



Buyers

PRODUCTS COMPANY

A LEADING MANUFACTURER DELIVERING QUALITY, VALUE & AVAILABILITY

Our History



1946
Buyers Products Company founded by Sam Ruven and Bessie Kleinman as a distributor of driveline components.



Buyers continued to grow its product offerings and build valued relationships with customers and suppliers. Increased demand for products led to the pursuit of supply chain manufacturing solutions.



1992 Buyers acquired Trailer Components Manufacturing (Tracom) for CNC precision machining and tooling, as well as state-of-the-art welding.



1995 Buyers acquired Progressive Powder Coating. Our Nordson automatic powder application booth is used to powder coat our Buyers toolboxes and other truck and trailer accessories.



2002 Buyers moved its corporate headquarters to a brand new 235,000 sq. ft. state-of-the-art office and distribution center.



2004 Buyers acquired Romotech in New Paris, Indiana. Our Ferry Industries Rotospeed molding machines are used to manufacture our poly salt spreaders.



2007 Buyers began manufacturing the SnowDogg stainless steel snowplow at our Mentor, Ohio facility.



2009 Buyers began our operations at Boomerang Rubber, in Botkins, Ohio manufacturing mudflaps, wheel chocks and other rubber truck and trailer accessories.



2013 Buyers acquired an additional 500,000 sq. ft. manufacturing facility in Mentor, Ohio allowing for expansion of our aluminum and stainless steel manufacturing.



2016 Buyers establishes a 22,000 sq ft Engineering Tech Center in Mentor, Ohio. It's multi-use lab, design, training and prototyping space is dedicated to the research and development of innovative product.

**ALL YOUR WORK
TRUCK PRODUCTS
ALL THE TIME.**

2017 Buyers launches new website with business partner portal, to make online ordering and account maintenance easy for customers.



2021 Buyers adds almost 300,000 sq ft of additional, state-of-the-art warehouse and office space to maintain the quick turnaround and competitive value their customers expect.



Fiercely Independent Since 1946



Buyers Products is a **fully integrated manufacturer** and a leader in the truck equipment industry, headquartered in Northeast Ohio.

Buyers Products' mission is to improve our Customers' profitability and productivity while enhancing the quality of our products and services.

Join thousands who have discovered the easiest way to do business with Buyers!

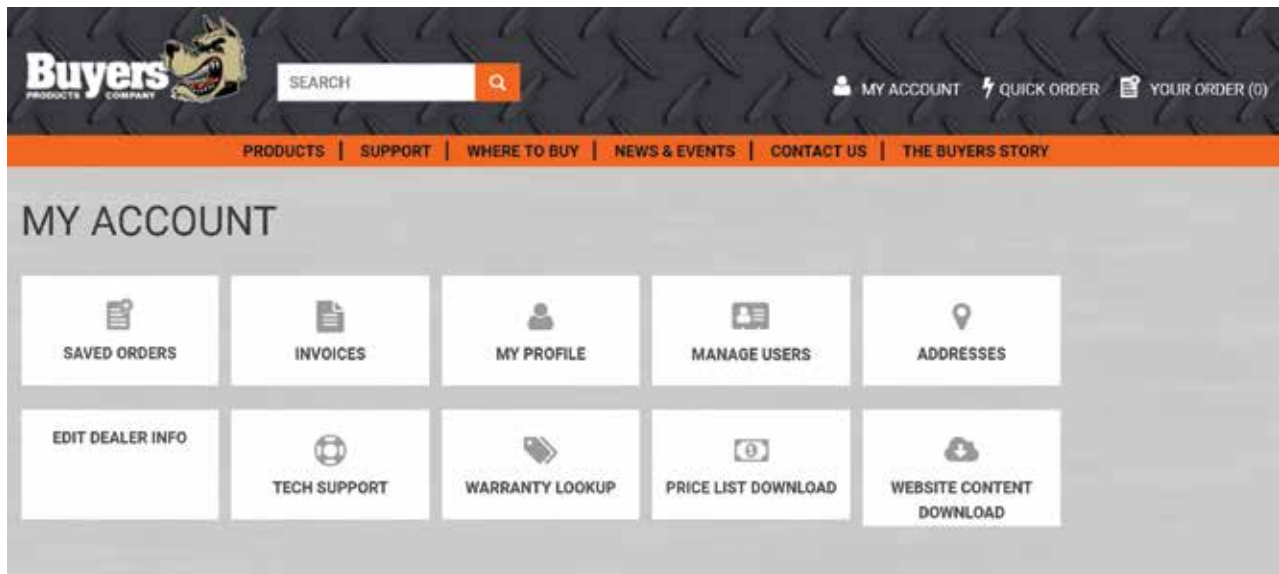

Online Business Partner Access

- Find product information for over 5,000 products.
- Get your personalized prices and product availability.
- Place your orders and check order status.
- Download manuals and access tech support.
- Download product cut sheets.

It's Easy to Join

1. From the home page, click *“Login or Register”* and select *“Create A User”*
2. Enter your account number and a recent invoice number, and proceed through the registration forms. (Both your account number and a recent invoice number are available on any recent Buyers Products invoice.)

Customer Support

Ordering:

Email: orders@BuyersProducts.com
24 Hour Toll-Free Fax: (800) 841-8003
Phone: (440) 974-8888

Customer Service:

For customer service assistance, call us at (440) 974-8888, email us at customercare@buyersproducts.com, or visit buyersproducts.com

Hours:

- Monday – Thursday from 8:00 AM to 6:00 PM EST, Friday from 8:00 AM to 5:30 PM EST

Payment Terms:

- Open account terms are net 30 days, with approved credit.
- There is a \$25.00 minimum order unless air service is requested.

Freight:

- Buyers' "Preferred LTL Program" incorporates preferred carrier rates, pre-paid and added to your invoice.
- Shipments are F.O.B. Mentor, Ohio.
- Drop-ship orders less than \$125.00 will incur a \$20.00 handling fee.

Returns:

Contact Customer Service for approval, authorization number and information for return. Returns may be subject to a restocking fee. Returns are not accepted without an RMA number.

Pricing:

Pricing is consistent with current market conditions and is subject to change without notice.

Marketing Information:

Looking for images, ad templates or have something to share with us online? Drop us an email at marketing@buyersproducts.com.

Additional Product Information:

Manuals, instructions, videos and other product details can be found at www.buyersproducts.com.



TABLE OF CONTENTS	PAGE
PRODUCT LOCATOR	4-5
NEW PRODUCTS	6-8
TRUCK BOXES	9-68
TOWING & CARGO CONTROL	69-146
LIGHTING AND ELECTRICAL	147-260
TRUCK EQUIPMENT & ACCESSORIES	261-274
FENDERS, MUDFLAPS & WHEEL CHOCKS	275-288
LANDSCAPE TRAILER ACCESSORIES & AGRICULTURAL PRODUCTS	289-300
TRUCK AND TRAILER HARDWARE	301-346
TARP SYSTEMS	347-376
HYDRAULICS	377-434
PNEUMATICS	435-446
CABLES & CONTROLS	447-468
PTO DRIVELINE	469-480
RETAIL SHOWROOM DISPLAYS	481-486
INDUSTRY GLOSSARY, WARRANTY POLICY and INDEX	487-512

Product Locator

PRODUCT	PAGE NO.	PRODUCT	PAGE NO.	PRODUCT	PAGE NO.	PRODUCT	PAGE NO.
A							
Accessories, Cable & Controls.....	448	Cam Lock Hardware,		Dump Consoles.....	436 - 438	Hooks, Tarp.....	372
Accessories, Landscape Trailer ..	290	Truck Boxes.....	325	Dump Tarp Kits.....	348	Hooks, Towing.....	102
Adjustable Multi-Ball Hitches.....	84	Cambuckle Straps.....	137	DumperDogg Dump Inserts &		Hooks, Weld-on.....	49, 101, 143, 372
Air Compensated Hitches.....	74	Cameras, Backup.....	242	Accessories.....	262	Hose Clamp, Hydraulic.....	401 - 403
Air Controls.....	436	Cargo Control.....	121	E			
Air Cylinders.....	445	Central Hydraulic Systems ..	424 - 427	Electric Jack.....	118	Hose Reels.....	444
Air Filter/Lubricator/Regulator ..	444	Chain Carrier.....	58	Electric Motors.....	255	Hose, Hydraulic.....	399
Air Fittings & Tube.....	334, 446	Chain Eyes.....	338	Electric Tarp Kits.....	348	Hour Meter.....	257
Air Regulator.....	443-444	Chain Hardware.....	96, 337	Electrical.....	242	Hydraulic Couplers.....	404 - 406
Air Shifters.....	439	Chain Holder.....	58	Electrical Connectors.....	111, 357	Hydraulic Filters.....	392 - 395
Air Tailgate Cylinders.....	333, 445	Chain Mount.....	96	Electrical Harness Assemblies.....	337	Hydraulic Fittings.....	431 - 434
Air Valves.....	436	Chain, Trailer.....	95	Electrical Solenoids.....	255	Hydraulic Gauges.....	413
Anchor Eye Bolts.....	103	Chainsaw Holder.....	293	Electrical Switches/Relays.....	249	Hydraulic Motors.....	414
Anti-Sail Mudflap Brackets.....	382	Chests, Toolbox.....	53	Emergency Road Flares.....	247	Hydraulic Pumps.....	408 - 411
Anti-Skid Tape.....	311	Circuit Breakers.....	254	E-Track & Accessories.....	142	Hydraulic Reservoirs.....	378 - 385
Assemblies, Universal Joint.....	470	Clamps, Cylinder.....	270	Eye Bolts.....	95	Hydraulic Valves.....	415 - 417
ATV Spreader.....	300	Clamps, Hose.....	401 - 403	EZ Gate.....	296	I	
Axle Controls.....	442	Clamps, Rubber.....	271	F			
B							
Backpack Truck Boxes.....	38-47	Clevises.....	330	Fender Extension, Rubber.....	276	ICC Bumper.....	90
Back-Up Alarm.....	248	Coal Door / Inspection Door.....	335	Fender Mounting Kit.....	277	In-Frame Toolbox.....	58
Backup Cameras.....	242	Compression Latch.....	63	Fenders.....	276	Inspection Door/Coal Door.....	335
Backup Lights, DOT.....	221	Compression Latch.....	63, 315	Fifth Wheel Lube Disks.....	101	Interior Lights.....	169
Ball Hitches / Pintle Hooks.....	71	Conduit Carrier Kit.....	268	Filters, Hydraulic.....	392 - 395	J	
Ball Joints.....	462	Cone Holders, Traffic.....	271, 272	Fittings, Air.....	446	Jacks, Trailer.....	118
Ball Mounts.....	79	Connection Kits/PTO/Pump.....	458 - 459	Fittings, Hydraulic.....	431 - 434	J-Hooks.....	49, 101, 143, 372
Ball Valves, Hydraulic.....	421	Connectors, Trailer.....	111	Flange, Bearings.....	480	Jumper Cables.....	246
Balls, Towing.....	86	Consoles & Shifters.....	448 - 451	Flange, Hydraulic.....	389	Junction Box.....	259
Banjo Eyes.....	338	Conspicuity Tape.....	233	Flare, Road, LED.....	247	K	
Battery Bolt Adapter.....	257	Continuous Hinge.....	341	Flasher, Strobe Light.....	188	Kabgard.....	269, 270
Battery Disconnects.....	252, 257	Contractor Truck Boxes.....	34-37	Flood Lights.....	148	Key Cylinders.....	65, 317
Battery operated beacon.....	210	Controls, Dump.....	436 - 438	Flow Control Valve.....	418	Key Stock.....	476
Beacon Strobes.....	280	Controls, Plow.....	436 - 437	Flow Divider Valve.....	418	King Pin.....	100
Bearings, Pillow Block.....	478	Controls, Spreader.....	422 - 423	Frame Step.....	57	King Pin Lock.....	101
Blind Spot Detection,		Corner Iron.....	325	Fuel Fill Dish.....	313	Knobs.....	461
Camera System.....	243	Couplers.....	106	Fuse Holders.....	258	L	
Board Holder, E-track.....	143	Couplers, Hydraulic.....	404 - 406	G			
Body-Up Indicator.....	339	Crank Arm Tarp Systems.....	362	Gas Can Rack, Holder.....	293	Ladder Rack Tie Downs.....	266
Booster Cables.....	246	Crossover Truck Boxes.....	50	Gas Springs.....	324	Ladder Racks.....	264
Bottle Holders.....	270	Cylinder Clamps.....	270	Gate Valves, Hydraulic.....	421	Ladder, Retractable Step.....	308
B-Pack Toolboxes.....	38-47	D				Landscape and Trailer	
Brackets, Beacon Light.....	213	Diamond Deck-Span Tread.....	311	Gauges, Hydraulic.....	413	Accessories.....	290
Brackets, Underbody Toolbox ..	28-29	Directional Strobes.....	187	Gear Motors, Tarp.....	364	Lashing Winch.....	134
Brake Controllers.....	110	Document Holder.....	297	Gooseneck Hitches.....	100	Latches.....	62-66, 314
Branch Guard.....	213	Dome Lights.....	169	GPS, Ground Speed Control.....	423	LED Lights.....	148
Breakaway Switch.....	110	Door Cam Lock.....	66, 325	Grab Handles.....	312	LED Road Flares.....	247
Breather Caps.....	386 - 387	Door Holders.....	326	Grab Hooks.....	101	LED Vans.....	448
Bulkhead Tanks.....	380	Door Locks.....	65, 317	Grease Fittings.....	477	Levers, Plow.....	448
Bumper Guides.....	272	Door Springs/Gas Springs.....	325	Gull-Wing Truck Boxes.....	51	Lift Axle Controller.....	442
Bumper, ICC.....	90	Doors, Aluminum, Cast.....	268	H			
Bumpers, Rubber.....	273	Doors, Inspection/Coal.....	335	Handles.....	312	Light Bars.....	174
Buzzer Light.....	340	DOT Air Fittings.....	446	Harness Assemblies.....	237	Light Boxes.....	236
C							
Cab Guard.....	269	DOT LED.....	214	Hasp, Lock.....	66, 324	Light Brackets.....	173, 213
Cable Levers.....	448, 450	DOT tubing.....	446	Headache Rack.....	269	Lightbar Mounts.....	176
Cable Steps.....	309	Drain Valve, Air.....	442	Hinges, Piano, Butt.....	341	Lighting.....	147
Cable Ties.....	146, 346, 468	Drawbar Eyes.....	103	Hitch Accessories.....	87	Lights.....	147
Cables & Control Systems.....	448	Drawbars.....	103	Hitch Adapters/Extensions.....	98	Lights, Beacons.....	208
Cables, Control.....	449	Drill-Free Lightbar Mounts.....	184	Hitch Balls.....	86	Lights, DOT.....	214
Cables, Push-Pull.....	452	D-Rings.....	122	Hitch Pins.....	87	Lights, Warning.....	174
Cam Lock Hardware, Truck Boxes..	22	D-Tracks.....	122	Hitch Plates.....	88	Lights, Work.....	148
		Driveline Components.....	458	Hitch Receivers.....	91	Limit Switches.....	339
		Driveshaft Assemblies.....	458	Hitches, Multi-fit.....	93	Linch Pins.....	328
		Dry Mat.....	61	Hitches, Service Body.....	92	Liner Slat.....	305
		Dump Body Hardware.....	336	Holder, Shovel.....	144, 336	Load Binders.....	135
		Dump Body Vibrators.....	334	Hood Catches, Rubber.....	322	Lock Cylinders.....	65, 317



PRODUCT	PAGE NO.	PRODUCT	PAGE NO.	PRODUCT	PAGE NO.	PRODUCT	PAGE NO.
Lo-Sider Truck Boxes	52	Receiver Tubes	97	Step, Folding	299	Truck Box, Gas Shock	66
Lube Disks	101	Receivers	91	Steps, Cable	301	Truck Box, Hasp	66
Lunette Eye	103	Recovery Hooks, Towing.....	101	Steps, Retractable.....	300	Truck Box, In-Frame.....	58
M							
Manual Tarp Kits	362	Reels, Hose	444	Stone Guards.....	283	Truck Box, Keys.....	65
Marker/Clearance Lights, DOT.....	214	Reflective Tape.....	233	Stop/Turn/Tail Lights, DOT	212	Truck Box, Latches.....	62-65
Master Disconnect Switch.....	252, 257	Regulators.....	443	Storage Tanks	298	Truck Box, Lock Cylinder.....	65
Motors, 12 VDC	255	Relay, Motor, Tarp.....	358	Strainers, Hydraulic.....	391	Truck Box, Mounting Kits.....	60
Motors, Hydraulic	414	Relief Valves	419	Straps, Winch, Ratchet.....	132	Truck Box, Open-Top Baskets.....	59
Mud Flap Brackets, Mounts.....	282	Remote Control Spot Lights.....	148	Strip Lights, LED	168	Truck Box, Shelf Kit	61
Mud Flaps	278	Remote Valve		Strobe Lights.....	180	Truck Box, Shelf Liner	61
Multi-Ball Hitches.....	82	Control Systems	448 - 449	Super Track.....	142	Truck Box, Tool Tray	66
N							
Non-Slip Tape.....	311	Reservoirs, Hydraulic.....	378 - 385	Switch Boxes.....	250-251	Truck Boxes.....	9-68
Nose Plate, Trailer	103	Retractable Steps.....	308	Switch Panels.....	249	Truck Boxes, Backpack	38-47
Nylon Ties	146, 346, 468	Retractable Tie-Down	137	Switches, Air	440-441	Truck Boxes, Crossover	50
O							
Object Detection Systems	242	Return Line Manifold	392	Switches, Limit.....	339	Truck Boxes, Lo-Siders	52
Outrigger Pads	284	Ring & Chain.....	338	Switches, Master Disconnect	257	Truck Boxes, Topsiders	30-37
Outriggers, Trailer.....	127	Road Flares, LED.....	247	Switches, Momentary.....	251	Truck Boxes, Trailer Tongue.....	55-56
P							
Paddle Latches.....	62	Roadside Assistance Equipment.....	246	Switches, Toggle	253	Truck Boxes, Underbody.....	10-29
Paddle Latches.....	62, 314	Rod End Bearings.....	262	Swivel Type Pintle Hooks.....	76	Truck Fenders	276
Piano Hinge	341	Rod Ends, Forged	324	T			
Pickup Hitches.....	91	Roll Tarps	366	Tail Light Converters, Trailer.....	117	Truck Racks.....	264
Pickup Racks.....	264	Rope lights, LED	169	Tailgate Cylinders, Air.....	333, 445	Truck/Trailer Lights	214
Pillow Blocks	478	Rope Rings	128	Tailgate Hinge, Bracket.....	336	Tubing, Air	446
Pin, Clevis.....	330	Rubber Bumpers	273	Tailgate Lift Assist, Trailer	296	Tunnel Box, Toolbox.....	49
Pins, Linch.....	328	Rubber Clamps.....	271	Tandem Fenders.....	269	Turn Signals, Lights.....	220
Pintle Hooks	72	Rubber Hood Catches.....	322	Tank Holders	262	U	
Pintle Mounts	78	RV/Travel Trailer Hitches.....	93	Tanks, Hydraulic	378 - 385	U-Bolt Kits.....	302
Plastic Mat	61	S				U-Joints	470
Pneumatic Tailgate Cylinders.....	333, 445	Safety & Emergency		Tanks, Poly	298	Underbody Toolboxes	10-29
Pneumatic Valves	332, 440-441	Lighting	179, 247	Tanks, Storage	298	Universal Joint Assemblies	470
Pneumatics	435 - 446	Safety Chain Retainers.....	96	Tanks, Water	298	Utility Light	148
Poly Fenders.....	276	Safety Chain, Trailer	96	Tarp Gear Motor	356	Utility Step.....	304
Power Units, Hydraulic	428 - 430	Sectional Valves	416 - 417	Tarp Kits.....	348	UTV spreader	300
Pressure Regulator.....	443	Set Screws.....	476	Tarp Straps.....	146, 371	V	
PRO Series Truck Boxes -		Shafting & Accessories.....	470	Tarp Winder	366	Valve Control Systems.....	448 - 449
Aluminum	20-21	Shifters, Push-Pull	450 - 451	Tarps.....	374	Valves, Air	332, 440-441
PRO Series Truck Boxes - Steel.....	10	Shovel Holder	144, 336	T-Bolt Clamp	401	Valves, Hydraulic	415 - 417
Programmable Switches.....	250	Sight Gauge.....	388	Temperature Gauges	388	Van Racks, Ladder Carriers.....	265
PTO Cables.....	456	Sight Rods.....	272	T-Handle Latches	64 - 65, 316-317	Vent Plugs	442
PTO Connection Kits.....	458 - 459	Smart Switches.....	250	Throttle Cables.....	455	Vernier Cables	455
PTO's	407	Snap Pins	328	Tie Bars.....	303	Vibrators, Dump Body.....	334
Pull-Style Tarp kits.....	364	Solenoid, Air	443	Tie Downs	137	Video Safety Systems	242
Pump Cables	452 - 453	Solenoids	255	Tie Rings	128	Vise Mount, Bumper	270
Pump Connection Kits	458 - 459	Spare Tire Carrier.....	296, 297, 304	Tire Carrier, Spare ..	144, 152, 296, 297	W	
Pumps, Hydraulic	408 - 411	Spare Tire Carrier, E-Track	144	Tool Holders	271, 336	Warning Lights	174
Push-Button, Recessed.....	252	Spitter Valve	442	Toolboxes	9-68	Water Cooler Holder	270, 295
Push-Pull Cables	452-454	Splash Guards	283	Topsider Truck Boxes.....	30-37	Water Tanks, Storage	298
Q							
Quarter Fenders	277	Splined Stub Insert.....	373, 472	Tow Hooks, Recovery	101	Weld Flange.....	389
Quick Couplers	404 - 406	Spot Lights.....	148	Towing.....	69	Wetline Kits	397 - 398
R							
Racks, Blower/Trimmer	270	Spreader Valves.....	422 - 423	Towing Lights	248	Wheel Chocks.....	285
Racks, Ladder	264	Spreaders, All-Season/ATV	300	Tractor Protection Valve.....	443	Winch Straps.....	133
Ramp Spring, Trailer.....	296	Spring Latches	318	Traffic Arrow Lights.....	186	Winches & Tie Downs.....	132
Ratchet Strap Mounts.....	141	Spring Ramp, Torsion	296	Traffic Cone Holder.....	271	Wind Deflector, Ladder Rack	264
Ratchet Straps.....	137	Spring Retracting Tie Downs	138	Trailer Breakaway Switch.....	110	Window Protector, Kabgard	269
Ratcheting Load Binders.....	135	Springs, Tarp.....	361	Trailer Connectors	111	Wire Harness, Universal	229
Receiver Adapters	98	Springs, Tarp.....	361	Trailer Tongue Toolboxes	55-56	Work Lights	148
S							
Racks, Blower/Trimmer	270	Stake Body Hardware.....	304	Tri-Ball Hitches.....	83	Y	
Racks, Ladder	264	Stake Connectors.....	304	Trimmer Racks	290	Yokes, Adjustable End	470
Ramp Spring, Trailer.....	296	Stake Pocket D-ring	123, 298	Truck & Trailer Hardware.....	302	Z	
Ratchet Strap Mounts.....	141	Stake Pocket Winch.....	134	Truck Box Mounting Brackets,		Zip-Ties	146, 346, 468
Ratchet Straps.....	137	Stake Pockets	298	Underbody	28-29		
Ratcheting Load Binders.....	135	Step Box.....	56-57	Truck Box, Back Pack			
Receiver Adapters	98	Step Grip	303	Mounting Kits	46 - 47		
		Step, Floor, Poly	302	Truck Box, Chain Holder	58		

New Products

Pro Series Smooth Aluminum Barn Door



PAGE 21

Universal Open Top Cargo & Tool Baskets



PAGE 59

Receiver Hitches



PAGE 91

Rock Gards



PAGE 99, 283

Barn Door Underbody With Cam Lock Rod



PAGE 22

Shelf Kits For Underbody Truck Tool Boxes



PAGE 61

Bolt-On Receiver Tube



PAGE 97

Trailer Outriggers



PAGE 127

Diamond Tread Aluminum Box With Slanted Back



PAGE 23

Adjustable Multi-Ball Hitches



PAGE 84

Adjustable Couplers



PAGE 107

Recessed Rope Rings



PAGE 128

HD Flatbed Contractor With Lower Door



PAGE 36

Hitch Plates



PAGE 88

OEM Trailer Connectors



PAGE 115

Sliding Winch Track



PAGE 133

HD Flatbed Contractor With Lower Drawers



PAGE 37

Receiver Tubes



PAGE 97

Side Wind Jack



PAGE 120

Anchor Shackles



PAGE 136



Commercial Grade Ratchet Tie Downs



PAGE 139

Mini Lights



PAGE 149

Surface Mount Strobes



PAGE 190

Extended Ladder Racks for Crew Cab Pickups



PAGE 264

Stainless Steel ladder Rack Tie Downs



PAGE 140, 266

Combination Flood/ Strobe Lights



PAGE 163

Class 1 Recessed Strobes



PAGE 203

Extended Ladder Racks for Crew Cab Service Bodies



PAGE 264

Spring Retracting Ladder Rack Tie Downs



PAGE 141, 267

Plow Lights



PAGE 170-171

Combination Stop/Turn/ Tail/Back-Up/Strobes



PAGE 201

Universal KabGards for Service Bodies



PAGE 270

E-track Tool Holders



PAGE 144

Mini Lightbars



PAGE 179-183

Backup Camera Kit



PAGE 243

Poly Fenders



PAGE 277

Remote Control Lights



PAGE 148

Lightbar Mounts



PAGE 184

Junction Boxes/Fuse Blocks



PAGE 259

Mudflap Clamps



PAGE 282

New Products

Rubber Bumpers



PAGE 273

Inspection/Coal Doors



PAGE 331

Retract-A-Pull™



PAGE 365

8" and 10" Cleanout cover unit



PAGE 388

Wheel Chocks



PAGE 285

Rear Dump Hinge



PAGE 335

PullCover™



PAGE 369

SAE H213 Series Pumps



PAGE 411

Retractable Truck Steps



PAGE 308

Spare Tire Carriers



PAGE 297

Hot shift PTO for Ford 10R Trans F550 & Down



PAGE 407

Air Control Levers



PAGE 437

Spring Latches



PAGE 319

ElectroCover™



PAGE 350-351

Pump for B3910 Series PTOs, 12 Ports



PAGE 410

Air Control Joysticks



PAGE 436

Hitch Pins



PAGE 329

CrankCover™



PAGE 362-363

Pump for B3910 Series PTOs, 16 Ports



PAGE 410

Filter/Regulator/Lubricator



PAGE 444



Truck Tool Boxes



Product Shown:

1762603: Smooth Aluminum Double Barn Door with Cam Lock Hardware

1701005: Mounting Brackets

1903005: Inch Weld-On Trailer Winch

1903070: 4" Strap

Underbodies	10 - 29
Topsiders	30 - 37
Backpacks	38-48
Tunnel Boxes	49
Crossovers	50 - 51
Lo-Sider	52

Storage Chests	53-54
Trailer Tongue	55 - 56
Step Boxes	57
In-Frame Boxes	58
Cargo Baskets	59
Parts & Accessories	60-68

PRO Series Steel Underbody

- 12 gauge steel box and cross-broke door
- Removable door design
- Automotive bulb seal
- Stainless steel bolt-on continuous hinge with oversized 1/4" pin
- Built-in rain gutter
- Detachable 3/16" door chains
- Locking die cast T-handle compression latch



GLOSS BLACK, SINGLE LATCH



1752805

Part No.	Height	Depth	Width	# Latches per Door	Wt. (lb)
1752799	18	18	18	1	56
1752800	18	18	24	1	80
1752803	18	18	30	1	91
1752805	18	18	36	1	104
1752810	18	18	48	1	127
1754800	24	24	24	1	90
1754803	24	24	30	1	115
1754805	24	24	36	1	132
1754807	24	24	48	1	145

GLOSS BLACK, DOUBLE DOOR

WORKS GREAT AS TOPSIDER ON FLATBEDS AND SERVICE BODIES.



1752825

Part No.	Height	Depth	Width	# Latches per Door	Wt. (lb)
1752815†	18	18	60	1	175
1752825†	18	18	72	1	202
1752835†	18	18	90	1	228
1752836†	18	18	96	1	250
1754809†	24	24	60	1	160
1754811†	24	24	72	1	175
1754814†	24	24	90	1	190
1754817†	24	24	96	1	210

†Boxes can be used as topsiders and underbodies



T-HANDLE LATCH

- 14 gauge powder-coated steel box
- Drop-down recessed door
- Locking stainless steel T-handle latches
- Bolt-on, stainless steel continuous hidden hinge
- Replaceable gasket sealing system
- Aircraft grade door cables
- Reinforced door backbone on boxes 48" and wider
- Door opening: flat surface mount (90°) or underbody mount (180°)



GLOSS BLACK, SINGLE LATCH



1702305

GLOSS BLACK, DUAL LATCH



1702310

GLOSS BLACK, DOUBLE DOOR



1702325

Part No.	Height	Depth	Width	# Latches per Door	Wt. (lb)
1703349	14	12	18	1	37
1703350	14	12	24	1	40
1703353	14	12	30	1	49
1703300	14	16	24	1	56
1703303	14	16	30	1	65
1703305	14	16	36	1	74
1703310	15	10	15	1	28
1703312	15	10	24	1	39
1703320	15	13	15	1	32
1703321	15	13	18	1	38
1703322	15	13	24	1	45
1703324	15	13	30	1	53
1703326	15	13	36	1	61
1703330	16	14	18	1	50
1702295	18	18	18	1	47
1702300	18	18	24	1	67
1702303	18	18	30	1	80
1702305	18	18	36	1	92
1704300	24	24	24	1	87
1704303	24	24	30	1	100
1704305	24	24	36	1	116

Part No.	Height	Depth	Width	# Latches per Door	Wt. (lb)
1703328	15	13	48	2	83
1702310	18	18	48	2	118
1702315	18	18	60	2	143
1702317	18	18	66	2	186
1708310	18	24	48	2	133
1704310	24	24	48	2	145
1704315	24	24	60	2	175

Part No.	Height	Depth	Width	# Latches per Door	Wt. (lb)
1702325†	18	18	72	1	156
1704320†	24	24	72	1	165

†Boxes can be used as topsiders and underbodies

Steel Underbody

GLOSS WHITE, SINGLE LATCH



1703400

Part No.	Height	Depth	Width	# Latches per Door	Wt. (lb)
1703400	14	16	24	1	56
1703403	14	16	30	1	65
1703405	14	16	36	1	71
1703495	18	18	18	1	47
1702400	18	18	24	1	67
1702403	18	18	30	1	80
1702405	18	18	36	1	92
1704400	24	24	24	1	87
1704403	24	24	30	1	100
1704405	24	24	36	1	116

GLOSS WHITE, DUAL LATCH



1702410

Part No.	Height	Depth	Width	# Latches per Door	Wt. (lb)
1702410	18	18	48	2	118
1702415	18	18	60	2	143
1702417	18	18	66	2	186
1708410	18	24	48	2	133
1704410	24	24	48	2	145
1704415	24	24	60	2	168

GLOSS WHITE, DOUBLE DOOR



1704420

Part No.	Height	Depth	Width	# Latches per Door	Wt. (lb)
1702425	18	18	72	1	133
1704420	24	24	72	1	165

PRIMED, SINGLE LATCH



1703900

Part No.	Height	Depth	Width	# Latches per Door	Wt. (lb)
1703900	14	16	24	1	56
1702905	18	18	36	1	92

PRIMED, DUAL LATCH



1702910

Part No.	Height	Depth	Width	# Latches per Door	Wt. (lb)
1702910	18	18	48	2	118



T-HANDLE OR 3-POINT COMPRESSION LATCH WITH WELDED SHELF

- 14 gauge steel box
- 14 gauge steel shelf welded at mid height, 12-3/4" deep with 1" front lip
- Locking T-handle or 3-point compression latches
- Replaceable gasket sealing system

T-HANDLE LATCH & AIRCRAFT GRADE DOOR CABLES



Part No.	Height	Depth	Width	# Latches per Door	Wt. (lb)
1703304	14	16	30	1	72

COMPRESSION LATCH



Part No.	Height	Depth	Width	# Latches per Door	Wt. (lb)
1702306†	18	18	36	1	82
1702311†	18	18	48	1	106

† Without lanyards

T-HANDLE LATCH WITH SLANTED BACK

- Angled top allows room for fuel fill hoses on single rear wheel flat beds
- Locking stainless steel T-handle latches
- Door opening: flat surface mount (90°) or underbody mount (180°)
- Drop-down recessed door
- Replaceable gasket sealing system

GLOSS BLACK



Part No.	Height	Depth	Width	# Latches per Door	Wt. (lb)
1703351	14	12	18	1	40
1703352	14	12	24	1	47
1703355	14	12	30	1	49

See pg. 28-29 for Underbody Mounting Brackets

Steel Underbody

PADDLE LATCH

- 14 gauge powder-coated steel box
- Drop-down recessed door
- Locking stainless steel paddle latch
- Bolt-on continuous hidden hinge
- Replaceable gasket sealing system
- Aircraft grade door cables
- Reinforced door backbone on boxes 48" and wider
- Door opening: flat surface mount (90°) or underbody mount (180°)



GLOSS BLACK, SINGLE LATCH



1702105

Part No.	Height	Depth	Width	# Latches per Door	Wt. (lb)
1703150	14	12	24	1	48
1703100	14	16	24	1	56
1703103	14	16	30	1	65
1702100	18	18	24	1	67
1702103	18	18	30	1	80
1702105	18	18	36	1	92

GLOSS BLACK, DUAL LATCH



1702110

Part No.	Height	Depth	Width	# Latches per Door	Wt. (lb)
1702110	18	18	48	2	118
1702115	18	18	60	2	143

GLOSS WHITE, SINGLE LATCH



1702203

Part No.	Height	Depth	Width	# Latches per Door	Wt. (lb)
1703203	14	16	30	1	65
1703205	14	16	36	1	74
1702200	18	18	24	1	67
1702203	18	18	30	1	80
1702205	18	18	36	1	92

GLOSS WHITE, DUAL LATCH



1702215

Part No.	Height	Depth	Width	# Latches per Door	Wt. (lb)
1702210	18	18	48	2	118
1702215	18	18	60	2	143



3-POINT COMPRESSION LATCH

- 14 gauge powder-coated steel box
- Drop-down recessed door
- Die-cast T-handle compression latch with 3-point locking system
- Bolt-on continuous hidden hinge
- Replaceable gasket sealing system
- Aircraft grade door cables
- Reinforced door backbone on boxes 48" and wider
- Door opening: flat surface mount (90°) or underbody mount (180°)



GLOSS BLACK



Part No.	# Doors	Height	Depth	Width	# Latches per Door	Wt. (lb)
1732300	1	18	18	24	1	59
1732303	1	18	18	30	1	70
1732305	1	18	18	36	1	83
1732310	1	18	18	48	1	118
1732315	1	18	18	60	1	143
1732320	2	18	18	72	1	142
1734300	1	24	24	24	1	84
1734303	1	24	24	30	1	95
1734305	1	24	24	36	1	110
1704320	2	24	24	72	1	165

GLOSS WHITE



Part No.	# Doors	Height	Depth	Width	# Latches per Door	Wt. (lb)
1732400	1	18	18	24	1	59
1732403	1	18	18	30	1	70
1732405	1	18	18	36	1	83
1732410	1	18	18	48	1	118
1732415	1	18	18	60	1	143
1702425	2	18	18	72	1	133
1734400	1	24	24	24	1	84
1734403	1	24	24	30	1	95
1734405	1	24	24	36	1	110
1704420	2	24	24	72	1	165

TEXTURED MATTE BLACK



Part No.	Height	Depth	Width	# Latches per Door	Wt. (lb)
1732500	18	18	24	1	59
1732503	18	18	30	1	70
1732505	18	18	36	1	83
1732510	18	18	48	1	118
1734500	24	24	24	1	84
1734503	24	24	30	1	95
1734505	24	24	36	1	110

Steel Underbody

POLISHED STAINLESS STEEL DOOR WITH COMPRESSION LATCH

- 14 gauge stainless box with polished 16 gauge stainless steel door
- Drop-down recessed door
- Locking die-cast T-handle compression latch
- Continuous hidden hinge
- Replaceable gasket sealing system
- Aircraft grade door cables
- Reinforced door backbone on boxes 48" and wider
- Door opening: flat surface mount (90°) or underbody mount (180°)



GLOSS BLACK BOX, SINGLE LATCH



1702705

Part No.	Height	Depth	Width	# Latches per Door	Wt. (lb)
1703700	14	16	24	1	55
1703703	14	16	30	1	64
1703705	14	16	36	1	71
1702965	18	18	18	1	42
1702700	18	18	24	1	72
1702703	18	18	30	1	81
1702705	18	18	36	1	101
1704700	24	24	24	1	70
1704703	24	24	30	1	81
1704705	24	24	36	1	132

GLOSS BLACK BOX, DUAL LATCH



1702710

Part No.	Height	Depth	Width	# Latches per Door	Wt. (lb)
1702710	18	18	48	2	110
1702715	18	18	60	2	132
1708710	18	24	48	2	108
1704710	24	24	48	2	169
1704715	24	24	60	2	227

GLOSS BLACK BOX, DOUBLE DOOR



1702725

Part No.	Height	Depth	Width	# Latches per Door	Wt. (lb)
1702725	18	18	72	1	156



POLISHED STAINLESS STEEL DOOR WITH COMPRESSION LATCH

- 14 gauge stainless steel body with polished 16 gauge stainless steel door
- Drop-down recessed door
- Locking die-cast T-handle compression latch
- Continuous hidden hinge
- Replaceable gasket sealing system
- Aircraft grade door cables
- Reinforced door backbone on boxes 48" and wider
- Door opening: flat surface mount (90°) or underbody mount (180°)



STAINLESS BOX, SINGLE LATCH



1702605

Part No.	Height	Depth	Width	# Latches per Door	Wt. (lb)
1702595	18	18	18	1	51.5
1702600	18	18	24	1	61.5
1702603	18	18	30	1	81
1702605	18	18	36	1	85

STAINLESS BOX, DUAL LATCH



1702610

Part No.	Height	Depth	Width	# Latches per Door	Wt. (lb)
1702610	18	18	48	2	110



1702605 shown

See pg. 28-29 for Underbody Mounting Brackets

Stainless Steel Underbody

MIRROR FINISH STAINLESS STEEL DOOR WITH COMPRESSION LATCH

- 16 gauge high polish stainless steel box and door
- Drop-down external door
- Locking die-cast T-handle compression latch
- Continuous hidden hinge
- Replaceable door cables
- Built-in rain gutter with automotive bulb seal



SINGLE LATCH



1702655

Part No.	Height	Depth	Width	# Latches per Door	Wt. (lb)
1702650	18	18	24	1	48
1702653	18	18	30	1	57
1702655	18	18	36	1	65

DUAL LATCH



1702660

Part No.	Height	Depth	Width	# Latches per Door	Wt. (lb)
1702660	18	18	48	2	80

1702655 shown



DIAMOND TREAD ALUMINUM DOOR WITH COMPRESSION LATCH

- 14 gauge steel box with .100" thick diamond tread door
- Drop-down recessed door
- Locking die-cast T-handle compression latch
- Bolt-on continuous hidden hinge
- Replaceable gasket sealing system
- Aircraft grade door cables
- Door opening: flat surface mount (90°) or underbody mount (180°)
- Reinforced door backbone on boxes 48" and wider



GLOSS BLACK, SINGLE LATCH



1702505

Part No.	Height	Depth	Width	# Latches per Door	Wt. (lb)
1702500	18	18	24	1	61
1702503	18	18	30	1	72
1702505	18	18	36	1	82

GLOSS BLACK, DUAL LATCH



1702510

Part No.	Height	Depth	Width	# Latches per Door	Wt. (lb)
1702510	18	18	48	2	104

1702505 shown



See pg. 28-29 for Underbody Mounting Brackets

PRO Series Aluminum Underbody

DROP DOOR WITH 3-POINT COMPRESSION LATCH

- .125" thick smooth aluminum with rigid extruded box frame (.100" thick diamond tread aluminum door on certain models)
- Die-cast T-handle compression latch with 3-point locking system
- Stainless steel bolt-on continuous hinge with oversized 1/4" pin
- Built-in rain gutter with automotive bulb seal

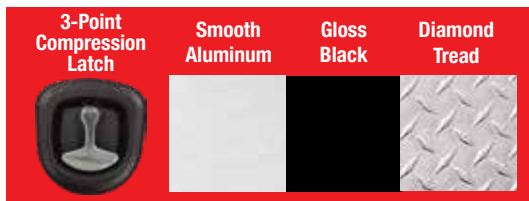

SMOOTH ALUMINUM



1706405

GLOSS BLACK



1706965

DIAMOND TREAD DOOR



1706505

Part No.	Height	Depth	Width	# Latches per Door	Wt. (lb)
1706400	18	18	24	1	44
1706403	18	18	30	1	50
1706405	18	18	36	1	57
1706410	18	18	48	1	64
1706415	18	18	60	1	78
1706420	18	24	36	1	57
1706425	18	24	48	1	79
1706430	18	24	60	1	83

Part No.	Height	Depth	Width	# Latches per Door	Wt. (lb)
1706960	18	18	24	1	44
1706963	18	18	30	1	50
1706965	18	18	36	1	57
1706970	18	18	48	1	64
1706975	18	18	60	1	78
1706980	18	24	36	1	57
1706985	18	24	48	1	79
1706990	18	24	60	1	83

Part No.	Height	Depth	Width	# Latches per Door	Wt. (lb)
1706500	18	18	24	1	41
1706503	18	18	30	1	48
1706505	18	18	36	1	56
1706510	18	18	48	1	69
1706515	18	18	60	1	79



1705510 Open



SMOOTH ALUMINUM BARN DOOR WITH COMPRESSION LATCH

- .125" thick smooth aluminum with rigid extruded box frame
- Locking die-cast T-handle compression latch
- 3 point locking system on double barn doors, standard lock system on single swing door
- Stainless steel bolt-on continuous hinge with oversized 1/4" pin
- Built-in rain gutter with automotive bulb seal
- Unobstructed box opening with no center post

SMOOTH ALUMINUM

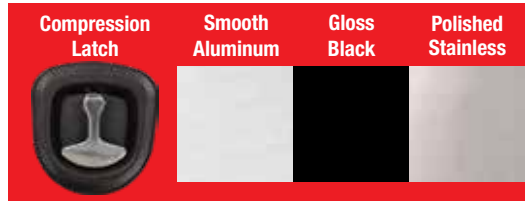

Part No.	Height	Depth	Width	# Doors	Wt. (lb)
1705395	18	18	18	1	56.5
1705401	18	18	24	1	56.5
1705403	18	18	30	2	45
1705405	18	18	36	2	51
1705410	18	18	48	2	62
1705415	18	18	60	2	73
1705420	18	24	36	2	58
1705425	18	24	48	2	71
1705430	18	24	60	2	85
1705431	24	24	24	1	67
1705433	24	24	30	2	62
1705435	24	24	36	2	67
1705440	24	24	48	2	83
1705445	24	24	60	2	99
1705450	24	24	72	2	105

GLOSS BLACK



Part No.	Height	Depth	Width	# Doors	Wt. (lb)
1705895	18	18	18	1	56.5
1705900	18	18	24	1	56.5
1705903	18	18	18	2	45
1705903	18	18	30	2	45
1705905	18	18	36	2	51
1705910	18	18	48	2	62
1705915	18	18	60	2	73
1705920	18	24	36	2	58
1705925	18	24	48	2	71
1705930	18	24	60	2	85
1705931	24	24	24	1	67
1705933	24	24	30	2	62
1705935	24	24	36	2	67
1705940	24	24	48	2	83
1705945	24	24	60	2	99
1705950	24	24	72	2	105

SMOOTH ALUMINUM WITH STAINLESS STEEL DOORS



Part No.	Height	Depth	Width	# Doors	Wt. (lb)
1705510*	18	18	36	2	56
1705515*	18	18	48	2	69
1705520*	18	18	60	2	91
1705580*	24	24	48	2	93
1705585*	24	24	60	2	119

See pg. 28-29 for Underbody Mounting Brackets

Cam Lock Underbody

BARN DOOR WITH CAM LATCH **NEW**

- 0.125" thick smooth aluminum (polished stainless steel doors on certain models)
- Unobstructed box opening with no center post
- Cam-Lock hardware is made of high-quality aluminum and allows for the use of a personal padlock (purchased separately)
- Designed for universal installation (drivers side or passenger side)
- Stainless steel bolt-on continuous hinge with oversized 1/4" pin
- Built-in rain gutter with automotive bulb seal
- Ideal for Flat Bed Trailer or Step Deck Applications

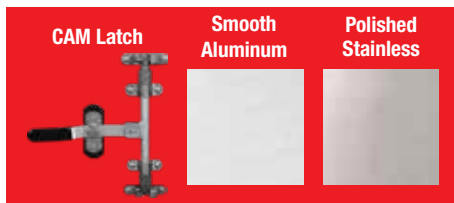

SMOOTH ALUMINUM DOORS



Part No.	Height	Depth	Width	# Doors	Wt. (lb)
1762600	18	18	36	2	55
1762603	18	18	48	2	65
1762606	18	18	60	2	76
1762609	18	18	72	2	87
1762621	18	24	36	2	63
1762624	18	24	48	2	75
1762627	18	24	60	2	88
1762630	18	24	72	2	101
1762639	24	24	36	2	73
1762642	24	24	48	2	87
1762645	24	24	60	2	102
1762648	24	24	72	2	116

POLISHED STAINLESS STEEL DOORS



Part No.	Height	Depth	Width	# Doors	Wt. (lb)
1763103	18	18	48	2	65
1763106	18	18	60	2	84
1763124	18	24	48	2	75
1763127	18	24	60	2	96
1763142	24	24	48	2	87
1763145	24	24	60	2	110



COMPRESSION LATCH

- .100" thick diamond tread aluminum
- Drop-down recessed door
- Locking die-cast T-handle compression latch
- Aluminum bolt-on continuous hidden hinge
- Replaceable gasket sealing system
- Aircraft grade door cables
- Reinforced door backbone on boxes 48" and wider
- Door opening: flat surface mount (90°) or underbody mount (180°)



DIAMOND TREAD, SINGLE LATCH



1705105

Part No.	Height	Depth	Width	# Latches per Door	Wt. (lb)
1705148	14	12	16	1	18
1705149	14	12	18	1	19
1705150	14	12	24	1	23
1705153	14	12	30	1	26
1705160	14	16	24	1	25
1705102	18	18	14	1	25
1705101	18	18	18	1	30
1705100	18	18	24	1	33
1705103	18	18	30	1	39
1705105	18	18	36	1	43
1705118	20	20	36	1	46
1705119	18	24	36	1	56
1705130	24	24	24	1	45
1705133	24	24	30	1	52
1705135	24	24	36	1	60

DIAMOND TREAD, DUAL LATCH



1705125

Part No.	Height	Depth	Width	# Latches per Door	Wt. (lb)
1705110	18	18	48	2	57
1705115	18	18	60	2	66
1705113	18	18	72	2	76
1705120	18	24	48	2	64
1705125	18	24	60	2	82
1705127	18	24	72	2	82
1705140	24	24	48	2	75
1705145	24	24	60	2	89
1705147	24	24	72	2	97

COMPRESSION LATCH WITH SLANTED BACK **NEW**

- Angled top allows room for fuel fill hoses on single rear wheel flat beds
- Locking die-cast T-handle compression latch
- Door opening: flat surface mount (90°) or underbody mount (180°)
- Drop-down recessed door
- Replaceable gasket sealing system



1705163

Part No.	Height	Depth	Width	# Latches per Door	Wt. (lb)
1705163*	14	12	18	1	18
1705166*	14	12	24	1	21
1705169*	14	12	30	1	23

Aluminum Underbody

GLOSS BLACK DIAMOND TREAD, SINGLE LATCH



1725105

Part No.	Height	Depth	Width	# Latches per Door	Wt. (lb)
1725148	14	12	16	1	18
1725149	14	12	18	1	23
1725150	14	12	24	1	25
1725153	14	12	30	1	27
1725160	14	16	24	1	26
1725101	18	18	18	1	27
1725100	18	18	24	1	30
1725103	18	18	30	1	38
1725105	18	18	36	1	42
1725116	18	24	30	1	40
1725119	18	24	36	1	56
1725125	18	24	60	1	64
1725118	20	20	36	1	64
1725130	24	24	24	1	46
1725133	24	24	30	1	53
1725135	24	24	36	1	59

GLOSS BLACK DIAMOND TREAD, DUAL LATCH



1725105

Part No.	Height	Depth	Width	# Latches per Door	Wt. (lb)
1725110	18	18	48	2	52
1725115	18	18	60	2	70
1725120	18	24	48	2	64
1725140	24	24	48	2	76
1725145	24	24	60	2	89
1725147	24	24	72	2	97

1725105 shown



3-POINT COMPRESSION LATCH

- .100" thick diamond tread aluminum
- Drop-down recessed door
- Die-cast T-handle compression latch with 3-point locking system
- Aluminum bolt-on continuous hidden hinge
- Replaceable gasket sealing system
- Aircraft grade door cables
- Reinforced door backbone
- Door opening: flat surface mount (90°) or underbody mount (180°)



DIAMOND TREAD



1735100



1735130 open

Part No.	Height	Depth	Width	# Latches per Door	Wt. (lb)
1735101	18	18	18	1	27
1735100	18	18	24	1	33
1735103	18	18	30	1	38
1735105	18	18	36	1	44
1735110	18	18	48	1	54
1735115	18	18	60	1	63
1735116	18	24	30	1	44
1735119	18	24	36	1	51
1735120	18	24	48	1	63
1735125	18	24	60	1	76
1735130	24	24	24	1	45
1735133	24	24	30	1	58
1735135	24	24	36	1	63
1735140	24	24	48	1	72
1735145	24	24	60	1	87

ALUMINUM UNDERBODY WITH DRAWERS

- .100" thick diamond tread aluminum
- Drawer comes with adjustable dividers and 100 lb rated 16" slides
- Drop-down recessed door
- Locking die-cast T-handle compression latch
- Continuous hidden hinge
- Replaceable gasket sealing system
- Door opening: flat surface mount (90°) or underbody mount (180°)
- Reinforced door backbone
- Aircraft grade door cables



1712205

Part No.	Height	Depth	Width	# Latches per Door	Wt. (lb)
1712200	20	18	24	1	50
1712205	20	18	36	1	66
1712210	20	18	48	1	85

Aluminum Underbody

BARN DOOR WITH COMPRESSION LATCH

- 0.100" thick diamond tread or smooth aluminum
- Side-hinged doors with reversible right/left locking door
- Locking die-cast T-handle compression latch
- 3 point locking system on double barn doors, standard lock system on single swing door
- Aluminum bolt-on continuous hinge with oversize 1/4" pin
- Automotive D-bulb seal
- Can mount on flat surface
- Unobstructed box opening with no center post

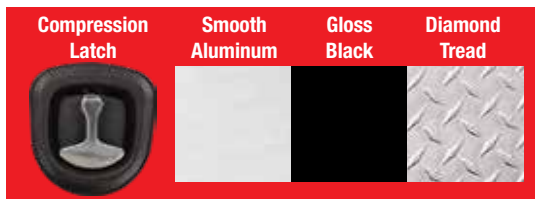

SMOOTH ALUMINUM



Part No.	Height	Depth	Width	# Doors	Wt. (lb)
1705295	18	18	18	1	26
1705300	18	18	24	1	32
1705303	18	18	30	2	42
1705305	18	18	36	2	49
1705310	18	18	48	2	63
1705315	18	18	60	2	77
1705325	24	24	24	1	43
1705333	24	24	30	2	69
1705335	24	24	36	2	75
1705340	24	24	48	2	87
1705345	24	24	60	2	99
1705350	24	24	72	2	98

GLOSS BLACK



Part No.	Height	Depth	Width	# Doors	Wt. (lb)
1705795	18	18	18	1	26
1705800	18	18	24	1	32
1705803	18	18	30	2	42
1705805	18	18	36	2	49
1705810	18	18	48	2	63
1705815	18	18	60	2	77
1705825	24	24	24	1	43
1705833	24	24	30	2	69
1705835	24	24	36	2	75
1705840	24	24	48	2	87
1705845	24	24	60	2	99
1705850	24	24	72	2	98

DIAMOND TREAD ALUMINUM



Part No.	Height	Depth	Width	# Doors	Wt. (lb)
1705201	18	18	18	1	27
1705200	18	18	24	1	36
1705203	18	18	30	1	42
1705205	18	18	36	2	49
1705210	18	18	48	2	63
1705215	18	18	60	2	77
1702225	24	24	24	1	45
1702230	24	24	30	1	52
1702235	24	24	36	2	71
1702240	24	24	48	2	76
1702250	24	24	60	2	87



3-POINT T-HANDLE LATCH

BLACK, SINGLE LATCH

- Constructed of high-density polyethylene
- Drop down door
- Locking stainless steel 3-point T-handle latch
- Stainless steel hinge pin
- Replaceable gasket sealing system
- Aircraft grade door cables
- Molded double-wall door design



1717110

Part No.	Height	Depth	Width	# Latches per Door	Wt. (lb)
1717100	18	18	24	1	24
1717105	18	18	36	1	31
1717110	18	18	48	1	42



1705805 shown

See pg. 28-29 for Underbody Mounting Brackets

Underbody Mounting Brackets

STEEL

Built for long wear with a corrosion-resistant black powder-coated finish in your choice of 3" inch wide Formed C-channel or Heavy-Duty Structural Steel.

- Choose welded or bolt-on braces
- Sold in boxed pairs
- Universal hole pattern for quick and easy mounting
- Made in the USA
- *Hardware not included*

FORMED, WELDED



1701006

Part No.	Description	Height	Depth	Wt. (lb)
1701006	Formed Welded Brackets	18	18	16
1701011	Formed Welded Brackets	18	24	19
1701016	Formed Welded Brackets	24	24	22

FORMED, BOLTED



1701006B

Part No.	Description	Height	Depth	Wt. (lb)
1701006B	Formed Bolted Brackets	18	18	16
1701011B	Formed Bolted Brackets	18	24	19

HEAVY DUTY, STRUCTURAL WELDED

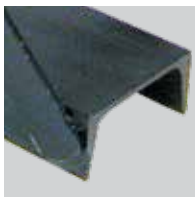

1701005

Part No.	Description	Height	Depth	Wt. (lb)
1701005	Structural Welded Brackets	18	18	24
1701010	Structural Welded Brackets	18	24	27
1701015	Structural Welded Brackets	24	24	32
1701012	Structural Welded Brackets	27	18	47

HEAVY DUTY, STRUCTURAL BOLTED



1701005B

Part No.	Description	Height	Depth	Wt. (lb)
1701005B	Structural Bolted Brackets	18	18	24
1701010B	Structural Bolted Brackets	18	24	27



STAINLESS STEEL

Made for long life and corrosion resistance with stainless steel construction.

- Mounting is made quick and easy with a universal hole pattern design.
- Strong, rigid, welded braces keep the brackets' shape intact.
- Conveniently sold in boxed pairs.
- For use on steel and stainless steel underbody truck tool boxes.
- Made in the USA.
- *Hardware not included*

FORMED, WELDED



1701031

Part No.	Description	Height	Depth	Wt. (lb)
1701031	Welded Brackets	18	18	19
1701041	Welded Brackets	18	24	22

ALUMINUM

Lightweight and corrosion-resistant aluminum construction.

- Strong, narrow 1/4 in. formed aluminum angles.
- Mounting brackets keep their shape with welded angle braces.
- Sold in boxed pairs for immediate use.
- Made in the USA.
- *Hardware not included*

FORMED, WELDED



1701030

Part No.	Description	Height	Depth	Wt. (lb)
1701030	Welded Brackets	18	18	7.5
1701040	Welded Brackets	24	24	10

FOR POLYMER UNDERBODIES

- Sold in boxed pairs
- Constructed of 3/16" thick 2" wide C-channel A-36 steel
- Black powder-coated
- Channel fits inside toolbox ribs
- Pre-drilled 7/16" mounting holes (nuts/bolts not included)

FORMED, WELDED



1701000

Part No.	Description	Height	Depth	Wt. (lb)
1701000	Brackets for 24" and 36" Poly	15	14	14.3
1701001	Brackets for 48" Poly	15	14	22.3

Steel Topsider

T-HANDLE LATCH

- 16 gauge steel box with 14 gauge steel doors
- Drop-down recessed doors
- Locking stainless steel T-handle latches
- Bolt-on continuous hidden hinge
- Replaceable 1/2 in. thick gasket sealing system
- Aircraft grade door cables
- Optional quick-mount trays
- Includes J-hooks for drill-free mounting and protective side rail pads
- Door opening: flat surface mount (90°)

GLOSS BLACK



1702950



1702940TRAY

GLOSS WHITE



1702840



1702840TRAY



Part No.	Height	Depth	Width	# Latches per Door	Wt. (lb)
1702940	16	13	72	1	115
1702950	16	13	88	1	120
1702980	18	16	72	1	118
1702990	18	16	88	1	136
1703000	18	16	90	1	150
1702960	16	13	96	2	128
1703020	18	16	96	2	151

OPTIONAL SHELF

Part No.	Height	Depth	Width	Wt. (lb)
1702940TRAY	2.25/4	10.75	35	11
1702950TRAY	2.25/4	10.75	43	14
1702960TRAY	2.25/4	10.75	47	15
1702980TRAY	2.25/4	13.75	35	12
1702990TRAY	2.25/4	13.75	43	14
1703000TRAY	2.25/4	13.75	44	15
1703020TRAY	2.25/4	13.75	77	16

Part No.	Height	Depth	Width	# Latches per Door	Wt. (lb)
1702840	16	13	72	1	115
1702850	16	13	88	1	120
1702880	18	16	72	1	118
1702890	18	16	88	1	136
1702895	18	16	90	1	136
1702860	16	13	96	2	128
1702920	18	16	96	2	147

OPTIONAL SHELF

Part No.	Height	Depth	Width	Wt. (lb)
1702840TRAY	2.25/4	10.75	35	11
1702850TRAY	2.25/4	10.75	43	14
1702860TRAY	2.25/4	10.75	47	15
1702880TRAY	2.25/4	13.75	35	12
1702890TRAY	2.25/4	13.75	43	14
1702895TRAY	2.25/4	13.75	44	15
1702920TRAY	2.25/4	13.75	77	16



1702850 shown with Optional Removable Tray



FLIP UP DOOR WITH COMPRESSION LATCH

- Gas shocks hold door open at 110°
- .100" thick diamond tread aluminum
- Locking die-cast T-handle compression latch
- Full length stainless steel bolt-on continuous hidden hinge
- Built-in rain gutter with automotive bulb seal
- Reinforced door backbone
- Replaceable gasket sealing system



DIAMOND TREAD

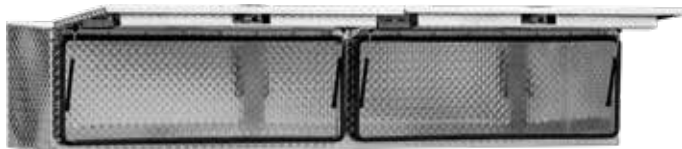

1701363

Part No.	Height	Depth	Width	# Latches per Door	Wt. (lb)
1701351	16	13	72	1	78
1701356	16	13	88	1	89
1701363	18	16	72	1	82
1701364	18	16	88	1	92
1701365	18	16	90	1	99
1701361	16	13	96	2	92
1701770	18	16	96	2	94

GLOSS BLACK DIAMOND TREAD



1721770

Part No.	Height	Depth	Width	# Latches per Door	Wt. (lb)
1721351	16	13	72	1	78
1721356	16	13	88	1	89
1721363	18	16	72	1	82
1721364	18	16	88	1	92
1721365	18	16	90	1	99
1721361	16	13	96	2	92
1721770	18	16	96	2	94

TEXTURED MATTE BLACK DIAMOND TREAD



1722365

Part No.	Height	Depth	Width	# Latches per Door	Wt. (lb)
1722351	16	13	72	1	78
1722356	16	13	88	1	89
1722363	18	16	72	1	82
1722364	18	16	88	1	92
1722365	18	16	90	1	99
1722361	16	13	96	2	92
1722770	18	16	96	2	94

1722356 shown



Aluminum Topsider

DROP DOOR WITH COMPRESSION LATCH

- .100" thick diamond tread aluminum
- Locking die-cast T-handle compression latch
- Full length stainless steel bolt-on continuous hidden hinge
- Replaceable gasket sealing system
- Aircraft grade door cables
- Includes J-hooks for drill-free mounting and protective side rail pads
- Door opening: flat surface mount (90°)



DIAMOND TREAD



1701551

GLOSS BLACK DIAMOND TREAD



1721551

TEXTURED MATTE BLACK DIAMOND TREAD, DUAL LATCH



1722568

Part No.	Height	Depth	Width	# Latches per Door	Wt. (lb)
1701551	16	13	72	1	78
1701556	16	13	88	1	89
1701563	18	16	72	1	82
1701564	18	16	88	1	92
1701565	18	16	90	1	99
1701561	16	13	96	2	92
1701568	18	16	96	2	103

Part No.	Height	Depth	Width	# Latches per Door	Wt. (lb)
1721551	16	13	72	1	78
1721556	16	13	88	1	89
1721563	18	16	72	1	82
1721564	18	16	88	1	92
1721565	18	16	90	1	99
1721561	16	13	96	2	92
1721568	18	16	96	2	103

Part No.	Height	Depth	Width	# Latches per Door	Wt. (lb)
1722551	16	13	72	1	78
1722556	16	13	88	1	89
1722563	18	16	72	1	82
1722564	18	16	88	1	92
1722565	18	16	90	1	90
1722561	16	13	96	2	92
1722568	18	16	96	2	103



1701556 shown



SMOOTH ALUMINUM

DROP DOOR WITH COMPRESSION LATCH

- .100" thick smooth aluminum
- Locking die-cast T-handle compression latch
- Full length stainless steel bolt-on continuous hidden hinge
- Replaceable gasket sealing system
- Aircraft grade door cables
- Includes J-hooks for drill-free mounting and protective side rail pads
- Door opening: flat surface mount (90°)

SMOOTH ALUMINUM



1751651



Part No.	Height	Depth	Width	# Latches per Door	Wt. (lb)
1751651	16	13	72	1	78
1751663	18	16	72	1	93
1751661	16	13	96	2	92
1751668	18	16	96	2	103

SMOOTH ALUMINUM, GLOSS BLACK



1752161

Part No.	Height	Depth	Width	# Latches per Door	Wt. (lb)
1752151	16	13	72	1	78
1752156	16	13	88	1	89
1752163	18	16	72	1	93
1752161	16	13	96	2	92
1752168	18	16	96	2	103

SMOOTH ALUMINUM, GLOSS WHITE



1753163

Part No.	Height	Depth	Width	# Latches per Door	Wt. (lb)
1753151	16	13	72	1	78
1753163	18	16	72	1	93
1753161	16	13	96	2	92
1753168	18	16	96	2	103



1753151 shown

Aluminum Topsider

CONTRACTOR WITH TWO LOWER DRAWERS

- .056" thick diamond tread aluminum
- Gas shocks lift and open door at over 90 degree angle
- Two bottom drawers feature adjustable dividers and 100 lb rated slides
- Locking stainless steel T-handle latches
- Replaceable gasket sealing system
- Aircraft grade door cables
- Mounting hardware included



1705641 open

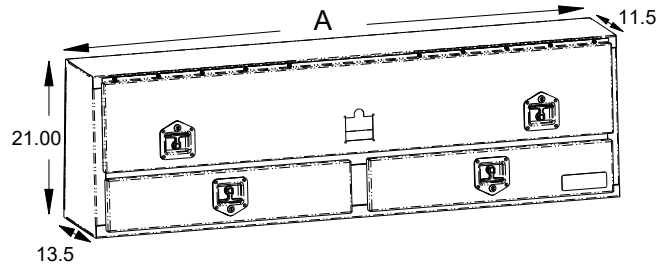

DIAMOND TREAD



1705641

Part No.	Top Doors	Bottom Drawers	Height	Depth	Width (A)	Wt. (lb)
1705641	1	2	21	13.5/11.5	72	58
1705651	1	2	21	13.5/11.5	88	91

Depth indicates bottom/top O.D.

GLOSS BLACK DIAMOND TREAD



1725651

Part No.	Top Doors	Bottom Drawers	Height	Depth	Width (A)	Wt. (lb)
1725641	1	2	21	13.5/11.5	72	58
1725651	1	2	21	13.5/11.5	88	91

Depth indicates bottom/top O.D.

1725641 shown



CONTRACTOR WITH LOWER DOOR

- .056" thick diamond tread aluminum
- Gas shocks lift and open door at over 90 degree angle
- Comes with two doors: top flip-up door and bottom drop door
- Locking stainless steel T-handle latches
- Replaceable gasket sealing system
- Aircraft grade door cables
- Mounting hardware included



1705640 open

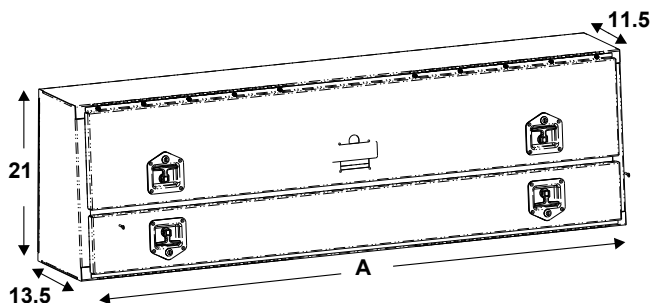

DIAMOND TREAD



1705640

Part No.	Top Doors	Bottom Doors	Height	Depth	Width (A)	Wt. (lb)
1705640	1	1	21	13.5/11.5	72	69
1705650	1	1	21	13.5/11.5	88	84
1705660	1	1	21	13.5/11.5	96	89

Depth indicates bottom/top O.D.

GLOSS BLACK DIAMOND TREAD



1725640

Part No.	Top Doors	Bottom Doors	Height	Depth	Width (A)	Wt. (lb)
1725640	1	1	21	13.5/11.5	72	69
1725650	1	1	21	13.5/11.5	88	84
1725660	1	1	21	13.5/11.5	96	89

Depth indicates bottom/top O.D.

Aluminum Topsider

HEAVY-DUTY FLATBED CONTRACTOR WITH LOWER DOOR **NEW**

- 0.100" thick diamond tread aluminum
- Gas shocks lift and open door at over 90 degree angle
- Comes with two doors: top flip-up door and bottom drop door
- Reinforced upper shelf to store heavier equipment
- Replaceable gasket sealing system
- Locking, die cast, compression latch system
- Aircraft-grade cables protect the lower door and hinge from damage



1701578 open

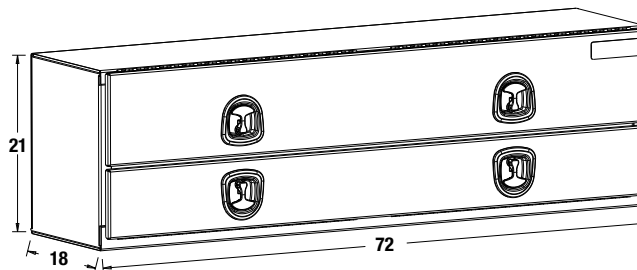

DIAMOND TREAD



1701578

Part No.	Top Doors	Bottom Doors	Height	Width	Depth	Wt. (lb)
1701578	1	1	21	72	18	99

GLOSS BLACK DIAMOND TREAD



1721578

Part No.	Top Doors	Bottom Doors	Height	Width	Depth	Wt. (lb)
1721578	1	1	21	72	18	99

TEXTURED MATTE BLACK DIAMOND TREAD



1722578

Part No.	Top Doors	Bottom Doors	Height	Width	Depth	Wt. (lb)
1722578	1	1	21	72	18	99



HEAVY-DUTY FLATBED CONTRACTOR WITH LOWER DRAWERS **NEW**

- 0.100" thick diamond tread aluminum
- Gas shocks lift and open door at over 90 degree angle
- Two bottom drawers feature adjustable dividers and 100 lb rated slides
- Reinforced upper shelf to store heavier equipment
- Replaceable gasket sealing system
- Locking, die cast, compression latch system
- Aircraft grade door cables

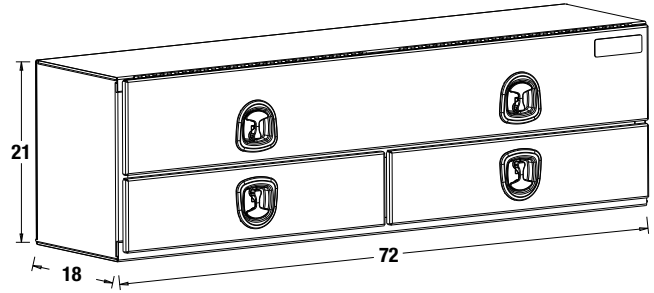

DIAMOND TREAD



Part No.	Top Doors	Bottom Drawers	Height	Width	Depth	Wt. (lb)
1701678	1	2	21	72	18	176

GLOSS BLACK DIAMOND TREAD



Part No.	Top Doors	Bottom Drawers	Height	Width	Depth	Wt. (lb)
1721678	1	2	21	72	18	176

TEXTURED MATTE BLACK DIAMOND TREAD



Part No.	Top Doors	Bottom Drawers	Height	Width	Depth	Wt. (lb)
1722678	1	2	21	72	18	176

Backpack 4 Doors, Offset Floor

DIAMOND TREAD ALUMINUM

- .100" thick aluminum diamond tread
- Stainless steel bolt-on continuous hidden hinges
- Integral mounting rail for quick and easy installation
- Doors open easily with gas powered shocks plus built-in rain gutter with automotive bulb seal
- Two shelves to organize tools and equipment plus two folding driver side J-hooks
- Universal spring cushion mounting kit, included with all aluminum backpack boxes, provides flex to reduce strain
- Backpack mounting adapter recommended for all 2017+ Ford® applications (see page 47)

DIAMOND TREAD ALUMINUM

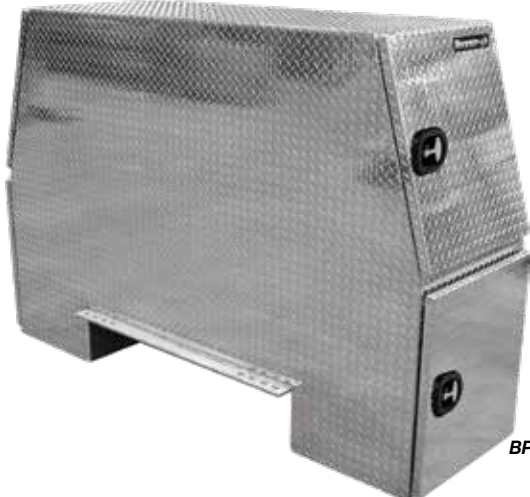

BP825524

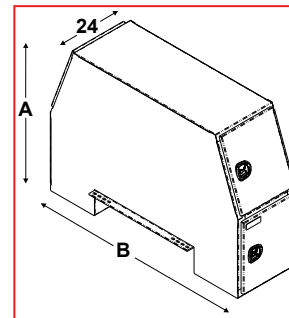

Part No.	Total Height (A)	Depth	Width (B)	Wt. (lb)
BP825524	55	24	82	234
BP826224	62	24	82	254
BP826524	65	24	82	316
BP827024	70	24	82	316
BP925824	58	24	92	255



For optional underbody box, see page 45.

⚠️CAUTION:** Failure to use supplied mounting kit may void warranty on Aluminum Backpack Boxes



BP825524 shown



CARBON STEEL

- 14 gauge steel box with 12 gauge steel doors (16 gauge stainless steel doors)
- Stainless steel bolt-on continuous hidden hinges
- Integral mounting rail for quick and easy installation
- Doors open easily with gas powered shocks plus built-in rain gutter with automotive bulb seal
- Two shelves to organize tools and equipment plus two folding driver side J-hooks
- Optional U-Bolt mounting kit sold separately (see page 46)
- Backpack mounting adapter recommended for all 2017+ Ford® applications (see page 47)

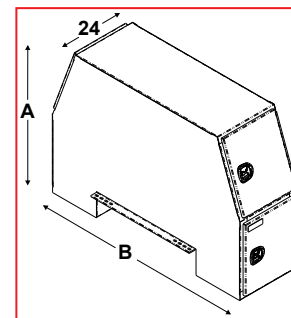
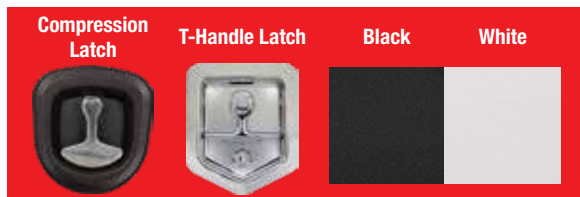

STEEL, GLOSS BLACK POWDER-COATED



BP855524B

Part No.	Total Height (A)	Depth	Width (B)	Wt. (lb)
BP855524B	55	24	85	536
BP826524B	65	24	82	600
BP925824B	58	24	92	576



For optional underbody box, see page 45.

STEEL, GLOSS BLACK POWDER-COATED BODY, POLISHED STAINLESS STEEL DOORS



BP855524BSST

Part No.	Total Height (A)	Depth	Width (B)	Wt. (lb)
BP855524BSST	55	24	85	538



For optional underbody box, see page 45.

STEEL, GLOSS WHITE POWDER-COATED



BP855524W

Part No.	Total Height (A)	Depth	Width (B)	Wt. (lb)
BP855524W	55	24	85	538
BP826524W	65	24	82	600
BP925824W	58	24	92	576



For optional underbody box, see page 45.

Backpack 4 Doors, Flat Floor

DIAMOND TREAD ALUMINUM

- .100" thick aluminum diamond tread
- Stainless steel bolt-on continuous hidden hinges
- Integral mounting rail for quick and easy installation
- Doors open easily with gas powered shocks plus built-in rain gutter with automotive bulb seal
- Two shelves to organize tools and equipment plus two folding driver side J-hooks
- Universal spring cushion mounting kit, included with all aluminum backpack boxes, provides flex to reduce strain
- Backpack mounting adapter recommended for all 2017+ Ford® applications (see page 47)

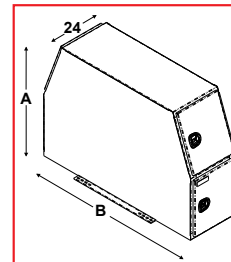

DIAMOND TREAD ALUMINUM



Part No.	Total Height (A)	Depth	Width (B)	Wt. (lb)
BP824624	46	24	82	216
BP855924	59	24	85	350



For optional underbody box, see page 45.

CAUTION: Failure to use supplied mounting kit may void warranty on Aluminum Backpack Boxes



CARBON STEEL

- 14 gauge steel box with 12 gauge steel doors (16 gauge stainless steel doors)
- Stainless steel bolt-on continuous hidden hinges
- Integral mounting rail for quick and easy installation
- Doors open easily with gas powered shocks plus built-in rain gutter with automotive bulb seal
- Two shelves to organize tools and equipment plus two folding driver side J-hooks
- Optional U-Bolt mounting kit sold separately (see page 46)
- Backpack mounting adapter recommended for all 2017+ Ford® applications (see page 47)

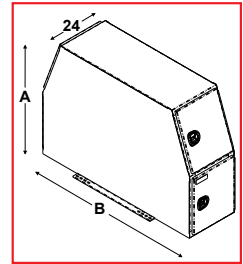

STEEL, GLOSS BLACK POWDER-COATED



BP855924B

Part No.	Total Height (A)	Depth	Width (B)	Wt. (lb)
BP824624B	46	24	82	454
BP855924B	59	24	85	536



For optional underbody box, see page 45.

STEEL, GLOSS BLACK POWDER-COATED BODY, POLISHED STAINLESS STEEL DOORS



BP855924BSST

Part No.	Total Height (A)	Depth	Width (B)	Wt. (lb)
BP855924BSST	59	24	85	536



For optional underbody box, see page 45.

STEEL, GLOSS WHITE POWDER-COATED



BP855924W

Part No.	Total Height (A)	Depth	Width (B)	Wt. (lb)
BP824624W	46	24	81	454
BP855924W	59	24	85	536



For optional underbody box, see page 45.

Backpack 2 Doors, Offset Floor

DIAMOND TREAD ALUMINUM

- .100" thick aluminum diamond tread
- Stainless steel bolt-on continuous hidden hinges
- Integral mounting rail for quick and easy installation
- Doors open easily with gas powered shocks plus built-in rain gutter with automotive bulb seal
- Two shelves to organize tools and equipment plus two folding driver side J-hooks
- Universal spring cushion mounting kit, included with all aluminum backpack boxes, provides flex to reduce strain
- Backpack mounting adapter recommended for all 2017+ Ford® applications (see page 47)



DIAMOND TREAD ALUMINUM



BP965724

****CAUTION:** Failure to use supplied mounting kit may void warranty on Aluminum Backpack Boxes

Part No.	Total Height	Depth	Width	Wt. (lb)
BP965724	57	24	96	262



For optional underbody box, see page 45.

CARBON STEEL

- 14 gauge steel box with 12 gauge steel doors
- Stainless steel bolt-on continuous hidden hinges
- Integral mounting rail for quick and easy installation
- Doors open easily with gas powered shocks plus built-in rain gutter with automotive bulb seal
- Two shelves to organize tools and equipment plus two folding driver side J-hooks
- Optional U-Bolt mounting kit sold separately (see page 46)
- Backpack mounting adapter recommended for all 2017+ Ford® applications (see page 47)



STEEL, GLOSS BLACK POWDER-COATED



BP965724B

Part No.	Total Height	Depth	Width	Wt. (lb)
BP965724B	57	24	96	690



For optional underbody box, see page 45.

STEEL, GLOSS WHITE POWDER-COATED



BP965724W

Part No.	Total Height	Depth	Width	Wt. (lb)
BP965724W	57	24	96	690



For optional underbody box, see page 45.



*

DIAMOND TREAD ALUMINUM

- .100" thick aluminum diamond tread
- Stainless steel bolt-on continuous hidden hinges
- Integral mounting rail for quick and easy installation
- Doors open easily with gas powered shocks plus built-in rain gutter with automotive bulb seal
- Two shelves to organize tools and equipment plus two folding driver side J-hooks
- Universal spring cushion mounting kit, included with all aluminum backpack boxes, provides flex to reduce strain
- Backpack mounting adapter recommended for all 2017+ Ford® applications (see page 47)



DIAMOND TREAD ALUMINUM



BP964824

****CAUTION:** Failure to use supplied mounting kit may void warranty on Aluminum Backpack Boxes

Part No.	Total Height	Depth	Width	Wt. (lb)
BP964824	48	24	96	240



For optional underbody box, see page 45.

CARBON STEEL

- 14 gauge steel box with 12 gauge steel doors
- Stainless steel bolt-on continuous hidden hinges
- Integral mounting rail for quick and easy installation
- Doors open with gas powered shocks plus built-in rain gutter with automotive bulb seal
- Two shelves to organize tools and equipment plus two folding driver side J-hooks
- Optional U-Bolt mounting kit sold separately (see page 46)
- Backpack mounting adapter recommended for all 2017+ Ford® applications (see page 47)



STEEL, GLOSS BLACK POWDER-COATED



BP964824B

Part No.	Total Height	Depth	Width	Wt. (lb)
BP964824B	48	24	96	700
BP964824BLL	48	24	96	700

BP964824BLL comes with 2 full length adjustable shelves



For optional underbody box, see page 45.

STEEL, GLOSS WHITE POWDER-COATED



BP964824W

Part No.	Total Height	Depth	Width	Wt. (lb)
BP964824W	48	24	96	700
BP964824WLL	48	24	96	700

BP964824WLL comes with 2 full length adjustable shelves



For optional underbody box, see page 45.

STEEL, PRIMED POWDER-COATED



BP964824P

Part No.	Total Height	Depth	Width	Wt. (lb)
BP964824P	48	24	96	700



For optional underbody box, see page 45.

L-Pack

DIAMOND TREAD ALUMINUM

- .100" thick aluminum diamond tread
- Stainless steel bolt-on continuous hidden hinges
- Integral mounting rail for quick and easy installation
- Ships with 2 additional 30" underbody boxes welded on to provide additional storage
- Two shelves to organize tools and equipment plus two folding driver side J-hooks
- Universal spring cushion mounting kit, included with all aluminum backpack boxes, provides flex to reduce strain
- Backpack mounting adapter recommended for all 2017+ Ford® applications (see page 47)

DIAMOND TREAD ALUMINUM



BP826254

⚠️CAUTION:** Failure to use supplied mounting kit may void warranty on Aluminum Backpack Boxes

CARBON STEEL

- 14 gauge steel body and 12 gauge steel doors with a corrosion resistant powder-coated finish
- Stainless steel bolt-on continuous hidden hinges
- Integral mounting rail for quick and easy installation
- Ships with 2 additional 24" underbody boxes bolted on to provide additional storage
- Two shelves to organize tools and equipment plus two folding driver side J-hooks
- Optional U-Bolt mounting kit sold separately (see page 46)
- Backpack mounting adapter recommended for all 2017+ Ford® applications (see page 47)

STEEL, GLOSS BLACK POWDER-COATED



BP85548B

STEEL, GLOSS WHITE POWDER-COATED



BP85548W

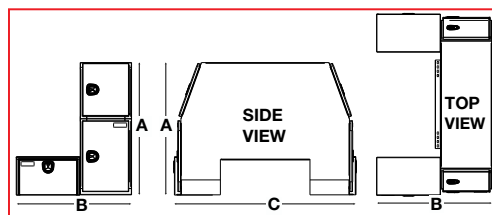

Part No.	Total Height (A)	Depth (C)	Width (B)	Wt. (lb)
BP826254	62	54	82	340
BP826554	65	54	82	314
BP827054	70	54	82	384

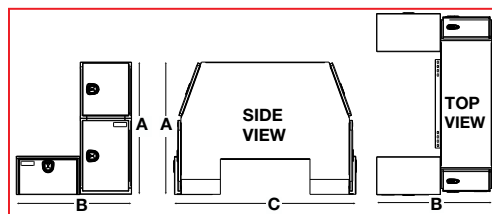

Part No.	Total Height (A)	Depth (C)	Width (B)	Wt. (lb)
BP85548B	55	54	82	638

Part No.	Total Height (A)	Depth (C)	Width (B)	Wt. (lb)
BP85548W	55	54	82	638



DIAMOND TREAD ALUMINUM

- Can be used as bolt-on or weld-on underbodies with any backpack box
- Durable, corrosion-resistant, .100" thick aluminum diamond tread
- Locking die-cast T-handle compression latch
- Drop-down recessed door
- Aluminum bolt-on continuous hidden hinge and replaceable gasket sealing system
- Aircraft grade door cables



BP141624

Part No.	Height	Depth	Width	Wt. (lb)
BP141624	14	16	24	18

CARBON STEEL

- Can be used as bolt-on underbodies with any backpack box
- 14 gauge powder-coated steel box
- Locking stainless steel T-handle latch
- Drop-down recessed door
- Aluminum bolt-on continuous hidden hinge and replaceable gasket sealing system
- Aircraft grade door cables



1703300

STEEL, GLOSS BLACK POWDER-COATED

Part No.	Height	Depth	Width	Wt. (lb)
1703300	14	16	25	46
1703303	14	16	30	55
1703304*	14	16	30	72

*Includes built-in shelf



1703400

STEEL, PRIMED POWDER-COATED

Part No.	Height	Depth	Width	Wt. (lb)
1703400	14	16	24	46



1703900

Part No.	Height	Depth	Width	Wt. (lb)
1703900	14	16	24	46

Backpack Accessories

STEEL AND ALUMINUM BACKPACK ACCESSORIES



UNIVERSAL SPRING CUSHION MOUNTING KIT

- Provides flex to reduce strain on steel and aluminum backpack truck boxes
- Ideal for off-road applications
- 5/8" U-bolts with forged tie bars, springs and fasteners (all zinc plated)
- **Included with all aluminum backpacks**
- ⚠ **CAUTION:** Failure to use supplied mounting kit may void warranty on aluminum backpack boxes
- Additional sizes available as custom orders



Part No.	Description	Wt. (lb)
3008086	Universal Spring Cushion Mounting Kit	17

UNIVERSAL SQUARE BEND U-BOLT KIT

- Secure truck boxes to truck body, or connect body to truck chassis
- 5/8" U-Bolts with fasteners and forged tie bars
- Durable Grade 5 hardware
- Additional sizes available as custom orders

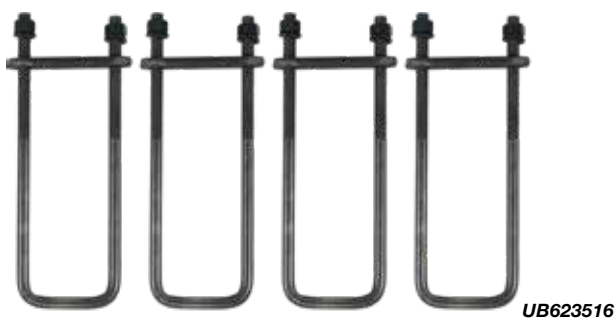

Part No.	Description	Wt. (lb)
UB623516	Universal Mounting Kit	17



BACKPACK MOUNTING ADAPTER, FORD 2017+

- Provides a level base with a pre-fabricated kit that ensures optimal fit and reduced installation time
- Black powder-coated bracket and zinc plated hardware add corrosion resistance
- Recommended for use with all Ford® 2017+ applications



Part No.	Description	Wt. (lb)
3037014	For Ford F350, F450, F550 (2017 - Mid 2020)	47.24
3037014B*	For Ford F350, F450, F550 (2020+) including Diesel	46.96

J-HOOK HANGER

- Universal J-hook hangers for holding items like chains or straps
- Bolt-on or weld-on
- Folding zinc plated J-hooks swing flush with compartment walls when not in use
- Hanger 3009122 comes installed inside every box*

*Excludes BP964824BLL and BP964824WLL due to full-length shelving.



Part No.	Description	Wt. (lb)
3009122	Double J-Hook with Steel Mounting Angle	0.85
3009938	Triple J-Hook with Aluminum Mounting Angle	2.16
3009123	Double J-Hook with Aluminum Mounting angle	0.51

Backpack Accessories

SILICONE LED STRIP LIGHTS WITH 3M™ ADHESIVE BACK

LIMITED LIFETIME WARRANTY
12 VOLTS
IP 68

Connection	Blunt Cut, Both Ends
Hardware Included	End Caps and Mounting Clips

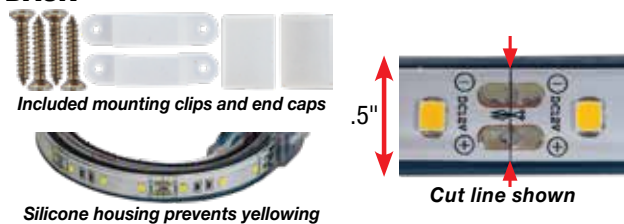

Clear Cool Strip Lights

Part No.	Color	Size	LED's	Amps	Lumens	Wt. (lbs.)
5622120	Clear, Cool	18"	27	0.45	513	0.31
5622941	Clear, Cool	24"	36	0.60	684	0.35
5623957	Clear, Cool	36"	54	0.90	1,026	0.40
5625377	Clear, Cool	48"	72	1.20	1,368	0.44

Accessories

Part No.	Description	Wt. (lbs.)
3035896	LED Strip Light Mounting Channel, 17-1/2" Long, Black, Mounting 3M® Tape	0.39

LED STRIP LIGHTS WITH 3M™ ADHESIVE BACK

LIMITED LIFETIME WARRANTY
12 VOLTS
IP 67

Connection	Blunt Cut, Both Ends
Hardware Included	End Caps and Mounting Clips



Clear Warm Strip Lights

Part No.	Color	Size	LED's	Amps	Lumens	Wt. (lbs.)
5621827	Clear, Warm	18"	27	0.41	360	0.31
5622436	Clear, Warm	24"	36	0.54	470	0.35
5623654	Clear, Warm	36"	54	0.81	710	0.40
5624872	Clear, Warm	48"	72	1.12	940	0.44
5626090	Clear, Warm	60"	90	1.30	1,180	0.55
56296144	Clear, Warm	96"	144	2.00	2,160	0.88



Clear Cool Strip Lights

Part No.	Color	Size	LED's	Amps	Lumens	Wt. (lbs.)
5621928	Clear, Cool	18"	27	0.41	360	0.31
5622537	Clear, Cool	24"	36	0.54	470	0.35
5623755	Clear, Cool	36"	54	0.81	710	0.40
5624973	Clear, Cool	48"	72	1.12	940	0.44
5626191	Clear, Cool	60"	90	1.30	1,175	0.55
56297145	Clear, Cool	96"	144	2.00	2,160	0.88
562109166	Clear, Cool	108"	165	3.00	2,400	1.12
562133202	Clear, Cool	132"	201	4.00	3,000	1.37



Accessories

Part No.	Description	Wt. (lbs.)
3035896	LED Strip Light Mounting Channel, 17-1/2" Long, Black, Mounting 3M® Tape	0.39

Accessories

Part No.	Description	Wt. (lbs.)
5621002	LED Strobe Controller with 6" Leads, Converts Steady-On Strip Lights to a Strobe Pattern	0.07



DIAMOND TREAD ALUMINUM

- .100" thick aluminum diamond tread
- 1/4 in. stainless steel continuous hinges
- Rain channel and watertight automotive bulb seal keeps tools protected
- Full length stationary shelf provides organization for tools and equipment.



DIAMOND TREAD ALUMINUM

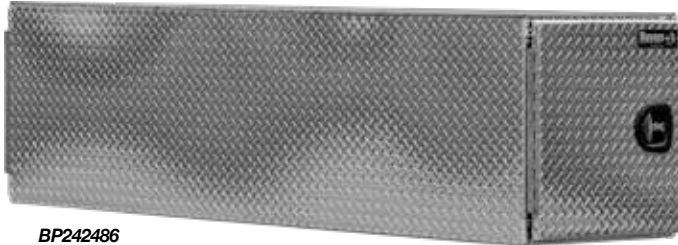

BP242486

Part No.	Height	Depth	Width	Wt. (lb)
BP242486	24	24	86	125
BP242496	24	24	96	135

CARBON STEEL

- 15 gauge steel box with 12 gauge steel doors
- 1/4 in. stainless steel continuous hinges
- Rain channel and watertight automotive bulb seal keeps tools protected
- Full length stationary shelf provides organization for tools and equipment.



STEEL, GLOSS BLACK POWDER-COATED



BP242486B

Part No.	Height	Depth	Width	Wt. (lb)
BP242486B	24	24	86	245
BP242496B	24	24	96	265

STEEL, GLOSS WHITE POWDER-COATED

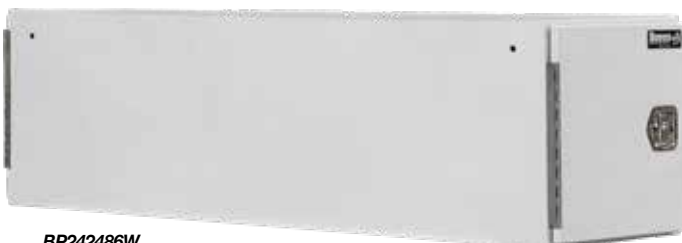

BP242486W

Part No.	Height	Depth	Width	Wt. (lb)
BP242486W	24	24	86	245
BP242496W	24	24	96	265

Crossover

SINGLE LID WITH PUSH-BUTTON LOCK

- Available for full-size and compact pickups
- Corrosion resistant diamond tread aluminum construction
- Gas shock props lid open
- Stainless steel push-button locks open from either side
- Suspends from pickup side rails
- Weather resistant seals keep moisture and dirt out of the tool box
- Includes standard J-hook mounting hardware
- Includes locking tool tray
- Pre-drilled mounting holes and included hardware make installation easy

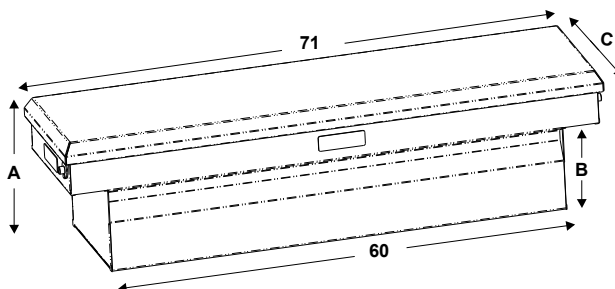

DIAMOND TREAD



1709420

Part No.	Height (A/B)	Depth (C)	Width	Wt. (lb)
1709410	18/11	20	71/60	75
1709415	23/16	20	71/60	81
1709420	18/11	27	71/60	89
1709425	23/16	27	71/60	94
1709430	13/6	20	63/54	63



Optional Universal Mounting Kit, see page 60.

GLOSS BLACK DIAMOND TREAD



1729420

Part No.	Height (A/B)	Depth (C)	Width	Wt. (lb)
1729410	18/11	20	71/60	75
1729415	23/16	20	71/60	77
1729420	18/11	27	71/60	89
1729425	23/16	27	71/60	91
1729430	13/6	20	63/54	63



Optional Universal Mounting Kit, see page 60.

TEXTURED MATTE BLACK DIAMOND TREAD



1739410

Part No.	Height (A/B)	Depth (C)	Width	Wt. (lb)
1739410	18/11	20	71/60	75
1739420	18/11	27	71/60	89
1739415	23/16	20	71/60	81
1739425	23/16	27	71/60	94
1739430	13/6	20	63/54	63



Optional Universal Mounting Kit, see page 60.



GULL WING WITH PUSH-BUTTON LOCK

- Available for full-size pickups
- Corrosion resistant diamond tread aluminum construction
- Gas shock props lid open
- Stainless steel push-button locks open from either side
- Suspends from pickup side rails
- Weather resistant seals keep moisture and dirt out of the tool box
- Includes standard J-hook mounting hardware
- Includes locking tool tray
- Pre-drilled mounting holes and included hardware make installation easy

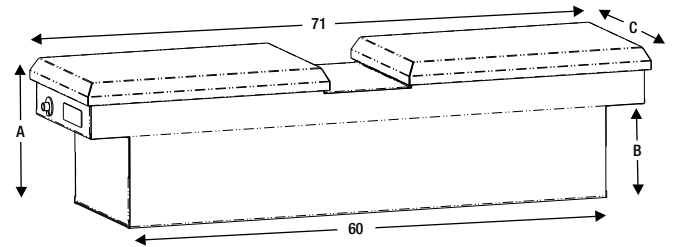

DIAMOND TREAD



1710410

Part No.	Height (A/B)	Depth (C)	Width	Wt. (lb)
1710410	18/11	20	71/60	77
1710413	23/16	20	71/60	83
1710420	18/11	27	71/60	93
1710423	23/16	27	71/60	100



Optional Universal Mounting Kit, see page 60.

GLOSS BLACK DIAMOND TREAD



1720410

Part No.	Height (A/B)	Depth (C)	Width	Wt. (lb)
1720410	18/11	20	71/60	77
1720413	23/16	20	71/60	83
1720420	18/11	27	71/60	93
1720423	23/16	27	71/60	100



Optional Universal Mounting Kit, see page 60.

TEXTURED MATTE BLACK DIAMOND TREAD



1722410

Part No.	Height (A/B)	Depth (C)	Width	Wt. (lb)
1722410	18/11	20	71/60	77
1722413	23/16	20	71/60	83
1722420	18/11	27	71/60	93
1722423	23/16	27	71/60	100



Optional Universal Mounting Kit, see page 60.

Lo-Sider

LO-SIDER WITH PUSH-BUTTON LOCK **NEW**

- Available for full-size and compact pickups
- Heavy-duty reinforced lid
- Gas shock props lid open
- Stainless steel push-button lock
- Suspends from pickup side rails
- Weather resistant seals keep moisture and dirt out of the tool box
- Includes standard J-hook mounting hardware
- Pre-drilled mounting holes and included hardware make installation easy

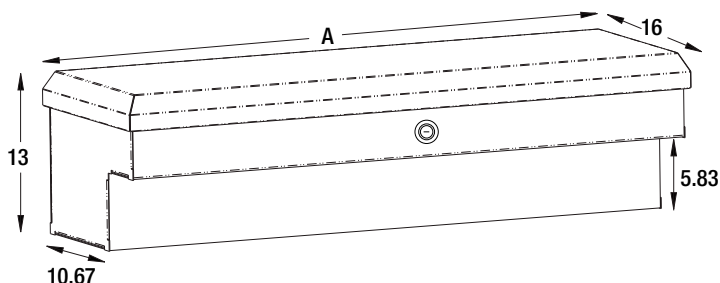

DIAMOND TREAD



1713025

Part No.	Height	Depth	Width (A)	Wt. (lb)
1713005	13	16	36	26
1713015	13	16	47	30
1713025	13	16	56	34
1713030	13	16	70	40
1713035	13	16	87	46

GLOSS BLACK DIAMOND TREAD



1723025

Part No.	Height	Depth	Width (A)	Wt. (lb)
1723005	13	16	36	26
1723015	13	16	47	30
1723025	13	16	56	34
1723030	13	16	70	40
1723035	13	16	87	46

TEXTURED MATTE BLACK DIAMOND TREAD



1733025

Part No.	Height	Depth	Width (A)	Wt. (lb)
1733005	13	16	36	26
1733015	13	16	47	30
1733025	13	16	56	34
1733030	13	16	70	40
1733035	13	16	87	46



JUMBO CHEST WITH PADDLE LATCH

- .100" thick diamond tread
- Locking stainless steel paddle latch
- Continuous aluminum hinge is welded to the lid and bolted to the box
- Zinc plated handles

DIAMOND TREAD ALUMINUM



1712110



Part No.	Height	Depth	Width	Cubic ft.	Wt. (lb)
1712110	24	24/22	49	15	74
1712120	30	30/28	49	24	92

POLY CHEST WITH HASP

- Lightweight, dent-resistant, high-density polyethylene body
- Box contents stay safe and secure behind a molded, double-wall, stainless steel hinged lid
- Corrosion and weather resistant stainless steel hasp and hinge made for use with combination lock or padlock (lock sold separately)
- Mount to floor of pickup beds, trailers or for use in garages

BLACK, SINGLE HASP



1712230



Part No.	# Hasps	Height	Depth	Width	Cubic ft.	Wt. (lb)
1712230	1	13.5	15/9.25	32/29.5	2.6	16
1712250	1	22.5	19.5/18.75	51/47	8.4	34

BLACK, DUAL HASP



1712240

Part No.	# Hasps	Height	Depth	Width	Cubic ft.	Wt. (lb)
1712240	2	17.25	19/13.25	44/41.25	6.3	28
1712255	2	26	23/21	51/47.25	17	46
1712260	2	23	25/19	77/73	18.8	52

Storage Chests

POLY CHEST WITH 2" RECEIVER MOUNT

- Durable, lightweight high density polyethylene construction
- Fully enclosed, water resistant design
- Mounts in 2" hitch receivers to provide portable, accessible storage
- Great for camping, fishing, tailgating, and more
- 17 cubic feet of functional space
- Holds up to 300 pounds
- Double walled lid with two lockable hasps (padlocks sold separately)
- Steel frame with black powder-coated finish
- Comes pre-drilled for easy assembly and installation
- Comes with all hardware including 5/8in. hitch pin



Part No.	# Hasps	Height	Depth	Width	Cubic ft.	Wt. (lb)
1707020	2	26	23/21	51/47.25	17	76



1707020 shown



STEEL TRAILER TONGUE WITH PADDLE LATCH

- 15 gauge steel box and door
- Locking stainless steel paddle latch
- Stainless steel continuous hidden hinge
- Designed to mount to the front of A-frame style trailers

GLOSS BLACK



1701280

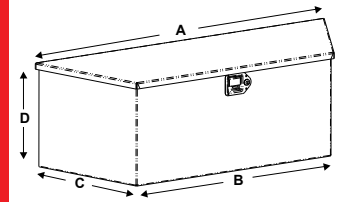

Part No.	Height (D)	Depth (C)	Width (A/B)	Wt. (lb)
1701281	12.3	12.6	148./27.1	33
1701280	16.3	14.3	21.2/35.1	51
1701285	16.3	16.14	33.5/49	74

ALUMINUM TRAILER TONGUE WITH PADDLE LATCH

- .056 thick diamond tread aluminum
- Locking stainless steel paddle latch
- Aluminum continuous hidden hinge
- Designed to mount to the front of A-frame style trailers

DIAMOND TREAD



1701380

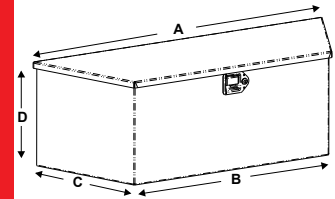

Part No.	Height (D)	Depth (C)	Width (A/B)	Wt. (lb)
1701380	14.8	14.4	35.2/21.2	17.5
1701385	18.3	16.1	33.4/29.22	28

POLY TRAILER TONGUE WITH HASP

- Constructed of high-density polyethylene
- Designed to mount to the front of A-frame style trailers
- Corrosion and weather resistant stainless steel hasp and hinge made for use with combination lock or padlock (lock sold separately)

BLACK



WHITE

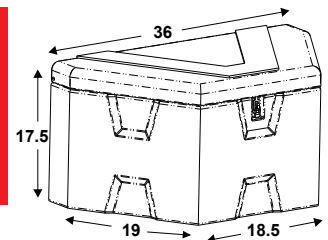

Part No.	Height	Depth	Width	Cubic ft.	Wt. (lb)
1701680	18	19	36/18	5.34	21

Part No.	Height	Depth	Width	Cubic ft.	Wt. (lb)
1701679	18	19	36/18	5.34	21

Trailer Tongue

STEEL PUMP BOX AND BATTERY BOX FOR DUMP-TRAILERS

- Durable 15-gauge steel toolbox with gloss black powder-coated finish.
- Predrilled holes with protective exit grommet for cables.
- Locking stainless steel paddle latch with 2 keys.
- Continuous stainless steel hinge.
- Weather-resistant seals keep moisture and dirt out of the tool box.
- Aircraft-grade cable protects the lid and hinge.
- Made in the USA.

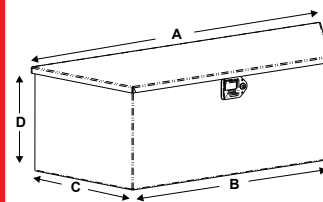

Part No.	Height (D)	Depth (C)	Width (A/B)	Wt. (lb)
1701283	12.4	17.8	31.1/14.6	17.5

GLOSS BLACK



1701283



Frame Steps

FRAME STEPS

- Grip strut provides superior traction even in inclement weather
- Universal design fits Peterbilt®, Kenworth®, International®, Freightliner®, Western-Star®, Volvo®, and Mack® trucks
- Corrosion resistant aluminum construction with .188 in. thick sides for years of dependable service
- Universal 4-bolt mounting pattern is easy to install on most semi truck frames

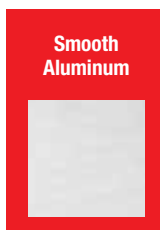

5239018

Part No.	Height	Depth	Width	Wt. (lb)
5239012	24	28	12	12
5239018	24	28	18	13
5239024	24	28	24	14



STEP BOXES

- Provides frame steps with built-in storage space
- Universal design fits Peterbilt®, Kenworth®, International®, Freightliner®, Western-Star®, Volvo®, and Mack® trucks
- Non-slip (grip punch) steps
- .125" smooth aluminum body
- .100" diamond tread aluminum door
- Automotive D-bulb seal protects from the elements
- Locking die-cast T-handle compression latch
- Stainless steel continuous hidden hinge



1705180



1705180 open



Part No.	Height	Depth	Width	Wt. (lb)
1705180	24	28	12	40
1705181	24	28	18	46
1705182	24	28	24	56
1705183	24	28	30	66

WIDOPEN™ STEP BOXES

- Provides frame steps with built-in storage space
- Universal design fits Peterbilt®, Kenworth®, International®, Freightliner®, Western-Star®, Volvo®, and Mack® trucks
- Replaceable non-slip (grip strut) steps
- .125" smooth aluminum construction
- Automotive D-bulb seal protects from the elements
- Locking, polished stainless steel T-handle latch
- Hinge and hardware are constructed of corrosion resistant stainless steel



1705281



1705281 open



Part No.	Height	Depth	Width	Wt. (lb)
1705280	24	28	12	40
1705281	24	28	18	47
1705282	24	28	24	56
1705283	24	28	30	64
1705284	24	28	36	76
1705285	24	28	16	45
1705286	24	28	22	51

In-Frame Boxes

IN-FRAME BOXES **NEW**

- Mounts between truck frame rails
- Universal design fits Peterbilt®, Kenworth®, International®, Freightliner®, Western-Star®, Volvo®, and Mack® trucks
- Body constructed of .100" smooth aluminum
- .125" Diamond tread aluminum lid
- Built-in rain gutter with automotive bulb seal
- Adjustable stainless steel latch for use with combination lock or padlock (sold separately)
- Full width stainless steel hinge
- Includes Mounting Kit
- Universal Mounting Kit (1705399) is also available separately for purchase



Part No.	Height	Depth	Width	Wt. (lb)
1705384	9	22	30	42
1705381†	12	24	32	52

†Includes notched center channel to accommodate driveline or accessories

CHAIN HOLDER

- Constructed of structural steel with aluminum diamond tread cover
- TIG welded
- Pre-drilled mounting holes
- Hinged diamond plate cover comes with lock hasp for secure use
- Keeps tire chains securely in place



Part No.	Height	Depth	Width	Wt. (lb)
5910024	9	7.5	24	34



UNIVERSAL HEAVY-DUTY OPEN-TOP CARGO AND TOOL BASKETS **NEW**

- Add additional storage space to your flatbed, service body, or landscape trailer
- Open design is good for storing construction tools, hand tools, masonry supplies, gas cans, oil, traffic cones, and landscape supplies
- The basket's perforated holes allow for quick drainage of water

24" & 36" INTERCHANGEABLE LENGTH BASKETS

- Each basket measures 18" wide by 10" tall and is available in 24" or 36" lengths
- Lengths are interchangeable: combine multiple 24" kits together or mix with 36" lengths
- Constructed from rugged 14-gauge carbon steel with a corrosion-resistant powder coated finish inside and out
- Fasteners, risers, and assembly instructions are included



Part No.	Length (in.)	Width (in.)	Height (in.)	Wt. (lb)
1744124	24	18	10	37

Part No.	Length (in.)	Width (in.)	Height (in.)	Wt. (lb)
1744136	36	18	10	46

54" FIXED LENGTH BASKET

- Includes 2 adjustable dividers to configure the basket's layout
- Constructed from rugged 12-gauge carbon steel with a corrosion-resistant powder coated finish inside and out
- Fasteners and assembly instructions are included



Part No.	Length (in.)	Width (in.)	Height (in.)	Wt. (lb)
LT44	53.75	18.00	10.00	74.36

Parts & Accessories

UNIVERSAL MOUNTING KIT FOR CROSSOVER AND SADDLE TRUCK TOOL BOXES

- Universal design; can be used with any brand Crossover, Saddle or Gull Wing Truck Tool Box; works with any brand Pick-Up Truck
- Quickly install your crossover truck tool box with this 2-piece hardware set
- Constructed of durable materials to prevent corrosion
- Kit Contains: corrosion-resistant aluminum J-hooks and anti-rust 304-grade stainless steel washers and bolts



Part No.	Description	Wt. (lb)
1701052	Universal Mounting Kit for Crossover, Saddle, and Gull Wing Truck Tool Boxes	.33

TOPSIDER MOUNTING HARDWARE KITS

- Quickly and securely attach your topsider truck tool box to your truck bed rails
- Constructed of durable materials to prevent corrosion
- Kit contains: two powder-coated steel leg brackets, j-bolts with fasteners, and a rubber pad to protect the truck bed rails
- **Included with all topsiders**



Part No.	Color	Wt. (lb)
3005318	Black	8
3004604	White	8

LO-SIDER MOUNTING HARDWARE KITS

- Quickly and securely attach your topsider truck tool box to your truck bed rails
- Constructed of durable materials to prevent corrosion
- Kit contains: two powder-coated steel leg brackets, j-bolts with fasteners, and a rubber pad to protect the truck bed rails
- **Included with all lo-siders**



Part No.	Color	Wt. (lb)
3025060	Black	8

SHELF KITS **NEW**

- Universal design works with any brand underbody or underbed truck tool box.
- Shelf adjusts to three different heights, optimizing storage space inside your truck box.
- Constructed from durable, 16-gauge galvanized steel.
- No tools required for assembly or installation.
- Designed for underbody truck tool boxes measuring 18" tall x 18" wide. Select the length that matches the length of your tool box

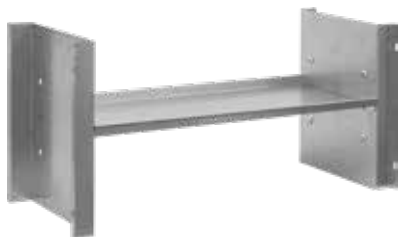

Part No.	Height(in)	Depth(in)	Width(in)	Wt. (lbs.)
1701072*	18	18	36	17
1701077*	18	18	48	19
1701082*	18	18	60	22

HEAVY DUTY TRUCK TOOL BOX LINER

- Roll Length is 18" wide by 16' long
- Universal design; can be used with any brand Truck Tool Box, Tool Chest, Garage, Shop, Mechanic or Utility Cabinet, Cart, or Workbench
- Non-slip design; holds tools and gear firmly in place
- Non-adhesive; easily removable and leaves no sticky residue on surfaces
- Non-absorbent; grease and oil resistant; washable and easy to clean
- Grid design; easily cut to fit a variety of storage spaces



Part No.	Depth (in)	Width (in)	Wt. (lb)
1701062	16	18	3.42

UNIVERSAL HEAVY-DUTY INTERLOCKING DRY-MAT FLOOR TILE AND SHELF LINER

- Multi-Purpose. Upgrade your garage, trailer, or workshop, or use as a shelf liner in vans, work trucks, service bodies, or inside truck tool boxes.
- Tool-Free Installation. The 12" x 12" tiles snap together with ease.
- Anti-Slip Design. The automotive-grade recycled plastic tiles provide excellent traction, along with added cushion and support for your feet.
- Easy to Clean. Remove oil, dirt, dust, or other spills with a hose or shop vac.
- Finished Border. The male and female beveled-edge pieces (sold separately) provide a professional finish.



Part No.	Description	Dim	Wt. (lbs.)
DM1212B	Tile	12" x 12"	1.42
DM0212BF	Female Edge	2" x 12"	0.33
DM0212BM	Male Edge	2" x 12"	0.35

Parts & Accessories

PADDLE / SLAM LATCHES

TEAR DROP SINGLE-POINT ROTARY PADDLE LATCH

- Hidden studs help safeguard belongings
- Polished stainless steel construction



L3890RLS Front



L3890RLS Back

Part No.	Width (in.)	Height (in.)	Mount Width (in.)	Mount Height (in.)	Mount Type	Locking	Housing Finish	Housing Material	Wt. (lbs.)
L3890RLS	4.75	5.50	3.88	3.94	Stud	Yes	Polished	Stainless Steel	1.22

Accessories:

Part No.	Description	Wt. (lbs.)
3005833	Striker Plate/Bracket for L3890RLS	0.26
CH545	Key Only	0.02
L881XGO	Gasket	0.13

STANDARD SIZE RECTANGULAR PADDLE LATCH

- Locking and non-locking options available
- Standard size ideal for larger applications



L3885RLS Front



L3885RLS Back

Part No.	Width (in.)	Height (in.)	Mount Width (in.)	Mount Height (in.)	Mount Type	Locking	Housing Finish	Housing Material	Wt. (lbs.)
L3885RLS	4.25	5.50	3.69	3.75	Stud	Yes	Polished	Stainless Steel	1.43
L3885	4.25	5.50	3.70	3.75	Bolt-On	Yes	Polished	Stainless Steel	1.13
N3885	4.25	5.50	3.69	3.75	Bolt-On	No	Polished	Stainless Steel	1.13
L3980	4.25	4.75	3.70	3.75	Weld-On	Yes	Zinc Plated	Carbon Steel	1.13
N3980	4.25	5.50	3.25	4.25	Weld-On	No	Zinc Plated	Carbon Steel	1.13

Accessories:

Part No.	Description	Wt. (lbs.)
L38RLSCH545	Cylinder and Keys CH545 for L3885RLS	0.25
CH545	Key Only for L3885RLS	0.02
3002713	Striker Latch/Pin for L3885RLS	0.16
39LL71	Cylinder and Keys for L3885, L3980	0.10
LL71	Key Only for L3885, L3980	0.02

JUNIOR RECTANGULAR PADDLE LATCH

- Locking and non-locking options available
- Junior size ideal for medium sized applications



L1883 Front



L1883 Back

Part No.	Width (in.)	Height (in.)	Mount Width (in.)	Mount Height (in.)	Mount Type	Locking	Housing Finish	Housing Material	Wt. (lbs.)
L1883	3.63	4.75	3.00	3.20	Bolt-On	Yes	Polished	Stainless Steel	1
N1883	3.63	4.75	3.00	3.20	Bolt-On	No	Polished	Stainless Steel	1
L1980	3.63	4.75	3.00	3.20	Weld-On	Yes	Zinc Plated	Carbon Steel	1
N1980	3.63	4.75	3.00	3.20	Weld-On	No	Zinc Plated	Carbon Steel	1

Accessories:

Part No.	Description	Wt. (lbs.)
88CH545	Cylinder and Keys CH545 for L1883, L1980	0.16
CH545	Key Only for L1883, L1980	0.25

MINI TEAR DROP LATCH

- Locking and non-locking options available
- Mini size ideal for smaller applications



8000SSL Front



8000SSL Back

Part No.	Width (in.)	Height (in.)	Mount Width (in.)	Mount Height (in.)	Mount Type	Locking	Housing Finish	Housing Material	Wt. (lbs.)
8000SSL	3.25	4.38	3.06	2.87	Bolt-On	Yes	Polished	Stainless Steel	0.57
8000SSN	3.25	4.38	3.06	2.87	Bolt-On	No	Polished	Stainless Steel	0.55

Accessories:

Part No.	Description	Wt. (lbs.)
19CH545	Cylinder and Key for 8000SSL	0.09
CH510	Key Only for 8000SSL	0.02



LOCKING, DIE CAST COMPRESSION LATCH

- Strong, secure compression operation
- Latch is secure and stays shut with the adjustable cam action roller engagement
- Corrosion resistant powder-coated housing

SINGLE POINT



LL9000 Front

LL9000 Back

Part No.	Width (in.)	Height (in.)	Mount Width (in.)	Mount Height (in.)	Mount Type	Locking	Housing Finish	Housing Material	Wt. (lbs.)
LL9000	5.88	6.00	3.88	3.94	Stud	Yes	Powder Coat	Die Cast Steel	2.04

Accessories:

Part No.	Description	Wt. (lbs.)
88CH545	Cylinder and Key Set	0.12
CH545	Key Only	0.02
3036319	Gasket	0.13

3-POINT

- Equipped with mounting studs for 3-point rods
- Rods sold separately



LL90003 Front

LL90003 Back

Part No.	Width (in.)	Height (in.)	Mount Width (in.)	Mount Height (in.)	Mount Type	Locking	Housing Finish	Housing Material	Wt. (lbs.)
LL90003	5.88	6.00	3.88	3.94	Stud	Yes	Powder Coat	Die Cast Steel	2.38

Accessories:

Part No.	Description	Wt. (lbs.)
88CH545	Cylinder and Key Set	0.12
CH545	Key Only	0.02
3036319	Gasket	0.13

RODS FOR LL90003

- Sold as singles



3024136

Part No.	Description	Wt. (lbs.)
3024136	7.6 Inch Rod for Die Cast 3-Point Compression Latch on an 18 Inch Truck Box	0.15
3024137	10.60 Inch Rod for Die Cast 3-Point Compression Latch on a 24 Inch Truck Box	0.23
3024138	13.6 Inch Rod for Die Cast 3-Point Compression Latch on a 30 Inch Truck Box	0.25
3024139	16.6 Inch Rod for Die Cast 3-Point Compression Latch on a 36 Inch Truck Box	1.1
3030564	22.6 Inch Rod for Die Cast 3-Point Compression Latch on a 48 Inch Truck Box	0.48
3031368	28.6 Inch Rod for Die Cast 3-Point Compression Latch on a 60 Inch Truck Box	0.01



17062603 shown

Parts & Accessories

LOCKING ZINC-PLATED, MOUNTING HOLES

- Cam adjusts from 1-1/4 in. to 2 in. to accommodate varying door thicknesses
- Zinc plated steel construction



L8915 Front

L8915 Back

Part No.	Width (in.)	Height (in.)	Mount Width (in.)	Mount Height (in.)	Mount Type	Locking	Housing Finish	Housing Material	Wt. (lbs.)
L8915	4.75	4.88	3.88	3.95	Bolt-On	Yes	Zinc Plated	Carbon Steel	1.26

Accessories:

Part No.	Description	Wt.(lbs.)
88CH545	Cylinder and Key Set	0.12
CH545	Key Only	0.02
L8815G0	Gasket	0.13

LOCKING STAINLESS STEEL, MOUNTING HOLES

- Cam adjusts from 1-1/4 in. to 2 in. to accommodate varying door thicknesses (except 2-point)
- Polished stainless steel construction
- 4 mounting holes

SINGLE POINT



L8815 Front

L8815 Back

Part No.	Width (in.)	Height (in.)	Mount Width (in.)	Mount Height (in.)	Mount Type	Locking	Housing Finish	Housing Material	Wt. (lbs.)
L8815	4.75	4.88	3.88	3.31	Bolt-On	Yes	Polished	Stainless Steel	1.5

Accessories:

Part No.	Description	Wt.(lbs.)
88CH545	Cylinder and Key Set	0.12
CH545	Key Only	0.02
L8815G0	Gasket	0.13

2-POINT

- Includes Latch, 34 in. rods and rod guides



L8825 Front

L8825 Back

Part No.	Width (in.)	Height (in.)	Mount Width (in.)	Mount Height (in.)	Mount Type	Locking	Housing Finish	Housing Material	Wt. (lbs.)
L8825	4.75	4.88	3.88	3.25	Bolt-On	Yes	Polished	Stainless Steel	4.17

Accessories:

Part No.	Description	Wt.(lbs.)
88CH545	Cylinder and Key Set	0.12
CH545	Key Only	0.02
L8815G0	Gasket	0.13
L882501	Latch Only	1.40
L882502	34in. Rods	0.04



3-POINT

- Includes Latch, 34 in. rods and rod guides



L8835 Front

L8825 Back

Part No.	Width (in.)	Height (in.)	Mount Width (in.)	Mount Height (in.)	Mount Type	Locking	Housing Finish	Housing Material	Wt. (lbs.)
L8835	4.75	4.88	3.88	3.38	Bolt-On	Yes	Polished	Stainless Steel	4.59

Accessories:

Part No.	Description	Wt.(lbs.)
88CH545	Cylinder and Key Set	0.12
CH545	Key Only	0.02
L8815G0	Gasket	0.13
L883501	Latch Only	1.45
L882502	34in. Rods	0.04



LOCKING STAINLESS STEEL, BLIND STUDS

- Blind studs and included gasket make for a water-tight installation with no showing bolts
- Flush-mount
- Cam adjusts from 1-1/4 in. to 2 in. to accommodate varying door thicknesses

SINGLE POINT



Part No.	Width (in.)	Height (in.)	Mount Width (in.)	Mount Height (in.)	Mount Type	Locking	Housing Finish	Housing Material	Wt. (lbs.)
L8855	4.75	4.88	3.88	3.31	Stud	Yes	Polished	Stainless Steel	1.5

Accessories:

Part No.	Description	Wt. (lbs.)
88CH545	Cylinder and Key Set	0.12
CH545	Key Only	0.02
L8815G0	Gasket	0.13

SINGLE POINT, TALL PROFILE



Part No.	Width (in.)	Height (in.)	Mount Width (in.)	Mount Height (in.)	Mount Type	Locking	Housing Finish	Housing Material	Wt. (lbs.)
L8816	4.75	5.50	3.88	3.95	Stud	Yes	Polished	Stainless Steel	1.5

Accessories:

Part No.	Description	Wt. (lbs.)
88CH545	Cylinder and Key Set	0.12
CH545	Key Only	0.02
L881XG0	Gasket	0.13

SINGLE POINT, REPLACEMENT LATCH FOR POLY UNDERBODY TOOLBOXES

- Special rolling Cam, designed to work on Buyers Products polymer underbody truck boxes



Part No.	Width (in.)	Height (in.)	Mount Width (in.)	Mount Height (in.)	Mount Type	Locking	Housing Finish	Housing Material	Wt. (lbs.)
L8816R	4.75	5.50	3.88	3.95	Stud	Yes	Polished	Stainless Steel	1.43

Accessories:

Part No.	Description	Wt. (lbs.)
88CH545	Cylinder and Key Set	0.12
CH545	Key Only	0.02
L881XG0	Gasket	0.13

CYLINDERS AND KEYS



Part No.	Description	Wt. (lbs.)
19CH545	Cylinder and Key	.09
888CH510	Cylinder Lock with Two Keys	.13
39LL71	Cylinder and Key	.09
L38RLSCH545	Cylinder for L3885RLS Latch	.25
88CH545	Cylinder and Keys for L1980, L8815, L8816, L8816R, L8825, L8835, L8855, L8915, LL9000, and LL9003	.25

Accessories:

Part No.	Description	Wt. (lbs.)
CDC01Z	Zinc Plated, Die Cast, Cylinder Dust Cover for Use with 39LL71, 19CH545, L38RLSCH545, 88CH545, 88CH510	0.12

PUSH BUTTON LOCK AND KEY



Part No.	Description	Wt. (lbs.)
3019101	Push Button Lock with Key	0.68
3030481	Spare Key for Push Button Lock	0.03

Parts & Accessories

UNIVERSAL ALUMINUM CAM-ACTION LOCK KIT

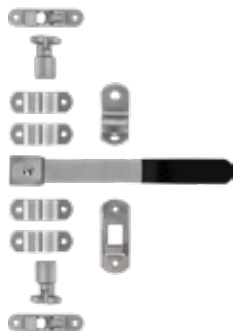

- Kit contains aluminum cams and keepers, rod guides, a plastic-coated handle, and a hasp that allows for the use of a personal padlock
- Aluminum pipe is not included.

Part No.	Description	Wt. (lbs.)
3052380	Universal Aluminum Cam-Action Lock Kit	3.31

HINGED SECURITY HASPS



SH35



SH36SS

- Hasp can be secured by adding lock (not included) in padlock eye.

Part No.	Material	Length (in)	Width (in)	Wt. (lb)
SH35	Zinc Plated Steel	3.5	1.5	0.19
SH36	Zinc Plated Steel	4.63	1.44	0.31
SH36SS	Stainless Steel	4.63	1.44	0.31

STAINLESS STEEL ADJUSTABLE DRAW LATCH



- Polished stainless steel
- Adjustable latch for use with combination lock or padlock (sold separately)
- Adjust the latching distance to compensate for gasket and panel misalignment
- Heavy-duty lever-action latch provides door-closing leverage for heavier gasketed door applications like toolboxes and other small compartment doors

Part No.	Description	Wt. (lb)
3049352	Stainless Steel Adjustable Draw Latch	.52

REPLACEMENT TRAY FOR 2020+ CROSSOVER TRUCK TOOL BOXES



1705181

- Oversized powder-coated steel tray with dividers
- 3 Dividers are removable for flexible storage
- For use with the newly redesigned crossover and gull wing tool boxes (page 50-51)

Part No.	Depth (in)	Width (in)	Wt. (lb)
3043331	15.375	18	7.64
3047140	15.375	25	10.56

GAS SHOCKS



3022729

- Dampened extension
- Undampened compression
- Black powder-coated cylinder

Part No.	Extended Length	Compressed Length	Stroke	Rod Diameter	Cylinder Diameter	Ball Socket Diameter	Force Rating (lbs.)	Wt. (lbs.)
3045502	17"	10"	7"	6mm	15mm	10mm	20	0.42
3045504	12"	8"	4"	6mm	15mm	10mm	25	0.27
3045506	12"	8"	4"	6mm	15mm	10mm	30	0.43
3045508	12"	8"	4"	6mm	15mm	10mm	40	0.27
3045512	12"	8"	4"	6mm	15mm	10mm	60	0.27
3045514	12"	8"	4"	6mm	15mm	10mm	80	0.42
3040770	17.10"	10.80"	6.30"	8mm	18mm	10mm	97	0.56
3023460	19.63"	11.63"	8"	9.98mm	21.59mm	10mm	250	0.85
3028786	13.93"	8.5"	5.5"	8mm	18mm	10mm	35	0.51
3008745	10mm Ball Stud (Sold Separately except for 3028786)							0.03
FNE031018034	Nylock Nut for Ball Stud (Sold Separately except for 3023460)							0.01



UNDERBODY REPLACEMENT PARTS

PART NO.	DOORS	LATCHES	LANYARDS
1702100	1702100DOOR	L3890RLS	3003081
1702103	1702103DOOR	L3890RLS	3003081
1702105	1702105DOOR	L3890RLS	3003081
1702110	1702110DOOR	L3890RLS	3003081
1702115	1702115DOOR	L3890RLS	3003081
1702200	1702200DOOR	L3890RLS	3003081
1702203	1702203DOOR	L3890RLS	3003081
1702205	1702205DOOR	L3890RLS	3003081
1702210	1702210DOOR	L3890RLS	3003081
1702215	1702215DOOR	L3890RLS	3003081
1702295	1702295DOOR	L8816	3003081
1702300	1702300DOOR	L8816	3003081
1702303	1702303DOOR	L8816	3003081
1702305	1702305DOOR	L8816	3003081
1702306	1702306DOOR	LL9003	-
1702310	1702310DOOR	L8816	3003081
1702311	1702311DOOR	LL9003	-
1702315	1702315DOOR	L8816	3003081
1702317	1702317DOOR	L8816	3003081
1702325	1702325DOOR	L8816	3003081
1702400	1702400DOOR	L8816	3003081
1702403	1702403DOOR	L8816	3003081
1702405	1702405DOOR	L8816	3003081
1702406	1702406DOOR	LL90003	-
1702410	1702410DOOR	L8816	3003081
1702411	1702411DOOR	LL90003	-
1702415	1702415DOOR	L8816	3003081
1702417	1702417DOOR	L8816	3003081
1702500	1702500DOOR	LL9000	3003081
1702503	1702503DOOR	LL9000	3003081
1702505	1702505DOOR	LL9000	3003081
1702510	1702510DOOR	LL9000	3003081
1702595	1702595DOOR	LL9000	3003081
1702600	1702600DOOR	LL9000	3003081
1702603	1702603DOOR	LL9000	3003081
1702605	1702605DOOR	LL9000	3003081
1702610	1702610DOOR	LL9000	3003081
1702650	1702650DOOR	LL9000	-
1702653	1702653DOOR	LL9000	-
1702655	1702655DOOR	LL9000	-
1702660	1702660DOOR	LL9000	-
1702700	1702700DOOR	LL9000	3003081
1702703	1702703DOOR	LL9000	3003081
1702705	1702705DOOR	LL9000	3003081
1702710	1702710DOOR	LL9000	3003081
1702715	1702715DOOR	LL9000	3003081
1702725	1702705DOOR	LL9000	3003081
1702900	1702900DOOR	L8816	3003081
1702905	1702905DOOR	L8816	3003081
1702910	1702910DOOR	L8816	3003081
1703100	1703100DOOR	L3890RLS	3003480
1703103	1703103DOOR	L3890RLS	3003480
1703150	1703150DOOR	L3890RLS	3003480
1703203	1703203DOOR	L3890RLS	3003480
1703205	1703205DOOR	L3890RLS	3003480
1703300	1703300DOOR	L8816	3003480
1703303	1703303DOOR	L8816	3003480
1703304	1703303DOOR	L8816	3003480
1703305	1703305DOOR	L8816	3003480
1703310	1703310DOOR	L8816	3003480
1703312	1703312DOOR	L8816	3003480
1703320	1703320DOOR	L8816	3003480
1703322	1703322DOOR	L8816	3003480
1703324	1703324DOOR	L8816	3003480
1703326	1703326DOOR	L8816	3003480
1703328	1703328DOOR	L8816	3004556
1703330	1703330DOOR	L8816	3003480
1703349	1703349DOOR	L8816	3003480
1703350	1703350DOOR	L8816	3003480
1703351	1703349DOOR	L8816	3003480
1703352	1703350DOOR	L8816	3003480
1703353	1703353DOOR	L8816R	3003480
1703355	1703303DOOR	L8816	3003480
1703400	1703400DOOR	L8816	3003480

PART NO.	DOORS	LATCHES	LANYARDS
1703403	1703403DOOR	L8816	3003480
1703404	1703403DOOR	L8816	3003480
1703405	1703405DOOR	L8816	3003480
1703495	1703495DOOR	L3890RLS	3003081
1703700	1703700DOOR	LL9000	3003480
1703703	1703703DOOR	LL9000	3003480
1703705	1703705DOOR	LL9000	3003480
1703900	1703900DOOR	L8816	3003480
1704300	1704300DOOR	L8816	3004713
1704303	1704303DOOR	L8816	3004713
1704305	1704305DOOR	L8816	3004713
1704310	1704310DOOR	L8816	3004713
1704315	1704315DOOR	L8816	3004713
1704400	1704400DOOR	L8816	3004713
1704403	1704403DOOR	L8816	3004713
1704405	1704405DOOR	L8816	3004713
1704410	1704410DOOR	L8816	3004713
1704415	1704415DOOR	L8816	3004713
1704600	3047158	LL9000	3004713
1704603	3047159	LL9000	3004713
1704610	3010773	LL9000	3004713
1704615	3047195	LL9000	3004713
1704705	1704705DOOR	LL9000	3004713
1704710	1704710DOOR	LL9000	3003081
1704715	1704715DOOR	LL9000	3003081
1705100	1705100DOOR	LL9000	3003081
1705101	1705101DOOR	LL9000	3003081
1705102	1705102DOOR	LL9000	3003081
1705103	1705103DOOR	LL9000	3003081
1705105	1705105DOOR	LL9000	3003081
1705110	1705110DOOR	LL9000	3003081
1705115	1705115DOOR	LL9000	3003081
1705118	1705118DOOR	LL9000	3024237
1705119	-	LL9000	3003081
1705120	1705110DOOR	LL9000	3003081
1705125	-	LL9000	3003081
1705130	1705130DOOR	LL9000	3004713
1705133	1705133DOOR	LL9000	3004713
1705135	1705135DOOR	LL9000	3004713
1705140	1705140DOOR	LL9000	3004713
1705145	1705145DOOR	LL9000	3004713
1705147	1705147DOOR	LL9000	3004713
1705148	1705148DOOR	LL9000	3003480
1705149	1705149DOOR	LL9000	3003480
1705150	1705150DOOR	LL9000	3003480
1705153	1705153DOOR	LL9000	3003480
1705160	1705160DOOR	LL9000	3003480
1706400	1706400DOOR	LL90003	3033784
1706403	1706403DOOR	LL90003	3033784
1706405	1706405DOOR	LL90003	3033784
1706410	1706410DOOR	LL90003	3033784
1706415	1706415DOOR	LL90003	3033784
1706420	1706420DOOR	LL90003	3033784
1706425	1706425DOOR	LL90003	3033784
1706430	1706430DOOR	LL90003	3033784
1706500	1706500DOOR	LL90003	3033784
1706503	1706503DOOR	LL90003	3033784
1706505	1706505DOOR	LL90003	3033784
1706510	1706510DOOR	LL90003	3033784
1706515	1706515DOOR	LL90003	3033784
1706520	1706505DOOR	LL90003	3033784
1706525	1706510DOOR	LL90003	3033784
1706530	1706515DOOR	LL90003	3033784
1706960	-	LL90003	3033784
1706963	-	LL90003	3033784
1706965	-	LL90003	3033784
1706970	-	LL90003	3033784
1706975	-	LL90003	3033784
1706980	-	LL90003	3033784
1706985	-	LL90003	3033784
1706990	-	LL90003	3033784
1707960	-	LL90003	3033784
1707963	-	LL90003	3033784
1707965	-	LL90003	3033784

PART NO.	DOORS	LATCHES	LANYARDS
1707970	-	LL90003	3033784
1707975	-	LL90003	3033784
1707980	-	LL90003	3033784
1707985	-	LL90003	3033784
1707990	-	LL90003	3033784
1708310	1708310DOOR	L8816	3003081
1708410	1702410DOOR	L8816	3003081
1712200	-	LL9000	3003081
1712205	-	LL9000	3003081
1712210	-	LL9000	3003081
1715100	1715100DOOR	LL9000	3003081
1715105	1715105DOOR	LL9000	3003081
1715110	1715110DOOR	LL9000	3003081
1715115	1715115DOOR	LL9000	3003081
1725100	1725100DOOR	LL9000	3003081
1725101	1725101DOOR	LL9000	3003081
1725102	1725102DOOR	LL9000	3003081
1725103	1725103DOOR	LL9000	3003081
1725105	1725105DOOR	LL9000	3003081
1725110	1725110DOOR	LL9000	3003081
1725115	1725115DOOR	LL9000	3003081
1725116	1725116DOOR	LL9000	3003081
1725118	1725118DOOR	LL9000	3024237
1725119	1725119DOOR	LL9000	3003081
1725120	1725120DOOR	LL9000	3003081
1725125	-	LL9000	3003081
1725130	1725130DOOR	LL9000	3004713
1725133	1725133DOOR	LL9000	3004713
1725135	1725135DOOR	LL9000	3004713
1725140	1725140DOOR	LL9000	3004713
1725145	1725145DOOR	LL9000	3004713
1725147	1725147DOOR	LL9000	3004713
1725148	1725148DOOR	LL9000	3003480
1725149	1725149DOOR	LL9000	3003480
1725150	1725150DOOR	LL9000	3003480
1725153	1725153DOOR	LL9000	3003081
1725160	1725160DOOR	LL9000	3003081
1732300	1732300DOOR	LL90003	3024237
1732303	1703203DOOR	L3890RLS	3003480
1732305	1732305DOOR	LL90003	3024237
1732310	1732310DOOR	LL90003	3024237
1732315	-	LL90003	3003081
1732400	1732400DOOR	LL90003	3024237
1732403	1732403DOOR	LL90003	3024237
1732405	1732405DOOR	LL90003	3024237
1732500	1732500DOOR	LL90003	3024237
1732503	1732503DOOR	LL90003	3024237
1732505	1732505DOOR	LL90003	3024237
1732510	1732510DOOR	LL90003	3024237
1734300	1734300DOOR	LL90003	3024238
1734303	1734303DOOR	LL90003	3024238
1734305	1734305DOOR	LL90003	3024238
1734400	1734400DOOR	LL90003	3024238
1734403	1734403DOOR	LL90003	3024238
1734405	1734405DOOR	LL90003	3024238
1734500	1734500DOOR	LL90003	3024238
1734503	1734503DOOR	LL90003	3024238
1734505	1734505DOOR	LL90003	3024238
1735100	1735100DOOR	LL90003	3003081
1735103	1735103DOOR	LL90003	3003081
1735105	1735105DOOR	LL90003	3003081
1735130	1735130DOOR	LL90003	3004713
1735133	1735133DOOR	LL90003	3004713
1735135	1735135DOOR	LL90003	3004713
1742300	1742300DOOR	LL9000	3030806
1742303	1742303DOOR	LL9000	3030806
1742305	1742305DOOR	LL9000	3030806
1742310	1742310DOOR	LL9000	3030806
1742315	1742303DOOR	LL9000	3030806
1742325	1742305DOOR	LL9000	3030806
1742335	1742335DOOR	LL9000	3030806
1742336	1742310DOOR	LL9000	3030806
1744300	1744300DOOR	LL9000	3041851
1744303	1744303DOOR	LL9000	3041851
1744305	1744305DOOR	LL9000	3041851

Replacement Parts

BARN DOOR REPLACEMENT PARTS

PART NO.	DOORS WITH LATCH	DOOR WITHOUT LATCH	LATCHES
1702225	1702225D0ORBWLCH	1702225D0ORBWLCH	LL9000
1702230	1702230D0ORBWLCH	1702230D0ORBWLCH	LL9000
1702235	1702235D0ORBWLCH	1702235D0ORBWLCH	LL90003
1702240	1702240D0ORBWLCH	1702240D0ORBWLCH	LL90003
1702250	1702250D0ORBWLCH	1702250D0ORBWLCH	LL90003
1705200	1705200D0ORBWLCH	1705200D0ORBWLCH	LL90003
1705201	1705201D0ORBWLCH	1705201D0ORBWLCH	LL90003
1705203	1705203D0ORBWLCH	1705203D0ORBWLCH	LL90003
1705205	1705205D0ORBWLCH	1705205D0ORBWLCH	LL90003
1705210	1705210D0ORBWLCH	1705210D0ORBWLCH	LL90003
1705215	1705215D0ORBWLCH	1705215D0ORBWLCH	LL90003
1705295	1705295D0ORBWLCH	1705295D0ORBWLCH	LL9000
1705300	1705300D0ORBWLCH	1705300D0ORBWLCH	LL9000
1705303	1705303D0ORBWLCH	1705303D0ORBWLCH	LL90003
1705305	1705305D0ORBWLCH	1705305D0ORBWLCH	LL90003
1705310	1705310D0ORBWLCH	1705310D0ORBWLCH	LL90003
1705315	1705315D0ORBWLCH	1705315D0ORBWLCH	LL90003
1705333	1705333D0ORBWLCH	1705333D0ORBWLCH	LL90003
1705335	1705335D0ORBWLCH	1705335D0ORBWLCH	LL90003
1705395	1705395D0ORBWLCH	1705395D0ORBWLCH	LL9000
1705340	1705340D0ORBWLCH	1705340D0ORBWLCH	LL90003
1705345	1705345D0ORBWLCH	1705345D0ORBWLCH	LL90003
1705350	1705350D0ORBWLCH	1705350D0ORBWLCH	LL90003
1705401	1705401D0ORBWLCH	1705401D0ORBWLCH	LL9000
1705403	1705403D0ORBWLCH	1705403D0ORBWLCH	LL9003
1705405	1705405D0ORBWLCH	1705405D0ORBWLCH	LL90003
1705410	1705410D0ORBWLCH	1705410D0ORBWLCH	LL90003

PART NO.	DOORS WITH LATCH	DOOR WITHOUT LATCH	LATCHES
1705415	1705415D0ORBWLCH	1705415D0ORBWLCH	LL90003
1705420	1705420D0ORBWLCH	1705420D0ORBWLCH	LL90003
1705425	1705425D0ORBWLCH	1705425D0ORBWLCH	LL90003
1705430	1705430D0ORBWLCH	1705430D0ORBWLCH	LL90003
1705431	1705431D0ORBWLCH	1705431D0ORBWLCH	LL9000
1705433	1705433D0ORBWLCH	1705433D0ORBWLCH	LL9003
1705435	1705435D0ORBWLCH	1705435D0ORBWLCH	LL90003
1705440	1705440D0ORBWLCH	1705440D0ORBWLCH	LL90003
1705445	1705445D0ORBWLCH	1705445D0ORBWLCH	LL90003
1705450	1705450D0ORBWLCH	1705450D0ORBWLCH	LL90003
1705795	1705795D0ORBWLCH	1705795D0ORBWLCH	LL9000
1705800	1705800D0ORBWLCH	1705800D0ORBWLCH	LL9000
1705825	1705825D0ORBWLCH	1705825D0ORBWLCH	LL9000
1705895	1705895D0ORBWLCH	1705895D0ORBWLCH	LL9000
1705900	1705900D0ORBWLCH	1705900D0ORBWLCH	LL9000
1705903	1705903D0ORBWLCH	1705903D0ORBWLCH	LL9003
1705931	1705931D0ORBWLCH	1705931D0ORBWLCH	LL9000
1705933	1705933D0ORBWLCH	1705933D0ORBWLCH	LL9000
1706795	1706795D0ORBWLCH	1706795D0ORBWLCH	LL9000
1706800	1706800D0ORBWLCH	1706800D0ORBWLCH	LL9000
1706825	1706825D0ORBWLCH	1706825D0ORBWLCH	LL9000
1706895	1706895D0ORBWLCH	1706895D0ORBWLCH	LL9000
1706900	1706900D0ORBWLCH	1706900D0ORBWLCH	LL9000
1706903	1706903D0ORBWLCH	1706903D0ORBWLCH	LL9003
1706931	1706931D0ORBWLCH	1706931D0ORBWLCH	LL9000
1706933	1706933D0ORBWLCH	1706933D0ORBWLCH	LL9003

CAM LOCK REPLACEMENT PARTS

ALUMINUM DOOR

PART NO.	ROD SIDE DOOR	HASP SIDE DOOR	CAMLOCK HARDWARE KIT
1762600	1762600D0ORROD	1762600D0ORHASP	3052380
1762603	1762603D0ORROD	1762603D0ORHASP	3052380
1762606	1762606D0ORROD	1762606D0ORHASP	3052380
1762609	1762609D0ORROD	1762609D0ORHASP	3052380
1762621	1762621D0ORROD	1762621D0ORHASP	3052380
1762624	1762624D0ORROD	1762624D0ORHASP	3052380
1762627	1762627D0ORROD	1762627D0ORHASP	3052380
1762630	1762630D0ORROD	1762630D0ORHASP	3052380
1762639	1762639D0ORROD	1762639D0ORHASP	3052380
1762642	1762642D0ORROD	1762642D0ORHASP	3052380
1762645	1762645D0ORROD	1762645D0ORHASP	3052380
1762648	1762648D0ORROD	1762648D0ORHASP	3052380

STAINLESS STEEL DOOR

PART NO.	ROD SIDE DOOR	HASP SIDE DOOR	CAMLOCK HARDWARE KIT
1763100	1763100D0ORROD	1763100D0ORHASP	3052380
1763103	1763103D0ORROD	1763103D0ORHASP	3052380
1763106	1763106D0ORROD	1763106D0ORHASP	3052380
1763121	1763121D0ORROD	1763121D0ORHASP	3052380
1763124	1763124D0ORROD	1763124D0ORHASP	3052380
1763127	1763127D0ORROD	1763127D0ORHASP	3052380
1763139	1763139D0ORROD	1763139D0ORHASP	3052380
1763142	1763142D0ORROD	1763142D0ORHASP	3052380
1763145	1763145D0ORROD	1763145D0ORHASP	3052380



Towing



Product Shown:
PH30: 30 Ton Pintle Hook
B5055: 1" Forged 55° Angled D-Ring
1809029: Fabricators Hitch Plate
TC1007P: 7-Way, Truck-SideTrailer Plug
B36SPP: Solid Black Rubber Mudflaps
8590245: Ribbed Poly Fenders
5626738: 5-3/4" Red Stop/Turn/Tail Light

Combination Hitches	70 - 71
Pintle Hooks	72 - 77
Pintle Hook Mounts	78
Ball Mounts	79 - 85
Hitch Balls	86
Hitch Pins	87
Hitch Plates	88 - 90
Receiver Hitches	91 - 94
Safety Chains	95 - 96
Receiver Tubes	97

Receiver Adapters	98 - 99
Gooseneck Hitch Accessories & King Pins	100
King Pins & Towing Hooks	101
Towing Hooks	102
Drawbars and Lunette Eyes	103 - 105
Couplers	106 - 109
Electrical Components for Towing	110 - 117
Trailer Jacks	118 - 120

Combination Hitches

RECEIVER MOUNT COMBINATION HITCHES

- Drop-forged with black powder-coat finish
- Individually boxed with capacity decals

6 TON COMBINATION HITCH FOR 2 INCH HITCH RECEIVERS

- Tow up to 12,000 lbs. with either ball hitch or pintle hook



RM62516



RM650M Box

Part No.	Ball Diameter (in.)	Drawbar Eye Inner Dia. (in.)	M.G.T.W. (lbs)	M.V.L. (lbs)	Wt. (lbs.)
RM62000	2	2.5-3.0	12,000	2,400	19.76
RM62516	2-5/16	2.5-3.0	12,000	2,400	20.38

Accessories:

Part No.	Description	Wt. (lbs.)
P11C	1/4 Inch Safety Pin with 8 Inch Chain	0.154
RB2000	2 Inch Replacement Ball With Nut For RM6 Series & BH8 Series	2.5
RB2516	2-5/16 Inch Replacement Ball With Nut For RM6 Series & BH8 Series	2.75
RB50MM	50 Millimeter Replacement Ball Without Nut For RM6 Series & BH8 Series	2.75
RB1780	1-7/8 Inch Replacement Ball With Nut For RM6 Series & BH8 Series	2.25

10 TON COMBINATION HITCH FOR 2-1/2 INCH HITCH RECEIVERS **NEW**

- Tow up to 20,000 lbs. with either ball hitch or pintle hook



RM102000



RM102000 Box

Part No.	Ball Diameter (in.)	Drawbar Eye Inner Dia. (in.)	M.G.T.W. (lbs)	M.V.L. (lbs)	Wt. (lbs.)
RM102000	2	2.5-3.0	20,000	3,600	28.1

Accessories:

Part No.	Description	Wt. (lbs.)
P11C	1/4 Inch Safety Pin with 8 Inch Chain	0.154

12 TON COMBINATION HITCH FOR 2-1/2 INCH HITCH RECEIVERS **NEW**

- Tow up to 24,000 lbs. with either ball hitch or pintle hook



RM122516



RM122516 Box

Part No.	Ball Diameter (in.)	Drawbar Eye Inner Dia. (in.)	M.G.T.W. (lbs)	M.V.L. (lbs)	Wt. (lbs.)
RM122516	2-5/16	2.5-3.0	24,000	3,600	28.5

Accessories:

Part No.	Description	Wt. (lbs.)
P11C	1/4 Inch Safety Pin with 8 Inch Chain	0.154



BOLT-ON COMBINATION HITCHES

- Drop-forged with black powder-coat finish
- Easily hooks up to a coupler or lunette eye
- Individually boxed with instruction sheet, drilling template, and capacity decals
- Retailed packaged models include instruction sheet, capacity decals, and mounting fasteners (nuts, bolts, and washers)

8 TON COMBINATION HITCH

- Tow up to 12,000 lbs. with ball hitch or 16,000 lbs. with pintle hook



BH82000



10045 Box

Part No.	Ball Diameter (in.)	Drawbar Eye Inner Dia. (in.)	M.G.T.W. (lbs)	M.V.L. (lbs)	Wt. (lbs.)
BH81780	1-7/8	2.5-3.0	12,000	3,000	13
10045	1-7/8	2.5-3.0	12,000	3,000	13.96
BH82000	2	2.5-3.0	12,000	3,000	13
10050	2	2.5-3.0	12,000	3,000	14.2
BH82516	2-5/16	2.5-3.0	16,000	3,000	13.5
10055	2-5/16	2.5-3.0	16,000	3,000	14.74
BH850MM	50 mm	2.5-3.0	16,000	3,000	12.93

Accessories:

Part No.	Description	Wt. (lbs.)
RB50MM	50 Millimeter Replacement Ball Without Nut For RM6 Series & BH8 Series	2.75
RB2516	2-5/16 Inch Replacement Ball With Nut For RM6 Series & BH8 Series	2.75
RB2000	2 Inch Replacement Ball With Nut For RM6 Series & BH8 Series	2.5
P11C	1/4 Inch Safety Pin with 8 Inch Chain	0.154
8520	Mounting Kit: (4) 1/2 in. x 2 in. Grade 8 cap screws, (4) 1/2 in. Grade 8 hex nuts, and (4) 1/2 in. heavy lock washers	0.73
RB1780	1-7/8 Inch Replacement Ball With Nut For RM6 Series & BH8 Series	2.25

10 TON COMBINATION HITCHES

- Tow up to 20,000 lbs. with either a ball hitch or pintle hook



10057



10052 Box

Part No.	Ball Diameter (in.)	Drawbar Eye Inner Dia. (in.)	M.G.T.W. (lbs)	M.V.L. (lbs)	Wt. (lbs.)
10052	2	2.38-3.0	20,000	4,000	20.3
10057	2-5/16	2.38-3.0	20,000	4,000	21

15 TON BOLT-ON COMBINATION HITCH **NEW**

- Tow up to 30,000 lbs. with either a ball hitch or pintle hook



BH152516



BH152516 Box

Part No.	Ball Diameter (in.)	Drawbar Eye Inner Dia. (in.)	M.G.T.W. (lbs)	M.V.L. (lbs)	Wt. (lbs.)
BH152516	2-5/16	2.38-3.0	30,000	4,000	19.7

Accessories:

Part No.	Description	Wt. (lbs.)
8525	Mounting Kit: (4) 9/16 in. x 2-1/2 in. Grade 8 cap screws, (4) 9/16 in. Grade 8 hex nuts, (4) 9/16 in. heavy lock washers and safety pin w/ chain	1.2

Pintle Hooks

RECEIVER MOUNT PINTLE HOOKS

- Drop-forged steel with black powder-coat finish
- Spring-loaded pintle hook lock arm provides a secure hold on 2 in. to 3 in. I.D. lunette eyes
- Easily hooks up to lunette eye/drawbar eye
- Retail packaged models include instruction sheet and capacity decals

5 TON PINTLE HOOK FOR 2 INCH HITCH RECEIVERS



RM5P



RM5P Box

Part No.	Drawbar Eye Inner Dia. (in.)	M.G.T.W. (lbs)	M.V.L. (lbs)	Wt. (lbs.)
 RM5P	2.0-3.0	10,000	2,000	14.22

Accessories:

Part No.	Description	Wt. (lbs.)
P11C	1/4 Inch Safety Pin with 8 Inch Chain	0.154

12 TON PINTLE HOOK FOR 2-1/2 INCH HITCH RECEIVERS **NEW**



RM12P



RM12P Box

Part No.	Drawbar Eye Inner Dia. (in.)	M.G.T.W. (lbs)	M.V.L. (lbs)	Wt. (lbs.)
 RM12P	2.0-3.0	24,000	3,600	19.80

Accessories:

Part No.	Description	Wt. (lbs.)
P11C	1/4 Inch Safety Pin with 8 Inch Chain	0.154

BOLT-ON PINTLE HOOKS

- Black powder coat finish
- Easy-to-use latch and drop forged steel lower jaw
- Individually boxed with instruction sheet, drilling template, and capacity decals
- Retail packaged models include instruction sheet, capacity decals, and mounting fasteners (nuts, bolts, and washers)

6 TON PINTLE HOOK **NEW**



PH6



10036 Box

Part No.	Drawbar Eye Inner Dia. (in.)	M.G.T.W. (lbs)	M.V.L. (lbs)	Wt. (lbs.)
PH6	2.0-3.0	12,000	2,400	11.345
 10036	2.0-3.0	12,000	2,400	12

Accessories:

Part No.	Description	Wt. (lbs.)
8520	Mounting Kit: (4) 1/2 in. x 2 in. Grade 8 cap screws, (4) 1/2 in. Grade 8 hex nuts, and (4) 1/2 in. heavy lock washers	0.73
P11C	1/4 Inch Safety Pin with 8 Inch Chain	0.154

10 TON PINTLE HOOK



PH10



10039 Box

Part No.	Drawbar Eye Inner Dia. (in.)	M.G.T.W. (lbs)	M.V.L. (lbs)	Wt. (lbs.)
PH10	2.0-3.0	20,000	4,000	11.345
 10039	2.0-3.0	20,000	4,000	11.345

Accessories:

Part No.	Description	Wt. (lbs.)
8520	Mounting Kit: (4) 1/2 in. x 2 in. Grade 8 cap screws, (4) 1/2 in. Grade 8 hex nuts, and (4) 1/2 in. heavy lock washers	0.73
P11C	1/4 Inch Safety Pin with 8 Inch Chain	0.154



BOLT-ON PINTLE HOOKS - continued

15 TON PINTLE HOOK



PH15



10040 Box

Part No.	Drawbar Eye Inner Dia. (in.)	M.G.T.W. (lbs)	M.V.L. (lbs)	Wt. (lbs.)
PH15	2.0-3.0	30,000	6,000	11
 10040	2.0-3.0	30,000	6,000	11.36

Accessories:

Part No.	Description	Wt. (lbs.)
8520	Mounting Kit: (4) 1/2 in. x 2 in. Grade 8 cap screws, (4) 1/2 in. Grade 8 hex nuts, and (4) 1/2 in. heavy lock washers	0.73
P11C	1/4 Inch Safety Pin with 8 Inch Chain	0.154

20 TON PINTLE HOOK



PH20



10042 Box

Part No.	Drawbar Eye Inner Dia. (in.)	M.G.T.W. (lbs)	M.V.L. (lbs)	Wt. (lbs.)
PH20	2.0-3.0	40,000	8,000	13.16
 10042	2.0-3.0	40,000	8,000	14.24

Accessories:

Part No.	Description	Wt. (lbs.)
8525	Mounting Kit: (4) 9/16 in. x 2-1/2 in. Grade 8 cap screws, (4) 9/16 in. Grade 8 hex nuts, (4) 9/16 in. heavy lock washers and safety pin w/ chain	1.2
P11C	1/4 Inch Safety Pin with 8 Inch Chain	0.154

30 TON PINTLE HOOK



PH30



10044 Box

Part No.	Drawbar Eye Inner Dia. (in.)	M.G.T.W. (lbs)	M.V.L. (lbs)	Wt. (lbs.)
PH30	2.38-3.00	60,000	15,000	24
 10044	2.38-3.00	60,000	15,000	26

Accessories:

Part No.	Description	Wt. (lbs.)
8530	Mounting Kit: (4) 3/4 in. x 3-1/2 in. Grade 8 cap screws, (4) 3/4 in. Grade 8 hex nuts, and (4) 3/4 in. heavy lock washers	2.8
3003316	3/8 Inch Safety Pin with 8 Inch Chain	0.23

45 TON PINTLE HOOK

- Mounting hardware sold separately



PH45

Part No.	Drawbar Eye Inner Dia. (in.)	M.G.T.W. (lbs)	M.V.L. (lbs)	Wt. (lbs.)
PH45	2.38-3.00	90,000	18,000	23

Accessories:

Part No.	Description	Wt. (lbs.)
0070055	Pawl Lock Clip for PH45	0.154
8530	Mounting Kit: (4) 3/4 in. x 3-1/2 in. Grade 8 cap screws, (4) 3/4 in. Grade 8 hex nuts, and (4) 3/4 in. heavy lock washers	2.8

Pintle Hooks

AIR COMPENSATED PINTLE HOOKS

- Black powder-coat finish for corrosion resistance
- Interlocking system that prevents the jaw from opening when the plunger is activated with air pressure
- Reduces wear and tear on towing parts by reducing slack and movement

45 TON AIR COMPENSATED PINTLE HOOK, 4-BOLT

- **Must be used with a brake chamber**
- Kit includes pintle hook with plunger, air chamber, and bracket



Part No.	Includes	Drawbar Eye Inner Dia. (in.)	M.G.T.W. (lbs)	M.V.L. (lbs)	Wt. (lbs.)
P45AC4	Pintle Hook Only	2.38-3.00	90,000	18,000	26
P45AC4K	Pintle Hook, Brake Chamber & Bracket	2.38-3.00	90,000	18,000	38.4

Accessories:

Part No.	Description	Wt.(lbs.)
8530	Mounting Kit: (4) 3/4 in. x 3-1/2 in. Grade 8 cap screws, (4) 3/4 in. Grade 8 hex nuts, and (4) 3/4 in. heavy lock washers	2.8

BRAKE CHAMBER MOUNT KIT FOR P45AC4



Part No.	For Use With	Wt. (lbs.)
P45AC4MK	Brake Chamber Mount Kit for P45AC4 45 Ton Air Compensated Pintle Hook	13.5

Accessories:

Part No.	Description	Wt.(lbs.)
P45AC4BK	45 Ton 4-Hole Air Compensated Pintle Hook Brake Chamber Bracket	3.2
BC45T24	Type 24 Brake Chamber with 9-1/2 in. Rod and (2) Nuts	9.2

45 TON AIR COMPENSATED PINTLE HOOK, 6-BOLT

- **Must be used with a brake chamber**
- Kit includes pintle hook with plunger, air chamber, and bracket
- Requires (2) mounting hardware kits



Part No.	Includes	Drawbar Eye Inner Dia. (in.)	M.G.T.W. (lbs)	M.V.L. (lbs)	Wt. (lbs.)
P45AC6	Pintle Hook Only	2.38-3.00	90,000	18,000	29.6
P45AC6K	Pintle Hook, Brake Chamber & Bracket	2.38-3.00	90,000	18,000	42

Accessories:

Part No.	Description	Wt.(lbs.)
8530	Mounting Kit: (4) 3/4 in. x 3-1/2 in. Grade 8 cap screws, (4) 3/4 in. Grade 8 hex nuts, and (4) 3/4 in. heavy lock washers	2.8

BRAKE CHAMBER MOUNT KIT FOR P45AC6



Part No.	For Use With	Wt. (lbs.)
P45AC6MK	Brake Chamber Mount Kit for P45AC6 45 Ton Air Compensated Pintle Hook	13.67

Accessories:

Part No.	Description	Wt.(lbs.)
P45AC6BK	45 Ton 6-Hole Air Compensated Pintle Hook Brake Chamber Bracket	3.2
BC45T24	Type 24 Brake Chamber with 9-1/2 in. Rod and (2) Nuts	9.2



AIR COMPENSATED PINTLE HOOKS - continued

50 TON AIR COMPENSATED PINTLE HOOK, 6 BOLT

- Can be utilized with or without the air chamber and plunger
- Kit includes pintle hook with plunger, air chamber, and bracket
- Requires (2) mounting hardware kits
- PH50 compares to: Wallace® PH-R50T-6 & Holland® PH410



Part No.	Includes	Drawbar Eye Inner Dia. (in.)	M.G.T.W. (lbs)	M.V.L. (lbs)	Wt. (lbs.)
PH50	Pintle Hook Only	2.38-3.00	100,000	20,000	28.9
PH50AC	Pintle Hook, Plunger, Brake Chamber & Bracket	2.38-3.00	100,000	20,000	44.8

Accessories:

Part No.	Description	Wt.(lbs.)
3015655	Safety Pin, 5/16 in. Zinc Plated	0.16
8530	Mounting Kit: (4) 3/4 in. x 3-1/2 in. Grade 8 cap screws, (4) 3/4 in. Grade 8 hex nuts, and (4) 3/4 in. heavy lock washers	2.8

50 TON AIR COMPENSATED PINTLE HOOK, 10 BOLT

- Can be utilized with or without the air chamber and plunger
- Kit includes pintle hook, plunger, brake chamber, and bracket
- Requires (3) mounting hardware kits
- PH50 compares to: Wallace® R-50-10 & Holland® PH400



Part No.	Includes	Drawbar Eye Inner Dia. (in.)	M.G.T.W. (lbs)	M.V.L. (lbs)	Wt. (lbs.)
PH55	Pintle Hook Only	2.38-3.00	100,000	20,000	38.6
PH55AC	Pintle Hook, Plunger, Brake Chamber & Bracket	2.38-3.00	100,000	20,000	54.5

Accessories:

Part No.	Description	Wt.(lbs.)
3015655	Safety Pin, 5/16 in. Zinc Plated	0.16
8530	Mounting Kit: (4) 3/4 in. x 3-1/2 in. Grade 8 cap screws, (4) 3/4 in. Grade 8 hex nuts, and (4) 3/4 in. heavy lock washers	2.8

BRAKE CHAMBER MOUNT KIT FOR 50 TON AIR COMPENSATED PINTLE HOOKS

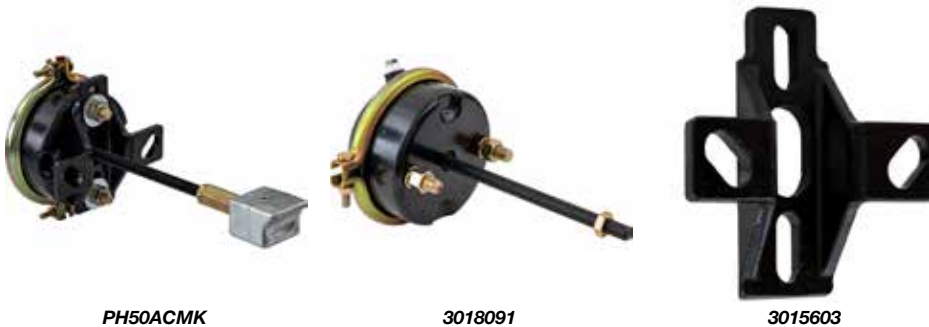

Part No.	For Use With	Wt. (lbs.)
PH50ACMK	Brake Chamber Mount Kit for PH50 and PH55 50 Ton Air Compensated Pintle Hooks	15.9

Accessories:

Part No.	Description	Wt.(lbs.)
3018091	Type 24 Brake Chamber with 9-1/2 in. Rod and (1) Nut	9
3015603	50 Ton 4-Hole Air Compensated Pintle Hook Brake Chamber Bracket	3.34

Pintle Hooks

SWIVEL-TYPE PINTLE HOOKS

- Forged steel construction
- Swivel action provides torsional relief of the coupling and the spring
- Recommended for off-road applications (capacities reduced by 25%)
- Easily accessible grease fitting
- Pintle hooks are individually boxed and include mounting information, spec. sheet, drilling template & vehicle capacity decal

15 TON SWIVEL TYPE PINTLE HOOK

- *BP100A compares to: Holland® PH-T-100A*



BP100A

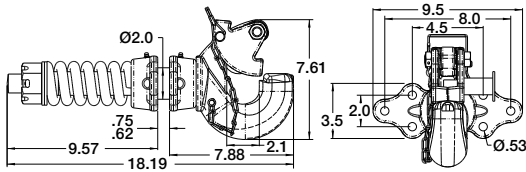

BP100A Drawing

Part No.	Drawbar Eye Inner Dia. (in.)	M.G.T.W. (lbs)	M.V.L. (lbs)	Wt. (lbs.)
BP100A	2.38-3.00	30,000	6,000	37

Accessories:

Part No.	Description	Wt. (lbs.)
8620	Mounting Kit: (6) 1/2 in. x 2-1/2 in. Grade 8 cap screws, (6) 1/2 in. Grade 8 hex nuts, and (6) 1/2 in. heavy lock washers	1.3
3003316	3/8 Inch Safety Pin with 8 Inch Chain	0.23

15 TON SWIVEL TYPE PINTLE HOOK WITH T-BRACKET

- *BP100A compares to: Holland® PH-T-125A*



BP125A

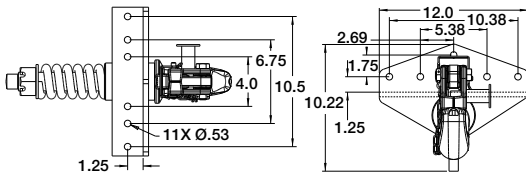

BP125A Drawing

Part No.	Drawbar Eye Inner Dia. (in.)	M.G.T.W. (lbs)	M.V.L. (lbs)	Wt. (lbs.)
BP125A	2.38-3.00	30,000	6,000	49.64

Accessories:

Part No.	Description	Wt. (lbs.)
8620	Mounting Kit: (6) 1/2 in. x 2-1/2 in. Grade 8 cap screws, (6) 1/2 in. Grade 8 hex nuts, and (6) 1/2 in. heavy lock washers	1.3
3003316	3/8 Inch Safety Pin with 8 Inch Chain	0.23

25 TON SWIVEL TYPE PINTLE HOOK

- *BP200 compares to: Wallace® 25-TON*



BP200

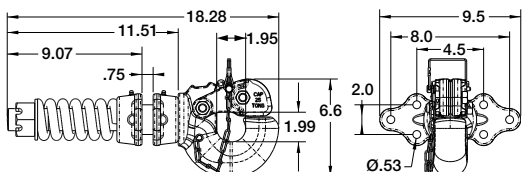

BP200 Drawing

Part No.	Drawbar Eye Inner Dia. (in.)	M.G.T.W. (lbs)	M.V.L. (lbs)	Wt. (lbs.)
BP200	2.38-3.00	50,000	6,000	37.9

Accessories:

Part No.	Description	Wt. (lbs.)
8620	Mounting Kit: (6) 1/2 in. x 2-1/2 in. Grade 8 cap screws, (6) 1/2 in. Grade 8 hex nuts, and (6) 1/2 in. heavy lock washers	1.3
3002478	1/4 Inch Safety Pin with 8 Inch Chain	0.15



SWIVEL-TYPE PINTLE HOOKS - continued

25 TON SWIVEL TYPE PINTLE HOOK WITH T-BRACKET

- BP225 compares to: Wallace® 25-TON



BP225

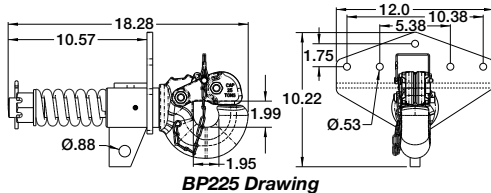

BP225 Drawing

Part No.	Drawbar Eye Inner Dia. (in.)	M.G.T.W. (lbs)	M.V.L. (lbs)	Wt. (lbs.)
BP225	2.38-3.00	50,000	6,000	47

Accessories:

Part No.	Description	Wt. (lbs.)
8620	Mounting Kit: (6) 1/2 in. x 2-1/2 in. Grade 8 cap screws, (6) 1/2 in. Grade 8 hex nuts, and (6) 1/2 in. heavy lock washers	1.3
3002478	1/4 Inch Safety Pin with 8 Inch Chain	0.15

30 TON HEAVY DUTY SWIVEL TYPE PINTLE HOOK



BP760A

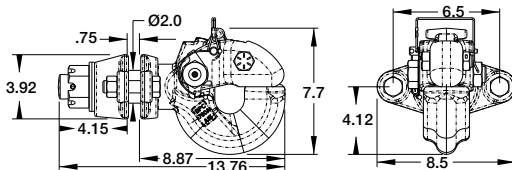

BP760A Drawing

Part No.	Drawbar Eye Inner Dia. (in.)	M.G.T.W. (lbs)	M.V.L. (lbs)	Wt. (lbs.)
BP760A	3.0	60,000	12,000	38.25

Accessories:

Part No.	Description	Wt. (lbs.)
3006875	1/4 Inch Safety Pin with Lanyard	0.154

50 TON HEAVY DUTY SWIVEL TYPE PINTLE HOOK

- Meets military towing specs
- BP880 compares to: Holland® PH-775SL11 & PH-775-01552; Wallace® B50 (2051108)



BP880

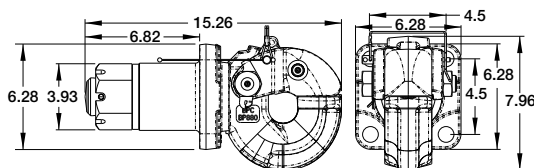

BP880 Drawing

Part No.	Drawbar Eye Inner Dia. (in.)	M.G.T.W. (lbs)	M.V.L. (lbs)	Wt. (lbs.)
BP880	3.0	100,000	20,000	62

Accessories:

Part No.	Description	Wt. (lbs.)
3017021	Safety Pin, 1/4 in. Zinc Plated	0.154

Pintle Hooks Mounts

2, 2-1/2 & 3 INCH PINTLE HOOK MOUNTS

- Black powder coat finish
- High & low positioning
- Accepts PH6, PH10, PH15, BH8 or similar pintle hooks
- Welded support bracket

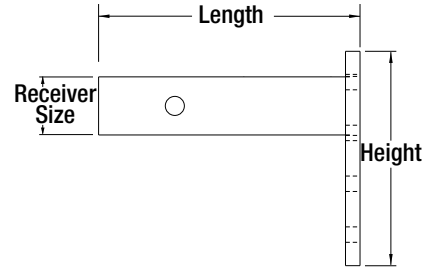

2 INCH



2-1/2 INCH



3 INCH **NEW**



Part No.	Shank Type	Receiver Size (in.)	Height (in.)	Length (in.)	Finish	Pairs of Holes	M.G.T.W. (lbs)	M.V.L. (lbs)	Wt. (lbs.)
PM84	Solid Shank	2.0	3.75	9.0	Powder-Coat	2	20,000	4,000	12
PM87	Solid Shank	2.0	7.38	9.0	Powder-Coat	4	14,000	2,800	15
10033	Solid Shank	2.0	7.38	9.0	Powder-Coat	4	14,000	2,800	15
PM90	Solid Shank	2.0	7.25	8.94	Powder-Coat	4	17,000	3,400	15.7
PM105	Solid Shank	2.0	5.75	10.0	Powder-Coat	3	15,000	3,000	16
PM107	Solid Shank	2.0	7.38	10.0	Powder-Coat	4	13,000	2,600	17
PM812	Solid Shank	2.0	12.50	12.25	Powder-Coat	7	10,000	2,000	24
10032	Solid Shank	2.0	12.50	12.25	Powder-Coat	7	10,000	2,000	24
PM1012	Solid Shank	2.0	12.50	14.0	Powder-Coat	7	10,000	2,000	26
PM25612	Tubular Shank	2.5	6.13	12.0	Powder-Coat	3	16,000	3,200	12.28
PM25812	Solid Shank	2.5	7.14	9.5	Powder-Coat	4	20,000	3,000	18.77
PM3109	Solid Shank	3	9	12	Powder-Coat	5	30,000	6,000	30



FIXED BALL MOUNTS

- Black powder-coat finish

BALL MOUNT KITS FOR 2 INCH RECEIVERS

- Corrosion-resistant black powder coat finish
- Pre-packaged kits are retail-display ready; kit includes ball mount assembled with ball and hitch pin
- Sold in 3-packs only



1803307

Part No.	Ball Diameter	Maximum Drop (in.)	Maximum Rise (in.)	Length (in.)	M.G.T.W. (lbs)	M.V.L. (lbs)	Wt. (lbs.)
1803306	2	2.00	0.75	8.00	6,000	600	10
1803307	2	2.00	0.75	8.00	6,000	600	8.81
1803308	2-5/16	2.00	0.75	8.00	7,500	750	10
1803312	1-7/8	4.00	2.75	8.00	5,000	600	12
1803313	2	4.00	2.75	8.00	6,000	600	9.77
1803314	2-5/16	4.00	2.75	8.00	7,500	750	10.45
1803318	2	2.00	0.75	10.00	7,500	750	9.51
1803319	2	4.00	2.75	10.00	7,500	750	10.51

2 INCH BALL MOUNTS

- Two-piece welded steel construction
- Tongue accepts 1 in. diameter shank towing ball



1803005

Part No.	For Ball Shank Size (in.)	Maximum Drop (in.)	Maximum Rise (in.)	Length (in.)	M.G.T.W. (lbs)	M.V.L. (lbs)	Wt. (lbs.)
1803005	1.00	2.00	0.75	8.00	7,500	750	5.59
1803007	1.00	2.00	0.75	10.00	7,500	750	7.71
1803010	1.00	4.00	2.75	8.00	7,500	750	7.47

2 INCH HIGH-LOW SHANK BALL MOUNTS

- Two-piece welded steel construction
- Tongue accepts 1 in. diameter shank towing balls



1803013

Part No.	For Ball Shank Size (in.)	Maximum Drop (in.)	Maximum Rise (in.)	Length (in.)	M.G.T.W. (lbs)	M.V.L. (lbs)	Wt. (lbs.)
1803013	1.00	4.00	2.75	10.00	7,500	750	7
1803015	1.00	6.00	4.75	10.00	7,500	750	9.9
1803017	1.00	8.00	6.75	10.00	7,500	750	12.07

2-1/2 INCH BALL MOUNTS

- Two-piece welded steel construction
- Tongue accepts 1.25 in. diameter shank towing balls



1803405

Part No.	For Ball Shank Size (in.)	Maximum Drop (in.)	Maximum Rise (in.)	Length (in.)	M.G.T.W. (lbs)	M.V.L. (lbs)	Wt. (lbs.)
1803405	1.25	3.00	1.50	10.00	15,000	1,500	11.85
1803410	1.25	5.00	3.50	10.00	15,000	1,500	14.5
1803415	1.25	7.75	6.25	10.00	15,000	1,500	17.52

Ball Mounts

FIXED BALL MOUNTS - continued

- Black powder-coat finish

2 INCH FORGED BALL MOUNTS

- One-piece, forged steel construction



1803055

Part No.	For Ball Shank Size (in.)	Maximum Drop (in.)	Maximum Rise (in.)	Length (in.)	M.G.T.W. (lbs)	M.V.L. (lbs)	Wt. (lbs.)
1803050	1.00	2.00	0.75	7.63	20,000	2,000	12
1803051	1.25	2.00	0.75	7.63	20,000	2,000	11.4
1803055	1.00	4.00	2.75	7.88	20,000	2,000	12.8
1803056	1.25	4.00	2.75	7.88	20,000	2,000	12.7
1803058	1.00	6.00	4.75	9.37	17,000	1,700	16
1803059	1.25	6.00	4.75	9.37	17,000	1,700	16

2-1/2 INCH FORGED BALL MOUNTS

- One-piece, forged steel construction



1803076

Part No.	For Ball Shank Size (in.)	Maximum Drop (in.)	Maximum Rise (in.)	Length (in.)	M.G.T.W. (lbs)	M.V.L. (lbs)	Wt. (lbs.)
1803075	1.25	2.00	0.5	8.50	20,000	2,700	16.16
1803076	1.25	4.00	2.5	8.50	20,000	2,700	16.95

3 INCH FORGED BALL MOUNTS **NEW**

- One-piece, forged steel construction



1803454

Part No.	For Ball Shank Size (in.)	Maximum Drop (in.)	Maximum Rise (in.)	Length (in.)	M.G.T.W. (lbs)	M.V.L. (lbs)	Wt. (lbs.)
1803454	1.25	4	2.5	9	21,000	2,100	22.5
1803456	1.25	6	4.75	10	21,000	2,100	25.5
1803458	1.25	8	6.75	10.5	21,000	2,100	28.75



CLEVIS MOUNTS

- Black powder-coat finish for corrosion resistance
- Accepts either a 1 in. diameter tow ball with a 1 in. shank length or a clevis/drop pin for towing flexibility (not included)
- Fits a standard 2 in. receiver tube
- 5/8 in. hitch pin hole

2 INCH CLEVIS BALL MOUNTS FOR 2 INCH HITCH RECEIVER



1803060

Part No.	Shank Size (in.)	Length (in.)	M.G.T.W. (lbs)	M.V.L. (lbs)	Wt. (lbs.)
1803060	2.00	9.25	6,000	600	11.9
1803065	2.00	9.25	8,000	800	17.4

Accessories:

Part No.	Description	Wt. (lbs.)
66127	Steel Hitch Pin w/Blue Poly-Coated Handle - 1 x 4-1/2 Inch Usable Length	1.7

ADJUSTABLE BALL MOUNTS

ADJUSTABLE BALL MOUNT FOR 2 INCH HITCH RECEIVERS, TUBULAR SHANK

- Black powder-coat finished for corrosion resistance
- Welded steel construction with tubular shank
- 4 positions for a wide range of trailer heights in a drop or rise position
- Tool free adjustment



1803090

Part No.	For Ball Shank Size (in.)	Maximum Drop (in.)	Maximum Rise (in.)	Length (in.)	M.G.T.W. (lbs)	M.V.L. (lbs)	Wt. (lbs.)
1803090	1.00	11.00	9.75	12.90	6,000	600	16.8

ADJUSTABLE BALL MOUNT FOR 2 INCH HITCH RECEIVERS, SOLID SHANK

- Black powder-coat finished for corrosion resistance
- Welded steel construction with solid shank
- 4 positions for a wide range of trailer heights in a drop or rise position
- Tool free adjustment



1803095

Part No.	For Ball Shank Size (in.)	Maximum Drop (in.)	Maximum Rise (in.)	Length (in.)	M.G.T.W. (lbs)	M.V.L. (lbs)	Wt. (lbs.)
1803095	1.00	11.00	9.75	12.90	10,000	1,000	32

Ball Mounts

MULTI-BALL MOUNTS

- Black powder-coat finish for corrosion resistance
- Easily swap between different towing balls

TRI-BALL HITCH FOR 2 INCH HITCH RECEIVERS

- Available with patented tubular steel shank or a solid steel shank design



1802200



1802200 Box

Part No.	Shank Type	Ball Finish	Ball Dia. (in.)	M.G.T.W. (lbs)	M.G.T.W. (lbs)	M.G.T.W. (lbs)	Wt. (lbs.)
				1-7/8" Ball	2" Ball	2-5/16" Ball	
1802200	Solid	Powder-Coat	1-7/8, 2, 2-5/16	6,000	7,500	10,000	19.5
1802202	Tubular	Powder-Coat	1-7/8, 2, 2-5/16	6,000	7,500	10,000	11.9
1802205	Solid	Chrome	1-7/8, 2, 2-5/16	6,000	7,500	10,000	19.5
1802207	Tubular	Chrome	1-7/8, 2, 2-5/16	6,000	7,500	10,000	11.9

TRI-BALL HITCH FOR 2-1/2 INCH HITCH RECEIVERS **NEW**

- Patented tubular steel shank



1802250



1802250 Box

Part No.	Shank Type	Ball Finish	Ball Dia. (in.)	M.G.T.W. (lbs)	M.G.T.W. (lbs)	M.G.T.W. (lbs)	Wt. (lbs.)
				1-7/8" Ball	2" Ball	2-5/16" Ball	
1802250	Tubular	Powder-Coat	1-7/8, 2, 2-5/16	6,000	10,000	14,000	16.1

TRI-BALL HITCH WITH CHROME TOWING BALLS FOR 2-1/2 INCH HITCH RECEIVERS **NEW**

- Patented tubular steel shank



1802252



1802252 Box

Part No.	Shank Type	Ball Finish	Ball Dia. (in.)	M.G.T.W. (lbs)	M.G.T.W. (lbs)	M.G.T.W. (lbs)	Wt. (lbs.)
				1-7/8" Ball	2" Ball	2-5/16" Ball	
1802252	Tubular	Chrome	1-7/8, 2, 2-5/16	6,000	10,000	14,000	16.1

TRI-BALL HITCH WITH RECOVERY HOOK FOR 2 INCH HITCH RECEIVERS

- Patented tubular steel shank



1802208



1802208 Box

Part No.	Shank Type	Ball Finish	Ball Dia. (in.)	M.G.T.W. (lbs)	M.G.T.W. (lbs)	M.G.T.W. (lbs)	Wt. (lbs.)
				1-7/8" Ball	2" Ball	2-5/16" Ball	
1802208	Tubular	Powder-Coat	1-7/8, 2, 2-5/16	6,000	7,500	10,000	13.4



MULTI-BALL MOUNTS - continued

- Black powder-coat finish for corrosion resistance
- Easily swap between different towing balls

TRI-BALL HITCH WITH PINTLE HOOK FOR 2 INCH HITCH RECEIVERS



1802279



1802279 Box

Part No.	Shank Type	Ball Finish	Ball Dia. (in.)	M.G.T.W. (lbs) 1-7/8" Ball	M.G.T.W. (lbs) 2" Ball	M.G.T.W. (lbs) 2-5/16" Ball	Wt. (lbs.)
 1802279	Solid	Chrome	1-7/8, 2, 2-5/16	6,000	7,500	10,000	24

TRI-BALL HITCH WITH PINTLE HOOK FOR 2-1/2 INCH HITCH RECEIVERS **NEW**



1802280



1802280 Box

Part No.	Shank Type	Ball Finish	Ball Dia. (in.)	M.G.T.W. (lbs) 1-7/8" Ball	M.G.T.W. (lbs) 2" Ball	M.G.T.W. (lbs) 2-5/16" Ball	Wt. (lbs.)
 1802280	Tubular	Chrome	1-7/8, 2, 2-5/16	6,000	10,000	14,000	21.8

DUAL BALL HITCH FOR 2 INCH HITCH RECEIVERS



1802215

Part No.	Shank Type	Ball Finish	Ball Dia. (in.)	M.G.T.W. (lbs) 2" Ball	M.G.T.W. (lbs) 2-5/16" Ball	Wt. (lbs.)
1802215	Solid	Powder-Coat	2, 2-5/16	7,500	10,000	18

DUAL BALL HITCH

- 2 in. Maximum drop



1803210

Part No.	Shank Type	Ball Finish	Ball Dia. (in.)	M.G.T.W. (lbs) 1-7/8" Ball	M.G.T.W. (lbs) 2" Ball	M.G.T.W. (lbs) 2-5/16" Ball	M.V.L. (lbs)	Wt. (lbs.)
1803210	Tubular	Powder-Coat	1-7/8, 2	6,000	6,000	-	600	7.75
1803215	Tubular	Powder-Coat	2, 2-5/16	-	6,000	6,000	600	10.95

Ball Mounts

ADJUSTABLE MULTI-BALL MOUNTS

- Black powder-coat finish for corrosion resistance
- Easily swap between different towing balls
- Tool-free ball and height adjustment

ADJUSTABLE TRI-BALL HITCH FOR 2 INCH HITCH RECEIVER

- 6 in. Maximum drop
- 6 in. Maximum rise



1802225



1802225 Box

Part No.	Shank Type	Ball Finish	Ball Dia. (in.)	M.G.T.W. (lbs) 1-7/8" Ball	M.G.T.W. (lbs) 2" Ball	M.G.T.W. (lbs) 2-5/16" Ball	Wt. (lbs.)
1802225	Solid	Chrome	1-7/8, 2, 2-5/16	6,000	7,500	10,000	44

Accessories:

Part No.	Description	Wt.(lbs.)
3020620	Replacement Chrome Tri-Ball	8.75

ADJUSTABLE TRI-BALL HITCH WITH ROTATING TOWING BALLS FOR 2 INCH HITCH RECEIVER **NEW**

- 9.3 in. Maximum drop
- 9.3 in. Maximum rise
- Features an under-bumper storage position



1802000



1802000 Under Bumper Storage

Part No.	Shank Type	Ball Finish	Ball Dia. (in.)	M.G.T.W. (lbs) 1-7/8" Ball	M.G.T.W. (lbs) 2" Ball	M.G.T.W. (lbs) 2-5/16" Ball	Wt. (lbs.)
1802000	Solid	Chrome	1-7/8, 2, 2-5/16	6,000	10,000	15,000	39.01

Accessories:

Part No.	Description	Wt.(lbs.)
BLHP500	5/8 Inch Dead Bolt-style Locking Hitch Pin Assembly for 2-1/2 and 3 Inch Hitch Receivers	1.06
BLHP200	5/8 Inch Locking Hitch Pin	1.06

ADJUSTABLE TRI-BALL HITCH WITH ROTATING TOWING BALLS FOR 2-1/2 INCH HITCH RECEIVER **NEW**

- 5-1/8 in. Maximum drop
- 5-1/8 in. Maximum rise
- Features an under-bumper storage position



1802500



1802500 Under Bumper Storage

Part No.	Shank Type	Ball Finish	Ball Dia. (in.)	M.G.T.W. (lbs) 1-7/8" Ball	M.G.T.W. (lbs) 2" Ball	M.G.T.W. (lbs) 2-5/16" Ball	Wt. (lbs.)
1802500	Tubular	Chrome	1-7/8, 2, 2-5/16	6,000	10,000	15,000	36



ADJUSTABLE MULTI-BALL MOUNTS - continued

ADJUSTABLE ALUMINUM DUAL BALL HITCH FOR 2 INCH HITCH RECEIVERS **NEW**

- Aluminum construction
- 6 in. Maximum drop
- 6 in. Maximum rise



1802800



1802800 Box

Part No.	Shank Type	Ball Finish	Ball Dia. (in.)	M.G.T.W. (lbs)		Wt. (lbs.)
				2" Ball	2-5/16" Ball	
1802800	Solid	Chrome	2, 2-5/16	7,500	7,500	15.0

ADJUSTABLE STEEL DUAL BALL HITCH FOR 2 INCH HITCH RECEIVERS **NEW**

- 5.8 in. Maximum rise and drop (1802600)
- 10 in. Maximum rise and drop (1802603)



1802600



1802600 Box

Part No.	Shank Type	Ball Finish	Ball Dia. (in.)	M.G.T.W. (lbs)		Wt. (lbs.)
				2" Ball	2-5/16" Ball	
1802600	Tubular	Chrome	2, 2-5/16	7,500	10,000	18.8
1802603	Tubular	Chrome	2, 2-5/16	10,000	14,000	38.7



1802000 shown

Hitch Balls

CHROME HITCH BALLS

- Chrome-plated for corrosion resistance
- Choose from a variety of sizes to handle your towing needs
- Individually packaged



1802026

Part No.	Material	Ball Diameter (in.)	Shank Diameter (in.)	Shank Length (in.)	Ball Finish	M.G.T.W. (lbs)	Wt. (lbs.)
1802015	Carbon Steel	1-7/8	0.75	2.125	Chrome	3,500	1.8
1802020	Carbon Steel	1-7/8	1.00	2.125	Chrome	5,000	2.25
1802005	Carbon Steel	2	1.00	2.125	Chrome	6,000	2.5
1802007	Carbon Steel	2	1.00	2.75	Chrome	10,000	2.5
1802010	Carbon Steel	2	0.75	2.125	Chrome	3,500	2.1
1802025	Carbon Steel	2-5/16	1.25	2.75	Chrome	10,000	4.2
1802026	Carbon Steel	2-5/16	1.00	2.125	Chrome	7,500	3.2
1802027	Carbon Steel	2-5/16	1.00	2.75	Chrome	10,000	3.2

BULK HITCH BALLS WITH BLACK FINISH

- Heat-treated black oxide finish for added corrosion resistance
- Individually bagged



1802050

Part No.	Material	Ball Diameter (in.)	Shank Diameter (in.)	Shank Length (in.)	Ball Finish	M.G.T.W. (lbs)	Wt. (lbs.)
1802050	Carbon Steel	2-5/16	1.25	2.75	Black Oxide	30,000	4.06
1802055	Carbon Steel	2-5/16	1.25	2.75 (+1 in. riser)	Black Oxide	30,000	4.81
1802056	Carbon Steel	2-5/16	1.50	2.75 (+1 in. riser)	Black Oxide	30,000	5.8
1802061	Carbon Steel	2-5/16	1.50	2.75 (+2 in. riser)	Black Oxide	30,000	7.04

BULK HITCH BALLS WITH CHROME OR ZINC FINISH

- Durable zinc or chrome-plated finish available
- Wide variety of sizes available for bulk ordering
- Retail-ready with individual labels and UPC barcodes
- Made from durable carbon steel



1802103

Part No.	Material	Ball Diameter (in.)	Shank Diameter (in.)	Shank Length (in.)	Ball Finish	M.G.T.W. (lbs)	Wt. (lbs.)
1802130	Carbon Steel	2	0.75	1.75	Chrome	3,500	2.1
1802131	Carbon Steel	2	0.75	1.75	Zinc Plated Clear	3,500	2.1
1802134	Carbon Steel	2	1.00	2.125	Chrome	5,000	2.5
1802135	Carbon Steel	2	1.00	2.125	Zinc Plated Clear	5,000	2.5
1802136	Carbon Steel	2	1.00	2.75	Chrome	10,000	2.5
1802148	Carbon Steel	2	1.25	2.25	Chrome	7,500	3.75
1802161	Carbon Steel	2-5/16	1.00	2.125	Chrome	6,000	3.2
1802162	Carbon Steel	2-5/16	1.00	2.125	Zinc Plated Clear	6,000	3.2
1802167	Carbon Steel	2-5/16	1.25	2.50	Chrome	10,000	4.25
1802168	Carbon Steel	2-5/16	1.25	2.50	Zinc Plated Clear	10,000	4.25
1802175	Carbon Steel	2-5/16	1.25	2.50	Chrome	5,000	5.6
1802028	Carbon Steel	2-5/16	1.25	2.75	Chrome	20,000	4.26



NON-LOCKING HITCH PINS

HITCH PIN WITH COTTER

- Zinc plated for corrosion resistance
- Choose the size to fit your hitch receiver

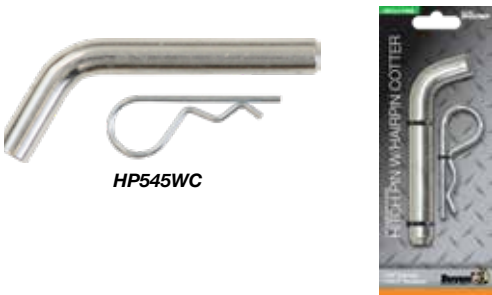

HP545WC

HP6253WCP Package

Part No.	Receiver		Usable Pin		Locking (Y/N)	Finish	Material	Wt. (lbs.)
	Tube Size (in.)	Diameter (in.)	Length (in.)	Length (in.)				
HP545WC	1-1/4	1/2	2.84		No	Zinc Plated Clear	Carbon Steel	0.28
HP6253WC	2	5/8	3.316		No	Zinc Plated Clear	Carbon Steel	0.58
HP6253WCP	2	5/8	3.316		No	Zinc Plated Clear	Carbon Steel	0.55
HP6256WC	2, 2-1/2, 3	5/8	3.816		No	Zinc Plated Yellow	Carbon Steel	0.58
HP6258WC	2, 2-1/2 & 3	5/8	4.2		No	Zinc Plated Yellow	Carbon Steel	0.58

HITCH PIN WITH SPRING CLIP

- Zinc-plated for corrosion resistance
- Fast, easy way to secure a hitch pin



HP625SC

HP625SC Packaging

Part No.	Receiver		Usable Pin		Locking (Y/N)	Finish	Material	Wt. (lbs.)
	Tube Size (in.)	Diameter (in.)	Length (in.)	Length (in.)				
HP625SC	2	5/8	2.5		No	Zinc Plated Clear	Carbon Steel	0.5
HP630SC	2, 2-1/2 & 3	5/8	3.3		No	Zinc Plated Clear	Carbon Steel	0.5

*HP630SC available Q2 2023

LOCKING HITCH PINS

BONE-STYLE LOCKING HITCH PINS

- Chrome-plated for corrosion resistance
- Helps protect your trailer and hitch from theft
- Lock cap protects the lock mechanism from outdoor elements



BLHP300

BLHP300 Packaging

Part No.	Receiver		Usable Pin Length (in.)	Locking (Y/N)	Finish	Material	Wt. (lbs.)
	Tube Size (in.)	Diameter (in.)					
BLHP300	2	5/8	2.625	Yes	Chrome	Carbon Steel	1.85
BLHP350	2, 2-1/2 & 3	5/8	3.125	Yes	Chrome	Carbon Steel	1.95

DEAD BOLT-STYLE LOCKING HITCH PINS

- Chrome-plated for corrosion resistance
- Helps protect your trailer and hitch from theft



BLHP200

BLHP200 Packaging

Part No.	Receiver		Usable Pin Length (in.)	Locking (Y/N)	Finish	Material	Wt. (lbs.)
	Tube Size (in.)	Diameter (in.)					
BLHP200	2, 2-1/2 & 3	5/8	3.125	Yes	Chrome	Carbon Steel	1.85

Hitch Plates

PINTLE MOUNT HITCH PLATES

- Includes two 5/8 in. forged D-rings with brackets
- Multiple pintle hook mounting positions; pre-punched hole fits multiple trailer connectors
- Includes ICC bumper protection
- Accepts PH6, PH10, PH15, PH20, BH8 Series and similar pintle hooks (except 1809029 which accepts PH30)

PINTLE MOUNT HITCH PLATE WITH SIDE ICC CHANNEL

- Black powder-coat finish



1809030B

Part No.	Thickness			Make	Model	Year	M.G.T.W.	Wt. (lbs.)
	(in.)	Height (in.)	Width (in.)					
1809030B	1/2	15.75	63.00	Ford®	F350/F550	1999+	20,000	113.97
1809035A	1/2	15.50	34.12	Chevy®	3500		20,000	104.94
1809037A	1/2	15.81	35.06	RAM®	3500/5500		20,000	116.5
1809038A	1/2	16.94	33.56	Chevy®	4500/5500	2003-2010	20,000	111.98
1809039A	1/2	22.00	33.56	Chevy®	4500/5500	2003-2010	20,000	135.59

PINTLE MOUNT HITCH PLATE WITH BOTTOM ICC CHANNEL

- Black powder-coat finish



1809031A

Part No.	Thickness			Make	Model	Year	M.G.T.W.	Wt. (lbs.)
	(in.)	Height (in.)	Width (in.)					
1809031A	1/2	17.2	34.25	Ford®	F350/F550	1999+	20,000	124.7
1809036	1/2	16.91	62.00	Chevy®	3500	2003-2010	20,000	112.41
1809079	1/2	17.39	62.00	Dodge®	RAM 3500/5500		20,000	127.24
1809080	1/2	17.10	62.00	Chevy®/GMC®/ International®	4500HD, 6500HD	2019+	20,000	125.16

FABRICATORS PINTLE MOUNT HITCH PLATE

- Trailer connector cut out
- Includes two D-Rings with bracket: 5/8 in. D-Ring on 1/2 in. thick plate; 1 in. D-Ring on the other sizes
- Two weld-on gussets



1809040

Part No.	Thickness (in.)	Height (in.)	Width (in.)	M.G.T.W. (lbs)	Wt. (lbs.)
1809040	1/2	15.50	34.50	Not Rated	71
1809042	5/8	15.50	34.50	Not Rated	93
1809043	5/8	22.50	34.50	Not Rated	131
1809027A	3/4	23.50	34.50	Not Rated	168.2
1809029*	1.00	22.50	34.50	Not Rated	217.24

*4.5" bolt centers on 1809029 fits PH30 30-Ton Pintle Hitch



RECEIVER TUBE HITCH PLATES

- Black powder coat finish
- Two 5/8 in. forged D-rings with brackets
- Pre-punched hole fits multiple trailer connectors
- Includes ICC bumper protection

2 INCH RECEIVER TUBE HITCH PLATE WITH BOTTOM ICC CHANNEL



1809060A

Part No.	Thickness			Make	Model	Year	M.G.T.W.	Wt. (lbs.)
	(in.)	Height (in.)	Width (in.)					
1809060A	1/2	17.20	62.00	Ford®	F350/F550	1999+	20,000	128.95
1809065	1/2	16.91	62.00	Chevy®	F-3500		20,000	116.65
1809067	1/2	17.39	62.00	Dodge®	RAM 3500/5500		20,000	131.48

2-1/2 INCH RECEIVER TUBE HITCH PLATE WITH BOTTOM ICC CHANNEL



1809061A

Part No.	Thickness			Make	Model	Year	M.G.T.W.	Wt. (lbs.)
	(in.)	Height (in.)	Width (in.)					
1809061A	1/2	17.20	62.00	Ford®	F350/F550	1999+	20,000	129.93
1809075	1/2	16.91	62.00	Chevy®	3500		20,000	117.63
1809077	1/2	17.39	62.00	Dodge®	RAM 3500/5500		20,000	132.46
1809085	1/2	17.10	62.00	GMC®/ Chevy®	4500/5500/6500/ International	2019+	20,000	130.39

FLATBED HITCH PLATES

- Universal fit provides ICC bumper protection
- Two position pintle hook mounting
- Includes two 5/8 in. forged D-rings with brackets
- Standard mounting holes for Ford F-350, F-450, F-550 (drilling required for GM trucks); pre-punched hole fits multiple trailer connectors
- Requires minimum of two 3 in. welds per side

PINTLE MOUNT FLATBED HITCH PLATE



1809050

Part No.	Thickness			Hitch Plate or Bumper	Application Summary	M.G.T.W.	Wt. (lbs.)
	(in.)	Height (in.)	Width (in.)				
1809050	1/2	16.18	62.00	Hitch Bumper	Cab and chassis trucks with a nominal 34 in. frame Width (in.).	20,000	117.6

2 INCH RECEIVER TUBE FLATBED HITCH PLATE



1809055

Part No.	Thickness			Hitch Plate or Bumper	Application Summary	M.G.T.W.	Wt. (lbs.)
	(in.)	Height (in.)	Width (in.)				
1809055	1/2	16.18	62.00	Hitch Bumper	Nominal 34" Frame Width (in.)	17,000	123.77

Hitch Plates

FLATBED HITCH PLATES - continued

- Universal fit provides ICC bumper protection
- Two position pintle hook mounting
- Includes two 5/8 in. forged D-rings with brackets
- Standard mounting holes for Ford F-350, F-450, F-550 (drilling required for GM trucks); pre-punched hole fits multiple trailer connectors
- Requires minimum of two 3 in. welds per side

2-1/2 INCH RECEIVER TUBE FLATBED HITCH PLATE



1809070

Part No.	Thickness (in.)	Height (in.)	Width (in.)	Hitch Plate or Bumper	Application Summary	M.G.T.W.	Wt. (lbs.)
1809070	1/2	16.18	62.00	Hitch Bumper	Cab and Chassis with Nominal 34" Frame Width (in.)	20,000	123.54

ICC BUMPER

- Corrosion-resistant black powder coat finish
- 4 in. structural steel C-channel construction



1809025

Part No.	Height (in.)	Width (in.)	Wt. (lbs.)
1809025	17.50	62.00	42.5

1809070 shown



CUTAWAY CHASSIS

CLASS 4 HITCH RECEIVER FOR FORD TRANSIT CUTAWAY CAB & CHASSIS WITH 2 INCH RECEIVER

- Black powder coat finish
- Easy bolt-on installation with no welding required, fasteners included



1801226

Part No.	Height (in.)	Width (in.)	Make	Model	M.G.T.W.	Wt. (lbs.)
1801226	14.00	33.13	Ford®	Transit	7,500	51.44

CAB AND CHASSIS

CLASS 5 HITCH RECEIVERS WITH 2 INCH RECEIVER TUBE

- Black powder-coat finish
- Heavy duty design for Ford®, GM®, Dodge/RAM®
- Available for use on cut-away service bodies
- Includes all hardware required for installation
- Includes 5/8 in. hitch pin with cotter



1801100

Part No.	Height (in.)	Width (in.)	Make	Model	Year	M.G.T.W.	Wt. (lbs.)
1801100	4.75	39.54	GM®	Express/Savana	1996-2018	12,000	41.6
1801102	10.38	39.25	GM®	Express/Savana	1996-2018	12,000	51.8
1801111	7.04	33.30	GM®	C3500	2011-2016	16,000	57.005
1801121	10.75	41.56	GM®	2500/3500	2020+	16,000	88.005
1801208A	10.01	33.94	Ford®	F350	2009-2016	16,000	63.48
1801214	10.01	33.94	Ford®	F450/F550	2011-2016	17,000	62
1801215	11.00	34.06	Ford®	F450/F550	2017+	20,000	82
1801220	11.00	26.60	Ford®	F350	2011+	20,000	82.005
1801301	11.30	33.60	GM®/Ford®/ Ram®	Multi-Fit		15,000	64
1801310	9.40	37.12	Ram®	2500	2014+	17,000	81.005
1801401	13.80	50.40	GM®/Ford®	Multi-Fit		12,000	72.89

CLASS 5 HITCH RECEIVERS WITH 2-1/2 INCH RECEIVER TUBE

- Black powder-coat finish
- Includes 5/8 in. hitch pin with cotter
- Does not include mounting hardware



1801510

Part No.	Height (in.)	Width (in.)	Make	Model	Year	M.G.T.W.	Wt. (lbs.)
1801500	10.04	33.63	GM®/Ram®	Multi-Fit		22,000	71.005
1801505	11.25	41.56	GM®	2500/3500	2020+	20,000	91.73
1801510	9.50	34.00	Ford®	F350-F650	1999+	22,000	75.005

Receiver Hitches

SERVICE BODY

CLASS 4 SERVICE BODY HITCH RECEIVER WITH 2 INCH RECEIVER TUBE

- Black powder-coat finish
- Heavy duty design for Stahl service bodies



1801053

Part No.	Application	M.V.L. (lbs)	M.G.T.W. (lbs)	Mount Type	Depth (in.)	Receiver Tube Length (in.)	Wt. (lbs.)
1801053	Service Body	1,000	10,000	Bolt-on	10.25	7.8	65
1801055	Service Body	1,000	10,000	Bolt-on	14.75	12.3	66.5

CLASS 4 SERVICE BODY HITCH RECEIVER WITH 2-1/2 INCH RECEIVER TUBE

- Black powder-coat finish
- Heavy duty design for Stahl service bodies



1801059

Part No.	Application	M.V.L. (lbs)	M.G.T.W. (lbs)	Mount Type	Depth (in.)	Receiver Tube Length (in.)	Wt. (lbs.)
1801059	Service Body	1,000	10,000	Weld-On	14.22	8.0	71.83

CLASS 5 SERVICE BODY HITCH RECEIVER WITH 2 INCH RECEIVER TUBE

- Black powder coat finish
- Heavy duty design for service bodies
- Includes 5/8 in. hitch pin with cotter
- Mounting plates ship unwelded so they can be positioned to suit your needs
- Available in different lengths and with standard or tall mounting plates to suit a wide variety of applications
- Available unpainted



1801051

Part No.	Application	M.V.L. (lbs)	M.G.T.W. (lbs)	Mount Type	Length (in.)	Mounting Plate Height (in.)	Wt. (lbs.)
1801050	Service Body	1,600	16,000	Weld-on	44	9.00	48.7
1801050L	Service Body	1,600	16,000	Weld-on	44	18.29	74
3045158	Service Body	1,600	16,000	Weld-on (Unpainted Brackets)	44	9.00	48.08
3006909	Service Body	-	-	Installer Needs to Fabricate Their Own Mounting Brackets	44	-	38
1801051	Service Body	1,600	16,000	Weld-on	62	9.00	62
1801051L	Platform Bodies	1,600	16,000	Weld-on	62	18.29	85.5

CLASS 5 SERVICE BODY HITCH RECEIVER WITH 2-1/2 INCH RECEIVER TUBE

- Black powder-coat finish
- Heavy duty design for platform bodies
- Includes 5/8 in. hitch pin with cotter
- Mounting plates ship unwelded so they can be positioned to suit your needs
- Available in different lengths and with standard or tall mounting plates to suit a wide variety of applications
- Available unpainted



1801052

Part No.	Application	M.V.L. (lbs)	M.G.T.W. (lbs)	Mount Type	Length (in.)	Mounting Plate Height (in.)	Wt. (lbs.)
1801052	Service Body	2,000	20,000	Weld-on	44	9.00	50.78
1801052L	Service Body	2,000	20,000	Weld-on	44	18.29	76.6
3018538	Service Body	-	-	Installer Needs to Fabricate Their Own Mounting Brackets	44	-	39.42
3039693	Service Body	-	-	Installer Needs to Fabricate Their Own Mounting Brackets, Unpainted Hitch	44	-	39.41
1801060	Service Body	2,000	20,000	Weld-on	62	9	62.23
1801060L	Service Body	2,000	20,000	Weld-On	62	18.29	89.02



SERVICE BODY - continued

CLASS 5 SERVICE BODY HITCH RECEIVER WITH 2-1/2 INCH RECEIVER TUBE FOR FORD® & GM® **NEW**

- Black powder coat finish
- Heavy duty, 4in. x 4in. X 5/16in. cross tube design
- Bolt-on frame mounting plates, hardware included
- Fits cab & chassis with 60in. or 84in. CA (Cab-to-Axle dimensions)
- 1801080 Fits Ford® F350, F450, F550 (compares to B&W® HDRH26010)
- 1801085 Fits GM® 3500, 4500, 5500 (compares to B&W® HDRH26030)



1801080

Part No.	Height (in.)	Width (in.)	Make	Model	M.G.T.W.	Wt. (lbs.)
1801080	20.16	40.28	Ford®	F350-F550	20,000	94.00
1801085	20.16	40.28	GM®	3500-5500	20,000	91.00

RV'S

TRAILER ACCESSORY/LIGHT TOWING HITCH RECEIVER

- Black powder-coat finish
- Ideal for light towing, bike & cargo racks
- Accepts 2 in. receiver-mounted accessories
- Universal fit; 6 1/2 ft. wide
- Mounting kit included (drilling required)
- Ships in two pieces: receiver (bulk) & mounting kit (boxed)



1801125

Part No.	Application	M.V.L. (lbs)	M.G.T.W. (lbs)	Mount Type	Wt. (lbs.)
1801125	Recreational Vehicles	350	3,000	Weld-on	55

RV BUMPER TRAILER HITCH

- 2 in. receiver opening
- Mounts to 4 in. square tube bumper of RV
- Assembly required; zinc-plated hardware included
- Class 2
- 5/8 in. Hitch pin hole



1804060

Part No.	M.G.T.W. (lbs)	M.V.L. (lbs)	Wt. (lbs.)
1804060	3,500	350	9.53

Receiver Hitches

RV'S - continued

RV BUMPER RECEIVER ADAPTER

- Fits standard 4 in. and 4 1/2 in. square RV bumpers
- 2 in. receiver opening
- Ideal for bike carriers and other accessories
- Assembly required; zinc-plated hardware included
- NOT FOR TOWING



RVA24

Part No.	M.V.L. (lbs)	Wt. (lbs.)
 RVA24	200	7

STEP BUMPER HITCH

- Black powder coat finish
- Fits most full-sized trucks with step bumpers
- Bolt-On hardware included
- Works with 2 in. receiver
- 10.25"L x 5.13"W x 3.06"H



SBH2

Part No.	M.G.T.W. (lbs)	M.V.L. (lbs)	Wt. (lbs.)
 SBH2	3,500	350	8.2

3 POINT TRACTOR

3-POINT TRACTOR HITCH RECEIVER

- 2 in. receiver
- Fits common 3-point tractors hitches
- (2) 7/8 in. pins & (1) 5/8 in. hitch pin included
- 24"H x 6-3/16"D x 33-3/16"W



3005345

Part No.	Mount Type	Wt. (lbs.)
3005345	3-Point	45



CLASS 2 & 3 TRAILER SAFETY CHAIN

- Zinc-plated for corrosion resistance
- Easy-to-use quick links for a secure safety chain connection
- 11215, 11220 ship (5) per carton
- NOT FOR LIFTING



B93248SC

Part No.	Material	Chain Length (in.)	Chain Diameter (in.)	Quick Links	M.G.T.W. (lbs)	Wt. (lbs.)
B31648SC	Carbon Steel	48.00	3/16	2	3,000	1.9
B93234SC	Carbon Steel	34.00	9/32	2	5,000	2.08
B93248SC	Carbon Steel	48.00	9/32	2	5,000	2.88
11215	Carbon Steel	48.00	9/32	2	5,000	3.31
B93272SC	Carbon Steel	72.00	9/32	2	5,000	4.39
11220	Carbon Steel	72.00	9/32	2	5,000	4.68

CLASS 4 TRAILER SAFETY CHAIN WITH FORGED EYE SLIP HOOK

- Zinc-plated for corrosion resistance
- Forged eye steel slip hook
- NOT FOR LIFTING



B03822SC

Part No.	Material	Chain Length (in.)	Chain Diameter (in.)	M.G.T.W. (lbs)	Coil	Wt. (lbs.)
B03822SC	Carbon Steel	22.00	3/8	10,000	30 Proof	3.285
B03835SC	Carbon Steel	35.00	3/8	10,000	30 Proof	4.75

CLASS 4 TRAILER SAFETY CHAIN WITH REMOVABLE CLEVIS STYLE HOOK

- Zinc-plated for corrosion resistance
- Clevis style slip hook
- 11275 ships (5) per carton
- NOT FOR LIFTING



BSC3835

Part No.	Material	Chain Length (in.)	Chain Diameter (in.)	M.G.T.W. (lbs)	Coil	Wt. (lbs.)
BSC3835	Carbon Steel	35.00	3/8	15,000	40 Proof	5.105
11275	Carbon Steel	35.00	3/8	15,000	43 Proof	5.75
BSC3842	Carbon Steel	42.00	3/8	15,000	43 Proof	6.032

PROPER SAFETY CHAIN USE

Safety Chains act as the final connection between the towing vehicle and the trailer, in the event there is a failure in the towing hitch and/or the coupler.

Use one or two safety chains set to a length that will allow for the turning radius of the vehicle but will not drag on the ground when in operation. The safety chains must have a "holding" capacity of at least the total weight of the trailer and contents.

When applying the safety chain hook up, cross the chain(s) under the trailer tongue to ensure that the tongue will not drop to the ground in the event of a failure.

For full SAE safety chain specifications, refer to SAE J684 specifications and standards.

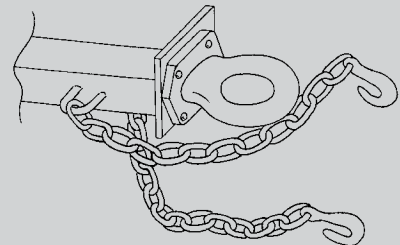

Safety Chains

WELD-ON SAFETY CHAIN RETAINER

- Forged steel construction
- Easily remove or replace a chain
- Included removable, zinc-plated clevis pin and cotter



5471000



5471001 Application

Part No.	Material	Accommodates Chain Dia. (in.)	W.L.L. (lbs)	Wt. (lbs.)
5471000	Forged Steel	5/16	10,000	0.73
5471001	Forged Steel	3/8	25,000	1.06

WELD-ON SAFETY CHAIN BAR

- Steel rod chain clip
- Secure chains to trailer frames



SC38B

Part No.	Material	Accommodates Chain Dia. (in.)	Wt. (lbs.)
SC38B	Carbon Steel	3/8	0.15
SC44B	Carbon Steel	7/16	0.19
SC50B	Carbon Steel	1/2	0.36
SC58B	Carbon Steel	5/8	0.88

QUICK LINK CONNECTOR

- Zinc-plated for corrosion resistance
- 2-3/4 in. L x 3/4 in. W I.D.
- Ideal for connecting chain, cable, or wire rope
- NOT FOR LIFTING



7350038

Part No.	Diameter (in.)	W.L.L. (lbs)	Material	Finish	Wt. (lbs.)
7350038	3/8	2,650	Carbon Steel	Zinc Plated	0.29

DOUBLE CLEVIS LINK

- Drop forged
- Heat treated
- Clear zinc-plated for corrosion resistance
- 1/2 in. pin diameter
- Ideal for tailgate chains on dump trucks



B2409C



B2409C Application

Part No.	Material	Chain Diameter (in.)	W.L.L. (lbs)	Wt. (lbs.)
B2409C	Carbon Steel	3/8	5,400	0.75



2, 2-1/2 & 3 INCH WELD-ON RECEIVER TUBES

- Plain or black powder-coat finishes available
- 2 in., 2-1/2 in., and 3 in.
- Cast steel collar
- 5/8 in. hitch pin hole



RT25806



RT255810



RT305808

Part No.	Receiver Size (in.)	Length (in.)	Finish	Mount Type	Wt. (lbs.)
2" RECEIVER TUBES					
RT25806	2.00	6.00	Plain	Weld On	3.76
RT25806B	2.00	6.00	Powder-Coat	Weld On	3.76
RT25808	2.00	8.00	Plain	Weld On	5.12
RT25808B	2.00	8.00	Powder-Coat	Weld On	5
RT25810	2.00	10.00	Plain	Weld On	6
RT25810B	2.00	10.00	Powder-Coat	Weld On	6
RT25812	2.00	12.00	Powder-Coat	Weld On	7.04
RT25812B	2.00	12.00	Powder-Coat	Weld On	7.04
RT25814	2.00	14.00	Plain	Weld On	8.29
RT25818	2.00	18.00	Plain	Weld On	10
RT25818B	2.00	18.00	Powder-Coat	Weld On	10
RT25824	2.00	24.00	Plain	Weld On	13.76
RT25824B	2.00	24.00	Powder-Coat	Weld On	13.76
RT25836	2.00	36.00	Plain	Weld On	20.49
RT25836B	2.00	36.00	Powder-Coat	Weld On	20.57
RT25848	2.00	48.00	Plain	Weld On	27.16
RT25848B	2.00	48.00	Powder-Coat	Weld On	27
2-1/2" RECEIVER TUBES					
RT255806	2.50	6.00	Plain	Weld On	4.89
RT255808	2.50	8.00	Plain	Weld On	5.81
RT255810	2.50	10.00	Plain	Weld On	7.49
RT255812	2.50	12.00	Plain	Weld On	8.76
RT255818	2.50	18.00	Plain	Weld On	12.84
3" RECEIVER TUBES					
RT305808	3.00	8.00	Plain	Weld On	7.45
RT305812	3.00	12.00	Plain	Weld On	10.8
RT305818	3.00	18.00	Plain	Weld On	15.9

BOLT-ON RECEIVER TUBE

- Bolts across three standard pintle hook hole patterns



1804055

Part No.	Receiver Size (in.)	M.G.T.W. (lbs)	M.V.L. (lbs)	Wt. (lbs.)
1804055	2.00	20,000	2,000	8
1804250	2.50	20,000	2,000	10.14

Accessories:

Part No.	Description	Wt. (lbs.)
8520	Mounting Kit: (4) 1/2 in. x 2 in. Grade 8 cap screws, (4) 1/2 in. Grade 8 hex nuts, and (4) 1/2 in. heavy lock washers	0.73

Receiver Adapters

HITCH RECEIVER EXTENSION

- Accepts all 2 in. hitch accessories
- Cast steel collar
- 5/8 in. hitch pin hole



1804005

Part No.	Receiver Adapter Start Size (in.)	Receiver Adapter Convert Size (in.)	Mount Type	Receiver Size (in.)	Length (in.)	Finish	M.G.T.W. (lbs)	Wt. (lbs.)
1804003	2.00	2.00	Receiver Extension	2.00	7.00	Powder-Coat	Reduces maximum hitch capacity by 33%	11.86
1804005	2.00	2.00	Receiver Extension	2.00	12.00	Powder-Coat	Reduces maximum hitch capacity by 33%	17.95
1804007	2.00	2.00	Receiver Extension	2.00	18.00	Powder-Coat	Reduces maximum hitch capacity by 33%	23.6

HITCH RECEIVER EXTENSION WITH STEP

- 17 in. x 6 in. step plate with diamond tread finish
- Accepts all 2 in. hitch accessories
- Cast steel collar
- 5/8 in. hitch pin holes



1804015

Part No.	Receiver Adapter Start Size (in.)	Receiver Adapter Convert Size (in.)	Mount Type	Receiver Size (in.)	Length (in.)	Finish	M.G.T.W. (lbs)	Wt. (lbs.)
1804015	2.00	2.00	Receiver Extension	2.00	12.00	Powder-Coat	Reduces maximum hitch capacity by 33%	21
1804017	2.00	2.00	Receiver Extension	2.00	18.00	Powder-Coat	Reduces maximum hitch capacity by 33%	27.05

2 INCH TO 1-1/4 INCH HITCH ADAPTER

- 1/2 in. hitch pin included



1804035

Part No.	Receiver Adapter Start Size (in.)	Receiver Adapter Convert Size (in.)	Mount Type	Receiver Size (in.)	Finish	M.G.T.W. (lbs)	M.V.L. (lbs)	Wt. (lbs.)
1804035	2.00	1.25	Receiver Adapter	2.00	Powder-Coat	3,000	300	3

2-1/2 INCH TO 2 INCH RECEIVER TUBE ADAPTER

- Corrosion-resistant zinc plating
- Will not change towing capacity requirements
- 5/8 in. hitch pin holes



RTA252

Part No.	Receiver Adapter Start Size (in.)	Receiver Adapter Convert Size (in.)	Mount Type	Receiver Size (in.)	Finish	Wt. (lbs.)
RTA252	2.50	2.00	Receiver Adapter	2.50	Zinc Plated	3.25



2-1/2 INCH TO 2 INCH RECEIVER TUBE ADAPTER WITH LANCE STOP **NEW**

- Zinc-plated for corrosion resistance
- Stop tabs to prevent adaptor from sliding forward out of alignment
- Will not change towing capacity requirements
- 5/8 in. slotted hitch pin holes for ease of alignment



RTA2520

Part No.	Receiver Adapter Start Size (in.)	Receiver Adapter Convert Size (in.)	Mount Type	Receiver Size (in.)	Finish	Wt. (lbs.)
RTA2520	2.50	2.00	Receiver Adapter	2.50	Zinc Plated	3.09

3 INCH TO 2 INCH RECEIVER TUBE HITCH ADAPTER

- Black powder coat finish
- Convert from 3 in. to 2 in. hitch applications
- 5/8 in. hitch pin holes



RTA302

Part No.	Receiver Adapter Convert Size (in.)	Mount Type	Receiver Size (in.)	Length (in.)	Finish	M.G.T.W. (lbs)	M.V.L. (lbs)	Wt. (lbs.)
RTA302	2.00	Receiver Adapter	3.00	3.94	Powder-Coat	12,000	1,200	8.49

3 INCH RECEIVER TUBE REDUCER SLEEVE SET **NEW**

- Black powder coat finish
- Reduces your 3 in. receiver tube opening to a 2 1/2 in. or 2 in.
- Compact nested design keeps the sleeves together so it's easy to swap sizes



RTA3252

Part No.	Receiver Adapter Convert Size (in.)	Mount Type	Receiver Size (in.)	Length (in.)	Finish	Wt. (lbs.)
RTA3252	2.50	Receiver Adapter	3	7.00	Powder-Coat	8.9

HITCH MOUNTED TRAILER STONE GUARDS **NEW**

- Black powder-coat steel construction with durable 3/8 in. thick composite mud flaps
- Clamps over 2 in., 2-1/2 in., and 3 in. receivers, also mounts to ball hitch shanks
- Cutouts for safety chain access
- Available with 15 in. flaps or 20 in. flaps
- Protects RVs and trailers from road debris



8597215



8597215 Application

Part No.	Width (in.)	Height (in.)	Thickness (in.)	Color	Mount Type	Material	Wt. (lbs.)
8597215	72.00	15.00	1.9	Black	Clamp-On	Carbon Steel	44
8597220	72.00	20.00	1.9	Black	Clamp-On	Carbon Steel	50

Gooseneck Hitch Accessories & King Pins

FABRICATORS KIT FOR FLATBEDS

- Flush-mounted to keep from obstructing load space
- Under-mount design makes for a clean appearance
- Kit includes: 2-5/16 in. zinc-plated ball, weld-on socket, spring loaded safety chain U bolts and hardware

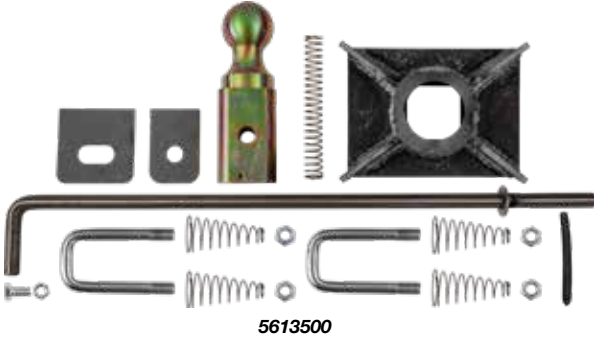

Part No.	Mount Type	M.G.T.W. (lbs)	M.V.L. (lbs)	Wt. (lbs.)
5613500	Flip Ball Gooseneck	30,000	7,500	25
3018195	Replacement Ball	30,000	5,000	8.39

GOOSENECK HITCH PLATE

- Black powder coat finish
- Steel plate construction
- 2-5/16 in. towing ball
- 42 in. L x 13.5 in. T x 3/8 in. Thick

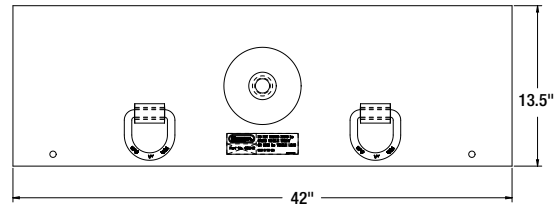

Part No.	D-Rings	M.G.T.W. (lbs)	M.V.L. (lbs)	Mount Type	Wt. (lbs.)
G9542	No	25,000	5,000	Fixed Gooseneck Plate	66
3014981	Yes	25,000	5,000	Fixed Gooseneck Plate	71.2

TRAILER KING PINS

- Forged from AISI 8630 steel, heat treated to create and maintain a hardness of 302-363 BHN
- Weldable (BKPT809B is Bolt-On)
- 150,000 P.S.I. in ultimate strength



Part No.	Material	Finish	Mount Type	Bolster Plate Thickness (in.)	Brinell Hardness	Wt. (lbs.)
KP20025	Forged Steel	Plain	Weld	0.25	302-363 BHN	13.03
KP20031	Forged Steel	Plain	Weld	0.312	302-363 BHN	12.95
KP20038	Forged Steel	Plain	Weld	0.375	302-363 BHN	13
KP20050	Forged Steel	Plain	Weld	0.50	302-363 BHN	13.2
BKPT809B	Forged Steel	Plain	Bolt	0.50	302-363 BHN	12.88



FIFTH WHEEL LUBE DISKS WITH RETENTION CLIP

- Durable poly disk with steel retention clip provides constant lubrication
- Eliminates the need for 5th wheel plate grease and time-consuming cleaning
- Large surface area provides extra towing protection
- Solid in boxes of 5 only



FWD24



FWRC

Part No.	Description	Thickness (in.)	Material	Color	Wt. (lbs.)
FWD24	24" x .185" thick with steel clip	0.19	Polymer	Black	3.8
FWD32	32" x .185" thick with steel clip	0.19	Polymer	Black	5.11
FWD36	36" x .185" thick with steel clip	0.19	Polymer	Black	6.51

Accessories:

Part No.	Description	Wt.(lbs.)
FWRC	Fifth Wheel Lube Disk Steel Retention Clip Only	0.11

KING PIN LOCK

- Cast steel construction
- Quick installation and removal
- Keyed alike



KPL200

Part No.	Material	Finish	Wt. (lbs.)
 KPL200	Cast Steel	Zinc Plated Clear	3.36

WELD-ON TOW/RECOVERY HOOKS GRADE 43

- For use with grade 43 chain



B2408W

Part No.	Material	Capacity (lbs)	Chain Size (in.)	Wt. (lbs.)
B2408W	Forged Steel	3,900	5/16	0.44
B2408W375	Forged Steel	5,400	3/8	0.87
B2408W50	Forged Steel	9,200	1/2	1.72

WELD-ON TOW/RECOVERY HOOK GRADE 70

- For use with grade 70 chain



B2409W375

Part No.	Material	Capacity (lbs)	Chain Size (in.)	Wt. (lbs.)
B2409W375	Forged Steel	6600	3/8	1

Towing Hooks

DROP-FORGED LIGHT DUTY TOW/RECOVERY HOOK PAIRS

- Black powder-coat finish for corrosion resistance
- Universal bolt pattern
- Shipped in pairs



B2799B

Part No.	Material	Capacity (lbs)	Mounting Holes Center to Center (in.)	Wt. (lbs.)
B2799B	Forged Steel	10,000	1.375	3.5

DROP-FORGED TOW/RECOVERY HOOK PAIRS

- Shipped in pairs of right and left hand patterns
- Available in black powder-coat, chrome plated or plain finish



B2800AB



B2800A Application

Part No.	Material	Finish	Capacity (lbs)	Mounting Holes		Wt. (lbs.)
				Center to Center (in.)	Mounting Hole Diameter (in.)	
B2800A	Forged Steel	Plain	13,500	Vertical 4.25	.78	9.4
B2800AB	Forged Steel	Powder-Coat	13,500	Vertical 4.25	.794	9.08
B2800AC	Forged Steel	Chrome	13,500	Vertical 4.25	.78/.66	9.4

DROP-FORGED HEAVY-DUTY TOW/RECOVERY HOOK PAIRS

- Shipped in pairs of right and left hand patterns



B2801A

Part No.	Material	Finish	Capacity (lbs)	Mounting Holes Center to		Wt. (lbs.)
				Center (in.)	Mounting Hole Diameter (in.)	
B2801A	Forged Steel	Plain	44,600	Vertical 4.19	.78/.66	14

BOLT-ON HEAVY DUTY TOW/RECOVERY HOOK

- Corrosion-resistant black powder coat finish
- Drop-forged steel



B076A

Part No.	Material	Finish	Capacity (lbs)	Mounting Holes Center to		Wt. (lbs.)
				Center (in.)	Mounting Hole Diameter (in.)	
B076A	Forged Steel	Powder-Coat	20,000	2.812 Vertical / 2.50 Horizontal	.562	4



WELD-ON DRAWBARS AND LUNETTE EYES

- Drop-forged steel construction

DRAWBAR

- Welds onto trailer tongue
- Use accessory 3013872 drawbar gauge as a tool to measure drawbar or lunette ring wear with color-coded indicators of when the item needs to be replaced.



LW10



3013872

Part No.	Finish	Eye Inner Diameter (in.)	Eye Outer Diameter (in.)	M.G.T.W. (lbs)	M.V.L. (lbs)	Wt. (lbs.)
LW10	Plain	2.50	4.50	10,000	1,000	4

Accessories:

Part No.	Description	Wt. (lbs.)
3013872	Drawbar Wear Gauge	0.98

LUNETTE EYE

- Forged Steel
- Use accessory 3013872 drawbar gauge as a tool to measure drawbar or lunette ring wear with color-coded indicators of when the item needs to be replaced.



LW625



3013872

Part No.	Finish	Eye Inner Diameter (in.)	Eye Outer Diameter (in.)	Wt. (lbs.)
LW625	Plain	3.00	5.00	2.9
LW847	Plain	3.00	6.25	9

Accessories:

Part No.	Description	Wt. (lbs.)
3013872	Drawbar Wear Gauge	0.98

UNTHREADED EYE BOLT

- Unthreaded design allows you to custom-thread to meet your needs
- Use accessory 3013872 drawbar gauge as a tool to measure drawbar or lunette ring wear with color-coded indicators of when the item needs to be replaced.



B56734BLK



3013872

Part No.	Outer Eye Diameter (in.)	Eye Opening (in.)	Bolt Shaft Diameter (in.)	Bolt Shaft Length (in.)	Wt. (lbs.)
B56734BLK	5.50	2.563	1.50	3.50	9

Accessories:

Part No.	Description	Wt. (lbs.)
3013872	Drawbar Wear Gauge	0.98

DRAWBAR LOCK

- Zinc-plated
- Helps deter trailer theft by filling the eye of your drawbar when not in use
- Fits into all standard 2-1/2 to 3 in. lunette eyes, and easily accommodates most 1.2 in. diameter padlocks
- Drawbar and lock not included



BDL253

Part No.	Material	Finish	Wt. (lbs.)
 BDL253	Carbon Steel	Zinc Plated	4

TRAILER NOSE PLATE FOR MOUNTING DRAWBAR

- Accepts most 4-1/2 in. bolt center drawbars
- Accommodates three adjustable heights

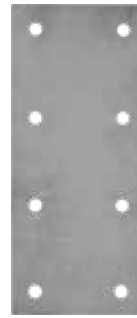

TNP716625750

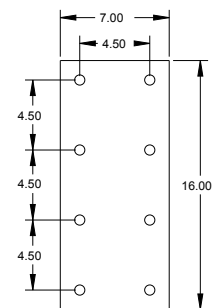

Part No.	Plate Thickness (in.)	Size (in.)	Bolt Hole Size (in.)	Wt. (lbs.)
TNP716625750	3/4	3/4 x 7 x 16	5/8	24
TNP716750100	1	1 x 7 x 16	3/4	32

Drawbars and Lunette Eyes

BOLT-ON DRAWBARS AND LUNETTE EYES

4 BOLT DRAWBAR

- Black powder-coat finish
- Easy to install bolt-on 4-1/2 in. mounting centers
- Welded construction



BDB125015W

Part No.	Finish	Eye Inner Diameter (in.)	Eye Outer Diameter (in.)	Bolt Hole Size (in.)	M.G.T.W. (lbs)	M.V.L. (lbs)	Wt. (lbs.)
BDB125015W	Powder-Coat	2.50	5.50	5/8	42,000	7,000	14.48

FORGED 4 BOLT DRAWBAR

- Black powder coat or zinc-plated finish
- Tough, one-piece forged alloy steel construction



BDB1385



BDB13850Z

Part No.	Finish	Eye Inner Diameter (in.)	Eye Outer Diameter (in.)	Bolt Hole Size (in.)	M.G.T.W. (lbs)	M.V.L. (lbs)	Wt. (lbs.)
BDB125015	Powder-Coat	2.50	5.50	5/8	42,000	7,000	17.1
BDB1385	Powder-Coat	3.00	6.25	3/4	60,000	15,000	19.48
BDB13850Z	Zinc Plated	3.00	6.25	3/4	60,000	15,000	19.48
BDB1394	Powder-Coat	3.00	6.25	7/8	100,000	20,000	20

BOLT-ON FORGED STEEL DRAWBAR

- Forged steel construction
- Adjustable bolt pattern accommodates a variety of towing applications



BDB12281

Part No.	Finish	Eye Inner Diameter (in.)	Eye Outer Diameter (in.)	M.G.T.W. (lbs)	M.V.L. (lbs)	Drawbar Section (in.)	Wt. (lbs.)
BDB12281	Powder-Coat	2.5	5.50	20,000	4,000	1.25 X 1.5	20.25
BDB1238	Powder-Coat	3.0	6.25	22,000	4,500	1.625	27

Accessories:

Part No.	Description	Wt.(lbs.)
3013872	Drawbar Wear Gauge	0.98

FORGED ALLOY STEEL DRAWBAR WITH NUT

- Alloy steel construction
- Can be used off-road with a swivel pintle hook
- Includes castle nut, cotter pin and washer



BDB12503

Part No.	Finish	Eye Inner Diameter (in.)	Eye Outer Diameter (in.)	M.G.T.W. (lbs)	M.V.L. (lbs)	Drawbar Section (in.)	Wt. (lbs.)
BDB12503	Powder-Coat	2.5	5.50	15,000	3,000	1.25 X 1.50	9
BDB12492H	Powder-Coat	3.0	6.25	45,000	9,000	1.625	16

Accessories:

Part No.	Description	Wt.(lbs.)
3013872	Drawbar Wear Gauge	0.98



ADJUSTABLE DRAWBARS AND LUNETTE EYES

10 TON ADJUSTABLE LUNETTE EYES

- Forged steel eye and one-piece 1/2 in. formed steel channel
- Adds flexibility in tow eye height for leveling your trailer
- Includes 2 mounting gussets



B20143



B20145

Part No.	Position	Finish	Eye Inner Diameter (in.)	Eye Outer Diameter (in.)	M.G.T.W. (lbs)	M.V.L. (lbs)	Wt. (lbs.)
B20143	3 Position	Plain	3.0	6.25	20,000	2,000	21.5
B20145	5 Position	Plain	3.0	6.25	20,000	2,000	25.5

Accessories:

Part No.	Description	Wt.(lbs.)
B9021	Heavy-Duty Bolt and Nut Kit for 3 or 5 Position Heavy-Duty Channel	1

CHANNEL STYLE LUNETTE EYES

- Forged steel construction
- Available in plain finish, corrosion-resistant, zinc-plated finish, or black finish



B16140

Part No.	Finish	Eye Inner Diameter (in.)	Eye Outer Diameter (in.)	M.G.T.W. (lbs)	M.V.L. (lbs)	Drawbar Section (in.)	Wt. (lbs.)
B16140	Plain	3.00	6.25	20,000	2,000	1.625	12
B16140Z	Zinc Plated Clear	3.00	6.25	20,000	2,000	1.625	12.3
B16140BK	Powder-Coat	3.00	6.25	20,000	2,000	1.625	0
B16145	Plain	3.00	6.25	25,000	3,000	1.625	12.47

Accessories:

Part No.	Description	Wt.(lbs.)
3013872	Drawbar Wear Gauge	0.98

5/16 INCH FORMED STEEL 3 AND 5 POSITION CHANNELS

- Weld-on gussets included for B8979
- Bolt and nut kit sold separately



B8978



B8979

Part No.	Position	Finish	Gussets	Wt. (lbs.)
B8978	3 Position	Plain	–	3.8
B8979	5 Position	Plain	2	7.25

Accessories:

Part No.	Description	Wt.(lbs.)
B9020	Bolt and Nut Kit for 3 or 5 Position Channel	1

1/2 INCH FORMED STEEL 3 AND 5 POSITION CHANNELS

- Used with B20143 (B9909) and B20145 (B9912, B99121)
- Weld-on gussets included for B9909 and B9912
- Bolt and nut kit sold separately



B9909



B9912

Part No.	Position	Finish	Gussets	Wt. (lbs.)
B9909	3 Position	Plain	2	8.07
B9912	5 Position	Plain	2	12.27
B99121	5 Position	Plain	–	11.32

Accessories:

Part No.	Description	Wt.(lbs.)
B9021	Heavy-Duty Bolt and Nut Kit for 3 or 5 Position Heavy-Duty Channel	1

Couplers

ADJUSTABLE COUPLERS

ADJUSTABLE CAST STEEL COUPLERS WITH 3 POSITION CHANNEL

- Plain finish
- 1/2 in. formed steel channel
- Fasteners included



0091553

Part No.	Ball Diameter (in.)	Finish	Channel Width (in.)	M.G.T.W. (lbs)	Class	Wt. (lbs.)
0091543	2	Plain	2.94	10,000	Class IV	22.4
0091553	2-5/16	Plain	2.94	15,000	Class V	21.5

ADJUSTABLE CAST COUPLER WITH 5 POSITION CHANNEL

- Plain finish
- 1/2 in. formed steel channel with weld gussets
- Fasteners included



0091555

Part No.	Ball Diameter (in.)	Channel Width (in.)	M.G.T.W. (lbs)	Class	Wt. (lbs.)
0091545	2	2.94	10,000	Class IV	27.2
0091555	2-5/16	2.94	15,000	Class V	26.2

ADJUSTABLE CAST STEEL COUPLERS WITHOUT CHANNEL

- Auto engage latch features easy one-hand operation
- Can be used with B9909, B9912, B99121 Mounting Channels and B9021 Hardware



0091540

0091600

Part No.	Ball Diameter (in.)	Finish	Channel Width (in.)	Mount	M.G.T.W. (lbs)	Class	Wt. (lbs.)
0091540	2	Plain	2.94	2-Bolt	10,000	Class IV	13.9
0091550	2-5/16	Plain	2.94	2-Bolt	15,000	Class V	14
0091600	2-5/16	Powder-Coat	2.84	3-Bolt	25,000	Class V	16.22

ADJUSTABLE STAMPED COUPLER **NEW**

- Can be used with B8978, B8979 Mounting Channels and B9020 Hardware



5431905

5431905 Application

Part No.	Ball Diameter	Finish	M.G.T.W.	Class	Wt. (lbs.)
5431905	2-5/16	Powder Coat	14,000	Class V	8.83



ADJUSTABLE COUPLERS - continued

ADJUSTABLE CAST STEEL COUPLER WITH SLEEVE LOCK LATCH **NEW**

- Can be used with B8978, B8979 Mounting Channels and B9020 Hardware



5431700

Part No.	Ball Diameter (in.)	Finish	Channel Width (in.)	Mount	M.G.T.W. (lbs)	Wt. (lbs.)
5431700	2	Powder-Coat	2.88	2-Bolt	7000	9.8

5/16 INCH FORMED STEEL 3 AND 5 POSITION CHANNELS

- Weld-on gussets included for B8979
- Bolt and nut kit sold separately



B8978



B8979

Part No.	Position	Finish	Gussets	Wt. (lbs.)
B8978	3 Position	Plain	-	3.8
B8979	5 Position	Plain	2	7.25

Accessories:

Part No.	Description	Wt.(lbs.)
B9020	Bolt and Nut Kit for 3 or 5 Position Channel	1

1/2 INCH FORMED STEEL 3 AND 5 POSITION CHANNELS

- Used with B20143 (B9909) and B20145 (B9912, B99121)
- Weld-on gussets included for B9909 and B9912
- Bolt and nut kit sold separately



B9909



B9912

Part No.	Position	Finish	Gussets	Wt. (lbs.)
B9909	3 Position	Plain	2	8.07
B9912	5 Position	Plain	2	12.27
B99121	5 Position	Plain	-	11.32

Accessories:

Part No.	Description	Wt.(lbs.)
B9021	Heavy-Duty Bolt and Nut Kit for 3 or 5 Position Heavy-Duty Channel	1

ONE-PIECE COUPLER

ONE-PIECE CAST COUPLER

- Auto-engage latch
- Easy one-hand latch operation
- 4-1/2 in. sq. hole pattern to suit 5/8 in. bolt
- Fits Buyers trailer nose plates TNP716625750 & TNP716750100



0091558

Part No.	Ball Diameter (in.)	Finish	M.G.T.W. (lbs)	Class	Wt. (lbs.)
0091558	2-5/16	Plain	18,000	Class V	12

Couplers

A-FRAME COUPLERS

A-FRAME TRAILER COUPLER

- 50 degree A-Frame design
- Predrilled for round jack mounting



0091091

Part No.	Ball Diameter (in.)	Finish	M.G.T.W. (lbs)	Class	Wt. (lbs.)
0091091	2	Primer	5,000	Class III	6.7
0091097	2-5/16	Primer	10,000	Class IV	8.38

CAST STEEL A-FRAME COUPLER WITH SLEEVE LOCK LATCH **NEW**

- Cast steel with black powder coat finish
- Predrilled for round jack mounting
- Sleeve lock latch



5431800

Part No.	Ball Diameter	Finish	M.G.T.W.	Class	Wt. (lbs.)
5431800	2	Powder Coat	7,000	Class V	14.00
5431805	2-5/16	Powder Coat	15,000	Class V	16.20

CAST A-FRAME STEEL COUPLER

- Black powder-coat finish for corrosion resistance
- 50 degree A-Frame design
- Predrilled for round jack mounting
- Auto engage latch features easy one-hand operation



0091595

Part No.	Ball Diameter (in.)	Finish	M.G.T.W. (lbs)	Class	Wt. (lbs.)
0091595	2-5/16	Powder-Coat	15,000	Class V	25



1802208, 0091097 & 0093500 shown



STRAIGHT TONGUE COUPLERS

STRAIGHT TONGUE COUPLER

- 2 in., 2-1/2 in., or 3 in. channel
- Can be bolted or welded to the trailer frame
- Primered couplers do not have mounting holes



0091050Z



0091061



0091060Z

Part No.	Ball Diameter (in.)	Finish	Bolt Holes	Channel Width (in.)	M.G.T.W. (lbs)	Class	Wt. (lbs.)
0091050	1-7/8	Primer	No	2.00	2,000	Class I	2.56
0091050Z	1-7/8	Zinc Plated Clear	Yes	2.00	2,000	Class I	3
0091052	1-7/8	Zinc Plated Clear	Yes	2.50	2,000	Class I	2.9
0091055	1-7/8	Primer	No	3.00	2,000	Class I	2.66
0091058	2	Primer	No	2.00	3,500	Class II	4
0091060	2	Primer	No	2.50	3,500	Class II	4.38
0091060Z	2	Zinc Plated Clear	Yes	2.50	3,500	Class II	4.38
0091061	2	Primer	No	2.50	3,500	Class II	4.38
0091065	2	Primer	No	3.00	3,500	Class II	4.5

HEAVY DUTY CAST STRAIGHT TONGUE COUPLER

- Clear zinc-plated finish for corrosion resistance
- Cast steel construction
- Auto-engage latch
- 3 in. channel welded to coupler



0091562

Part No.	Ball Diameter (in.)	Finish	Channel Width (in.)	M.G.T.W. (lbs)	Class	Wt. (lbs.)
0091560	2	Zinc Plated Clear	3.00	10,000	Class IV	18.5
0091562	2-5/16	Zinc Plated Clear	3.00	15,000	Class V	18.3

Comparison Chart for Couplers

BUYERS	ATWOOD®	DUTTON-LAINSON®	FULTON®	SHELBY®
0091050	—	940P-1	11200	5128
0091055	—	970P-1	11300	5131
0091058	—	982P-2	22250	5111
0091060	80051	985P-2	22300	5135

Buyers Products is not authorized by nor affiliated with the manufacturer Atwood®, Dutton-Lainson®, Fulton®, or Shelby® products. This information is made available for the convenience of our customers and is not meant to indicate that the product is shipped to/from above companies.

Electrical Components for Towing

TRAILER BRAKE CONTROLLERS

2 AXLE TIME-BASED BRAKE CONTROLLER

- Recommended for light duty trailers with 2 or 4 electric brakes
- Quick connect wire plug
- Automatic and manual trailer braking
- Includes mounting bracket and hardware
- 3-year warranty



BC2A

Part No.	Number of Axles	Control Style	Max Number of Brakes	Wt. (lbs.)
BC2A	2	Time-Based	4	0.6

3 AXLE PROPORTIONAL BRAKE CONTROLLER

- Recommended for medium/heavy duty trailers with 2, 4 or 6 electric trailer brakes
- Quick connect wire plug
- Faster, smoother stopping performance
- Automatic and manual trailer braking
- Includes mounting bracket and hardware
- 5-year warranty



BC3AP

Part No.	Number of Axles	Control Style	Max Number of Brakes	Wt. (lbs.)
BC3AP	3	Proportional	6	0.6

4 AXLE DIGITAL PROPORTIONAL BRAKE CONTROLLER

- Recommended for medium/heavy duty trailers with 2, 4, 6, or 8 electric brakes
- Quick connect wire plug
- Built-in diagnostics display and digital controller with adjustable turn-on power
- Automatic and manual trailer braking
- Includes mounting bracket and hardware
- Lifetime warranty



BC4APD

Part No.	Number of Axles	Control Style	Max Number of Brakes	Wt. (lbs.)
BC4APD	4	Proportional	8	0.7

BRAKE CONTROL WIRING HARNESSES

- Simple plug-in installation
- Connects directly to your factory tow package without cutting, splicing, or taping.



BCHF1

Part No.	Year	Make/Model	Wt. (lbs.)
BCHF1	2005-2007	Ford® Super Duty, E-350, E-450, F-250, F-350, F-450, F-550	0.25

BREAKAWAY SWITCH

- Switch activates electric brakes if emergency cable pulls out
- 48" plastic coated high-strength cable
- Bolt-on zinc plated mounting bracket
- Not a substitute for safety chains
- 6 - 24 volt DC



5422010

5422012

Part No.	Control Style	Wt. (lbs.)
5422010	Breakaway Switch Kit	0.413

Accessories:

Part No.	Description	Wt. (lbs.)
5422012	Pin and Cable Replacement for 5422010	0.1



DIE-CAST ZINC-PLATED TRAILER CONNECTORS

2-WAY, TRUCK-SIDE

- Available in either horizontal or vertical terminal pin configurations
- Suitable for 4-6 gauge wire



TC1002



TC1012

Part No.	Truck Side/Trailer Side	Pin Style	Mounting Type	Wt. (lbs.)
TC1002	Truck Side	2 Round Horizontal	Bolt-On	0.68
TC1012	Truck Side	2 Round Vertical	Bolt-On	0.68

2-WAY, TRAILER-SIDE

- Spring style cable guard helps protect wiring
- Available in either horizontal or vertical terminal pin configurations
- Suitable for 4-6 gauge wire



TC2002



TC2012

Part No.	Truck Side/Trailer Side	Pin Style	Wt. (lbs.)
TC2002	Trailer Side	2 Round Horizontal	0.74
TC2012	Trailer Side	2 Round Vertical	0.79

4-WAY, TRUCK-SIDE



TC1004



TC1004 Open

Part No.	Truck Side/Trailer Side	Pin Style	Mounting Type	Wt. (lbs.)
TC1004	Truck Side	4 Round	Bolt-On	0.33

4-WAY, TRAILER-SIDE



TC2004



TC2004 Back

Part No.	Truck Side/Trailer Side	Pin Style	Wt. (lbs.)
TC2004	Trailer Side	4 Round	0.15

Electrical Components for Towing

DIE-CAST ZINC-PLATED TRAILER CONNECTORS - continued

6-WAY, TRUCK-SIDE



TC1006



TC1006 Open

Part No.	Truck Side/Trailer Side	Pin Style	Mounting Type	Wt. (lbs.)
TC1006	Truck Side	6 Round	Bolt-On	0.34

6-WAY, TRAILER-SIDE

- Spring style cable guard helps protect wiring



TC2006



TC2061

Part No.	Truck Side/Trailer Side	Pin Style	Wt. (lbs.)
TC2006	Trailer Side	6 Round	0.156
TC2061	Trailer Side	6 Round	0.35

7-WAY, TRUCK-SIDE



TC1007



TC1007 Open

Part No.	Truck Side/Trailer Side	Pin Style	Mounting Type	Wt. (lbs.)
TC1007	Truck Side	7 Round	Bolt-On	0.7

7-WAY, TRAILER-SIDE

- Spring-style cable guard helps protect wiring



TC2007

Part No.	Truck Side/Trailer Side	Pin Style	Wt. (lbs.)
TC2007	Trailer Side	7 Round	0.75



NYLON/POLY TRAILER CONNECTORS

- Durable nylon plastic construction
- 7-way RV blade connectors

7-WAY, TRUCK-SIDE



TC1007P



TC1007P Open

Part No.	Truck Side/Trailer Side	Pin Style	Wt. (lbs.)
TC1007P	Truck Side	RV Flat	0.269

7-WAY, TRAILER-SIDE



TC2007P

Part No.	Truck Side/Trailer Side	Pin Style	Wt. (lbs.)
TC2007P	Trailer Side	RV Flat	0.187

STAMPED METAL ZINC-PLATED TRAILER CONNECTORS

- Zinc-plated construction
- 7-way RV blade connectors

7-WAY STAMPED METAL TRAILER CONNECTOR - TRUCK-SIDE



TC1007Z



TC1007Z Open

Part No.	Truck Side/Trailer Side	Pin Style	Wt. (lbs.)
TC1007Z	Truck Side	RV Flat	0.49

7-WAY STAMPED METAL TRAILER CONNECTOR - TRAILER-SIDE



TC2007Z

Part No.	Truck Side/Trailer Side	Pin Style	Wt. (lbs.)
TC2007Z	Trailer Side	RV Flat	0.27

Electrical Components for Towing

TRAILER CONNECTORS AND ADAPTERS

6-WAY TO 4-FLAT TRAILER CONNECTOR ADAPTER



TC2064P Front

TC2064P Back

Part No.	Truck Side/Trailer Side	Pin Style	Wt. (lbs.)
TC2064P	Truck Side	6 Round to 4 Flat	0.1

7-WAY FLAT PIN TRAILER CONNECTOR WITH 96 IN. CABLE

- 96 in. pre-wired cable for easy connection to trailer
- 7-way wire: (2) 10-gauge wires: black & white; (1) 12-gauge wire: blue; (4) 14-gauge wires: brown, green, red, yellow



TC1967P

TC2967P

Part No.	Truck Side/Trailer Side	Pin Style	Wt. (lbs.)
TC1967P	Truck Side	RV Flat	2.69
TC2967P	Trailer Side	RV Flat	2.35

7-WAY FLAT PIN TRAILER CONNECTOR

- Quick plug-and-play OEM design means no cutting or splicing of wires
- TC1770P is retail packaged
- TC1770B is packaged in bulk



TC1770P & TC1770B

TC1770P & TC1770B Back

Part No.	Truck Side/Trailer Side	Pin Style	Wt. (lbs.)
 TC1770P	Truck Side	RV Flat	0.31
TC1770B	Truck Side	RV Flat	0.31

7-WAY DUAL-PLUG TRAILER CONNECTOR

- 7-way RV flat and 4 flat connections
- Prewired 10 in., (4) flat & pigtail ends
- Plastic housing
- Built-in connection latch
- RVI color-coded wiring terminals
- Mounting bracket and hardware included



TC1474P

Part No.	Truck Side/Trailer Side	Pin Style	Wt. (lbs.)
 TC1474P	Truck Side	RV Flat & 4 Flat	1.15



TRAILER CONNECTORS AND ADAPTERS - continued

7-WAY DUAL-PLUG OEM TRAILER CONNECTOR

- 7-way flat pin and 4 flat with OEM connection
- Prewired 8 in. wiring lead
- All mounting hardware included



TC1774P

Part No.	Truck Side/Trailer Side	Pin Style	Wt. (lbs.)
 TC1774P	Truck Side	RV Flat, 4 Flat & OEM	1.15

7-WAY RV BLADE OUTPUT TRAILER CONNECTOR **NEW**

- Connects to truck's OEM trailer connection to provide a 7-way RV blade socket
- 7-way RV connects tail, brake, reverse, turn signals, brakes and auxiliary power
- Dust cover keeps connector clean when not in use
- Wire looms protected
- Fits Ford® F-250, F-350, F-450, 2020+



TC1775P



TC1775P Open

Part No.	Truck Side/Trailer Side	Pin Style	Wt. (lbs.)
 TC1775P	Truck Side	RV Flat & OEM	0.005

7-WAY RV TO 4-FLAT TRAILER CONNECTOR ADAPTER



TC2074P Front

TC2074P Back

Part No.	Truck Side/Trailer Side	Pin Style	Wt. (lbs.)
TC2074P	Truck Side	RV Flat TO 4 Flat	0.19

7-WAY TO 4-FLAT TRAILER CONNECTOR ADAPTER WITH LED TESTER

- Includes a dust cap with built-in LED tester



TC2074T Front

TC2074T Back

Part No.	Truck Side/Trailer Side	Pin Style	Wt. (lbs.)
TC2074T	Truck Side	RV Flat to 4 Flat	0.55

Electrical Components for Towing

TRAILER CONNECTORS AND ADAPTERS - continued

7-WAY ROUND TO 4-PIN FLAT TRAILER CONNECTOR



Part No.	Truck Side/Trailer Side	Pin Style	Wt. (lbs.)
TC2274P	Trailer Side	7 Round to 4 Flat	0.26

7-WAY RV TO 5-FLAT TRAILER CONNECTOR ADAPTER



Part No.	Truck Side/Trailer Side	Pin Style	Wt. (lbs.)
TC2075P	Truck Side	RV Flat to 5 Flat	0.218

7-WAY RV TO 6-WAY TRAILER CONNECTOR ADAPTER



Part No.	Truck Side/Trailer Side	Pin Style	Wt. (lbs.)
TC2076P	Truck Side	RV Flat to 6 Round	0.218

6-WAY ROUND TO 7-WAY FLAT TRAILER CONNECTOR ADAPTER

- Converts vehicle's 6-way round zinc connector to 7-way RV flat connector
- Prewired 3 in. connectors



Part No.	Truck Side/Trailer Side	Pin Style	Wt. (lbs.)
 TC1067P	Truck Side	6 Round to RV Flat	0.8

7-WAY ROUND TO 7-WAY RV FLAT TRAILER CONNECTOR ADAPTER

- Prewired 3 in. connectors



Part No.	Truck Side/Trailer Side	Pin Style	Wt. (lbs.)
TC1077P	Truck Side	7 Round to RV Flat	0.8



TRAILER CONNECTORS AND ADAPTERS - continued

7-WAY TRAILER CONNECTOR BRACKET

- Corrosion-resistant zinc construction
- Pre-drilled for a 7-way flat pin trailer connector



TC107

Part No.	Truck Side/Trailer Side	Wt. (lbs.)
TC107	Truck Side	0.15

4-5-6-WAY TRAILER CONNECTOR BRACKET

- Black powder-coat finish for corrosion resistance
- Pre-drilled for a 4, 5, or 6-way trailer connector



TC1456

Part No.	Truck Side/Trailer Side	Wt. (lbs.)
TC1456	Truck Side	0.2

RUBBER BOOT FOR 4, 5, AND 6-WAY CONNECTOR



TC1046B

Part No.	Truck Side/Trailer Side	Wt. (lbs.)
TC1046B	Truck Side	0.2

RUBBER BOOT FOR 7-WAY CONNECTOR



TC1007B

Part No.	Truck Side/Trailer Side	Wt. (lbs.)
TC1007B	Truck Side	0.0625

48 IN. PRE-WIRED LOOP WITH A 4-WAY FLAT CONNECTOR

- Pre-wired and color-coded cable for easy connection to the truck's wiring
- Ideal for controlling tail lights, turn signals, and brake lights
- Dust cap protects the connectors from dirt and water damage



TC1244

Part No.	Truck Side/Trailer Side	Pin Style	Wt. (lbs.)
TC1244	Truck Side	4 Flat	0.25

HEAVY DUTY TAIL LIGHT CONVERTER

- Easily convert a 3-wire tail light vehicle system to a 2-wire tail light trailer system
- Color-coded wires for easy, worry-free installation
- 6 amp



5423203

Part No.	Truck Side/Trailer Side	Wt. (lbs.)
5423203	Truck Side	0.41

Trailer Jacks

12 VOLT ELECTRIC JACK

- Black powder-coat finish for corrosion resistance
- 31.5 in. travel (27 in. power + 4.5 in. drop foot.)
- 48 in. prewired (7-way RV Type) trailer connector power supply for quick, plug-in operation
- Built-in LED night light and weather-sealed switches
- Bolts on to A-frame coupler
- Manual hand crank backup



0093500



0093500 Application

Part No.	Wind	Capacity	Travel (in.)	Wt. (lbs.)
 0093500	Top Wind	3,500	31.50	25

SIDE-PIN SQUARE JACKS

- Black powder-coat finish for corrosion resistance
- Easy retraction with spring assist
- 4-1/2 in. square outer tubing, 3 in. inner tubing
- 2 grease fittings
- 0091410 does not include handle
- 0091410H includes handle and clip



0091410H



0091405H

Part No.	Wind	Static Capacity (lbs)	Dynamic Capacity	Retracted Length (in.)	Extended Length (in.)	Travel (in.)	Wt. (lbs.)
0091410	Side Wind	12,000	10,000	28.5	54	13	61
0091410H	Side Wind	12,000	10,000	28.5	54	13	64.4

Accessories:

Part No.	Description	Wt.(lbs.)
0091405H	Handle and Clip For Square Jacks	3.4

FRONT-PIN SQUARE JACKS

- Black powder-coat finish for corrosion resistance
- Easy retraction with the spring assist
- 4-1/2 in. square outer tubing, 3 in. inner tubing
- 2 grease fittings
- 0091415 does not include handle
- 0091415H includes handle and clip



0091415H



0091405H

Part No.	Wind	Static Capacity (lbs)	Dynamic Capacity	Retracted Length (in.)	Extended Length (in.)	Travel (in.)	Wt. (lbs.)
0091415	Side Wind	12,000	10,000	28.5	54	13	61
0091415H	Side Wind	12,000	10,000	28.5	54	13	64.4

Accessories:

Part No.	Description	Wt.(lbs.)
0091405H	Handle and Clip For Square Jacks	3.4



SWING-AWAY MARINE JACK

- Corrosion resistant zinc finish
- Bolt-on mounting bracket fits up to 3 in. x 5 in. trailer frame
- 6 in. poly wheel
- Quickly swings up and out of the way for transport
- All mounting hardware included



0091610

Part No.	Wind	Capacity	Retracted Length (in.)	Extended Length (in.)	Travel (in.)	Wt. (lbs.)
0091610	Side Wind	1,000	14.75	24.75	10	14

TOP-WIND SWIVEL JACK

- Black powder coat finish with zinc-plated hardware for corrosion resistance
- Footplate and weld-on mount included



0091205



3005528

Part No.	Wind	Capacity	Retracted Length (in.)	Extended Length (in.)	Travel (in.)	Wt. (lbs.)
0091205	Top Wind	2,000	11	14	10	10.74
0091215	Top Wind	2,000	11	14	15	14.22

Accessories:

Part No.	Description	Wt.(lbs.)
3005528	Tube Mount Assembly	2.44

TOP-WIND JACK WITH SWIVEL MOUNT

- Swivel bracket easily welds onto trailer tongue
- Black powder coat finish with zinc-plated hardware for corrosion resistance



0091210



3005528

Part No.	Wind	Capacity	Retracted Length (in.)	Extended Length (in.)	Travel (in.)	Wt. (lbs.)
0091210	Top Wind	2,000	10.25	20.25	10.00	11.82
0091225	Top Wind	2,000	14.25	29.25	15.00	14.88

Accessories:

Part No.	Description	Wt.(lbs.)
3005528	Tube Mount Assembly	2.44

Trailer Jacks

SIDE-WIND JACK WITH SWIVEL MOUNT

- Weld-on mounting assembly included
- Black powder coat finish with zinc-plated hardware for corrosion resistance



5391211



0091220

Part No.	Wind	Capacity	Retracted Length (in.)	Extended Length (in.)	Travel (in.)	Wt. (lbs.)
5391211	Side Wind	2,000	10.8	20.8	10.00	12.05
0091220	Side Wind	5,000	10.25	20.25	10.00	13.26

Accessories:

Part No.	Description	Wt. (lbs.)
3005528	Tube Mount Assembly	2.44

A-FRAME JACK

- Black powder coat finish with zinc-plated handle for corrosion resistance
- Bolts onto A-frame coupler



0091260 & 0091265



0091261 & 0091266

Part No.	Wind	Capacity	Retracted Length (in.)	Extended Length (in.)	Travel (in.)	Foot	Wt. (lbs.)
0091260	Top Wind	2,000	22.69	27.69	15.00	Yes	12.78
0091261	Top Wind	2,000	22.69	27.69	15.00	No	11.44
0091265	Top Wind	5,000	22.69	27.69	15.00	Yes	12.84
0091266	Top Wind	5,000	22.69	27.69	15.00	No	11.44

Accessories:

Part No.	Description	Wt. (lbs.)
0091269	Foot Base for A-Frame Jacks	1.782

SQUARE DROP-FOOT JACK

- Black powder coat finish with zinc-plated hardware for corrosion resistance
- 2-1/2 in. square tubing



0091310



0091340

Part No.	Wind	Capacity	Retracted Length (in.)	Extended Length (in.)	Travel (in.)	Wt. (lbs.)
0091310	Top Wind	7,000	22.60	51.10	15.38	22
0091340	Side Wind	7,000	25.80	54.30	15.25	23.5

Accessories:

Part No.	Description	Wt. (lbs.)
3006636A	Pin Assembly for 2-1/2in. Drop Foot Jacks	0.35
3005521A	Knob for 0091310 Handle Assembly	0.04
3005525A	Handle Assembly for 0091340 Side Wind Jack	0.982
3006073A	Drop Foot Only for 2-1/2in. Drop Foot Jacks	2.51
3005222A	Handle Assembly for 0091310 (1/2in Screw)	1.05



Cargo Control



Product Shown:
5483005: 30ft. Commercial Grade Ratchet
5483105: 10ft. Spring Retractable Ratchet
B38SP: Stake Pocket with 1/2" D-Ring
1702505: Diamond Tread Aluminum Door Truck Box

D-Rings	122 - 126
Outriggers	127
Rope Rings	128 - 131
Winches	132 - 135
Load Binders	135

Tie Down Hardware	136
Tie Down Straps	137 - 141
E-Track	142 - 145
Tarp Straps	146

D-Rings

1/2 IN. D-RINGS

1/2 INCH FORGED D-RINGS, WELD-ON BRACKET

- Forged from C-1045 steel for durability
- Not approved or intended for overhead use



B38W



B38IW

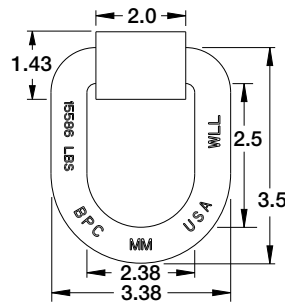

B38W Drawing

Part No.	Ring Dia.(in.)	Inner Width (in.)	Inner Height (in.)	Min Break Strength (lbs)	W.L.L. (lbs)	Made in USA	Wt. (lbs.)
B38W	1/2	2.375	2.50	12,240	4,080	Yes	0.95
B38IW	1/2	2.375	2.50	12,240	4,080	No	1

Accessories:

Part No.	Description	Wt.(lbs.)
B38B	Bolt-On Bracket for B38 D-Rings	0.35
B38BF	Forged Weld-On Bracket for B38 D-Ring	0.35

1/2 INCH FORGED D-RINGS, BOLT-ON BRACKET

- Forged from C-1045 steel for durability
- Not approved or intended for overhead use
- 02040 - Must order in multiples of (5)



B38



B38ZW



B38ZY

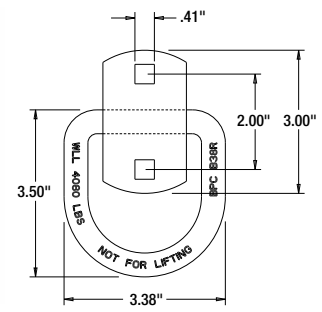

B38 Drawing

Part No.	Finish	Ring Dia.(in.)	Inner Width (in.)	Inner Height (in.)	Min Break Strength (lbs)	W.L.L. (lbs)	Made in USA	Wt. (lbs.)
B38	Plain	1/2	2.375	2.50	12,240	4,080	Yes	1
B38I	Plain	1/2	2.375	2.50	12,240	4,080	No	1
B38ZW	Zinc White	1/2	2.375	2.50	12,240	4,080	No	0.93
B38ZY	Zinc Yellow	1/2	2.375	2.50	12,240	4,080	No	0.93
02040	Yellow Zinc	1/2	2.375	2.50	12,240	4,080	No	1.03

Accessories:

Part No.	Description	Wt.(lbs.)
B38B	Bolt-On Bracket for B38 D-Rings	0.35
B38BF	Forged Weld-On Bracket for B38 D-Ring	0.35



1/2 IN. D-RINGS - continued

1/2 INCH FORGED D-RING



B38R



B38RZW



B38RZY

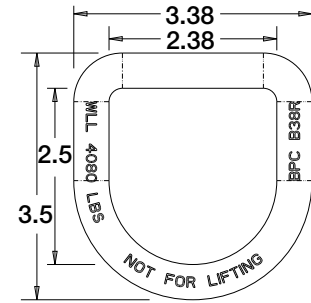

B38R Drawing

Part No.	Finish	Ring Dia.(in.)	Inner Width (in.)	Inner Height (in.)	Min Break Strength (lbs)	W.L.L. (lbs)	Wt. (lbs.)
B38R	Plain	1/2	2.375	2.5	12,240	4,080	0.6
B38RZW	White Zinc	1/2	2.375	2.5	12,240	4,080	0.58
B38RZY	Yellow Zinc	1/2	2.375	2.5	12,240	4,080	0.58

Accessories:

Part No.	Description	Wt.(lbs.)
B38B	Bolt-On Bracket for B38 D-Rings	0.35
B38BF	Forged Weld-On Bracket for B38 D-Ring	0.35

1/2 INCH EXTENDED FORGED D-RING, WELD-ON BRACKET

- Elongated profile can accommodate bulky hooks and chains
- Forged from c-1045 steel for durability
- Not approved or intended for overhead use



B39W

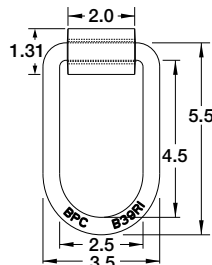

B39W Drawing

Part No.	Ring Dia. (in.)	Inner Width (in.)	Inner Height (in.)	Min Break Strength (lbs)	W.L.L. (lbs)	Wt. (lbs.)
B39W	1/2	2.50	4.50	12,240	4,080	1.205

1/2 INCH FORGED D-RING, SINGLE BOLT MOUNT

- Forged from C-1045 steel for durability
- Not approved or intended for overhead use
- Integral bracket is 1-3/4" wide & 3/8" thick with square mounting hole to accept 3/8" carriage bolts



B38S

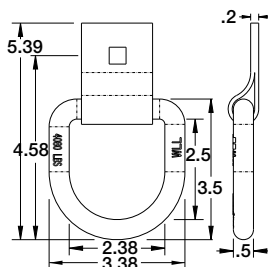

B38S Drawing

Part No.	Ring Dia. (in.)	Inner Width (in.)	Inner Height (in.)	Min Break Strength (lbs)	W.L.L. (lbs)	Wt. (lbs.)
B38S	1/2	2.375	2.50	12,240	4,080	1.14

D-Rings

5/8 IN. D-RINGS

5/8 INCH FORGED D-RINGS, WELD-ON BRACKET

- Strong AISI-1025 construction
- Not approved or intended for overhead use
- 02050 - Must order in multiples of (10)



B40



B40I

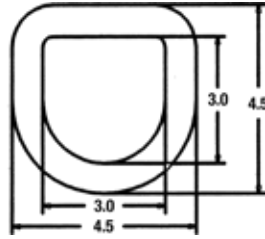

B40 Drawing

Part No.	Ring Dia.(in.)	Inner Width (in.)	Inner Height (in.)	Min Break Strength (lbs)	W.L.L. (lbs)	Made in USA	Wt. (lbs.)
B40	5/8	3.00	3.00	18,390	6,130	Yes	1.84
B40I	5/8	3.00	3.00	18,390	6,130	No	1.84
02050	5/8	3.00	3.00	18,390	6,130	Yes	1.84

Accessories:

Part No.	Description	Wt. (lbs.)
B40BF	Forged Bracket for B40 5/8 Inch D-Ring	0.76

5/8 INCH FORGED D-RING, 6 INCH BOLT-ON PLATE

- Strong forged steel construction
- Four-bolt plate helps spread "pull" force to multiple anchor points
- Includes: D-Ring on plate, 2 backing plates, 4 carriage bolts, 4 nylock nuts
- Not approved or intended for overhead use



B40MP

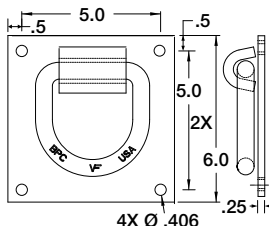

B40MP Drawing

Part No.	Ring Dia.(in.)	Inner Width (in.)	Inner Height (in.)	Wt. (lbs.)
B40MP	5/8	3.00	3.00	8.37

3/4 IN. D-RINGS

3/4 INCH FORGED D-RINGS, WELD-ON BRACKET

- Forged from C-1045 steel for durability
- Not approved or intended for overhead use



B46



B46I

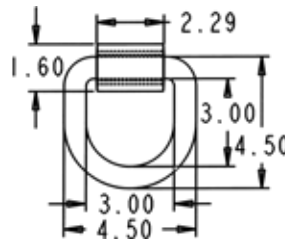

B46 Drawing

Part No.	Ring Dia.(in.)	Inner Width (in.)	Inner Height (in.)	Min Break Strength (lbs)	W.L.L. (lbs)	Made in USA	Wt. (lbs.)
B46	3/4	3.00	3.00	27,360	9,120	Yes	2.17
B46I	3/4	3.00	3.00	27,360	9,120	No	2.5

Accessories:

Part No.	Description	Wt. (lbs.)
B46BF	Forged Mounting Bracket For B46 Forged D-Ring	0.58



1 IN. D-RINGS

1 INCH FORGED D-RINGS, WELD-ON BRACKET

- Forged from C-1045 steel for durability
- Not approved or intended for overhead use



B48



B48I

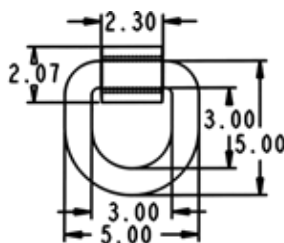

B48 Drawing

Part No.	Ring Dia.(in.)	Inner Width (in.)	Inner Height (in.)	Min Break Strength (lbs)	W.L.L. (lbs)	Made in USA	Wt. (lbs.)
B48	1.00	3.00	3.00	46,758	15,586	Yes	4.11
B48I	1.00	3.00	3.00	46,758	15,586	No	4.45

Accessories:

Part No.	Description	Wt.(lbs.)
B50BF	Forged Bracket to Fit 1 Inch D-Ring	0.97

1 INCH EXTENDED FORGED D-RINGS, WELD-ON BRACKET

- Elongated profile can accommodate bulky hooks and chains
- Forged from C-1045 steel for durability
- Not approved or intended for overhead use



B50



B50I

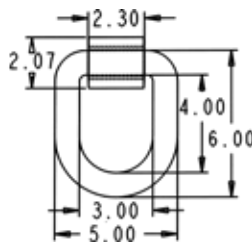

B50 Drawing

Part No.	Ring Dia.(in.)	Inner Width (in.)	Inner Height (in.)	Min Break Strength (lbs)	W.L.L. (lbs)	Made in USA	Wt. (lbs.)
B50	1.00	3.00	4.00	46,758	15,586	Yes	4.75
B50I	1.00	3.00	4.00	46,758	15,586	No	4.65
 O2055	1.00	3.00	4.00	46,760	15,586	Yes	4.79

Accessories:

Part No.	Description	Wt.(lbs.)
B50BF	Forged Bracket to Fit 1 Inch D-Ring	0.97



B50 shown

D-Rings

1 IN. D-RINGS - continued

1 INCH ANGLED FORGED D-RINGS, WELD-ON BRACKET

- 55° bend
- Forged from C-1045 steel for durability
- Not approved or intended for overhead use



B5055



B5055I

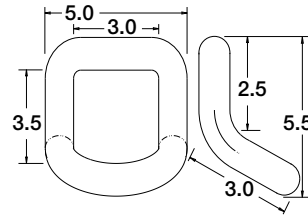

B5055 Drawing

Part No.	Ring Dia.(in.)	Inner Width (in.)	Inner Height (in.)	Min Break Strength (lbs)	W.L.L. (lbs)	Made in USA	Wt. (lbs.)
B5055	1.00	3.00	3.50	46,760	15,586	Yes	4.63
B5055I	1.00	3.00	3.50	46,760	15,586	No	4.63

Accessories:

Part No.	Description	Wt.(lbs.)
B50BF	Forged Bracket to Fit 1 Inch D-Ring	0.97

ROTATING 1 INCH FORGED D-RING

- Rotates 360° for optimum tie down angle
- Includes: Weld-on mounting bracket



B51

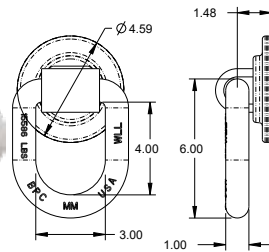

B51 Drawing

Part No.	Ring Dia. (in.)	Inner Width (in.)	Inner Height (in.)	Min Break Strength (lbs)	W.L.L. (lbs)	Wt. (lbs.)
B51	1.00	3.00	4.00	46,758	15,586	7.1

ROTATING ANGLED 1 INCH FORGED D-RING

- Rotates 360° for optimum tie down angle
- 55° bend
- Includes: Weld-on mounting bracket



B52

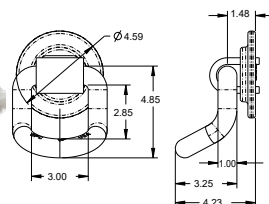

B52 Drawing

Part No.	Ring Dia. (in.)	Inner Width (in.)	Inner Height (in.)	Min Break Strength (lbs)	W.L.L. (lbs)	Wt. (lbs.)
B52	1.00	3.00	3.50	46,758	15,586	7.1



OUTRIGGERS

7 INCH FORGED STEEL REMOVABLE OUTRIGGER

- Forged steel construction
- 7 in. x 14 in.
- Brackets sold Separately



B23506

B23505LH B23505RH & 66053

Part No.	Capacity	Usable Width (in.)	Brackets Included (y/n)	Height (in.)	Finish	Wt. (lbs.)
B23506	6,500	13.38	No	7.00	Plain	8.035

Accessories:

Part No.	Description	Wt. (lbs.)
66053	Yellow Zinc Plated Snapper Pin - 5/16 Diameter x 2-19/32 Inch Usable with Handle	0.11
B23505LH	Left Hand Outrigger Bracket For B23506 Removable Outrigger	3.822
B23505RH	Right Hand Outrigger Bracket For B23506 Removable Outrigger	3.822

8 INCH FORGED STEEL OUTRIGGER

- Forged carbon steel
- Designed to allow for indexing at 90° angles
- 3 locking positions
- 8 in. x 12-1/2 in.
- Includes upper and lower mounting brackets



B23515

Part No.	Capacity	Usable Width (in.)	Brackets Included (y/n)	Height (in.)	Finish	Wt. (lbs.)
B23515	5,000	11.81	Yes	8.00	Plain	19.4

8-1/4 INCH DUCTILE IRON OUTRIGGER

- 100-70-03 cast ductile iron
- Increase trailer width 12 in. per side
- 8-1/4 in. x 12-1/4 in.
- Brackets sold separately



B23510

B23510HDG

B2351001 & B2351002

Part No.	Capacity	Usable Width (in.)	Brackets Included (y/n)	Height (in.)	Finish	Wt. (lbs.)
B23510	5,000	12.375	No	8.25	Plain	9.8
B23510HDG	5,000	12.375	No	8.25	Hot Dipped Galvanized	10.00

Accessories:

Part No.	Description	Wt. (lbs.)
B2351002	Mounting Bracket For B23510 Ductile Iron Outrigger - Welds To Web Of Beam	1.7
B2351001	Mounting Bracket For B23510 Ductile Iron Outrigger - Welds To Flange Of Beam	0.75

Rope Rings

RECESSED MOUNTED ROPE RING

BOLT-ON 1/2 INCH FORGED D-RING WITH RECESSED PAN MOUNT

- Zinc-plated for corrosion resistance

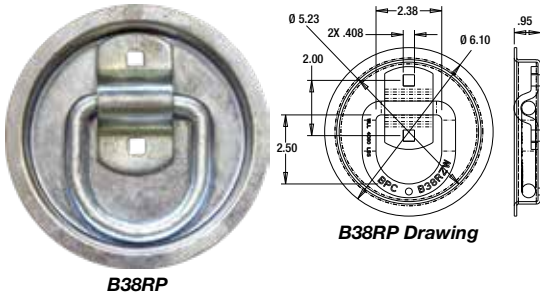

Part No.	Mount Type	Min. Breaking Strength (lbs)	W.L.L. (lbs)	Wt. (lbs.)
B38RP	Recessed	12,240	4,080	1.8

HEAVY DUTY RECESSED ROTATING ROPE RING

- Rotates 360 degrees

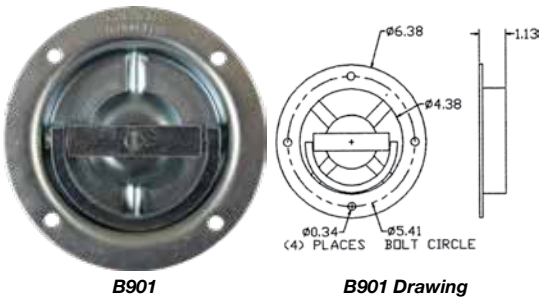

Part No.	Mount Type	Min. Breaking Strength (lbs)	W.L.L. (lbs)	Wt. (lbs.)
B901	Recessed	6,000	2,000	2.5

Accessories:

Part No.	Description	Wt. (lbs.)
901BP	Back Support Plate For B901A Zinc Plated	0.72

HEAVY DUTY RECESSED ROPE RING

- Formed 1/8 in. steel pan houses a ductile iron ring
- 3-5/8 in. diameter hole with 7/8 in. clearance below surface is required

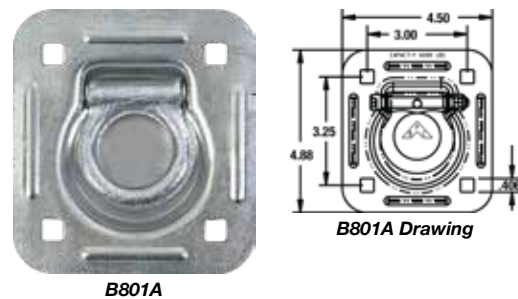

Part No.	Mount Type	Finish	Min. Breaking Strength (lbs)	W.L.L. (lbs)	Wt. (lbs.)
B801	Recessed	Plain	6,000	2,000	1.15
B801A	Recessed	Zinc Plated	6,000	2,000	1.15
B801AK*	Recessed	Zinc Plated	6,000	2,000	2.5
B801SS	Recessed	Stainless Steel	6,000	2,000	1.09

*Kit comes with back support plate and hardware

Accessories:

Part No.	Description	Wt. (lbs.)
801BP	Back Support Plate For B801 Series	0.92



RECESSED ROPE RING

- Zinc-plated for corrosion resistance
- Requires 3 in. diameter mounting hole in 3/8 in. or thicker material
- Not for lifting

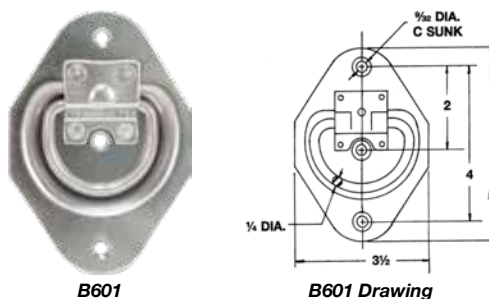

Part No.	Mount Type	Min. Breaking Strength (lbs)	W.L.L. (lbs)	Wt. (lbs.)
B601	Recessed	855	285	0.42



SURFACE MOUNTED ROPE RING

- Variety of finishes available
- Not for lifting
- Zinc-plated for corrosion resistance
- Bolt-on

SURFACE MOUNTED OR RECESSED ROPE RING

- Requires 3 in. diameter mounting hole in 3/8 in. or thicker material
- Choose a recessed or surface installation

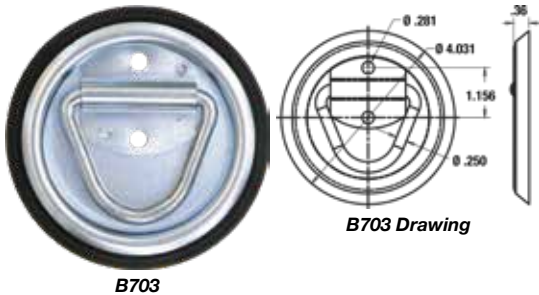

Part No.	Mount Type	Min. Breaking Strength (lbs)	W.L.L. (lbs)	Wt. (lbs.)
B703	Either	795	265	0.35

ROPE RING WITH PLASTIC SURFACE MOUNT

- Plastic pan allows surface mounting

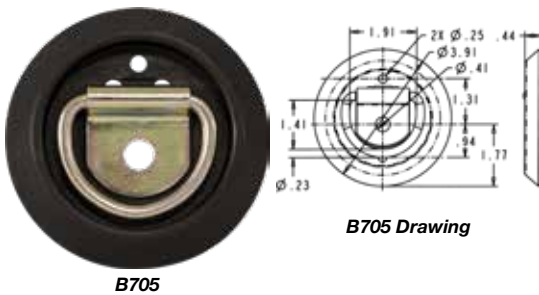

Part No.	Mount Type	Min. Breaking Strength (lbs)	W.L.L. (lbs)	Wt. (lbs.)
B705	Surface	3,000	1,000	0.2

SURFACE MOUNTED ROPE RING

- Requires 3 in. diameter mounting hole in 3/8 in. or thicker material

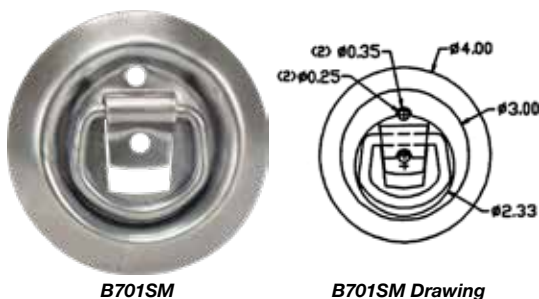

Part No.	Mount Type	Min. Breaking Strength (lbs)	W.L.L. (lbs)	Wt. (lbs.)
B701SM	Surface	795	265	0.28

ROPE RING WITH INTEGRAL BRACKET

- Zinc plated

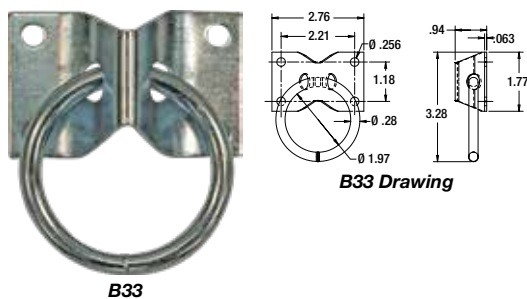

Part No.	Mount Type	Finish	Min. Breaking Strength (lbs)	W.L.L. (lbs)	Wt. (lbs.)
B33	Surface	Zinc Plated	528	176	0.22

Rope Rings

BOLT-ON ROPE RINGS WITH BRACKET

- Variety of finishes available
- Not for lifting
- Includes: Bolt-on mounting bracket

ROPE RING WITH TWO HOLE BRACKET

- Zinc-plated for corrosion resistance
- 1/4 in. dia. steel ring and formed steel clamp
- Bolt-on



B20

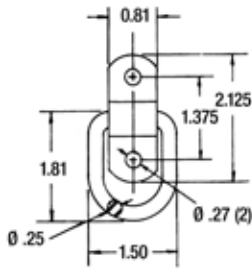

B20 Drawing

Part No.	Mount Type	Min. Breaking Strength (lbs)	W.L.L. (lbs)	Wt. (lbs.)
B20	Surface	2,400	800	0.12

ROPE RING WITH ONE HOLE CLIP

- Black zinc-plated for corrosion resistance
- 1/4 in. dia. steel ring
- Bolt-on



B21

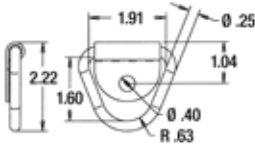

B21 Drawing

Part No.	Mount Type	Min. Breaking Strength (lbs)	W.L.L. (lbs)	Wt. (lbs.)
B21	Surface	2,400	800	0.15

LIGHT DUTY ROPE RING

- Features a welded D-ring and a 14 Ga steel clip



B23

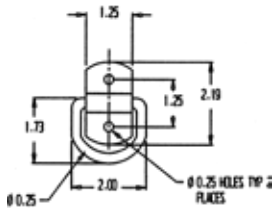

B23 Drawing

Part No.	Mount Type	Material	Finish	Min. Breaking Strength (lbs)	W.L.L. (lbs)	Wt. (lbs.)
B23	Surface	Steel	Zinc	1,200	400	0.12
B23SS	Surface	Stainless Steel	Plain	1,200	400	0.13

ROPE RING WITH BRACKET

- Zinc-plated for corrosion resistance
- Bolt-on



B32F

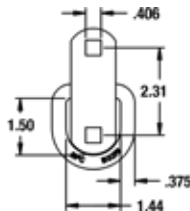

B32F Drawing

Part No.	Mount Type	Min. Breaking Strength (lbs)	W.L.L. (lbs)	Wt. (lbs.)
B32F	Surface	6,000	2,000	0.42



WELD-ON ROPE RINGS

- Variety of finishes available
- Not for lifting

ROPE RING

- Zinc-plated for corrosion resistance
- 3/8 in. diameter steel ring
- Includes weld-on mounting bracket (plain finish)



Part No.	Mount Type	Min. Breaking Strength (lbs)	W.L.L. (lbs)	Wt. (lbs.)
B28F	Weld-On	6,000	2,000	0.5

CAST ALUMINUM CHAIN LOOP

- Cast aluminum, 1/2 in. diameter
- Width of opening is 2.09 in.
- Depth of opening is 1.75 in.
- .44 in. diameter mounting holes
- Do not use for lifting

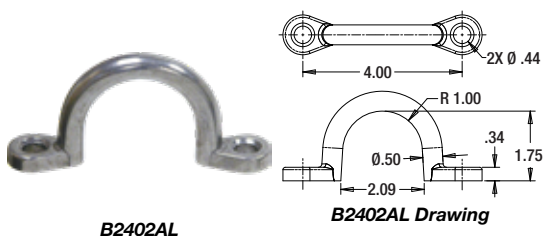

Part No.	Mount Type	Wt. (lbs.)
B2402AL	Surface	0.15

STAKE POCKET D-RINGS

STAKE POCKET WITH 1/2 INCH D-RING

- Fits common flush and outside stake pockets
- Provides convenient tie point for chains or straps
- Black powder-coat finish for corrosion resistance
- 2-Position adjustable height with 1/2 in. hitch pin
- D-rings are not approved for overhead use
- Includes 1/2 in. hitch pin with cotter pin

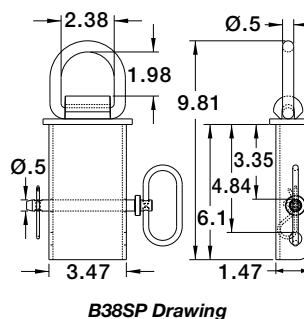

Part No.	Ring Dia.(in.)	Inner Width (in.)	Inner Height (in.)	W.L.L. (lbs)	Wt. (lbs.)
B38SP	1/2	2-3/8	2-1/2	4,080	3.8

Winches

WELD-ON TRAILER WINCH

- Steel construction with a corrosion-resistant black powder coat finish
- Fully slotted mandrel for easy threading of straps
- 8.00"L x 3.50"W x 6.25"H



1903005



1903005LH

Part No.	For Use With Strap Width (in.)	Mounting Style	W.L.L. (lbs)	Strap Included (Y/N)	Wt. (lbs.)
1903005	4.00	Weld-On	5,500	No	9
1903005LH	4.00	Weld-On	5,500	No	8.1

BOLT-ON TRAILER WINCH

- Steel construction with a corrosion-resistant black powder coat finish
- Can be positioned anywhere on a trailer's side channel
- Fully slotted mandrel for easy threading of straps
- 8.00"L x 3.50"W x 6.25"H



1903020

Part No.	For Use With Strap Width (in.)	Mounting Style	W.L.L. (lbs)	Strap Included (Y/N)	Wt. (lbs.)
1903020	4.00	Bolt-On	5,500	No	9.08

SLIDING TRAILER WINCH

- Works with standard sliding winch tracks for easy installation
- 1903030: 7.75"L x 4.00"W x 7.00"H standard sliding winch
- 1903035: 7.75"L x 4.50"W x 7.50"H deep sliding winch for longer straps



1903030

Part No.	For Use With Strap Width (in.)	Mounting Style	W.L.L. (lbs)	Strap Included (Y/N)	Wt. (lbs.)
1903030	4.00	Sliding	6,000	No	10.5
1903035	4.00	Sliding	6,000	No	11.5



SLIDING WINCH TRACK

- 1/4 in. formed steel (1903040)
- 6063-T5 extruded aluminum winch track (1903045)
- Mill finish
- Accommodates 4 in. standard and 4 in. deep sliding winches
- Works with 1903030, 1903035



1903040



1903045 shown with 1903030 winch & 1903070 strap

Part No.	Material	Finish	Length (in.)	Wt. (lbs.)
1903040	Carbon Steel	Plain	72	39
1903045	Aluminum	Plain	72	18.41

4 INCH WINCH STRAP

- Hook is zinc-plated for corrosion resistance
- Designed to work with bed and trailer deck winches
- Weather-resistant cargo strap provides minimum stretch and maximum wear resistance



1903070



1903085 Application

Part No.	Working Load Limit	Capacity	Width (in.)	Length (ft)	Wt. (lbs.)
1903070	5,000	15,000	4.00	27	4.64
1903085	5,000	15,000	4.00	30	5

WINCH BAR

- Black powder-coat finish for corrosion resistance
- Tighten and release with minimal effort
- For use with steel trailer winches



1903060

Part No.	Length (in.)	Finish	Material	Wt. (lbs.)
1903060	35.00	Powder-Coat	Carbon Steel	5.3

COMBINATION WINCH BAR

- Black powder-coat finish for corrosion resistance
- Tighten and release with minimal effort
- For use with steel trailer winches, an additional fitting allows it to provide extra leverage for the forged load binder



1903065

Part No.	Length (in.)	Finish	Material	Wt. (lbs.)
1903065	40.00	Powder-Coat	Carbon Steel	6.56

Winches

LASHING WINCH

- Works with 2 in. wide webbing straps (not included)
- Welds or bolts to your truck or trailer
- Easy tension control with pry bar or hex drive (1 1/8 in. socket size)
- 6.22 in. W x 3.56 in. D x 4.00 in. H

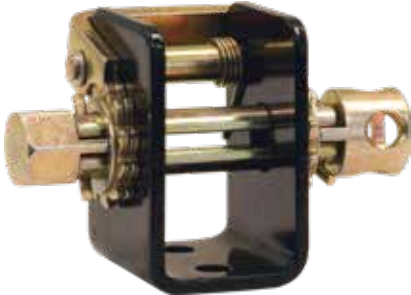

5482100

Part No.	For Use With Strap Width (in.)	Mounting Style	Minimum Breaking Strength (lbs)	W.L.L. (lbs)	Strap Included (Y/N)	Wt. (lbs.)
 5482100	2.00	Bolt-On/Weld-On	10,000	3,333	No	4

STAKE POCKET LASHING WINCH **NEW**

- Steel construction with a corrosion-resistant black powder coat finish
- Works with 2 in. wide webbing straps (not included)
- Easy tension control with pry bar or hex drive (1 1/8 in. socket size)
- Fits conveniently in common flush and outside stake body pockets
- 2-Position adjustable height stake pocket post
- 6.22 in. W x 3.56 in. D x 10.31 in. H



5482105

Part No.	For Use With Strap Width (in.)	Mounting Style	Minimum Breaking Strength (lbs)	W.L.L. (lbs)	Strap Included (Y/N)	Wt. (lbs.)
5482105	2.00	Stake Pocket	10,000	3,333	No	7.1

2 INCH WINCH STRAP **NEW**

- Hook is zinc-plated for corrosion resistance
- Designed to work with bed, stake pocket and trailer deck winches
- Weather-resistant cargo strap provides minimum stretch and maximum wear resistance



5482030



5482031

Part No.	Hook Type	Working Load Limit	Capacity	Width (in.)	Length (ft)	Wt. (lbs.)
5482030	Double J	3,300	10,000	2.00	30	
5482031	Flat	3,300	10,000	2.00	30	



HAND WINCH

- (1) 26.00 ft. L x 1.5 in. W nylon strap with slip hook
- Ideal for horizontal pulling applications with a gear ratio of 4.4:1
- 7.00 in. L handle
- 6.00 in. L x 3.25 in. W x 3.00 in. H



HW800S

Part No.	For Use With Strap Width (in.)	Mounting Style	Minimum Breaking Strength (lbs)	W.L.L. (lbs)	Strap Included (Y/N)	Wt. (lbs.)
 HW800S	1.50	In-Line	2,400	800	Yes	4.97

LOAD BINDERS

- Red powder-coat finish for corrosion resistance
- Forged hooks and cast steel handle

RATCHETING LOAD BINDER

- Red powder-coat finish
- Forged hooks and cast steel handle
- Double acting ratchet



RLB3812

Part No.	Chain Size (in.)	Minimum Breaking Strength (lbs)	W.L.L. (lbs)	Wt. (lbs.)
RLB5638	5/16-3/8	23,100	6,600	10.5
RLB3812	3/8-1/2	33,000	9,200	13.5

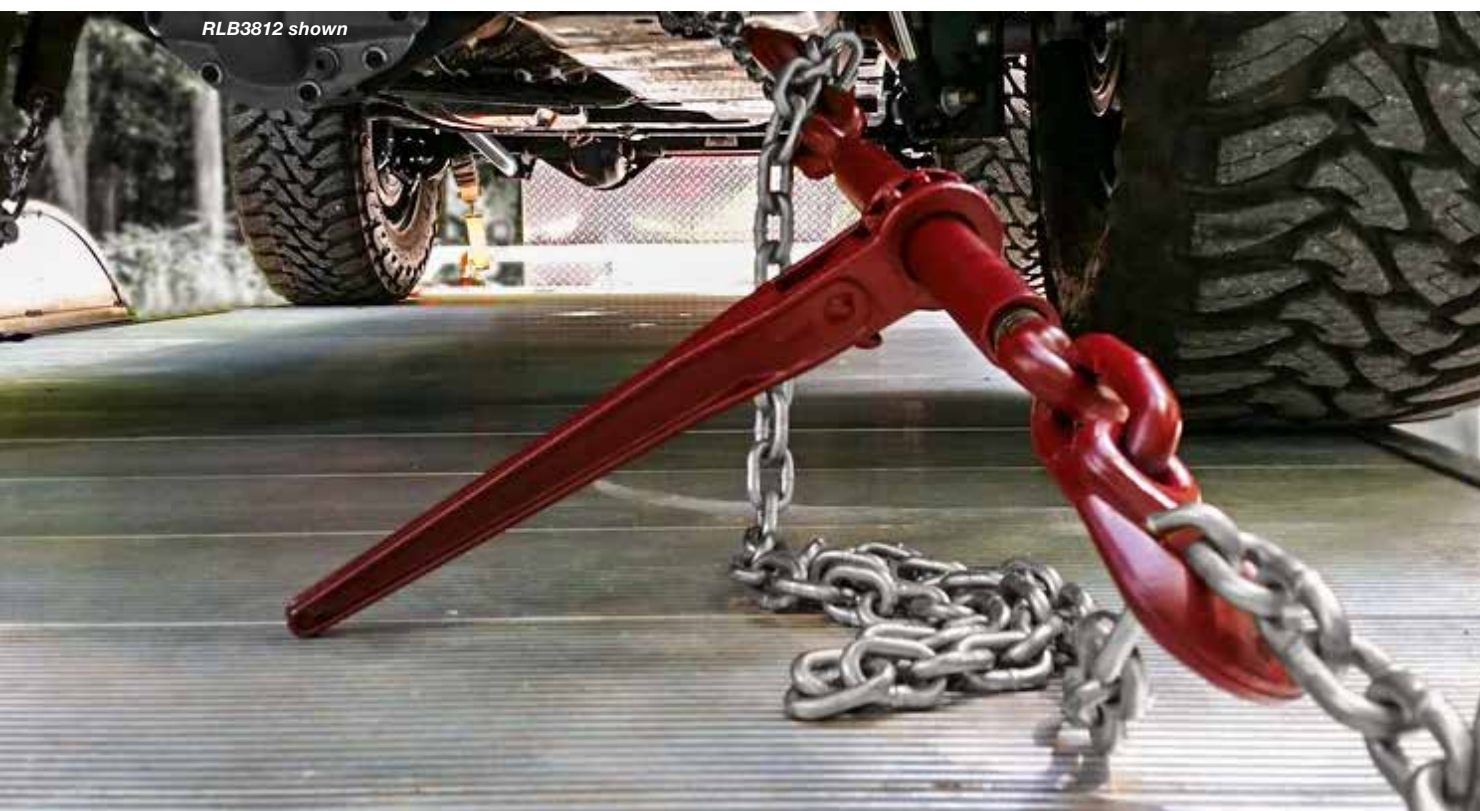

Tie Down Hardware

TRAILER BED CHAIN TIE DOWN **NEW**

- Provides a sturdy anchor point on your flatbed floor
- Sits flush with floor
- 2.30 in. x .188 in. Cap
- Yellow zinc plated .375 in., 6-link Grade 70 chain
- Welds to crossmembers or side rails under floor of flatbed



1901006



1901006 Application

Part No.	W.L.L. (lbs)	Material	Finish	Wt. (lbs.)
1901006	6,600	Carbon Steel	Powder-Coat	3.6

FORGED RECEIVER MOUNT TOW EYE

- Corrosion-resistant black powder coat finish
- Forged steel construction
- Handles straight-line towing up to 12,000 lb.



RM1225E

Part No.	Mount Type	Material	Receiver Tube Size (in.)	Finish	Capacity (lbs)	Mounting Hole Diameter (in.)	Eye Inner Diameter (in.)	Eye Outer Diameter	Wt. (lbs.)
RM1225E	2" Receiver	Forged Steel	2.0	Powder-Coat	12,000	0.656	2.5	5.0	9.2

ANCHOR SHACKLES FOR HITCH RECEIVERS **NEW**

- Receiver hitch mount for recovery towing purposes
- Order (3) of the same part number and retail cut-case box will be included



1804025



1804025 Application

Part No.	Mount Type	Material	Receiver Tube Size (in.)	Finish	Capacity (lbs)	Wt. (lbs.)
1804020	Hitch Receiver	Carbon Steel	2	Powder-Coat	10,000	10.1
1804025	Hitch Receiver	Carbon Steel	2-1/2	Powder-Coat	13,000	16.5
1804040	Hitch Receiver	Carbon Steel	3	Powder-Coat	18,000	20.7

3/8 INCH GALVANIZED ANCHOR SHACKLE

- Galvanized finish
- Attach chains to D-rings without a hook
- Includes screw pin to hold chain in place



5480375

Part No.	W.L.L. (lbs)	Material	Finish	Wt. (lbs.)
5480375	2,000	Carbon Steel	Galvanized	0.33



RATCHET STRAPS

10 FOOT CAMBUCKLE TIE DOWN - 4 PACK

- Clear zinc plated for corrosion resistance
- Ideal for securing lighter cargo
- Vinyl coated steel S-hooks



5483305



5483305 Packaging

Part No.	Length (ft)	Width (in.)	Break Strength (lbs)	W.L.L. (lbs)	Hook Type	Pack Quantity	Wt. (lbs.)
 5483305	10.00	1.00	900	300	S-Hooks	4	3.27

6 FOOT SPRING RETRACTABLE RATCHET TIE DOWN - 2 PACK

- Clear zinc plated for corrosion resistance
- Strap spring retracts for tangle-free storage
- Vinyl coated steel s-hooks
- Rubber grip handle



5483220



5483220 Packaging

Part No.	Length (ft)	Width (in.)	Break Strength (lbs)	W.L.L. (lbs)	Hook Type	Pack Quantity	Wt. (lbs.)
 5483220	6.00	1.00	1,500	500	S-Hooks	2	2.65

12 FOOT RATCHET TIE DOWN - 2 PACK

- Yellow zinc plated for corrosion resistance
- Vinyl coated steel s-hooks
- Rubber grip handle



RTD211218



RTD211218 Packaging

Part No.	Length (ft)	Width (in.)	Break Strength (lbs)	W.L.L. (lbs)	Hook Type	Pack Quantity	Wt. (lbs.)
 RTD211218	12.00	1.00	1,800	600	S-Hook	2	2.53

12 FOOT RATCHET TIE DOWN - 4 PACK

- Clear zinc plated for corrosion resistance
- Vinyl coated steel s-hooks
- Rubber grip handle



5483215



5483215 Packaging

Part No.	Length (ft)	Width (in.)	Break Strength (lbs)	W.L.L. (lbs)	Hook Type	Pack Quantity	Wt. (lbs.)
 5483215	12.00	1.00	1,800	600	S-Hooks	4	4.25

Tie Down Straps

RATCHET STRAPS - continued

14 FOOT RATCHET TIE DOWN - 4 PACK

- Clear zinc plated for corrosion resistance
- Vinyl coated steel s-hooks with spring keepers
- Rubber grip handle



5483100



5483100 Packaging

Part No.	Length (ft)	Width (in.)	Break Strength (lbs)	W.L.L. (lbs)	Hook Type	Pack Quantity	Wt. (lbs.)
 5483100	14.00	1.00	3,000	1,000	S Keeper Style	4	6.85

10 FOOT SPRING RETRACTABLE RATCHET TIE DOWN

- Zinc plated hardware for corrosion resistance
- Vinyl coated steel -s-hooks
- Bolt-on design
- Ratchet automatically retracts for tangle-free storage when not in use
- Rubber grip handle
- 8.00 ft retractable strap + 2.00 ft bolt on extension



5483105



5483105CC

Part No.	Length (ft)	Width (in.)	Break Strength (lbs)	W.L.L. (lbs)	Hook Type	Pack Quantity	Wt. (lbs.)
5483105	10.00	2.00	3,000	1,000	S-Hook	1	3.69
 5483105CC*	10.00	2.00	3,000	1,000	S-Hook	4	14.76

*5483105CC comes in a 4-pack retail cut case

8 FOOT SPRING RETRACTABLE RATCHET TIE DOWN **NEW**

- Zinc plated hardware for corrosion resistance
- Double J-hooks
- Bolt-on design
- Ratchet automatically retracts for tangle-free storage when not in use
- Rubber grip handle



5483106



5483106CC

Part No.	Length (ft)	Width (in.)	Break Strength (lbs)	W.L.L. (lbs)	Hook Type	Pack Quantity	Wt. (lbs.)
5483106	8.00	2.00	3,000	1,000	Double J Hook	1	5.39
 5483106CC*	8.00	2.00	3,000	1,000	Double J Hook	4	21.56

*5483106CC comes in a 4-pack retail cut case



RATCHET STRAPS - continued

30 FOOT COMMERCIAL GRADE RATCHET TIE DOWN WITH FLAT HOOKS

- Clear zinc plated for corrosion resistance
- High strength polyester strap for long-lasting durability
- Rubber grip handle
- Flat hooks



5483005



5483005CC

Part No.	Length (ft)	Width (in.)	Break Strength (lbs)	W.L.L. (lbs)	Hook Type	Pack Quantity	Wt. (lbs.)
5483005	30.00	2.00	10,000	3,300	Flat Hooks	1	5.15
 5483005CC*	30.00	2.00	10,000	3,300	Flat Hooks	4	20.6

*5483005CC comes in a 4-pack retail cut case

30 FOOT COMMERCIAL GRADE RATCHET TIE DOWN WITH DOUBLE J-HOOKS

- Clear zinc plated for corrosion resistance
- High strength polyester strap for long-lasting durability
- Rubber grip handle
- Double J-Hooks



5483000



5483000CC

Part No.	Length (ft)	Width (in.)	Break Strength (lbs)	W.L.L. (lbs)	Hook Type	Pack Quantity	Wt. (lbs.)
5483000	30.00	2.00	10,000	3,300	Double J	1	5.05
 5483000CC*	30.00	2.00	10,000	3,300	Double J	4	20.2

*5483000CC comes in a 4-pack retail cut case

27 FOOT COMMERCIAL GRADE RATCHET TIE DOWN WITH FLAT HOOKS

- Yellow zinc plated for corrosion resistance
- High strength polyester strap for long-lasting durability
- Flat hooks



RS132715F

Part No.	Length (ft)	Width (in.)	Break Strength (lbs)	W.L.L. (lbs)	Hook Type	Pack Quantity	Wt. (lbs.)
RS132715F	27.00	3.00	15,000	5,000	Flat	1	12

27 FOOT COMMERCIAL GRADE RATCHET TIE DOWN WITH DOUBLE J-HOOKS

- Yellow zinc plated for corrosion resistance
- High strength polyester strap for long-lasting durability
- Double J-Hooks



5483027

Part No.	Length (ft)	Width (in.)	Break Strength (lbs)	W.L.L. (lbs)	Hook Type	Pack Quantity	Wt. (lbs.)
5483027	27.00	3.00	15,000	5,000	Double J	1	12

Tie Down Straps

1-1/2 INCH LADDER RACK RATCHET TIE DOWNS

1-1/2 INCH RATCHET TIE DOWNS FOR ROUND TUBE LADDER RACKS

- Black powder-coated steel mount (5480007)
- 304 stainless steel mount (5480008)
- Rolled steel bracket fits ladder racks with popular 1-7/8 in. - 2 in. OD round tubing
- Fits Buyers ladder racks: 1501150, 1501153, 1501250, 1501260 and 1501270
- Includes hardware
- 2 per pack



5480007



5480008

Part No.	Length (ft)	Width (in.)	Break Strength (lbs.)	W.L.L. (lbs.)	Hook Type	Pack Quantity	Material	Wt. (lbs.)
5480007	7	1-1/2	1,500	500	Double J	2	Carbon Steel	7.83
5480008	7	1-1/2	1,500	500	Double J	2	Stainless Steel	7.785

Accessories:

Part No.	Description	Wt. (lbs.)
3028819	Replacement Strap/Prybar For 5480005, 5480006, 5480007, 5480008 Ladder Rack Ratchet Tie Downs	1.17

1-1/2 INCH RATCHET TIE DOWNS FOR SQUARE AND RECTANGULAR TUBE LADDER RACKS

- Black powder-coated steel mount for corrosion resistance (5480005)
- 304 stainless steel mount corrosion resistance (5480006)
- Add convenient, permanent securing points to a ladder rack with square or rectangular tubing
- Mounting surface 1-1/2 in. angle
- Includes hardware
- 2 per pack



5480005



5480006

Part No.	Length (ft)	Width (in.)	Break Strength (lbs.)	W.L.L. (lbs.)	Hook Type	Pack Quantity	Material	Wt. (lbs.)
5480005	7	1-1/2	1,500	500	Double J	2	Carbon Steel	8
5480006	7	1-1/2	1,500	500	Double J	2	Stainless Steel	8.19

Accessories:

Part No.	Description	Wt. (lbs.)
3028819	Replacement Strap/Prybar For 5480005, 5480006, 5480007, 5480008 Ladder Rack Ratchet Tie Downs	1.17

1-1/2 INCH RATCHET TIE DOWNS FOR PICKUP TRUCK LADDER RACKS

- Add convenient, permanent securing points to a truck ladder rack
- Fits Buyers extruded aluminum pickup truck ladder racks 1501400, 1501410, 1501675, 1501680
- Includes hardware



1501416



1501416 installed on pickup truck ladder rack

Part No.	Mount Material	Length (ft)	Width (in.)	Break Strength (lbs.)	W.L.L. (lbs.)	Hook Type	Pack Quantity	Wt. (lbs.)
1501416	Black Powder-Coat Steel	7	1-1/2	1,500	500	Double J	1	5.63

1-1/2 INCH RATCHET TIE DOWNS FOR VAN LADDER RACKS

- Add convenient, permanent securing points to a van ladder rack with square or rectangular tubing
- Fits Buyers 1501311 van ladder rack
- Includes hardware



1501312



1501312 installed on van ladder rack

Part No.	Mount Material	Length (ft)	Width (in.)	Break Strength (lbs.)	W.L.L. (lbs.)	Hook Type	Pack Quantity	Wt. (lbs.)
1501312	Black Powder-Coat Steel	7	1-1/2	1,500	500	Double J	1	5.22



2 INCH LADDER RACK RATCHET TIE DOWNS

SPRING RETRACTING TIE DOWNS FOR ROUND TUBE LADDER RACKS **NEW**

- Black powder-coated steel mount for corrosion resistance
- Formed c-channel steel bracket fits ladder racks with popular 1-7/8 in. - 2 in. OD round tubing
- Ratchet spring retracts for tangle-free storage when not in use
- Fits Buyers Ladder Racks: 1501150, 1501153, 1501250, 1501260 & 1501270
- Includes hardware
- 2 per pack



5480017

Part No.	Length (ft)	Width (in.)	Break Strength		Hook Type	Pack Quantity	Material	Wt. (lbs.)
			(lbs.)	W.L.L. (lbs.)				
5480017	8	2	3,000	1,000	Double J	2	Polyester	15.57

SPRING RETRACTING TIE DOWNS FOR SQUARE AND RECTANGULAR TUBE LADDER RACKS **NEW**

- Black powder-coated steel mount for corrosion resistance
- Add convenient, permanent securing points to a ladder rack with square or rectangular tubing
- Ratchet spring retracts for tangle-free storage when not in use
- Includes hardware
- 2 per pack



5480015

Part No.	Length (ft)	Width (in.)	Break Strength		Hook Type	Pack Quantity	Material	Wt. (lbs.)
			(lbs.)	W.L.L. (lbs.)				
5480015	8	2	3,000	1,000	Double J	2	Polyester	14.92

5480015 shown



E-Track

E-TRACK AND SUPER TRACK

STEEL E-TRACK

- Corrosion-resistant grey powder coat finish
- Provides convenient tie down points for securing cargo
- Ideal for wall or floor mounting
- Constructed of 12 gauge steel
- Hardware not included



1903050

Part No.	Length (ft)	Material	Finish	Color	Pre-Drilled Holes	Wt. (lbs.)
1903055	5	Carbon Steel	Powder Coat	Grey	Yes	7.69
1903050	10	Carbon Steel	Powder Coat	Grey	Yes	16.50

ALUMINUM E-TRACK **NEW**

- .10 in. thick 6063-T5 aluminum construction
- Ideal for wall or floor mounting



1903110

Part No.	Length (ft)	Material	Finish	Pre-Drilled Holes	Wt. (lbs.)
1903110	10	Aluminum	Plain	No	6.40

SUPER TRACK STARTER KIT

- Adjustable ring placement
- Ideal for pickups, vans and enclosed trailers
- Eight 1.0 in. I.D. anchor rings included
- Made of durable anodized extruded aluminum
- Includes (4) 46-1/2 in. anodized extruded aluminum tracks and (8) rings
- (2) 46-1/2 in. fits 8 ft pickups



ST93



LR1

Part No.	Length (ft)	Material	Finish	Color	Pack Quantity	Wt. (lbs.)
ST93	3.875	Aluminum	Anodized	Clear	4	7.85

Accessories:

Part No.	Description	Wt. (lbs.)
LR1	Load Ring For Super Track	0.10

E-TRACK HARDWARE

E-TRACK ROPE RING

- Provides a secure and easy attachment point for tie downs
- Heavy duty steel construction
- Zinc plated for corrosion resistance



01090

Part No.	Hook Type	Finish	Inner Dimension/ Dia. (in.)	Minimum Breaking Strength (lbs)	W.L.L. (lbs)	Wt. (lbs.)
01090	Rope Ring	Zinc Plated	1.31	6,000	2,000	0.52



E-TRACK HARDWARE - continued

E-TRACK CURVED J-HOOK

- Corrosion resistant white powder-coated finish
- The steel hook is .5 in. thick, 5.28 in. wide, 5.00 in. tall
- E-Track not included



01120

Part No.	Hook Type	Finish	Inner Dimension/Dia. (in.)	Wt. (lbs.)
01120	J-Hook	Powder Coat	4.25	0.89

E-TRACK J-HOOK

- White powder-coat finish for corrosion resistance
- The steel hook is .375 in. thick, 2.75 in. wide, 3.75 in. tall
- E-Track not included



01130

Part No.	Hook Type	Finish	Inner Dimension/Dia. (in.)	Wt. (lbs.)
01130	J-Hook	Powder Coat	2.00	0.50

E-TRACK TOOL HOLDER

- Zinc-plated steel construction for corrosion resistance
- Provides convenient E-Track tool storage for long-handled tools



01140

Part No.	Hook Type	Finish	Inner Dimension/Dia. (in.)	Wt. (lbs.)
01140	Tool Holder	Zinc Plated	2.09	0.89

E-TRACK BOARD HOLDER

- Corrosion resistant zinc plated steel construction
- Holds 2 x 4 in. and 2 x 6 in. lumber to create wood partitions
- Bolt holes provided for additional security



01100



01100 application

Part No.	Hook Type	Finish	Inner Dimension/Dia. (in.)	Wt. (lbs.)
01100	Board Holder	Zinc Plated Yellow	2.00	1.00

E-Track

E-TRACK AND HARDWARE - continued

E-TRACK SPARE TIRE CARRIER **NEW**

- Zinc-plated for corrosion resistance
- 7 in. long carbon steel construction
- Secures spare tire to wall



5201030



5201030 Packaging

Part No.	Hook Type	Finish	Length	Wt. (lbs.)
 5201030	Spare Tire Carrier	Zinc Plated	7	0.67

E-TRACK LONG HANDLE TOOL HOLDER **NEW**

- 9 in. L x 2-3/4 in. W x 4-1/4 in. H
- Holds up to 1-7/8 in. tool handles



5201040

Part No.	Hook Type	Finish	Inner Dimension/Dia. (in.)	Wt. (lbs.)
5201040	Tool Holder	Zinc Plated Yellow	1-7/8	1.58

E-TRACK TOOL HOLDER WITH SPRING RETENTION **NEW**

- 7-1/2 in. L x 1-1/2 in. W x 6-1/2 in. H
- Holds up to 1-5/8 in. diameter tool handles
- Black powder-coat finish for corrosion resistance



5206750

Part No.	Hook Type	Finish	Inner Dimension/Dia. (in.)	Wt. (lbs.)
5206750	Tool Holder	Powder Coat	1-5/8	3.06

Available Q2 of 2024



E-TRACK TIE DOWNS

2 INCH E-TRACK CAMBUCKLE TIE DOWN

- Zinc plated for corrosion resistance



01070

Part No.	Hook Type	Finish	Strap Size (in. x ft)	Minimum Breaking Strength (lbs)	W.L.L. (lbs)	Wt. (lbs.)
01070	E-Track	Zinc Plated	2 x 12	3,000	1,000	2.00

2 INCH E-TRACK RATCHET TIE DOWN

- Zinc plated for corrosion resistance



01075

Part No.	Hook Type	Finish	Strap Size (in. x ft)	Minimum Breaking Strength (lbs)	W.L.L. (lbs)	Wt. (lbs.)
01075	E-Track	Zinc Plated	2 x 12	4,400	1,467	2.20
01076	E-Track	Zinc Plated	2 x 16	4,400	1,467	2.31
01077	E-Track	Zinc Plated	2 x 20	4,400	1,467	2.40

2 INCH X 6 INCH E-TRACK ROPE RING STRAP

- Zinc plated for corrosion resistance
- The D-ring provides an ideal anchor point for tie downs, ropes, or cords



01080

Part No.	Hook Type	Finish	Strap Size (in. x in)	Minimum Breaking Strength (lbs)	W.L.L. (lbs)	Wt. (lbs.)
01080	E-Track	Zinc Plated	2 x 6	3,000	1,000	0.36

2 INCH RETRACTABLE E-TRACK RATCHET TIE DOWN

- Soft rubber grip handle
- Spring retracting spool easily retracts for tangle-free storage
- Bolt on design for permanent mount applications
- 8.00 ft retractable strap + 2.00 ft bolt on extension



5480011

Part No.	Hook Type	Strap Size (in. x ft)	Minimum Breaking Strength (lbs)	W.L.L. (lbs)	Wt. (lbs.)
5480011	E-Track	1.88 x 10	3,000	1,000	4.50

Tarp Straps & Cable Ties

TARP STRAPS

RUBBER TARP STRAPS

- Holds tarp down securely
- Prevents flapping
- S-Hooks sold separately

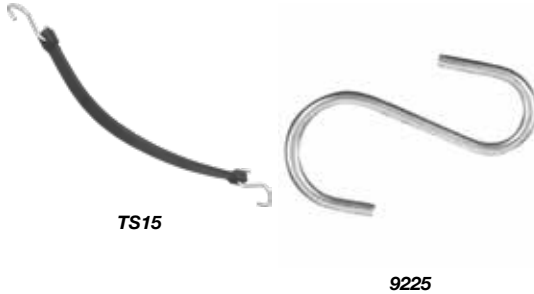

Part No.	Material	Length (in.)	Wt. (lbs.)
TS9	Rubber	9	0.11
TS15	Rubber	15	0.12
TS20	Rubber	20	0.15
TS31	Rubber	31	0.25
TS41	Rubber	41	0.3

Accessories:

Part No.	Description	Wt.(lbs.)
9225	2-1/2 Inch Zinc Plated S-Hook For Tarp Straps - 100/Cartron	0.04

CABLE/ZIP TIES

NYLON CABLE TIES

- 100% nylon
- Bent tip for ease of installation
- Available in natural or black weather resistant (WR)



Part No.	Length	Width	Tensile Strength (lbs.)	Color	Military Standard	Package Quantity	Package Wt. (lbs.)
BTN055CPK	5-1/2"	.180	50	Natural	MS-3367-5	100 PC	0.08
BTN075	7-1/2"	.180	50	Natural	MS-3367-1	1000 PC	2.50
BTN075CPK	7-1/2"	.180	120	Natural	MS-3367-1	100 PC	0.13
BTN011CPK	11"	.180	50	Natural	MS-3367-7	100 PC	0.18
BTN011	11"	.180	50	Natural	MS-3367-7	500 PC	4.25
BTN145	14-1/2"	.250	120	Natural	MS-3367-3	100 PC	0.98
BTN015	15"	.180	50	Natural	MS-3367-2	100 PC	0.57
BTN240	24"	.350	175	Natural	N/A	50 PC	1.40
BTN300	30"	.350	175	Natural	MS-3367-6	50 PC	2.08
BTN075WRCPK	7-1/2"	.180	50	Black	MS-3367-1	100 PC	0.26
BTN075WR	7-1/2"	.180	50	Black	MS-3367-1	1000 PC	2.60
BTN011WRCPK	11"	.180	50	Black	MS-3367-7	100 PC	0.24
BTN011WR	11"	.180	50	Black	MS-3367-7	500 PC	1.96
BTN145WR	14-1/2"	.250	120	Black	MS-3367-3	100 PC	0.98
BTN015WR	15"	.180	50	Black	MS-3367-2	100 PC	0.56

ADHESIVE MOUNT

- 1" square adhesive mount
- Also accepts #6 screw
- For all ties up to .180 wide
- 100 pcs. per bag
- Color: Natural



Part No.	Description	Wt. (lbs.)
B08462	Adhesive Mount	0.42



Lighting & Electrical



Product Shown:

- 8893148: 48" Amber/Clear LED Light Bar
- 1492260: 8" Edgeless Ultra Bright Combination Spot-Flood Light
- 1492196: 6" Ultra Bright Wide Rectangular LED Flood Light
- 8891700: 5" Amber Dual Row LED Strobe Light
- 85204: 71" KabGard™
- 1729410: Gloss Black Diamond Tread Aluminum Crossover Truck Tool Box

Work Lights	148 - 161
Work/Strobe Lights	162 - 163
Work Light Bars	164 - 167
Strip Lights	168
Dome Lights	169
Plow Lights	170
LED Modular Light Bars	174
LED Light Bars	178
LED Mini Light Bars	179 - 183
Drill-Free Light Bar Mounts and Cab Mounts	184 - 185
Traffic Advisors	186 - 187
Strobe Lights	188 - 207
LED Combination Stop/Turn/Tail/Backup	
Strobe Lights	201 - 202
Beacon Lights	208 - 212
DOT Lights	214 - 232

License Plate Lights, Plugs, Reflectors	233
DOT Light Bar Kits	234 - 235
DOT Light Boxes	236
DOT Light Boxes and Accessories	237
Backup Camera Systems	242 - 245
Booster Cables	246
Road Strobe/Flares	247
Towing Lights and Backup Alarms	248
Switch Panels	249 - 250
Switches	252 - 253
Circuit Breakers	254
Solenoids and Motors	255 - 256
Meters, Battery Accessories Bolt Adapters	257
Fuse Holders & Electric Converter	258
Junction Boxes, Fuse Block, Battery Protector	259
Icon Definitions	260

Work Lights

ULTRA BRIGHT ROTATING SPOT LIGHT WITH WIRELESS REMOTE **NEW**

5-YEAR W	Number of LEDs	16
12-24 VOLTS	Lumens	6,720
IP 65	Lead Length	12"
	Mount / Base	Surface

360° Continuous Power Rotation and 110° Power Tilt



Part No.	Type	Housing Color	Lens Color	Amp	Connection	Mount	Wt. (lbs.)
1492200	Spot	White	Clear	4.75	Blunt Cut	Permanent	7.84
1492201†	Spot	White	Clear	4.75	12V Plug	Magnetic	7.84
1492202†	Spot	Black	Clear	4.75	Blunt Cut	Permanent	7.84
1492203†	Spot	Black	Clear	4.75	12V Plug	Magnetic	7.84

Battery Type A23 for Controller - (Not Included)
†Available Q2 of 2024

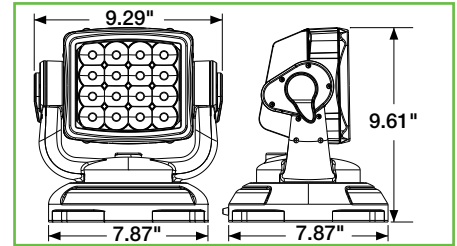
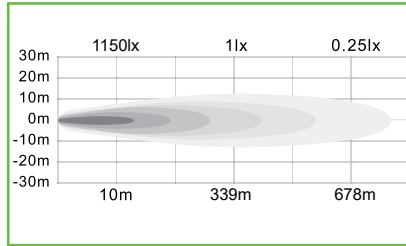

ROUND

ULTRA BRIGHT ARTICULATING 5" LED

5-YEAR W	Number of LEDs	18
12-24 VOLTS	Lumens	6,800
IP 67	Lead Length	36"
	Mount / Base	Surface

Part No.	Type	Color	Amp	Connection	Wt. (lbs.)
1492145	Flood	Clear	3	Blunt Cut	2.04
1492146	Spot	Clear	3	Blunt Cut	2.04

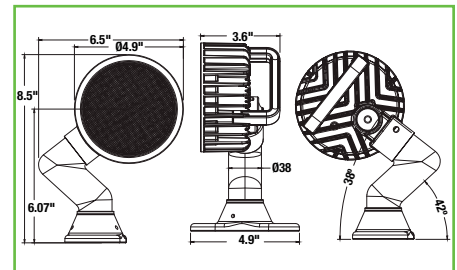
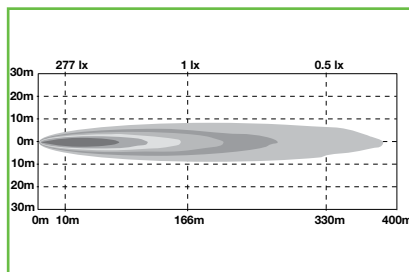
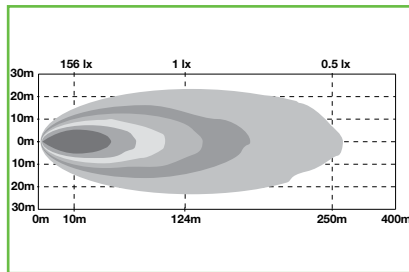

ARTICULATING 5" LED

5-YEAR
W
12-24
VOLTS
IP
67

Number of LEDs	6
Lumens	1,350
Lead Length	36"
Mount / Base	Surface

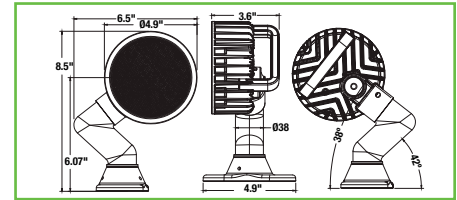
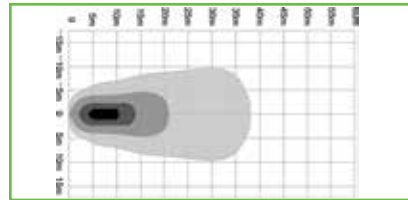
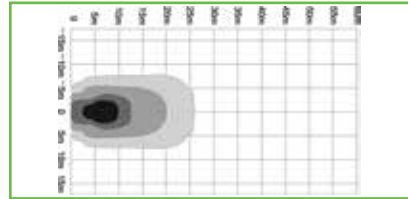

Part No.	Type	Color	Amp	Connection	Wt. (lbs.)
1492125	Flood	Clear	1.5	Blunt Cut	2.41
1492126	Spot	Clear	1.5	Blunt Cut	2.41

3" LED **NEW**

5-YEAR
W
12-24
VOLTS
IP
68
IP
69K

Number of LEDs	8
Lumens	2,650
Lead Length	18"
Mount / Base	8mm Stud, SST

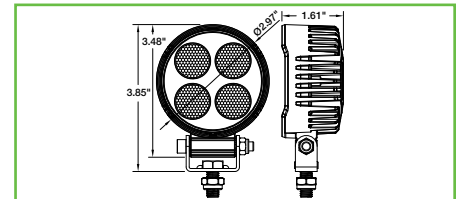
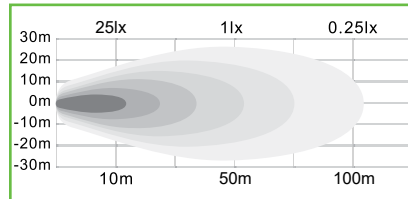

Part No.	Type	Color	Amp	Connection	Wt. (lbs.)
1492302	Flood	Clear	1.78	Blunt Cut	0.75

4" LED

5-YEAR
W
12-24
VOLTS
IP
68
IP
69K

Number of LEDs	9
Lumens	1,710
Lead Length	18"
Mount / Base	8mm Stud, SST

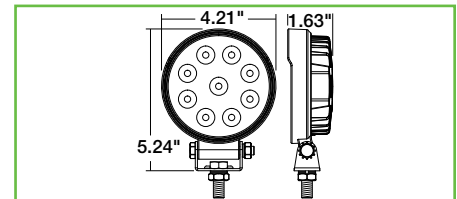
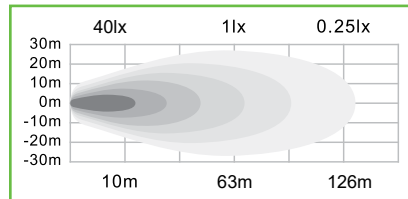

Part No.	Type	Color	Amp	Connection	Wt. (lbs.)
1492114	Flood	Clear	1.25	Blunt Cut	1.58

4" LED, MAGNETIC BASE

5-YEAR
W
12-24
VOLTS
IP
67

Number of LEDs	6
Lumens	1,140
Lead Length	30'
Mount / Base	Magnetic

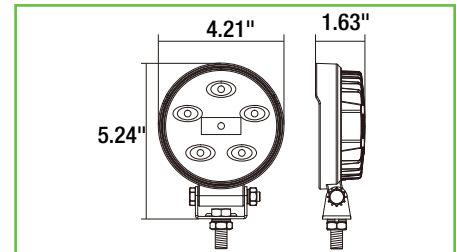
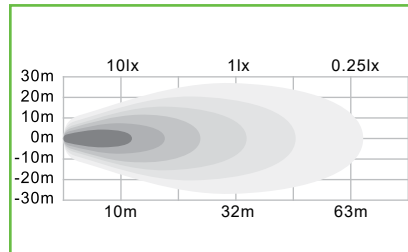

Part No.	Type	Color	Amp	Connection	Wt. (lbs.)
1492130	Flood	Clear	1.5	12V DC Adapter	2.53

Work Lights

4.5" LED

5-YEAR W	Number of LEDs	6
12-24 VOLTS	Lumens	1,350
IP 67	Lead Length	36"
	Mount / Base	8mm Stud, SST

Part No.	Type	Housing Color	Lens Color	Amp	Connection	Wt. (lbs.)
1492115	Flood	Black	Clear	1.5	Blunt Cut	1.20
1492116	Flood	Black	Amber	1.5	Blunt Cut	1.20
1493215	Flood	White	Clear	1.5	Blunt Cut	1.20
1492215	Spot	Black	Clear	1.5	Blunt Cut	1.20

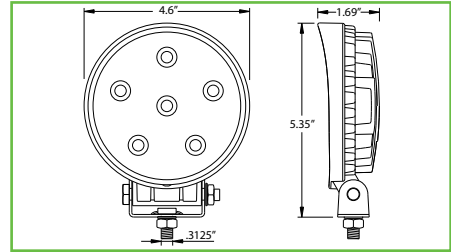
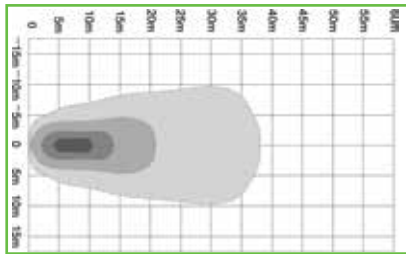
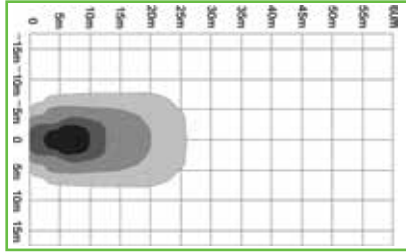

5" LED, SEALED RUBBER HOUSING

5-YEAR W	Number of LEDs	54
12-24 VOLTS	Lumens	375
IP 67	Lead Length	36"
	Mount / Base	8mm Stud, SST

Part No.	Type	Color	Amp	Connection	Wt. (lbs.)
1492110	Flood	Clear	3	Blunt Cut	1.63
1492111	Flood	Amber	3	Blunt Cut	1.63

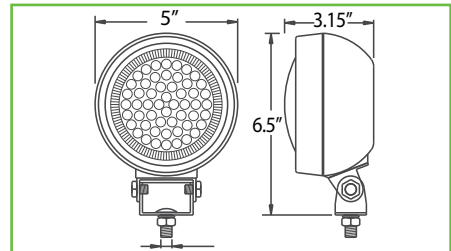
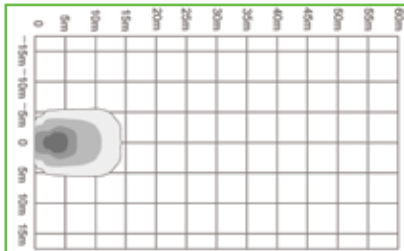

5" LED, SEALED RUBBER HOUSING

5-YEAR W	Number of LEDs	5
12-24 VOLTS	Lumens	1,350
IP 67	Lead Length	36"
	Mount / Base	8mm Stud, SST

Part No.	Type	Color	Amp	Connection	Wt. (lbs.)
1492112	Flood	Clear	1.5	Blunt Cut	1.80

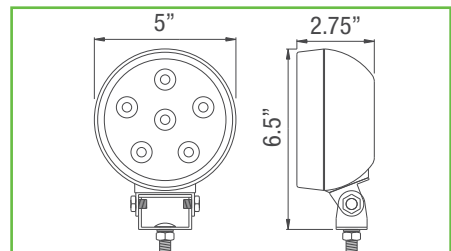
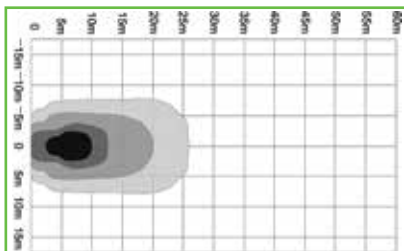

5" INCANDESCENT, SEALED RUBBER HOUSING

5-YEAR
W
12
VOLTS
IP
67

Number of LEDs	-
Lumens	-
Lead Length	10"
Mount / Base	8mm Stud Zinc

Part No.	Type	Color	Amp	Connection	Wt. (lbs.)
 1492100	Flood	Clear	2.92	Blunt Cut	2.64

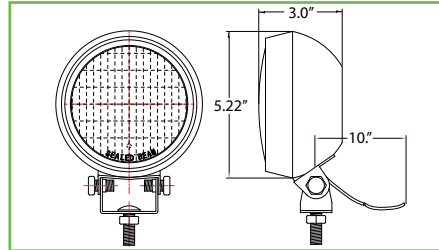

ULTRA BRIGHT 5" LED

5-YEAR
W
12-24
VOLTS
IP
68
IP
69K

Number of LEDs	14
Lumens	3,780
Lead Length	18"
Mount / Base	10mm Stud, SST

Part No.	Type	Color	Amp	Connection	Wt. (lbs.)
 1492127	Flood	Clear	1.83	Blunt Cut	1.49

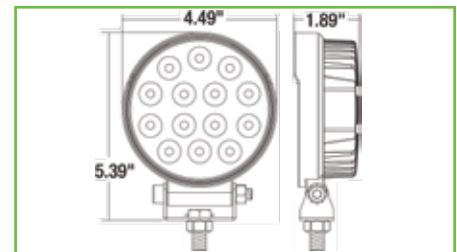
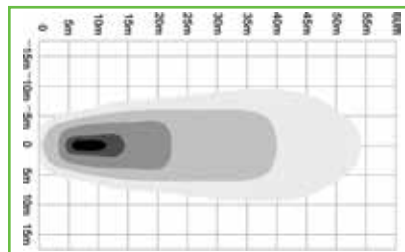

5.5" LED

5-YEAR
W
12-24
VOLTS
IP
67

Number of LEDs	6
Lumens	1,350
Lead Length	36"
Mount / Base	8mm Stud SST

Part No.	Type	Color	Amp	Connection	Wt. (lbs.)
 1492113	Flood/Spot	Clear	1.5	Blunt Cut	1.20

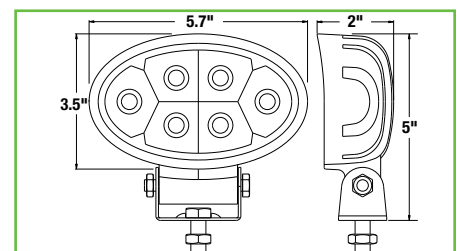
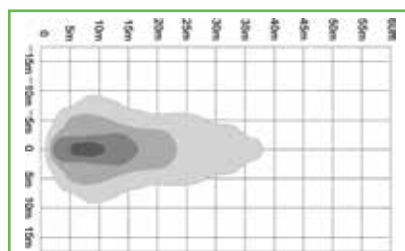

Work Lights

SQUARE

2" LED **NEW**

5-YEAR W	Number of LEDs	9
12-24 VOLTS	Lumens	1,200
IP 67	Lead Length	13.75"
	Mount / Base	8mm Stud, SST



1492300

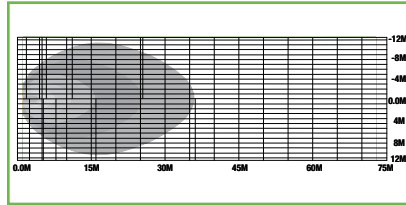

1492301

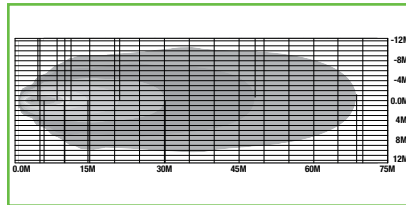

Part No.	Type	Color	Amp	Connection	Wt. (lbs.)
1492300	Flood	Clear	0.9	Blunt Cut	1.48
1492301	Spot	Clear	0.9	Blunt Cut	1.48

Available in retail master pack when bought in quantities of 30

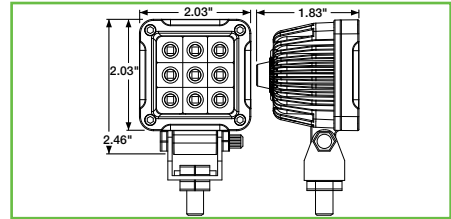

2.5" LED

5-YEAR W	Number of LEDs	4
12-24 VOLTS	Lumens	780
IP 67	Lead Length	36"
	Mount / Base	10mm Stud, SST

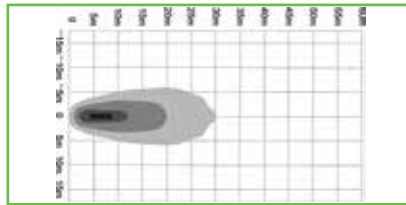

Part No.	Type	Color	Amp	Connection	Wt. (lbs.)
1492129	Flood	Clear	1.0	Blunt Cut	1.0

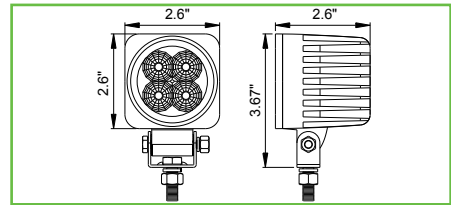

EDGELESS 2.5" LED

5-YEAR W	Number of LEDs	4
12-24 VOLTS	Lumens	1,920
IP 68	Lead Length	18"
IP 69K	Mount / Base	8mm Stud, SST

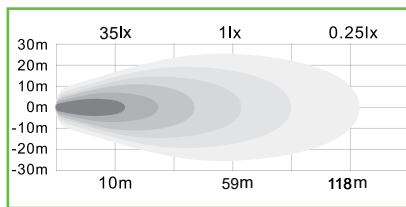

Part No.	Type	Color	Amp	Connection	Wt. (lbs.)
1492239	Flood	Clear	1.5	Blunt Cut	0.61

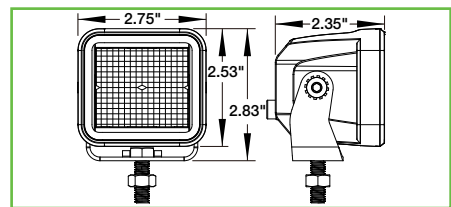

3" LED

5-YEAR W	Number of LEDs	6
12-24 VOLTS	Lumens	1,350
IP 67	Lead Length	36"
	Mount / Base	10mm Stud, SST

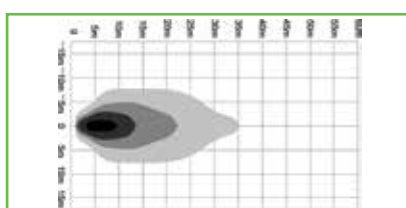

Part No.	Type	Color	Amp	Connection	Wt. (lbs.)
1492137	Flood	Clear	1.5	Blunt Cut	1.5

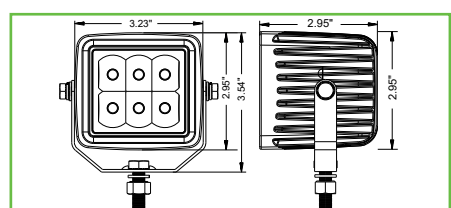

3" LED

5-YEAR
W
12-24
VOLTS
IP
67

Number of LEDs	6
Lumens	1,350
Lead Length	36"
Mount / Base	10mm Stud, SST

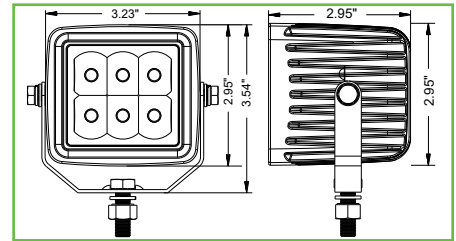
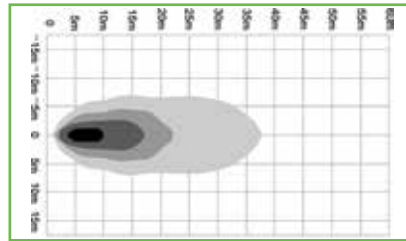

Part No.	Type	Color	Amp	Connection	Wt. (lbs.)
1492237	Spot	Clear	1.5	Blunt Cut	1.5

3" LED **NEW**

5-YEAR
W
12-24
VOLTS
IP
68
IP
69K

Number of LEDs	8
Lumens	2,650
Lead Length	18"
Mount / Base	8mm Stud, SST

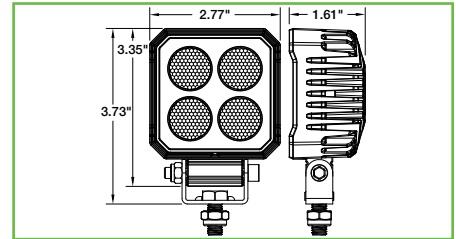
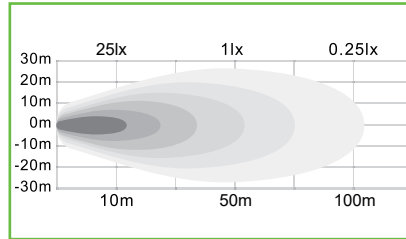

Part No.	Type	Color	Amp	Connection	Wt. (lbs.)
1492303	Flood	Clear	1.78	Blunt Cut	0.75

ULTRA BRIGHT 3" LED

5-YEAR
W
12-24
VOLTS
IP
68
IP
69K

Number of LEDs	4
Lumens	4,000
Lead Length	20"
Mount / Base	8mm Stud, SST

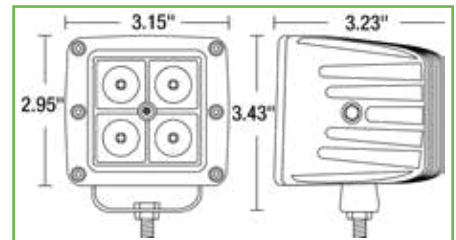
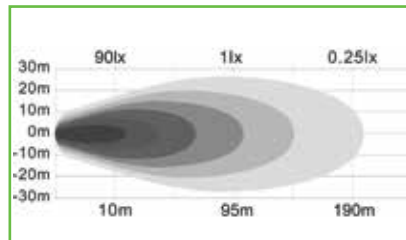

Part No.	Type	Color	Amp	Connection	Wt. (lbs.)
1492227	Flood	Clear	3.55	Deutsch	1.45

EDGELESS ULTRA BRIGHT 3" LED

5-YEAR
W
12-24
VOLTS
IP
68
IP
69K

Number of LEDs	4
Lumens	4,800
Lead Length	18"
Mount / Base	8mm Stud, SST

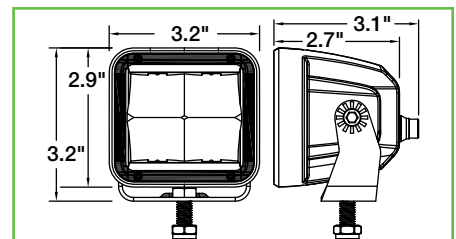
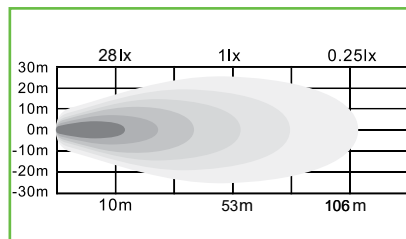

Part No.	Type	Color	Amp	Connection	Wt. (lbs.)
1492236	Flood	Clear	3.39	Blunt Cut	1.45

Work Lights

4" LED

5-YEAR W 12-24 VOLTS IP 67	Number of LEDs	5
	Lumens	1,050
	Lead Length	36"
	Mount / Base	10mm Stud, SST

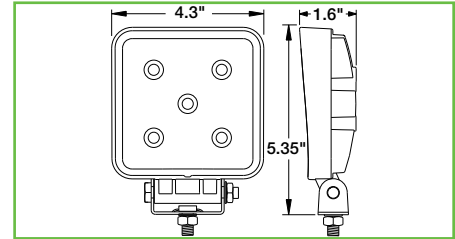
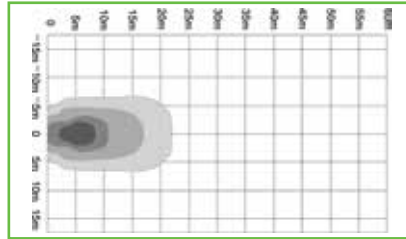

Part No.	Type	Color	Amp	Connection	Wt. (lbs.)
1492117	Flood	Clear	1.2	Blunt Cut	1.20

4" LED WITH SWITCH AND HANDLE

5-YEAR W 12-24 VOLTS IP 68 IP 69K	Number of LEDs	9
	Lumens	1,710
	Lead Length	36"
	Mount / Base	SST Bracket

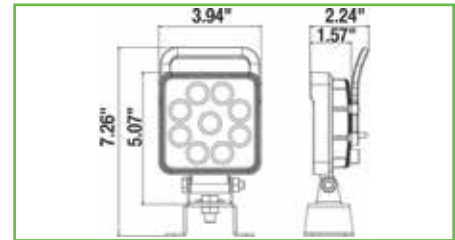
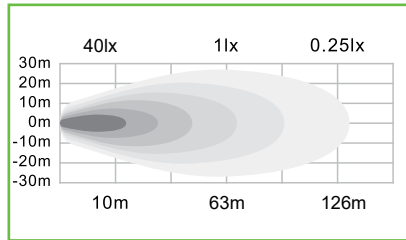

Part No.	Type	Color	Amp	Connection	Wt. (lbs.)
1492193	Flood	Clear	2.25	Blunt Cut	1.76

4" LED

5-YEAR W 12-24 VOLTS IP 68 IP 69K	Number of LEDs	9
	Lumens	1,755
	Lead Length	18"
	Mount / Base	10mm Stud, SST

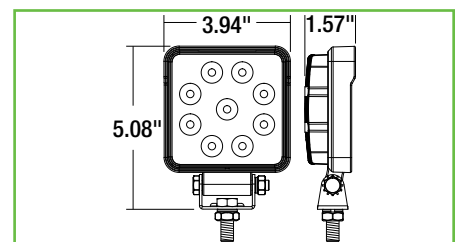
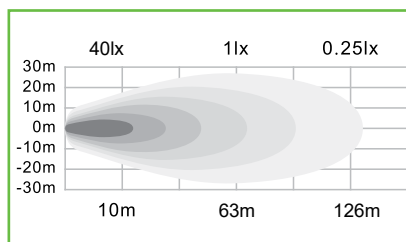

Part No.	Type	Color	Amp	Connection	Wt. (lbs.)
1492217	Flood	Clear	1.25	Blunt Cut	1.1

4" LED

5-YEAR W 12-24 VOLTS IP 68 IP 69K	Number of LEDs	9
	Lumens	2,430
	Lead Length	18"
	Mount / Base	10mm Stud, SST

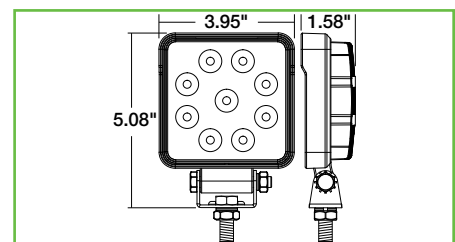
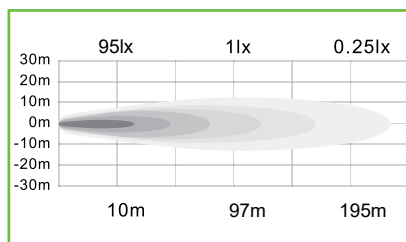

Part No.	Type	Color	Amp	Connection	Wt. (lbs.)
1492134	Spot	Clear	1.25	Blunt Cut	1.12



ULTRA BRIGHT WIDE ANGLE 4" LED

5-YEAR
W
12-24
VOLTS
IP
68
IP
69K

Number of LEDs	10
Lumens	3,540
Lead Length	18"
Mount / Base	10mm Stud, SST

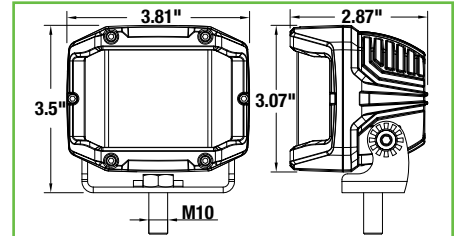
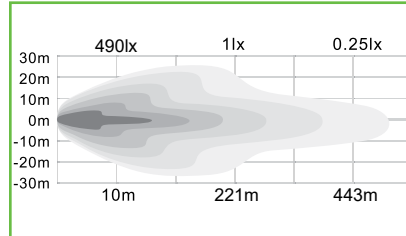

Part No.	Type	Color	Amp	Connection	Wt. (lbs.)
1492197	Flood/Spot	Clear	2.18	Blunt Cut	1.73

ULTRA BRIGHT 4" LED WITH HEATED LENS

5-YEAR
W
12-24
VOLTS
IP
67

Number of LEDs	4
Lumens	4,500
Lead Length	7"
Mount / Base	10mm Stud, SST

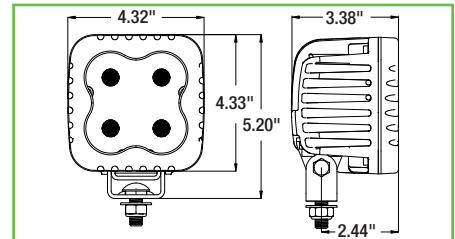
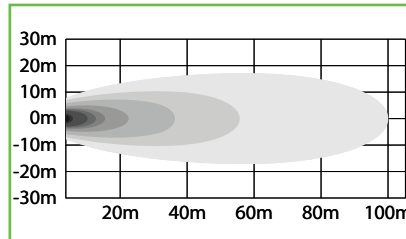

Part No.	Type	Color	Amp	Connection	Wt. (lbs.)
1492198	Flood	Clear	6.6	Blunt Cut	3.31
Heated tempered glass lens helps prevent ice from building up.					

EDGELESS ULTRA BRIGHT WIDE ANGLE 4" LED **NEW**

5-YEAR
W
12-24
VOLTS
IP
68
IP
69K

Number of LEDs	10
Lumens	8,400
Lead Length	18"
Mount / Base	10mm Stud, SST

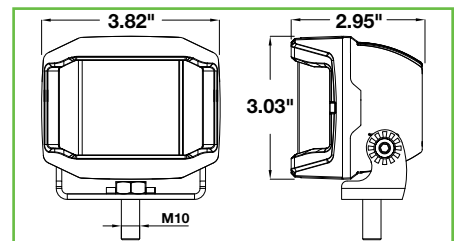
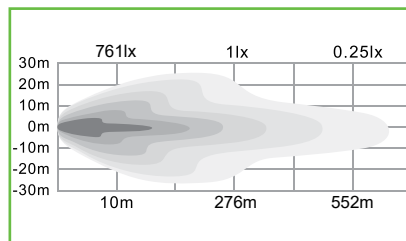

Part No.	Type	Color	Amp	Connection	Wt. (lbs.)
1492240	Flood/Spot	Clear	3.2	Blunt Cut	1.59

ULTRA BRIGHT 4" LED

5-YEAR
W
12-24
VOLTS
IP
68
IP
69K

Number of LEDs	21
Lumens	12,600
Lead Length	9"
Mount / Base	10mm Stud, SST



Swivels at base and light

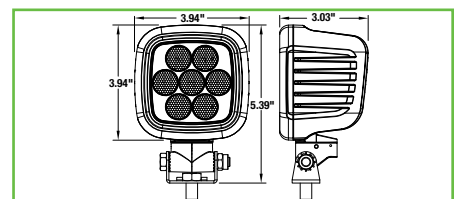
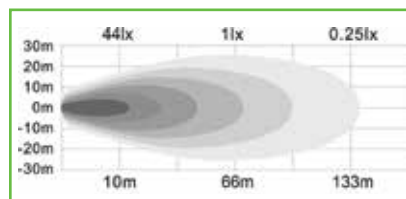

Part No.	Type	Color	Amp	Connection	Wt. (lbs.)
1492223	Flood	Clear	7.75	Deutsch	2.34

Work Lights

ULTRA BRIGHT 4.5" LED

5-YEAR W	Number of LEDs	17
12-24 VOLTS	Lumens	6,920
IP 68	Lead Length	28"
IP 69K	Mount / Base	10mm Stud, SST

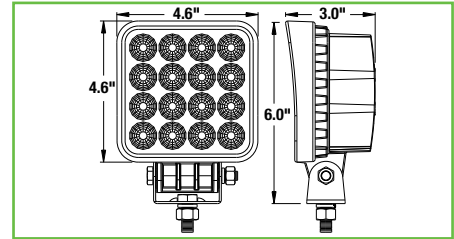
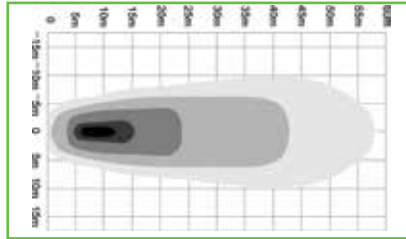

Part No.	Type	Color	Amp	Connection	Wt. (lbs.)
1492128	Flood	Clear	2.08	Blunt Cut	1.66

ULTRA BRIGHT 4.5" LED

5-YEAR W	Number of LEDs	36
12-24 VOLTS	Lumens	21,600
IP 68	Lead Length	28"
IP 69K	Mount / Base	10mm Stud, SST

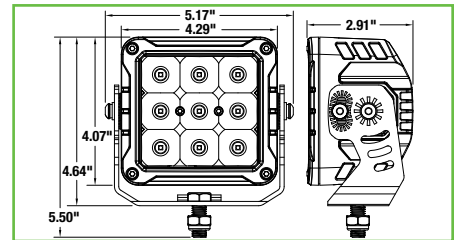
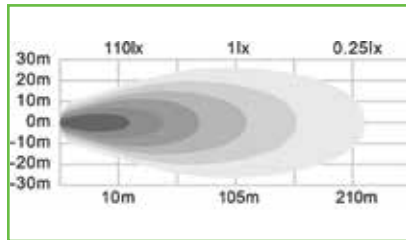

Part No.	Type	Color	Amp	Connection	Wt. (lbs.)
1492225	Flood	Clear	10.00	Deutsch	2.90

5" LED

5-YEAR W	Number of LEDs	9
12-24 VOLTS	Lumens	1,500
IP 67	Lead Length	36"
	Mount / Base	8mm Stud SST

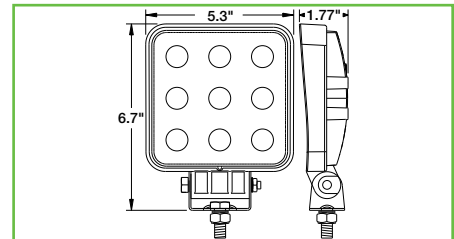

Part No.	Type	Color	Amp	Connection	Wt. (lbs.)
1492119	Flood	Clear	2.25	Blunt Cut	1.76

ULTRA BRIGHT WIDE ANGLE 5.5" LED

5-YEAR W	Number of LEDs	17
12-24 VOLTS	Lumens	6,920
IP 68	Lead Length	28"
IP 69K	Mount / Base	10mm Stud, SST

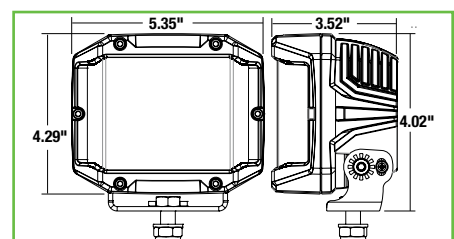
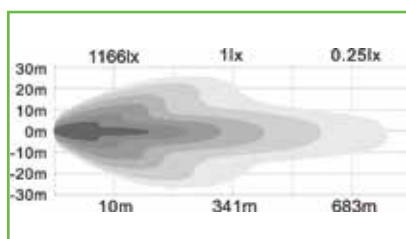

Part No.	Type	Color	Amp	Connection	Wt. (lbs.)
1492222	Flood/Spot	Clear	4.17	Blunt Cut	3.24



4" LED

5-YEAR
W
12-24
VOLTS
IP
67

Number of LEDs	10
Lumens	1,800
Lead Length	14"
Mount / Base	10mm Stud, SST

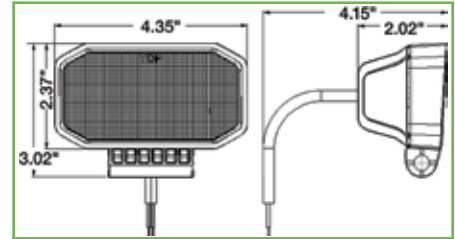
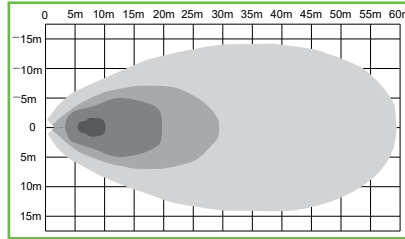

Part No.	Type	Color	Amp	Connection	Wt. (lbs.)
1492220	Flood	Clear	1.0	Blunt Cut	0.90

ULTRA BRIGHT 5.5" LED

5-YEAR
W
12-24
VOLTS
IP
68
IP
69K

Number of LEDs	36
Lumens	21,600
Lead Length	9"
Mount / Base	10mm Stud, SST

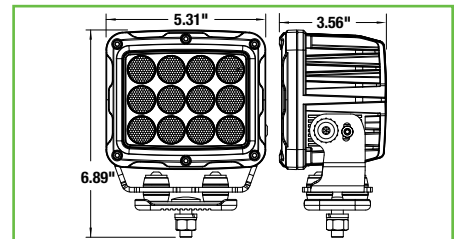
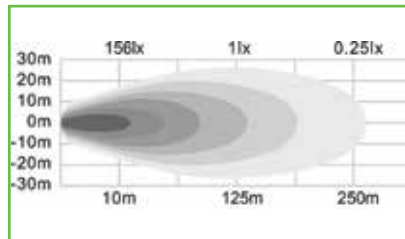

Part No.	Type	Color	Amp	Connection	Wt. (lbs.)
1492226	Flood	Clear	12.42	Deutsch	4.6

6" LED

5-YEAR
W
12-24
VOLTS
IP
67

Number of LEDs	6
Lumens	1,350
Lead Length	36"
Mount / Base	10mm Stud SST

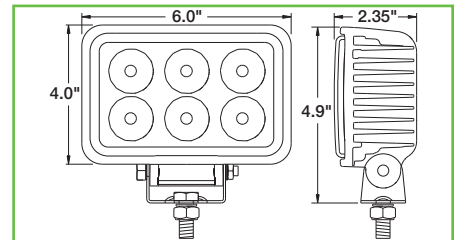
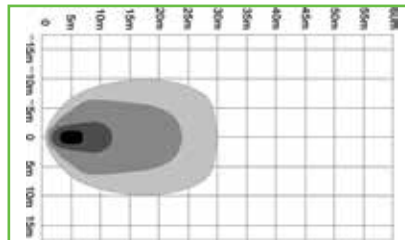

Part No.	Type	Color	Amp	Connection	Wt. (lbs.)
1492118	Flood	Clear	1.5	Blunt Cut	1.75

Work Lights

ULTRA BRIGHT 6" LED

5-YEAR W 12-24 VOLTS IP 68 IP 69K	Number of LEDs	15
	Lumens	4,050
	Lead Length	18"
	Mount / Base	10mm Stud, SST

Part No.	Type	Color	Amp	Connection	Wt. (lbs.)
 1492190	Flood	Clear	1.96	Blunt Cut	1.6
 1492290	Spot	Clear	1.96	Blunt Cut	1.6

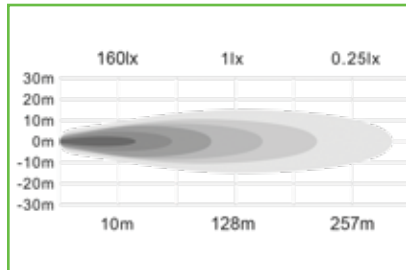
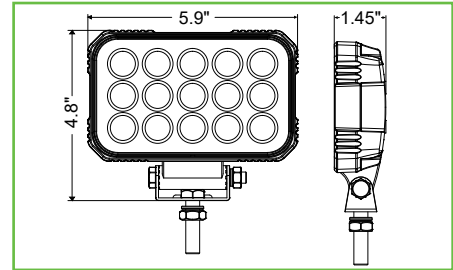
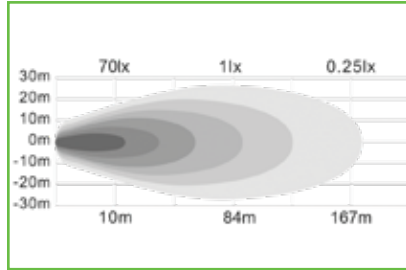

ULTRA BRIGHT 6" LED

5-YEAR W 12-24 VOLTS IP 68 IP 69K	Number of LEDs	15
	Lumens	9,000
	Lead Length	18"
	Mount / Base	10mm Stud, SST

Part No.	Type	Color	Amp	Connection	Wt. (lbs.)
 1492196	Flood	Clear	6.8	Blunt Cut	1.6

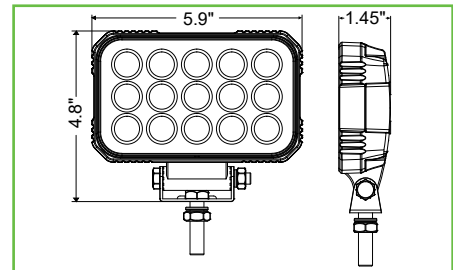
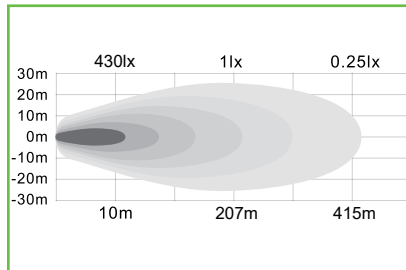

ULTRA BRIGHT 6.5" LED

5-YEAR W 12-24 VOLTS IP 67	Number of LEDs	36
	Lumens	7,920
	Lead Length	11"
	Mount / Base	10mm Stud, SST

Part No.	Type	Color	Amp	Connection	Wt. (lbs.)
 1492194	Flood	Clear	4.9	Blunt Cut	1.88

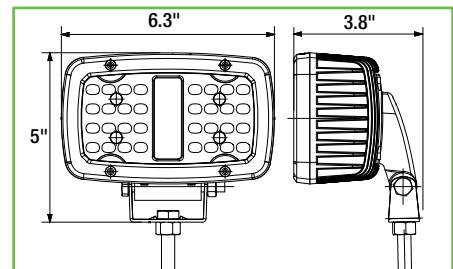
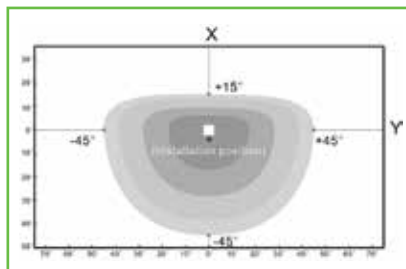

5.5" LED

5-YEAR
W
12-24
VOLTS
IP
68
IP
69K

Number of LEDs	6
Lumens	1,620
Lead Length	36"
Mount / Base	8mm Stud SST



Part No.	Type	Color	Amp	Connection	Wt. (lbs.)
1492135	Flood	Clear	1.5	Blunt Cut	1.6

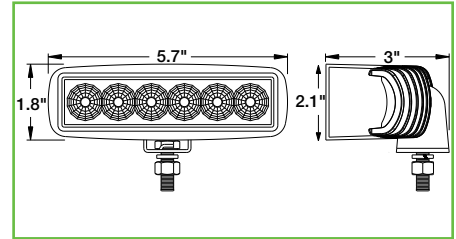
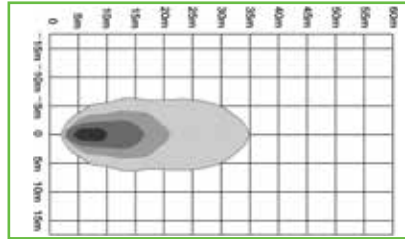

EDGELESS 6" LED

5-YEAR
W
12-24
VOLTS
IP
68
IP
69K

Number of LEDs	6
Lumens	2,880
Lead Length	18"
Mount / Base	8mm Stud, SST



Part No.	Type	Color	Amp	Connection	Wt. (lbs.)
1492235	Flood	Clear	2.04	Blunt Cut	1.6

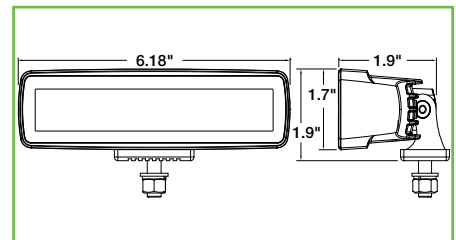
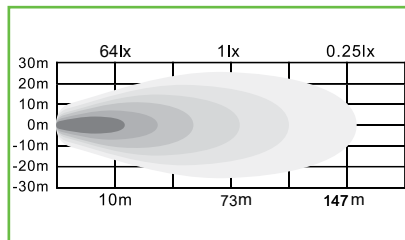

1492235 shown

Work Lights

4.4" LED PROJECTOR LIGHT

5-YEAR W	Number of LEDs	3
12 VOLTS	Lumens	120
IP 67	Lead Length	36"
	Base / Mount	Aluminum/SS Bracket

Part No.	Color	Amp	Connection	Wt. (lbs.)
5624433	Clear	0.30	Blunt Cut	0.37

Ideal for cab steps and perimeter ground lighting

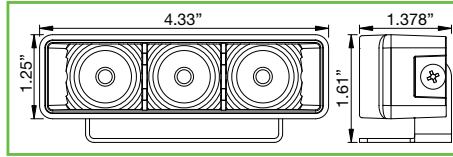

ANGLE MOUNTED 3" LED

5-YEAR W	Number of LEDs	3
12-24 VOLTS	Lumens	1,260
IP 68	Lead Length	18"
IP 69K	Rubber Mount / Base	Flat, Tubular and Angle

Part No.	Type	Color	Amp	Connection	Wt. (lbs.)
1492139	Flood	Clear	0.34	Blunt Cut	0.32

Rubber mounting options included: flat, tubular and angle



Side view of Rubber Mount

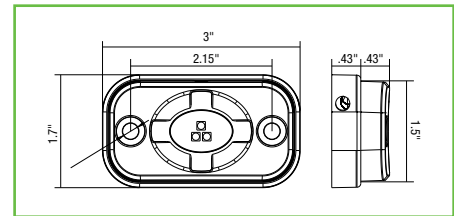
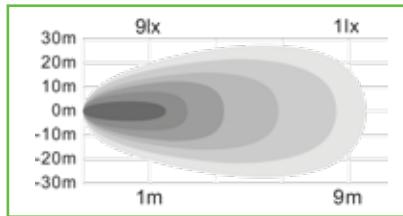

RECESSED 4" LED

5-YEAR W	Number of LEDs	6
12-24 VOLTS	Lumens	1,620
IP 68	Lead Length	18"
IP 69K	Mount / Base	12mm Stud

Part No.	Type	Color	Amp	Connection	Wt. (lbs.)
1492138	Flood	Clear	1.38	Blunt Cut	1.37

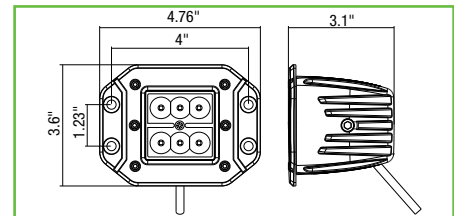
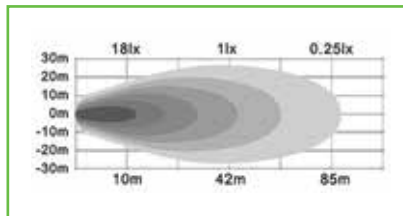

ULTRA BRIGHT 7.5" LED

5-YEAR W	Number of LEDs	6
12-24 VOLTS	Lumens	3,600
IP 68	Lead Length	20"
IP 69K	Mount / Base	Recessed

Part No.	Type	Color	Amp	Connection	Wt. (lbs.)
1492228	Flood	Clear	2.18	Deutsch	1.16

Includes angled mounting bracket.

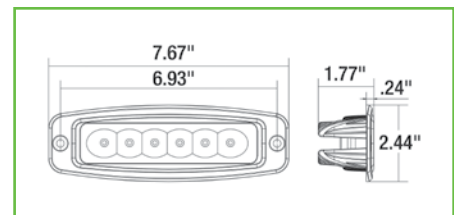
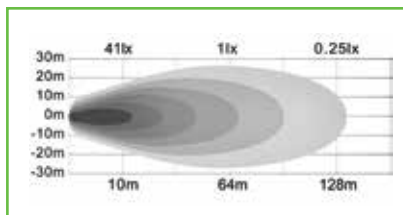

Shown with the included angle bracket

Shown without angle bracket



6.25" LED SCENE LIGHT

5-YEAR
W
12-24
VOLTS
IP
68
IP
69K

Number of LEDs	6
Lumens	1,140
Lead Length	18"
Mount / Base	Recessed, Diecast

Part No.	Type	Color	Amp	Connection	Wt. (lbs.)
 1492191	Flood	Clear	0.75	Blunt Cut	1.2

Includes 30° rubber offset mount for surface mount

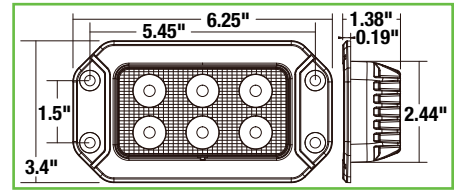
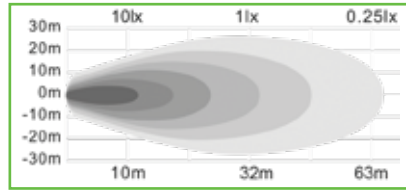

6" LED SCENE LIGHT

5-YEAR
W
12-24
VOLTS
IP
68
IP
69K

Number of LEDs	52
Lumens	2,296
Lead Length	20"
Mount / Base	45° Angled

Part No.	Type	Color	Amp	Connection	Wt. (lbs.)
 1492238	Flood	Clear	1.54	Blunt Cut	0.65

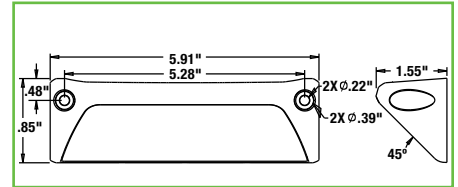
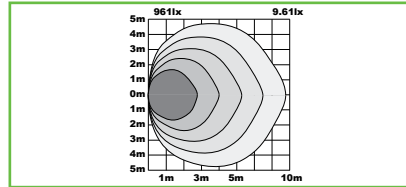

FLEXIBLE LED CAB LIGHT **NEW**

5-YEAR
W
12-24
VOLTS

Number of LEDs	1 White, 1 Blue
Lumens	200
Construction	6" Flexible Metal Arm
Mount	2 Screws Included

Part No.	Color	Amp	Connection	Wt. (lbs.)
 1492246	Clear/Blue	0.11	Blunt Cut	0.5

Available Q2 of 2024

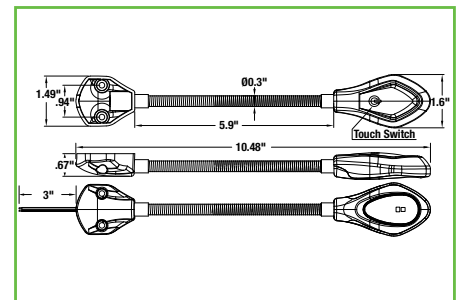

STAINLESS STEEL MOUNTS FOR WORK LIGHTS

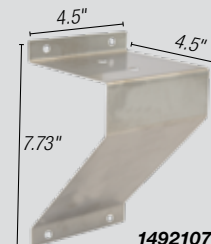
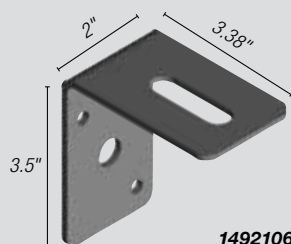

Part No.	Description	Wt. (lbs.)
1492106	Stainless Steel Bracket	0.47
1492107	Stainless Steel Bracket	0.90

Work/Strobe Lights

ULTRA BRIGHT 4.5" LED WITH STROBE

5-YEAR W 12-24 VOLTS IP 68 IP 69K	Number of LEDs	16
	Lumens	9,600
	Lead Length	20"
	Mount / Base	10mm Stud, SST

2 LIGHTS IN ONE!



Part No.	Type - Color	Amp	Connection	Wt. (lbs.)
1492230	Flood - Clear	6.67 - Flood	Deutsch	1.45
	Strobe - Amber	1.33 - Strobe		

Light functions as a flood light or a warning strobe light.

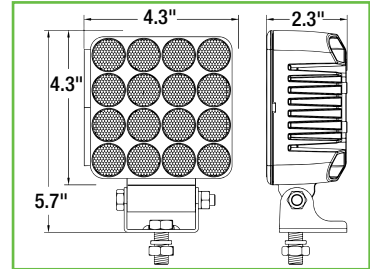
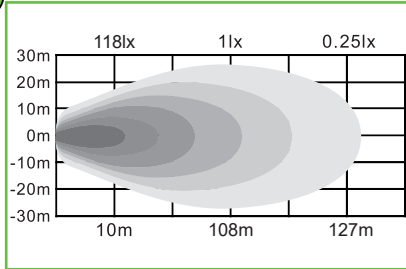

ULTRA BRIGHT 4.5" LED WITH STROBE

5-YEAR W 12-24 VOLTS IP 68 IP 69K	Number of LEDs	18
	Lumens	4,050
	Lead Length	18"
	Mount / Base	10mm Stud, SST

2 LIGHTS IN ONE!



Part No.	Type - Color	Amp	Connection	Wt. (lbs.)
1492231	Flood - Clear	3.7 - Flood	Deutsch	1.35
	Strobe - Amber	0.8 - Strobe		

Light functions as a flood light or a warning strobe light.

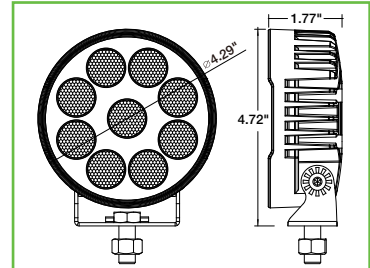
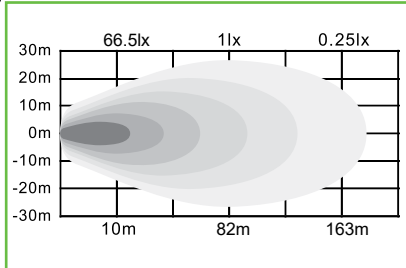

4" LED WITH STROBE

5-YEAR W 12-24 VOLTS IP 68 IP 69K	Number of LEDs	10
	Lumens	2,400
	Lead Length	18"
	Mount / Base	10mm Stud, SST

2 LIGHTS IN ONE!



Part No.	Type - Color	Amp	Connection	Wt. (lbs.)
1492232	Flood - Clear	1.72 - Flood	Deutsch	1.30
	Strobe - Amber	0.36 - Strobe		

Light functions as a flood light or a warning strobe light.

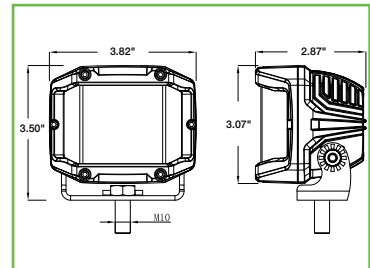
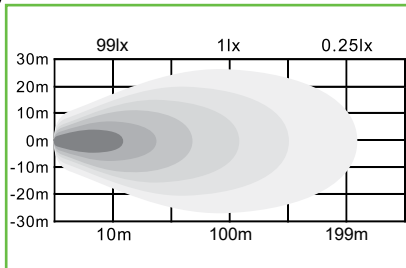

EDGELESS ULTRA BRIGHT 4" LED WITH STROBE **NEW**

5-YEAR W 12-24 VOLTS IP 68 IP 69K	Number of LEDs	40
	Lumens	8,400
	Lead Length	18"
	Mount / Base	10mm Stud, SST

Part No.	Type - Color	Amp	Connection	Wt. (lbs.)
 1492242	Flood/Spot- Clear	3.2 - Flood	Blunt Cut	1.59
	Strobe - Amber	0.67 - Strobe		

Light functions as a flood/spot light or a warning strobe light.

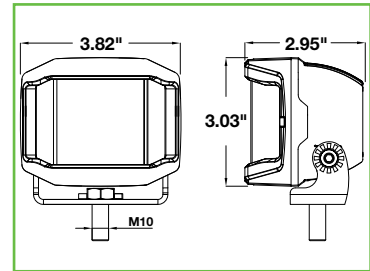
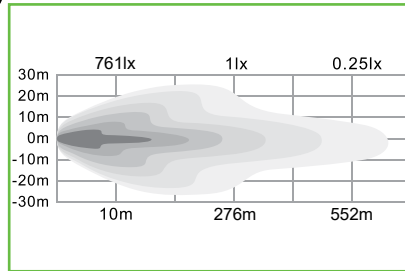

6.5" LED WITH STROBE

5-YEAR W 12-24 VOLTS IP 68 IP 69K	Number of LEDs	18
	Lumens	1,710
	Lead Length	18"
	Mount / Base	8m Stud, SST

Part No.	Type - Color	Amp	Connection	Wt. (lbs.)
 1492233	Flood - Clear	1.27 - Flood	Deutsch	1.45
	Strobe - Amber	0.21 - Strobe		

Light functions as a flood light or a warning strobe light.

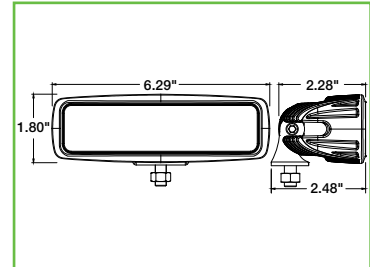
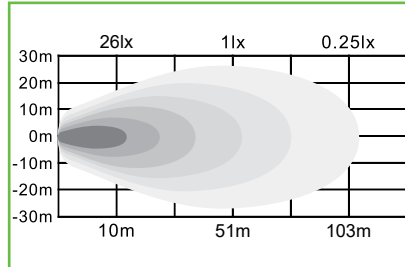

7" LED SCENE LIGHT WITH STROBE **NEW**

5-YEAR W 12-24 VOLTS IP 67	Number of LEDs	12
	Lumens	1,200
	Lead Length	12"
	Mount / Base	Surface
	Flash Pattern	19

Part No.	Type - Color	Amp	Connection	Wt. (lbs.)
 1492245	Flood - Clear	0.5 - Flood	Blunt Cut	0.8
	Strobe - Amber	0.25 - Strobe		

Light functions as a flood light or a warning strobe light.

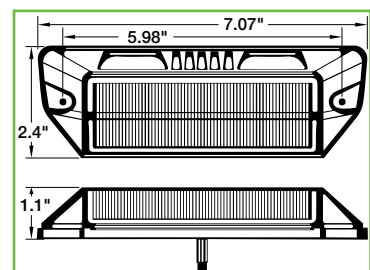
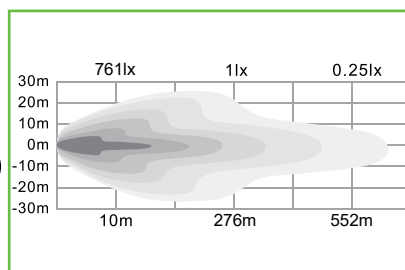

Work Light Bars

EDGELESS ULTRA BRIGHT DUAL ROW LED COMBINATION LIGHT BARS

5-YEAR
W
12-24
VOLTS
IP
68
IP
69K

Color	Clear
Mount / Base	Aluminum

Part No.	Length	LEDs	Type	Amp	Lead Length	Connection	Lumens	Wt. (lbs.)
1492260	8"	12	Flood/Spot	3.78	19.5"	Deutsch	5,040	3.11
1492261	14"	24	Flood/Spot	7.73	19.5"	Deutsch	10,080	4.65
1492262	22"	40	Flood/Spot	14.60	39.25"	Deutsch	16,800	6.61
1492263	32"	60	Flood/Spot	20.80	39.25"	ATP	25,200	8.53

8"

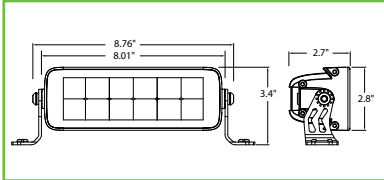
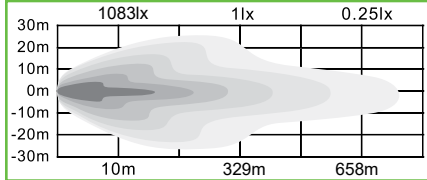

REAR MOUNTING LEGS, 1492260 SERIES



Part No.	Description
3048967	Rear Mounting Legs For 1492260 Series

14"

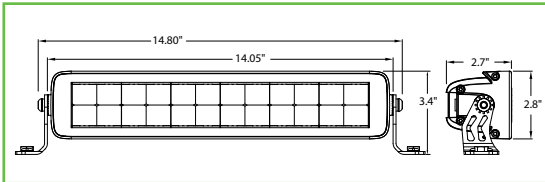
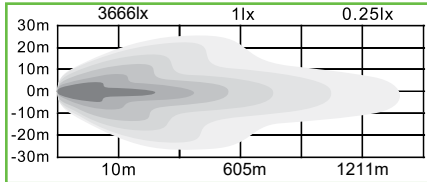

22"

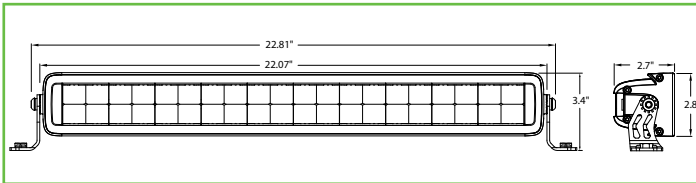
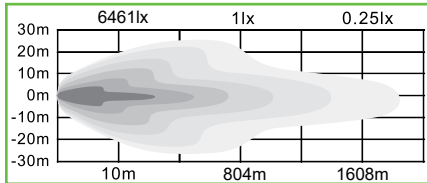

32"

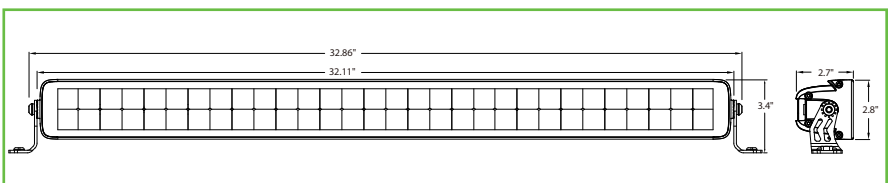
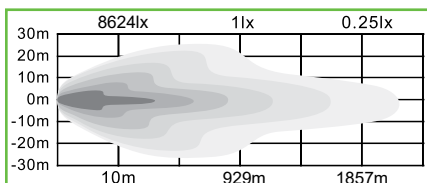

ULTRA BRIGHT DUAL ROW LED COMBINATION LIGHT BARS

5-YEAR
W
12-24
VOLTS
IP
68

Color	Clear
Connection	Blunt Cut
Mount / Base	Aluminum

Part No.	Length	LEDs	Type	Amp	Lead Length	Lumens	Wt. (lbs.)
1492160	8"	12	Flood/Spot	2.0	33.5"	3,240	3.34
1492161	14"	24	Flood/Spot	4.2	33.5"	6,480	4.98
1492162	22"	40	Flood/Spot	8.2	52.5"	10,800	7.34
1492163	32"	60	Flood/Spot	12.0	52.5"	16,200	10.15
1492165	50"	96	Flood/Spot	16.0	52.5"	25,920	15.42

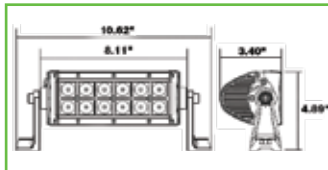
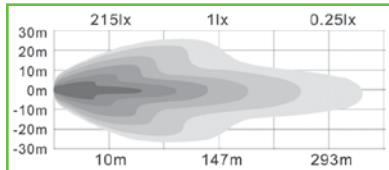

REAR MOUNTING LEGS, 1492160 SERIES



Part No.	Description
3034110	Rear Mounting Legs For 1492160 Series

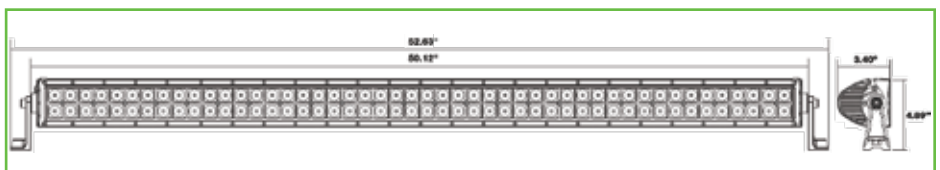
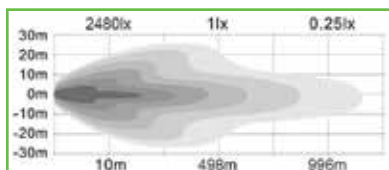
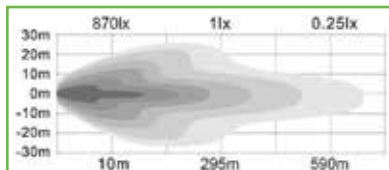
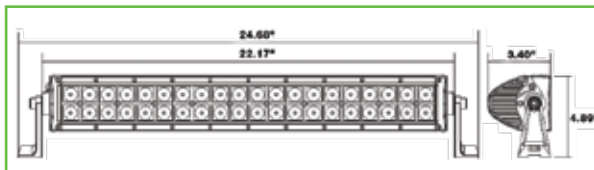
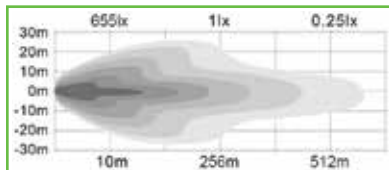
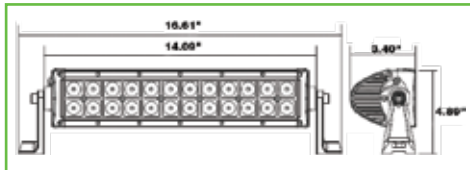
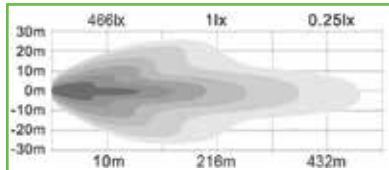

Work Light Bars

ULTRA BRIGHT SINGLE ROW LED COMBINATION LIGHT BARS

5-YEAR
W
12-24
VOLTS
IP
68

Color	Clear
Connection	Blunt Cut
Mount / Base	Aluminum

Part No.	Length	LEDs	Type	Amp	Lead Length	Lumens	Wt. (lbs.)
1492182	20.5"	15	Flood/Spot	2.80	30.5"	4,050	3.70
1492183	32"	24	Flood/Spot	4.55	30.5"	6,480	5.45
1492184	39.5"	30	Flood/Spot	5.78	30.5"	8,100	6.62
1492185	51"	39	Flood/Spot	7.60	30.5"	10,530	8.80



Adjustable width mounts.

20.5"



1492182

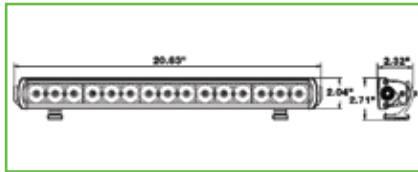
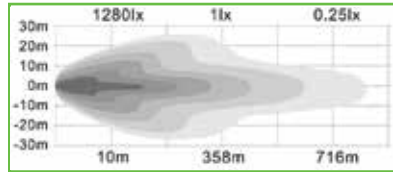

REAR MOUNTING LEGS, 1492180 SERIES



Part No.	Description
3035781	Tube Mount Pair for 1492180 Series

32"



1492183

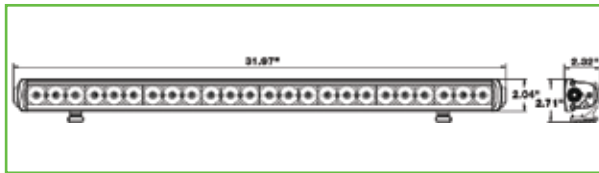
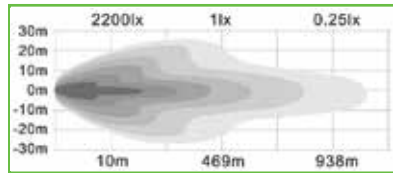

39.5"



1492184

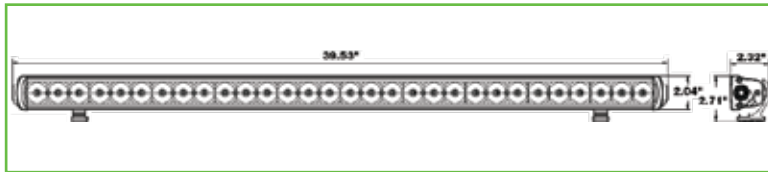
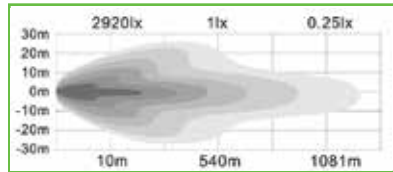

51"



1492185

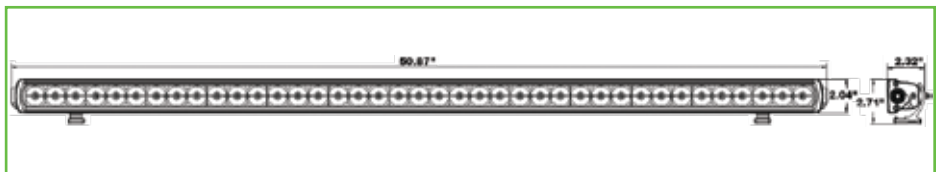
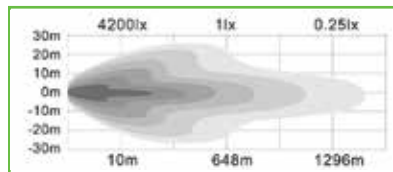

ULTRA BRIGHT DUAL ROW LED CURVED COMBINATION LIGHT BARS

**5-YEAR
W
12-24
VOLTS
IP
68**

Color	Clear
Connection	Blunt Cut
Mount / Base	Aluminum

Part No.	LEDs	Type	Amp	Lead Length	Lumens	Wt. (lbs.)
1492171	24	Flood/Spot	4.2	33.5"	6,480	4.93
1492172	40	Flood/Spot	8.2	52.5"	10,800	7.29

14"

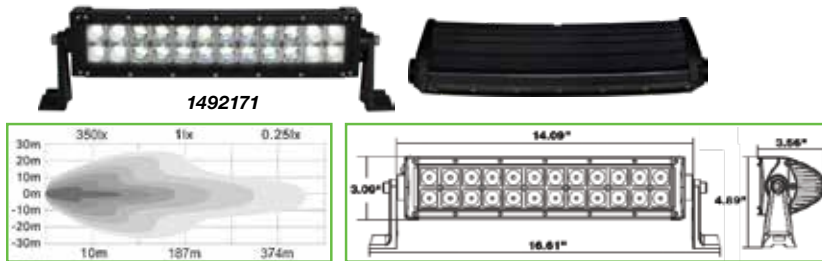

REAR MOUNTING LEGS, 1492170 SERIES



Part No.	Description
3034110	Rear Mounting Legs For 1492170 Series

22"

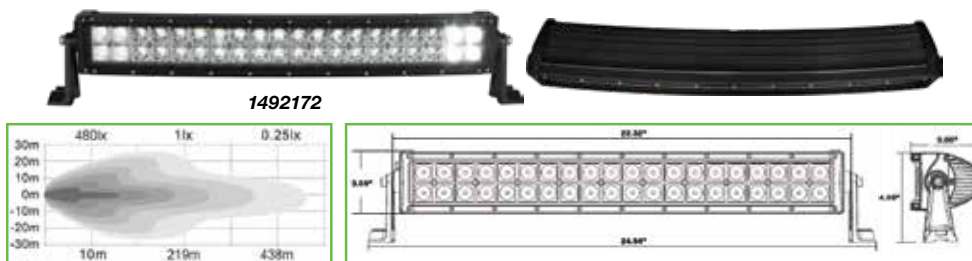

PREWIRED HARNESS WITH IN-CAB SWITCH FOR LIGHT BAR

Single switch and relay harness to control 12VDC lighting of up to a 30 Amp load

- 16" lead to battery connections with 5/16 ring terminals
- 30 amp ATO fuse in sealed holder
- SPST relay with single bolt mounting tab
- 9' lead to switch with intermediate connector for easy routing
- Lighted rocker switch conveniently mounts in 3/4" diameter round hole
- 9' lead to connector for light



Sealed 2 Pin Female DT connector

Part No.	Description	Wt. (lbs.)
3035768	Harness with Single Switch, DT Connection	0.93

For 1492160, 1492170, 1492180 series work lights.



Sealed 2 Pin Female ATP connector

Part No.	Description	Wt. (lbs.)
3035770	Harness with Single Switch, ATP Connection	1.04

For 1492160, 1492170, 1492180 series work lights.

Strip Lights

SILICONE LED STRIP LIGHTS WITH 3M™ ADHESIVE BACK

LIMITED LIFETIME WARRANTY
12 VOLTS
IP 68

Connection	Blunt Cut, Both Ends
Hardware Included	End Caps and Mounting Clips

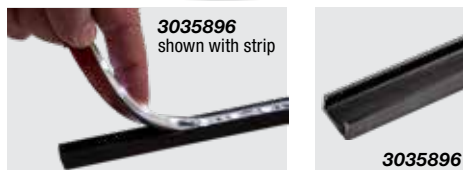
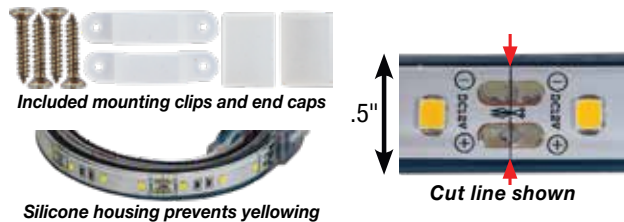

Clear Cool Strip Lights

Part No.	Color	Size	LED's	Amps	Lumens	Wt. (lbs.)
5622120	Clear, Cool	18"	27	0.45	513	0.31
5622941	Clear, Cool	24"	36	0.60	684	0.35
5623957	Clear, Cool	36"	54	0.90	1,026	0.40
5625377	Clear, Cool	48"	72	1.20	1,368	0.44

Accessories

Part No.	Description	Wt. (lbs.)
3035896	LED Strip Light Mounting Channel, 17-1/2" Long, Black, Mounting 3M® Tape	0.39

PVC LED STRIP LIGHTS WITH 3M™ ADHESIVE BACK

LIMITED LIFETIME WARRANTY
12 VOLTS
IP 67

Connection	Blunt Cut, Both Ends
Hardware Included	End Caps and Mounting Clips



Clear Warm Strip Lights

Part No.	Color	Size	LED's	Amps	Lumens	Wt. (lbs.)
5621827	Clear, Warm	18"	27	0.41	360	0.31
5622436	Clear, Warm	24"	36	0.54	470	0.35
5623654	Clear, Warm	36"	54	0.81	710	0.40
5624872	Clear, Warm	48"	72	1.12	940	0.44
5626090	Clear, Warm	60"	90	1.30	1,180	0.55
56296144	Clear, Warm	96"	144	2.00	2,160	0.88



Clear Cool Strip Lights

Part No.	Color	Size	LED's	Amps	Lumens	Wt. (lbs.)
5621928	Clear, Cool	18"	27	0.41	360	0.31
5622537	Clear, Cool	24"	36	0.54	470	0.35
5623755	Clear, Cool	36"	54	0.81	710	0.40
5624973	Clear, Cool	48"	72	1.12	940	0.44
5626191	Clear, Cool	60"	90	1.30	1,175	0.55
56297145	Clear, Cool	96"	144	2.00	2,160	0.88
562109166	Clear, Cool	108"	165	3.00	2,400	1.12
562133202	Clear, Cool	132"	201	4.00	3,000	1.37

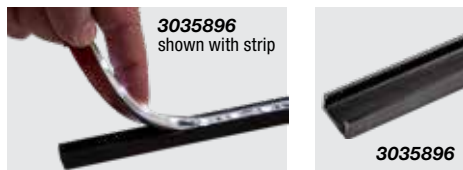

Accessories

Part No.	Description	Wt. (lbs.)
3035896	LED Strip Light Mounting Channel, 17-1/2" Long, Black, Mounting 3M® Tape	0.39

Accessories

Part No.	Description	Wt. (lbs.)
5621002	LED Strobe Controller with 6" Leads, Converts Steady-On Strip Lights to a Strobe Pattern	0.07



LED ROPE LIGHT WITH CONNECTIONS AND MOUNTS



Number of LEDs	576
Lumens	48-60 per Foot
Size	52.5' L x 1/2" Dia.
Base / Mount	Clips

Can be cut every 3 LEDs

Part No.	Color	Amp	Connection	Wt. (lbs.)
5625576	Clear	3.8	Plug	6

Ideal for lighting truck compartments or truck boxes
Easy to install flexible PVC construction



Included mounting hardware and connections

5" ROUND LED INTERIOR DOME LIGHTS



Number of LEDs	36
Lumens	2,200
Lead Length	8"
Connection	Blunt Cut

Part No.	ON/OFF Function	Color	Amp	Mounting	Wt. (lbs.)
5625336	Remote Switch	Clear	1.5	Surface	0.39
5625337	Built-In Switch	Clear	1.5	Surface	0.39
5625338	Motion Sensor	Clear	1.5	Surface	0.39



5625336
Remote Switch



5625337
Built-In Switch



5625338
Motion Sensor

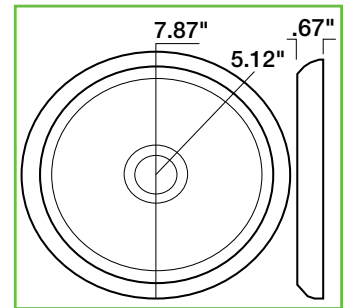

5.8" RECTANGULAR LED INTERIOR DOME LIGHTS **NEW**



Number of LEDs	14
Lumens	700
Lead Length	8"
Connection	Blunt Cut

Part No.	ON/OFF Function	Color	Amp	Mounting	Wt. (lbs.)
5626336	Remote Switch	Clear	1.5	Surface	0.14
5626337	Built-In Switch	Clear	1.5	Surface	0.15
5626338	Motion Sensor	Clear	1.5	Surface	0.15



5626336
Remote Switch



5626337
Built-In Switch



5626338
Motion Sensor

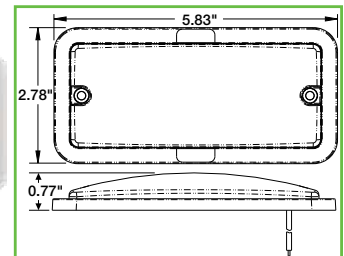

LED Plow Lights

LOW PROFILE HEATED LED PLOW LIGHT

12-24
VOLTS
IP
68

Number of LEDs	15 Clear LEDs
Color Temperature	5200K - 5700K
Connection	19" 6 Pin Deutsch Connector
Mount	Dual Post Mount
Housing	Black Powder-Coated Aluminum

Part No.	Lumens	Amp	Wt. (lbs.)
1312100	High Beam 3600 lm	4.0	12
	Low Beam 1800 lm		

Heated tempered glass lens helps prevent ice from building up.
Over twice as bright as traditional halogens, with a much longer lifespan.
12V relay may be required (not included) for heated function on certain trucks.

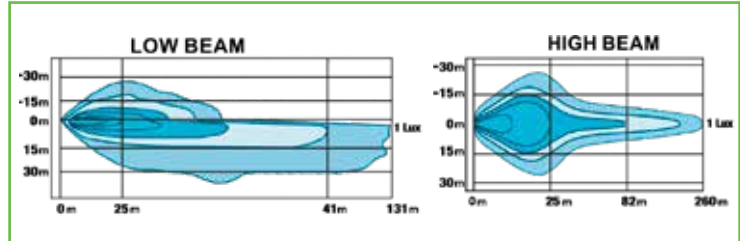
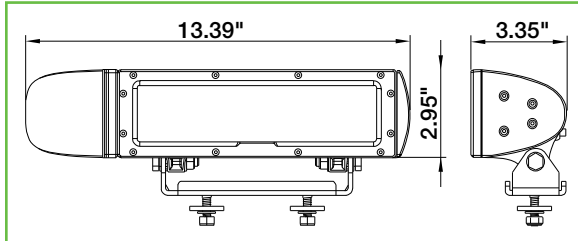

UNIVERSAL HEATED LED SNOW PLOW HEADLIGHTS

12-24
VOLTS
IP
65

Number of LEDs	13 Clear LEDs
Color Temperature	5300K - 6000K
Connection	11" 6 Pin Deutsch Connector
Mount	Single Post Mount
Housing	Black Powder-Coated Aluminum

Part No.	Lumens	Amp	Wt. (lbs.)
1312000	High Beam 2,500 lm	5.5	9.8
	Low Beam 1,200 lm		

Heated tempered glass lens helps prevent ice from building up.
Over twice as bright as traditional halogens, with a much longer lifespan.
12V relay may be required (not included) for heated function on certain trucks.

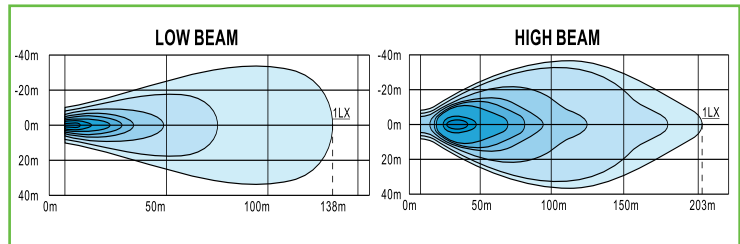
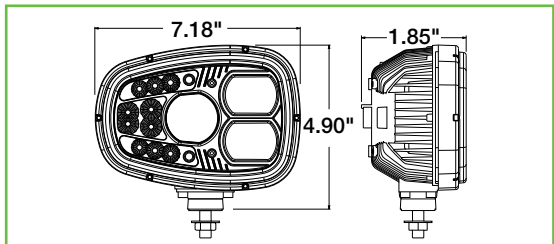

SQUARE HEATED LED PLOW LIGHT WITH MULTI-DIRECTIONAL MOUNT FOR INDICATOR

12-24
VOLTS
IP
68
IP
69K

Number of LEDs	11 Clear LEDs
Color Temperature	5700K
Connection	16" 6 Pin Deutsch Connector
Mount	Multi-Mount
Housing	Black Powder-Coated Aluminum

Part No.	Lumens	Amp	Wt. (lbs.)
 1312200	High Beam 3600 lm Low Beam 1800 lm	5.7	9.5

Heated tempered glass lens helps prevent ice from building up.
Over twice as bright as traditional halogens, with a much longer lifespan.
12V relay may be required (not included) for heated function on certain trucks.

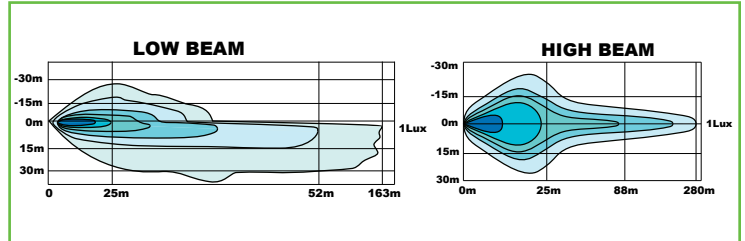
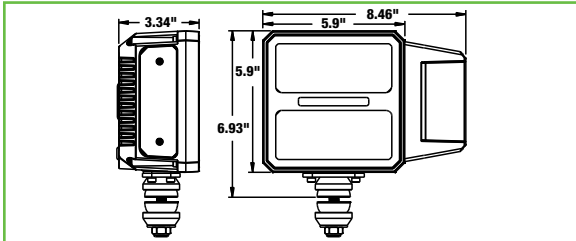

1312000 shown

Halogen Plow Lights

UNIVERSAL SNOWPLOW LIGHT KIT



Number of LEDs	None - Halogen Bulbs
Connection	Universal Wiring Harness
Mount	Dual Post Mount
Housing	High Image Polycarbonate Case

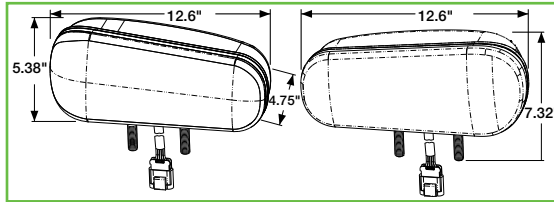

Part No.	Description	Amp	Wt. (lbs.)
1311100	Dual Beam Halogen Headlamps with Turn Signal/Parking Light	24	10.45



Kit includes a universal wiring harness and switch



1311102



1311101



1311103



1311100

Accessories

Part No.	Description
1311110	Headlight Adapter for International® Trucks
1311102	Low Beam Replacement Bulb for 1311100
1311101	Hi Beam Replacement Bulb for 1311100
1311103	Amber Park/Turn Replacement Bulb for 1311100



1311100 shown



STAINLESS STEEL TRUCK HOOD LIGHT BRACKETS



PLB11SS for use with single stud plow lights



PLB12SS for use with 1311100 dual stud plow lights



PLB11SS shown with warning lights and plow light

Part No.	Description	Style	Wt. (lbs.)
PLB11SS	Stainless Steel Truck Hood Light Brackets with Hardware	Single Stud	5.0
PLB12SS	Extended Stainless Steel Truck Hood Light Brackets with Hardware	Dual Stud	5.0

Kit Includes driver & passenger side bracket, gaskets & fasteners.

Universal fit for med./hvy. class truck hoods:

Ford®, Freightliner®, GMC®, International®, Mack®, Peterbilt®, Sterling®, Volvo®

MIRROR MOUNT LIGHT BRACKET KIT



PLB15SS shown with 1312200 plow lights



Part No.	Description	Style	Wt. (lbs.)
PLB15SS	External Mirror Mount Bracket Kit, Fits International Harvester HV507 Series	Single Stud	6.47

Kit Includes driver & passenger side bracket, gaskets & fasteners.

PLOW LIGHT BRACKET KIT FOR MACK GRANITE 2020+

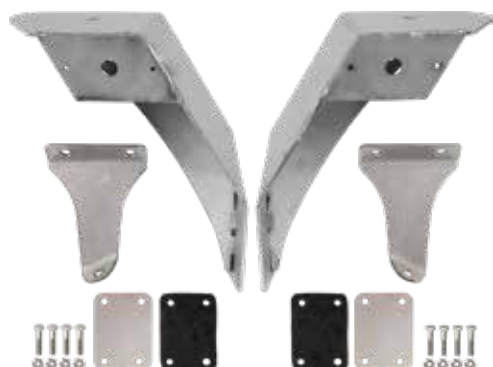

PLB17SS shown with warning lights and plow light

Part No.	Description	Style	Wt. (lbs.)
PLB17SS	Plow Light Bracket Kit, Fits MACK	Single Stud	15.76

Kit Includes driver & passenger side bracket, gaskets & fasteners.

LED Modular Light Bars

LED MODULAR LIGHT BAR SERIES



- 13" wide x 2" tall
- Optional work lights and take down lights on 49" and 60" models
- Mounting feet and controller sold separately (see pg 176)
- Available in 24", 49", and 60" sizes

- Customize by adding amber, blue, green, clear and/or red strobes
- Middle strobes have 3-LED reflector heads
- Corner strobes have 6-LED D-fuser heads
- Dimming mode
- Extruded aluminum frame

24" LED MODULAR LIGHT BAR



49" LED MODULAR LIGHT BAR



60" LED MODULAR LIGHT BAR



8893060 shown with mounting feet
(Mounting feet and controller sold separately)

Part No.	Size	LEDs	Amp	Modules Description	Chassis Diagram	Wt. (lbs.)
8893024	24"	36	3-6	8 Amber		15.4
88930243	24"	36	3-6	4 Amber, 4 Clear		15.4
3031043	24"	36	3-6	4 Amber, 4 Blue		15.4
3034374	24"	36	3-6	4 Amber, 4 Green		15.4
8893049	49"	54	7-14	14 Amber Built-in Traffic Advisor		33.0
3026981	49"	60	7-14	8 Amber, 8 Clear		33.5
3046364	49"	72	7-14	12 Amber, 4 Take Down Lights		33.5
88930492	49"	36	7-14	8 Amber		31.8
3040855	49"	36	7-14	8 Amber, 2 Take Down Lights		31.8
88930493	49"	36	7-14	4 Amber, 4 Clear		31.8
8893060	60"	60	8-16	14 Amber, 2 Red Stop-Turn-Tail Lights Built-in Traffic Advisor		36.1
3031546	60"	48	8-16	6 Amber, 6 Clear		36.1
3053887	60"	48	8-16	9 Amber, 9 Clear		36.1
88930603	60"	42	8-16	8 Amber, 2 Red Stop-Turn-Tail Lights 2 Take Down Lights		34.7
88930604	60"	48	8-16	12 Amber		34.9
3030056	60"	60	8-16	10 Amber, 4 Clear, 2 Red Stop-Turn-Tail Lights		34.9
88930605	60"	60	8-16	16 Amber Built-in Traffic Advisor		36.1



BUYERS CUSTOM LIGHT BARS

CUSTOMIZING STOCK LIGHT BARS





MODULAR LIGHT BARS CAN BE CUSTOMIZED BY PURCHASING THE ACCESSORY LIGHT HEADS LISTED BELOW. THIS ALLOWS LIGHT HEADS TO BE ADDED OR COLORS TO BE CHANGED WITHOUT HAVING TO BUY A NEW LIGHT BAR. TAKEDOWN AND ALLEY LIGHTS CAN ALSO BE ADDED TO 49" AND 60" MODELS (NOT 24").

LED MIDDLE STROBE

5-YEAR
W
12-24
VOLTS



3024631

	Part No.	LEDs	Color	Wt. (lbs.)
	3024631	3	Amber	0.28
	3024632	3	Clear	0.27
	3024633	3	Red	0.28
	3024634	3	Blue	0.27
	3032932*	3	Green	0.28





*3032932 is not CA13 or SAE J595 Class 1

LED CORNER STROBE

5-YEAR
W
12-24
VOLTS



3024635

	Part No.	LEDs	Color	Wt. (lbs.)
	3024635	6	Amber	0.21
	3024636	6	Clear	0.20
	3024637	6	Red	0.21
	3024638	6	Blue	0.21
	3032933*	6	Green	0.21

*3032933 is not CA13 or SAE J595 Class 1

LED MIDDLE TAKE DOWN LIGHT HEAD

5-YEAR
W
12-24
VOLTS



3024639

Part No.	LEDs	Color	Wt. (lbs.)
3024639	6	Clear	0.23
3024640	9	Clear	0.23

LED ALLEY LIGHTS

5-YEAR
W
12
VOLTS



Part No.	LEDs	Color	Wt. (lbs.)
3024642	3	Clear	0.14

LED Modular Light Bar Accessories

PLASTIC MOUNTING FEET FOR LED MODULAR LIGHT BAR



3024646 shown with 24" light bar

Part No.	Size	Wt. (lbs.)
3024646	12.625"L x 5.50"W x 2.25"T	2.58

Feet have an adjustable width.
Used in conjunction with stainless steel strap kits.

STEEL MOUNTING FEET FOR LED MODULAR LIGHT BAR



3024647 shown with 24" light bar

Part No.	Size	Wt. (lbs.)
3024647	10.125"L x 6.5"W x 2-3"T	3.89

Feet have an adjustable height and are black powder-coated.
Used in conjunction with stainless steel strap kits.

HEADACHE RACK STEEL MOUNTING FEET FOR LED MODULAR LIGHT BARS



3024648 shown with 24" light bar

Part No.	Size	Wt. (lbs.)
3024648	4.5"L x 6.75"W x 1.75"T	3.16

Black powder-coat finish.
Designed with a narrow surface for tight spaces.

WIDE-SURFACE STEEL MOUNTING FEET FOR LED MODULAR LIGHT BARS



3024649 shown with 24" light bar

Part No.	Size	Wt. (lbs.)
3024649	8.75"L x 2.50"W x 2.25"T	2.47

Black powder-coat finish.
Designed for use on flat surfaces or cab roofs.

STAINLESS STEEL STRAP KITS FOR LED MODULAR LIGHT BARS



3034400

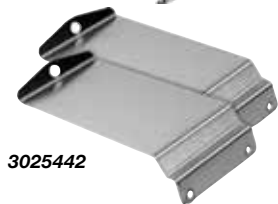

3025442



3026116

Ford Trucks

Part No.	Make/Model	Wt. (lbs.)
3034400	F-150 (2015+) F250/F550 (2017+), Light Bars: 49", 54" & 60"	1.60
3026115	F-250/350/450/550 (1999-2016), Light Bars: 49", 54" & 60"	1.60

GM/Chevy Trucks

Part No.	Make/Model	Wt. (lbs.)
3025442	GM1500/2500/3500/4500/5500 (Up to 2018), Light Bars: 49", 54" and 60"	1.53
3042509	GM1500/2500/3500 (2019+), Light Bars: 49", 54" and 60"	1.53

Dodge/RAM Trucks

Part No.	Make/Model	Wt. (lbs.)
3026116	RAM 500/2500/3500/4500/5500, (2009-2018), Light Bars: 49", 54" and 60"	1.60



5 SWITCH PANEL, PRE-WIRED



Part No.	Description	Wt. (lbs.)
6391205	5-Switch Panel, Pre-Wired, 3.5"L x 1.0"W x 2.5"T	0.35

For use with 49", 54" & 60" modular light bars, plus surface and recessed mounted strobes.

6 SWITCH PANEL, PRE-WIRED WITH LED PATTERN DISPLAY



Part No.	Description	Wt. (lbs.)
6391206	6-Switch Panel, Pre-Wired with LED Pattern Display, 6.5"L x 0.75"W x 2.75"T	0.39

Built-in traffic advisor controls.

For use with 49", 54" & 60" modular light bars.

7 FUNCTION PROGRAMMABLE SWITCH PANEL



Part No.	Description	Wt. (lbs.)
6391208	Switch Panel, 7 Function, Multi-Purpose, Programmable	0.83

The programmable panel supports up to 7 functions, and can be used to control multiple lights and/or other equipment.

For use with 49" and 60" modular light bars.

8 FUNCTION PROGRAMMABLE SWITCH PANEL WITH RELAYS



Part No.	Description	Wt. (lbs.)
6391209	Switch Panel, 8 Function, Multi-Purpose, Programmable with Relays	0.83

The programmable panel supports up to 7 functions, and can be used to control multiple lights and/or other equipment.

The relay allows the switch panel to deliver additional amperage to lighting accessories with higher power demands.

For use with 49" and 60" modular light bars.

LED Light Bars

48" LIGHT BAR WITH WIRELESS REMOTE

5-YEAR WARRANTY	Number of LEDs	136
	Number of Flash Patterns	13
12-24 VOLTS	Lead Length	25'
	Housing	Aluminum
IP 67	Mount	Feet and Strap Kit Included
	SAE J943 CLASS 1	

Light features a wireless hand held remote that displays the patterns being used.



Included mounting feet and stainless steel strap kit



INCLUDES: Wireless remote control. Screen indicates light bars functions.

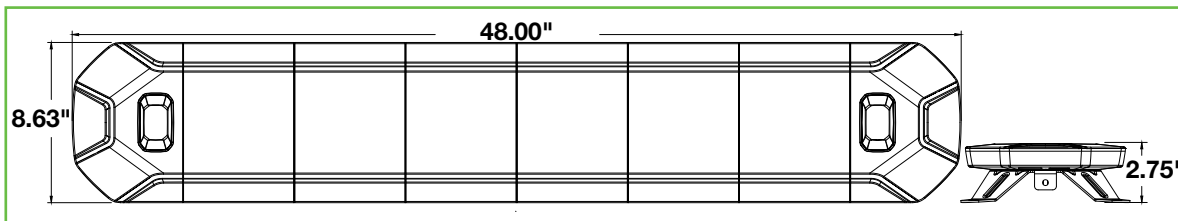

Single Color

Part No.	Color	Amp	Wt. (lbs.)
8893048	Amber	11.30	20



Dual Color

Part No.	Color	Amp	Wt. (lbs.)
8893148	Amber/Clear	11.30	20



8893048 shown



12" WIRELESS RECHARGEABLE LED LIGHT BAR WITH REMOTE **NEW**

1-YEAR
W
12-24
VOLTS
IP
67
CA
13
SAE J845
CLASS
1

Number of LEDs	84
Number of Flash Patterns	7
Battery Life	Up to 6.5 Hours
Charging Cord	11.5"
Mount	2 Magnetic Mounts

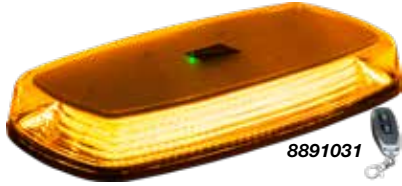
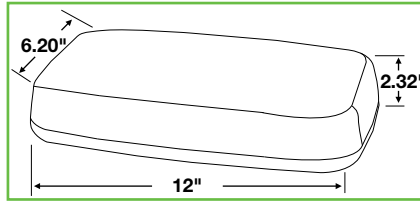

Part No.	Color	Amp	Wt. (lbs.)
8891031	Amber	2.5	3.08



Light alternates between Amber and Clear

Part No.	Color	Amp	Wt. (lbs.)
8891032	Amber/Clear	2.5	3.08

Available Q2 of 2024



Light alternates between Amber and Green

Part No.	Color	Amp	Wt. (lbs.)
8891039	Amber/Green	2.5	3.08

Available Q2 of 2024

11" RECTANGULAR MULTI-MOUNT LED MINI LIGHT BAR

5-YEAR
W
12-24
VOLTS
IP
67

Number of LEDs	24
Number of Flash Patterns	10
Lead Length	15' with ON/OFF and Pattern Switch
Mount	Permanent or Magnetic

See pg. 184-185 for Drill-Free Cab Mount Options

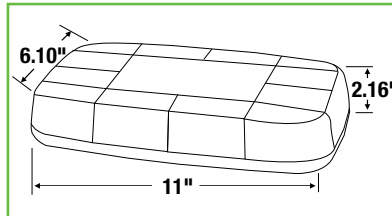

Single Color SAE J845 Class 1 Light Bar

SAE J845
CLASS
1

Part No.	Color	Amp	Wt. (lbs.)
8891040	Amber	2.0	3.5



Part No.	Color	Amp	Wt. (lbs.)
8891042	Amber/Clear	2.0	3.5



Part No.	Color	Amp	Wt. (lbs.)
8891049	Amber/Green	2.0	3.5

LED Mini Light Bars

11" RECTANGULAR MAGNETIC MOUNT LED MINI LIGHT BAR

5-YEAR
W
12
VOLTS
IP
67
SAE J849
CLASS
1

Number of LEDs	48
Flash Patterns	4
Lead Length	15' with ON/OFF
Mount	Magnetic

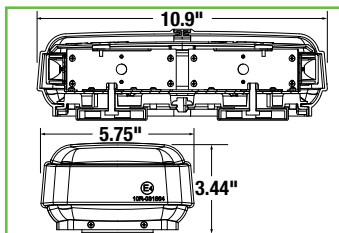

Magnetic mounts



Part No.	Color	Amp	Wt. (lbs.)
8891050	48 Amber	2.1	4.0



Part No.	Color	Amp	Wt. (lbs.)
8891052	24 Amber, 24 Clear	2.1	4.0



Part No.	Color	Amp	Wt. (lbs.)
8891059	24 Amber, 24 Clear	2.1	4.0

Available Q2 of 2024

15" OCTAGONAL LED MINI LIGHT BAR SERIES

5-YEAR
W
12-24
VOLTS
IP
67
SAE J849
CLASS
1

Number of Flash Patterns	10
Lead Length	15' with ON/OFF and Pattern Switch
Mount	Permanent or Magnetic

See pg. 184-185 for Drill-Free Cab Mount Options

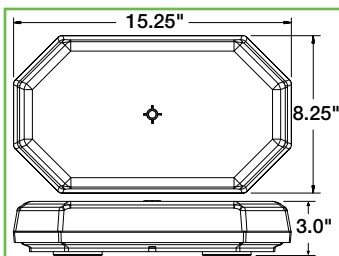

Permanent mounting studs and magnetic mounts



Part No.	Number of LEDs	Color	Amp	Wt. (lbs.)
8891060	68 Amber	Amber	2.0	5.5



Part No.	Number of LEDs	Color	Amp	Wt. (lbs.)
8891062	34 Amber, 34 Clear	Amber/Clear	3.0	5.5



Part No.	Number of LEDs	Color	Amp	Wt. (lbs.)
8891068	34 Amber, 34 Blue	Amber/Blue	4.7	5.5



Part No.	Number of LEDs	Color	Amp	Wt. (lbs.)
8891069	34 Amber, 34 Green	Amber/Green	3.4	5.5



16" MULTI-MOUNT DUAL COLOR LED MINI LIGHT BAR SERIES

5-YEAR
W
12-24
VOLTS
IPX
4K
SAE J848
CLASS
1

Number of LEDs	72
Number of Flash Patterns	26
Lead Length	15' with ON/OFF and Pattern Switch
Mount	Permanent or Magnetic

See pg. 184-185 for Drill-Free Cab Mount Options

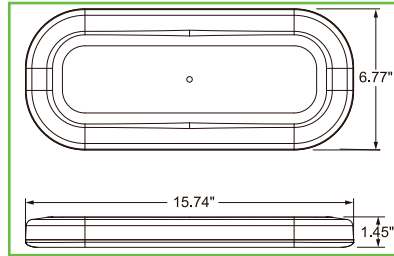

Magnetic and permanent mounting options



8891160

Full light alternates between Amber and Clear



8891161

Full light alternates between Amber and Blue



8891162

Full light alternates between Amber and Green

Part No.	Description	Amp	Wt. (lbs.)
8891160	36 Amber, 36 Clear	3	4

Part No.	Description	Amp	Wt. (lbs.)
8891161	36 Amber, 36 Blue	3	4

Part No.	Description	Amp	Wt. (lbs.)
8891162	36 Amber, 36 Green	3	4

Available Q2 of 2024

13" MULTI-MOUNT DUAL COLOR LED MINI LIGHT BAR SERIES **NEW**

5-YEAR
W
12-24
VOLTS
SAE J848
CLASS
1
IP
66

Number of LEDs	48
Number of Flash Patterns	10
Lead Length	15' with ON/OFF and Pattern Switch
Mount	Permanent or Magnetic

See pg. 184-185 for Drill-Free Cab Mount Options

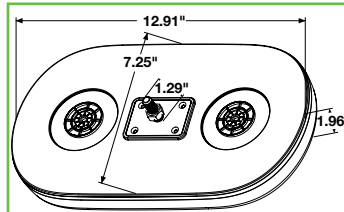

Permanent mounting stud and magnetic mounts



8891170



8891172

Full light alternates between Amber and Clear



8891179

Full light alternates between Amber and Green

Part No.	Color	Amp	Wt. (lbs.)
8891170	Amber	2.63	2.5

Part No.	Color	Amp	Wt. (lbs.)
8891172	Amber/Clear	2.63	2.5

Part No.	Color	Amp	Wt. (lbs.)
8891179	Amber/Green	2.63	2.5

LED Mini Light Bars

10" OVAL LOW PROFILE LED MINI LIGHT BAR

5-YEAR W 12-24 VOLTS IP 67 <small>SAE J849 CLASS 1</small>	Number of LEDs	40
	Flash Patterns	20
	Lead Length	15' with ON/OFF and Pattern Switch
	Mount	Permanent or Magnetic

See pg. 184-185 for Drill-Free Cab Mount Options

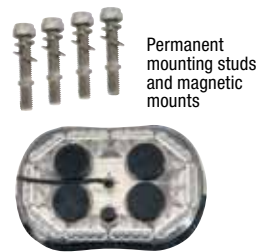
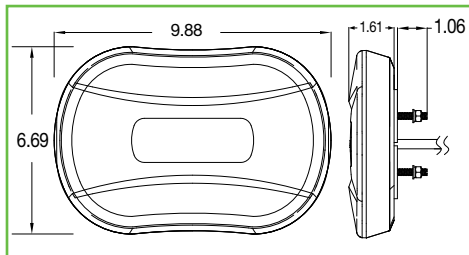

8891080



8891082



8891089

Part No.	Color	Amp	Wt. (lbs.)
8891080	Amber	3.34	3.1

Part No.	Color	Amp	Wt. (lbs.)
8891082	Amber/Clear	3.34	3.1

Part No.	Color	Amp	Wt. (lbs.)
8891089	Amber/Green	3.34	3.1

Available Q2 of 2024

15" HEXAGONAL LOW PROFILE MINI LIGHT BAR

5-YEAR W 12-24 VOLTS IP 67 <small>SAE J849 CLASS 1</small>	Number of LEDs	48
	Number of Flash Patterns	10
	Lead Length	15' with ON/OFF and Pattern Switch
	Mount	Permanent or Magnetic

See pg. 184-185 for Drill-Free Cab Mount Options

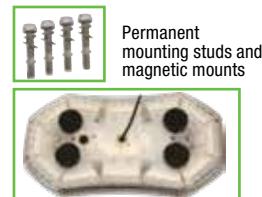
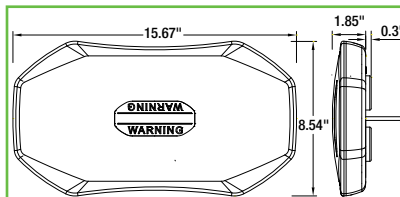

8891110



8891111



8891119

Part No.	Color	Amp	Wt. (lbs.)
8891110	Amber	3.52	4.65

Part No.	Color	Amp	Wt. (lbs.)
8891111	Amber/Clear	3.52	4.65

Part No.	Color	Amp	Wt. (lbs.)
8891119	Amber/Green	3.52	4.65

Available Q2 of 2024

8891110 & 8895301 shown



16.5" RECTANGULAR LED MINI LIGHT BAR

5-YEAR
W
12-24
VOLTS
SAE J845
CLASS
1

Number of LEDs	18
Flash Patterns	19
Lead Length	15' with ON/OFF and Pattern Switch
Mount	Vacuum or Magnetic

See pg. 184-185 for Drill-Free Cab Mount Options

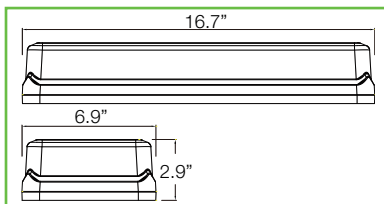

Vacuum mounting cups and magnetic mounts



8891090



8891092



8891099



8891091
Permanent mounting studs and magnetic mounts

Part No.	Color	Amp	Wt. (lbs.)
8891090	Amber	3.2	7.78

Part No.	Color	Amp	Wt. (lbs.)
8891092	Amber/Clear	3.2	7.78

Available Q2 of 2024

Part No.	Color	Amp	Wt. (lbs.)
8891099	Amber/Green	3.2	7.78

Available Q2 of 2024

Accessories

Part No.	Description	Wt. (lbs.)
8891091	Aluminum Light Bar Mounting Bracket Kit	1.7

17" OCTAGONAL MINI LIGHT BAR

5-YEAR
W
12-24
VOLTS
SAE J845
CLASS
1

Number of LEDs	30
Number of Flash Patterns	25
Lead Length	15' with ON/OFF and Pattern Switch
Mount	Magnetic

See pg. 184-185 for Drill-Free Cab Mount Options

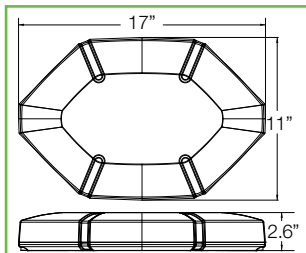

Magnetic mounts and hardware

SAE J845
CLASS
1



8891100



8891102



8891109

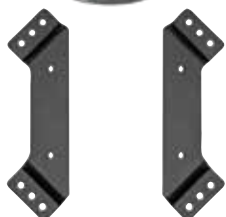

8891010
Includes mounting brackets with 4 bolts and washers

Single Color SAE J845 Class 1 Light Bar

Part No.	Color	Amp	Wt. (lbs.)
8891100	Amber	3.6	9.9

Dual Color Light Bar

Part No.	Color	Amp	Wt. (lbs.)
8891102	Amber/Clear	3.6	9.9

Dual Color Light Bar

Part No.	Color	Amp	Wt. (lbs.)
8891109	Amber/Green	3.6	9.9

Available Q2 of 2024

Accessories

Part No.	Description	Wt. (lbs.)
8891010	Aluminum Mounting Brackets for 8891100 and 8891102	0.7

Drill-Free Light Bar Mounts

PRO SERIES DRILL-FREE LIGHT BAR CAB MOUNT

Construction	Rustproof Aluminum
Finish	Black Powder-Coated
Capacity	30 lbs.
Size	22" L x 10" W



8895560 shown with 8891060 light bar (sold separately)



8895560 shown with light bar 8891060 (not included)



8895580

Ford Trucks

Part No.	Make/Model	Wt. (lbs.)
8895560	Ford F-150 (2015+), Ford F-250-550 (2017+) and Ranger SuperCrew (2019+)	13.2

Installs in third light OEM location, no drilling required.

GM/Chevy Trucks

Part No.	Make/Model	Wt. (lbs.)
8895580	1500-4500 LT / LD with Spoiler (2020+)	13.2

Installs in third light OEM location, no drilling required.

Available Q2 of 2024

DRILL-FREE LIGHT BAR CAB MOUNT

Construction	Rustproof Aluminum
Finish	Black Powder-Coated
Capacity	30 lbs.
Size	22" L x 10" W



8895152 shown with light bar 8891060 (not included)



8895115



8895302



8895405

Ford Trucks

Part No.	Make/Model	Wt. (lbs.)
8895152	Ford F-150 (2015+), Ford F-250-550 (2017+)	7.25
8895153	Ranger (2019+)	7.25
8895250	Ford SuperDuty with Legacy Steel Cab F-250-550 (2006-2016)	7.25
8895155	Ford Maverick (2022+)	8

Installs in third light OEM location, no drilling required.

GM/Chevy Trucks

Part No.	Make/Model	Wt. (lbs.)
8895115	1500-4500 LT / LD with Spoiler (2020+)	3.5
8895100	1500-3500 (2014-2018, All Models), 1500-3500 (2019 All Models) Except 1500 LT & LTZ 4500-6500 (2020+) International CV (2020+)	7.25
8895105	For Chevy Colorado-GMC Canyon (2015-2022)	7.25
8895120	1500-3500 Chevy/GMC (2020) Work Truck Cab	7.25

Installs in third light OEM location, no drilling required.

Dodge/RAM Trucks

Part No.	Make/Model	Wt. (lbs.)
8895301	1500 Classic / 2500-5500 All Models (2019+)	8.0
8895302	1500 No Classic (2019+)	7.25

Installs in third light OEM location, no drilling required.

Nissan Trucks

Part No.	Make/Model	Wt. (lbs.)
8895405	Nissan Frontier (2023-2024)	6.0

Installs in third light OEM location, no drilling required.



FLEET SERIES DRILL-FREE LIGHT BAR CAB MOUNT

Construction	Rustproof Aluminum
Finish	Black Powder-Coated
Capacity	30 lbs.
Size	22" L x 10"W



8895551 shown with **8891060** light bar (sold separately)



8895556 shown with **8891042** light bar (sold separately)



8895551



8895554



8895556

Ford Trucks

Part No.	Make/Model	Wt. (lbs.)
8895551	Ford F-150 (2015+) and Ford F-250/550 (2017+), Aluminum Construction	6.46
8895553	Ford F-150 (2015+) and Ford F-250/550 (2017+), Steel Construction	6.46

Installs in third light OEM location, no drilling required.

GM/Chevy Trucks

Part No.	Make/Model	Wt. (lbs.)
8895554	1500-3500 Chevy/GMC Work Truck Cab (2020)	6.46

Installs in third light OEM location, no drilling required.

Dodge/RAM Trucks

Part No.	Make/Model	Wt. (lbs.)
8895556	1500 Classic / 2500-5500 All Models (2019+)	6.46

Installs in third light OEM location, no drilling required.

SELF-ADHESIVE MAGNETIC MOUNT PAD FOR ALUMINUM CABS

Construction	Carbon Steel
Finish	Black Powder-Coated
Size	3.5" L x 3.5"W
Mount	3M® Tape

Allows use of magnetic light mounts even on aluminum truck cabs



8895400



8895400 shown with **SL695A** beacon



8895400 shown with **8891031** mini light bar

Note: Allows use of magnetic light mounts even on aluminum truck cabs

Part No.	Description	Wt. (lbs.)
8895400	Self-Adhesive Magnetic Mount Pad for Aluminum Cabs, Single	0.27
8895404	Self-Adhesive Magnetic Mount Pad for Aluminum Cabs, 4 pack	1.02

Traffic Advisors

LED TRAFFIC ADVISOR / STROBE WITH FLOOD LIGHT

5-YEAR W 12-24 VOLTS IP 67 CA 13 SAE J599 CLASS 1	Number of Flash Patterns	50 Strobe 16 Traffic Arrows 1 Flood
	Color	Amber or Clear for Strobe and Traffic Arrows Clear for Flood
	Lead Length	25'
Housing	Aluminum	
Mount	Rear Angle Mounts Included	

Combines an SAE J595 Class 1 strobe, traffic advisor with 16 different arrows, and a bright flood light into a single versatile fixture.

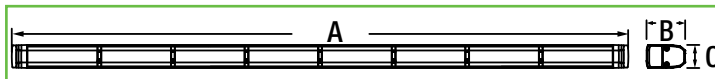

Part No.	LEDs	A	B	C	Amp	Wt. (lbs.)
8894134	96 LEDs	33.7"	2.1"	1.25"	3.0	5.5
8894142	108 LEDs	41.7"	2.1"	1.25"	3.0	6.6



8894142
In Strobe Mode

2 LIGHTS IN ONE!



8894142
In Flood Light Mode



6391207

Accessories

Part No.	Description	Wt. (lbs.)
6391207	6-Switch Panel, Pre-Wired with LED Pattern Display, 6.5"L x 0.75"W x 2.75"T	0.39

Built-in traffic advisor controls.

8894134 shown installed on Buyers Kabgard™ 85204



LED TRAFFIC ADVISOR/STROBE



Number of Flash Patterns	11 Strobe
	11 Traffic Arrows
Color	Amber
Lead Length	25'
Housing	Aluminum
Mount	Mounting Brackets Included

Mounting brackets can be set at various widths to accommodate a variety of applications.

Adjustable width mounting studs

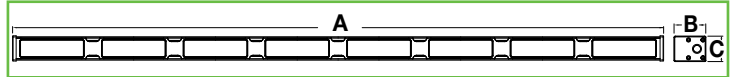

Part No.	LEDs	A	B	C	Amp	Wt. (lbs.)
8894037	24	36.7"	2.25"	1.81"	3.2	6.6
8894047	32	46.5"	2.25"	1.81"	3.2	7.5



8894047



8894050 Riser Mounts



6391204



6391207



8894056

Accessories

Part No.	Description	Wt. (lbs.)
8894050	Optional L-Bracket Riser Mounts - 4.3" H	0.5

Accessories

Part No.	Description	Wt. (lbs.)
6391204	4-Switch Panel, Pre-Wired, 3.75"L x 1.25"W x 1.5"T	0.27
6391207	6-Switch Panel, Pre-Wired with LED Pattern Display, 6.5"L x 0.75"W x 2.75"T	0.39

Built-in traffic advisor controls.

Accessories

Part No.	Description	Wt. (lbs.)
8894056	8-Strand Bulk Wire, 50ft, For 8894037 & 8894047	4.5



8894047 shown installed on Buyers Kabgard™ 85204

Strobe Lights

3.5" LED STROBE LIGHT SERIES

5-YEAR W	Number of LEDs	3
12-24 VOLTS	Housing	Aluminum
IP X8	Mounting	3M Adhesive or 2 Screws
CA 13	Number of Flash Patterns	12
	Synchronous	Yes
	Alternating	Yes



8892230



8892232



Mounting Hardware

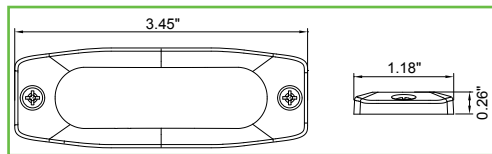

SAE J595 CLASS 1

SAE J595 Class 1

Part No.	Color	Amp	Wt. (lbs.)
8892230	Amber	0.5	0.08
8892231	Clear	0.5	0.08
8892233	Red	0.5	0.08
8892234	Blue	0.5	0.08

Part No.	Color	Amp	Wt. (lbs.)
8892239	Green	0.5	0.08

Accessories

Part No.	Description	Wt. (lbs.)
8892232	Black 90° Mounting Bracket For 8892230 Series Strobe Lights	0.04

4.5" LED STROBE LIGHT

5-YEAR W	Number of LEDs	4
12-24 VOLTS	Housing	Aluminum
IP X8	Mounting	3M Adhesive or 2 Screws
CA 13	Number of Flash Patterns	23
	Synchronous	Yes
	Alternating	Yes



8892240



8892252



Mounting Hardware

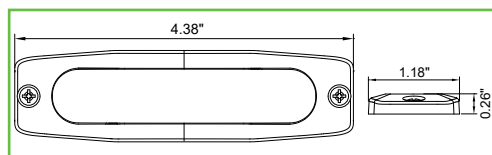

SAE J595 CLASS 1

SAE J595 Class 1

Part No.	Color	Amp	Wt. (lbs.)
8892240	Amber	0.65	0.10
8892241	Clear	0.65	0.10
8892243	Red	0.65	0.10
8892244	Blue	0.65	0.10

Part No.	Color	Amp	Wt. (lbs.)
8892242	Amber/Clear	0.65	0.10
8892245	Red/Blue	0.65	0.10
8892248	Blue/Amber	0.65	0.10
8892249	Green	0.65	0.10
8892250	Green/Amber	0.65	0.10

Accessories

Part No.	Description	Wt. (lbs.)
8892252	Black 90° Mounting Bracket For 8892240 Series Strobe Lights	0.04



5" LED STROBE LIGHT



Number of LEDs	6
Housing	Aluminum
Mounting	3M Adhesive or 2 Screws
Number of Flash Patterns	23
Synchronous	Yes
Alternating	Yes



8892200



8892225

Mounting Hardware

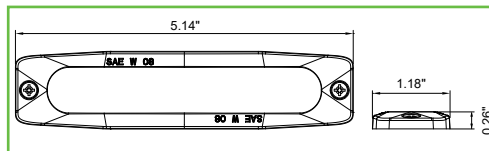

SAE J595 CLASS 1

SAE J595 Class 1

Part No.	Color	Amp	Wt. (lbs.)
8892200	Amber	1.0	0.09
8892201	Clear	1.0	0.09
8892203	Red	1.0	0.09
8892204	Blue	1.0	0.09

Part No.	Color	Amp	Wt. (lbs.)
8892202	Amber/Clear	1.0	0.09
8892205	Red/Blue	1.0	0.09
8892206	Amber/Red	1.0	0.09
8892207	Clear/Red	1.0	0.09
8892208	Amber/Blue	1.0	0.09
8892209	Green	1.0	0.09
8892210	Amber/Green	1.0	0.09

Accessories

Part No.	Description	Wt. (lbs.)
8892225	Black Mounting Bracket for 8892200 Series Strobe Lights	0.04

DUAL ROW 5" LED STROBE LIGHT



Number of LEDs	12
Housing	Aluminum
Mounting	3M Adhesive or 2 Screws
Number of Flash Patterns	30
Synchronous	Yes
Alternating	Yes



8890400



Mounting Hardware

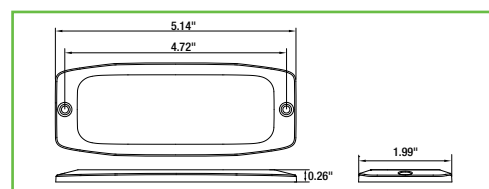

SAE J595 CLASS 1

SAE J595 Class 1

Part No.	Color	Amp	Wt. (lbs.)
8890400	Amber	1.5	0.2

Part No.	Color	Amp	Wt. (lbs.)
8890402	Amber/Clear	1.5	0.2
8890409	Green	1.5	0.2
8890410	Amber/Green	1.5	0.2

Strobe Lights

ULTRA THIN SQUARE 2" LED STROBE LIGHT

5-YEAR W 12-24 VOLTS IP X7 CA 13 <small>SAE J595 CLASS 1</small> 	Number of LEDs	4
	Housing	Aluminum
	Mounting	3M Adhesive or 2 Screws
	Number of Flash Patterns	18
	Synchronous	Yes
	Alternating	Yes

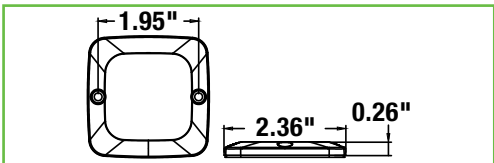

	Part No.	Color	Amp	Wt. (lbs.)
	8892140	Amber	0.45	0.06
	8892141	Clear	0.45	0.06

8892140



Mounting Hardware

FLEXIBLE SILICON LED STROBE LIGHT **NEW**

5-YEAR W 12-24 VOLTS IP X7 CA 13 	Number of LEDs	6 Single - 12 Dual Color
	Housing	Aluminum
	Mounting	3M Adhesive or 2 Screws Supports up to 120° Bend
	Number of Flash Patterns	See Chart
	Synchronous	Yes
	Alternating	Yes

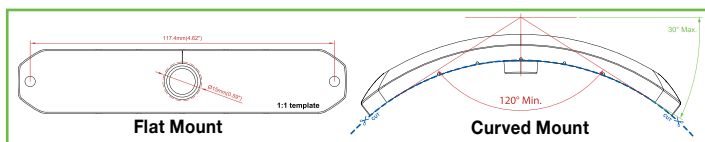
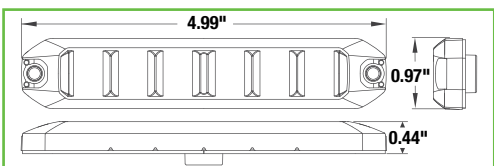

8890700



Shown with 120° Bend



3M Adhesive Backing



Mounting Hardware

SAE J595 Class 1



	Part No.	Color	Flash	Amp	Wt. (lbs.)
	8890700	Amber	20	0.64	0.07
	8890702	Amber/ Clear	30	0.64	0.07
	8890708	Amber/ Blue	30	0.64	0.07
	8890709	Amber/ Green	30	0.64	0.07

Available Q2 of 2024



ULTRA THIN WIDE ANGLE 4" LED STROBE LIGHT



Number of LEDs	6
Housing	Aluminum
Number of Flash Patterns	16
Synchronous	Yes
Alternating	Yes



8890600

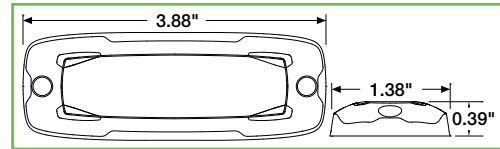

	Part No.	Color	Amp	Wt. (lbs.)
	8890600	Amber	0.88	0.18
	8890601	Clear	0.88	0.18

ULTRA THIN WIDE ANGLE 5" DUAL COLOR LED STROBE LIGHT



Number of LEDs	12
Housing	Aluminum
Number of Flash Patterns	See Chart
Synchronous	Yes
Alternating	Yes



8890300



8890320

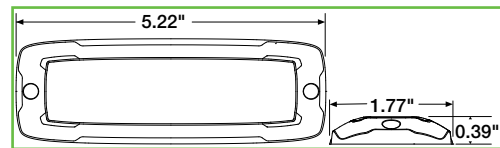

SAE J595 Class 1



	Part No.	Color	Amp	Flash	Wt. (lbs.)
	8890300	Amber	0.88	16	0.24
	8890301	Clear	0.88	16	0.24

	Part No.	Color	Amp	Flash	Wt. (lbs.)
	8890302	Amber/Clear	0.88	26	0.24

	8890305	Red/Blue	0.88	26	0.24
--	---------	----------	------	----	------

	8890306	Amber/Red	0.88	26	0.24
--	---------	-----------	------	----	------

	8890307	Clear/Red	0.88	26	0.24
--	---------	-----------	------	----	------

	8890308	Amber/Blue	0.88	26	0.24
--	---------	------------	------	----	------

	8890310	Amber/Green	0.88	26	0.24
--	---------	-------------	------	----	------

Accessories

	Part No.	Description	Wt. (lbs.)
	8890320	Chrome Bezel For 8890300 Series Strobe Lights	0.04

Strobe Lights

3.375" WIDE ANGLE TRIPLE COLOR LED STROBE LIGHT **NEW**



Number of LEDs	9
Housing	Aluminum
Number of Flash Patterns	28
Synchronous	Yes
Alternating	Yes

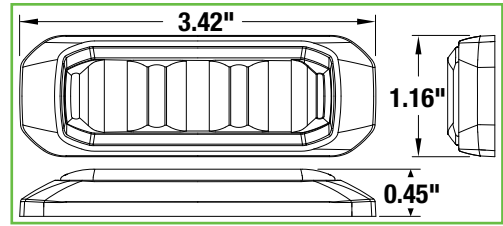

3 COLORS IN ONE!



Full light alternates between Amber, Clear, and Green

SAE J595 Class 1

Part No.	LED Color	Amp	Flash	Wt. (lbs.)
8890929	3 Amber 3 Clear 3 Green	0.78	28	0.16

Available Q2 of 2024

WIDE ANGLE TRIPLE COLOR LED STROBE LIGHT **NEW**



Number of LEDs	18 (6 per color)
Housing	Aluminum
Number of Flash Patterns	28
Synchronous	Yes
Alternating	Yes

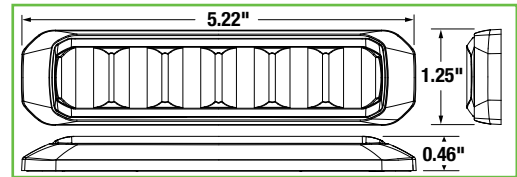

3 COLORS IN ONE!



Full light alternates between Amber, Clear, and Green

SAE J595 Class 1

Part No.	LED Color	Amp	Flash	Wt. (lbs.)
8891829	6 Amber 6 Clear 6 Green	0.90	28	0.23

Available Q2 of 2024



THIN 3.5" LED STROBE LIGHT



Number of LEDs	3
Housing	Aluminum
Number of Flash Patterns	12
Synchronous	Yes
Alternating	Yes



8892300



8892320



8892325

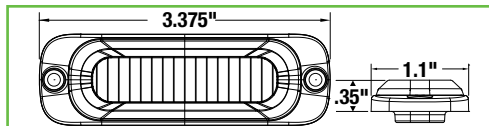

SAE J595 Class 1

	Part No.	Color	Amp	Wt. (lbs.)
	8892300	Amber	0.24	0.11
	8892301	Clear	0.24	0.11

Strobes must be mounted in horizontal orientation to achieve Class 1 rating

Accessories

	Part No.	Description	Wt. (lbs.)
	8892320	Chrome Bezel for Thin Mount LED Lights	0.02
	8892325	Black, 90 Degree Mounting Bracket	0.06



8891900 shown



StrobeConnect Supported



ProConnect Supported

Strobe Lights

THIN 4.5" VERTICAL LED STROBE LIGHT



Number of LEDs	6
Housing	Aluminum
Number of Flash Patterns	19
Synchronous	Yes
Alternating	Yes



8891910



8891920



8891925

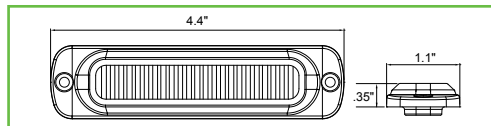

SAE J595 Class 1



	Part No.	Color	Amp	Wt. (lbs.)
	8891910	Amber	1.0	0.15
	8891911	Clear	1.0	0.15
	8891913	Red	1.0	0.15
	8891914	Blue	1.0	0.15

Strobes must be mounted in vertical orientation to achieve Class 1 rating

	Part No.	Color	Amp	Wt. (lbs.)
	8891912	Amber/Clear	1.0	0.15

Accessories

	Part No.	Description	Wt. (lbs.)
	8891920	Chrome Bezel for Thin Mount LED Lights	0.02
	8891925	Black, 90 Degree Mounting Bracket	0.06

THIN 4.5" HORIZONTAL LED STROBE LIGHT



Number of LEDs	6
Housing	Aluminum
Number of Flash Patterns	19
Synchronous	Yes
Alternating	Yes



8891900



8891920



8891925

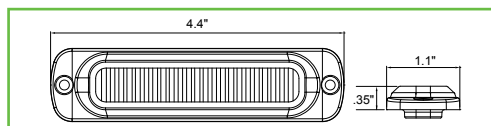

SAE J595 Class 1



	Part No.	Color	Amp	Wt. (lbs.)
	8891900	Amber	1.0	0.15
	8891901	Clear	1.0	0.15
	8891903	Red	1.0	0.15
	8891904	Blue	1.0	0.15

Strobes must be mounted in horizontal orientation to achieve Class 1 rating

	Part No.	Color	Amp	Wt. (lbs.)
	8891902	Amber/Clear	1.0	0.15

Accessories

	Part No.	Description	Wt. (lbs.)
	8891920	Chrome Bezel for Thin Mount LED Lights	0.02
	8891925	Black, 90 Degree Mounting Bracket	0.06



THIN 4.5" DUAL COLOR LED STROBE LIGHT



Number of LEDs	12 (6 per color)
Housing	Aluminum
Number of Flash Patterns	28
Synchronous	Yes
Alternating	Yes

2 COLORS IN ONE!



8892102 - Amber/Clear Strobe
Full light alternates between the two colors

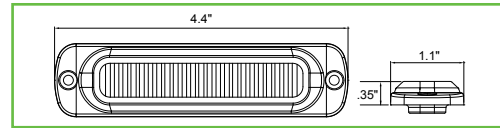
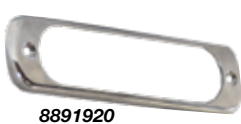

SAE J595 CLASS 1

SAE J595 Class 1

	Part No.	LED Color	Amp	Wt. (lbs.)
	8892102	6 Amber	1.0	0.15
		6 Clear		
	8892105	6 Blue	1.0	0.15
		6 Red		
	8892106	6 Amber	1.0	0.15
		6 Red		
	8892107	6 Clear	1.0	0.15
		6 Red		
	8892108	6 Amber	1.0	0.15
		6 Blue		
	8892109	6 Amber	1.0	0.15
		6 Green		

Strobes must be mounted in horizontal orientation to achieve Class 1 rating

Accessories

	Part No.	Description	Wt. (lbs.)
	8891920	Chrome Bezel for Thin Mount LED Lights	0.02
	8891925	Black, 90 Degree Mounting Bracket	0.06

THIN DUAL ROW 4.5" LED STROBE LIGHT



Number of LEDs	12
Housing	Aluminum
Number of Flash Patterns	25
Synchronous	Yes
Alternating	Yes



8892600



8892620

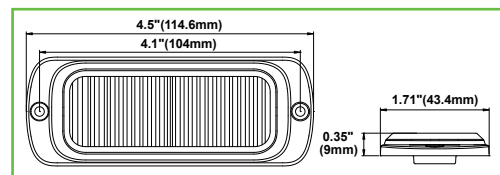

SAE J595 CLASS 1

SAE J595 Class 1

	Part No.	Color	Amp	Wt. (lbs.)
	8892600	Amber	0.78	0.21
	8892602	Amber/Clear	0.78	0.21

Accessories

	Part No.	Description	Wt. (lbs.)
	8892620	Chrome Bezel for Thin Mount LED Lights	0.02

Strobe Lights

2.5" LED STROBE LIGHT



Number of LEDs	3
Housing	Aluminum
Number of Flash Patterns	12
Synchronous	Yes
Alternating	Yes

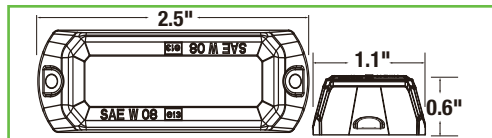

8891403



Included multi-mount



Part No.	Color	Amp	Wt. (lbs.)
8891403	Amber	0.22	0.33

3.5" LED STROBE LIGHT



Number of LEDs	3
Housing	Aluminum
Number of Flash Patterns	12
Synchronous	Yes
Alternating	Yes

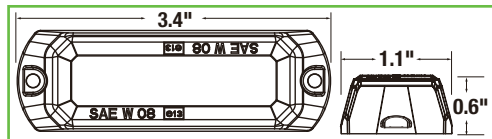

8891400



8891402



Part No.	Color	Amp	Wt. (lbs.)
8891400	Amber	0.22	0.17
8891401	Clear	0.22	0.17

Accessories

Part No.	Description	Wt. (lbs.)
8891402	Black, 90 Degree Mounting Bracket for 8891400 and 8891401	0.08



5" LED STROBE LIGHT



Number of LEDs	6
Housing	Aluminum
Number of Flash Patterns	19
Synchronous	Yes
Alternating	Yes



8891500



8891506

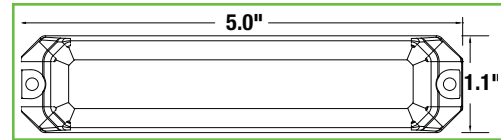

SAE J595 Class 1



Part No.	Color	Amp	Wt. (lbs.)
8891500	Amber	1.1	0.25
8891501	Clear	1.1	0.25

Part No.	Color	Amp	Wt. (lbs.)
8891502	Amber/Clear	1.1	0.25

Accessories

Part No.	Description	Wt. (lbs.)
8891506	Black, 90 Degree Mounting Bracket for 8891500 Series	0.16

DUAL ROW 5" LED STROBE LIGHT



Number of LEDs	12
Housing	Aluminum
Number of Flash Patterns	25
Synchronous	Yes
Alternating	Yes



8891700



8891711



8891706

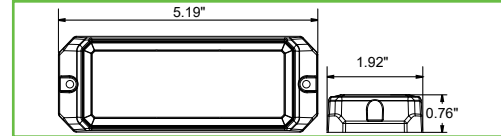

SAE J595 Class 1



Part No.	Color	Amp	Wt. (lbs.)
8891700	Amber	2.2	0.42
8891701	Clear	2.2	0.42

Part No.	Color	Amp	Wt. (lbs.)
8891702	Amber/Clear	2.2	0.42

Part No.	Color	Amp	Wt. (lbs.)
8891709	Amber/Green	2.2	0.42

Part No.	Color	Amp	Wt. (lbs.)
8891710	Green	2.2	0.42

Accessories

Part No.	Description	Wt. (lbs.)
8891711	Recessed Mount, Black Grommet for 8891700 Series, fits in 6" Oval	0.12
8891706	Black, 90 Degree Mounting Bracket	0.70



StrobeConnect Supported



ProConnect Supported

Strobe Lights

NARROW PROFILE 5" LED STROBE LIGHT

5-YEAR W	Number of LEDs	3
12-24 VOLTS	Housing	Aluminum
IP X7	Number of Flash Patterns	12
CA 13	Synchronous	Yes
SAE J595 CLASS 1	Alternating	Yes

Mounts in the narrow spacing in a vehicle's front grill or between the rear bumper and tailgate of pickup trucks



8892700

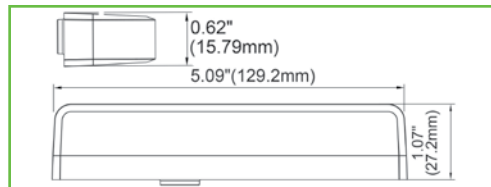

Part No.	Color	Amp	Wt. (lbs.)
8892700	Amber	0.74	0.29
8892701	Clear	0.74	0.29

Accessories

Part No.	Description	Wt. (lbs.)
8892825	Dash Bracket Housing	0.12

ULTRA BRIGHT NARROW PROFILE 5" LED STROBE LIGHT

5-YEAR W	Number of LEDs	6
12-24 VOLTS	Housing	Aluminum
IP X7	Number of Flash Patterns	23
CA 13	Synchronous	Yes
SAE J595 CLASS 1	Alternating	Yes

Mounts in the narrow spacing in a vehicle's front grill or between the rear bumper and tailgate of pickup trucks



8892800

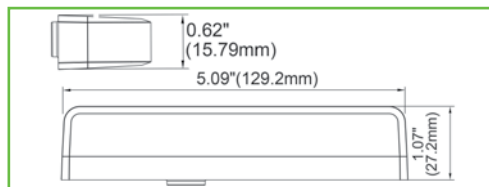

SAE J595 Class 1



Part No.	Color	Amp	Wt. (lbs.)
8892800	Amber	1.14	0.29
8892801	Clear	1.14	0.29

Part No.	Color	Amp	Wt. (lbs.)
8892802	Amber/Clear	1.14	0.29
8892810	Amber/Green	1.14	0.29

Accessories

Part No.	Description	Wt. (lbs.)
8892825	Dash Bracket Housing	0.12

NARROW PROFILE 3.5" LED STROBE LIGHT **NEW**

5-YEAR W	Number of LEDs	6
12-24 VOLTS	Housing	Aluminum
IP X8	Number of Flash Patterns	18 Single, 26 Dual
CA 13	Synchronous	Yes
SAE J595 CLASS 1	Alternating	Yes

Mounts in the narrow spacing in a vehicle's front grill or between the rear bumper and tailgate of pickup trucks



8892710

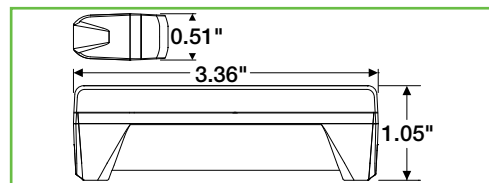

SAE J595 Class 1



Part No.	Color	Amp	Wt. (lbs.)
8892710	Amber	1.2	0.2
8892711	Clear	1.2	0.2

Part No.	Color	Amp	Wt. (lbs.)
8892712	Amber/Clear	1.2	0.2



POST MOUNTED 3" LED STROBE SAE J595 CLASS 1 LIGHT



Number of LEDs	4
Housing	Aluminum
Number of Flash Patterns	19
Synchronous	Yes
Alternating	Yes

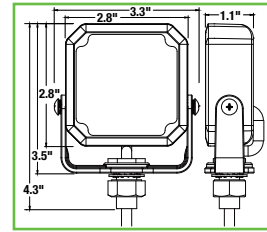

Part No.	Color	Amp	Wt. (lbs.)
 8891800	Amber	0.55	0.65

SURFACE/RECESS MOUNT LED STROBE LIGHT SERIES



Number of LEDs	3
Housing	Aluminum
Number of Flash Patterns	16
Synchronous	Yes
Alternating	Yes



8892400
Shown with included bezel



Shown without bezel
Ideal for tail lights





8892420



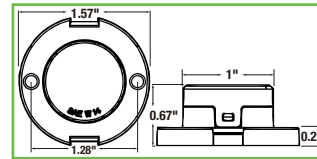

8892425



Part No.	Color	Amp	Lead	Wt. (lbs.)
 8892400	Amber	0.47	9.5"	0.10
 8892401	Clear	0.47	9.5"	0.10

1 lighthead per box, includes black bezel.

Accessories

Part No.	Description	Wt. (lbs.)
 8892420	Chrome Bezel	0.10
 8892425	Black Aluminum Mounting Bracket, 90 Degree	0.05

1.5" FLUSH/SURFACE MOUNT LED STROBE LIGHT SERIES



Number of LEDs	6
Housing	Aluminum
Mount	Flush or Surface
Number of Flash Patterns	17
Synchronous	Yes
Alternating	Yes





8892410

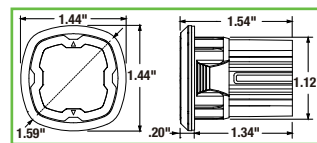

8892426



Part No.	Color	Amp	Lead	Wt. (lbs.)
 8892410	Amber	1.62	9.5"	0.14
 8892411	Clear	1.62	9.5"	0.14
 8892412	Amber /Clear	1.62	9.5"	0.14

1 lighthead per box.

Accessories

Part No.	Description	Wt. (lbs.)
 8892426	Mounting Bracket Pair	0.18

Hidden LED Strobe Lights

BOLT-ON HIDDEN LED STROBE KITS WITH IN-LINE FLASHERS

5-YEAR W	Number of LEDs	6
12 VOLTS	Housing	Aluminum
	Number of Flash Patterns	19
	Synchronous	Yes
	Alternating	Yes

Note: Up to six 8891215-8891327 can be combined for synchronized or alternating flash patterns

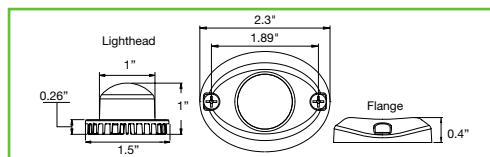

	Part No.	Color	Amp	Lead	Wt. (lbs.)
	8891215	Clear	1.3	15'	1.25
	8891225	Clear	1.3	25'	1.60
	8891216	Amber	1.3	15'	1.25
	8891226	Amber	1.3	25'	1.60
	8891227	Amber/Clear	1.3	25'	1.60

2 lightheads per box.

Accessories

	Part No.	Description	Wt. (lbs.)
	8891200	1 Pair, Chrome, Surface Mount Bezels for Bolt-On Hidden Strobes	0.04
	8891201	1 Pair, Black, Surface Mount Bezels for Bolt-On Hidden Strobes	0.04

PUSH-ON HIDDEN STROBE KIT WITH IN-LINE FLASHERS

5-YEAR W	Number of LEDs	6
12 VOLTS	Housing	Aluminum
	Number of Flash Patterns	19
	Synchronous	Yes
	Alternating	Yes

Note: Up to six 8891215-8891327 can be combined for synchronized or alternating flash patterns

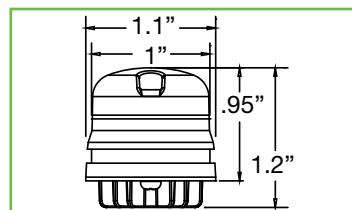

	Part No.	Color	Amp	Size	Wt. (lbs.)
	8891325	Amber	1.3	25'	1.60
	8891326	Clear	1.3	25'	1.60
	8891327	Amber/Clear	1.3	25'	1.60

2 lightheads per box.



LED Combination Stop/Turn/Tail/Backup Strobe Lights

4" ROUND LED MULTI-MOUNT STOP/TURN/TAIL/BACKUP/STROBE **NEW**



Number of LEDs	24
Size	4"
Housing	Plastic
Strobe	Amber/Clear
Number of Flash Patterns	57
Synchronous	Yes
Alternating	Yes

6 LED strobe can be: all amber, all clear, or half amber and half clear. Each color has 19 flash patterns.

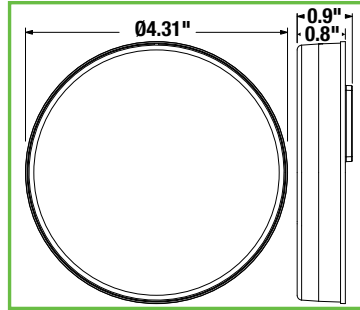

PL-3 Connection & Back Wiring



Part No.	LED Color	Amp	Wt. (lbs.)
5624424	12 Red	0.5	0.49
	6 Clear		
	6 Amber		

Includes Grommet and comes pre-wired

FMVSS108 Compliant including truck bodies over 80"

DOT SAE 23 S2T216R W-1

Available Q2 of 2024



Stop/Turn

Backup

Amber Strobe

6" OVAL LED MULTI-MOUNT STOP/TURN/TAIL/BACKUP/STROBE **NEW**



Number of LEDs	24
Size	6"
Housing	Plastic
Strobe	Amber/Clear
Number of Flash Patterns	57
Synchronous	Yes
Alternating	Yes

6 LED strobe can be: all amber, all clear, or half amber and half clear. Each color has 19 flash patterns.

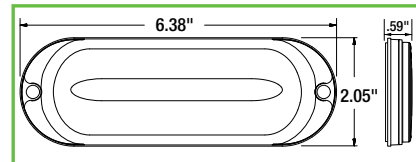

PL-3 Connection & Back Wiring



Part No.	LED Color	Amp	Wt. (lbs.)
5626424	12 Red	0.5	0.49
	6 Clear		
	6 Amber		

Includes Grommet and comes pre-wired

FMVSS108 Compliant including truck bodies over 80"

DOT SAE 23 S2T216R W-1

Available Q2 of 2024



Stop/Turn

Backup

Amber Strobe

LED Combination Stop/Turn/Tail/Backup Strobe Lights

4" ROUND LED MULTI-MOUNT STOP/TURN/TAIL/BACKUP/STROBE

5-YEAR
W
12-24
VOLTS
IP
69
CA
13
SAE J595
CLASS
1

Number of LEDs	32
Housing	Plastic
Connection	Blunt Cut
Number of Flash Patterns	19
Synchronous	Yes
Alternating	Yes

Grommet for recessed and chrome cover for surface mounting.

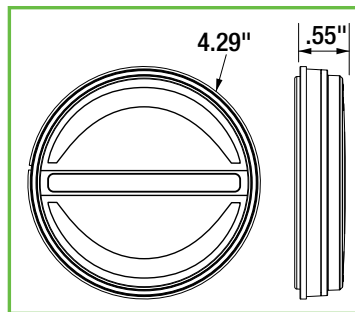

3 LIGHTS IN ONE!

Shown in Stop/Turn/Tail/Backup mode with grommet and in Strobe mode without grommet

Part No.	Color	Amp	Wt. (lbs.)
5624432	Red/Clear/Amber	1.3	0.50

6" OVAL LED MULTI-MOUNT STOP/TURN/TAIL/BACKUP/STROBE

5-YEAR
W
12-24
VOLTS
IP
69
CA
13
SAE J595
CLASS
1

Number of LEDs	32
Housing	Plastic
Connection	Blunt Cut
Number of Flash Patterns	19
Synchronous	Yes
Alternating	Yes

Grommet for recessed and chrome cover for surface mounting.

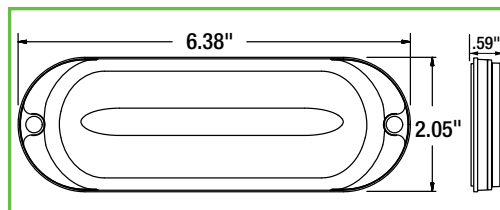

3 LIGHTS IN ONE!

Shown in Stop/Turn/Tail/Backup mode with grommet and in Strobe mode without grommet

Part No.	Color	Amp	Wt. (lbs.)
5626432	Red/Clear/Amber	1.3	0.60

6" OVAL LED MULTI-MOUNT MARKER/STROBE **NEW**

5-YEAR
W
12-24
VOLTS
IP
69K
CA
13
SAE J595
CLASS
1

Number of LEDs	20 Marker LEDs 6 Strobe LEDs
Housing	Plastic
Connection	Blunt Cut
Number of Flash Patterns	See Chart
Synchronous	Yes
Alternating	Yes

Grommet for recessed and chrome cover for surface mounting.

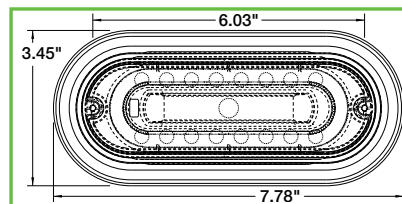

2 LIGHTS IN ONE!

Complements 5626432

SAE J595 Class 1 Lights

Part No.	Color	Flash	Amp	Wt. (lbs.)
5626026	Amber	19	0.8	0.44
5626226	Amber/Clear	12	0.8	0.44
5626926	Amber/Green	12	0.8	0.44



4" ROUND LED RECESSED STROBE LIGHT **NEW**







Number of LEDs	4
Housing	Plastic
Connection	Blunt Cut
Number of Flash Patterns	6
Synchronous	Yes
Alternating	Yes

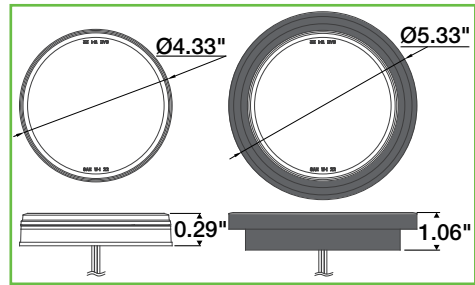

SL42AO



	Part No.	Color	Lens Color	Amp	Wt. (lbs.)
	 SL42AO	Amber	Amber	0.5	0.4
	 SL42CA	Amber	Clear	0.5	0.4

6" OVAL LED RECESSED STROBE LIGHT **NEW**



Number of LEDs	4
Housing	Plastic
Connection	Blunt Cut
Number of Flash Patterns	9
Synchronous	Yes
Alternating	Yes



SL62AO

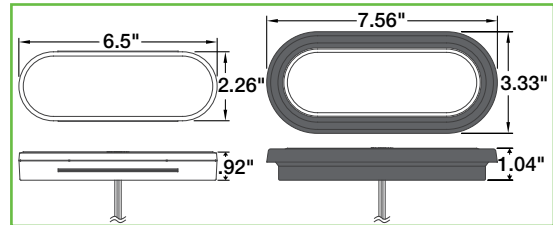

	Part No.	Color	Lens Color	Amp	Wt. (lbs.)
	 SL62AO	Amber	Amber	0.5	0.44
	 SL62CA	Amber	Clear	0.5	0.44
	 SL62CO	Clear	Clear	0.5	0.44
	 SL62AC	Amber/Clear	Clear	0.5	0.44
	 SL62AB	Amber/Blue	Clear	0.5	0.44
	 SL62CB	Blue	Clear	0.5	0.44
	 SL62AG	Amber/Green	Clear	0.5	0.44
	 SL62GO	Green	Clear	0.5	0.44



StrobeConnect Supported



ProConnect Supported

LED Recessed Strobes



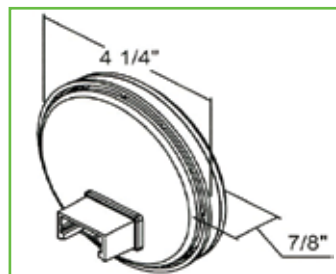

4" ROUND LED RECESSED STROBE LIGHT

**5-YEAR
W**
**12-24
VOLTS**
**IP
67**

Number of LEDs	24
Housing	Plastic
Number of Flash Patterns	See Chart
Synchronous	Yes
Alternating	Yes



SL40AR

	Part No.	Color	Flash	Amp	Wt. (lbs.)
	 SL40AR	Amber	Six Flash	0.50	0.40
	 SL41AR	Amber	Quad Flash	0.50	0.40



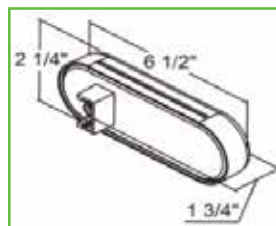

6" OVAL LED RECESSED STROBE LIGHT

**5-YEAR
W**
**12-24
VOLTS**
**IP
67**

Number of LEDs	24
Housing	Plastic
Number of Flash Patterns	6
Synchronous	Yes
Alternating	Yes



SL65AO

	Part No.	Color	Amp	Wt. (lbs.)
	 SL65AO	Amber	0.50	0.70
	 SL65CO	Clear	0.50	0.70

6" QUAD FLASH OVAL RECESSED STROBE LIGHT SERIES **NEW**





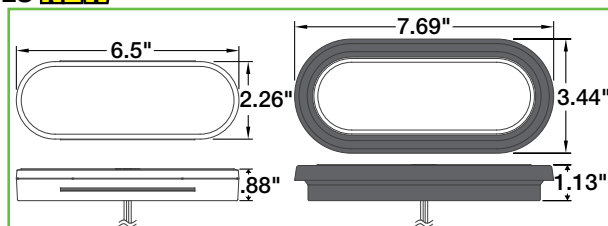

**5-YEAR
W**
**12
VOLTS**
**IP
67**
SAE J999
CLASS
1

Number of LEDs	24
Housing	Plastic
Connection	Blunt Cut
Number of Flash Patterns	19
Synchronous	Yes
Alternating	Yes

Includes grommet for recessed and base for surface mounting



SL70AO

	Part No.	Color	Lens Color	Amp	Wt. (lbs.)
	 SL70AO	Amber	Clear	0.25	0.50
	 SL70AC	Amber/ Clear	Clear	0.25	0.50
	 SL70AG	Amber/ Green	Clear	0.25	0.50

Available Q2 of 2024



4" LED STROBE LIGHT

5-YEAR
W
12-24
VOLTS
IP
67

Number of LEDs	3
Housing	Plastic
Number of Flash Patterns	19
Synchronous	Yes
Alternating	Yes



8891900



8891135

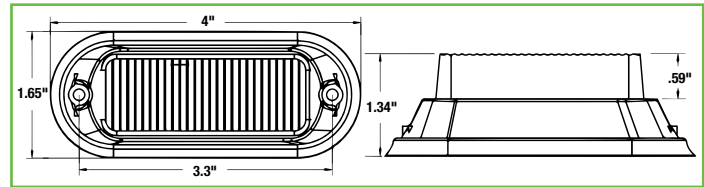

SAE J595 Class 1 Lights

SAE J595
CLASS
1

Part No.	Color	Amp	Wt. (lbs.)
8891120	Amber	0.3	0.20

Accessories

Part No.	Description	Wt. (lbs.)
8891135	Mounting Bracket for 8891120/8891121, Black	0.08

5" LED MINI STROBE LIGHT SERIES

5-YEAR
W
12-24
VOLTS
IP
67

Number of LEDs	4
Housing	Plastic
Number of Flash Patterns	19
Synchronous	Yes
Alternating	Yes



8891130



8891135

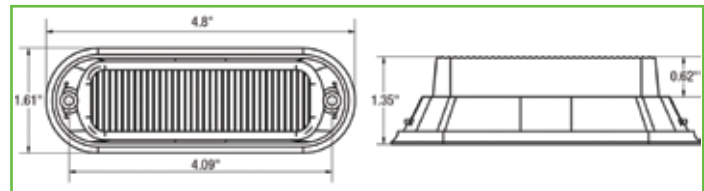

SAE J595 Class 1 Lights

SAE J595
CLASS
1

Part No.	Color	Amp	Wt. (lbs.)
8891130	Amber	0.4	0.24
8891131	Clear	0.4	0.24

Part No.	Color	Amp	Wt. (lbs.)
8891132	Amber/Clear	0.4	0.24

Accessories

Part No.	Description	Wt. (lbs.)
8891135	Black, 90 Degree Mounting Bracket for 8891130 Series	0.08

Strobe Lights

DUAL ROW 5.5" LED STROBE LIGHT

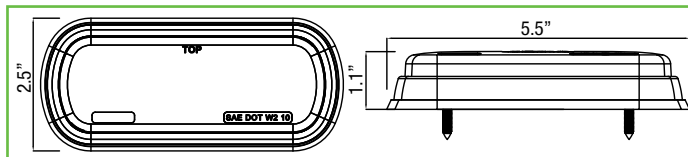

5-YEAR
W
12-24
VOLTS
IP
67

Number of LEDs	12
Housing	Plastic
Number of Flash Patterns	12
Synchronous	Yes
Alternating	Yes



8891600



	Part No.	Color	Amp	Wt. (lbs.)
	8891600	Amber	1.0	0.42
	8891602	Amber/Clear	1.0	0.42

5" RAISED LED STROBE LIGHT

5-YEAR
W
12-24
VOLTS
IP
67

Number of LEDs	4
Housing	Aluminum
Number of Flash Patterns	See Chart
Synchronous	Yes
Alternating	Yes

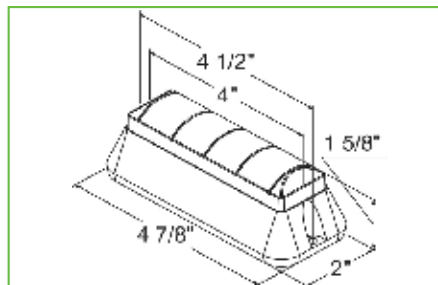



8891104



SAE J595 Class 2 Lights with 1 Flash Pattern

SAE J595
CLASS 2



	Part No.	Color	Flash	Amp	Wt. (lbs.)
	8891004**	Amber	1	0.54	0.60
	8891006**	Clear	1	0.54	0.60

**Does not feature alternating and synchronous functions

SAE J595 Class 2 Lights with 19 Flash Patterns

SAE J595
CLASS 2

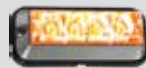

	Part No.	Color	Flash	Amp	Wt. (lbs.)
	8891104	Amber	19	0.54	0.60
	8891105	Amber/Clear	19	0.54	0.60



POST MOUNTED 4.5" LED STROBE LIGHT

5-YEAR
W
12-24
VOLTS
IP
67

Number of LEDs	6
Housing	Aluminum
Number of Flash Patterns	1
Synchronous	Yes
Alternating	Yes

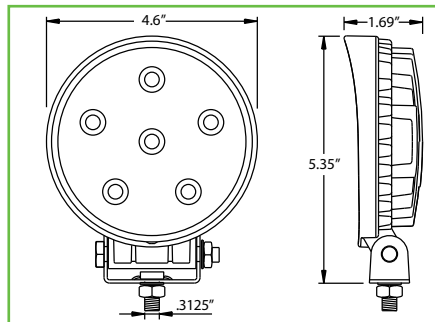

Part No.	Color	Amp	Wt. (lbs.)
 8891015	Amber	1.5	1.20

BLUE LED PEDESTRIAN WARNING LIGHT FOR FORKLIFTS

5-YEAR
W
12-24
VOLTS
IP
69K

Number of LEDs	9
Lumens	400
Lead Length	16"
Mount / Base	10mm Stud SST

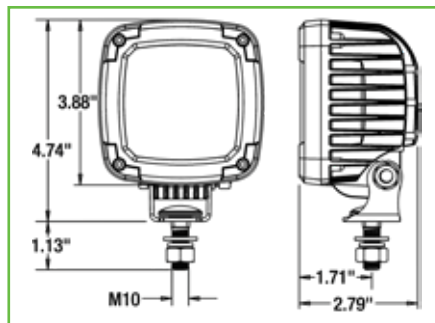

Part No.	Type	Color	Amp	Connection	Wt. (lbs.)
1492133	Spot	Clear	0.75	Blunt Cut	1.65

Beacon Lights

LOW PROFILE CLASS 1 6" LED BEACON

5-YEAR
W
12-24
VOLTS
SAE J845
CLASS
1

Number of LEDs	12
Number of Flash Patterns	3

See pg. 212 & 213 for Mount Options

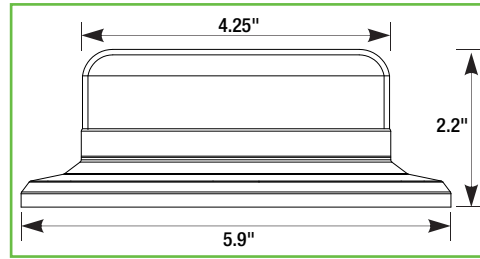

SAE J845 Class 1 Beacon, Auxiliary Power Plug

Part No.	Color	Lead	Mounting	Amp	Wt. (lbs.)
SL550ALP	Amber	15' ON/OFF Switch	Permanent and Magnetic	1.0	1.46

SAE J845 Class 1 Beacon, Hard-wired

Part No.	Color	Lead	Mounting	Amp	Wt. (lbs.)
SL551ALP	Amber	13" Blunt Cut	Permanent	1.0	1.08

CLASS 2 LED MICRO BEACON

5-YEAR
W
12-24
VOLTS
IP
67
SAE J845
CLASS
2

Number of LEDs	18
Flash	132 Flasher per Minute

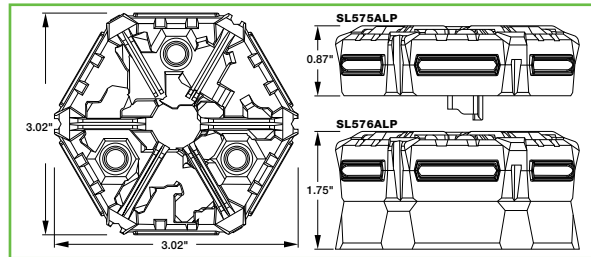

SAE J845 Class 2 Beacon, Permanent Mount, Hard-wired

Part No.	Connection	Mounting	Amp	Wt. (lbs.)
SL575ALP	7" Blunt Cut	Permanent 5 mm Stud	1.3	0.19

Accessories

Part No.	Description	Wt. (lbs.)
3048064	1.6" Riser Mount for SL575ALP	0.2

SAE J845 Class 2 Beacon, Magnetic Mount, Auxiliary Power Plug

Part No.	Wiring	Mounting	Amp	Wt. (lbs.)
SL576ALP	12.5' Auxiliary Plug	Magnetic	1.3	0.6



SL575ALP shown mounted on a stainless steel spreader



CLASS 1 6.5" X 5" LED BEACON

5-YEAR W 12-24 VOLTS IP 65 <small>SAE J848</small> CLASS 1	Number of LEDs	6
	Number of Flash Patterns	12, (including Steady-On)

See pg. 212 & 213 for Mount Options

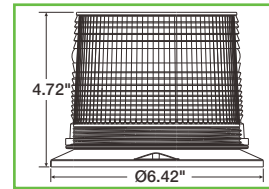

SL645ALP
14' ON/OFF switch



SL647ALP
Blunt cut ends

SAE J845 Class 1 Beacon, Auxiliary Power Plug

Part No.	Color	Lead	Mounting	Amp	Wt. (lbs.)
SL645ALP	Amber	14' ON/OFF Switch	Permanent, Pipe, and Magnetic	1.0	2.4

SAE J845 Class 1 Beacon, Hard-wired

Part No.	Color	Lead	Mounting	Amp	Wt. (lbs.)
SL647ALP	Amber	9" Blunt Cut	Permanent, 3-Bolt or 1" NPT	1.5	1.2

CLASS 1 6.5" X 6.5" LED BEACON

5-YEAR W 12-24 VOLTS IP 65 <small>SAE J848</small> CLASS 1	Number of LEDs	6
	Number of Flash Patterns	12, (including Steady-On)

See pg. 212 & 213 for Mount Options

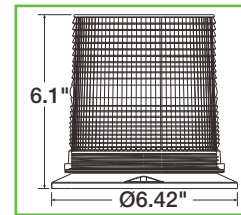

SL665A
14' ON/OFF switch



SL667A
Blunt cut ends

SAE J845 Class 1 Beacon, Auxiliary Power Plug

Part No.	Color	Lead	Mounting	Amp	Wt. (lbs.)
SL665A	Amber	14' ON/OFF Switch	Permanent, Pipe, and Magnetic	0.6	2.7

SAE J845 Class 1 Beacon, Hard-wired

Part No.	Color	Lead	Mounting	Amp	Wt. (lbs.)
SL667A	Amber	9" Blunt Cut	Permanent, 3-Bolt or 1" NPT	1.5	1.5

CLASS 1 6.5" X 5" LED BEACON

5-YEAR W 12-24 VOLTS IP 65 <small>SAE J848</small> CLASS 1	Number of LEDs	8
	Number of Flash Patterns	15

See pg. 212 & 213 for Mount Options

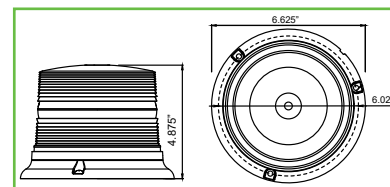

SL675ALP
15' ON/OFF switch



SL685ALP
Blunt cut ends

SAE J845 Class 1 Beacon, Auxiliary Power Plug

Part No.	Color	Lead	Mounting	Amp	Wt. (lbs.)
SL675ALP	Amber	10' ON/OFF Switch	Permanent and Magnetic	1.5	2.35

SAE J845 Class 1 Beacon, Hard-wired

Part No.	Color	Lead	Mounting	Amp	Wt. (lbs.)
SL685ALP	Amber	9" Blunt Cut	Permanent and Pipe	1.5	1.63

Beacon Lights

CLASS 1 6.5" X 6.5" LED BEACON

5-YEAR WARRANTY 12-24 VOLTS	Number of LEDs	12
	Number of Flash Patterns	12

See pg. 212 & 213 for Mount Options

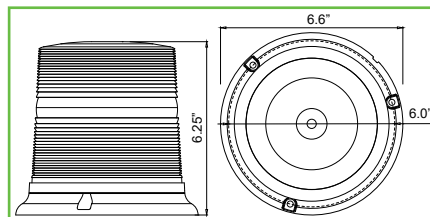

SL695A
10' ON/OFF switch



SL696A
Blunt cut ends

SAE J845 Class 1 Beacon, Auxiliary Power Plug

Part No.	Color	Lead	Mounting	Amp	Wt. (lbs.)
SL695A	Amber	10' ON/OFF Switch	Permanent and Magnetic	2.7	2.67

SAE J845 Class 1 Beacon, Hard-wired

Part No.	Color	Lead	Mounting	Amp	Wt. (lbs.)
SL696A	Amber	12" Blunt Cut	Permanent	2.7	2.67

CLASS 1 5" X 4" LED BEACON

5-YEAR WARRANTY 12-24 VOLTS	Number of LEDs	32
	Number of Flash Patterns	8

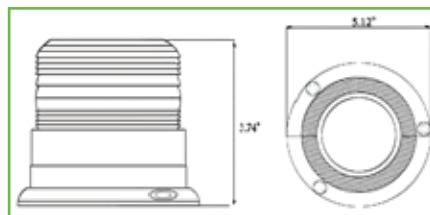

Part No.	Color	Lead	Mounting	Amp	Wt. (lbs.)
SL502A	Amber	10' ON/OFF Switch	Permanent and Magnetic	1.4	1.16

5" X 4" LED BEACON

5-YEAR WARRANTY 12-24 VOLTS	Number of LEDs	40
	Number of Flash Patterns	2

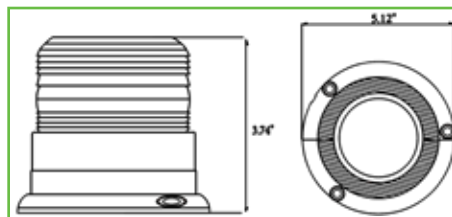

Part No.	Color	Lead	Mounting	Amp	Wt. (lbs.)
SL501A	Amber	10' Auxiliary Cable	Magnetic and Permanent	0.6	1.28

PORTABLE 5" X 4" LED BEACON

5-YEAR WARRANTY	Number of LEDs	24
	Flash	1

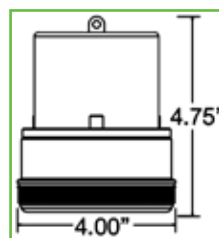

Part No.	Color	Power	Mounting	Wt. (lbs.)
SL475A	Amber	(2) D Batteries	Magnetic	1.75

Automatic On/Off operation with light sensor or manual operation via selector switch.



6.5" INCANDESCENT BEACON STROBE



Joules	8
Mounting	Permanent and Pipe

See pg. 212 & 213 for Mount Options



SL640ALP
4.75" tall x 6.31" wide



SL660A
6.31" tall x 6.31" wide



3016342

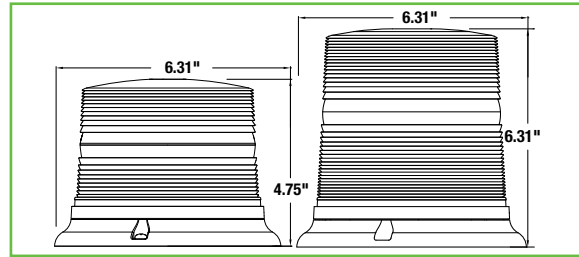

Part No.	Color	Lead	Flash	Amp	Wt. (lbs.)
SL640ALP	Amber	10" Blunt Cut	1	1.5	1.75

Part No.	Color	Lead	Flash	Amp	Wt. (lbs.)
SL660A	Amber	10" Blunt Cut	Dual Flash 80 FPM	1.5	2.0

Accessories

Part No.	Description	Wt. (lbs.)
3016342	Replacement Bulb for SL640ALP & SL660A	0.02

5" X 4" INCANDESCENT BEACON STROBE



Joules	1.7
Flash	2

See pg. 212 & 213 for Mount Options

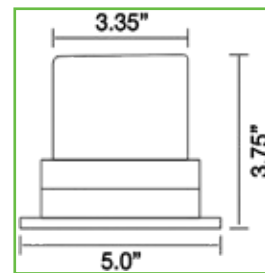

Part No.	Color	Lead	Mounting	Amp	Wt. (lbs.)
SL500A	Amber	10' Auxiliary Cable	Magnetic and Permanent	0.6	1.13

Beacon Lights

6" X 5" INCANDESCENT BEACON STROBE

1-YEAR
W
12-110
VOLTS

Joules	1.7
Flash	1

See pg. 212 & 213 for Mount Options

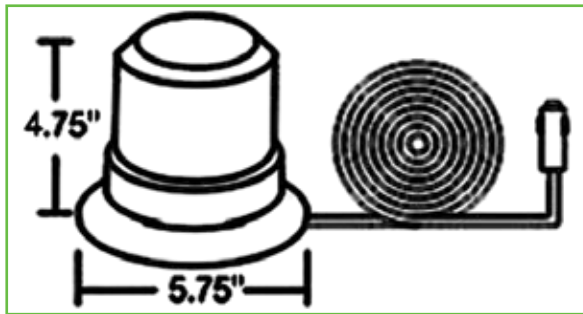

Part No.	Color	Lead	Mounting	Amp	Wt. (lbs.)
 SL650A	Amber	10' Auxiliary Cable	Magnetic and Permanent	0.3	1.5

5.5" HALOGEN REVOLVING LIGHT

1-YEAR
W
12-24
VOLTS

Flash	90 FPM
-------	--------

See pg. 212 & 213 for Mount Options

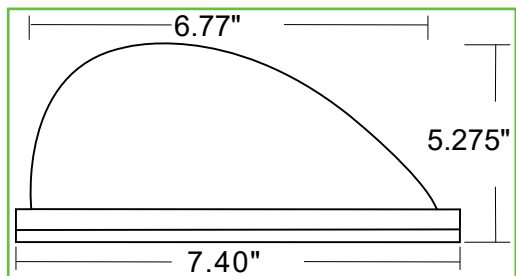

Part No.	Color	Lead	Mounting	Amp	Wt. (lbs.)
 RL650A	Amber	10' Auxiliary Cable	Magnetic	1.5	1.5

SELF-ADHESIVE MAGNETIC MOUNT PAD FOR ALUMINUM CABS

Construction	Carbon Steel
Finish	Black Powder-Coated
Size	3.5" L x 3.5" W
Mount	3M® Tape

Allows use of magnetic light mounts even on aluminum truck cabs

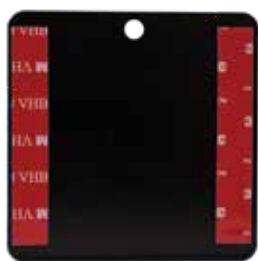

8895400



8895400 shown with SL695A beacon



8895400 shown with 8891031 mini light bar

Note: Allows use of magnetic light mounts even on aluminum truck cabs

Part No.	Description	Wt. (lbs.)
8895400	Self-Adhesive Magnetic Mount Pad for Aluminum Cabs, Single	0.27
8895404	Self-Adhesive Magnetic Mount Pad for Aluminum Cabs, 4 pack	1.02

SELF-LEVELING BEACON MOUNT



Part No.	Description	Wt. (lbs.)
B210880	Self-Leveling Mounting Bracket, 3/16" Steel Plate with Black Powder Coating, 9"W (ID) x 7.625T (OD)	6.7

STAINLESS STEEL MIRROR-MOUNTED BEACON BRACKET



Part No.	Description	Wt. (lbs.)
8891001	Beacon Mirror Mounting Bracket, Stainless Steel, 6.625" Diam x 4.875" T	1.4

Includes U-Bolts.
Bolt pattern fits most beacons up to 6.625" diameter.

BEACON BRUSH GUARD



Part No.	Description	Wt. (lbs.)
8891002	Black Beacon Brush Guard 6.5" Diam x 6.5" T (See fit guide online at buyersproducts.com)	1.0

This guard will NOT work with the following beacon strobes: RL650A, SL475A, SL500A, SL501A, SL650A, SL660A, SL665A.

STAINLESS STEEL BEACON MOUNT BRACKET



Part No.	Description	Wt. (lbs.)
8891003	Stainless Steel Beacon Mount Bracket 10.5"H x 6.88"L x 6.63"W	1.94

3/4" Round Marker/Clearance Lights

3/4" ROUND MARKER CLEARANCE LIGHTS WITH 1 LED



Number of LEDs	1
Size	3/4"
Connection	Hard Wired

Kit includes light and grommet

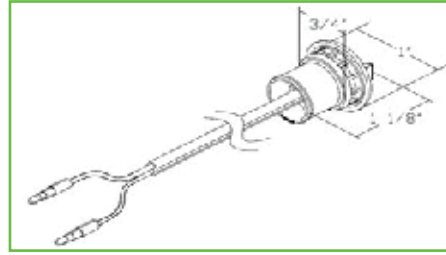

5623413 / 5623423 / 5623433 / 5623443
(sold in qty of 10)



5627511 / 5627521
(sold in qty of 10)



5623414 / 5623424 / 5623434 / 5623444
(sold in qty of 10)



5627512 / 5627522 / 5627532
(sold in qty of 10)



5627501
(sold in qty of 25)

Part No.	Diode Color	Lens Color	Lens Style	Lead	Amp	Std. Qty	Wt. (lbs.)
5623413	Red	Red	Dome	.180 Male Bullets	.021	10	0.03
5623423	Amber	Amber	Dome	.180 Male Bullets	.021	10	0.03
5627511	Red	Red	Bird Beak	.180 Male Bullets	.021	10	0.05
5627521	Amber	Amber	Bird Beak	.180 Male Bullets	.021	10	0.05
5623433	Red	Clear	Dome	.180 Male Bullets	.021	10	0.03
5623443	Amber	Clear	Dome	.180 Male Bullets	.021	10	0.03
5623414	Red	Red	Dome	Stripped Leads	.021	10	0.02
5623424	Amber	Amber	Dome	Stripped Leads	.021	10	0.02
5627512	Red	Red	Bird Beak	Stripped Leads	.021	10	0.02
5627522	Amber	Amber	Bird Beak	Stripped Leads	.021	10	0.02
5627532	Clear	Clear	Bird Beak	Stripped Leads	.021	10	0.02
5623434	Red	Clear	Dome	Stripped Leads	.021	10	0.03
5623444	Amber	Clear	Dome	Stripped Leads	.021	10	0.03

Bulk. Part number indicates single light only. Must order in multiples of 10.

Accessories

Part No.	Description	Std. Qty	Wt. (lbs.)
5627501	Black Grommet for 3/4" Round Marker Lights, for 1-LED Marker/Clearance Lights	25	0.05

Bulk. Part number indicates single item only. Must order in multiples of 25.

3/4" ROUND MARKER CLEARANCE LIGHTS WITH 3 LEDs



Number of LEDs	3
Size	3/4"
Connection	Hard Wired

Kit includes light and grommet

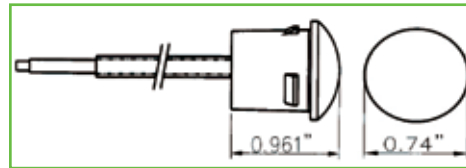

5627513 / 5627523
(sold in qty of 10)



5627514 / 5627524
(sold in qty of 10)



5627503
(sold in qty of 25)

Part No.	Color	Lead	Amp	Std. Qty	Wt. (lbs.)
5627513	Red	.180 Male Bullets	.038	10	0.05
5627514	Red	Stripped Leads	.038	10	0.05
5627517	Red	Stripped Leads	.038	1	0.05
5627523	Amber	.180 Male Bullets	.038	10	0.05
5627524	Amber	Stripped Leads	.038	10	0.05
5627527	Amber	Stripped Leads	.038	1	0.05

Bulk. Part number indicates single light only. 5627513, 5627514, 5627523, and 5627524 must be ordered in multiples of 10.

Accessories

Part No.	Description	Std. Qty	Wt. (lbs.)
5627503	Black Grommet for 3/4" Round Marker Lights, for 3-LED Marker/Clearance Lights	25	0.05

Bulk. Part number indicates single item only. Must order in multiples of 25.



2" ROUND MARKER/CLEARANCE LIGHT WITH 1 LED



Number of LEDs	1
Size	2"
Connection	PL-10

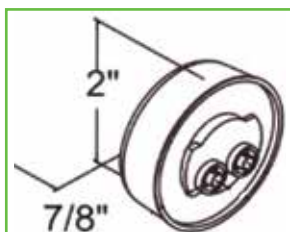

5622101 / 5622201
Plug and grommet included

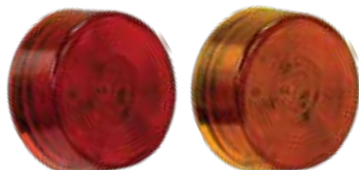

5622150 / 5622250
Light only (sold in qty of 10)



5622050
(sold in qty of 10)



5620250
(sold in qty of 10)

Part No.	Color	Mounting	Amp	Std. Qty	Wt. (lbs.)
5622101	Red	Grommet (Included)	.050	1	0.18
5622201	Amber	Grommet (Included)	.050	1	0.18
5622150	Red	Grommet (sold separately)	.050	10	0.07
5622250	Amber	Grommet (sold separately)	.050	10	0.07

Bulk. Part number indicates single light only. 5622150 and 5622250 must be ordered in multiples of 10.

Accessories

Part No.	Description	Std. Qty	Wt. (lbs.)
5622050	Black Grommet For 2" Marker Lights, Open Back	10	0.07
5620250	2-Pin In-Line Male PL-10 Plug with Stripped Power Wire and #10 Ring on Ground	25	0.03

Bulk. Part number indicates single item only. 5622050 must be ordered in multiples of 10 and 5620250 must be ordered in multiples of 25.

2" ROUND MARKER/CLEARANCE LIGHT WITH 4 LEDs



Number of LEDs	4
Size	2"
Connection	PL-10

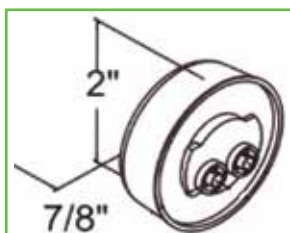

5622102 / 5622202
Plug and grommet included



5622154 / 5622254
Light only (sold in qty of 10)



5622050
(sold in qty of 10)



5620250
(sold in qty of 10)

Part No.	Color	Mounting	Amp	Std. Qty	Wt. (lbs.)
5622102	Red	Grommet (Included)	.039	1	0.18
5622202	Amber	Grommet (Included)	.039	1	0.18
5622154	Red	Grommet (sold separately)	.039	10	0.07
5622254	Amber	Grommet (sold separately)	.039	10	0.07

Bulk. Part number indicates single light only. 5622154 and 5622254 must be ordered in multiples of 10.

Accessories

Part No.	Description	Std. Qty	Wt. (lbs.)
5622050	Black Grommet For 2" Marker Lights, Open Back	10	0.07
5620250	2-Pin In-Line Male PL-10 Plug with Stripped Power Wire and #10 Ring on Ground	25	0.03

Bulk. Part number indicates single item only. 5622050 must be ordered in multiples of 10 and 5620250 must be ordered in multiples of 25.

2-1/2" Round Marker/Clearance Lights

2-1/2" ROUND MARKER/CLEARANCE LIGHT WITH 2 LEDs



Number of LEDs	2
Size	2-1/2"
Connection	PL-10

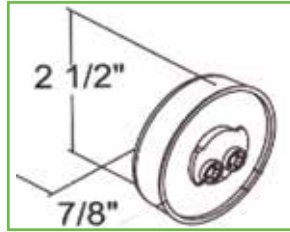

5622512 / 5622522
(sold in qty of 10)



5622505 / 5622506
(sold in qty of 10)

5620250
(sold in qty of 10)

Part No.	Color	Mounting	Amp	Std. Qty	Wt. (lbs.)
5622512	Red	Grommet (sold separately)	.044	10	0.11
5622522	Amber	Grommet (sold separately)	.044	10	0.11

Bulk. Part number indicates single light only. 5622512 and 5622522 must be ordered in multiples of 10.

Accessories

Part No.	Description	Std. Qty	Wt. (lbs.)
5622505	Black Grommet For 2-1/2" Marker Lights, Semi-Open Back	10	0.11
5622506	Black Grommet For 2-1/2" Marker Lights, Open Back	10	0.11
5620250	2-Pin In-Line Male PL-10 Plug with Stripped Power Wire and #10 Ring on Ground	25	0.03

Bulk. Part number indicates single item only. 5622505 and 5622506 must be ordered in multiples of 10. 5620250 must be ordered in multiples of 25.

2-1/2" ROUND MARKER/CLEARANCE LIGHT WITH 4 LEDs



Number of LEDs	4
Size	2-1/2"
Connection	PL-10

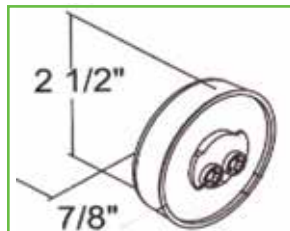

5622514 / 5622524
Plug and grommet included



5622550 / 5622525
(sold in qty of 10)



5622505 / 5622506
(sold in qty of 10)

5620250
(sold in qty of 10)

Part No.	Color	Mounting	Amp	Std. Qty	Wt. (lbs.)
5622514	Red	Grommet (Included)	.032	1	0.11
5622524	Amber	Grommet (Included)	.032	1	0.11
5622550	Red	Grommet (sold separately)	.032	10	0.11
5622525	Amber	Grommet (sold separately)	.032	10	0.11

Bulk. Part number indicates single light only. 5622550 and 5622525 must be ordered in multiples of 10.

Accessories

Part No.	Description	Std. Qty	Wt. (lbs.)
5622505	Black Grommet For 2-1/2" Marker Lights, Semi-Open Back	10	0.11
5622506	Black Grommet For 2-1/2" Marker Lights, Open Back	10	0.11
5620250	2-Pin In-Line Male PL-10 Plug with Stripped Power Wire and #10 Ring on Ground	25	0.03

Bulk. Part number indicates single item only. 5622505 and 5622506 must be ordered in multiples of 10. 5620250 must be ordered in multiples of 25.



2-1/2" Round Marker/Clearance Lights

2-1/2" ROUND MARKER/CLEARANCE LIGHT WITH 7 LEDs



Number of LEDs	7
Size	2-1/2"
Connection	PL-10

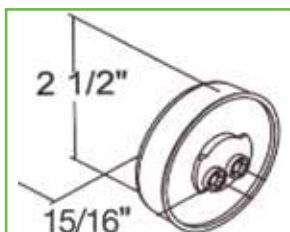

5622517 / 5622527
(sold in qty of 10)

Part No.	Color	Mounting	Amp	Std. Qty	Wt. (lbs.)
5622517	Red	Grommet (sold separately)	.19	10	0.11
5622527	Amber	Grommet (sold separately)	.19	10	0.11

Bulk. Part number indicates single light only. 5622517 and 5622527 must be ordered in multiples of 10.



5622505 / 5622506
(sold in qty of 10)

5620250
(sold in qty of 10)

Accessories

Part No.	Description	Std. Qty	Wt. (lbs.)
5622505	Black Grommet For 2-1/2" Marker Lights, Semi-Open Back	10	0.11
5622506	Black Grommet For 2-1/2" Marker Lights, Open Back	10	0.11
5620250	2-Pin In-Line Male PL-10 Plug with Stripped Power Wire and #10 Ring on Ground	25	0.03

Bulk. Part number indicates single item only. 5622505 and 5622506 must be ordered in multiples of 10. 5620250 must be ordered in multiples of 25.

2-1/2" ROUND MARKER/CLEARANCE LIGHT WITH REFLEX AND 4 LEDs



Number of LEDs	4
Size	2-1/2"
Connection	PL-10

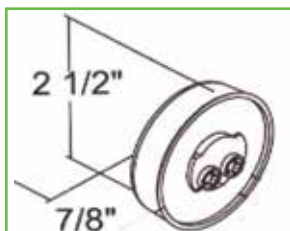

5622551 / 5622526
Plug and grommet included

Part No.	Color	Mounting	Amp	Std. Qty	Wt. (lbs.)
5622551	Red	Grommet (sold separately)	.030	10	0.11
5622526	Amber	Grommet (sold separately)	.033	10	0.11

Bulk. Part number indicates single light only. 5622551 and 5622526 must be ordered in multiples of 10.



5622505 / 5622506
(sold in qty of 10)

5620250
(sold in qty of 10)

Accessories

Part No.	Description	Std. Qty	Wt. (lbs.)
5622505	Black Grommet For 2-1/2" Marker Lights, Semi-Open Back	10	0.11
5622506	Black Grommet For 2-1/2" Marker Lights, Open Back	10	0.11
5620250	2-Pin In-Line Male PL-10 Plug with Stripped Power Wire and #10 Ring on Ground	25	0.03

Bulk. Part number indicates single item only. 5622505 and 5622506 must be ordered in multiples of 10. 5620250 must be ordered in multiples of 25.

2-1/2", 2-7/8", and 3-3/4" Rectangular Marker/Clearance Lights

2-1/2" SURFACE MOUNT MARKER LIGHT WITH 3 LEDs



Number of LEDs	3
Size	2-1/2"
Connection	PL-10
Mounting	Surface Mount

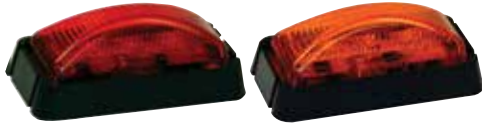

5622103 / 5622203
Plug and mounting bracket included



5622104 / 5622204 / 5622304
Light only (sold in qty of 10)



5622205 (sold in qty of 10) **5622206** (sold in qty of 10) **5620250** (sold in qty of 10)

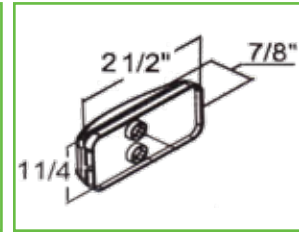
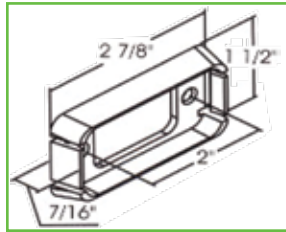

Part No.	Color	Amp	Std. Qty	Wt. (lbs.)
5622103	Red	.042	1	0.05
5622203	Amber	.042	1	0.05
5622104	Red	.042	10	0.05
5622204	Amber	.042	10	0.05
5622304	Clear	.042	10	0.05

Bulk. Part number indicates single light only. 5622104, 5622204 and 5622304 must be ordered in multiples of 10.

Accessories

Part No.	Description	Std. Qty	Wt. (lbs.)
5622205	2-1/2" Flush Mount, Open Back Grommet for use with 5622104, 5622204, 5622304	10	0.11
5622206	2-1/2" Surface Mount, Open Back Grommet	10	0.11
5620250	2-Pin In-Line Male PL-10 Plug with Stripped Power Wire and #10 Ring on Ground	25	0.03

Bulk. Part number indicates single item only. 5622205 and 5622206 must be ordered in multiples of 10 and 5620250 must be ordered in multiples of 25.

2-7/8" RECTANGULAR MARKER/CLEARANCE LIGHT WITH REFLEX AND 6 LEDs



Number of LEDs	6
Size	2-7/8"
Connection	Hard Wired with Stripped Lead and Ring Terminal
Mounting	Stud



5622716 / 5622726
Includes ground wire (sold in qty of 10)

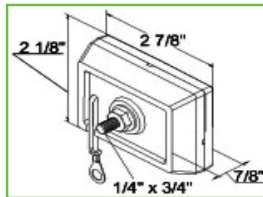

Part No.	Color	Amp	Std. Qty	Wt. (lbs.)
5622716	Red	.033	10	0.14
5622726	Amber	.033	10	0.14

Bulk. Part number indicates single light only. 5622716 and 5622726 must be ordered in multiples of 10.

3-3/4" RECTANGULAR MARKER/CLEARANCE LIGHT WITH 2 LEDs



Number of LEDs	2
Connection	Male Barrel Terminals
Mounting	Surface Mount



5623812 / 5623822
Light only (sold in qty of 10)



5623750
(sold in qty of 10)

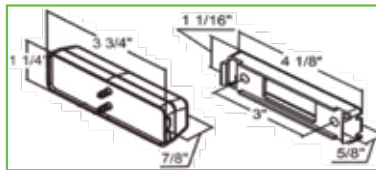

Part No.	Size	Color	Amp	Std. Qty	Wt. (lbs.)
5623812	3-3/4"	Red	.060	10	0.04
5623822	3-3/4"	Amber	.060	10	0.04

Bulk. Part number indicates single light only. 5623711, 5623712, 5623812 and 5623822 must be ordered in multiples of 10.

Accessories

Part No.	Description	Std. Qty	Wt. (lbs.)
5623750	4-1/8" Black Mounting Bracket Includes Stripped Lead for 5623712	1	0.05



3/4" ID LIGHT WITH 9 LEDs



Number of LEDs	9
Size	3/4"
Connection	Hard Wired with .180 Male Bullets
Mounting	Grommet

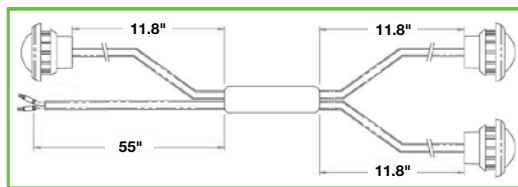

Part No.	Color	Amp	Std. Qty	Wt. (lbs.)
5627533	Red	.113	1	0.50
5627534	Amber	.113	1	0.50

14-1/4" STAINLESS STEEL ID BAR LIGHT WITH 9 LEDs

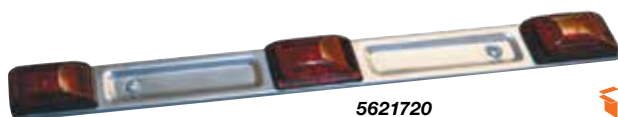
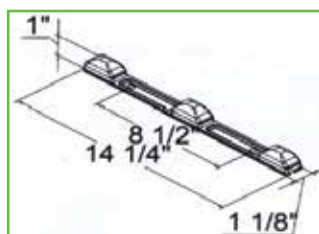

Part No.	Color	Amp	Std. Qty	Wt. (lbs.)
5621720	Red	.147	1	0.55

17" POLYCARBONATE ID BAR LIGHT WITH 9 LEDs

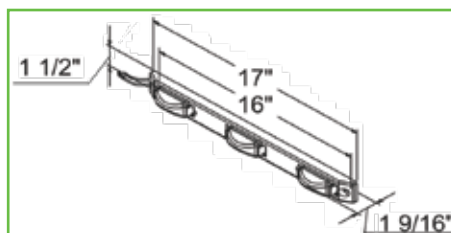

Part No.	Color	Amp	Std. Qty	Wt. (lbs.)
5621719	Red	.119	1	0.65

17" SLIMLINE STOP/TURN/TAIL LIGHT WITH 11 LEDs



Number of LEDs	11
Size	17"
Connection	Hard Wired with Stripped Lead and Ring Terminal
Mounting	Surface

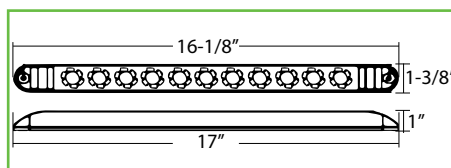

Part No.	Color	Amp	Std. Qty	Wt. (lbs.)
5621711	Red	.162	10	0.41

4" Round Stop/Turn/Tail Lights

4" ROUND STOP/TURN/TAI LIGHT WITH 7 LEDS



Number of LEDs	7
Size	4"
Connection	PL-3

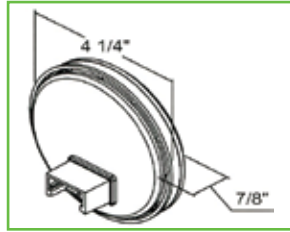

5624157
Plug and grommet included



5624156
(sold in qty of 10)



5624050
(sold in qty of 10)



5621004
(sold in qty of 10)



5620350
(sold in qty of 25)

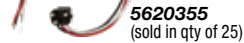

5620355
(sold in qty of 25)

Part No.	Color	Mounting	Amp	Std. Qty	Wt. (lbs.)
5624157	Red	Grommet (Included)	.150	1	0.23
5624156	Red	Grommet (sold separately)	.150	10	0.23

Bulk. Part number indicates single item only. Must order in multiples of 10.

Accessories

Part No.	Description	Std. Qty	Wt. (lbs.)
5624050	Replacement Black Grommet	10	0.15
5621004	Black Plastic Security Grommet	10	0.08
5620350	3-Pin Right Angle Male PL-3 Plug with Stripped Leads and #10 Ring on Ground	25	0.03
5620355	3-Wire, 3-Pin Straight Male PL-3 Plug with Stripped Leads and #10 Ring on Ground	25	0.05

Bulk. Part number indicates single item only. 5624050, 5621004 must be ordered in multiples of 10. 5620350 and 5620355 must be ordered in multiples of 25.

4" ROUND STOP/TURN/TAI LIGHT WITH 10 LEDS



Number of LEDs	10
Size	4"

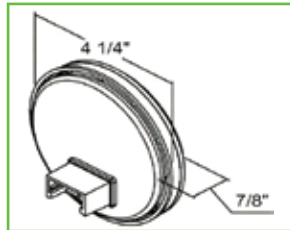

5624110
Plug and grommet included



5624150
Light only (sold in qty of 10)



5624151
Light only (sold in qty of 10)



5624050
(sold in qty of 10)



5621004
(sold in qty of 10)



5620350
(sold in qty of 25)



5620355
(sold in qty of 25)

5620352
(sold in qty of 25)

Part No.	Color	Mounting	Connection	Amp	Std. Qty	Wt. (lbs.)
5624110	Red	Grommet (Included)	PL-3	.113	1	0.70
5624150	Red	Grommet (sold separately)	PL-3	.113	10	0.36
5624151	Red	Grommet (sold separately)	AMP-Style	.105	10	0.34

Bulk. Part number indicates single light only. 5624150 and 5624151 must be ordered in multiples of 10.

Accessories

Part No.	Description	Std. Qty	Wt. (lbs.)
5624050	Replacement Black Grommet	10	0.15
5621004	Black Plastic Security Grommet	10	0.08
5620350	3-Pin Right Angle Male PL-3 Plug with Stripped Leads and #10 Ring on Ground	25	0.03
5620355	3-Wire, 3-Pin Straight Male PL-3 Plug with Stripped Leads and #10 Ring on Ground	25	0.05
5620352	3-Wire AMP-Style Plug, with Stripped Leads and #10 Ring on Ground	25	0.03

Bulk. Part number indicates single item only. 5624050, 5621004 must be ordered in multiples of 10. 5620350, 5620355 and 5620352 must be ordered in multiples of 25.



4" Round Stop/Turn/Tail/Backup/Strobe Lights

4" ROUND LED MULTI-MOUNT STOP/TURN/TAILO/BACKUP/STROBE **NEW**

5-YEAR
W
12-24
VOLTS
IP
69
CA
13
SAE J599
CLASS
1

Number of LEDs	24
Size	4"
Housing	Plastic
Strobe	Amber/Clear
Number of Flash Patterns	57
Synchronous	Yes
Alternating	Yes

6 LED strobe can be: all amber, all clear, or half amber and half clear. Each color has 19 flash patterns.

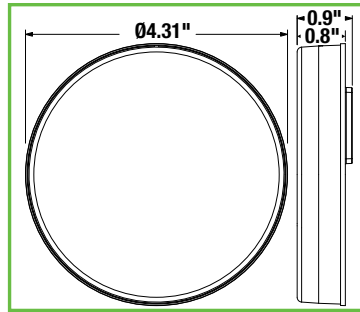

PL-3 Connection & Back Wiring

3 LIGHTS IN ONE!



Part No.	LED Color	Amp	Wt. (lbs.)
5624424	12 Red	0.5	0.49
	6 Clear		
	6 Amber		

Includes Grommet and comes pre-wired

FMVSS108 Compliant including truck bodies over 80"

DOT SAE 23 S2T216R W-1

Available Q2 of 2024



Stop/Turn

Backup

Amber Strobe

4" ROUND STOP/TURN/TAILO/BACKUP LIGHT WITH 12 LEDs

LIMITED
UPSIDE
W
12
VOLTS
IP
67

Number of LEDs	12
Size	4"
Connection	PL-3 and PL-2

2 LIGHTS IN ONE!

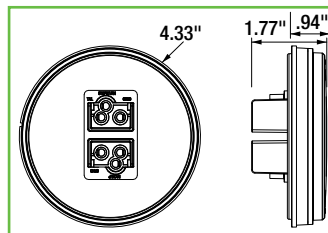

5624131
Plug and grommet included



5624130
Light only (sold in qty of 10)



5624050
(sold in qty of 10)



5621004
(sold in qty of 10)



5620251
(sold in qty of 25)

5620350
(sold in qty of 25)

Part No.	Color	Mounting	Amp	Std. Qty	Wt. (lbs.)
5624131	Red/Clear	Grommet (Included)	.80	1	0.23
5624130	Red/Clear	Grommet	.80	10	0.23

Bulk. Part number indicates single light only, 5624130 must be ordered in multiples of 10.

Accessories

Part No.	Description	Std. Qty	Wt. (lbs.)
5624050	Replacement Black Grommet	10	0.15
5621004	Black Plastic Security Grommet	10	0.08
5620251	2-Pin Right Angle Male Plug with Stripped Power Wire and #10 Ring on Ground	25	0.03
5620350	3-Pin Right Angle Male PL-3 Plug with Stripped Leads and #10 Ring on Ground	25	0.03

Bulk. Part number indicates single item only, 5624050, 5621004 must be ordered in multiples of 10. 5620251 and 5620350 must be ordered in multiples of 25.

4" Round & 6" Oval Stop/Turn/Tail Lights

4" ROUND STOP/TURN/TAIL LIGHT WITH 18 LEDs



Number of LEDs	18
Size	4"
Connection	PL-3

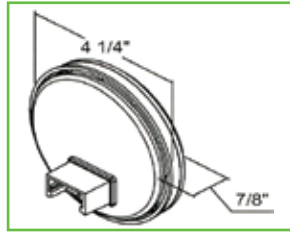

5624118
Plug and grommet included



5624119
Light only (sold in qty of 10)



5624050
(sold in qty of 10)



5621004
(sold in qty of 10)



5620350
(sold in qty of 25)

5620355
(sold in qty of 25)



Part No.	Color	Mounting	Amp	Std. Qty	Wt. (lbs.)
5624118	Red	Grommet (Included)	.208	1	0.80
5624119	Red	Grommet (sold separately)	.208	10	0.40

Bulk. Part number indicates single light only. **5624119** must be ordered in multiples of 10.

Accessories

Part No.	Description	Std. Qty	Wt. (lbs.)
5624050	Replacement Black Grommet	10	0.15
5621004	Black Plastic Security Grommet	10	0.08
5620350	3-Pin Right Angle Male PL-3 Plug with Stripped Leads and #10 Ring on Ground	25	0.03
5620355	3-Wire, 3-Pin Straight Male PL-3 Plug with Stripped Leads and #10 Ring on Ground	25	0.05

Bulk. Part number indicates single item only. **5624050, 5621004** must be ordered in multiples of 10. **5620350** and **5620355** must be ordered in multiples of 25.

6" OVAL STOP/TURN/TAIL LIGHT WITH 6 LEDs



Number of LEDs	6
Size	6"
Connection	PL-3

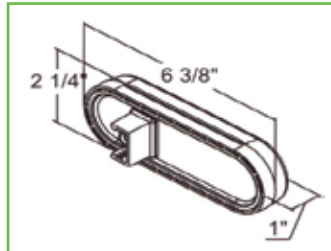

5626157
Plug and grommet included



5626156
Light only (sold in qty of 10)



5626050
(sold in qty of 10)



5620350
(sold in qty of 25)

5620355
(sold in qty of 25)



Part No.	Color	Mounting	Amp	Std. Qty	Wt. (lbs.)
5626157	Red	Grommet (Included)	.150	1	0.23
5626156	Red	Grommet (sold separately)	.150	10	0.23

Bulk. Part number indicates single light only. **5624130** must be ordered in multiples of 10.

Accessories

Part No.	Description	Std. Qty	Wt. (lbs.)
5626050	Replacement Black Grommet	10	0.18
5620350	3-Pin Right Angle Male PL-3 Plug with Stripped Leads and #10 Ring on Ground	25	0.03
5620355	3-Wire, 3-Pin Straight Male PL-3 Plug with Stripped Leads and #10 Ring on Ground	25	0.05

Bulk. Part number indicates single item only. **5626050** must be ordered in multiples of 10. **5620350** and **5620355** must be ordered in multiples of 25.



6" HARDWIRED SURFACE MOUNT OVAL STOP/TURN/TAIL LIGHT KIT WITH 10 LEDs



Number of LEDs	10
Size	6"
Connection	Hard Wired with Stripped Leads & Ring Terminal

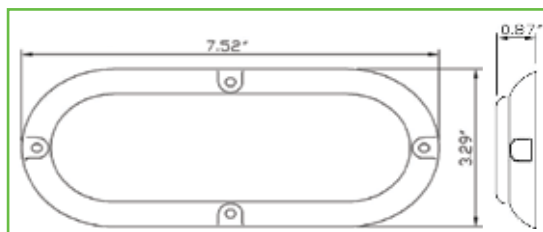

Part No.	Color	Mounting	Amp	Std. Qty	Wt. (lbs.)
5626552	Red	Surface	.106	1	0.34

6" OVAL STOP/TURN/TAIL LIGHT WITH 10 LEDs



Number of LEDs	10
Size	6"

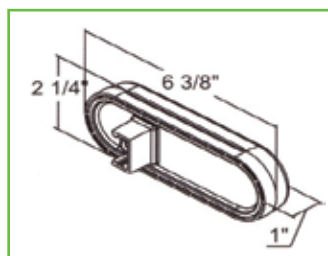

5626510
Plug and grommet included



5626550
Light only (sold in qty of 10)



5626551
Light only (sold in qty of 10)



5626553
Light only (sold in qty of 10)



5626050
(sold in qty of 10)



5620350
(sold in qty of 25)



5620355
(sold in qty of 25)



5620352
(sold in qty of 25)



Part No.	Color	Mounting	Connection	Amp	Std. Qty	Wt. (lbs.)
5626510	Red	Grommet (Included)	PL-3	.129	1	0.50
5626550	Red	Grommet (sold separately)	PL-3	.129	10	0.36
5626551	Red	Grommet (sold separately)	AMP-Style	.112	10	0.29
5626553	Clear Lens Red LEDs	Grommet (sold separately)	PL-3	.129	10	0.36

Bulk. Part number indicates single light only. 5626550, 5626551 and 5626553 must be ordered in multiples of 10.

Accessories

Part No.	Description	Std. Qty	Wt. (lbs.)
5626050	Replacement Black Grommet	10	0.18
5620350	3-Pin Right Angle Male PL-3 Plug with Stripped Leads and #10 Ring on Ground	25	0.03
5620355	3-Wire, 3-Pin Straight Male PL-3 Plug with Stripped Leads and #10 Ring on Ground	25	0.05
5620352	3-Wire AMP-Style Plug, with Stripped Leads and #10 Ring on Ground	25	0.03

Bulk. Part number indicates single item only. 5626050 must be ordered in multiples of 10. 5620350, 5620355 and 5620352 must be ordered in multiples of 25.

6" Oval Stop/Turn/Tail/Backup/Strobe Lights

6" OVAL LED MULTI-MOUNT STOP/TURN/TAILO/BACKUP/STROBE **NEW**

5-YEAR W	Number of LEDs	24
12-24 VOLTS	Size	6"
IP 69	Housing	Plastic
CA 13	Strobe	Amber/Clear
SAE J599 CLASS 1	Number of Flash Patterns	57
	Synchronous	Yes
	Alternating	Yes

6 LED strobe can be: all amber, all clear, or half amber and half clear. Each color has 19 flash patterns.

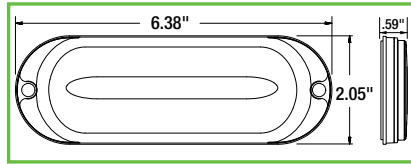

Part No.	LED Color	Amp	Wt. (lbs.)
5626424	12 Red	0.5	0.49
	6 Clear		
	6 Amber		

Includes Grommet and comes pre-wired
 FMVSS108 Compliant including truck bodies over 80"
 DOT SAE 23 S2T216R W-1
 Available Q2 of 2024

3 LIGHTS IN ONE!



6" OVAL STOP/TURN/TAILO/BACKUP LIGHT WITH 14 LEDs

LIMITED LIFETIME W	Number of LEDs	14
12 VOLTS	Size	6"
IP 67	Connection	PL-3 and PL-2

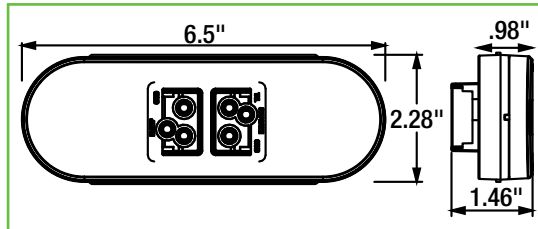

2 LIGHTS IN ONE!



Part No.	Color	Mounting	Amp	Std. Qty	Wt. (lbs.)
5626131	Red/Clear	Grommet (Included)	.80	1	0.3
5626130	Red/Clear	Grommet (sold separately)	.80	10	0.3

Bulk. Part number indicates single light only. 5626130 must be ordered in multiples of 10.

Accessories

Part No.	Description	Std. Qty	Wt. (lbs.)
5626050	Black Grommet for use with 5626132	10	0.18
5620251	2-Pin Right Angle Male Plug with Stripped Power Lead and #10 Ring on Ground	25	0.03
5620350	3-Pin Right Angle Male Plug with Stripped Power Leads and #10 Ring on Ground	25	0.05

Bulk. Part number indicates single item only. 5626050 must be ordered in multiples of 10. 5620251 and 5620350 must be ordered in multiples of 25.

6" OVAL STOP/TURN/TAIL/BACKUP LIGHT WITH 17 LEDs



Number of LEDs	17
Size	6"
Connection	PL-3 and PL-2
Compliance Family	FMVSS 108

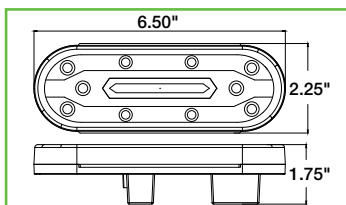

2 LIGHTS IN ONE!

5626132
Light only (sold in qty of 10)



5626050
(sold in qty of 10)

5620251
(sold in qty of 25)

5620350
(sold in qty of 25)

Part No.	Color	Mounting	Amp	Std. Qty	Wt. (lbs.)
5626132	Red/Clear	Grommet	.46	10	0.50

Featuring "Light Stripe" LED light tube technology.
Bulk. Part number indicates single light only. Must order in multiples of 10.

Accessories

Part No.	Description	Std. Qty	Wt. (lbs.)
5626050	Black Grommet for use with 5626132	10	0.18
5620251	2-Pin Right Angle Male Plug with Stripped Power Lead and #10 Ring on Ground	25	0.03
5620350	3-Pin Right Angle Male Plug with Stripped Power Leads and #10 Ring on Ground	25	0.05

Bulk. Part number indicates single item only. 5626050 must be ordered in multiples of 10. 5620251 and 5620350 must be ordered in multiples of 25.

6" OVAL STOP/TURN/TAIL LIGHT WITH 20 LEDs



Number of LEDs	20
Size	6"
Connection	PL-3

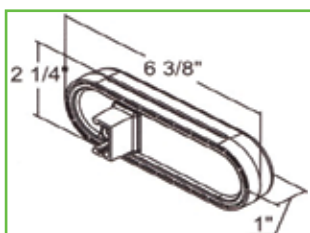

5626520
Plug and grommet included



5626521
Light only (sold in qty of 10)



5626050
(sold in qty of 10)

5620350
(sold in qty of 25)

5620355
(sold in qty of 25)

Part No.	Color	Mounting	Amp	Std. Qty	Wt. (lbs.)
5626520	Red	Grommet (Included)	.162	1	0.83
5626521	Red	Grommet (sold separately)	.162	10	0.31

Bulk. Part number indicates single light only. 5626130 must be ordered in multiples of 10.

Accessories

Part No.	Description	Std. Qty	Wt. (lbs.)
5626050	Replacement Black Grommet	10	0.18
5620350	3-Pin Right Angle Male PL-3 Plug with Stripped Leads and #10 Ring on Ground	25	0.03
5620355	3-Wire, 3-Pin Straight Male PL-3 Plug with Stripped Leads and #10 Ring on Ground	25	0.05

Bulk. Part number indicates single item only. 5626050 must be ordered in multiples of 10. 5620350 and 5620355 must be ordered in multiples of 25.

5-1/3" RECTANGULAR STOP/TURN/TAIL KIT WITH 15 LEDs



Number of LEDs	15
Size	5-1/3"
Connection	PL-3

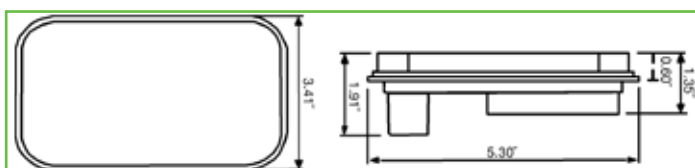

5625115
Plug and grommet included

Part No.	Color	Mounting	Amp	Std. Qty	Wt. (lbs.)
5625115	Red	Grommet (Included)	.188	1	0.65

Box-Style Stop, Turn, Tail Lights

5" BOX-STYLE LED STOP/TURN/TAIL LIGHT (FOR TRAILERS UNDER 80" WIDE)

LIMITED LIFETIME WARRANTY 12 VOLTS	Size	5"
	Connection	Hard Wired with Stripped Leads
	Mounting	Stud

Grounds through mounting stud.
Red polycarbonate colored lens and built-in reflector lens.

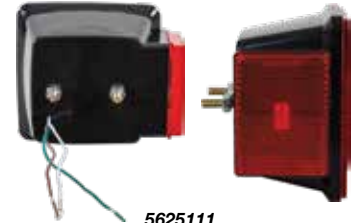
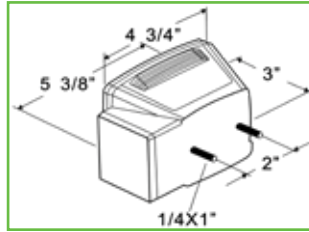

5625111
Back and side shown



5625111



5625117
Shown with built-in license plate light

Part No.	LEDs	Color	Style	Amp	Std. Qty	Wt. (lbs.)
5625111	11	Red	Passenger Side	.1	1	0.66
5625117	17	Red	Driver Side	.1	1	0.70

5-3/4" BOX STYLE STOP/TURN/TAIL AND BACK-UP WITH REFLEX

LIMITED LIFETIME WARRANTY 12 VOLTS	Size	5"
	Connection	Hard Wired with Stripped Leads
	Mounting	Stud

Includes ground wire.

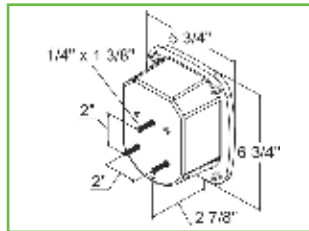

5626700



5626734



5626738
Shown with built-in license plate light

Part No.	LEDs	Color	Style	Amp	Std. Qty	Wt. (lbs.)
5626734	16 Red 14 Clear	Red Clear	Passenger Side	.091	1	1.24
5626738	16 Red 17 Clear	Red Clear	Driver Side	.091	1	1.24

5626738 includes license light.

Accessories

Part No.	Description	Std. Qty	Wt. (lbs.)
5626700	License Plate Bracket	1	0.12

5-3/4" LOW PROFILE COMBINATION REAR LIGHT STOP/TURN/TAIL/BACKUP **NEW**

LIMITED LIFETIME WARRANTY 12 VOLTS	Size	5-3/4"
	Connection	Hard Wired with Stripped Leads
	Mounting	Stud

Includes ground wire.

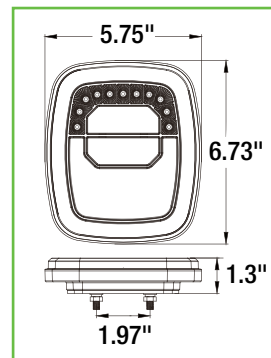

5626780



5626780 Side

Part No.	LEDs	Color	Style	Amp	Std. Qty	Wt. (lbs.)
5626780	80 Red 11 Clear	Red Clear	Drivers or Passenger Side	.082	1	1.0



4" Round and 6" Oval Turn Signal Lights

4" ROUND TURN SIGNAL LIGHT WITH 10 LEDs



Number of LEDs	10
Size	4"
Connection	PL-3

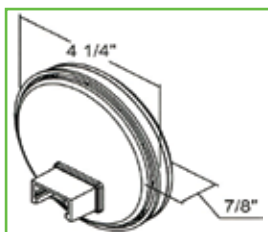

5624210
Plug and grommet included



5624211
(sold in qty of 10)



5624050
(sold in qty of 10)



5621004
(sold in qty of 10)



5620350
(sold in qty of 25)

5620352
(sold in qty of 10)



Part No.	Color	Mounting	Amp	Std. Qty	Wt. (lbs.)
5624210	Amber	Grommet (Included)	.221	1	0.70
5624211	Amber	Grommet (sold separately)	.221	10	0.36

Bulk. Part number indicates single light only. **5624211** and **5624251** must be ordered in multiples of 10.

Accessories

Part No.	Description	Std. Qty	Wt. (lbs.)
5624050	Replacement Black Grommet	10	0.15
5621004	Black Plastic Security Grommet	10	0.08
5620350	3-Pin Right Angle Male PL-3 Plug with Stripped Leads and #10 Ring on Ground for use with 5624211	25	0.03
5620352	3-Wire AMP-Style Plug, with Stripped Leads and #10 Ring on Ground for use with 5624251	10	0.03

Bulk. Part number indicates single item only. **5624050**, **5621004** and **5620352** must be ordered in multiples of 10. **5620350** must be ordered in multiples of 25.

6" OVAL TURN AND PARK SIGNAL LIGHT WITH 6 LEDs



Number of LEDs	6
Size	6"
Connection	PL-3

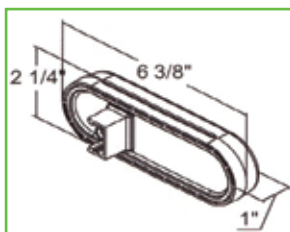

5626206
(sold in qty of 10)



5626050
(sold in qty of 10)



5620251
(sold in qty of 25)

Part No.	Color	Mounting	Amp	Std. Qty	Wt. (lbs.)
5626206	Amber	Grommet (sold separately)	.150	10	0.23

Bulk. Part number indicates single item only. Must order in multiples of 10.

Accessories

Part No.	Description	Std. Qty	Wt. (lbs.)
5626050	Replacement Black Grommet	10	0.18
5620251	2-Pin Right Angle Male Plug with Stripped Power Wire and #10 Ring on Ground	25	0.03

Bulk. Part number indicates single item only. **5626050** must be ordered in multiples of 10. **5620251** must be ordered in multiples of 25.

6" Oval Turn Signal Lights

6" OVAL TURN SIGNAL LIGHT WITH 10 LEDS



Number of LEDs	10
Size	6"
Connection	PL-3

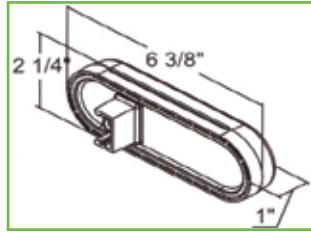

5626210
Plug and grommet included



5626211
Light only (sold in qty of 10)



5626050
(sold in qty of 10)



5620350
(sold in qty of 25)

Part No.	Color	Mounting	Amp	Std. Qty	Wt. (lbs.)
5626210	Amber	Grommet (Included)	.224	1	0.71
5626211	Amber	Grommet (sold separately)	.224	10	0.31

Bulk. Part number indicates single light only. 5626211 must be ordered in multiples of 10.

Accessories

Part No.	Description	Std. Qty	Wt. (lbs.)
5626050	Replacement Black Grommet	10	0.18
5620350	3-Pin Right Angle Male PL-3 Plug with Stripped Leads and #10 Ring on Ground	25	0.03

Bulk. Part number indicates single item only. 5626050 must be ordered in multiples of 10. 5620350 must be ordered in multiples of 25.

6" MIDSHIP TURN SIGNAL AND SIDE MARKER WITH REFLEX AND 9 LEDS



Number of LEDs	9
Size	6"
Connection	PL-3

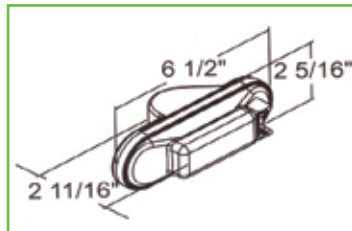

5626209
Plug and grommet included



5626208
Light only (sold in qty of 10)



5626050
(sold in qty of 10)



5620350
(sold in qty of 25)

Part No.	Color	Mounting	Amp	Std. Qty	Wt. (lbs.)
5626209	Amber	Grommet (Included)	.114	1	0.30
5626208	Amber	Grommet (sold separately)	.114	10	0.30

Bulk. Part number indicates single light only. 5626208 must be ordered in multiples of 10.

Accessories

Part No.	Description	Std. Qty	Wt. (lbs.)
5626050	Replacement Black Grommet	10	0.18
5620350	3-Pin Right Angle Male PL-3 Plug with Stripped Leads and #10 Ring on Ground	25	0.03

Bulk. Part number indicates single light only. 5626050 must be ordered in multiples of 10. 5620350 must be ordered in multiples of 25.



4" ROUND STOP/TURN/TAIL LIGHT WITH 7 LED



Number of LEDs	7
Size	4"
Connection	STD PL-2

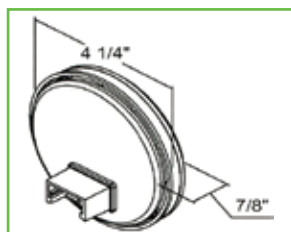

5624357
Plug and grommet included



5624356
(sold in qty of 10)



5624050
(sold in qty of 10)

5621004
(sold in qty of 10)



5620251
(sold in qty of 25)

Part No.	Color	Mounting	Amp	Std. Qty	Wt. (lbs.)
5624357	Clear	Grommet (Included)	.150	10	0.23
5624356	Clear	Grommet (sold separately)	.150	10	0.23

Bulk. Part number indicates single item only. Must order in multiples of 10.

Accessories

Part No.	Description	Std. Qty	Wt. (lbs.)
5624050	Replacement Black Grommet	10	0.15
5621004	Black Plastic Security Grommet	10	0.08
5620251	2-Pin Right Angle Male Plug with Stripped Power Wire and #10 Ring on Ground	25	0.03

Bulk. Part number indicates single item only. 5624050 and 5621004 must be ordered in multiples of 10. 5620251 must be ordered in multiples of 25.

4" ROUND BACKUP LIGHT KIT WITH 10 LEDS



Number of LEDs	10
Size	4"
Connection	STD PL-2

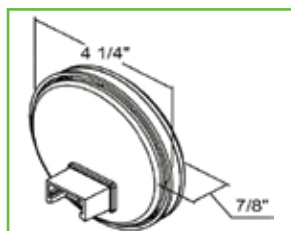

5624310
Plug and grommet included



5624350
(sold in qty of 10)



5624050
(sold in qty of 10)

5621004
(sold in qty of 10)



5620251
(sold in qty of 25)

Part No.	Color	Mounting	Amp	Std. Qty	Wt. (lbs.)
5624310	Clear	Grommet (Included)	.213	1	0.70
5624350	Clear	Grommet (sold separately)	.213	10	0.36

Bulk. Part number indicates single item only. Must order in multiples of 10.

Accessories

Part No.	Description	Std. Qty	Wt. (lbs.)
5624050	Replacement Black Grommet	10	0.15
5621004	Black Plastic Security Grommet	10	0.08
5620251	2-Pin Right Angle Male Plug with Stripped Power Wire and #10 Ring on Ground	25	0.03

Bulk. Part number indicates single item only. 5624050 and 5621004 must be ordered in multiples of 10. 5620251 must be ordered in multiples of 25.

4" Round and 6" Oval Backup Lights

4" ROUND BACKUP LIGHT KIT WITH 24 LEDs



Number of LEDs	24
Size	4"
Connection	STD PL-2

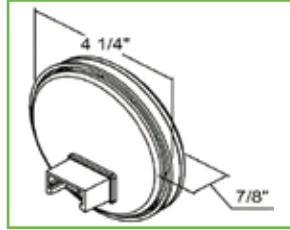

5624324
Plug and grommet included



5624325
(sold in qty of 10)



5624050
(sold in qty of 10)

5621004
(sold in qty of 10)



5620251
(sold in qty of 25)

Part No.	Color	Mounting	Amp	Std. Qty	Wt. (lbs.)
5624324	Clear	Grommet (Included)	.141	1	0.80
5624325	Clear	Grommet (sold separately)	.141	10	0.42

Bulk. Part number indicates single item only. Must order in multiples of 10.

Accessories

Part No.	Description	Std. Qty	Wt. (lbs.)
5624050	Replacement Black Grommet	10	0.15
5621004	Black Plastic Security Grommet	10	0.08
5620251	2-Pin Right Angle Male Plug with Stripped Power Wire and #10 Ring on Ground	25	0.03

Bulk. Part number indicates single item only. 5624050 and 5621004 must be ordered in multiples of 10. 5620251 must be ordered in multiples of 25.

6" OVAL BACKUP LIGHT WITH 6 LEDs



Number of LEDs	6
Size	6"
Connection	STD PL-2

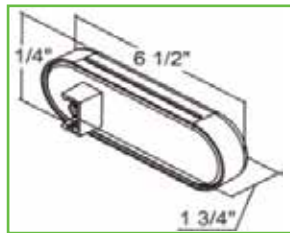

5626357
Plug and grommet included



5626356
Light only (sold in qty of 10)



5626050
(sold in qty of 10)



5620251
(sold in qty of 25)

Part No.	Color	Mounting	Amp	Std. Qty	Wt. (lbs.)
5626357	Clear	Grommet (Included)	.150	1	0.23
5626356	Clear	Grommet (sold separately)	.150	10	0.23

Bulk. Part number indicates single light only. 5626130 must be ordered in multiples of 10.

Accessories

Part No.	Description	Std. Qty	Wt. (lbs.)
5626050	Replacement Black Grommet	10	0.18
5620251	2-Pin Right Angle Male Plug with Stripped Power Wire and #10 Ring on Ground	25	0.03

Bulk. Part number indicates single item only. 5626050 must be ordered in multiples of 10. 5620251 must be ordered in multiples of 25.



6" OVAL BACKUP LIGHT WITH 10 LEDs



Number of LEDs	10
Size	6"
Connection	STD PL-2



5626310
Plug and grommet included



5626311
Light only (sold in qty of 10)



5626050
(sold in qty of 10)



5620251
(sold in qty of 25)

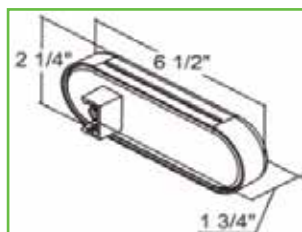

Part No.	Color	Mounting	Amp	Std. Qty	Wt. (lbs.)
5626310	Clear	Grommet (Included)	.218	1	0.70
5626311	Clear	Grommet (sold separately)	.138	10	0.38

Bulk. Part number indicates single light only. **5626311** must be ordered in multiples of 10.

Accessories

Part No.	Description	Std. Qty	Wt. (lbs.)
5626050	Replacement Black Grommet	10	0.18
5620251	2-Pin Right Angle Male Plug with Stripped Power Wire and #10 Ring on Ground	25	0.03

Bulk. Part number indicates single item only. **5626050** must be ordered in multiples of 10. **5620251** must be ordered in multiples of 25.

6" OVAL BACKUP LIGHT WITH 24 LEDs



Number of LEDs	24
Size	6"
Connection	STD PL-2



5626324
Plug and grommet included



5626325
Light only (sold in qty of 10)



5626050
(sold in qty of 10)



5620251
(sold in qty of 25)

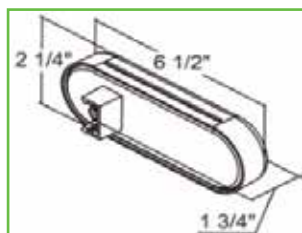

Part No.	Color	Mounting	Amp	Std. Qty	Wt. (lbs.)
5626324	Clear	Grommet (Included)	.138	1	0.86
5626325	Clear	Grommet (sold separately)	.218	10	0.43

Bulk. Part number indicates single light only. **5626325** must be ordered in multiples of 10.

Accessories

Part No.	Description	Std. Qty	Wt. (lbs.)
5626050	Replacement Black Grommet	10	0.18
5620251	2-Pin Right Angle Male Plug with Stripped Power Wire and #10 Ring on Ground	25	0.03

Bulk. Part number indicates single item only. **5626050** must be ordered in multiples of 10. **5620251** must be ordered in multiples of 25.

5" Rectangular Backup Lights, License / Utility Plate Lights

5-1/3" RECTANGULAR BACKUP LIGHT KIT WITH 32 LEDS



Number of LEDs	32
Size	5-1/3"
Connection	STD PL-2

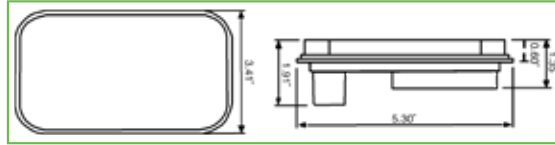

5625332
Plug and grommet included



5620251
(sold in qty of 25)

Part No.	Color	Mounting	Amp	Std. Qty	Wt. (lbs.)
5625332	Clear	Grommet (Included)	.301	1	0.55

Accessories

Part No.	Description	Std. Qty	Wt. (lbs.)
5620251	2-Pin Right Angle Male Plug with Stripped Power Wire and #10 Ring on Ground	25	0.03

Bulk. Part number indicates single light only. 5620350 must be ordered in multiples of 25.

1-1/2" ROUND LICENSE/UTILITY LIGHT WITH 4 LEDS



Number of LEDs	4
Size	1-1/2"
Connection	Hard Wired with Stripped Leads

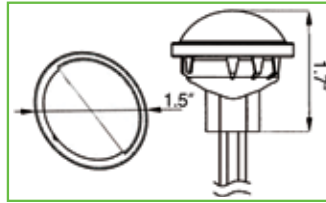

5621534

Part No.	Color	Mounting	Amp	Std. Qty	Wt. (lbs.)
5621534	Clear	Snap In	.030	1	0.10

Two lights needed to meet DOT requirements.

2" LICENSE/UTILITY LIGHT WITH 2 LEDS SERIES



Number of LEDs	4
Size	2"

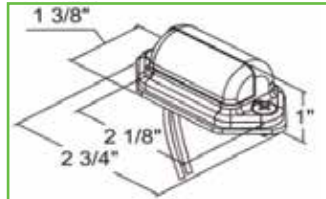

5622032
5622132 (sold in qty of 10)



5622130 (sold in qty of 10)



5622133 (sold in qty of 10)

Part No.	Housing Color	Connection	Mounting	Amp	Std. Qty	Wt. (lbs.)
5622032	Chrome	Stripped Leads	Surface	.047	1	0.07
5622132	Chrome	Stripped Leads	Surface	.047	10	0.07
5622130	Black	Stripped Leads	Surface	.047	10	0.07
5622133	Chrome	.180 Male Bullets	Surface	.047	10	0.08

Bulk. Part number indicates single light only. 5622132, 5622130 and 5622133 must be ordered in multiples of 10.

Two lights needed to meet DOT requirements.

2" SURFACE MOUNT LICENSE/UTILITY LIGHT WITH 2 LEDS



Number of LEDs	2
Size	2"
Connection	Hard Wired with .180 Male Bullets

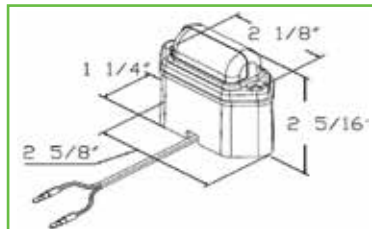

5622134
Light only (sold in qty of 10)

Part No.	Color	Mounting	Amp	Std. Qty	Wt. (lbs.)
5622134	Clear	Surface	.047	10	0.13

Bulk. Part number indicates single item only. Must order in multiples of 10.



2-3/4" LICENSE PLATE LIGHT WITH 2 LEDS



Number of LEDs	2
Size	2-3/4"
Connection	Hard Wired with Stripped Leads



5622754
Light only (sold in qty of 10)

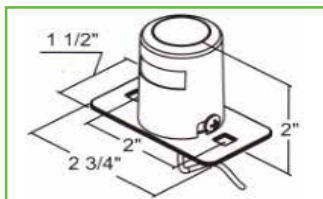

Part No.	Color	Mounting	Amp	Std. Qty	Wt. (lbs.)
5622754	Clear	Surface	.086	10	0.17

Bulk. Part number indicates single item only. Must order in multiples of 10. Two lights needed to meet DOT requirements.

DOT TURN SIGNAL EQUALIZER PLUGS



5621010



5621012

Part No.	Description	Wt. (lbs.)
5621010	50 Watt LED Turn Signal Equalizer with Right Angle Male PL-3 Plug and Stripped Leads	0.12
5621012	50 Watt LED Turn Signal Equalizer with Right Angle Male PL-3 Plug and Straight Female PL-3 Plug	0.15

DOT LIGHT PLUGS



5620250



5620352



5620251



5620354



5620350



5620355



5620351

Part No.	Description	Wt. (lbs.)
5620250	2-Pin In-Line Male PL-10 Plug with Stripped Power Wire and #10 Ring on Ground	0.03
5620251	2-Pin Right Angle Male Plug with Stripped Power Wire and #10 Ring on Ground	0.03
5620350	3-Pin Right Angle Male PL-3 Plug with Stripped Leads and #10 Ring on Ground	0.03
5620351	3-Wire AMP-Style Plug, 3-Pin Straight Female PL-3 Plug	0.07
5620352	3-Wire AMP-Style Plug, with Stripped Leads and #10 Ring on Ground	0.03
5620354	3-Wire AMP-Style Plug, with 3-Pin Right Angle Male PL-3 Plug	0.06
5620355	3-Wire, 3-Pin Straight Male PL-3 Plug with Stripped Leads and #10 Ring on Ground	0.05

DOT REFLECTORS



5623316



5623001



5623317



5623520



5623000



5623521

Part No.	Description	Std. Qty	Wt. (lbs.)
5623316	3-3/16" Round, Bolt-on, Red	10	0.50
5623317	3-3/16" Round, Bolt-on, Amber	10	0.50
5623000	3" Round, Stick-on, Red, 100 per Roll	1 Roll	0.55
5623001	3" Round, Stick-on, Amber, 100 per Roll	1 Roll	0.55
5623520	3-1/2" Rectangular, Stick-on, Red, 500 per Roll	1 Roll	2.20
5623521	3-1/2" Rectangular, Stick-on, Amber, 500 per Roll	1 Roll	2.20

DOT CONSPICUITY TAPE

- DOT approved
- ASTM D4956 - 93B Type V
- LS300C

- FP92
- NHTSA 49 CFT, Part 571, DOT-C2



CT150RW



CT151RW

Part No.	Description	Wt. (lbs.)
CT150RW	DOT Conspicuity Tape, 5-Year Rating, 150' Roll, 11" Red, 7" White	1.5
CT151RW	DOT Conspicuity Tape, 3-Year Rating, 150' Roll, 11" Red, 7" White	1.5

Light Bar Kits

44" LIGHT BAR KITS



8891144



8891145

Part No.	Description
8891144 (Round)	(1) 304 Stainless Steel Light Box, Dimension: 44" L x 8" H x 3" D (2) 4" Round STT Lights, 10 Red LEDs (2) 4" Round Strobe Lights, 24 Amber LEDs (3) 2.5" Round Marker Lights, 4 Red LEDs (1) Wire Harness (2) LED Load Equalizers

Comes with lights and wiring harness.

Part No.	Description
8891145 (Oval)	(1) 304 Stainless Steel Light Box, Dimension: 44" L x 8" H x 3" D (2) 6" Oval STT Lights, 10 Red LEDs (2) 6" Oval Strobe Lights, 24 Amber LEDs (3) 2.5" Round Marker Lights, 4 Red LEDs (1) Wire Harness (2) LED Load Equalizers

Comes with lights and wiring harness.

66" LIGHT BAR KITS



8891166



8891167



8891168



8891169

Part No.	Description
8891166 (Round)	(1) 304 Stainless Steel Light Box, Dimension: 66" L x 8" H x 3" D (2) 4" Round STT Lights, 10 Red LEDs (2) 4" Round Back-Up Lights, 10 Clear LEDs (2) 4" Round Strobe Lights, 24 Amber LEDs (3) 2.5" Round Marker Lights, 4 Red LEDs (1) Wire Harness (2) LED Load Equalizers

Comes with lights and wiring harness.

Part No.	Description
8891167 (Round)	(1) 304 Stainless Steel Light Box, Dimension: 66" L x 8" H x 3" D (4) 4" Round STT Lights, 10 Red LEDs (2) 4" Round Strobe Lights, 24 Amber LEDs (3) 2.5" Round Marker Lights, 4 Red LEDs (1) Wire Harness (2) LED Load Equalizers

Comes with lights and wiring harness.

Part No.	Description
8891168 (Oval)	(1) 304 Stainless Steel Light Box, Dimension: 66" L x 8" H x 3" D (2) 6" Oval STT Lights, 10 Red LEDs (2) 6" Oval Back-Up Lights, 10 Clear LEDs (2) 6" Oval Strobe Lights, 24 Amber LEDs (3) 2.5" Round Marker Lights, 4 Red LEDs (1) Wire Harness (2) LED Load Equalizers

Comes with lights and wiring harness.

Part No.	Description
8891169 (Oval)	(1) 304 Stainless Steel Light Box, Dimension: 66" L x 8" H x 3" D (4) 6" Oval STT Lights, 10 Red LEDs (2) 6" Oval Strobe Lights, 24 Amber LEDs (3) 2.5" Round Marker Lights, 4 Red LEDs (1) Wire Harness (2) LED Load Equalizers

Comes with lights and wiring harness.

WIRING HARNESS FOR 44" AND 66" LIGHT BARS

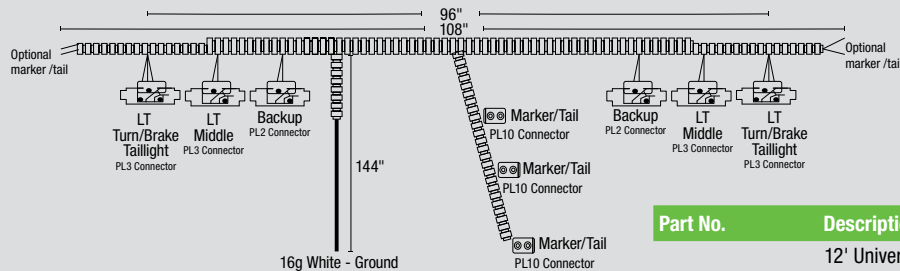

*LT & RT Middle Lights may be used as additional stop light or for safety strobe lights.

- 16g White - Ground
- 16g Tan - Marker/Tail
- 16g Black - Left Middle*
- 16g Red - Right Middle*
- 16g Blue - Backup
- 16g Yellow - Left Turn/Brake
- 16g Green - Right Turn/Brake

Part No.	Description
5609000	12' Universal DOT Rear Wiring Harness - Comes with 4 PL-3 Connectors, 2 PL-2 Connectors, 3 PL-10 Connectors, 2 Optional Marker/Tail Connections Included with 44" and 66" Light Bar Kits



77" LIGHT BAR KITS



8891177



8891178

Part No.	Description
8891177 (Oval)	(1) 304 Stainless Steel Light Box, Dimension: 77" L x 4" H x 3" D (2) 6.5" Oval Strobe Lights, 24 Amber LEDs (2) 6.5" Oval Back-Up Lights, 10 Clear LEDs (2) 6.5" Oval STT, 10 Red LEDs (3) .75" Round Marker Lights, 3 Red LEDs (1) Wire Harness (2) LED Load Equalizers

Comes with lights and wiring harness.

Part No.	Description
8891178 (Oval)	(1) 304 Stainless Steel Light Box, Dimension: 77" L x 4" H x 3" D (4) 6" Oval STT Lights, 10 Red LEDs (2) 6" Oval Strobe Lights, 24 Amber LEDs (3) .75" Round Marker Lights, 3 Red LEDs (1) Wire Harness (2) LED Load Equalizers/Turn Signal

Comes with lights and wiring harness.

WIRING HARNESS FOR 77" LIGHT BARS

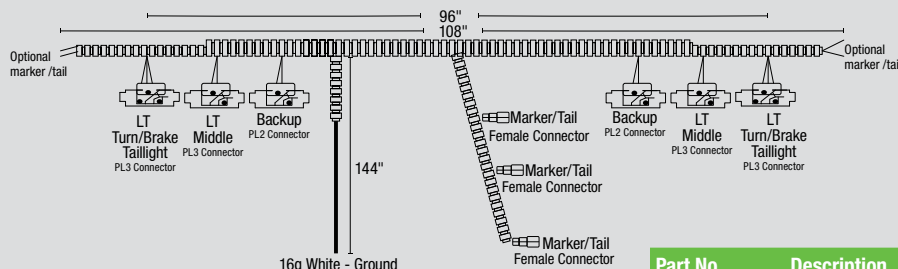

*LT & RT Middle Lights may be used as additional stop light or for safety strobe lights.

- 16g White - Ground
- 16g Tan - Marker/Tail
- 16g Black - Left Middle*
- 16g Red - Right Middle*
- 16g Blue - Backup
- 16g Yellow - Left Turn/Brake
- 16g Green - Right Turn/Brake

Part No.	Description
5609001	12' Universal DOT Rear Wiring Harness - Comes with 4 PL-3 Connectors, 2 PL-2 Connectors, 3 Female Bullet Connectors, 2 Optional Marker/Tail Connections Included with 77" Light Bar Kits



8891168 shown

DOT Light Boxes

44" STAINLESS STEEL LIGHT BAR FOR ROUND LIGHTS



Part No.	Description
LB8443SST	(4) 4" and (3) 2-1/2" Round Cutouts, 8" x 3" x 44" (Lights Not Included)

44" STAINLESS STEEL LIGHT BAR FOR OVAL LIGHTS



Part No.	Description
LB8445SST	(4) 6" Oval and (3) 2-1/2" Round Cutouts, 8" x 3" x 44" (Lights Not Included)

66" STAINLESS STEEL LIGHT BAR FOR ROUND LIGHTS



Part No.	Description
LB8663SST	(6) 4" and (3) 2-1/2" Round Cutouts, 8" x 3" x 66" (Lights Not Included)

66" STAINLESS STEEL LIGHT BAR FOR OVAL LIGHTS



Part No.	Description
LB8665SST	(6) 6" Oval and (3) 2-1/2" Round Cutouts, 8" x 3" x 66" (Lights Not Included)

77" STAINLESS STEEL LIGHT BAR FOR OVAL LIGHTS



Part No.	Description
LB4773SST	(6) 6" Oval and (3) 3/4" ID Marker Light Cutouts, 4" x 3" x 77" (Lights Not Included)



WIRING HARNESS

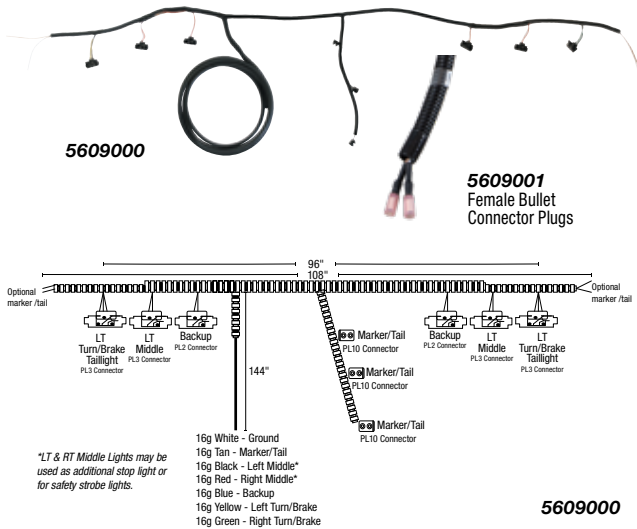

Part No.	Description
5609000	12' Universal DOT Rear Wiring Harness - Comes with 4 PL-3 Connectors, 2 PL-2 Connectors, 3 PL-10 Connectors, 2 Optional Marker/Tail Connections For use with 44" & 66" Light Bars.
5609001	12' Universal DOT Rear Wiring Harness - Comes with 4 PL-3 Connectors, 2 PL-2 Connectors, 3 Female Bullet Connectors, 2 Optional Marker/Tail Connections. For use with 77" Light Bars.

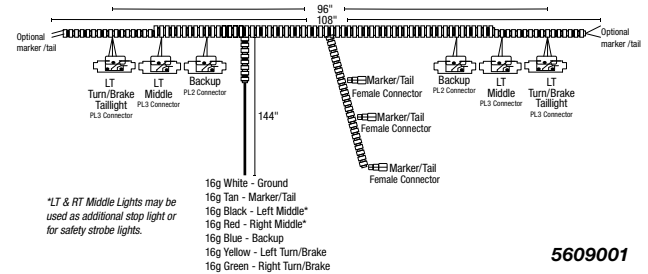

SINGLE OVAL LIGHT BOXES



Part No.	Description
LB383	Single Oval, Black Powder-Coated Steel, (3" x 8" x 3")

Part No.	Description
LB383SL	Single Oval with Side Light, Black Powder-Coated Steel, (3" x 8" x 3")

Part No.	Description
LB383SST	Single Oval, Stainless Steel, (3" x 8" x 3")

Part No.	Description
LB383ALDT	Single Oval, Diamond Tread Aluminum, (3" x 8" x 3")

Part No.	Description
LB383ALSM	Single Oval, Smooth Aluminum, (3" x 8" x 3")

Part No.	Description
LB383P	Single Oval, Black Polymer, (3" x 8" x 3")

Part No.	Description
LB384	Single Oval, Both Front and Back, Black Powder-Coated Steel, (3" x 8" x 4")

DOT Light Boxes

DUAL OVAL LIGHT BOXES



LB163

Part No.	Description
LB3163	Dual Oval Black Powder-Coated Steel, (3" x 16" x 3")



LB3163SST

Part No.	Description
LB3163SST	Dual Oval Stainless Steel, (3" x 16" x 3")

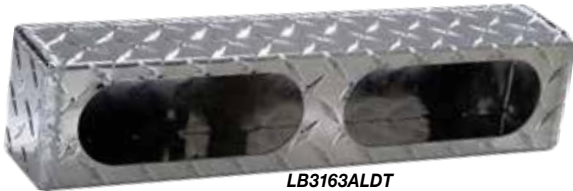

LB3163ALDT

Part No.	Description
LB3163ALDT	Dual Oval Diamond Tread Aluminum, (3" x 16" x 3")

TRIPLE OVAL LIGHT BOXES



LB3253

Part No.	Description
LB3253	Triple Oval, Black Powder-Coated Steel, (3" x 25" x 3")



LB3253ALDT

Part No.	Description
LB3253ALDT	Triple Oval Diamond Tread Aluminum, (3" x 25" x 3")



LB3253SST

Part No.	Description
LB3253SST	Triple Oval Stainless Steel, (3" x 25" x 3")



LB8133

Part No.	Description
LB8133	Triple Oval Vertical or Horizontal, Steel, Gray Primer, (8" x 13" x 3")



SINGLE ROUND LIGHT BOXES



LB663



LB663SL



LB663SST

Part No.	Description
LB663	Single Round Black Powder-Coated Steel, (6" x 6" x 3")

Part No.	Description
LB663SL	Single Round with 2" Side Light, Black Powder-Coated Steel, (6" x 6" x 3")

Part No.	Description
LB663SST	Single Round Stainless Steel, (6" x 6" x 3")

DUAL ROUND LIGHT BOXES



LB6123



LB6123SST



LB6123ALDT

Part No.	Description
LB6123	Dual Round, Black Powder-Coated Steel, (6" x 12" x 3")

Part No.	Description
LB6123SST	Dual Round, Stainless Steel, (6" x 12" x 3")

Part No.	Description
LB6123ALDT	Dual Round, Diamond Tread Aluminum, (6" x 12" x 3")

DOT Light Boxes

TRIPLE ROUND LIGHT BOXES



Part No.	Description
LB6183	Triple Round, Black Powder-Coated Steel, (6" x 18" x 3")



Part No.	Description
LB6183SST	Triple Round, Stainless Steel, (6" x 18" x 3")



Part No.	Description
LB6183ALDT	Triple Round, Diamond Tread Aluminum, (6" x 18" x 3")

DOT LIGHT MOUNTING BRACKETS



Part No.	Description
LB1	Single Oval, Black, 8.25" x 4.0"



Part No.	Description
LB1SS	Single Oval, Stainless Steel, 8.25" x 4.0"



TRIPLE ROUND LIGHT BOXES WITH MUDFLAP MOUNT **NEW**



LB6303SST

Part No.	Description
LB6303SST	Triple Round, Stainless Steel Kit, (6" x 30" x 3") Both Driver and Passenger Side
LB6304SST	Triple Round, Stainless Steel, (6" x 30" x 3") Driver Side
LB6305SST	Triple Round, Stainless Steel, (6" x 30" x 3") Passenger Side

Combination lightbox-mudflap mounts.

Accommodates (3) 4" round recessed or surface mount lights per box. Spring loaded for impact protection.



LB6303SST shown

Backup Camera Systems

NIGHT VISION BACKUP CAMERA SYSTEMS

**2-YEAR
W**
**12-24
VOLTS**
**IP
67**

Screen	7" TFT-LCD Color Monitor
Cable Length	65'
Mount	Standard U Bracket, Pedestal, and Flush Mount

- Auto reverse "on"
- License plate night vision camera
- Supports multiple camera feeds (*additional cameras sold separately*)
- Wireless remote
- Removable sun visor

STANDARD CAMERA WITH AUDIO

- Audio from rear camera - 8883101



Part No.	Description	Wt. (lbs.)
 8883000	Backup Camera System, Standard Camera	5.5

LICENSE PLATE CAMERA



Part No.	Description	Wt. (lbs.)
 8883010	Backup Camera System, License Plate Camera	5.5

RECESSED CAMERA



Part No.	Description	Wt. (lbs.)
 8883020	Backup Camera System, 1" Diameter Recessed Bullet Camera	5.5

REARVIEW MIRROR BACKUP CAMERA SYSTEM, NIGHT VISION CAMERA

**2-YEAR
W**
**12-24
VOLTS**
**IP
67**

Screen	4.3" TFT-LCD Mirror Monitor (Replaces OEM Mirror)
Cable Length	50'



- Auto reverse "on"
- Illuminated touch screen buttons
- Compact, IP68 back-up camera with night vision

Part No.	Description	Wt. (lbs.)
 8883030	Backup Camera System, Universal OEM 4.3" Monitor	1.88



QUAD SCREEN BACKUP CAMERA SYSTEMS

2-YEAR W 12-24 VOLTS IP 67	Screen	7" TFT-LCD Color Quad Screen Monitor
	Cable Length	65'
	Mount	Standard U Bracket, Pedestal, and Flush Mount

- Auto reverse "on"
- Audio from heated rear cameras
- Shows up to 4 adjustable camera views on same screen (*additional cameras sold separately*)
- Wireless remote
- Removable sun visor
- Refer to page 245 for additional cables

STANDARD QUAD SCREEN SYSTEM



Part No.	Description	Wt. (lbs.)
8883040	Backup Camera System, Quad Screen (1) Standard Camera	5.5

QUAD SCREEN SYSTEM WITH DVR **NEW**



Part No.	Description	Wt. (lbs.)
8883050	Backup Camera System with DVR	4.9

QUAD SCREEN SYSTEM WITH DVR AND BLIND SPOT DETECTION **NEW**



Part No.	Description	Wt. (lbs.)
8883060	Backup Camera System with DVR and BSP - Blind Spot Detection	4.9

Available Q2 of 2024

WIRELESS BACKUP CAMERA SYSTEM WITH BACKUP CAMERA

2-YEAR W 12-24 VOLTS IP 67	Screen	7" TFT-LCD Color Wireless Monitor
	Cable Length	65'
	Mount	Standard U Bracket and Suction Cup



- Auto reverse "on"
- Audio from rear camera
- Wireless night vision camera with audio
- Wireless remote
- New dual antenna provides stronger signal strength
- Removable sun visor

Part No.	Description	Wt. (lbs.)
8883210	Backup Camera System	3.2

Backup Camera Accessories

COLOR CAMERA WITH HEATED NIGHT VISION AND AUDIO

**2-YEAR
W**
**12-24
VOLTS**
**IP
67**



Part No.	Description	Wt. (lbs.)
8883101	Camera, Standard, Waterproof, Night Vision, Heated, Audio	0.01
8883053	Camera, Standard, Waterproof, Night Vision, Heated and BSD - Blind Spot Detection for use on 8883060	0.01

LICENSE PLATE MOUNT CAMERA WITH NIGHT VISION

**1-YEAR
W**
**12-24
VOLTS**
**IP
67**



Part No.	Description	Wt. (lbs.)
8883102	License Plate, Waterproof, 4-Pin	0.01

COLOR BULLET CAMERA FOR RECESSED MOUNTING WITH NIGHT VISION

**1-YEAR
W**
**12-24
VOLTS**
**IP
67**



Part No.	Description	Wt. (lbs.)
8883103	Camera, Recessed 1" Diameter Bullet, Waterproof, 4-Pin	0.01

SURFACE SIDE MOUNT CAMERA, COLOR WITH NIGHT VISION

**1-YEAR
W**
**12-24
VOLTS**
**IP
67**



Part No.	Description	Wt. (lbs.)
8883104	Camera, Side, Universal, Waterproof, 4-Pin	0.01

SPHERE SURFACE MOUNT CAMERA WITH NIGHT VISION

**1-YEAR
W**
**12-24
VOLTS**
**IP
67**



Part No.	Description	Wt. (lbs.)
8883105	Sphere Surface Mount, Waterproof, 4-Pin	0.01
8883062	Sphere Surface Mount, Waterproof, 4-Pin, and BSD - Blind Spot Detection for use on 8883060	0.01

SURFACE MOUNT CUBE CAMERA, COLOR WITH NIGHT VISION

**1-YEAR
W**
**12-24
VOLTS**
**IP
67**



Part No.	Description	Wt. (lbs.)
8883106	Cube Surface Mount, Camera, Waterproof, 4-Pin	0.01

DUAL CAMERA WITH NIGHT VISION

**1-YEAR
W**
**12-24
VOLTS**
**IP
67**



Part No.	Description	Wt. (lbs.)
8883108	Dual Hi-Low Camera, Waterproof, 4-Pin, Stainless Steel Housing	0.01



WORK LIGHTS WITH BUILT-IN BACKUP CAMERAS



Number of LEDs	8
Lumens	1,100
Lead Length	18"
Mount / Base	8mm Stud, SST



8883110

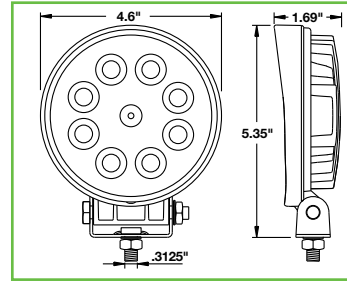

Round Work Lamp Camera

Part No.	Type	Color	Amp	Connection	Wt. (lbs.)
8883110	Flood	Clear	2.33	Deutsch	1.45

Features a 976 (H) x 592 (V) pixel resolution.
Night vision capabilities and a wide 140° viewing angle.

WIRELESS WATERPROOF COLOR CAMERA WITH NIGHT VISION AND AUDIO



Part No.	Description	Wt. (lbs.)
8883215	Camera, Standard, IP67, Night Vision, Heated, Wireless, for use with 8883210	0.01

UNIVERSAL CAMERA WASHING SYSTEM



- Ideal for salt spreader trucks
- High pressure
- Works with camera: **8883101**
- Includes: 1-1/2 quart tank with mounting bracket, 9-1/2 ft fluid tube with pressure nozzle, Pump, in-cab controller, 32 ft power cord, mounting hardware.

Part No.	Description	Wt. (lbs.)
8882150	Universal Camera Washing System, 12-24 VDC	0.01

CAMERA CABLE FOR BACKUP CAMERAS



Part No.	Description	Wt. (lbs.)
8883116	Cable, 16'/5m	0.01
8883132	Cable, 32'/10m	0.01
8883165	Cable, 65'/20m	0.01
8883182	Cable, 82'/25m	0.01

All accessory cameras require cable. (Sold Separately)

Booster Cables

BOOSTER CABLES WITH QUICK CONNECT

600 AMP GRAY PLUG-IN QUICK CONNECT KIT



Part No.	Length	Wire Gauge	Amp	Wt. (lbs.)
 5601025	28'	4	600	13

Replacement Parts

Part No.	Description	Wt. (lbs.)
5601020	6' Battery Side Cable with Gray Plug-In Quick Connect for 5601025	2.7
5601015	Gray Plug-In Quick Connect Replacement Kit for 5601025	0.78

600 AMP BLUE PLUG-IN QUICK CONNECT KIT



Part No.	Length	Wire Gauge	Amp	Wt. (lbs.)
 5601026	28'	4	600	13

Replacement Parts

Part No.	Description	Wt. (lbs.)
5601021	6' Battery Side Cable with Blue Plug-In Quick Connect for 5601026	2.7
5601016	Blue Plug-In Quick Connect Replacement Kit for 5601026	0.78

800 AMP RED PLUG-IN QUICK CONNECT KIT



Part No.	Length	Wire Gauge	Amp	Wt. (lbs.)
 5601032	32.5'	1	800	23.1

Replacement Parts

Part No.	Description	Wt. (lbs.)
5601022	7.5' Battery Side Cable with Red Plug-In Quick Connect for 5601032	2.7
5601017	Red Plug-In Quick Connect Replacement Kit for 5601032	0.78

1000 AMP BLACK PLUG-IN QUICK CONNECT KIT



Part No.	Length	Wire Gauge	Amp	Wt. (lbs.)
 5601033	32.5'	1	1000	28.6

Replacement Parts

Part No.	Description	Wt. (lbs.)
5601023	7.5' Battery Side Cable with Black Plug-In Quick Connect for 5601033	2.7
5601018	Black Plug-In Quick Connect Replacement Kit for 5601033	0.78



4" LED RECHARGEABLE MAGNETIC ROAD FLARES

IP 67

LEDs Per Flare	16
Number of Flash Patterns	10
Color	Amber
Run Time	8 - 60 Hours
Recharge Time	4 - 5 Hours
Housing	Crush-Proof with Magnetic Bottom
Charger	120V Wall Charger/12V Vehicle Charger

- Includes steady-on "flashlight mode"
- Strobes float in water

SINGLE ROAD STROBE FLARE

- Vehicle charger included



8891016
Single road strobe/flare

Part No.	Number of Flares	Amp	Wt. (lbs.)
 8891016	1	0.5	0.85

4 ROAD STROBE FLARE CASE

- Wall & vehicle charger included



8891017
Case of 4 road strobe/flares

Part No.	Number of Flares	Amp	Wt. (lbs.)
 8891017	4	0.5	5.00

6 ROAD STROBE FLARE CASE

- Wall & vehicle charger included



8891018
Case of 6 road strobe/flares

Part No.	Number of Flares	Amp	Wt. (lbs.)
 8891018	6	0.5	6.42



8891017 shown

Towing Lights and Backup Alarms

HEAVY-DUTY TOWING LIGHT SET

Bulb Type	Incandescent
Housing	Rubber
Mounting	Magnetic

Visible for up to one mile.

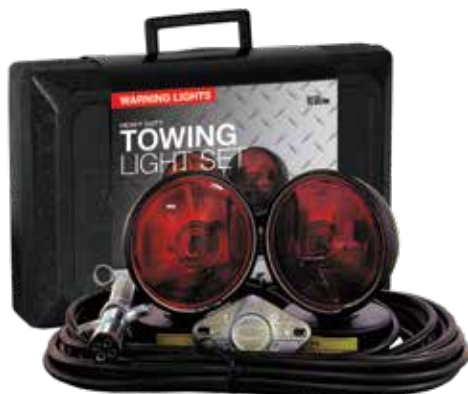

Part No.	Lens Color	Lead Length	Connection	Wt. (lbs.)
 TL257M	Red	30'	4 Pin Round Connector	5.32

SELF-GROUNDING BACKUP ALARMS

**2-YEAR
W**
**12-24
VOLTS**
**IP
65**

Housing	Nylon
---------	-------

Meets OSHA, Bureau of Mines, GSA & all state regulations.

97 DECIBEL



BA0972

Part No.	Decibels	Size	Wt. (lbs.)
 BA0972	97 dB	4" x 1-5/8" x 2-5/8"	0.42

SAE
J994

102 DECIBEL



BA102

Part No.	Decibels	Size	Wt. (lbs.)
 BA102	102 dB	4" x 1-5/8" x 2-5/8"	0.60

SAE
J994

107 DECIBEL



BA107

Part No.	Decibels	Size	Wt. (lbs.)
 BA107	107 dB	4" x 1-3/4" x 3-1/16"	0.68

SAE
J994



PRE-WIRED SWITCH PANELS

- Prewired and fused
- Backlit

PRE-WIRED SINGLE SWITCH PANEL

- 10 Amp, "On/Off"



Part No.	Description	Wt. (lbs.)
 6391001	Single Switch Panel, On-Off Illuminated, 2"L x 1.625"W x 2.25"T	0.22

PRE-WIRED DOUBLE SWITCH PANEL

- 15 Amp, "On/Off"



Part No.	Description	Wt. (lbs.)
 6391002	Double Switch Panel, On-Off Illuminated, 3"L x 1.625"W x 2.25"T	0.29

PRE-WIRED TRIPLE SWITCH PANEL

- 20 Amp, "On/Off"



Part No.	Description	Wt. (lbs.)
 6391003	Triple Switch Panel, On-Off Illuminated, 3.875"L x 1.625"W x 2.25"T	0.29

PRE-WIRED QUAD SWITCH PANEL

- 20 Amp, "On/Off"



Part No.	Description	Wt. (lbs.)
 6391004	Quad Switch Panel, On-Off Illuminated, 4.75"L x 1.625"W x 2.25"T	0.29

SINGLE ON/OFF SWITCH



Part No.	Description	Wt. (lbs.)
6391101	Replacement Rocker Switch, On/Off Red, 12VDC	0.02

Switch Panels

8 FUNCTION PROGRAMMABLE SWITCH PANEL



- 8 function programmable switch panel comes pre-wired to control up to eight 12V auxiliary devices
- This extremely versatile panel combines 8 relays and 8 circuit breakers into a single compact unit, drastically simplifying the wiring in the vehicle's cab and makes installation clean and simple
- The unit is ideal for a wide range of applications, including crane trucks, brush trucks, utility, and municipal vehicles
- The panel features 5 On/Off switches and 3 switches that can be configured as momentary or On/Off to suit your needs
- Each switch is rated for a maximum current of 15 amps with a max of 60 total amps running through the panel at any one time
- The switch panel is backlit and includes a legend with over 120 different switch label

Part No.	Description	Wt. (lbs.)
6391308	8 Function Panel Switch, Illuminated-On, Pre-Wired	1.68

7 FUNCTION PROGRAMMABLE SWITCH PANEL



6391208

6391209

- The programmable panel supports up to 7 functions, and can be used to control multiple lights and/or other equipment
- For use with 49" and 60" modular light bars

Part No.	Description	Wt. (lbs.)
6391208	Switch Panel, 7 Function, Multi-Purpose, Programmable	0.83
6391209	Switch Panel, 8 Function, Multi-Purpose, Programmable with Relay Module	0.83

CONTROL PANEL / FUNCTION

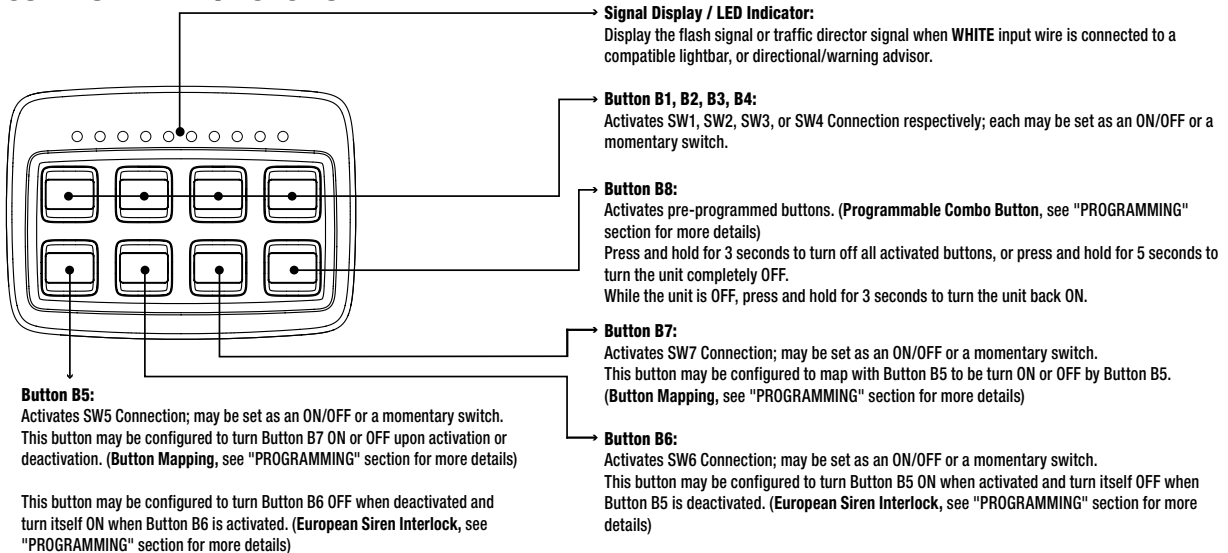

PRE-WIRED SWITCH WITH MOMENTARY BUTTON



- On-off, flash pattern control
- 15' Pre-wired cable
- 10 Amp
- 2-1/2" L x 1-1/2" W x 1" H

Part No.	Description	Wt. (lbs.)
6391215	Switch Panel, On-Off with Flash Pattern	1.0

4 FUNCTION BACKLIT PRE-WIRED SWITCH BOX



- 12V pre-wired switch boxes fused with relay & circuit breaker
- Individually fused
- Multiple legends included

Part No.	Description	Wt. (lbs.)
 6391104	4 Function Backlit Switch Box (3) 20 Amp, (1) 40 Amp	2.4

6 FUNCTION BACKLIT PRE-WIRED SWITCH BOX



- 12V pre-wired switch boxes fused with relay & circuit breaker
- Individually fused
- Multiple legends included

Part No.	Description	Wt. (lbs.)
 6391106	6 Function Backlit Switch Box (5) 20 Amp, (1) 40 Amp	2.9

SINGLE ON/OFF SWITCH



Part No.	Description	Wt. (lbs.)
6391101	Replacement Rocker Switch, On/Off Red, 12VDC	0.02

MINI ROUND ROCKER SWITCHES



6391100

Part No.	Description	Wt. (lbs.)
6391100	On/Off Mini Round Rocker Switch Illuminated, 0.75", Red	0.01



6391102

Part No.	Description	Wt. (lbs.)
6391102	On/Off Mini Round Rocker Switch, 0.75", Black	0.01



6391103

Part No.	Description	Wt. (lbs.)
6391103	On/Off/On Mini Round Rocker Switch, 0.75", Black	0.01



6391105

Part No.	Description	Wt. (lbs.)
6391105	Momentary (On)/Off Mini Round Rocker Switch, 0.75", Black	0.01

Switches

ROCKER SWITCH & BRACKET



- Commonly used with tarp gear motors

Part No.	Description	Wt. (lbs.)
3014187	12 Volt, Double Momentary Open/Close	2.9
3014188	Rocker Switch Bracket	2.9

LED STROBE CONTROLLER



- LED strobe flasher
- Includes 2-sided 3M mounting tape and 3 wire taps
- 12-24V
- 6 Amps
- Commonly used with strip lights on page 168

Part No.	Description	Wt. (lbs.)
5621002	LED Strobe Controller with 6" Leads, Converts Steady-On Strip Lights to a Strobe Pattern	0.07

12 VOLT PANEL MOUNT MOMENTARY PUSH-BUTTON SWITCH



- Weatherproof, dust proof, single pole, single throw
- Rubber cap & mounting nut assembly, two screw terminals with lock-washers
- Mounting stem 5/8"-32 Thd., 21/32" long
- Max 35 amps

Part No.	Description	Wt. (lbs.)
BSW90030	Switch, Momentary Push Button, 12V	0.11

12 VOLT HEAVY DUTY ROTARY ON/OFF SWITCH



- Single pole battery disconnect, two position (on & off)
- 12V DC, 20A continuous 125A intermittent +15 sec.on, min off
- Two 3/8" copper terminal studs
- Brass mounting stem
- 3/4"-16 Thd., 23/32" long, fits through 3/16" thick panel

Part No.	Description	Wt. (lbs.)
SW700	Switch with Face Plate	0.89



50 AMP ROTARY SWITCH



- Commonly used with tarp gear motors
- Heavy-duty 50 AMP rotary switch controls forward and reverse motion of a 12-volt motor (No relay required)
- Momentary on/off/momentary on lever type actuator
- 4 screw terminals with silver laminated contacts
- M12 x 1.0 mounting threads
- Aluminum name plate included

Part No.	Description	Wt. (lbs.)
SW710	Switch, 50 AMP, Rotary, Momentary	0.39

12 VOLT MOMENTARY SWITCH



- Push for ON, Spring return for OFF
- Two brass terminals
- Two 5/8"-32 brass screws
- 2-5/16" long OD
- 5/8" diameter mounting hole, fits through 3/4" thick panel
- Moisture repellent insulator

Part No.	Description	Wt. (lbs.)
SW900	Switch, Momentary, 12V, (2) Terminals	0.12

12 VOLT RECESSED TOGGLE SWITCH



SW911



SW9111

- 12 VDC, 10 AMP switch with panel mount
- Two blade terminals
- Recessed pan protects switch from impacts & accidental activation
- 20 gauge zinc-plated steel pan
- 2" diameter mounting hole

Part No.	Description	Wt. (lbs.)
SW911	Switch, Toggle, 12V (2) Blade Terminals and Recessed Panel Mount	0.12
SW9111	Switch, Toggle, 12V (2) Blade Terminals	0.12

Circuit Breakers

HI-AMP CIRCUIT BREAKERS



Manual Reset, Push-to-Trip



Auto Reset

- For cranes, dump hoists, liftgates, plows, spreaders, etc.
- 1/4-28 silver plated studs and stainless steel nuts with rubber boots
- Waterproof

Part No.	Amps	Description
CB30PB	30	Manual Reset, Push-to-Trip
CB50	50	Auto Reset
CB50PB	50	Manual Reset, Push-to-Trip
CB60	60	Auto Reset
CB60PB	60	Manual Reset, Push-to-Trip
CB80PB	80	Manual Reset, Push-to-Trip
CB90PB	90	Manual Reset, Push-to-Trip
CB100	100	Auto Reset
CB100PB	100	Manual Reset, Push-to-Trip
CB120PB	120	Manual Reset, Push-to-Trip
CB150	150	Auto Reset
CB150PB	150	Manual Reset, Push-to-Trip
CB200PB	200	Manual Reset, Push-to-Trip

HI-AMP LARGE FRAME CIRCUIT BREAKERS



Manual Reset, Push-to-Trip

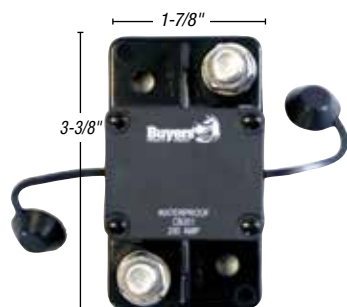

Auto Reset

- For cranes, dump hoists, liftgates, plows, spreaders, etc.
- 3/8" silver plated steel studs and nuts with rubber boots provide additional clearance for heavy gauge connectors
- Waterproof

Part No.	Amps	Description
CB151	150	Auto Reset
CB151PB	150	Manual Reset, Push-to-Trip
CB201	200	Auto Reset
CB201PB	200	Manual Reset, Push-to-Trip
CB251PB	250	Manual Reset, Push-to-Trip
CB300	300	Auto Reset

40 AMP CIRCUIT BREAKER



3014119



3014214

Part No.	Description	Wt. (lbs.)
3014119	Manual Reset 40 Amp Circuit Breaker	0.04
3014214	Auto Reset 40 Amp Circuit Breaker	0.05



MOTORS

COUNTER CLOCKWISE ROTATION



Part No.	Description
M3100	12 Volt D.C. Motor Less Drive, End Tang Shaft

CLOCKWISE ROTATION



Part No.	Description
M3200	12 Volt D.C. Motor, Less Drive, End Tang Shaft

BI-ROTATIONAL



Part No.	Description
M3300	12 Volt, DC Motor

CLOCKWISE ROTATION WITH SPLINE OUTPUT SHAFT



Part No.	Description
M3400	12 Volt D.C. Motor with 9-Spline Output Shaft

SOLENOIDS

CANISTER TYPE



- Push for ON, Spring return for off
- 5/16"-24 Thd. terminals
- 1" diameter mounting hole
- Fits through 1/4" panel thickness
- Button extends 1" above faceplate

Part No.	Description
B63322	Solenoid - Canister

CONTINUOUS DUTY 12 VOLT PLASTIC CASE (INSULATED)



1306317



1304719

- Waterproof, sealed design
- 11/32" holes, 3" on center
- 5/16"-24 Thd. terminals
- 10-32 coil terminals

Part No.	Description
1306317	Solenoid, 12V, Motor Relay, Continuous
1304719	Solenoid, 12V, 150 AMP, Motor Relay, Intermittent

Solenoids

SOLENOIDS - continued

INTERMITTENT 12 VOLT PLASTIC CASE (INSULATED)



1306070



1306300

- 5/16"-24 Thd. terminals
- 9/32" x 25/64" holes, 27/64" on center

Part No.	Description
1306070	Intermittent-duty, +12V to Activate
1306300	Intermittent-duty, GND to Activate

SOLENOID SWITCH KIT



1306600



3014186

- 150 amp, grounded coils
- Alloy silver-plated contact material, intermittent-duty
- Ideal for any application that requires reversing motion (truck winch, tarp systems, boat lifts, RV slide-out, RV leveling systems)

Part No.	Description
1306600	Solenoid, grounded, Reversing Polarity
3014186	Plastic Cover for 1306600 (Sold Separately)

GROUNDING 12 VOLT STEEL CASE (INSULATED)



B98596

- Continuous-duty
- 5/16"-24 thread terminals
- 12 volts applied to center terminals activates solenoid

Part No.	Description
B98596	Solenoid-Steel Case with Slots



1306505

- Continuous-duty
- 5/16"-24 thread terminals
- 29/32" x 25/64" holes, 27/64" on center
- Ground connection applied to center terminal activates solenoid

Part No.	Description
1306505	Solenoid, Steel, Ground-Activate

12 VOLT STEEL CASE SOLENOID (INSULATED)



- Continuous-duty
- 5/16"-24 thread terminals
- Ground connection applied to center terminal activates solenoid
- Compares to Cole-Hersee® #24059

Part No.	Description
1306515	Solenoid, Steel, 12V, Continuous Duty



HOUR METER



- Low power, low cost reliable hour meter with quartz timing
- Compact, tamper proof meter is sealed against moisture and dirt
- Mechanical counter requires no battery

Part No.	Description
B40B45	10-80V DC Hour Meter, 2.75" Diameter x 1.875" Deep

Compact, tamper proof meter is sealed against moisture and dirt.

LOCKING BATTERY DISCONNECT SWITCH



- 2500 amp surge/250 amp continuous for 5 seconds
- 12-24VDC
- Complies with OSHA 1910.147 lock-out/tag-out

Part No.	Description
6391005	Battery Disconnect Switch, Dual, 250A

BRASS BATTERY BOLT ADAPTERS, BULK



- Organize and protect battery connections
- Reduce corrosion of battery and connections
- Reduce warranty claims
- Replaces standard battery bolts
- Attach lights, backup alarms, lift gates, plows, spreaders, winches, etc.

Part No.	Description
 BA1	Bolt, Brass, Side Terminal, 3/8-16

Fuse Holders & Electric Converter

DUAL FUSE HOLDERS



5601000

Part No.	Description
 5601000	Dual Fuse Holder Dual ATM Mini Fuse Holder, 10 Amp Main, 5 Amp Added
Turns one fuse slot into two. Fuse not included.	



5601005

Part No.	Description
 5601005	Dual Fuse Holder Dual ATM Type Low Profile, 10 Amp Main, 5 Amp Added
Turns one fuse slot into two. Fuse not included.	



5601107

Part No.	Description
 5601107	Dual Fuse Holder Dual ATR Type Micro, 10 Amp Main, 5 Amp Added
Turns one fuse slot into two. Fuse not included.	



5601010

Part No.	Description
 5601010	Dual Fuse Holder Dual ATO/ATC Fuse Holder, 10 Amp Main, 5 Amp Added
Turns one fuse slot into two. Fuse not included.	

ELECTRIC CONVERTER



- Convert 110C AC to 12V DC
- 5A output
- 1/4" MQD(-), 1/4" FQD(+)
- Perfect for showroom displays

Part No.	Description
3023432	Electric Adapter, Convert 110 AC to 12VDC, 5A Output, 1/4" MQD(-), 1/4" FQD(+)



JUNCTION BOXES



- Consolidates your truck's electrical wiring

Part No.	Description
 5601100	Polypropylene Electrical Junction Box with 7 Terminals, 8-3/8" L x 3-7/8" W x 2-3/8" T



Part No.	Description
 5601101	ABS Electrical Junction Box with 7 Color-Coded Terminals, 8" L x 3-1/4" W x 2-3/16" T

Color-coded terminals help you stay organized.

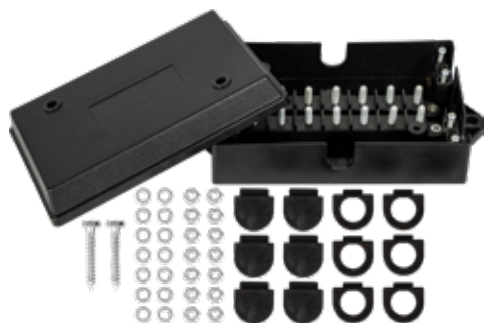

- 14 terminals help you stay organized

Part No.	Description
 5601114	Polypropylene Electrical Junction Box with 14 Terminals, 8-3/8" L x 4-1/4" W x 2-1/4" T

6-WAY FUSE BLOCK WITH COVER



- For use with ATC/ATO blade-type fuses (fuses not included)
- 25 amps max per circuit with 150 amp max per block
- Includes two tin-plated copper 10-32 studs and six tin-plated copper terminal screws
- Clear polycarbonate removable cover for easy viewing

Part No.	Description
 5601006	6-Way Fuse Block with Cover

12-WAY FUSE BLOCK WITH COVER

















- For use with ATC/ATO blade-type fuses (fuses not included)
- 25 amps max per circuit with 150 amp max per block
- Includes two tin-plated copper 10-32 studs and twelve tin-plated copper terminal screws
- Clear polycarbonate removable cover for easy viewing

Part No.	Description
 5601066	12-Way Fuse Block with Cover

Available Q2 of 2024

LIGHTING ICON DEFINITIONS

-  The light beam emitted from this light spreads out 90 degrees to either side of its centerline for a total of 180 degrees of coverage
-  Ingress protection from solids is rated at a 6 meaning that it allows no ingress of dust. Ingress protection from liquids is rated at a 5 meaning that it has protection against low pressure jets of water
-  Ingress protection from solids is rated at a 6 meaning that it allows no ingress of dust. Ingress protection from liquids is rated at a 6 meaning that it has protection against high pressure jets of water
-  Ingress protection from solids is rated at a 6 meaning that it allows no ingress of dust. Ingress protection from liquids is rated at a 7 meaning that it has protection against immersion in water between 15cm to 1m deep for 30 minutes
-  Ingress protection from solids is rated at a 6 meaning that it allows no ingress of dust. Ingress protection from liquids is rated at an 8 meaning that it has protection against immersion in water under pressure for long periods
-  Ingress protection from solids has not been formally tested. Ingress protection from liquids is rated at a 6 meaning that it has protection against high pressure jets of water
-  Ingress protection from solids has not been formally tested. Ingress protection from liquids is rated at a 7 meaning that it has protection against high pressure jets of water
-  Ingress protection from solids has not been formally tested. Ingress protection from liquids is rated at an 8 meaning that it has protection against immersion in water under pressure for long periods
-  Ingress protection from solids is rated at a 6 meaning that it allows no ingress of dust. Ingress protection from liquids is rated at a 9K meaning that it has protection against high temperature water jets
-  Meets the industry standards for warning lights to be rated SAE J595 Class 1
-  Meets the industry standards for warning lights to be rated SAE J845 Class 1
-  Meets the requirements that apply to warning lights in the state of California
-  Light(s) is programmable by STROBECONNECT
-  Light(s) is programmable by PROCONNECT



Truck Equipment & Accessories



Product Shown:

1501270: Steel Utility Body Ladder Rack
5401000: Diamond Tread Aluminum Conduit Carrier
5201005: White Steel 5 Gallon Water Cooler Mount
TCH10H: Horizontal Mount Traffic Cone Holders
5480007: 7 Foot Ladder Rack Ratchet Tie Down
CC400: 4 Inch Diameter PVC Conduit Carrier Kit

DumperDogg® Dump Insets	262 - 263
Racks and Accessories	264 - 265
Ladder Rack Tie Downs	266 - 267
Conduit Carriers	268
Kabgard Headache Racks	269

Kabgard™ Headache Racks & Service Body Accessories	270
Service Body Accessories	271
Cone Holder & Bumper Guides	272
Rubber Bumpers	273 - 274

DumperDogg® Dump Inserts



ALL DUMPERDOGG® FEATURES

- 20 ft. battery cables
- Tailgate chains with vinyl mesh covers
- Body-up indicator kit (SK10)

Specification	6 ft. Steel DumperDogg®	6 ft. Stainless Steel DumperDogg®	8 ft. Steel DumperDogg®	8 ft. Stainless Steel DumperDogg®	8 Ft Polymer DumperDogg®
Part Number	5531006	5534006	5531001	5534001	5532000
Category	553 (Y)	553 (Y)	553 (Y)	553 (Y)	553 (Y)
Bed Floor Size	48.25" x 78.5"	48.25" x 78.5"	48.25" x 102"	48.25" x 102"	36" x 89.75"
Overall Dimensions (HxWxD)	26" x 72" x 82"	26" x 72" x 82"	26" x 72" x 107"	26" x 72" x 107"	43" x 70" x 101"
Volume Capacity	1.5 cu. yd. / 2.0 cu. yd.*	1.5 cu. yd. / 2.0 cu. yd.*	2.0 cu. yd. / 2.75 cu. yd.*	2.0 cu. yd. / 2.75 cu. yd.*	3.1 cu. yd. (with sidewalls)
Max Payload Capacity**	6,000 lbs.	6,000 lbs.	6,000 lbs.	6,000 lbs.	6,000 lbs.
Weight	790 lbs.	790 lbs.	875 lbs.	875 lbs.	1,115 lbs.
Material	12 Gauge Steel	12 Gauge 304 Stainless	12 Gauge Steel	12 Gauge 304 Stainless	Double Wall Polymer with integral side extensions
Frame Construction	Black Powder Coated Structural Steel Frame				
Dump Angle	0° – 45°				
Tailgate	Double Pivoting and Removable with Four 3/4" Diameter Hinge Pins				
Lift	Scissor Hoist with 3HP Power Unit				
Hydraulics/Cylinder	4-1/2" x 8" Power Up/Power Down Cylinder				
Control Box	Tethered Control Box with 10 ft. Cord				
Lubrication	Grease Holes or Fittings at Pivot Points				
Optional Accessories					
Cab Guard	5531010	5534010	5531010	5534010	Included
Side Wall Extensions	5531020	5534020	5531020	5534020	Included
Tarp Kit	DTR5508	DTR5508	DTR5511	DTR5511	DTR4510

* With optional sidewall kit

**Weight limits not to exceed manufacturers gross vehicle weight limits.



CAB GUARDS FOR DUMPERDOGG®



5531010

Part No.	Description	Wt. (lbs.)
5531010	Steel Bolt-On Cab Guard (use with Steel Inserts)	83
5534010	Stainless Steel Bolt-On Cab Guard (use with Stainless Steel Inserts)	55

SIDE-WALL EXTENSION BRACKETS FOR DUMPERDOGG®

- Must be used with cab guard installed. 2' x 12' board not included.
- Increases volume capacity by 0.75 cu. yd. on 8 ft. dumper or by 0.5 cu. yd. on 6 ft. dumper with 2' x 10' boards



5531020



5534020



5531020 shown with 2' x 12" boards

Part No.	Description	Wt. (lbs.)
5531020	Steel Side-Wall Extension Bracket Kit. 2 Brackets/Side, Hardware Included. (use with Steel Inserts)	15
5534020	Stainless Steel Side-Wall Extension Bracket Kit. 2 Brackets/Side, Hardware Included. (use with Stainless Steel Inserts)	15

ROLL TARP KITS FOR DUMPERDOGG®



DTR511

Part No.	Description	Wt. (lbs.)
DTR5508	Roll Tarp Kit, 5.4'W x 9.5'L for 6' Steel/Stainless Steel Inserts (Must be used with Cab Guard Installed)	24
DTR5511	Roll Tarp Kit, 5.4'W x 11.5'L for 8' Steel/Stainless Steel Inserts (Must be used with Cab Guard Installed)	25
DTR4510	Roll Tarp Kit, 4.6'W x 10'L for 8' Poly Insert	23

REPLACEMENT TAILGATE SPREADER FOR DUMPERDOGG®

- Fits all DumperDogg® Dump Inserts
- Stainless steel housing construction won't rust or corrode
- 12VDC Spinner Motor 54 AMP/ 620 RPM
- 12VDC Auger Gear Motor 50 AMP/ 30 RPM/ 1042 in lbs.
- Adjustable spread pattern from 4' to 20' of rock salt, free-flowing granular materials or de-icer chemicals
- Includes in-cab, independent variable spinner speed control and auger control
- Dual-flight augers (5" O.D. x 2.4" I.D. x 20"L)
- 18" Poly spinner
- Overall dimensions 64.5" W x 25.75" H x 12.7" D
- **Quick and Easy 4-pin installation and removal**



3057918 - Variable Speed Controller



5535002

Part No.	Description	Wt. (lbs.)
5535002	Tailgate Replacement Spreader	291

Racks and Accessories

LADDER RACKS

1000 LB PICKUP TRUCK LADDER RACK

- Fits full-sized pickup trucks with 5.5 ft to 8 ft beds
- Black powder-coat with rust-inhibiting e-coat
- Integrated no-drill mounting system; built-in grab handles at rear; built-in tie points
- (4) Crossbars, (2) fixed, (1) adjustable, (1) removable
- Removable rear crossbar (no tools required)
- 1501153, 156 in. length is designed for crew cabs



1501150

Part No.	Length (in.)	Width (in.)	Height (in.)	Load Capacity (lbs.)	Mount Type	Finish	Color	Material	Wt. (lbs.)
1501150	138.00	56.00	36.00	1000	Clamp or Bolt on	E-Coat and Powder Coat	Black	Carbon Steel	144
1501153	156.00	56.00	36.00	1000	Clamp or Bolt on	E-Coat and Powder Coat	Black	Carbon Steel	160

1000 LB SERVICE BODY LADDER RACK **NEW**

- Fits both single & dual rear wheel body compartments
- Adjustable height accommodates 21 in. - 31 in. range
- (4) Crossbars: (2) fixed, (1) adjustable, (1) removable
- Removable rear crossbar (no tools required); additional adjustable cross bars optional
- Built-in grab handles at rear and built-in tie points
- 1501270, 186 in. length is designed for longer bodies and crew cabs



1501250

Part No.	Length (in.)	Width (in.)	Height Adj. Range	Load Capacity (lbs.)	Mount Type	Finish	Color	Material	Wt. (lbs.)
1501250	162.0	66.0	18.0 - 28.0	1000	Bolt On	E-Coat and Powder Coat	Black	Carbon Steel	160
1501260	174.0	66.0	18.0 - 28.0	1000	Bolt On	E-Coat and Powder Coat	Black	Carbon Steel	164
1501270	186.00	66.00	18.0 - 28.0	1000	Bolt On	E-Coat and Powder Coat	Black	Carbon Steel	170

TRUCK WINDOW SCREEN

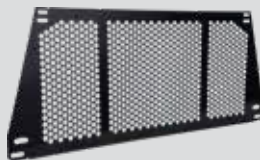

1501155

Part No.	Description	Length (in.)	Height (in.)	Finish	Color	Material	Wt. (lbs.)
1501155	For use w/ 1501150 / 1501153	70	27.0	Powder Coat	Black	Carbon Steel	20.01
1501110	For use w/ 1501250 / 1501260 / 1501270	62.0	19.0	Powder Coat	Black	Carbon Steel	15

LADDER RACK WIND DEFLECTOR KIT

- Reduces wind noise especially at highway speeds



1501193

Part No.	Description	Length (in.)	Color	Material	Wt. (lbs.)
1501193	For use w/ 1501150 / 1501153 / 1501250 / 1501260 / 1501270	40.0	Black	Carbon Steel	3.6



LADDER RACKS - continued

800 LB ALUMINUM PICKUP TRUCK LADDER RACK (WITH SIDE RAILS)

- Fits most makes & models
- Easy, drill-free installation
- Comes standard with four load stops that adjust to secure cargo
- Black powder coat optional (1501410)
- Includes zinc-plated hardware for corrosion resistance; tie-downs sold separately



1501400



1501410

Part No.	Side Rails Included	Length (in.)	Width (in.)	Height (in.)	Load Capacity (lbs.)	Mount Type	Finish	Color	Material	Wt. (lbs.)
1501400	Yes	134.0	76-3/8	35.0	800	Clamp On	Anodized	Clear	Aluminium	99
1501410	Yes	134.0	76-3/8	35.0	800	Clamp on	Powder Coat	Black	Aluminium	99

800 LB ALUMINUM PICKUP TRUCK LADDER RACK

- Fits most makes & models
- Easy, drill-free installation
- Comes standard with four load stops that adjust to secure cargo
- Black powder coat optional (1501410)
- Includes zinc-plated hardware for corrosion resistance; tie-downs sold separately



1501400



1501410

Part No.	Side Rails Included	Length (in.)	Width (in.)	Height (in.)	Load Capacity (lbs.)	Mount Type	Finish	Color	Material	Wt. (lbs.)
1501675	No	Adjustable	66.0	28.0	800	Clamp on	Plain	Clear	Aluminium	44
1501680	No	Adjustable	66.0	28.0	800	Clamp on	Powder Coat	Black	Aluminium	44.09

600 LB VAN LADDER RACK

- Mounts to rain gutter, universal fit
- 6 in. wide gutter clamps - 3/16 in. thick steel plate
- 1-1/2 in. & 1-1/4 in. square 14-gauge steel tubing
- Adjustable widths: 41 in. to 72 in.
- Includes adjustable load stop
- Ships UPS in 1 box



1501410

Part No.	Width (in.)	Load Capacity (lbs.)	Mount Type	Finish	Color	Material	Wt. (lbs.)
1501310	41.0 - 72.0	600	Clamp on Rain Gutter	E-Coat and Powder Coat	White	Carbon Steel	41.5

Accessories:

Part No.	Description	Wt. (lbs.)
1501312	Pair of Ratchet Strap Mounts with Ratcheting Tie Downs for Van Ladder Racks	5.22
1501311	Extra White Crossbar for Van Ladder Rack 1501310	23

Ladder Rack Tie Downs

1-1/2 INCH RATCHET TIE DOWNS

1-1/2 INCH RATCHET TIE DOWNS FOR ROUND TUBE LADDER RACKS

- Black powder-coated steel mount (5480007)
- 304 stainless steel mount (5480008)
- Rolled steel bracket fits ladder racks with popular 1-7/8 in. - 2 in. OD round tubing
- Fits Buyers ladder racks: 1501150, 1501153, 1501250, 1501260 and 1501270
- Includes hardware
- 2 per pack



5480007



5480008

Part No.	Length (ft)	Width (in.)	Break Strength (lbs.)	W.L.L. (lbs.)	Hook Type	Pack Quantity	Material	Wt. (lbs.)
5480007	7	1-1/2	1,500	500	Double J	2	Carbon Steel	7.83
5480008	7	1-1/2	1,500	500	Double J	2	Stainless Steel	7.785

Accessories:

Part No.	Description	Wt. (lbs.)
3028819	Replacement Strap/Prybar For 5480005, 5480006, 5480007, 5480008 Ladder Rack Ratchet Tie Downs	1.17

1-1/2 INCH RATCHET TIE DOWNS FOR SQUARE AND RECTANGULAR TUBE LADDER RACKS

- Black powder-coated steel mount for corrosion resistance (5480005)
- 304 stainless steel mount corrosion resistance (5480006)
- Add convenient, permanent securing points to a ladder rack with square or rectangular tubing
- Mounting surface 1-1/2 in. angle
- Includes hardware
- 2 per pack



5480005



5480006

Part No.	Length (ft)	Width (in.)	Break Strength (lbs.)	W.L.L. (lbs.)	Hook Type	Pack Quantity	Material	Wt. (lbs.)
5480005	7	1-1/2	1,500	500	Double J	2	Carbon Steel	8
5480006	7	1-1/2	1,500	500	Double J	2	Stainless Steel	8.19

Accessories:

Part No.	Description	Wt. (lbs.)
3028819	Replacement Strap/Prybar For 5480005, 5480006, 5480007, 5480008 Ladder Rack Ratchet Tie Downs	1.17

1-1/2 INCH RATCHET TIE DOWNS FOR PICKUP TRUCK LADDER RACKS **NEW**

- Add convenient, permanent securing points to a truck ladder rack
- Fits Buyers extruded aluminum pickup truck ladder racks 1501400, 1501410, 1501675, 1501680
- Includes hardware



1501416



1501416 installed on pickup truck ladder rack

Part No.	Mount Material	Length (ft)	Width (in.)	Break Strength (lbs.)	W.L.L. (lbs.)	Hook Type	Pack Quantity	Wt. (lbs.)
1501416	Black Powder-Coat Steel	7	1-1/2	1,500	500	Double J	1	5.63

1-1/2 INCH RATCHET TIE DOWNS FOR VAN LADDER RACKS **NEW**

- Add convenient, permanent securing points to a van ladder rack with square or rectangular tubing
- Fits Buyers 1501311 van ladder rack
- Includes hardware



1501312



1501312 installed on van ladder rack

Part No.	Mount Material	Length (ft)	Width (in.)	Break Strength (lbs.)	W.L.L. (lbs.)	Hook Type	Pack Quantity	Wt. (lbs.)
1501312	Black Powder-Coat Steel	7	1-1/2	1,500	500	Double J	1	5.22



2 INCH RATCHET TIE DOWNS

SPRING RETRACTING TIE DOWNS FOR ROUND TUBE LADDER RACKS

- Black powder-coated steel mount for corrosion resistance
- Formed c-channel steel bracket fits ladder racks with popular 1-7/8 in. - 2 in. OD round tubing
- Ratchet spring retracts for tangle-free storage when not in use
- Fits Buyers Ladder Racks: 1501150, 1501153, 1501250, 1501260 & 1501270
- Includes hardware
- 2 per pack



5480017

Part No.	Length (ft)	Width (in.)	Break Strength		Hook Type	Pack Quantity	Material	Wt. (lbs.)
			(lbs.)	W.L.L. (lbs.)				
5480017	8	2	3,000	1,000	Double J	2	Polyester	15.57

SPRING RETRACTING TIE DOWNS FOR SQUARE AND RECTANGULAR TUBE LADDER RACKS

- Black powder-coated steel mount for corrosion resistance
- Add convenient, permanent securing points to a ladder rack with square or rectangular tubing
- Ratchet spring retracts for tangle-free storage when not in use
- Includes hardware
- 2 per pack



5480015

Part No.	Length (ft)	Width (in.)	Break Strength		Hook Type	Pack Quantity	Material	Wt. (lbs.)
			(lbs.)	W.L.L. (lbs.)				
5480015	8	2	3,000	1,000	Double J	2	Polyester	14.92

1501250, 5480007 & 5480015 shown



Conduit Carriers

PVC CONDUIT CARRIER

- For use with 4 in., 6 in., or 8 in., diameter PVC (**PVC not included**)
- Kit includes: cast aluminum door & end cap, saddle brackets, zinc-plated U-bolts and hardware
- Spring loaded latching mechanism for quick, easy access
- Pre-drilled padlock tabs for added security (padlock not included)
- Designed for use with ladder racks, this kit can be built to accommodate any desired length



CC400



CC400 Application



CC400 Application

Part No.	Diameter Conduit Needed (in.)	Length (in.)	Width (in.)	Height (in.)	Wt. (lbs.)
CC400	4	Variable Length	4.96	6.00	4.27
CC600	6	Variable Length	7.07	8.00	6.85
CC800	8	Variable Length	9.07	10.00	8.25

Accessories:

Part No.	Description	Wt. (lbs.)
3016383	Cover Assembly for 4 Inch Conduit	1.9
3016367	Cap for 4 Inch Conduit	0.72
3016371	U-Bolt for 4 Inch Conduit	0.47
3016369	Saddle for 4 Inch Conduit	0.38
3016382	Cover Assembly for 6 Inch Conduit	2.6
3016366	Cap for 6 Inch Conduit	1.09
3016370	U-Bolt for 6 Inch Conduit	0.61
3016368	Saddle for 6 Inch Conduit	0.57
3025864	Cover Assembly for 8 Inch Conduit	3.9
3025858	Cap for 8 Inch Conduit	1.15
3025859	U-Bolt for 8 Inch Conduit	0.7
3025860	Saddle for 8 Inch Conduit	0.15
3006554	Hardware Kit	0.31

DIAMOND TREAD ALUMINUM CONDUIT CARRIER

- .060 in. diamond tread aluminum construction
- Provides fully enclosed storage for conduit, pipe, tubing, etc.
- Kit includes: three-piece design (for shipping & storage purposes) and mounting brackets for round or square bars
- Hinged door w/lock hasp (lock not included)



5401000



5401000 Application

Part No.	Length (in.)	Width (in.)	Height (in.)	Wt. (lbs.)
5401000	121.38	11.00	6.00	45

5401000 shown



PICKUP TRUCK KABGARD™

- Black powder-coat finish for corrosion resistance
- Mount lights and other accessories
- Secures ladders and other cargo in your pickup bed
- No-drill installation



85104

Part No.	Length (in.)	Width (in.)	Height (in.)	Color	Wt. (lbs.)
85104	69.000	2.00	23.50	Black	77.69
85204	71.60	2.00	26.30	Black	53.1

Accessories:

Part No.	Description	Length (in.)	Width (in.)	Height (in.)	Color	Wt. (lbs.)
85141	Kabgard Beacon Light Mount, Inch Drivers Side	6.5	6.5	8.1	Black	3.5
85142	Kabgard Beacon Light Mount, Passengers Side	6.5	6.5	8.1	Black	3.5
85152	Kabgard Mini Lightbar Mount	16.0	7.0	2.3	Black	5.80
85166	Kabgard Spot and Flood Light Mount	2.5	2.0	6.4	Black	1.24
85177	Kabgard Full Size Lightbar Mount	5.5	2.0	8.8	Black	4.67
3024648	Mounting Feet for Full-Size LED Light Bars	4.5	6.75	1.75	Black	3.16

KABGARD™ MOUNTING KIT FOR CROSSOVER TOOLBOXES

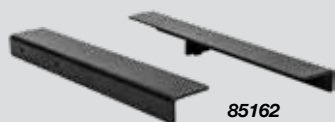

85162



85162 Application

Part No.	Description	Length (in.)	Width (in.)	Height (in.)	Color	Wt. (lbs.)
85162	KabGard Mounting Kit For Standard Crossover Toolbox	21.5	3.5	1.8	Black	11.91
85164	KabGard Mounting Kit For Extra Wide Crossover Toolbox	27	3.5	1.8	Black	32.46

KABGARD™ APPLICATION GUIDE

Part No.	Manufacturer	Body Style	Year
85104	Chevy/GMC	1500 Reg. Cab, Ext. Cab & Crew Cab	1999+
	Chevy/GMC	2500 Reg. Cab, Ext. Cab & Crew Cab	1999+
	Ford	F-150	1997+
	Ford	F-250/350 Super Duty Reg. Cab	1997-1999
	Dodge/Ram	1500 Reg. Cab	1997-2001
	Dodge/Ram	1500 Quad Cab	1997-2000
	Dodge/Ram	1500 Quad Cab, (155" wheel base only)	2001
	Dodge/Ram	2500 Reg. Cab	1997-2001
85204	Chevy/GMC	2500HD (all cab styles)	2003+
	Chevy/GMC	3500 (all cab styles)	2003+
	Ford	F-250 Super Duty Reg. Cab, Super Cab & Crew Cab	2003+
	Ford	F-350 Super Duty Reg. Cab, Super Cab & Crew Cab	2003+
	Dodge/Ram	1500 Quad Cab	2001+
	Dodge/Ram	2500 Reg. Cab	2002+
	Dodge/Ram	3500 Reg. Cab & Quad Cab	2003+
	Dodge/Ram	3500 Mega Cab	2006

Kabgard™ Headache Racks & Service Body Accessories

UNIVERSAL SERVICE BODY KABGARD™ **NEW**

- 3/16 in. 12 gauge steel construction
- 49 in. length fits single rear wheel service bodies
- 54 in. length fits dual rear wheel service bodies
- Adjustable height
- Built in tie down points



Part No.	Length (in.)	Width (in.)	Height (in.)	Color	Wt. (lbs.)
5404927	49.00	3.50	27.00	White	52.15
5404927B	49.00	3.50	27.00	Black	52.15
5405427	54.00	3.50	27.00	White	54.79
5405427B	54.00	3.50	27.00	Black	54.79



5404927



5404927B



5404927 Application

TANK HOLDER

- Wing nut & hinge design provide quick access
- Rubber gasket eliminates friction and noise
- For use with oxygen & acetylene tanks
- Zinc-plated finish for corrosion resistance



TH612714



TH9934 and TH612714
Application

Part No.	Holds Min Dia. (in.)	Holds Max Dia. (in.)	Hardware Included (y/n)	Color	Wt. (lbs.)
TH612714	6.50	7.25	No	Silver	3
TH9934	9.00	9.75	No	Silver	4

BUMPER VISE MOUNT SERIES

- Black or white powder-coat finish for corrosion resistance
- Pre-drilled for versatile height adjustment and for attaching vise
- Easily bolts to a service or utility truck bumper
- Fits Wilton® vise models AW35, 3505, 400S, AW45, 4505, C-0, C-2 and 2040
- Mounting hardware included



5201015



5201015 Application

Part No.	Length (in.)	Width (in.)	Height (in.)	Material	Color	Wt. (lbs.)
5201015	12.25	7.625	9.00	Carbon Steel	Black	12.5
5201017	12.25	7.625	9.00	Carbon Steel	White	12.5

SERVICE BODY WATER COOLER RACK

- Rack is designed to mount to flat surface and fit a standard 3 to 5 gal water cooler
- Secures coolers with sturdy nylon strap
- White powder-coated steel
- Water cooler not included



5201005



5201005 Application

Part No.	Width (in.)	Height (in.)	Depth (in.)	Capacity	Wt. (lbs.)
5201005	12.82	9.92	11.79	(1) Water Cooler	7.5



UNIVERSAL HEAVY DUTY OPEN-TOP TOOL BASKET **NEW**

- Offers open tool storage and organization
- 14-Gauge steel construction and black powder-coat finish for corrosion resistance (LT44 is 12-gauge)
- All hardware included.
- Ships unassembled
- For full specs and details see page 59



Part No.	Length (in.)	Width (in.)	Height (in.)	Wt. (lbs.)
LT44	53.75	18.00	10.00	74.36
1744124	24.00	18.00	10.00	37.00
1744136	36.00	18.00	10.00	46.00

RUBBER CLAMPS

- Bolt-on
- Sold in pairs
- Adjustable strap accommodates wide range of tools and equipment



RC8M



RC10L



RC10S



RC11S

Part No.	Mounting Base Length (in.)	Mounting Base Width (in.)	Hardware Included (y/n)	Pkg Quantity	Color	Wt. (lbs.)
RC8M	1.75	1.50	No	2	Black	0.14
RC10L	6.00	0.88	No	2	Black	0.6
RC10S	2.50	0.75	No	2	Black	0.3
RC11S	2.58	1.00	No	2	Black	0.35

TRAFFIC CONE HOLDER

- Pre-drilled mounting plate for easy installation
- Black powder-coat finish for corrosion resistance
- Holds (10) 18 in. or (5) 28 in. sized cones



TCH10H



TCH10V



TCH12V

Part No.	Mounting Bracket	Height (in.)	Material	Finish	Color	Wt. (lbs.)
TCH10H	Horizontal	22.00	Carbon Steel	Powder Coat	Black	2.25
TCH10V	Vertical	18.00	Carbon Steel	Powder Coat	Black	2.5
TCH12V	Vertical	12.00	Carbon Steel	Powder Coat	Black	8.41

Cone Holder & Bumper Guides

SWING-AWAY BUMPER MOUNT CONE HOLDER **NEW**

- Low profile, front bumper-mounted design clears truck's with front tilting hoods
- Swing-away design facilitates easy loading of traffic cones
- Holds (15) 18 in. - (12) 28 in. traffic cones
- Built-in retention pin keeps traffic cones secure during transport
- Mounting hardware included



TCH14V



TCH14V Application

Part No.	Length (in.)	Material	Finish	Color	Wt. (lbs.)
TCH14V	72.00	Carbon Steel	Powder Coat	Black	46.16

BUMPER GUIDES

- Bright and easy to see, with more surface area than conventional sight guides
- Fast bolt mount installation on your vehicle
- Choose the height to match your application
- Horizontal adapter kit available
- Durable nylon construction

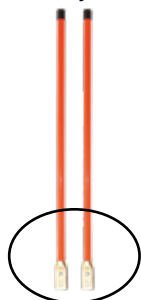

1308105

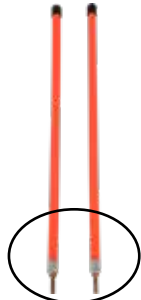

1308103

Part No.	Mount Type	Width (in.)	Height (in.)	Material	Color	Wt. (lbs.)
1308105	Bolt-On	.750	28.00	Nylon	Fluorescent Orange	0.8
1308107	Bolt-On	.750	28.00	Nylon	Fluorescent Orange	0.68
1308110	Bolt-On	.750	36.00	Nylon	Fluorescent Orange	1
1308115	Bolt-On	.750	48.00	Nylon	Fluorescent Orange	1.06
1308103	Stud	.750	24.00	Nylon	Fluorescent Orange	0.72
1308106	Stud	.750	28.00	Nylon	Fluorescent Orange	0.68
1308111	Stud	.750	36.00	Nylon	Fluorescent Orange	0.98

OVERSIZED BUMPER GUIDES

- Flexible base lets you custom-position the sight rods



1308150

Part No.	Width (in.)	Height (in.)	Material	Finish	Color	Wt. (lbs.)
1308150	1.313	24.00	Polymer	Smooth	Yellow	1.5

ILLUMINATED LED GUIDES

- Light-up design makes it easier to see your equipment in low visibility conditions.
- Most plow applications require the Horizontal Adapter Kit (1308126--sold separately) in order to mount on the outside plow rib
- Includes wiring harness that is 12 ft per side with a pre-terminated male bullet connector and ring terminal to connect to the LED guides



1308124



1308136 Application

Part No.	Width (in.)	Height (in.)	Material	Color	Wt. (lbs.)
1308124	.750	24.00	Nylon	Fluorescent Orange	2.3
1308128	.750	28.00	Nylon	Fluorescent Orange	2.37
1308136	.750	36.00	Nylon	Fluorescent Orange	2.51

Accessories:

Part No.	Description	Wt. (lbs.)
5621002	Strobe Controller for LED Strip Lights	0.07
1308126	Horizontal Mount Adapter Kit for Illuminated LED Guides	0.58



RUBBER BUMPERS

- Heavy duty rubber reinforced with nylon and rayon cording
- Compression molded for strength and durability
- Ideal for OEM applications where close tolerance and precision molding are required
- Sold in pairs (unless otherwise noted)



B4000



B4500



B5264



B5500



B5540



B5760



B6000L



B5800 (pair) B5801 (single)

Part No.	Sold in Pairs (y/n)	Width (in.)	Height (in.)	Depth (in.)	Mounting Holes Ctr to Ctr (in.)	Hole Dia.	Number of Mounting holes	Wt. (lbs.)
B4000	Yes	6.00	8.00	3.00	3-1/4 Vertical x 5-1/2 Horizontal	.50	4	8.26
B4500	Yes	5-1/2	7-5/8	3-3/4	3.00 Vertical x 5-1/2 Horizontal	.58	4	10.5
B5264	Yes	2-1/2	6-3/4	4-1/8	3-3/4	.54	2	6.5
B5500	yes	3.00	6.00	3-1/2	3.00	.54	2	5.4
• B5540	Yes	2-1/2	6.00	3.00	3-1/2	.66	2	3.3
B5760	Yes	2-1/4	7-3/4	2.00	4-1/2	.44	2	2.4
B6000L	Yes	3-1/2	6.00	3-1/2	3.00	.56	2	6
B5800	Yes	3.00	6.00	3-1/2	3.00	.54	2	4.29
B5801	No	3.00	6.00	3-1/2	3.00	.54	2	2.15

ROUND RUBBER BUMPER

- Acts as a cushion between ground and loading ramp or lift gate



B1001

Part No.	Sold in Pairs (y/n)	Width (in.)	Height (in.)	Hole Dia.	Number of Mounting holes	Wt. (lbs.)
B1001	No	2-1/2	1.00	4/10	1	0.21

Rubber Bumpers

EXTRUDED RUBBER RECTANGULAR BUMPER

- Heavy duty extruded rubber
- Includes steel mounting plate



441466

Part No.	Sold in Pairs (y/n)	Width (in.)	Height (in.)	Depth (in.)	Mounting Holes Ctr to Ctr (in.)	Hole Dia.	Number of Mounting holes	Wt. (lbs.)
441466	No	10.00	4-3/4	2-3/4	5.00	7/10	2	5.45

LAMINATED RUBBER BUMPERS

- Bumpers have 21 belted rubber sections encased in 2 in. structural steel angles with welded tie rods for maximum strength
- Ideal for severe duty and refuse applications
- Weld-on design for long lasting impact resistance
- Compares to Heil® H-014-1714



B9000

Part No.	Sold in Pairs (y/n)	Width (in.)	Height (in.)	Depth (in.)	Number of Mounting holes	Wt. (lbs.)
B9000	Yes	5.00	2-1/2	10.00	0	17.5

EXTRUDED RUBBER D-SHAPED BUMPER

- Extruded D-shape bumper is designed for high impact resistance
- Available in a variety of sizes, thicknesses, and drill-hole configurations
- Compression molded rubber construction won't rust or dent



D26U

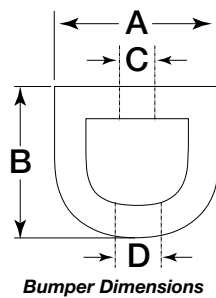

Part No.	A	B	C	D	No. of Holes	C-C of Holes	Length	Wt. (lbs.)
D210	2-1/8	1-7/8	3/8	7/10	2	6.00	10.00	0.98
D2120	2-1/8	1-7/8	0	0	0	N/A	120	13
D232	2-1/8	1-7/8	3/8	7/10	3	14.00	32.00	3.42
D26U	2-1/8	1-7/8	3/8	7/10	2	3.00	6.00	0.6
D312	3.00	2-7/8	7/10	1-1/8	2	8-1/8	12.00	3.3
D324	3.00	2-7/8	7/10	1-1/8	4	6-1/2	24.00	5.42
D412	4.00	3-3/4	7/8	1-1/8	2	7-7/8	12.00	3.09
D424	4.00	3-3/4	7/8	1-1/8	3	10.00	24.00	8.11
D46	4.00	3-3/4	7/8	1-1/8	2	3-1/8	6.00	1.25



Fenders, Mudflaps, & Wheel Chocks



Product Shown:
B36SPP: Solid Black Rubber Mudflaps
B5055: 1" Forged 55° Angled D-Ring
8590245: Ribbed Poly Fenders
5626738: 5-3/4" Red Stop/Turn/Tail Light

Fenders and Accessories
Mudflaps

276 - 277
278 - 283

Outrigger Pads
Wheel Chocks

284
285 - 288

Fenders and Accessories

POLY FENDERS

- Integrated molded ribs add strength and reduce spray
- Injection molded poly construction
- Durable, forgiving, and lightweight poly construction
- Sold individually

FULL RADIUS POLY FENDERS



8590017



8590196 Application

Part No.	Length (in.)	Width (in.)	Height (in.)	Wheel Dia. (in.)	Mount Type	Wt. (lbs.)
8590017	37.3	19.40	14.9	16.0	Bolt-On	6.31
8590196	38.5	20.0	17.0	17.0 - 19.5	Bolt-On	10.02

SMOOTH POLY FENDERS

- Added length to fit larger tires



8590195

Part No.	Length (in.)	Width (in.)	Height (in.)	Depth (in.)	Wheel Dia. (in.)	Mount Type	Wt. (lbs.)
8590195	46.70	22.40	20.60	22.50	19.5	Bolt-On	8.29

RIBBED POLY FENDERS



8590245



8590245 Application

Part No.	Length (in.)	Width (in.)	Height (in.)	Wheel Dia. (in.)	Mount Type	Wt. (lbs.)
8590245	50.50	26.50	23.80	22.5/24.5	Bolt-On	9.84

FENDER EXTENSIONS



B52150

- Extends fender by 2-1/2 in.
- Supplied in 50 ft coils

Part No.	Width (in.)	Wheel Dia. (in.)	Material	Finish	Mount Type	Wt. (lbs.)
B52150	2.50	Any	Rubber	Smooth	Bolt-On	30



B52169

- Extends fender by 2 in.
- Supplied in 50 ft coils

Part No.	Width (in.)	Wheel Dia. (in.)	Material	Finish	Mount Type	Wt. (lbs.)
B52169	2.215	Any	Rubber	Smooth	Bolt-On	28



POLY FENDERS - continued

UNIVERSAL POLY FENDER MOUNTING KIT



8591000



8591001 Application

Part No.	Width (in.)	Wheel Dia. (in.)	Material	Finish	Mount Type	Wt. (lbs.)
8591000	30.50	Any	Carbon Steel	Powder Coat	Bolt-On	24
8591001	30.50	Any	Stainless Steel	Plain	Bolt-On	23

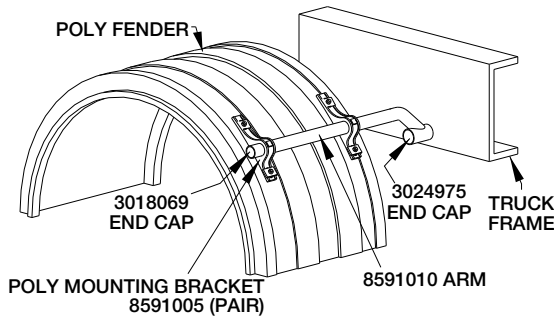

8591010



8591005

Accessories:

Part No.	Description	Wt. (lbs.)
8591010	Fender Mounting Arm for 8591095 and 8590245	8.05
8591005	Fender Bracket Pair for 8591000, 8591001, 8591010, and 8591020	2.40
3018069	Black Plastic End Cap for 8591000, 8591001, 8591010, and 8591020	0.01
3024975	Black Plastic End Cap for 8591000, 8591001, 8591010, and 8591020	0.02
3035509	Black Plastic End Cap for 8591000, 8591001, 8591010, and 8591020	0.02

STRAIGHT FENDER MOUNTING KIT

- Flush end-mount design
- Black powder-coat or stainless steel finish for corrosion resistance
- 30.25 in. long x 1.88 in. diameter x .125 in. wall straight tubing
- Kit includes: (2) straight mounting tubes, (2) plastic end-caps & fasteners
- 2 pair of 8591005 required per fender (sold separately)



8591020

Part No.	Length (in.)	Width (in.)	Wheel Dia. (in.)	Material	Finish	Mount Type	Wt. (lbs.)
8591020	30.25	1.88	Any	Carbon Steel	Powder Coat	Bolt-On	14.5

QUARTER POLY FENDER FOR DUAL REAR WHEELS **NEW**

- Includes steel tubing mount, clamp, 5.5 in. top poly flap extension, and hardware
- Includes two complete fenders
- 8592425 frame mounting post (sold separately)



8592424



8592424 Application



8592425

Part No.	Length (in.)	Width (in.)	Mount Type	Wt. (lbs.)
8592424	24.00	24.00	Bolt on	21

Accessories:

Part No.	Description	Wt. (lbs.)
8592425	Tube Mount, set of 2	3.72
8592426	Fender Tube with Clamp and Bolts, set of 2	6.18
8592427	Single Poly Quarter Fender	10.3
8592428	Poly Fender Flap Extension, set of 2	0.8

Mudflaps

POLY MUDFLAPS

STANDARD/CUSTOM FLAPS

- 3/16 in. super durable polymer mudflaps
- Withstands subfreezing temps
- Resists buildup of ice & snow
- Repels impact from road debris
- Stocked in white, black, red, blue, and yellow. Gloss pigment foils are stocked & available for custom imprinting
- Custom sizes and colors quoted on request



Part No.	Width (in.)	Height (in.)	Thickness (in.)	Color	Mount Type	Material	Wt. (lbs.)
RC18PPB	24.00	18.00	.15	Black	Bolt-On	Polymer	4.9
RC18PPW	24.00	18.00	.15	White	Bolt-On	Polymer	4.9
RC24PPB	24.00	24.00	.15	Black	Bolt-On	Polymer	6.54
RC24PPW	24.00	24.00	.15	White	Bolt-On	Polymer	6.54
B24PPY	24.00	24.00	.17	Yellow	Bolt-On	Polymer	7
B30PPY	24.00	30.00	.19	Yellow	Bolt-On	Polymer	8.31
RC30PPB	24.00	30.00	.15	Black	Bolt-On	Polymer	8.2
RC30PPBLU	24.00	30.00	.15	Blue	Bolt-On	Polymer	8.2
RC30PPR	24.00	30.00	.15	Red	Bolt-On	Polymer	8.2
RC30PPW	24.00	30.00	.15	White	Bolt-On	Polymer	8.2
B36PPY	24.00	30.00	.17	Yellow	Bolt-On	Polymer	10
RC36PPB	24.00	36.00	.15	Black	Bolt-On	Polymer	10
RC36PPW	24.00	36.00	.19	White	Bolt-On	Polymer	10
RC40PPB	24.00	40.00	.15	Black	Bolt-On	Polymer	12
RC40PPW	24.00	40.00	.15	White	Bolt-On	Polymer	12

SPRAY-REDUCING GROOVED

- 5/16 in. thick polymer mudflaps
- Heavy duty, no sail design
- Unique design minimizes spray
- Withstands subfreezing temps
- Gloss pigment foils are stocked & available for custom imprinting
- Stocked in white & black - Custom sizes and colors quoted on request



B30PSRPB

Part No.	Width (in.)	Height (in.)	Thickness (in.)	Color	Mount Type	Material	Wt. (lbs.)
B24PSRPB	24.00	24.00	.31	Black	Bolt-On	Polymer	11
B24PSRPW	24.00	24.00	.31	White	Bolt-On	Polymer	11
B30PSRPB	24.00	30.00	.31	Black	Bolt-On	Polymer	14
B30PSRPW	24.00	30.00	.31	White	Bolt-On	Polymer	14
B36PSRPB	24.00	36.00	.31	Black	Bolt-On	Polymer	14.69
B36PSRPW	24.00	36.00	.31	White	Bolt-On	Polymer	17

CUSTOM PRINT MUDFLAPS

- Custom prints are available with any of our polymer or composite flaps
- Gloss pigment foils are stocked & available for custom imprinting
- As large as 20 in. x 20 in. area available for custom imprinting
- Custom sizes and colors quoted on request
- Minimum order of 50 pairs with tooling.

Gloss pigment foils are stocked and available for custom imprinting



Call Customer Service at 440-974-8888 for a quote, minimum order quantity of 50 required



"CAUTION WIDE TURNS" POLYMER MUD FLAPS

- 3/16 in. super durable polymer mudflaps
- Withstands impact & stress while maintaining appearance & anti-sail properties
- Withstands subfreezing temps
- Resists buildup of ice & snow
- Repels impact from road debris
- Bright yellow & "Caution Wide Turns" increase safety



B2424YC

Part No.	Width (in.)	Height (in.)	Thickness (in.)	Color	Mount Type	Material	Wt. (lbs.)
B2424YC	24.00	24.00	.17	Yellow	Bolt-On	Polymer	7
B2430YC	24.00	30.00	.17	Yellow	Bolt-On	Polymer	8.31
B2436YC	24.00	36.00	.17	Yellow	Bolt-On	Polymer	10

THERMOFLEX FENDER GUARD MUD FLAPS

- 1/8 in. thick poly mudflaps
- Add style to your truck or trailer
- Repels impact from road debris
- Withstands subfreezing temps.
- Resists buildup of ice & snow
- 40+ gloss pigment foils are stocked & available for custom imprinting



B1018PPB

Part No.	Width (in.)	Height (in.)	Thickness (in.)	Color	Mount Type	Material	Wt. (lbs.)
B1018PPB	10.00	18.00	.13	Black	Bolt-On	Polymer	1.3
B1020PPB	10.00	20.00	.13	Black	Bolt-On	Polymer	1.41
B117518PPB	11.75	17.75	.13	Black	Bolt-On	Polymer	1.55
B1237PPB	12.00	37.00	.13	Black	Bolt-On	Polymer	2.8
B1237PPW	12.00	37.00	.13	White	Bolt-On	Polymer	2.5
B915PPB	9.00	15.00	.13	Black	Bolt-On	Polymer	1.12

COMPOSITE MUD FLAPS

- Available with 1/4 in. or 3/8 in. grooves on back
- Heavy duty, no sail design
- Withstands subfreezing temps
- Custom sizes quoted on request
- 40+ gloss pigment foils are stocked & available for custom imprinting
- As large as 20 in. x 20 in. area available for custom imprinting



BSGD2430

Part No.	Width (in.)	Height (in.)	Thickness (in.)	Color	Mount Type	Material	Wt. (lbs.)
BSGD2424	24.00	24.00	.38	Black	Bolt-On	Composite	11
BSGD2030	20.00	30.00	.38	Black	Bolt-On	Composite	11.2
BSGD2430	24.00	30.00	.38	Black	Bolt-On	Composite	13.8
BSGD2436	24.00	36.00	.38	Black	Bolt-On	Composite	16.6
BSGS2018	20.00	18.00	.25	Black	Bolt-On	Composite	5.34
BSGS2424	24.00	24.00	.25	Black	Bolt-On	Composite	8.85
BSGS2430	24.00	30.00	.25	Black	Bolt-On	Composite	12.2
BSGS2436	24.00	36.00	.25	Black	Bolt-On	Composite	14

Mudflaps

RUBBER MUDFLAPS

HEAVY DUTY

- 1/4 in. thick rubber mudflaps
- Resists impact, cutting & tearing
- Resists buildup of ice & snow
- Repels impact from road debris



B30LP



B1018LSP

Part No.	Width (in.)	Height (in.)	Thickness (in.)	Color	Mount Type	Material	Wt. (lbs.)
B1018LSP*	10.00	18.00	.25	Black	Bolt-On	Rubber	3.25
B1218LSP	12.00	18.00	.25	Black	Bolt-On	Rubber	4.5
B1412LSP	14.00	12.00	.25	Black	Bolt-On	Rubber	3.5
B1812LSP	18.00	12.00	.25	Black	Bolt-On	Rubber	4
B1820LSP	18.00	20.00	.25	Black	Bolt-On	Rubber	7.63
B2014LSP	20.00	14.00	.25	Black	Bolt-On	Rubber	6
B2018LSP	20.00	18.00	.25	Black	Bolt-On	Rubber	7
B2020LSP	20.00	20.00	.25	Black	Bolt-On	Rubber	8
B2024LSP	20.00	24.00	.25	Black	Bolt-On	Rubber	9
B2030LSP	20.00	30.00	.25	Black	Bolt-On	Rubber	13.38
B2412LSP	24.00	12.00	.25	Black	Bolt-On	Rubber	5.02
B2414LSP	24.00	14.00	.25	Black	Bolt-On	Rubber	7
B2418LSP	24.00	18.00	.25	Black	Bolt-On	Rubber	8
B2420LSP	24.00	20.00	.25	Black	Bolt-On	Rubber	9
B24LP	24.00	24.00	.25	Black	Bolt-On	Rubber	11
B30LP	24.00	30.00	.25	Black	Bolt-On	Rubber	14.63
B36LP	24.00	36.00	.25	Black	Bolt-On	Rubber	16.5
B40LP	24.00	40.00	.25	Black	Bolt-On	Rubber	18

* Teardrop style



BoomerangRubber.com

RAISED OR FLAT CUSTOM LOGO MUD FLAPS

- Durable, flexible and made with 100% recycled, cord-reinforced rubber
- All raised or flat logos are silk screened using a specially formulated ink designed to apply and bond to rubber. Our logos provide excellent durability, resistance to discoloration/oil migration, vivid colors, and adhesion.
- Basic colors offered are white, yellow, red, orange, green, blue
- Premium colors are available – tangerine, sky blue, silver, navy blue, gold, gray, burgundy
- Minimum order of 50 pieces with tooling.



Custom Economical Flat



Custom Premium Raised

Call Boomerang Rubber at 937-693-4611 for a quote, minimum order quantity of 50 required



HEAVY ANTI-SPRAY

- 1/2 in. thick rubber mudflaps
- Repels spray with special 1/4 in. broad based knobs
- Resists impact, cutting & tearing
- Resists buildup of ice & snow
- Repels impact from road debris



B30SRP

Part No.	Width (in.)	Height (in.)	Thickness (in.)	Color	Mount Type	Material	Wt. (lbs.)
B24SRP	24.00	24.00	.50	Black	Bolt-On	Rubber	12
B30SRP	24.00	30.00	.50	Black	Bolt-On	Rubber	22
B36SRP	24.00	36.00	.50	Black	Bolt-On	Rubber	24.38

SOLID RUBBER

- 1/2 in. thick rubber mudflap
- Solid back
- For use in off-road conditions
- Resists impact, cutting & tearing
- Resists buildup of ice & snow
- Repels impact from road debris



B36SPP

Part No.	Width (in.)	Height (in.)	Thickness (in.)	Color	Mount Type	Material	Wt. (lbs.)
B24SPP	24.00	24.00	.50	Black	Bolt-On	Rubber	21
B30SPP	24.00	30.00	.50	Black	Bolt-On	Rubber	27
B36SPP	24.00	36.00	.50	Black	Bolt-On	Rubber	33

SUPER HEAVY DUTY

- 3/8 in. thick rubber mudflaps
- Resists impact, cutting & tearing
- Resists buildup of ice & snow
- Repels impact from road debris



B24LXP

Part No.	Width (in.)	Height (in.)	Thickness (in.)	Color	Mount Type	Material	Wt. (lbs.)
B24LXP	24.00	24.00	.38	Black	Bolt-On	Rubber	16
B30LXP	24.00	30.00	.38	Black	Bolt-On	Rubber	18
B36LXP	24.00	36.00	.38	Black	Bolt-On	Rubber	24
B40LXP	24.00	40.00	.38	Black	Bolt-On	Rubber	28

Mudflaps

MUDFLAP HARDWARE

MUD FLAP CLAMPS **NEW**

- Works with 1/4 in. - 1/2 in. plastic and rubber mud flaps
- Secures mud flaps to the truck and protects them from tire contact tearing
- Ideal for paving operations when flaps need removed for paver
- A long handle, flat head screwdriver is enough to install or release them
- 4 per kit



8591100



8591100 Application

Part No.	Length (in.)	Width (in.)	Height (in.)	Thickness (in.)	Material	Color	Wt. (lbs.)
8591100	9.50	1.00	3.00	3.00	304 Stainless Steel	Natural	5.76

TRIPLE ROUND LIGHT BOXES WITH MUDFLAP MOUNT **NEW**



LB6303SST

Part No.	Description	Wt. (lbs.)
LB6303SST	Triple Round, Stainless Steel Kit, (6" x 30" x 3") Both Driver and Passenger Side	30.50
LB6304SST	Triple Round, Stainless Steel, (6" x 30" x 3") Driver Side	15.25
LB6305SST	Triple Round, Stainless Steel, (6" x 30" x 3") Passenger Side	15.25

Combination lightbox-mudflap mounts. Accommodates (3) 4" round recessed or surface mount lights per box. Spring loaded for impact protection.

MUD FLAP BOLTING PLATE

- Reinforces the critical bolt hole area of all 24 in. wide rubber or plastic splash guards
- Black powder-coat finish for corrosion resistance
- Sold in pairs
- 25 pairs per master carton



MFW2375

Part No.	Description	Wt. (lbs.)
MFW2375	Black Powder Coated Steel	2.6

MUD FLAP MOUNTING PLATE



MFHB2375F

Part No.	Description	Wt. (lbs.)
MFHB2375F	Straight Mounting Plate	6.5
MFHB2375A	90 Degree Mounting Plate	6.5

ANTI-SAIL BRACKETS FOR MUD FLAPS

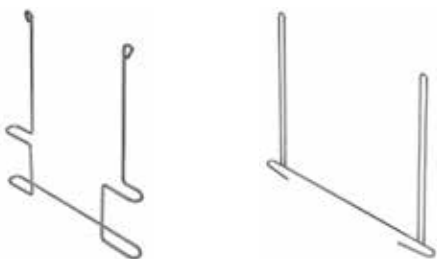

400BZ

B2436ASBC

Part No.	Description	Width (in.)	Height (in.)	Wt. (lbs.)
400BZ	Galvanized, Sized for Exhaust Tip Clearance	21-3/8	20-3/4	4.09
405BC	Chrome Plated	26-1/8	21.00	4.45
405BZ	Galvanized	26-1/8	21.00	4.45
405SS	Stainless Steel, Sized For Exhaust Tip Clearance	21-3/8	20-3/4	4.1
B2418ASBC	Chrome Plated (5 pairs per case)	24-1/2	9.00	5.2
B2436ASBC	Chrome Plated (5 pairs per case)	24-1/2	20-3/4	5.7



HITCH-MOUNTED TRAILER STONE GUARDS **NEW**

- Clamps over 2 in., 2-1/2 in., and 3 in. receivers, also mounts to ball hitch shanks
- Black powder-coat steel construction with durable 3/8 in. thick composite mud flaps
- Cutouts for safety chain access
- Available with 15 in. flaps or 20 in. flaps
- Protects RVs and trailers from road debris



8597215



8597215 Application

Part No.	Width (in.)	Height (in.)	Thickness (in.)	Color	Mount Type	Material	Wt. (lbs.)
8597215	72.00	15.00	1.9	Black	Clamp-On	Carbon Steel	44
8597220	72.00	20.00	1.9	Black	Clamp-On	Carbon Steel	50

STEEL & ALUMINUM SPLASH GUARDS

KITS

- Includes: (2) splash shields, (2) mounting tubes, (2) end cap plugs
- 2 in. steel tube welds to hoist sub-frame in front of the rear wheels on dump bodies
- Requires no additional bracing
- Predrilled holes for easy installation (fasteners not included)
- Guards bolt on to mounting tubes



SG2228

SG2229

Part No.	Width (in.)	Height (in.)	Thickness (in.)	Color	Mount Type	Material	Wt. (lbs.)
SG2228	22.00	28.00	.096	Black	Weld-On/ Bolt-On	Carbon Steel	51
SG2229	22.00	28.00	.10	Natural	Weld-On/ Bolt-On	Aluminum	28

ALUMINUM GUARDS ONLY

- Protects lower front panel of utility bodies & underbody toolboxes from stone chips & road debris
- Six predrilled 3/16 in. mounting holes
- Includes: (12) rivets
- Sold in quantities of (10)



STG1210

Part No.	Width (in.)	Height (in.)	Thickness (in.)	Color	Mount Type	Material	Wt. (lbs.)
STG1210	10.00	12.00	.100	Natural	Bolt-On	Aluminum	1.4

Outrigger Pads

POLY OUTRIGGERS

HIGH DENSITY POLY OUTRIGGER PADS

- Durable, HDPE high density polyethylene construction
- 1/2 the weight of rubber
- Ideal for concrete, paved surfaces, and off road use
- Rope style handle



OP24X24P



OP18X18P Application

Part No.	Length (in.)	Width (in.)	Thickness (in.)	Material	Finish	Color	Wt. (lbs.)
OP18X18P	18.00	18.00	1.00	Polyethylene	Textured	Black	11.68
OP24X24P	24.00	24.00	1.00	Polyethylene	Textured	Black	20.75
OP242415	24.00	24.00	1.50	Polyethylene	Textured	Black	30

ULTRA HIGH MOLECULAR WEIGHT POLY OUTRIGGER PAD - 1 INCH

- Ultra durable UHMW polyethylene
- 1/2 the weight of rubber
- Rope style handle
- Ideal for concrete, paved surfaces, and off road use



OP242410



OP242410 Application

Part No.	Length (in.)	Width (in.)	Thickness (in.)	Material	Finish	Color	Wt. (lbs.)
OP242410	24.00	24.00	1.00	UHMW Polyethylene	Textured	Black	19

HARDWOOD OUTRIGGER PAD

- Constructed of natural hardwood in a "floating design" to avoid cracking
- Heavy duty U-bolt style handle runs the complete length of the pad for added strength
- Handle sized for gloved hands
- Ideal for concrete, paved surfaces, and off road use



OP18X18



OP18X18 Application

Part No.	Length (in.)	Width (in.)	Thickness (in.)	Material	Finish	Color	Wt. (lbs.)
OP18X18	18.00	18.00	2.00	Wood	Plain	Brown	16

RUBBER OUTRIGGER PAD

- Constructed of 2 in. solid rubber
- Textured surface
- Built-in handle
- Ideal for concrete, paved surfaces, and off road use



OP18X18R

Part No.	Length (in.)	Width (in.)	Thickness (in.)	Material	Finish	Color	Wt. (lbs.)
OP18X18R	18.00	18.00	2.00	Rubber	Textured	Black	30.01
OP24X24R	24.00	24.00	2.00	Rubber	Textured	Black	52.8



RUBBER WHEEL CHOCKS

- Reinforced rubber construction
- Keeps vehicles and trailers in place
- Resists oil, rust, salt, and sunlight

HEAVY DUTY RUBBER WHEEL CHOCK

- Includes chain eye or U-Handle



Part No.	Description	Color	Width (in.)	Height (in.)	Thickness (in.)	Wt. (lbs.)
WC1086	Heavy Duty Rubber Wheel Chock With Chain Eye	Black	10.00	6.00	8.00	9.3
WC6810L	Heavy Duty Rubber Wheel Chock With Recessed Chain Eye	Black	10.00	6.00	8.00	7.46
WC6810LP	Orange Heavy Duty Rubber Wheel Chock With Recessed Chain Eye	Orange	10.00	6.00	8.00	7.46
WC1087	Heavy Duty Rubber Wheel Chock With Bolt-On Orange Handle Kit	Black	10.00	6.00	8.00	16.57
WC1088	Bolt-On Orange Handle Kit Only With Hardware	Orange	–	–	–s	1.50
WC1086UWH	Heavy Duty Rubber Wheel Chock With U-Handle	Black	10.00	6.00	8.00	9.1



WC1087 shown

Wheel Chocks

RUBBER WHEEL CHOCKS - continued

- Reinforced rubber construction
- Keeps vehicles and trailers in place
- Resists oil, rust, salt, and sunlight

RUBBER WHEEL CHOCK WITH HANDLE

- Includes zinc-plated handle for corrosion resistance
- Durable and chemical-proof design



WC1085H

Part No.	Width (in.)	Height (in.)	Thickness (in.)	Material	Finish	Color	Wt. (lbs.)
WC1085H	10.00	5.00	8.00	Rubber	Plain	Black	8.2

HEAVY DUTY RUBBER WHEEL CHOCK WITH MOLDED HANDHOLD

- Molded-in chain eye
- Molded-in handhold



WC2556A



WC2556A Back

Part No.	Width (in.)	Height (in.)	Thickness (in.)	Material	Finish	Color	Wt. (lbs.)
WC2556A	10.00	8.00	7.00	Rubber	Plain	Black	9.95

LAMINATED RUBBER WHEEL CHOCK

- Features durable, recycled tire rubber pressed between two 1/4 in. steel plates
- Includes retaining chain bracket



WC0888

Part No.	Width (in.)	Height (in.)	Thickness (in.)	Material	Finish	Color	Wt. (lbs.)
WC0888	8.75	8.00	8.00	Multiple	Powder Coat	Black	16.57

RUBBER WHEEL CHOCK



WC1467A

Part No.	Width (in.)	Height (in.)	Thickness (in.)	Material	Finish	Color	Wt. (lbs.)
WC1467A	5.00	5.00	6.00	Rubber	Plain	Black	2.78
WC1468A	8.00	5.00	6.00	Rubber	Plain	Black	4.4
WC796R	9.50	7.00	7.00	Rubber	Plain	Black	9.69



RUBBER WHEEL CHOCKS - continued

- Reinforced rubber construction
- Keeps vehicles and trailers in place
- Resists oil, rust, salt, and sunlight

RUBBER WHEEL CHOCK SET

- Bright yellow reflective tape adds visibility
- Attached 36 in. nylon rope included



WC24483

Part No.	Width (in.)	Height (in.)	Thickness (in.)	Material	Finish	Color	Wt. (lbs.)
WC24483	8.00	4.00	4.00	Rubber	Plain	Black	7.5

MINI RUBBER WHEEL CHOCK SET

- For ATVs, lawn mowers and similar sized vehicles
- Not for automotive or truck use
- Attached 36 in. nylon rope included

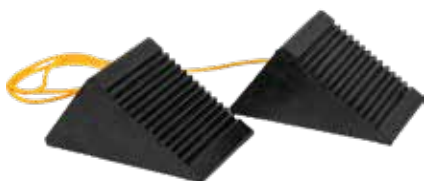

WC35225

Part No.	Width (in.)	Height (in.)	Thickness (in.)	Material	Finish	Color	Wt. (lbs.)
WC35225	2.25	3.00	5.00	Rubber	Plain	Black	1.67

POLY & COMPOSITE WHEEL CHOCKS

COMPOSITE WHEEL CHOCK SET

- 100% recycled composite construction
- Safety yellow for high visibility
- Resistant to oils and chemicals
- Attached 32-3/4 in. nylon rope included
- Boxed in sets of two chocks



WC9642Y

Part No.	Width (in.)	Height (in.)	Thickness (in.)	Material	Finish	Color	Wt. (lbs.)
WC9642Y	9.50	4.00	6.00	Composite	Plain	Yellow	10.5

ORANGE POLYURETHANE WHEEL CHOCK

- Semi-rigid polyurethane construction
- Half the weight of rubber
- Built-in carrying hand grip
- Includes mounting holes for rope, eye bolts, etc.
- Two wheel chocks per box



WC8118

Part No.	Width (in.)	Height (in.)	Thickness (in.)	Material	Finish	Color	Wt. (lbs.)
WC8118	8.69	8.13	11.25	Polyurethane	Plain	Orange	4.37

Wheel Chocks

ALUMINUM WHEEL CHOCKS

CAST ALUMINUM WHEEL CHOCK

- Built-in carrying handle slot
- Anti-skid base
- Lightweight



WC1267



WC1588 Application

Part No.	Width (in.)	Height (in.)	Thickness (in.)	Material	Finish	Color	Wt. (lbs.)
WC1267	6.25	7.00	12.25	Aluminum	Plain	Silver	3.25
WC1588	8.50	8.25	15.00	Aluminum	Plain	Silver	7.25

EXTRUDED ALUMINUM WHEEL CHOCK

- Anti-skid base
- Great for off-road, ice and snow conditions
- Built-in carrying handle slot

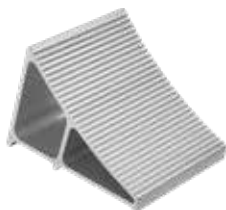

WC6096A



WC7118A Application

Part No.	Width (in.)	Height (in.)	Thickness (in.)	Material	Finish	Color	Wt. (lbs.)
WC6096A	6.00	5.86	8.75	Aluminum	Plain	Silver	3.54
WC7118A	7.00	7.80	10.75	Aluminum	Plain	Silver	7.3

GALVANIZED SERRATED WHEEL CHOCK

- Great for off-road ice and snow conditions
- Serrated texture on all sides offers extra grip
- Built-in grab handle



WC091060



WC091061

Part No.	Width (in.)	Height (in.)	Thickness (in.)	Material	Finish	Color	Wt. (lbs.)
WC091060	9.00	5.50	10.00	Carbon Steel	Galvanized	Silver	10
WC091061	9.00	5.50	10.00	Carbon Steel	Galvanized	Orange	10

WHEEL CHOCK BRACKET

- 1/4 in. x 1/4 in. steel bar
- Stores WC1267 wheel chocks (not included)



WCB186

Part No.	Length (in.)	Thickness (in.)	Material	Finish	Color	Wt. (lbs.)
WCB186	20.86	5.82	Carbon Steel	Powder Coat	Black	2.9



Landscape Trailer Accessories & Agricultural Products



Product Shown:

- LT13: 3-Position Channel Style Lockable Trimmer Rack
- LT40: Trimmer Line Spool Bracket
- LT20: Universal Backpack Blower Rack
- LT30: Gas Container Rack For Trailers
- LT25: Water Cooler Rack

Landscape Trailer Racks	290 - 295
Landscape Trailer Accessories	296
Carriers and Holders	297

Poly Storage Tanks	298 - 299
ATV/UTV All Season Spreaders	300

Landscape Trailer Racks

TRIMMER RACKS

LOCKING FLAT PIN

- Trimmer hooks are heavy-duty, vinyl coated to protect from dings and scratches
- Hooks feature multiple flat pin slots to accommodate various trimmers and reduce rattling
- Mounting hardware and lock(s) included
- Trimmer not included



LT18



LT18 Application

Part No.	Capacity	Width (in.)	Height (in.)	Depth (in.)	Wt. (lbs.)
LT18	2 Trimmers	3.50	20.94	4.75	13.25



LT13



LT13 Application

Part No.	Capacity	Width (in.)	Height (in.)	Depth (in.)	Wt. (lbs.)
LT13	3 Trimmers	3.50	31.88	4.75	18.5



LT14

Part No.	Capacity	Width (in.)	Height (in.)	Depth (in.)	Wt. (lbs.)
LT14	4 Trimmers	3.50	42.82	4.75	23.75

FLEET SERIES LOCKING

- Durable 1/8 in. carbon steel construction
- Easily mounts to any open trailer
- Pre-drilled holes are slotted to line up with variable height trailer side rails
- 1-1/2 in. deep trimmer latch is lined with foam gasket to protect tools
- Hinged latch comes with key locking padlock for each holder
- Base coat primer and top powder coat provide excellent corrosion resistance



LT19



LT21 Application

Part No.	Capacity	Width (in.)	Height (in.)	Depth (in.)	Wt. (lbs.)
LT19	2 Trimmers	2.00	33.75	1	14.74
LT21	3 Trimmers	2.00	45.25	1	18.27



TRIMMER RACKS - continued

LOCKING SNAP-IN RACK, 3-POSITION

- Easy, snap-in design for effortless storage of up to 3 trimmers
- Lock bar secures 3 trimmer racks with 1 padlock
- Stainless steel springs maintain snap back even with repeated daily use
- Black power-coated for corrosion resistance
- Secures with padlock (not included)

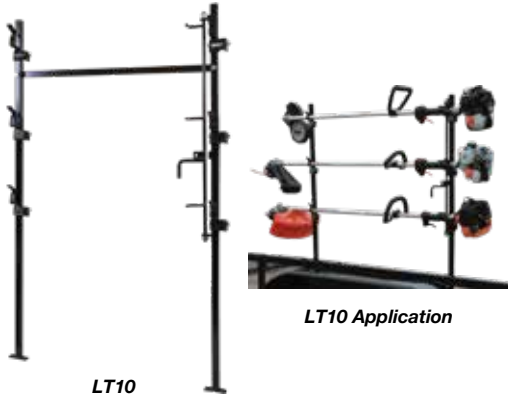

LT10



LT10 Application

Part No.	Capacity	Width (in.)	Height (in.)	Depth (in.)	Wt. (lbs.)
LT10	3 Trimmers	1.00	54.41	3.25	25

Accessories:

Part No.	Description	Wt. (lbs.)
3004090	Trimmer Rack Lock	2.13

SNAP-IN RACK, 3-POSITION

- Easy, snap-in design for effortless storage of up to 3 trimmers
- Stainless steel springs maintain snap back even with repeated daily use
- Black power-coated for corrosion resistance



LT12



LT12 Application

Part No.	Width (in.)	Height (in.)	Capacity	Wt. (lbs.)
LT12	1.00	32.00	3 Trimmers	15.15

TRIMMER LINE SPOOL BRACKET

- Holds most 3 lb or 5 lb line spools (not included)
- Powder-coated steel construction for corrosion resistance
- Mounting hardware included



Part No.	Length (in.)	Width (in.)	Height (in.)	Wt. (lbs.)
LT40	6.25/7.50	5.50	5.50	2.76



LT40



LT40 Application Enclosed Trailer



LT40 Application Open Trailer

Landscape Trailer Racks

BLOWER RACKS

LOCKING ADJUSTABLE BACKPACK BLOWER RACK

- Adjustable height to fit all blower makes and models
- Fits open and enclosed style trailers
- Locks to secure your backpack blowers when not in use
- Built-in wand holder supports wands up to 5 in. in diameter
- Includes rubber mat to reduce road vibrations



LT24



LT24 Application

Part No.	Length (in.)	Width (in.)	Height (in.)	Depth (in.)	Capacity	Wt. (lbs.)
LT24	15.00	15.00	14.25	14.50	(1) Backpack Blower	32.87

BACKPACK BLOWER RACK FOR STIHL® BLOWERS

- Designed specifically for STIHL® BR340, BR380, BR420 or BR440 blowers
- Blower rests on bottom support and is secured on top hang pin
- Padlock and blower not included



LT22



LT22 Application

Part No.	Width (in.)	Height (in.)	Capacity	Wt. (lbs.)
LT22	23.00	40.25	(1) STIHL® BR340, BR380, BR420 or BR440 Backpack Blower	6.5

BACKPACK BLOWER RACK

- Rack mounts on any style trailer to keep backpack blowers out of the way and easily accessible
- Secures backpack blowers onto spring latch hook
- Rubber straps keep equipment securely in place while vehicle is in motion
- Padlock and blower not included



LT20



LT20 Application

Part No.	Width (in.)	Height (in.)	Capacity	Wt. (lbs.)
LT20	12.63	40.25	(1) Backpack Blower (Not STIHL® BR Series)	9.14

SPRAYER RACK

ADJUSTABLE SPRAYER RACK FOR OPEN AND ENCLOSED LANDSCAPE TRAILERS

- Fits open and enclosed style trailers
- Works with popular backpack sprayers from Echo®, Shindaiwa® and Stihl®
- Includes adjustable tie strap with buckle to secure sprayer
- Corrosion resistant black powder-coated finish
- Bolts to side rails on open trailers
- Sprayer not included



LT23



LT23 Application

Part No.	Width (in.)	Height (in.)	Depth (in.)	Capacity	Wt. (lbs.)
LT23	16.87/18.36	19.75	8.38	(1) Backpack Sprayer	15.04



MULTI-RACKS

MULTI-TOOL CAGE WITH LOCKING LID

- Protects hedge trimmers, chainsaws, or handheld blowers
- Lid-to-base locking mechanism (lock not included)
- Includes: rubber anti-vibration skid pad, bracket to fit hedge-trimmer, rubber straps, and mounting hardware



LT17



LT17 Application

Part No.	Length (in.)	Width (in.)	Height (in.)	Depth (in.)	Wt. (lbs.)
LT17	13.75	13.00	12.25	12.35	20.01

MULTI-RACK FOR TRAILERS

- Protects hedge trimmers, chainsaws, or handheld blowers
- Includes rubber straps to secure equipment
- For side rail or wall mount



LT15



LT15 Application

Part No.	Length (in.)	Width (in.)	Height (in.)	Depth (in.)	Wt. (lbs.)
LT15	13.25	12.00	9.61	12.00	15

LOCKING GAS CONTAINER RACK

- Works with the following gas cans: Blitz US Inc. 5 and 6 gal; Midwest Can Co. Models 5600, 7600, & 8600; No-Spill Inc. Models 1058, 1450, 1456, & 1457 (not included)
- Black powder-coated steel for corrosion resistance
- Includes mounting hardware and lock and steel pin to lock gas canister in place



LT32



LT32 Application

Part No.	Length (in.)	Width (in.)	Height (in.)	Capacity	Wt. (lbs.)
LT32	15.28	10.63	9.38	Gas Can (1 x 5 gallon)	11.22

GAS CONTAINER RACK FOR TRAILERS

- Rack holds (1) 5 gal or (2) 2-1/2 gal polymer cans (not included)
- Nylon strap is included to secure can(s)
- For enclosed or open style trailers
- Wall mount bracket included
- Black powder-coated steel for corrosion resistance



LT30



LT30 Application

Part No.	Length (in.)	Width (in.)	Height (in.)	Capacity	Wt. (lbs.)
LT30	18.75	12.00	4.00	Gas Can (1 x 5 gallon or 2 x 2-1/2 gallon)	12.83

Landscape Trailer Racks

MULTI-RACKS - continued

MULTI-PURPOSE STORAGE BASKET FOR OPEN LANDSCAPE TRAILERS

- Can accommodate up to 250 lb evenly distributed
- Fits open trailers 4 ft 10 in. - 6 ft 8 in. wide
- Includes LT40, LT44, LT45 trimmer line holder and LT20 backpack blower holder
- Includes 2 adjustable dividers and mounting legs
- Black powder-coat finish for corrosion resistance
- Includes mounting hardware

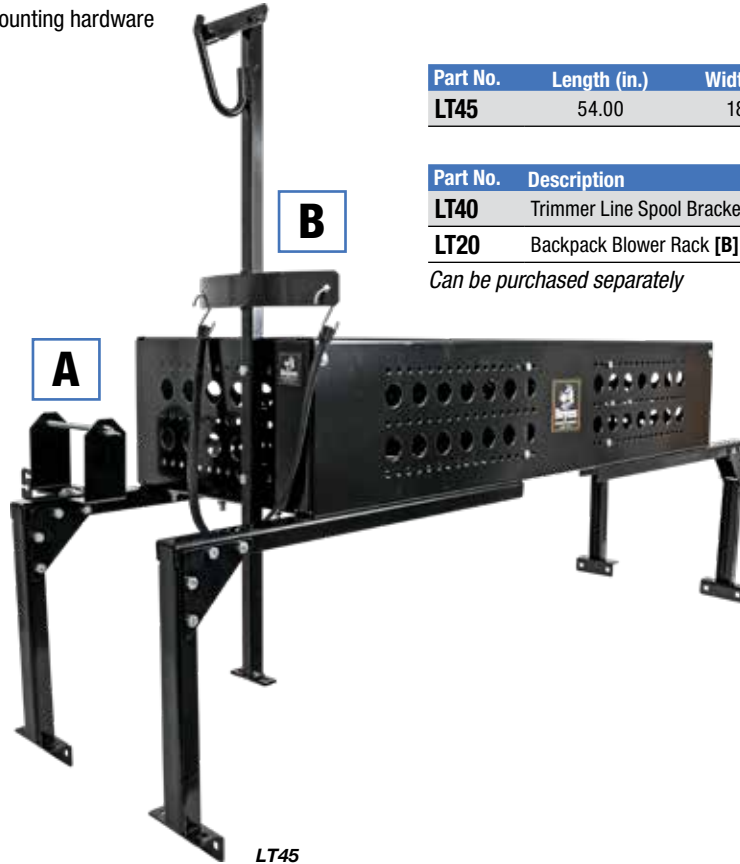

Part No.	Length (in.)	Width (in.)	Height (in.)	Wt. (lbs.)
LT45	54.00	18.00	10.5 (Sides) / 15.75 (Legs)	105.01

Part No.	Description	Wt. (lbs.)
LT40	Trimmer Line Spool Bracket [A]	3.1
LT20	Backpack Blower Rack [B]	7.0

Can be purchased separately

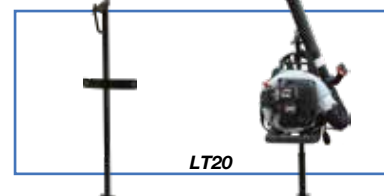

5 POSITION VERTICAL HAND TOOL RACK

- Holds 5 straight, triangle or D-handle tools
- Bolts on to LT45
- Includes mounting hardware



LT46



LT46 Application

Part No.	Length (in.)	Width (in.)	Height (in.)	Capacity	Wt. (lbs.)
LT46	37.25	4.00	31.50	5 straight handle or triangle/D-handle tools	14.51

UNIVERSAL HEAVY DUTY OPEN-TOP TOOL BASKET

- Offers open tool storage and organization
- .096 in. steel construction and black powder-coat finish for corrosion resistance
- All hardware included
- (2) Adjustable dividers
- Ships unassembled



LT44

Part No.	Length (in.)	Width (in.)	Height (in.)	Wt. (lbs.)
LT44	53.75	18.00	10.00	74.36



WATER COOLER RACKS

WIRE FORM WATER COOLER RACK

- Wire formed steel construction
- 1 in. nylon tie strap included
- Water cooler not included

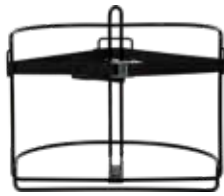

5201007



5201007 Application



Part No.	Width (in.)	Height (in.)	Depth (in.)	Capacity	Wt. (lbs.)
5201007	14.50	12.00	11.10	(1) Water Cooler	3

WATER COOLER RACK

- Holds 3 to 5 gallon coolers
- Bolts to side rails or wall mount
- Mounting hardware and adjustable straps included
- Water cooler not included



LT25



LT25 Application



Part No.	Width (in.)	Height (in.)	Depth (in.)	Capacity	Wt. (lbs.)
LT25	10.58	18.56	6.44	(1) Water Cooler	7.79

TOOL RACKS

VERTICAL HAND TOOL RACK

- Holds up to 6 straight handle tools (not included)
- Keeps tools organized and trailer floor clutter-free
- Includes rubber grommets to protect tools



LT35



LT35 Application



Part No.	Width (in.)	Height (in.)	Capacity	Wt. (lbs.)
LT35	23.00	39.25	6 Straight Handle Tools	10.82

Accessories:

Part No.	Description	Wt. (lbs.)
3004167	2 Inch Rubber Grommet, Replacement	0.02

HORIZONTAL HAND TOOL RACK

- Holds up to 6 straight handle tools (not included)
- Keeps tools organized and trailer bed clutter-free
- Includes rubber grommets to protect tools



LT37



LT37 Application



Part No.	Width (in.)	Height (in.)	Capacity	Wt. (lbs.)
LT37	23.00	5.00	6 Straight Handle Tools	8.77

Accessories:

Part No.	Description	Wt. (lbs.)
3004167	2 Inch Rubber Grommet, Replacement	0.02

MOUNTING BRACKET FOR ROUND TRAILER RAILS



LT59



LT59 Application

Part No.	Length (in.)	Width (in.)	Height (in.)	Wt. (lbs.)
LT59	5.00	3.00	3.50	2.1

- Clamps to round trailer rails for installation of racks
- Accommodates rails 1-5/8 in., 2 in. and 2-3/8 in. diameter
- Standard drill pattern to accommodate all Buyers racks
- Includes hardware for mounting to rail

Landscape Trailer Accessories

TAILGATE ASSIST

EZ GATE™ TAILGATE ASSIST

- Patented design reduces physical strain from lifting and lowering heavy trailer tailgates by up to 90%
- One kit is strong enough to work on tailgates up to 180 lbs
- Single side design frees up space for rail mounted accessories
- Features a no-rattle spring insert for quieter operation
- Works on most standard open trailers with round or square tubing



5201000



5201000 Application

Part No.	Description	Capacity	Wt. (lbs.)
5201000	EZ Gate™ Tailgate Assist	Gates Up To 180 lbs.	19

TORSION RAMP SPRINGS

- 3034278 replaces Sure-Trac ST9437L
- 3034279 replaces Sure-Trac ST9437R



3034278

3034279

3002879

3002880

3020695

3020694

Part No.	Description	Spring Rate (in-lbs/deg)	No. of Coils	Coil Length (in.)	Max Deflection (°)	I.D. (in.)	O.D. (in.)	Bar Dia. (in.)	Bar Ends (in.)	Material	Wt. (lbs.)
3034278	Left Hand	23	5	1.87		1.18	1.87	.311	3.00	Spring Steel	0.63
3034279	Right Hand	23	5	1.87		1.18	1.87	.311	3.00	Spring Steel	0.63
3002879	Left Hand	21-23	6.83	3.75	74	1.88	2.85	.468	5.00	Spring Steel	3.03
3002880	Right Hand	21-23	6.83	3.75	74	1.88	2.85	.468	5.00	Spring Steel	3.03
3020695	Left Hand	12.09	10.21	4.90	100.9	1.85	2.75	.4375	3.25	Spring Steel	3.5
3020694	Right Hand	12.09	10.21	4.90	100.9	1.85	2.75	.4375	3.25	Spring Steel	3.5

TIRE CARRIERS

SPARE TIRE CARRIER

- Black powder-coat finish for corrosion resistance
- Universal fit for 19.5 in. rims or smaller
- Oversized wing nut lets you easily remove or secure tires
- Can be welded or bolted on



5201010



5201010 Application

Part No.	Length (in.)	Width (in.)	Height (in.)	Material	Wt. (lbs.)
5201010	23.63	6.50	.88	Carbon Steel	8





STAKE POCKET SPARE TIRE CARRIER

- Black powder-coat finish for corrosion resistance
- Provides a removable spare tire mount on stake body trucks and trailers
- Fits wheels with the following bolt patterns: 5 on 4.5 in., 5 on 5 in., 6 on 5-1/2 in., and 8 on 6-1/2 in.
- Fits most standard stake pockets
- Installation hardware is included



5201012



5201012 Application

Part No.	Width (in.)	Height (in.)	Depth (in.)	Material	Color	Wt. (lbs.)
 5201012	6.75	13.87	8.00	Carbon Steel	Black	9.49

UNIVERSAL TRAILER BOLT-ON SPARE TIRE CARRIER

- Black powder-coat finish for corrosion resistance
- 1/2 in. adjustable carriage bolts fit 8 in. - 15 in. wheels
- Bolts to trailer frames up to 3-1/4 in. wide
- Plated mounting hardware included



5201014



5201014 Application

Part No.	Width (in.)	Height (in.)	Depth (in.)	Material	Color	Wt. (lbs.)
 5201014	4.00	11.00	10.50	Carbon Steel	Black	5.55

DOCUMENT HOLDERS

VEHICLE DOCUMENT HOLDER

- Ideal for tractor trailer applications
- Rubber caps provide a tight seal
- Aluminum mounting bracket
- Stainless steel tube



5201100

Part No.	Length (in.)	Width (in.)	Height (in.)	Finish	Color	Wt. (lbs.)
5201100	4.00	2.81	5.75	Plain	Natural	0.59

DOCUMENT HOLDER WITH CLEAR COVER

- Corrosion, impact and UV resistant plastic construction
- Keeps permits, work licenses, and other papers dry, secure and accessible
- Mounting hardware included
- 9 in. Dia. x 1-5/8 in. H
- Interior spring keeper



5201101

Part No.	Material	Finish	Color	Wt. (lbs.)
5201101	Plastic	Plain	Grey	0.4

Poly Storage Tanks

POLY STORAGE TANKS

- Produced out of all-virgin, medium density polyethylene with UV inhibiting stabilizers for long-term outdoor storage
- Approved for potable water, agricultural chemicals, industrial chemicals, other non-flammable liquids. Not intended for fuel storage
- Large fill cap and drain. Easy tightening cap
- One piece molded tank with molded channels for saddle straps
- Thick walled heavy duty construction with a low profile design

DOMED STORAGE TANK



82123879 82123889 82123899

Part No.	Length (in.)	Width (in.)	Height (in.)	Tank Capacity (gal.)	Port Size (in.)	Tank Shape	Mount Style	Wt. (lbs.)
82123879	16.00	12.00	15.00	8.00	.750	Domed	Strap	7
82123889	22.00	16.00	16.00	16.00	.750	Domed	Strap	10
82123899	26.00	18.00	19.00	26.00	.750	Domed	Strap	12

SQUARE STORAGE TANK



82123909 82123919 82123929

Part No.	Length (in.)	Width (in.)	Height (in.)	Tank Capacity (gal.)	Port Size (in.)	Tank Shape	Mount Style	Wt. (lbs.)
82123909	24.00	19.00	22.00	30.00	.750	Square End	Strap	18
82123919	38.00	19.00	22.00	50.00	.750	Square End	Strap	25
82123929	38.00	30.00	29.00	100.00	.750	Square End	Strap	40

STORAGE TANK WITH LEGS



82123939 82123949 82124269

Part No.	Length (in.)	Width (in.)	Height (in.)	Tank Capacity (gal.)	Port Size (in.)	Tank Shape	Mount Style	Wt. (lbs.)
82123939	38.00	23.00	27.00	65.00	.750	Round Ends with Legs	Strap	28
82123949	48.00	36.00	28.00	125.00	.750	Round Ends with Legs	Strap	50
82124269	78.00	48.00	49.00	550.00	2.00	Round Ends with Legs	Strap	160

Accessories:

Part No.	Description	Wt. (lbs.)
1496505	4 Piece Spreader Tie Down Kit	8.64



POLY STORAGE TANKS - continued

PICKUP TRUCK STORAGE TANK



82124639

82124649

Part No.	Length (in.)	Width (in.)	Height (in.)	Tank Capacity (gal.)	Port Size (in.)	Tank Shape	Mount Style	Wt. (lbs.)
82124639	60.00	52.50	29.80	210.00	.750	Round Vertical	Strap	90
82124649	52.50	62.00	32.80	325.00	2.00	Round Vertical	Strap	110

VERTICAL STORAGE TANK



82124659

82124659

Part No.	Length (in.)	Width (in.)	Height (in.)	Tank Capacity (gal.)	Port Size (in.)	Tank Shape	Mount Style	Wt. (lbs.)
82124749	67.00	67.00	45.00	550.00	2.00	Round Vertical	Strap	140
82124659	86.00	86.00	71.00	1550.00	2.00	Round Vertical	Strap	315

HOPPER-MOUNTED POLY TANKS



3010816

Part No.	Length (in.)	Width (in.)	Height (in.)	Tank Capacity (gal.)	Port Size (in.)	Tank Shape	Mount Style	Wt. (lbs.)
3036808	48.00	13.00	14.00	30.00	.750	Rectangle	Hopper	25
3010816	69.00	20.00	25.00	105.00	.750	Wedge	Hopper	62
3026538	144.00	28.00	33.00	400.00	2.00	Rectangle	Hopper	218

ATV/UTV All Season Spreaders

SPREADERS

- Sealed 12V motor
- Direct linkage controls eliminate stretching/breaking cable
- Multi-purpose design: salt, fertilizer, broadcast seed & feed game
- Manual feed gate regulator
- Hopper empties completely

ATV ALL PURPOSE SPREADER - HORIZONTAL RACK MOUNT

- 100 lb capacity, polymer hopper
- Rain cover included



ATVS100

Part No.	Drive Type	Hopper Length (in.)	Hopper Width (in.)	Overall Height (in.)	Wt. (lbs.)
 ATVS100	Electric	23.00	20.00	13.00	20

ATV ALL PURPOSE SPREADER - VERTICAL RACK AND HITCH MOUNT

- 15 gallon capacity, polymer hopper
- Black powder-coated steel framework for corrosion resistance



ATVS15A

Part No.	Drive Type	Hopper Length (in.)	Hopper Width (in.)	Overall Height (in.)	Wt. (lbs.)
ATVS15A	Electric	15.00	16.55	23.5	39

UTV ALL PURPOSE SPREADER - 2 INCH RECEIVER MOUNT

- 15 gallon capacity, polymer hopper
- Black powder-coated steel framework for corrosion resistance
- Quick detach mounting bracket



UTVS16

Part No.	Drive Type	Hopper Length (in.)	Hopper Width (in.)	Overall Height (in.)	Wt. (lbs.)
UTVS16	Electric	15.00	16.55	31.50	57.5



Truck & Trailer Hardware



Product Shown:

PH30: 30 Ton Pintle Hook
B5055: 1" Forged 55° Angled D-Ring
1809029: Fabricators Hitch Plate
TC1007P: 7-Way, Truck-Side Trailer Plug
B36SPP: Solid Black Rubber Mudflaps
TGBE6438: Banjo Eyes
8591100: Mudflap Clamps

U-Bolts and Tie Down Rods	302 - 303
Stake Body Hardware	304 - 306
Steps and Tread	307 - 310
Tread and Grip	311
Grab Handles	312 - 313
Fuel Fill Dishes	313
Paddle Latches	314
T-Handle Latches	315 - 317
Spring Latches	318 - 320

Draw Latches	321
Hood Latches	322
Door Locks and Handles	323
Locks, Levers	324
Cam Lock Kits and Corner Iron	325
Door and Body Hardware	326 - 327
Pins	328 - 330
Dump Body Hardware	331 - 340
Hinges	341 - 346

U-Bolts and Tie Down Rods

SQUARE BEND U-BOLT KIT

- (4) square bend 5/8 in. U-Bolts
- (8) 5/8 in. hex nuts & (8) 5/8 in. split lock washers
- Grade 5 equivalent hardware
- (4) forged 1/2 in. thick x 4-1/4 in. wide tie bars
- U-Bolt kits are shipped individually boxed, other diameter, length and finish U-Bolts are available by special order



UB623512

Part No.	Length (in.)	Center Spacing (in.)	Wt. (lbs.)
UB623512	12.00	4.25	13.2
UB623514	14.00	4.25	13.16
UB623516	16.00	4.25	14.65
UB623518	18.00	4.25	15.79
UB623520	20.00	4.25	18
UB623522	22.00	4.25	18.7
UB623524	24.00	4.25	20

UNIVERSAL SPRING CUSHION MOUNTING KIT

- Spring-cushioned design provides stress relief for off-road chassis flex
- Forged tie bars
- Zinc-plated for corrosion resistance
- Each kit comes complete with four 5/8 in. U-bolts for mounting
- Commonly used with aluminum backpack truck tool boxes



3008086

Part No.	Length (in.)	Center Spacing (in.)	Finish	Wt. (lbs.)
3008086	16.00	4.25	Zinc-Plated	17

BODY TIE DOWN ROD

- Grade 5 material
- 4 in. of 5/8 in. - 11 N.C. thread on each end
- Plain finish
- Hardware bag TR6211588 contains (8) 5/8 in. - 11 Gr. 5 hex nuts and (8) 5/8 in. split lock washers (must purchase separately)



TR6211516



TR6211588

Part No.	Thread (in.)	Length (in.)	Finish	Wt. (lbs.)
TR6211518	5/8-11	18.00	Plain	1.24
TR6211520	5/8-11	20.00	Plain	1.36
TR6211522	5/8-11	22.00	Plain	1.54
TR6211524	5/8-11	24.00	Plain	1.6

Accessories:

Part No.	Description	Wt. (lbs.)
TR6211588	Hardware Kit for Body Tie Down Rods	0.74



U-Bolts and Tie Down Rods

TIE BAR

- Available in two lengths for various applications
- Standard 1-1/2 in. width works with U-bolts and tie-down rods
- Plain finish



B2162E

Part No.	Length (in.)	Width (in.)	Thickness	Mounting Holes		Material	Finish	Wt. (lbs.)
				Ctr to Ctr (in.)				
B2162H	6.50	1.50	.50	4.50		Carbon Steel	Plain	1.24
B2162N	6.00	1.50	.781	4.25		Carbon Steel	Plain	1.06

FORGED TIE BAR

- Forged from 1/2 in. thick steel
- Available in plain finish or clear zinc finish



B2162FF

Part No.	Length (in.)	Width (in.)	Thickness	Mounting Holes		Material	Finish	Wt. (lbs.)
				Ctr to Ctr (in.)				
B2162FF	5.75	1.25	.50	4.25		Forged Steel	Plain	0.91
B2162FFZ	5.75	1.25	.50	4.25		Forged Steel	Zinc Plated	0.92

BODY MOUNTING HOOKS **NEW**

- Used when U-bolts are blocked by exhaust, tanks or suspension components
- Slides onto truck frame flanges
- Used with body tie down rods



3050386



3050387



3050386 Application

Part No.	Length (in.)	Width (in.)	Fits Frame Thickness (in.)	Material	Mounting Type	Finish	Wt. (lbs.)
3050386	5.09	1.97	.520	Carbon Steel	Bolt-on	Plain	1.29
3050387	6.00	2.56	.485	Carbon Steel	Bolt-on	Plain	2.59

Stake Body Hardware

SECURITY LATCH SET

- Complete set of (4) bagged pieces
- Available in either a plain finish bolt-on style, zinc finish bolt-on style, or plain finish weld-on style
- Replacement parts also available for repair needs
- Can be installed for right or left hand operation for ease of use



B2588B

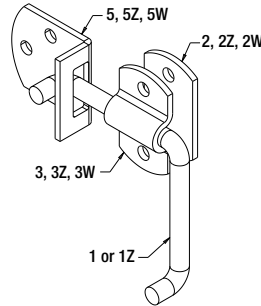

Straight Side Security Latch



B2589BZ

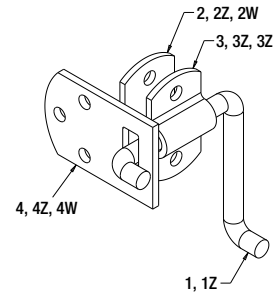

Corner Security Latch

Part No.	Bolt Diameter (in.)	Bolt Length (in.)	Mounting Type	Finish	Wt. (lbs.)
06025	0.50	4.69	Bolt-On	Plain	1.48
B2588B	0.50	4.69	Bolt-On	Plain	1.5
B2588BZ	0.50	4.69	Bolt-On	Zinc Plated	1.5
B2588W	0.50	4.69	Weld-On (No Holes)	Plain	1.5
B2589B	0.50	4.69	Bolt-On	Plain	1.5
B2589BZ	0.50	4.69	Bolt-On	Zinc Plated	1.5
B2589W	0.50	4.69	Weld-On (No Holes)	Plain	1.5

Accessories:

Part No.	Description	Wt. (lbs.)
1	Latch Bar, Plain Finish	0.51
1Z	Latch Bar, Zinc Plated Finish	0.51
2	Bottom Bearing Plate, Plain Finish	0.23
2W	Bottom Bearing Plate, Weld-On (No Holes)	0.23
2Z	Bottom Bearing Plate, Zinc Plated Finish	0.23
3	Cap Bearing, Plain Finish	0.27
3W	Bearing Cap, Weld-On (No Holes)	0.27
3Z	Bearing Cap, Zinc Plated Finish	0.27
4	Corner Plate, Plain	0.37
4W	Corner Plate, Weld-On (No Holes)	0.42
4Z	Corner Plate, Zinc Plated	0.45
5	Plate, side 90 deg bend, Plain Finish	0.42
5W	Side Plate, 90° Bend, Weld-On (No Holes)	0.4
5Z	Side Plate, 90° Bend, Zinc Plated Finish	0.39



QUICK RELEASE SPRING LATCH

- Spring-loaded handle
- Zinc-plated bolt and housing with stainless steel spring
- Bolt-on installation
- B2590KZ sold separately



Part No.	Desc.	Keeper (y/n)	Bolt Dia. (in.)	Bolt Length (in.)	Housing Length (in.)	Housing Width (in.)	Mount Type	Housing Material	Housing Finish	Wt. (lbs.)
B2590RH	Right Hand	No	0.50	4.69	6.09	2.66	Bolt-On	Carbon Steel	Zinc Plated	0.81
B2590LH	Left Hand	No	0.50	4.69	6.09	2.66	Bolt-On	Carbon Steel	Zinc Plated	0.81

Accessories:

Part No.	Description	Wt.(lbs.)
B2590KZ	90 Degree Stake Body Spring Latch Keeper for B2590LH/RH	0.4

SPRING LATCH

- Use on tailgates, stake posts, and drawers
- Zinc finish hook & spring



Part No.	Keeper (y/n)	Housing Length (in.)	Housing Height (in.)	Housing Width (in.)	Mount Type	Housing Material	Housing Finish	Wt. (lbs.)
B2597	No	10.00	1.00	0.75	Bolt-On	Carbon Steel	Zinc Plated	0.25

LINER SLAT

- 16 gauge steel
- Long edges are rolled over, and corners are rounded for ease of installation and safety



Part No.	Length (in.)	Width (in.)	Material	Finish	Wt. (lbs.)
LS166545	44.62	6.50	Carbon Steel	Plain	5.7
LS166548	47.25	6.50	Carbon Steel	Plain	5.7
LS166554	53.25	6.50	Carbon Steel	Plain	6.5
LS166572	71.25	6.50	Carbon Steel	Plain	9
LS166590	90.00	6.50	Carbon Steel	Plain	11.5
LS1665120	120.00	6.50	Carbon Steel	Plain	15
LS1665144	144.00	6.50	Carbon Steel	Plain	18

STAKE ASSEMBLY

- Two piece stakes with welded reinforcements
- 14 gauge steel
- Assembly fits a 3 in. wide, 4-3/4 in. deep stake pocket



Part No.	Length (in.)	Width (in.)	Material	Finish	Wt. (lbs.)
SA1447WDNH	47.00	4.50	Carbon Steel	Plain	6.66
SA1454WDNH	54.00	4.50	Carbon Steel	Plain	8.5

Stake Body Hardware

STRAIGHT BOLT-ON STAKE POCKET

- Straight pocket designed for easy in and out of stake posts on stake bodies
- 14 gauge steel



B2373G

Part No.	Width (in.)	Height (in.)	Inside Dimensions (in.)	Pocket Depth (in.)	Material	Finish	Mounting Type	Wt. (lbs.)
B2373G	6.50	2.50	1.50x3.00	2.50	Carbon Steel	Plain	Bolt-On	0.7

TAPERED BOLT-ON STAKE POCKET

- Pockets are tapered slightly for tight fit of upright stake posts on stake body assembly
- 14 gauge steel



B2374G

Part No.	Width (in.)	Height (in.)	Pocket Width Top (in.)	Pocket Width Bottom (in.)	Pocket Depth (in.)	Material	Finish	Mounting Type	Wt. (lbs.)
06010	6.50	2.50	3.00	2.875	2.50	Carbon Steel	Plain	Bolt-On	0.82
B2374G	6.50	2.50	3.00	2.875	2.50	Carbon Steel	Plain	Bolt-On	0.7
B2374GZ	6.50	2.50	3.00	2.875	2.50	Carbon Steel	Zinc Plated	Bolt-On	0.7

STRAIGHT WELD-ON STAKE POCKET

- Ideal for securing stake body wall assemblies on the straight side of a stake body flatbed or trailer
- Made of 14 gauge steel



B2373W

Part No.	Width (in.)	Height (in.)	Inside Dimensions (in.)	Pocket Depth (in.)	Material	Finish	Mounting Type	Wt. (lbs.)
B2373C	4.00	2.00	3.50x1.80	2.00	Carbon Steel	Plain	Weld-On	1.9
B2373J	3.00	3.00	3.00x1.50	3.00	Carbon Steel	Plain	Weld-On	1.29
B2373K	3.00	4.00	3.00x1.50	4.00	Carbon Steel	Plain	Weld-On	1.67
B2373R	4.00	3.00	3.50x1.50	3.00	Carbon Steel	Plain	Weld-On	1.3
B2373W	3.50	2.50	3.00x1.50	2.50	Carbon Steel	Plain	Weld-On	0.48

STAKE POCKET WITH 1/2 INCH D-RING

- Fits common flush and outside stake pockets
- Provides convenient tie point for chains or straps
- Black powder-coat finish for corrosion resistance
- 2-Position adjustable height with 1/2 in. hitch pin
- D-rings are not approved for overhead use



B38SP



B38SP Application

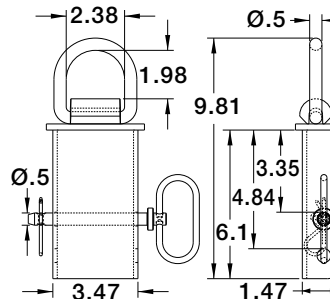

B38SP Drawing

Part No.	Ring Dia. (in.)	Inner Width (in.)	Inner Height (in.)	W.L.L. (lbs.)	Wt. (lbs.)
B38SP	1/2	2-3/8	2-1/2	4,080	3.8



FOLDING STEPS & GRABS

FOLDING FOOT/GRAB STEP

- Adds a convenient step grab or handle on your vehicle
- Opens a full 90° and folds back flat for transport

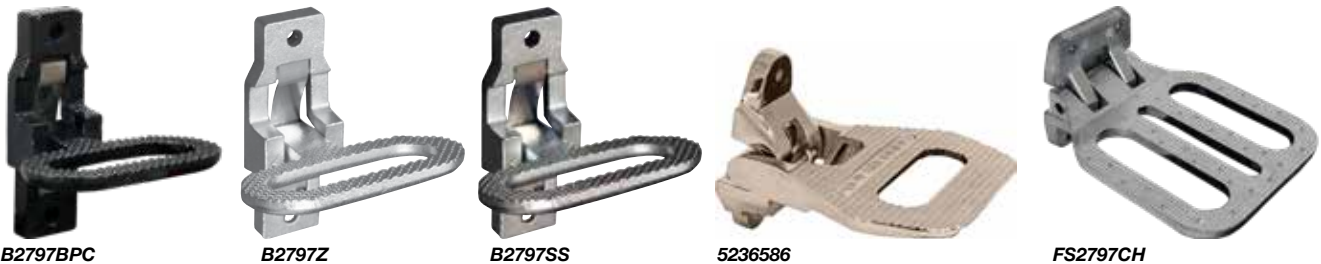

Part No.	Platform Width (in.)	Platform Depth (in.)	Mounting Bracket Width (in.)	Mounting Bracket Height (in.)	Material	Finish	Mounting Type	Color	Wt. (lbs.)
B2797BPC	4.38	2.10	1.75	4.70	Steel	E-Coated	Bolt-On	Black	1.25
B2797Z	4.38	2.10	1.75	4.70	Steel	Zinc Plated	Bolt-On	Silver	1.25
B2797SS	4.38	2.10	1.75	4.70	304 Stainless Steel	Plain	Bolt-On	Natural	1.16
5236586*	6.50	5.30	3.50	5.00	Steel	Zinc Plated	Bolt-On	Silver	3.5
FS2797CH*	6.75	8.56	4.00	4.88	Steel	Chrome Plated	Bolt-On	Chrome	4.96

* Conforms to National Fire Protection Association (NFPA) specifications for use on emergency vehicles. Not for use as grab handle due to tread

BREAKAWAY TRUCK STEP

- Mounts to step bumper
- Step pivots forward or backward to prevent damage if impacted
- The cast brass mounting bracket and stainless steel pivot shafts, springs, and fasteners resist corrosion
- The galvanized steel grip step provides extra slip protection
- Step folds up for transport



5230710

5230710 Folded

Part No.	Platform Length	Platform Width (in.)	Platform Depth (in.)	Material	Finish	Mounting Type	Wt. (lbs.)
5230710	7.00	10.00	4.00	Steel	Galvanized	Bolt-On	8.45

5230710 shown



Steps and Tread

RETRACTABLE STEPS

RETRACTABLE SLIDE-IN TRUCK STEP

- Non-slip treads ideal for truck and trailers
- The slide-in horizontal storage avoids interference with toolboxes, reservoirs, and more
- Steps can be bolted or welded on



Part No.	Number of Rungs	Width (in.)	Height (in.)	Distance Between Rungs	Material	Finish	Color	Wt. (lbs.)
5232000	2	19.63	25.50	11.00	Carbon Steel	Powder Coat	Black	21.2
5232001	2	19.63	25.50	11.00	Stainless Steel	Stainless Steel	Natural	21.2
5232000YEL	2	19.63	25.50	11.00	Carbon Steel	Powder Coat	Yellow	21.2
5233000	3	19.63	30.25	9.50	Carbon Steel	Powder Coat	Black	24.86
5233001	3	19.63	30.25	9.50	Stainless Steel	Stainless Steel	Natural	24.9
5233000YEL	3	19.63	30.25	9.50	Carbon Steel	Powder Coat	Yellow	24.86

RETRACTABLE TRUCK STEP

- Compact one-rung design with non-slip treads
- Fold away design for storage when not in use
- 14 in. bolt centers



Part No.	Number of Rungs	Width (in.)	Height (in.)	Material	Finish	Mounting Type	Color	Wt. (lbs.)
RS1	1	17.37	15.00	Carbon Steel	Powder Coat	Bolt-on or Weld-on	Black	18.72
RS1SS	1	17.37	15.00	Stainless Steel	Stainless Steel	Bolt-on or Weld-on	Natural	0.01
RS2	2	17.38	30.25	Carbon Steel	Powder Coat	Bolt-on or Weld-on	Black	23
RS2SS	2	17.38	30.25	Stainless Steel	Stainless Steel	Bolt-on or Weld-on	Natural	23
RS2W	2	17.38	30.25	Carbon Steel	Powder Coat	Bolt-on or Weld-on	White	23
RS2Y	2	17.38	30.25	Carbon Steel	Powder Coat	Bolt-on or Weld-on	Yellow	23
RS3	3	17.38	35.00	Carbon Steel	Powder Coat	Bolt-on or Weld-on	Black	25
RS3SS	3	17.38	35.00	Stainless Steel	Stainless Steel	Bolt-on or Weld-on	Natural	25
RS3Y	3	17.38	35.00	Carbon Steel	Powder Coat	Bolt-on or Weld-on	Yellow	25



FIXED STEPS

FLEXIBLE RUBBER STEP

- Belted rubber, flexes to resist damage from low objects and off road impact
- Mounting bracket is powder-coat finished and can be welded or bolted on
- Zinc hardware is included for installation
- Ideal for mechanics trucks with low work shelf bumpers



5231112



5231112 Application

Part No.	Number of Rungs	Width (in.)	Height (in.)	Depth (in.)	Step Thickness (in.)	Finish	Color	Wt. (lbs.)
5231112	1	12.00	11.00	4.75	1.88	Galvanized	Black / Silver	11
5231130	1	30.00	11.00	4.75	1.88	Galvanized	Black / Silver	22

CABLE TRUCK STEP

- Steps have 1-1/4 in. galvanized wire cable
- Cable welded to 1-1/2 in. pipe sleeve ends



5230912

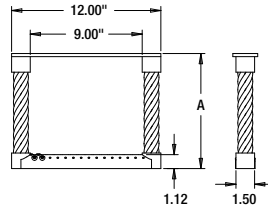

Part No.	Number of Rungs	Width (in.)	"A" Height (in.)	Depth (in.)	Step Thickness (in.)	Finish	Mounting Type	Wt. (lbs.)
5230912	1	12.00	9.00	1.38	1.88	Powder Coat	Bolt-On/Weld-On	7.67
5231212	1	12.00	12.00	1.38	1.88	Powder Coat	Bolt-On/Weld-On	8.98
5231512	1	12.00	15.00	1.38	1.88	Powder Coat	Bolt-On/Weld-On	10.07



5232417

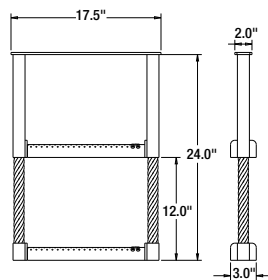

Part No.	Number of Rungs	Width (in.)	Height (in.)	Depth (in.)	Step Thickness (in.)	Finish	Mounting Type	Wt. (lbs.)
5232417	2	17.50	24.00	3.00	1.88	Powder Coat	Bolt-On/Weld-On	20.86



5231515

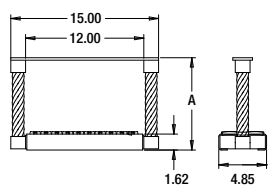

Part No.	Number of Rungs	Width (in.)	"A" Height (in.)	Depth (in.)	Step Thickness (in.)	Finish	Mounting Type	Wt. (lbs.)
5230915	1	15.00	9.00	4.75	1.88	Powder Coat	Bolt-On	11.5
5231515	1	15.00	15.00	4.75	1.88	Powder Coat	Bolt-On	11.8



5232216

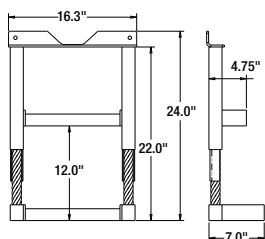

Part No.	Number of Rungs	Width (in.)	Height (in.)	Depth (in.)	Step Thickness (in.)	Finish	Mounting Type	Wt. (lbs.)
5232216	2	16.00	22.00	7.00	2.00	Powder Coat	Bolt-On	25.41

Steps and Tread

FIXED STEPS - continued

CLASS 8 ALUMINUM FRAME STEPS FOR SEMI TRUCKS **NEW**

- 4.75 in. grip strut steps provide anti-slip traction
- Universal design fits Peterbilt®, Kenworth®, International®, Freightliner®, Western-Star®, Volvo®, and Mack® trucks
- Aluminum construction with .188 in. thick mounts
- Universal 4-bolt mounting pattern is easy to install on most semi truck frames
- Mounting hardware included



5239012



5239024

Part No.	Width (in.)	Height (in.)	Depth (in.)	Step Thickness (in.)	Material	Mounting Type	Wt. (lbs.)
5239012	12.00	24.00	28.00	2.00	Aluminum	4-bolt	12.01
5239018	18.00	24.00	28.00	2.00	Aluminum	4-bolt	13.01
5239024	24.00	24.00	28.00	2.00	Aluminum	4-bolt	14.01

STEEL TRUCK STEP

- Perforated, 2 in. deep anti-slip metal grip steps
- 1/4 in. x 2 in. can be bolted or welded on to the vehicle



5232412



5233612

Part No.	Number of Rungs	Width (in.)	Height (in.)	Distance Between Rungs	Material	Finish	Mounting Type	Wt. (lbs.)
5232412	2	12.50	24.00	12.00	Carbon Steel	Powder Coat	Bolt-on or Weld-on	9
5233612	3	12.50	36.00	12.00	Carbon Steel	Powder Coat	Bolt-on or Weld-on	18.5

DIE CAST WELD-ON FOOT/GRAB STEP

- Weld on step is available in die cast aluminum or steel construction
- Step is reversible and includes molded treads for slip resistance



B2744A



B2744S

Part No.	Width (in.)	Height (in.)	Depth (in.)	Material	Finish	Color	Wt. (lbs.)
B2744A	7.750	1.639	4.125	Aluminum	Smooth	Silver	1.12
B2744S	7.75	1.693	4.125	Cast Steel	Smooth	Silver	3.2

POLYMER STEP

- The rotationally molded step is constructed from UV stable, high density polyethylene
- The lightweight step is easy to carry with its built-in handle
- Steps have a non-skid surface and are ideal for RVs, campers, and shop use
- The stackable design frees up valuable storage space



3013658

Part No.	Width (in.)	Height (in.)	Depth (in.)	Material	Finish	Color	Wt. (lbs.)
3013658	21.00	16.00	24.00	Polyethylene	Diamond Tread	Black	14.6



STEP TREAD AND ANTI SKID

STEEL GRIP STRUT

- Ideal for truck step construction, treads are available in plain or galvanized finish
- .125" Thick End Plates w/(2) .410" square carriage bolt holes
- 12 gauge steel
- Replacement step for 5231112



3012035



3013531

Part No.	Width (in.)	Depth (in.)	Height (in.)	Material	Material Finish	Wt. (lbs.)
3012035	12.00	4.75	2.00	Steel	Galvanized	4.35
3013531	12.00	4.75	2.00	Steel	Plain	4.35

ALUMINUM GRIP STRUT **NEW**

- .080 in. grating
- .125 in. end plates w/ .410 in. carriage bolt holes



3046249

Part No.	Width (in.)	Depth (in.)	Height (in.)	Material	Material Finish	Wt. (lbs.)
3046249	11.56	4.75	2.00	Aluminum	Plain	1.23
3046270	17.56	4.75	2.00	Aluminum	Plain	1.69
3046838	21.56	4.75	2.00	Aluminum	Plain	2.01
3046272	23.56	4.75	2.00	Aluminum	Plain	1.69
3046902	29.56	4.75	2.00	Aluminum	Plain	1.23
3046909	35.56	4.75	2.00	Aluminum	Plain	3.08
3059112	20.25	7.00	2.00	Aluminum	Plain	1.43
3059049	29.25	9.50	2.00	Aluminum	Plain	2.38

PERFORATED STEEL CHANNEL STEP GRIP

- Constructed from 13 gauge hot rolled steel
- 3-row perforated pattern



SG1501048



SG1501048 Detail

Part No.	Length (in.)	Width (in.)	Height (in.)	Material	Material Finish	Wt. (lbs.)
SG1501048	48.75	1.50	1.19	Steel	Plain	3.8

ANTI-SKID TAPE

- Black medium "46" grit surface improves traction and safety
- Ideal for bumpers, steps, or walkways
- Resistant to detergents & solvents
- Peel and stick for easy application to surfaces



AST215



AST60



AST460



AST660



AST624

Part No.	Description	Length (ft.)	Width (in.)	Quantity	Type	Wt. (lbs.)
AST215	Retail packaged, self adhesive 15 ft. x 2 in. roll	15.00	2.00	1	Roll	1
AST60	Individually boxed, self adhesive 60 ft. x 2 in. roll	60.00	2.00	1	Roll	3
AST460	Individually boxed, self adhesive 60 ft. x 4 in. roll	60.00	4.00	1	Roll	4.5
AST660	Individually boxed, self adhesive 60 ft. x 6 in. roll	60.00	6.00	1	Roll	7.5
AST624	Self adhesive 6 in. x 24 in. sheets (50 per box)	2.00	6.00	50 sheets	sheets	13

Grab Handles

CHROME-PLATED DIE-CAST ZINC GRAB HANDLE



B2399B2C

Part No.	Handle Length (in.)	Handle Dia (in.)	Handle Finish	Handle Material	Mounting Type	Wt. (lbs.)
B2399B2C	8.25	0.960	Chrome	Steel	Bolt On	0.75

CHROME-PLATED DIE CAST STEEL GRAB HANDLE



B2399B6C

Part No.	Handle Length (in.)	Handle Dia (in.)	Handle Finish	Handle Material	Mounting Type	Wt. (lbs.)
B2399B6C	5.94	0.500	Chrome	Steel	Bolt On	0.37

FORGED STEEL GRAB HANDLE



B2399A

Part No.	Handle Length (in.)	Handle Dia (in.)	Handle Finish	Handle Material	Mounting Type	Wt. (lbs.)
B2399A	9.50	0.625	Plain	Steel	Bolt On	1
B2399B	11.50	0.625	Plain	Steel	Bolt On	1.13
B2399C	13.50	0.625	Plain	Steel	Bolt On	1.28
B2399D	15.38	0.625	Plain	Steel	Bolt On	1.44
B2399W	13.25	0.500	Plain	Steel	Weld On	0.79

CHEST HANDLE

- Zinc-plated
- .055 in. mounting plate



B2344

Part No.	Handle Length (in.)	Height (in.)	Handle Finish	Handle Material	Mounting Type	Wt. (lbs.)
B2344	4.00	2.75	Zinc Plated	Carbon Steel	Bolt On	0.4



POLY-COATED GRAB HANDLE

- Comfort grip, poly-coated steel resists corrosion
- Hidden bolt design provides a clean installation finish



B239911P

Part No.	Handle Length (in.)	Handle Finish	Handle Material	Mounting Type	Wt. (lbs.)
B239911P	10.81	Multiple	Steel	Hidden Bolt On	0.6

SOLID ALUMINUM FLAT GRAB HANDLE

- Flat style handle has a bright, anodized finish



B239916AL

Part No.	Handle Length (in.)	Handle Finish	Handle Material	Mounting Type	Wt. (lbs.)
B239916AL	16.00	Anodized	Aluminum	Bolt On	0.55

SOLID ALUMINUM ROUND GRAB HANDLE



B239914AL

Part No.	Handle Length (in.)	Handle Dia (in.)	Handle Finish	Handle Material	Mounting Type	Wt. (lbs.)
B239914AL	13.00	0.500	Anodized	Aluminum	Bolt On	0.26
B239918AL	18.00	0.625	Anodized	Aluminum	Bolt On	0.5
3039855	15.81	0.625	Anodized	Aluminum	Bolt On	0.51

CHROME-PLATED SOLID STEEL GRAB HANDLE



B239918C

Part No.	Handle Length (in.)	Handle Dia (in.)	Handle Finish	Handle Material	Mounting Type	Wt. (lbs.)
B2399BC	11.50	0.625	Chrome	Carbon Steel	Bolt On	0.29
B239918C	13.25	0.500	Chrome	Carbon Steel	Bolt On	0.75
B239920C	16.00	0.500	Chrome	Carbon Steel	Bolt On	1
B239936C	36.00	0.625	Chrome	Carbon Steel	Bolt On	4

FUEL FILL DISH

- Universal fit
- 5.25 in. Bolt centers



FFD625SS



FFD626SS

Part No.	Dia. (in.)	Degree	Material	Finish	Wt. (lbs.)
FFD625SS	6.25	42°	304 Stainless Steel	Plain	1.00
FFD626SS	6.25	21°	304 Stainless Steel	Plain	0.56

Paddle Latches

PADDLE / SLAM LATCHES

TEAR DROP SINGLE-POINT ROTARY PADDLE LATCH

- Hidden studs help safeguard belongings
- Polished stainless steel construction



L3890RLS Front



L3890RLS Back

Part No.	Width (in.)	Height (in.)	Mount Width (in.)	Mount Height (in.)	Mount Type	Locking	Housing Finish	Housing Material	Wt. (lbs.)
L3890RLS	4.75	5.50	3.88	3.94	Stud	Yes	Polished	Stainless Steel	1.22

Accessories:

Part No.	Description	Wt. (lbs.)
3005833	Striker Plate/Bracket for L3890RLS	0.26
CH545	Key Only	0.02
L881XGO	Gasket	0.13

STANDARD SIZE RECTANGULAR PADDLE LATCH

- Locking and non-locking options available
- Standard size ideal for larger applications



L3885RLS Front



L3885RLS Back

Part No.	Width (in.)	Height (in.)	Mount Width (in.)	Mount Height (in.)	Mount Type	Locking	Housing Finish	Housing Material	Wt. (lbs.)
L3885RLS	4.25	5.50	3.69	3.75	Stud	Yes	Polished	Stainless Steel	1.43
L3885	4.25	5.50	3.70	3.75	Bolt-On	Yes	Polished	Stainless Steel	1.13
N3885	4.25	5.50	3.69	3.75	Bolt-On	No	Polished	Stainless Steel	1.13
L3980	4.25	4.75	3.70	3.75	Weld-On	Yes	Zinc Plated	Carbon Steel	1.13
N3980	4.25	5.50	3.25	4.25	Weld-On	No	Zinc Plated	Carbon Steel	1.13

Accessories:

Part No.	Description	Wt. (lbs.)
L38RLSCH545	Cylinder and Keys CH545 for L3885RLS	0.25
CH545	Key Only for L3885RLS	0.02
3002713	Striker Latch/Pin for L3885RLS	0.16
39LL71	Cylinder and Keys for L3885, L3980	0.10
LL71	Key Only for L3885, L3980	0.02

JUNIOR RECTANGULAR PADDLE LATCH

- Locking and non-locking options available
- Junior size ideal for medium sized applications



L1883 Front



L1883 Back

Part No.	Width (in.)	Height (in.)	Mount Width (in.)	Mount Height (in.)	Mount Type	Locking	Housing Finish	Housing Material	Wt. (lbs.)
L1883	3.63	4.75	3.00	3.20	Bolt-On	Yes	Polished	Stainless Steel	1
N1883	3.63	4.75	3.00	3.20	Bolt-On	No	Polished	Stainless Steel	1
L1980	3.63	4.75	3.00	3.20	Weld-On	Yes	Zinc Plated	Carbon Steel	1
N1980	3.63	4.75	3.00	3.20	Weld-On	No	Zinc Plated	Carbon Steel	1

Accessories:

Part No.	Description	Wt. (lbs.)
88CH545	Cylinder and Keys CH545 for L1883, L1980	0.16
CH545	Key Only for L1883, L1980	0.25

MINI TEAR DROP LATCH

- Locking and non-locking options available
- Mini size ideal for smaller applications



8000SSL Front



8000SSL Back

Part No.	Width (in.)	Height (in.)	Mount Width (in.)	Mount Height (in.)	Mount Type	Locking	Housing Finish	Housing Material	Wt. (lbs.)
8000SSL	3.25	4.38	3.06	2.87	Bolt-On	Yes	Polished	Stainless Steel	0.57
8000SSN	3.25	4.38	3.06	2.87	Bolt-On	No	Polished	Stainless Steel	0.55

Accessories:

Part No.	Description	Wt. (lbs.)
19CH545	Cylinder and Key for 8000SSL	0.09
CH510	Key Only for 8000SSL	0.02



T-Handle Latches

LOCKING, DIE CAST COMPRESSION LATCH

- Strong, secure compression operation
- Latch is secure and stays shut with the adjustable cam action roller engagement
- Corrosion resistant powder-coated housing

SINGLE POINT



LL9000 Front

LL9000 Back

Part No.	Width (in.)	Height (in.)	Mount Width (in.)	Mount Height (in.)	Mount Type	Locking	Housing Finish	Housing Material	Wt. (lbs.)
LL9000	5.88	6.00	3.88	3.94	Stud	Yes	Powder Coat	Die Cast Steel	2.04

Accessories:

Part No.	Description	Wt. (lbs.)
88CH545	Cylinder and Key Set	0.12
CH545	Key Only	0.02
3036319	Gasket	0.13

3-POINT

- Equipped with mounting studs for 3-point rods
- Rods sold separately



LL90003 Front

LL90003 Back

Part No.	Width (in.)	Height (in.)	Mount Width (in.)	Mount Height (in.)	Mount Type	Locking	Housing Finish	Housing Material	Wt. (lbs.)
LL90003	5.88	6.00	3.88	3.94	Stud	Yes	Powder Coat	Die Cast Steel	2.38

Accessories:

Part No.	Description	Wt. (lbs.)
88CH545	Cylinder and Key Set	0.12
CH545	Key Only	0.02
3036319	Gasket	0.13

RODS FOR LL90003

- Sold as singles



3024136

Part No.	Description	Wt. (lbs.)
3024136	7.6 Inch Rod for Die Cast 3-Point Compression Latch on an 18 Inch Truck Box	0.15
3024137	10.60 Inch Rod for Die Cast 3-Point Compression Latch on a 24 Inch Truck Box	0.23
3024138	13.6 Inch Rod for Die Cast 3-Point Compression Latch on a 30 Inch Truck Box	0.25
3024139	16.6 Inch Rod for Die Cast 3-Point Compression Latch on a 36 Inch Truck Box	1.1
3030564	22.6 Inch Rod for Die Cast 3-Point Compression Latch on a 48 Inch Truck Box	0.48
3031368	28.6 Inch Rod for Die Cast 3-Point Compression Latch on a 60 Inch Truck Box	0.01



17062603 shown

T-Handle Latches

LOCKING ZINC-PLATED, MOUNTING HOLES

- Cam adjusts from 1-1/4 in. to 2 in. to accommodate varying door thicknesses
- Zinc plated steel construction



L8915 Front

L8915 Back

Part No.	Width (in.)	Height (in.)	Mount Width (in.)	Mount Height (in.)	Mount Type	Locking	Housing Finish	Housing Material	Wt. (lbs.)
L8915	4.75	4.88	3.88	3.95	Bolt-On	Yes	Zinc Plated	Carbon Steel	1.26

Accessories:

Part No.	Description	Wt. (lbs.)
88CH545	Cylinder and Key Set	0.12
CH545	Key Only	0.02
L8815G0	Gasket	0.13

LOCKING STAINLESS STEEL, MOUNTING HOLES

- Cam adjusts from 1-1/4 in. to 2 in. to accommodate varying door thicknesses (except 2-point)
- Polished stainless steel construction
- 4 mounting holes

SINGLE POINT



L8815 Front

L8815 Back

Part No.	Width (in.)	Height (in.)	Mount Width (in.)	Mount Height (in.)	Mount Type	Locking	Housing Finish	Housing Material	Wt. (lbs.)
L8815	4.75	4.88	3.88	3.31	Bolt-On	Yes	Polished	Stainless Steel	1.5

Accessories:

Part No.	Description	Wt. (lbs.)
88CH545	Cylinder and Key Set	0.12
CH545	Key Only	0.02
L8815G0	Gasket	0.13

2-POINT

- Includes Latch, 34 in. rods and rod guides



L8825 Front

L8825 Back

Part No.	Width (in.)	Height (in.)	Mount Width (in.)	Mount Height (in.)	Mount Type	Locking	Housing Finish	Housing Material	Wt. (lbs.)
L8825	4.75	4.88	3.88	3.25	Bolt-On	Yes	Polished	Stainless Steel	4.17

Accessories:

Part No.	Description	Wt. (lbs.)
88CH545	Cylinder and Key Set	0.12
CH545	Key Only	0.02
L8815G0	Gasket	0.13
L882501	Latch Only	1.40
L882502	34in. Rods	0.04



3-POINT

- Includes Latch, 34 in. rods and rod guides



L8835 Front

L8835 Back

Part No.	Width (in.)	Height (in.)	Mount Width (in.)	Mount Height (in.)	Mount Type	Locking	Housing Finish	Housing Material	Wt. (lbs.)
L8835	4.75	4.88	3.88	3.38	Bolt-On	Yes	Polished	Stainless Steel	4.59

Accessories:

Part No.	Description	Wt. (lbs.)
88CH545	Cylinder and Key Set	0.12
CH545	Key Only	0.02
L8815G0	Gasket	0.13
L883501	Latch Only	1.45
L882502	34in. Rods	0.04



T-Handle Latches

LOCKING STAINLESS STEEL, BLIND STUDS

- Blind studs and included gasket make for a water-tight installation with no showing bolts
- Flush-mount
- Cam adjusts from 1-1/4 in. to 2 in. to accommodate varying door thicknesses

SINGLE POINT



L8855 Front

L8855 Back

Part No.	Width (in.)	Height (in.)	Mount Width (in.)	Mount Height (in.)	Mount Type	Locking	Housing Finish	Housing Material	Wt. (lbs.)
L8855	4.75	4.88	3.88	3.31	Stud	Yes	Polished	Stainless Steel	1.5

Accessories:

Part No.	Description	Wt. (lbs.)
88CH545	Cylinder and Key Set	0.12
CH545	Key Only	0.02
L8815G0	Gasket	0.13

SINGLE POINT, TALL PROFILE



L8816 Front

L8816 Back

Part No.	Width (in.)	Height (in.)	Mount Width (in.)	Mount Height (in.)	Mount Type	Locking	Housing Finish	Housing Material	Wt. (lbs.)
L8816	4.75	5.50	3.88	3.95	Stud	Yes	Polished	Stainless Steel	1.5

Accessories:

Part No.	Description	Wt. (lbs.)
88CH545	Cylinder and Key Set	0.12
CH545	Key Only	0.02
L881XG0	Gasket	0.13

SINGLE POINT, REPLACEMENT LATCH FOR POLY UNDERBODY TOOLBOXES

- Special rolling Cam, designed to work on Buyers Products polymer underbody truck boxes



L8816R Front

L8816R Back

Part No.	Width (in.)	Height (in.)	Mount Width (in.)	Mount Height (in.)	Mount Type	Locking	Housing Finish	Housing Material	Wt. (lbs.)
L8816R	4.75	5.50	3.88	3.95	Stud	Yes	Polished	Stainless Steel	1.43

Accessories:

Part No.	Description	Wt. (lbs.)
88CH545	Cylinder and Key Set	0.12
CH545	Key Only	0.02
L881XG0	Gasket	0.13

CYLINDERS AND KEYS



19CH545

888CH510

39LL71

L38RLSCH545

88CH545

Part No.	Description	Wt. (lbs.)
19CH545	Cylinder and Key	.09
888CH510	Cylinder Lock with Two Keys	.13
39LL71	Cylinder and Key	.09
L38RLSCH545	Cylinder for L3885RLS Latch	.25
88CH545	Cylinder and Keys for L1980, L8815, L8816, L8816R, L8825, L8835, L8855, L8915, LL9000, and LL9003	.25

ZINC-COATED DIE CAST CYLINDER DUST COVER



CDC01Z

Part No.	Material	Finish	For Use With	Wt. (lbs.)
CDC01Z	Die Cast	Zinc Plated	39LL71, 19CH545, L38RLSCH545, 88CH545, 88CH510	0.04

Spring Latches

1/2 INCH DIAMETER SPRING LATCH ASSEMBLY

- Ideal for doors, panels or gates
- Corrosion resistant zinc-plated steel or stainless steel construction
- Spring-loaded bolt can be locked in the open position
- Turning lever allows the bolt to close under spring pressure



B2595LKB



3009988



B2595LKB Application



B2575 Application

Part No.	Description	Keeper (y/n)	Handle Length (in.)	Bolt Length (in.)	Housing Length (in.)	Housing Height (in.)	Housing Width (in.)	Mount Type	Housing Material	Wt. (lbs.)
B2595LKB	1/2" Latch Assembly with Keeper	Yes	3.875	1.03	3.00	1.75	1.75	Bolt-On	Carbon Steel	1.25
06035	1/2" Latch Assembly with Keeper	Yes	3.875	1.03	3.00	1.75	1.75	Bolt-On	Carbon Steel	1.14
B2595	1/2" Latch Assembly, 5.19"L x 1.75"W	No	3.875	1.375	3.00	1.75	3.00	Bolt-On	Carbon Steel	0.94
B2595SH	1/2" Latch Assembly with short handle, 5.19"L x 1.75"W	No	2.375	1.00	3.00	1.75	1.75	Bolt-On	Carbon Steel	0.85
B2575	1/2" Latch Assembly, 6.5"L x 1.56"W	No	1.375	1.03	3.00	1.75	1.75	Bolt-On	Carbon Steel	0.82
3009988	1/2" Latch Assembly, 8.38"L x 2.75"W	No	1.50	1.25	3.50	2.75	2.75	Bolt-On	Stainless Steel	0.97

Accessories:

Part No.	Description	Wt.(lbs.)
B2595KZ	1/2 Inch Zinc Plated Keeper Only - 1.75 x 1.75 Inch	0.14

HEAVY DUTY 3/4 INCH DIAMETER SPRING LATCH ASSEMBLY

- Ideal for doors, panels or gates
- Corrosion resistant zinc-plated steel or stainless steel construction
- Spring-loaded bolt can be locked in the open position
- Turning lever allows the bolt to close under spring pressure



B2596LKB

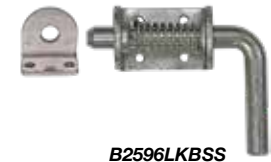

B2596LKBSS

Part No.	Description	Keeper (y/n)	Handle Length (in.)	Bolt Length (in.)	Housing Length (in.)	Housing Height (in.)	Housing Width (in.)	Mount Type	Housing Material	Wt. (lbs.)
B2596LKB	3/4" Latch Assembly with Keeper	Yes	3.5	6.00	3.25	2.00	2.00	Bolt-On	Carbon Steel	2.8
B2596	3/4" Latch Assembly, 5.91"L x 2.09"W	No	3.5	6.00	3.25	2.00	2.00	Bolt-On	Carbon Steel	2.04
B2596LKBSS	3/4" Latch Assembly with Keeper, Stainless	Yes	3.5	6.00	3.25	2.00	2.00	Bolt-On	Stainless Steel	2.7
B2596SS	3/4" Latch Assembly, 5.91"L x 2.09"W	No	3.5	6.00	3.25	2.00	2.00	Bolt-On	Stainless Steel	2.05

Accessories:

Part No.	Description	Wt.(lbs.)
B2596KSS	Keeper for B2596SS	0.5
B2596KZ	Keeper for B2596	0.4

1/2 INCH QUICK RELEASE SPRING LATCH

- Spring-loaded handle
- Zinc-plated bolt and housing with stainless steel spring
- Bolt-on installation
- B2590KZ sold separately



B2590LH



B2590RH



B2590KZ

Part No.	Description	Keeper (y/n)	Handle Length (in.)	Bolt Length (in.)	Housing Length (in.)	Housing Width (in.)	Mount Type	Housing Material	Wt. (lbs.)
B2590LH	1/2" Latch Assembly, Left Hand, 6.09"L x 1.69"W	No	2.75	4.69	6.09	2.66	Bolt-On	Carbon Steel	0.81
B2590RH	1/2" Latch Assembly, Right Hand, 6.09"L x 1.69"W	No	2.75	4.69	6.09	2.66	Bolt-On	Carbon Steel	0.81

Accessories:

Part No.	Description	Wt.(lbs.)
B2590KZ	90 Degree Stake Body Spring Latch Keeper for B2590LH/RH	0.4



HEAVY DUTY SPRING LATCH ASSEMBLY WITH LOOPED HANDLE **NEW**

- Ideal where doors, compartments, or panels need to engage and disengage quickly and securely
- Corrosion resistant zinc-plated steel or stainless steel construction
- Spring-loaded bolt can be locked in the open position
- Turning lever allows the bolt to close under spring pressure



B2600



B2600LK



B2600SS



B2600LKSS

Part No.	Keeper (y/n)	Bolt Dia. (in.)	Bolt Length (in.)	Housing Length (in.)	Housing Height (in.)	Housing Width (in.)	Mount Type	Housing Material	Housing Finish	Wt. (lbs.)
B2600	No	0.44	7.50	3.26	1.50	1.50	Bolt-On	Steel	Zinc Plated	0.93
B2600LK	Yes	0.44	7.50	3.26	1.50	1.50	Bolt-On	Steel	Zinc Plated	1.09
B2600SS	No	0.44	7.50	3.26	1.50	1.50	Bolt-On	Stainless Steel	Plain	0.93
B2600LKSS	Yes	0.44	7.50	3.26	1.50	1.50	Bolt-On	Stainless Steel	Plain	1.09

WELD-ON SPRING LATCH

- Stainless steel spring and pin
- Spring-loaded bolt can be locked in the open position
- Carbon steel or stainless steel housing
- Can be ordered unassembled (B2598HU)



B2598H



B2598HU



B2598SSC



B2598SSC Application

Part No.	Keeper (y/n)	Bolt Dia. (in.)	Bolt Length (in.)	Housing Length (in.)	Housing Height (in.)	Housing Width (in.)	Mount Type	Housing Material	Housing Finish	Wt. (lbs.)
B2598H	No	0.62	.84	2.00	1.25	1.50	Weld-On	Carbon Steel	Plain	0.7
B2598HU	No	0.62	.84	2.00	1.25	1.50	Weld-On	Carbon Steel	Plain	0.7
B2598SSC	No	0.62	.84	2.00	1.25	1.50	Weld-On	Stainless Steel	Plain	0.74
B2598LP	No	0.62	1.31	2.00	1.25	1.50	Weld-On	Carbon Steel	Plain	1

STAKE BODY SPRING LATCH

- Spring-loaded bolt can be locked into open position
- Available for left or right hand operation



B2599LH

Part No.	Desc.	Keeper (y/n)	Bolt Dia. (in.)	Bolt Length (in.)	Housing Length (in.)	Housing Height (in.)	Housing Width (in.)	Mount Type	Housing Material	Housing Finish	Wt. (lbs.)
B2599RH	Right Hand	No	0.49	0.70	2.27	1.60	1.69	Weld-On	Carbon Steel	Plain	0.75
B2599LH	Left Hand	No	0.49	0.70	2.27	1.60	1.69	Weld-On	Carbon Steel	Plain	0.75

Spring Latches

SNAP LOCK LATCH

- Zinc-plated
- 1/2 in. square plunger



B2586

Part No.	Keeper (y/n)	Bolt Dia. (in.)	Bolt Length (in.)	Housing Length (in.)	Housing Height (in.)	Housing Width (in.)	Mount Type	Housing Material	Housing Finish	Wt. (lbs.)
B2586	No	0.50	0.63	2.87	1.04	2.03	Bolt-On	Carbon Steel	Zinc Plated	0.81

SLAM BOLT LATCH

- Powder-coated bolt
- Zinc-plated steel construction provides strength and durability
- Ideal for 2 and 3 point latch applications
- Finger pull w/ manual release



90M

Part No.	Keeper (y/n)	Bolt Length (in.)	Housing Length (in.)	Housing Width (in.)	Mount Type	Housing Material	Housing Finish	Wt. (lbs.)
90M	No	5.25	5.50	2.00	Bolt-On	Carbon Steel	Zinc Plated	0.49

TIPPER LATCH

- Durable, corrosion resistant zinc-plated steel construction
- Pre-assembled for immediate use



TL382

Part No.	Keeper (y/n)	Bolt Dia. (in.)	Bolt Length (in.)	Housing Length (in.)	Housing Height (in.)	Housing Width (in.)	Mount Type	Housing Material	Housing Finish	Wt. (lbs.)
TL382	No	0.75	1.28	1.94	2.25	2.00	Weld-On	Carbon Steel	Plain	1.5

CAMLOCK / TWIST LOCK PLUNGER PIN

- Locks securely with spring loaded pin and rotating handle
- Each pin includes a grease fitting and is zinc-plated for corrosion protection
- Ideal for farm equipment, wrecker attachments and more
- Weld-on



TLP750

Part No.	Pin Dia. (in.)	Outside Dia. (in.)	Length (in.)	Wt. (lbs.)
TLP625	5/8	1-1/8	3-1/8	1
TLP750	3/4	1-1/4	3-1/8	1
TLP100	1.0	1-3/8	3-1/2	2



Draw Latches

HEAVY DUTY ADJUSTABLE DRAW LATCH

- Rubber dipped handle (WJ225R)
- Zinc-plated steel for corrosion resistance
- Hook and keeper sold separately



WJ225



WJ225R



3013332 (sold separately)

Part No.	Length (in.)	Width (in.)	Material	Finish	Latch Style	Wt. (lbs.)
WJ225	8.75	1.5	Carbon Steel	Zinc Plated	Draw Latch	0.78
WJ225R	8.75	1.00	Carbon Steel	Zinc Plated	Draw Latch	0.01

Accessories:

Part No.	Description	Wt.(lbs.)
3013332	Utility Hook - 1-1/2 x 2 Inch - Zinc Plated	0.12

PADLOCK EYE DRAW LATCH

- Zinc-plated steel for corrosion resistance
- Catch complete with striker and mounting holes
- Provisions for padlock



BHC207Z



BHC227Z

Part No.	Length (in.)	Width (in.)	Material	Finish	Latch Style	Stiker or Bracket Included (y/n)	Wt. (lbs.)
BHC207Z	4.00	1.00	Carbon Steel	Zinc Plated	Steel Hood Latch	Yes	0.18
BHC227Z	2.463	1.665	Carbon Steel	Zinc Plated	Steel Hood Latch	Yes	0.15

HOOK STYLE DRAW LATCH

- Zinc-plated steel for corrosion resistance
- Ideal for general purpose applications and replacement
- Toggle action



BHC801Z

Part No.	Length (in.)	Width (in.)	Material	Finish	Latch Style	Stiker or Bracket Included (y/n)	Wt. (lbs.)
BHC801Z	3.69	1.87	Carbon Steel	Zinc Plated	Steel Hood Latch	No	0.15

ADJUSTABLE DRAW LATCH **NEW**

- Stainless steel
- Adjusts easily by turning latch
- Provisions for padlock
- The overall length listed includes the strike plate and is measured with the latch extended to maximum latching distance



3049352

Part No.	Length (in.)	Width (in.)	Material	Finish	Latch Style	Stiker or Bracket Included (y/n)	Wt. (lbs.)
3049352	6.625 - 7.375	1.60	Stainless Steel	Smooth	Draw Latch	Yes	0.52

Hood Latches

RUBBER HOOD LATCH WITH METAL KEEPER AND BRACKET

- Optional brackets and pins for easy installation



WJ205



WJ205 Application



WJ206



WJ206 Side View



WJ208

Part No.	Qty	Latch Length (in.)	Handle Width (in.)	Latch Style	Latch Material	Bracket Material	Keeper Included (y/n)	Wt. (lbs.)
WJ205	1	6.00	3-1/2	T-Handle	Rubber	Carbon Steel	Yes - A	0.43
WJ206	1	6.00	3-1/2	T-Handle	Rubber	Carbon Steel	Yes - A	0.5
03020	1	6.00	3-1/2	T-Handle	Rubber	Carbon Steel	Yes - A	0.67
WJ208	1	7-7/8	2-2/5	T-Handle	Rubber	Carbon Steel	Yes - A	0.5
03025	1	7-7/8	2-2/5	T-Handle	Rubber	Carbon Steel	Yes - A	0.72

Accessories:

Part No.	Description	Wt. (lbs.)
WJ205R0	Replacement Handle for WJ205	0.25

RUBBER/POLYMER DRAW LATCH



WJ211



WJ212



WJ213



WJ215

Part No.	Description	Qty	Latch Length (in.)	Handle Width (in.)	Latch Style	Latch Material	Bracket Material	Keeper Included (y/n)	Wt. (lbs.)
WJ211*	12" Rubber/Poly Latch <i>Compares to Standard Navistar®</i>	1	12.00	1-3/4	Hood Latch	Rubber	Polymer	Yes	0.5
WJ212	9" Rubber/Poly Latch <i>Compares to Southco® 37-30-294-60</i>	1	9.00	2.00	Hood Latch	Rubber/Polymer	Polymer	Yes	0.5
WJ213	13.25" Rubber/Poly Latch <i>Compares to Southco® 37-30-295-60</i>	1	13-1/4	2.00	Hood Catch	Rubber/Polymer	Polymer	Yes	0.5
WJ215	4.25" Rubber/Poly Latch	1	4-1/4	2.00	T-Handle	Rubber/Polymer	Polymer	Yes	0.25

SPRING-LOADED HOOD LATCH

- 90° elbow at base of handle allows handle and bracket to be mounted on same plane
- Black enamel finish for corrosion resistance
- Includes hooking bracket and mounting hardware for easy installation



WJ96WCB

Part No.	Qty	Latch Length (in.)	Handle Width (in.)	Latch Style	Latch Material	Bracket Material	Keeper Included (y/n)	Hardware Included (y/n)	Wt. (lbs.)
WJ96WCB	1	4.00	2-2/5	Spring Latch	Carbon Steel	Carbon Steel	Yes	Yes	0.31



T-TYPE LOCKING DOOR HANDLE

- Chrome plated handle rotates full 360°
- Shaft is standard 5/16 in. sq. x 4-3/16 in. L
- 1-1/2 in. C-C mounting holes
- Can be locked in 4 positions spaced 90° apart



B2392L

Part No.	Handle Length (in.)	Shaft Length (in.)	Shaft Width (in.)	Built in Lock (y/n)	Mounting Type	Handle Material	Handle Finish	Wt. (lbs.)
B2392L	3.88	4.19	0.31	Yes	Bolt On	Carbon Steel	Chrome	0.63
 04010	3.88	4.19	0.31	Yes	Bolt On	Carbon Steel	Chrome	0.64

L-TYPE LOCKING DOOR HANDLE

- Chrome plated handle rotates full 360°
- Shaft is standard 5/16 in. sq. x 2-11/16 in. L
- 1-1/2 in. C-C mounting holes
- Can be locked in 4 positions spaced 90° apart



B2394L

Part No.	Handle Length (in.)	Shaft Length (in.)	Shaft Width (in.)	Built in Lock (y/n)	Mounting Type	Handle Material	Handle Finish	Wt. (lbs.)
B2394L	3.50	2.69	0.31	Yes	Bolt On	Carbon Steel	Chrome	0.5

SINGLE POINT CAM

- Zinc die-cast
- Secures to 5/16 in. shaft
- For use with B2392L & B2394L
- Complete with set screw



B239CZ

Part No.	Length (in.)	Width (in.)	Mounting Type	Wt. (lbs.)
B239CZ	2.00	.75	Set Screw	0.08

Locks, Levers

HEAVY DUTY SECURITY LOCK AND HASP

- Cylindrical lock provides maximum protection
- Chrome-plated steel lock with two keys
- Packaged for retail display



SL100

Part No.	Length (in.)	Width (in.)	Material	Finish	Wt. (lbs.)
 SL100	9.00	4.50	Carbon Steel	Chrome	2.2

HEAVY DUTY SECURITY HASP

- Fasteners includes
- For use with SL100

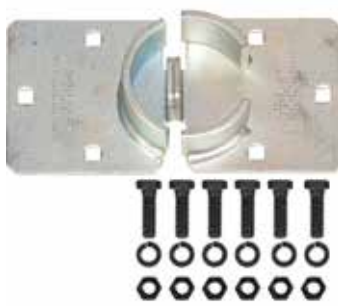

SLH100

Part No.	Length (in.)	Width (in.)	Material	Finish	Wt. (lbs.)
 SLH100	9.00	4.50	Carbon Steel	Zinc Plated	3.79

FORGE LEVER NUT

- Lever is offset 1-1/2 in.



B575A

Part No.	Length - Hole to		Size Thread (N.C.)	Material	Finish	Wt. (lbs.)
	End (in.)	Round (in.)				
B575A	3.75	.375	3/8-16	Forged Steel	Plain	0.24
B575CZ	4.00	.4375	1/2-13	Forged Steel	Zinc Plated	0.29
B575GZ	6.00	.625	3/4-10	Forged Steel	Zinc Plated	0.73

CAST IRON WING STYLE CLAMP HANDLE

- 5/8-11 full thread cast iron
- Ideal for securing doors, chutes and tailgates using a 5/8-11 rod
- Zinc plated



WN5811Z

Part No.	Length - Hole to		For Use With	Material	Finish	Wt. (lbs.)
	(in.)					
WN5811Z	5.50		5/8-11 Threaded Rod	Cast Iron	Zinc Plated	0.70

FORGED ROD END

- 5/8-11 x 6in. forged end rod (4-1/2in. of thread)
- 5/8 in. PH
- Zinc plated



B575A

Part No.	Outer Eye		Eye Opening (in.)	Bolt Shaft Diameter (in.)	Bolt Shaft Length (in.)	Wt. (lbs.)
	Diameter (in.)	Thread Stocked				
B27027EKZ	1.250	5/8-11	0.688	.625	6.000	0.52



UNIVERSAL ALUMINUM CAM-ACTION LOCK KIT **NEW**

- Kit contains aluminum 2 cams and 2 keepers, 4 rod guides, 1 a plastic-coated handle, and 1 hasp that allows for the use of a padlock
- Aluminum pipe (3/4 in. SCH40) is not included



3052380



3052380 Hardware



3052380 Application

Part No.	Built in Lock (y/n)	Mounting Type	Handle Material	Wt. (lbs.)
3052380	No	Bolt On	Aluminum	3.31

STEEL TRAILER DOOR CAM-ACTION LOCK KIT

- Kit contains 2 cast steel cups, 2 lugs, 1 steel handle (13 in.) & 8 supports
- Steel pipe (3/4 in. SCH40) not included

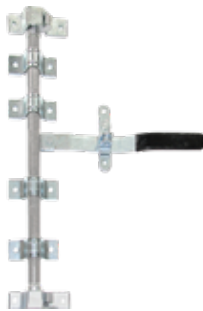

B2159C



B2159C Hardware



B215805 - Cam Lock Hasp



B215806 - Cam Lock Handle

Part No.	Handle Length (in.)	Built in Lock (y/n)	Mounting Type	Handle Material	Handle Finish	Wt. (lbs.)
B2159C	13.73	No	Bolt On	Cast Steel	Zinc Plated Clear	6.16

Accessories:

Part No.	Description	Wt. (lbs.)
B215805	Zinc Plated Cam Lock Hasp	0.44
B215806	Cam Lock Handle Assembly	1.43

BOX VAN CORNER IRON

- Drop-forged construction
- Reinforces box van and enclosed trailer body corners
- Weld-on



B2487B

Part No.	Length (in.)	Width (in.)	Depth (in.)	Material	Finish	Color	Wt. (lbs.)
B2487B	8.00	1.50	6.00	Carbon Steel	Plain	None	2.7
B2485AA	12.00	1.50	12.00	Carbon Steel	Plain	None	4.52



Welds to top inside corners of box vans/trailer bodies to reduce stress, and prevent cracking from inside.

Door and Body Hardware

DOOR CHECKS AND PROPS

DOOR CHECK AND HOLD BACK

- Operates on doors with vertical or horizontal hinges
- The spring assisted slide passes over the center of the check to hold the door open at 90°
- Zinc-plated for corrosion resistance
- Spring releases automatically and closes door with a slight push



BH2395AA11

Part No.	Arm Length (in.)	Retracted Length (in.)	Extended Length (in.)	Style	Spring Strength (lbs)	Keeper Included (y/n)	Material	Finish	Wt. (lbs.)
BM2395AA11	11.00	3.55	6.84	Door Check/ Hold Back	30	No	Carbon Steel	Zinc Plated	1.69
BH2395AA11	11.00	3.55	6.84	Door Check/ Hold Back	50	No	Carbon Steel	Zinc Plated	1.87

TELESCOPING DOOR AND LID PROP

- Automatically locks for safety, then unlocks when extended slightly in up position
- Sturdy mounting clamps for easy installation
- All-steel construction
- Zinc-plated for corrosion resistance



DP100



102406002

Part No.	Retracted Length (in.)	Extended Length (in.)	Style	Mounting Feet	Material	Finish	Wt. (lbs.)
DP100	13.13	21.00	Telescoping Door & Lid Prop	2	Carbon Steel	Zinc Plated	1.1
102406002	13.25	18.50	Telescoping Door & Lid Prop	1	Carbon Steel	Zinc Plated	0.9

ALUMINUM HOOK AND KEEPER DOOR HOLD BACK

- Heavy duty die cast aluminum construction
- Available in 2 in. or 4 in. lengths
- Keeper has spring loaded latch mechanism (DH300 / DH304)

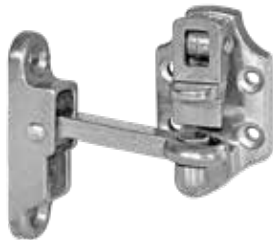

DH300



DH304



DH305

Part No.	Arm Length (in.)	Style	Keeper Included (y/n)	Material	Finish	Wt. (lbs.)
DH300	2.00	Door Hold Back	Yes	Aluminum	Natural	0.3
DH304	4.00	Door Hold Back	Yes	Aluminum	Natural	0.29
DH305	4.00	Dual Axis Pivot	Yes	Aluminum	Natural	0.39



DOOR CHECKS AND PROPS - continued

HOOK AND KEEPER DOOR HOLD BACK



Part No.	Hook Length (in.)	Keeper Included (y/n)	Material	Finish	Wt. (lbs.)
DH500	4.00	Yes	Carbon Steel	Zinc Plated	0.5
DH500SS	4.00	Yes	Stainless Steel	Plain	0.36
DH5006	6.00	Yes	Carbon Steel	Zinc Plated	0.39
DH5006SS	6.00	Yes	Stainless Steel	Plain	0.38

Accessories:

Part No.	Description	Wt. (lbs.)
DH501	4 Inch Door Hold Back, Hook Only - Zinc Plated	0.25
DH502	4 Inch Door Hold Back, Keeper Only - Zinc Plated	0.25

GAS SPRINGS

- Dampened extension
- Undampened compression
- Black powder-coat cylinder for corrosion resistance
- 3008745 ball stud sold separately (**except for 3028786**)
- Commonly used as door prop and positioner



3008786



3008745

Part No.	Extended Length (in.)	Compressed Length (in.)	Stroke	Rod Diameter (mm)	Cylinder Diameter (mm)	Ball Socket Diameter (mm)	Force Rating (lbs)	Ball Stud Included	Wt. (lbs.)
3045508	12.00	8.00	4.00	6.00	15.00	10.00	40	N	0.43
3045512	12.00	8.00	4.00	6.00	15.00	10.00	60	N	0.27
3045514	12.00	8.00	4.00	6.00	15.00	10.00	80	N	0.42
3028786	13.93	8.50	5.50	8.00	18.00	10.00	35	Y	0.51
3040770	17.10	10.80	6.30	8.00	18.00	10.00	97	N	0.74
3023460	19.63	11.63	8.00	9.98	21.59	10.00	250	N	0.85

Accessories:

Part No.	Description	Wt. (lbs.)
3008745	10 MM Ball Stud w/ 5/16-18 in. Threaded Stud - Zinc Plated	0.03
FNE031018034	5/16-18 Nylock Nut for 3008745 Ball Stud	0.01

Pins

LINCH AND SNAPPER PINS

LINCH PINS

- Yellow zinc-plated finish for corrosion resistance
- Packaged parts are two pieces per clam shell (66004)

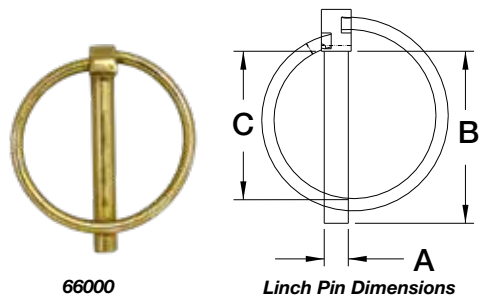

Part No.	(A) in.	(B) in.	(C) in.	Material	Finish	Wt. (lbs.)
66000	.25	1.75	1.51	Carbon Steel	Zinc Plated Yellow	0.05
66003	.19	1.38	1.10	Carbon Steel	Zinc Plated Yellow	0.02
66004	.19	1.38	1.10	Carbon Steel	Zinc Plated Yellow	0.08
66006	.31	1.75	1.50	Carbon Steel	Zinc Plated Yellow	0.06
66010	.44	1.75	1.50	Carbon Steel	Zinc Plated Yellow	0.11
66015	.44	1.97	1.50	Carbon Steel	Zinc Plated Yellow	0.13

SNAPPER PINS

- Yellow zinc-plated for corrosion resistance
- Packaged parts are two pieces per clam shell
- 3034842 comes with 12 in. chain



Part No.	A. Pin Dia (in.)	B. Usable Length (in.)	C. Clearance (in.)	D. Pin Length (in.)	Wt. (lbs.)
66045	3/16	1-5/8	1-5/8	1-13/16	0.05
66050	1/4	1-13/16	1-1/2	2	0.07
66051	1/4	1-13/16	1-1/2	2	0.18
66053	5/16	2-19/32	1-5/8	2-25/32	0.11
66054	5/16	2-19/32	1-5/8	2-25/32	0.26
66056	3/8	1-17/32	1-17/32	1-5/8	0.1
66060	3/8	2-11/32	1-1/2	2-1/2	0.13
66061	3/8	2-11/32	1-1/2	2-1/2	0.3
66063	1/4	2-1/2	1-3/4	2-49/64	0.09
66064	1/4	2-1/2	1-3/4	2-49/64	0.20
66066	1/4	3	1-1/2	3-1/4	0.11
66067	1/4	3	1-1/2	3-1/4	0.22
66070	1/4	3-5/8	1-1/2	3-3/4	0.1
66073	1/2	2-1/2	2-1/2	1-1/2	0.26
3034842	1/4	3-1/2	3-1/2	1-1/2	0.1

HITCH PINS

WITH POLY-COATED HANDLE

- Constructed from SAE AISI 1541 rated steel, 20 Rc
- Silver powder-coat steel pin shank
- Blue poly-coat handle
- Includes cotter pin

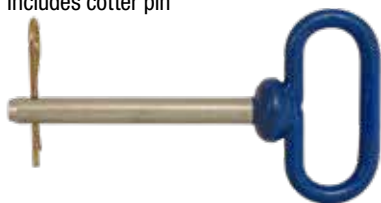

66101

Part No.	Pin Dia. (in.)	Usable Length (in.)	Includes Cotter Pin (Y/N)	Wt. (lbs.)
66101	1/2	4.0	Y	0.58
66107	5/8	4.0	Y	0.77
66111	3/4	4-1/2	Y	1.13
66122	1.0	4-1/2	Y	1.42
66127	7/8	4-1/2	Y	1.7

ZINC-PLATED

- Forged from 1040 steel
- Yellow zinc-plating for corrosion resistance
- Wire formed handle
- Includes cotter pin

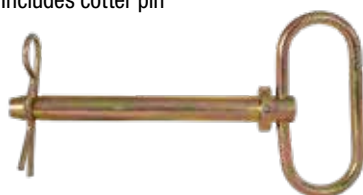

66100

Part No.	Pin Dia. (in.)	Usable Length (in.)	Includes Cotter Pin (Y/N)	Wt. (lbs.)
66100	1/2	4-1/4	Y	0.46
66102	9/16	2-3/4	Y	0.48
66103	5/8	4-1/4	Y	0.64
66105	5/8	6-1/4	Y	0.8
66110	3/4	4-1/4	Y	0.87
66115	3/4	6-1/4	Y	1.12
66120	7/8	6-1/4	Y	1.47
66125	1.0	6-1/4	Y	1.87
66130	1-1/8	6-1/4	Y	2.34
66135	1-1/4	7.0	Y	3.26

ZINC-PLATED WITH LINCH PIN AND CHAIN

- Forged from 1040 steel
- Yellow zinc plated for corrosion protection
- .25 in. linch pin included with chain
- Wire formed handle



66141

Part No.	Pin Dia. (in.)	Usable Length (in.)	Wt. (lbs.)
66141	5/8	4-1/4	1
66142	3/4	6-1/4	1

ZINC-PLATED WITH WIRE-FORMED HANDLE

- Forged from 1040 steel
- Yellow zinc-plating for corrosion resistance
- Wire formed handle
- Includes cotter pin



66128

66160

Part No.	Pin Dia. (in.)	Usable Length (in.)	Includes Cotter Pin (Y/N)	Wt. (lbs.)
66128	1.0	4-1/2	Y	1.43
66129	1.0	9-1/2	Y	2.58
66150	1-1/4	2-3/4	Y	1.74
66155	1-1/4	4-1/8	Y	2.15
66160	1-1/4	7-1/4	Y	3.27
66170	1-1/4	9-7/8	Y	4.12

REPLACEMENT COTTER PIN

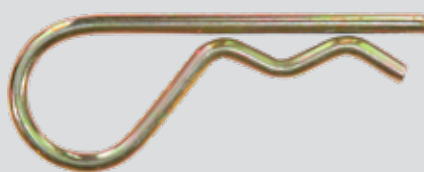

HP9

Part No.	Wire Diameter (in.)	Length (in.)	Material	Finish	Wt. (lbs.)
HP9	3/32	2.00	Carbon Steel	Zinc Plated Clear	0.01
HP10	1/8	2.38	Carbon Steel	Zinc Plated Clear	0.04
HP11	5/8	2.80	Carbon Steel	Zinc Plated Clear	0.05
HP12	5/32	3.00	Carbon Steel	Zinc Plated Yellow	0.07
HP13	3/16	4-1/5	Carbon Steel	Zinc Plated Clear	0.07

Pins

ROD END YOKES AND PINS

CLEVIS ROD END YOKE WITH PIN AND COTTER PIN

- Clear zinc-plated for corrosion resistance



B27086ANFZKT

Part No.	Base to Hole Center (in.)	Neck Dia. (in.)	Height of Yoke Arm (in.)	Center Hole to Neck (in.)	Inner Arm to Arm (in.)	Width (in.)	Hole Dia. (in.)	Neck Length (in.)	Clevis Pin Hole Dia. (in.)	Thread Size (in.)	Clevis Pin Incl. (y/n)	Wt. (lbs.)
B27081AZKT	1.563	0.313	0.313	1.000	0.188	0.438	0.188	0.563	0.375	3/16-32	Yes	0.04
B27082AZKT	2.000	0.438	0.438	1.250	0.281	0.625	0.250	0.750	0.500	1/4-28	Yes	0.09
B27083AZKT	2.250	0.500	0.500	1.438	0.344	0.750	0.313	0.813	0.594	5/16-24	Yes	0.13
B27083A14ZKT	2.250	0.500	0.500	1.438	0.344	0.750	0.313	0.813	0.594	1/4-28	Yes	0.14
B27084AZKT	2.500	0.625	0.625	1.625	0.438	0.875	0.375	0.875	0.688	3/8-24	Yes	0.22
B27084A14ZKT	2.500	0.625	0.625	1.625	0.438	0.875	0.375	0.875	0.688	1/4-28	Yes	0.23
B27084A56ZKT	2.500	0.625	0.625	1.625	0.438	0.875	0.375	0.875	0.688	5/16-24	Yes	0.22
B27086A56ZKT	3.000	0.813	0.813	1.875	0.563	1.125	0.500	1.125	0.938	5/16-24	Yes	0.44
B27086A38ZKT	3.000	0.813	0.813	1.875	0.563	1.125	0.500	1.125	0.938	3/8-24	Yes	0.44
B27086ANFZKT	3.000	0.813	0.813	1.875	0.563	1.125	0.500	1.125	0.938	1/2-20	Yes	0.44
B27087CKT	1.903	0.844	0.847	1.250	0.594	1.281	0.500	0.563	0.969	5/8-18	Yes	0.37

CLEVIS PIN

- SAE Standard

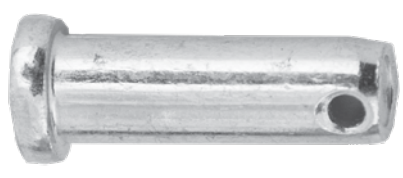

B27081/23AZ

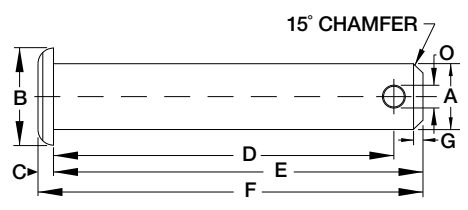

Part No.	Finish	A	B	C	D (Min.)	E	F	G	(O) Drill No.	Wt. (lbs.)
B27081/22AZ	Zinc Plated Clear	0.250	0.375	0.094	0.672	0.797	0.891	0.063	49 (.073)	0.01
B27081/23AZ	Zinc Plated Clear	0.313	0.438	0.094	0.813	0.969	1.063	0.078	38 (.101)	0.02
B27081/24AZ	Zinc Plated Clear	0.375	0.500	0.125	0.938	1.094	1.219	0.078	38 (.101)	0.04
B27081/26AZ	Zinc Plated Clear	0.500	0.625	0.156	1.203	1.359	1.540	0.109	29 (.136)	0.09
B27081/26C	Zinc Plated Clear	0.500	0.625	0.156	1.766	1.984	2.141	0.109	29 (.136)	0.12
B27081/26D	Zinc Plated Yellow	0.500	0.625	0.156	1.982	2.203	2.359	0.109	29 (.136)	0.14
B27081/27AZ	Zinc Plated Clear	0.625	0.813	0.203	1.469	1.719	1.922	.109	29 (.136)	0.17
B27081/27BZ	Zinc Plated Clear	0.500	0.625	0.156	1.562	1.781	1.983	0.109	29 (.136)	0.09
B27081/27C	Zinc Plated Yellow	0.500	0.625	0.156	1.344	1.563	1.750	0.156	29 (.136)	0.09
B27081/28AZ	Zinc Plated Clear	0.750	0.938	0.250	1.750	2.047	2.297	0.156	19 (.166)	0.30
B27081/210C	Zinc Plated Clear	0.625	0.813	0.188	1.625	1.750	1.953	0.062	29 (.136)	0.18
3007113	Zinc Plated Clear	0.313	0.438	0.094	2.364	2.510	2.750	.143	29 (.136)	0.06

INSPECTION DOORS

SERVICEABLE **NEW**

- Bolt-on design for ease of service
- Adjustable door travel clevis & door linkage
- Bolt on cast iron door handle interchanges for left or right hand operation



CCD0815



CCD0815SS



CCD1415



CCD1415SS

Part No.	For Dump Truck (class)	Overall Width (in.)	Overall Height (in.)	Door Opening Width (in.)	Door Opening Height (in.)	Material	Wt. (lbs.)
CCD0815	1-Ton to Super Duty	20.59	16.44	14.00	7.17	Carbon Steel	47.46
CCD0815SS	1-Ton to Super Duty	20.59	16.44	14.00	7.17	304 Stainless Steel	48.68
CCD1415	Medium & Heavy Duty	20.59	28.44	14.00	13.17	Carbon Steel	68.49
CCD1415SS	Medium & Heavy Duty	20.59	28.44	14.00	13.17	304 Stainless Steel	70.32

STANDARD

- Designed to be welded into dump body tailgates
- Adjustable door travel clevis & door linkage
- Bolt on cast iron door handle interchanges for left or right hand operation



CCD0714



CCD1314



CCD1314

Part No.	For Dump Truck (class)	Overall Width (in.)	Overall Height (in.)	Door Opening Width (in.)	Door Opening Height (in.)	Material	Wt. (lbs.)
CCD0714	1-Ton to Super Duty	17.15	11.75	13.75	7.25	Carbon Steel	40.5
CCD0714SS	1-Ton to Super Duty	17.15	11.75	13.75	7.25	304 Stainless Steel	35
CCD1314	Medium & Heavy Duty	15.12	23.00	13.50	12.38	Carbon Steel	49.5

Accessories:

Part No.	Description	Wt. (lbs.)
3015862	Replacement Handle for CCD0714/CCD0714SS	3
3015863	Replacement Handle for CCD1314	2.76

Dump Body Hardware

AIR VALVES

4-WAY, 2-POSITION

- Panel mounted valve is ideal for operating double acting cylinders
- Black anodized aluminum
- Requires 1/2 in. diameter hole for mounting
- (5) 1/8 in. NPT ports
- Includes tailgate control faceplate



BAV010

Part No.	Valve Actuation	Depth (in.)	Width (in.)	Height (in.)	Valve Action	Valve Primary Application	Wt. (lbs.)
BAV010	Manual Push/Pull	1-3/8	13/16	4	4-Way, 2 Position	Air Tailgate Valve	0.5

4-WAY, 3-POSITION

- Detent spool allows for adjusting linkage without shutting off air pressure
- Center position blocks air at valve while opening both cylinder ports to atmosphere
- Requires 5/8 in. diameter hole for mounting
- (5) 1/4 in. NPT ports
- Black anodized aluminum



BAV015

BAV020

Part No.	Valve Actuation	Depth (in.)	Width (in.)	Height (in.)	Valve Action	Valve Primary Application	Wt. (lbs.)
BAV015	Manual Push/Pull	1-1/2	1	5	4-Way, 3 Position	Air Tailgate Valve	0.67
BAV020	Manual Push/Pull	1-5/16	1	6-1/8	4-Way, 3 Position	Air Tailgate Valve	1.86

4-WAY, 2-POSITION SOLENOID

- (5) 1/4 in. NPT ports
- Rugged 12 VDC coil comes complete with 2 ft flying leads
- Can be easily converted to 3-way operation by installing 2 pipe plug



BAV050SA

BSW050

Part No.	Valve Actuation	Depth (in.)	Width (in.)	Height (in.)	Valve Action	Valve Primary Application	Wt. (lbs.)
BAV050SA	12 VDC	1-3/8	1	4-3/4	4-Way, 2 Position	Solenoid Tailgate Valve	0.57

Accessories:

Part No.	Description	Wt. (lbs.)
BSW050	Push-Pull Switch For BAV050SA	0.2



TAILGATE CYLINDERS

- Extruded aluminum body
- 5/8in-18 threaded piston rod can be used with a variety of ends and is threaded for 1-1/2in for adjustment
- Retracted lengths are center to center dimensions that include a B27087C adjustable yoke on all configurations except cylinder only where it is measured as center of pivot to end of rod
- 1/4 NPT port threads
- Integrated Pillow valves (prevents piston from slamming when fully open or closed)
- Available in 1/2in clevis style (V) or hinge style (HM) base end mounting
- Available in a variety of kit and control configurations designated by the part number suffix

CYLINDER ONLY



TGC25006C

CYLINDER KITS



TGC32506V



TGC32506HM

CYLINDER AND VALVE KITS



TGC32506VK



TGC32506HMK

CYLINDER AND ELECTRICALLY OPERATED VALVE KITS



TGC32506VKSA



TGC32506HMSKA

CYLINDER AND VALVE KITS WITH TUBING AND FITTINGS



TGC25006VSPK



Part No.	Mount	Stroke	Bore	Retracted Length (in.)	Rod Dia (in.)	Control	Wt. (lbs.)
C kits include cylinder only with a removable base mounted clevis							
TGC25006C	Clevis	6	2.5	13-1/4	3/4	None	5.5
TGC25008C	Clevis	8	2.5	15-1/4	3/4	None	6.2
TGC32506C	Clevis	6	3.25	15-1/4	1	None	9.5
TGC23508C	Clevis	8	3.25	17-1/4	1	None	10.2
V and HM kits include cylinder and related hardware, including B27087C adjustable yoke for piston rod, jam nut, and clevis pins							
TGC25006V	Clevis	6	2.5	Min 13-3/4 to Max 14-3/4	3/4	None	6.1
TGC25006HM	Hinge	6	2.5	Min 13-3/4 to Max 14-3/4	3/4	None	9.5
TGC25008V	Clevis	8	2.5	Min 15-3/4 to Max 16-3/4	3/4	None	6.7
TGC25008HM	Hinge	8	2.5	Min 15-3/4 to Max 16-3/4	3/4	None	10.2
TGC32506V	Clevis	6	3.25	Min 15-3/4 to Max 16-3/4	1	None	10.1
TGC32506HM	Hinge	6	3.25	Min 15-3/4 to Max 16-3/4	1	None	13.6
TGC32508V	Clevis	8	3.25	Min 17-3/4 to Max 18-3/4	1	None	10.8
TGC32508HM	Hinge	8	3.25	Min 17-3/4 to Max 18-3/4	1	None	14.3
VK and HMK kits include cylinder, hardware, and BAV010 manual push / pull valve							
TGC25006VK	Clevis	6	2.5	Min 13-3/4 to Max 14-3/4	3/4	BAV010	6.6
TGC25006HMK	Hinge	6	2.5	Min 13-3/4 to Max 14-3/4	3/4	BAV010	10
TGC25008VK	Clevis	8	2.5	Min 15-3/4 to Max 16-3/4	3/4	BAV010	7.3
TGC25008HMK	Hinge	8	2.5	Min 15-3/4 to Max 16-3/4	3/4	BAV010	10.7
TGC32506VK	Clevis	6	3.25	Min 15-3/4 to Max 16-3/4	1	BAV010	10.6
TGC32506HMK	Hinge	6	3.25	Min 15-3/4 to Max 16-3/4	1	BAV010	14.1
TGC32508VK	Clevis	8	3.25	Min 17-3/4 to Max 18-3/4	1	BAV010	11.3
TGC32508HMK	Hinge	8	3.25	Min 17-3/4 to Max 18-3/4	1	BAV010	14.8
VKSA or HMKSA kits include cylinder, hardware, BAV050SA electric operated valve installed on cylinder, BSW050 push/pull electric switch, and 100ft of 1/4in tubing							
TGC25006VKSA	Clevis	6	2.5	Min 13-3/4 to Max 14-3/4	3/4	BAV050SA	7.2
TGC25006HMKSA	Hinge	6	2.5	Min 13-3/4 to Max 14-3/4	3/4	BAV050SA	10.6
TGC25008VKSA	Clevis	8	2.5	Min 15-3/4 to Max 16-3/4	3/4	BAV050SA	7.9
TGC25008HMKSA	Hinge	8	2.5	Min 15-3/4 to Max 16-3/4	3/4	BAV050SA	11.3
TGC32506VKSA	Clevis	6	3.25	Min 15-3/4 to Max 16-3/4	1	BAV050SA	11.2
TGC32506HMKSA	Hinge	6	3.25	Min 15-3/4 to Max 16-3/4	1	BAV050SA	14.7
TGC32508VKSA	Clevis	8	3.25	Min 17-3/4 to Max 18-3/4	1	BAV050SA	11.9
TGC32508HMKSA	Hinge	8	3.25	Min 17-3/4 to Max 18-3/4	1	BAV050SA	15.4
VSPK kits include cylinder, hardware, BAV020 manual push / pull valve, 75ft of 1/4in tubing, and 7 push to connect fittings							
TGC25006VSPK	Clevis	6	2.5	Min 13-3/4 to Max 14-3/4	3/4	BAV020	10.0
TGC25008VSPK	Clevis	8	2.5	Min 15-3/4 to Max 16-3/4	3/4	BAV020	10.7
TGC32506VSPK	Clevis	6	3.25	Min 15-3/4 to Max 16-3/4	1	BAV020	14.0
TGC32508VSPK	Clevis	8	3.25	Min 17-3/4 to Max 18-3/4	1	BAV020	14.7

Dump Body Hardware

TAILGATE CYLINDER KIT PARTS

NYLON TUBE AND FITTING INSTALLATION KIT

- 3/8 in. x 100 ft. D.O.T. approved nylon tube, (4) 3/8in. x 1/4in. push-in elbows, (1) 3/8in. x 1/4in. swivel elbow
- These kits contain all material required to install 2-1/2in. or 3-1/4in. cylinders using BAV010, BAV020 air valves



TGC02TFK

Part No.	Length (ft)	Diameter (in.)	For Use With	Wt. (lbs.)
TGC02TFK	100	3/8	BAV010 or BAV020 air valves	3.69

NPT BREATHER VENT

- Max pressure: 150 PSI
- Max temperature: 300 F
- 40 microns



BAV02002

Part No.	Side 1	Shape	Style	Material	Finish	Wt. (lbs.)
BAV01502	1/8 NPTF	Hex Head	M	Brass	Plain	0.02
BAV02002	1/4 NPT	Hex Head	M	Carbon Steel	Zinc Plated	0.02

REDUCER BUSHING

- Bushing is constructed from brass and allows you to connect two different sizes of air tubing in-line



RAB038025



RAB050038

Part No.	Side 1	Side 2	Shape	Style	Material	Finish	Wt. (lbs.)
RAB038025	3/8 NPT	1/4 NPT	Run Tee	MF	Brass	Plain	0.04
RAB050038	1/2 NPT	3/8 NPT	Combination Nipple	MF	Brass	Plain	0.05



SHOVEL HOLDER

- Holds shovels or other round handled tools in place with heavy duty spring mechanism
- Offset mounts provide extra clearance for large shovels



SH675SS



SH675SS Application



3056416



3056419

Part No.	Plate Width (in.)	Plate Height (in.)	Material	Finish	Wt. (lbs.)
SH675	7.50	6.37	Carbon Steel	Powder Coat	2.88
SH675SS	7.50	6.37	304 Stainless Steel	Plain	2.75

Accessories:

Part No.	Description	Wt. (lbs.)
3056417	1 Inch Carbon Steel Offset Mount for Carbon Steel Shovel Holder, Weld-On, w/hardware	0.78
3056416	1 Inch Stainless Steel Offset Mount for Stainless Steel Shovel Holder, Weld-On w/hardware	0.76
3056418	2-3/8 Inch Carbon Steel Offset Mount for Carbon Steel Shovel Holder, Weld-On, w/hardware	1.22
3056419	2-3/8 Inch Stainless Steel Offset Mount for Stainless Steel Shovel Holder, Weld-On, w/hardware	1.25

REAR DUMP HINGE

- Sized for 1-ton / superduty dumps
- 57 degree dump angle
- 1/4 in. carbon steel construction
- 1 in. cold rolled steel hinge pin with grease fitting



5121000



5121000 End View



5121000 Application

Part No.	Length (in.)	Width (in.)	Height (in.)	Pin Diameter (in.)	Wt. (lbs.)
5121000	5.50	5.31	3.50	1	6.43

LOWER HINGE ASSEMBLY

- Heavy duty forged C1045 steel construction
- C1020 steel base allows for easier welding



BTL020B2



BTL020B2 Application

Part No.	Bracket Width (in.)	Bracket Height (in.)	Pin Dia. (in.)	Tailgate Post Dia (in.)	Bracket Material	Wt. (lbs.)
BTL020B2	2.52	7.00	0.50	1.00	Forged Steel	6.04
BTL030B2	2.52	7.00	0.50	1.25	Forged Steel	6.04
BTL030B656	2.52	7.00	0.65	1.25	Forged Steel	6.04
BTL030M2	4.00	7.00	0.50	1.25	Forged Steel	6.04

Accessories:

Part No.	Description	Wt. (lbs.)
B284001	1/2 Inch Tailgate Pin Replacement - Zinc	0.35

Dump Body Hardware

TAILGATE LATCH ASSEMBLY COMPONENTS



TGL3410 Application

Part No.	Description	Wt. (lbs.)
TGL3410ST	Steel tailgate assembly with forged bracket & clevis	10.33
TGL3410	Steel tailgate assembly with aluminum bracket & clevis	6.4
TGL3410SS	Stainless steel tailgate latch assembly with SS bracket & clevis	10.4

Accessories:

Part No.	Description	Wt. (lbs.)
TGL34SBR	(A) and (B) : Steel Latch Assembly for Tailgate Latch	3.4
TGL34SB	(A) : Steel Bar Winder Assembly Only	2.38
B27028LMZ	(B) : Forged Rod End for Tailgate Latch	1.04
TGL3410HDW	(1) : Hardware Kit for Tailgate Latch	0.4
TGL34CLCS	(2) : Cast Steel Clevis for Tailgate Latch	1.75
TGL34CL	(2) : Aluminum Clevis for Tailgate Latch	0.6
TGL34CLSS	(2) : Stainless Steel Clevis for Tailgate Latch	1.81
TGL34BKTF	(3) : Forged Steel Bracket for Tailgate Latch	4.34
TGL34BKT	(3) : Aluminum Bracket for Tailgate Latch	1.6
TGL34BKTSS	(3) : Stainless Steel Bracket for Tailgate Latch	4.38

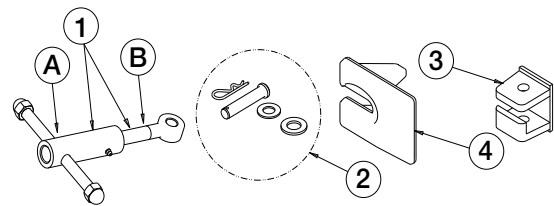

TAILGATE RELEASE LEVER

- Ductile iron release lever slides over 1 in. diameter cross shaft & bolts to adapter plate for 2-point attachment
- Adapter is designed to weld to 1 in. diameter cross shaft to provide mounting point for L001 tailgate release lever
- Tailgate release lever cam (L001C) sold separately

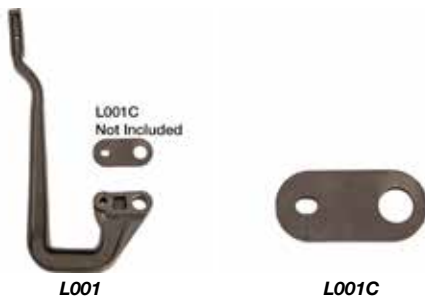

Part No.	Overall Handle Height (in.)	Material	Wt. (lbs.)
L001	20.00	Cast Iron	6.8

Accessories:

Part No.	Description	Wt. (lbs.)
L001C	Tailgate Release Lever Cam	0.7

UPPER TAILGATE BRACKET

- Comes complete with 1/2 in. diameter "L" pin and hairpin cotter
- For use with 1-1/4 in. diameter tailgate posts



BTB030

Part No.	Back Brkt to Front Brkt (in.)	Bracket Width (in.)	Bracket Height (in.)	Pin Diameter (in.)	Tailgate Post Dia (in.)	Bracket Material	Wt. (lbs.)
BTB030	2.95	2.00	5.08	0.50	1.25	Forged Steel	3.1

Accessories:

Part No.	Description	Wt. (lbs.)
B284001	1/2 Inch Tailgate Pin Replacement - Zinc	0.35



TAILGATE LINKAGE CONNECTING PLATE

- Stamped from 1/2 in. steel plate
- Other sizes available by special order



TGCAM0001

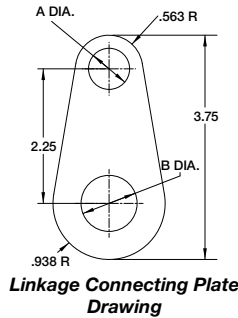

Part No.	Mounting Holes Ctr to		Plate Thickness	Wt. (lbs.)
	A	B		
TGCAM0002	1/2	1.00	2-1/4	0.6
TGCAM0004	1/2	1-1/4	2-1/4	0.5
TGCAM0003	5/8	1.00	2-1/4	0.6
TGCAM0001	5/8	1-1/4	2-1/4	0.46

WELD-ON TAILGATE RING

- 1/4 in. stock 2-3/4 in. O.D. ring
- 6 links, 5 - 7 in. long
- Use with tailgate release lever



58R6



58R6 Application

Part No.	Number of Links	Ring Diameter (in.)	Chain Length (in.)	Chain Stock (in.)	Material	Finish	Wt. (lbs.)
58R5SS	5	2-3/4	4-3/4	1/4	Stainless Steel	Plain	0.28
58R6	6	2-3/4	5-3/4	1/4	Carbon Steel	Zinc Plated	0.29
58R14	14	2-3/4	13-3/10	1/4	Carbon Steel	Plain	0.57

BANJO EYE

- Available in low carbon stamped steel or stainless steel
- Banjo Eye is available for 5/16 in. or 3/8 in. chains

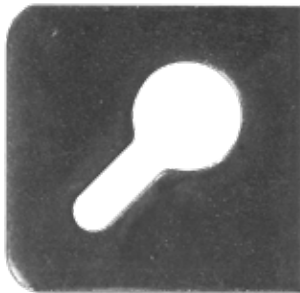

TGBE3125



TGBE2754

Part No.	Chain Size		Material	Finish	Wt. (lbs.)	
	(in.)	Width (in.)				Height (in.)
TGBE3125	5/16	3-1/2	3-1/2	Carbon Steel	Plain	0.87
TGBE3138	3/8	3-1/2	3-1/2	Carbon Steel	Plain	0.78
TGBE6438	3/8	4-1/4	6.00	304 Stainless Steel	Plain	2.39
TGBE2754	3/8	3	4-1/8	304 Stainless Steel	Plain	0.87



TGBE2754 shown

Dump Body Hardware

TAILGATE CHAIN LATCH

- Formed from 3/8 in. steel
- Provides a latch point for safety chains up to 3/8 in. in size



CL375



CL375 Application

Part No.	Length (in.)	Width (in.)	Length - Hole to End (in.)	For Use With	Material	Wt. (lbs.)
CL375	3.00	2-1/2	2.00	Chains up to 3/8 in.	Carbon Steel	1.17

LIMIT SWITCHES

DUMP BODY-UP INDICATOR

- 360° Activation
- Water resistant
- Includes bracket
- Adjustable wand
- 12 VDC, 15 AMPs
- Normally closed



B95



B95W



SK11

Part No.	Prewired (Y/N)	Connection	Body Up Style	Buzzer Included (Y/N)	Indicator Light Included (Y/N)	Wt. (lbs.)
B95	No	—	Wand	No	No	0.8
B95W	Yes	Blunt Cut	Wand	No	No	0.8
SK11	Yes	Packard Connector	Wand	No	Yes	1.11

COMPACT STYLE DUMP BODY-UP INDICATOR

- Waterproof, IP68 rated
- 304SS housing with adjustable mounts
- Operates in extreme temps: -40°F - 185°F
- 12-24 VDC, 5 AMPs
- Normally closed, no polarity
- Ideal for use with BL10 buzzer light



B96W

Part No.	Prewired?	Blunt Cut?	Body Up Style	Buzzer Included?	Indicator Light Included?	Wt. (lbs.)
B96W	Yes	Yes	Lever	No	No	0.2



LIMIT SWITCHES - continued

BUZZER LIGHT

- Combination warning light & buzzer operate simultaneously for 2-way warning of hazardous conditions
- 12 VDC, .2 AMPs
- Red lens, snaps out for easy bulb replacement (bulb included)
- 70 DB at 3 ft



BL10

Part No.	Body Up Style	Buzzer Included?	Indicator Light Included?	Wt. (lbs.)
BL10	Indicator Only	Yes	Yes	0.16

DUMP BODY-UP INDICATOR KIT

- Kit Includes: weather tight switch, 20 ft wiring harness, packard weatherproof connectors, body and chassis mounting brackets, red indicator light and in-cab indicator decal



SK10

Part No.	Body Up Style	Buzzer Included?	Indicator Light Included?	Wt. (lbs.)
SK10	Plunger	No	Yes	1.14
SK12	Plunger	Yes	Yes	1.7

COMPACT-STYLE DUMP BODY-UP INDICATOR KIT

- Waterproof, IP68 rated
- 304SS housing with adjustable mounts
- Operates in extreme temps: -40°F - 185°F
- 12-24 VDC, 5 AMPs
- Normally closed, no polarity
- Kit Includes: B96W indicator, 20 ft wiring harness, BL10 buzzer light, red indicator light and in-cab indicator decal



SK16

Part No.	Body Up Style	Buzzer Included?	Indicator Light Included?	Wt. (lbs.)
SK16	Lever	Yes	Yes	1

Dump Body Hardware

DUMP BODY VIBRATORS

- O-Ring sealed for weather resistance
- Sealed, permanently lubricated bearings
- Hardened steel motor shaft
- Aluminum housing
- Steel mounting plate
- Includes 3010636 Mounting Kit : 50 ft 4 AWG wire, solenoid, 150 amp circuit breaker, push-button switch, 8-1/2 in. bolt centers with 3/4 in. fasteners



DBV3500



Included Mount Kit



DBV2500 Application



3009253

Part No.	Length (in.)	Width (in.)	Height (in.)	Suggested Dump Body Length (ft)	Force (lbs)	Included Wiring Length (ft.)	Voltage	Wt. (lbs.)
DBV2500	12.00	10.00	10.00	9-12	2500	50	12	62
DBV3500	12.00	10.00	10.00	13+	3500	50	12	62.92

Accessories:

Part No.	Description	Wt. (lbs.)
3009253	Aluminum Vibrator Mounting Plate for Aluminum Dump Body	5.29

INSTALLATION KIT FOR 2500-3500 POUND DUMP BODY VIBRATORS

- 3010636 Mounting kit includes: 50 ft 4 AWG wire, solenoid, 150 amp circuit breaker, push-button switch, on 8-1/2 in. bolt centers with 3/4 in. fasteners



3010636

Part No.	Description	Wt. (lbs.)
3010636	Installation Kit For 2500-3500 Pound Dump Body Vibrators	10.6

Accessories:

Part No.	Description	Wt. (lbs.)
1306317	12 Volt Plastic Case Insulated Solenoid Continuous Duty Motor Relay	0.85
CB150	150 Amp Circuit Breaker With Auto Reset	0.23
3010629	WIRE, COPPER, 4 AWG, BLACK, (50 FT/ROLL)	0.17
3010635	HARDWARE KIT, 2500 & 3500 VIBRATOR	0.22
SW900	12 Volt Momentary Switch with Vibrator Label	0.12

DUMP BODY VIBRATOR TIMER

- 15 second vibrator timer



3022840

Part No.	Mount Style	Switch Style	Wt. (lbs.)
3022840	Panel	Solid State	0.25



CONTINUOUS HINGE

- Equal leaves
- Stock length 72 in.
- 96 in. lengths are available by special order

ALUMINUM CONTINUOUS HINGE



A34

Part No.	Thickness (in.)	Open Width (in.)	Pin Diameter (in.)	Knuckle Length (in.)	Wt. (lbs.)
A34	.093	2.00	1/4	1.00	0.27
A36	.075	3.00	1/4	1.00	0.28
A41	.120	3.00	3/8	2.00	0.29

STAINLESS STEEL CONTINUOUS HINGE



SS15

Part No.	Thickness (in.)	Gauge	Open Width (in.)	Pin Diameter (in.)	Knuckle Length (in.)	Wt. (lbs.)
SS15	.075	14	2.00	.25	1.00	0.30
SS15N	.075	14	2.00	.187	1.00	0.31
SS16	.075	14	2.50	.25	1.00	0.32
SS17	.075	14	3.00	.25	1.00	0.33
SS19	.120	11	2.00	.375	2.00	0.34
SS20	.120	11	3.00	.375	2.00	0.35
SS21	.120	11	4.00	.375	2.00	0.36
SS8	.062	16	1.50	.128	.50	0.37

STEEL CONTINUOUS HINGE



SS65

Part No.	Thickness (in.)	Gauge	Open Width (in.)	Pin Diameter (in.)	Knuckle Length (in.)	Wt. (lbs.)
S48	.075	14	2.00	1/4	1.00	0.38
S50	.075	14	3.00	1/4	1.00	0.39
S63	.120	11	2.00	3/8	2.00	0.40
S65	.120	11	3.00	3/8	2.00	0.41
S73	.187	7	4.00	1/2	2.00	0.42

Continuous Hinge Terms

- 1. Hinge Length:** The length of the leaves measured parallel to the pin.
- 2. Hinge Width:** The over-all dimension of the leaves measured perpendicular or across the pin.
- 3. Leaf:** That portion of a hinge extending laterally from the knuckle, which generally revolves around a pin.
- 4. Leaf Width:** The dimension from the center of the pin to the outer edge of the leaf.
- 5. Knuckle:** The hollow circular part at the joint of a hinge through which a pin is passed. Sometimes called loop, joint, node or curl.
- 6. Knuckle Length:** The nominal or typical dimension of the knuckle measured parallel to the pin.
- 7. Pitch:** The dimension from a point on the knuckle to the same point on an adjacent knuckle on the same leaf.
- 8. End Play:** The amount of axial movement between the leaves.
- 9. Paint Clearance:** The dimension between the outer face of the knuckle and the opposing edge of the leaf cutout over the entire range of pivotal movement of the hinge.
- 10. Pin:** Diameter of rod.

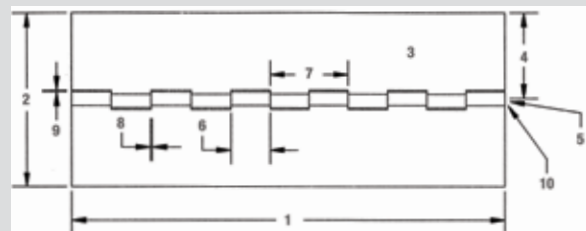

Hinges

BULLET HINGE

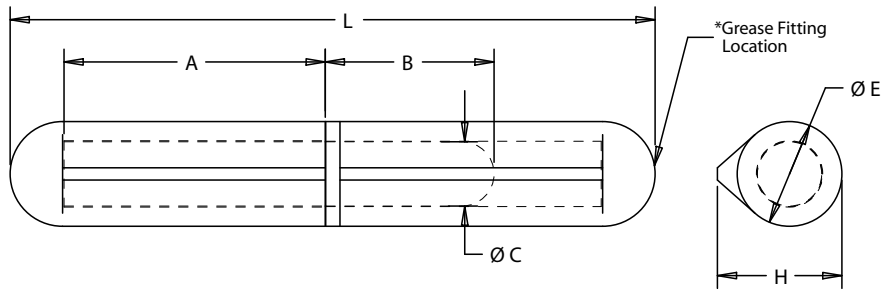

ALUMINUM WELD-ON BULLET HINGE



Part No.	Hinge Length (in.) L	Thickness (in.) H	Diameter (in.) E	Pin Length A (in.)	Pin Length B (in.)	Pin Diameter (in.) C	Pin Material	Bushing Material	With Grease Fitting (y/n)	Wt. (lbs.)
AFSSP080	3.15	0.61	0.51	1.28	0.83	0.32	Stainless Steel	Stainless Steel	No	0.09
AFSSP100	3.94	0.77	0.63	1.65	1.16	0.39	Stainless Steel	Stainless Steel	No	0.10

STAINLESS STEEL WELD-ON BULLET HINGE



Part No.	Hinge Length (in.) L	Thickness (in.) H	Diameter (in.) E	Pin Length A (in.)	Pin Length B (in.)	Pin Diameter (in.) C	Pin Material	Bushing Material	With Grease Fitting (y/n)	Wt. (lbs.)
FSS070	2.76	0.51	0.45	1.14	0.67	0.24	Stainless Steel	Stainless Steel	No	0.11
FSS100	3.94	0.77	0.63	1.65	1.16	0.39	Stainless Steel	Stainless Steel	No	0.12

STEEL WELD-ON BULLET HINGE



Part No.	Hinge Length (in.) L	Thickness (in.) H	Diameter (in.) E	Pin Length A (in.)	Pin Length B (in.)	Pin Diameter (in.) C	Pin Material	Bushing Material	With Grease Fitting (y/n)	Wt. (lbs.)
FSP050	1.97	0.39	0.32	0.79	0.55	0.20	Carbon Steel	Brass	No	0.13
FSP070	2.76	0.51	0.45	1.14	0.67	0.24	Carbon Steel	Brass	No	0.14
FSP100	3.94	0.77	0.63	1.65	1.16	0.39	Carbon Steel	Brass	No	0.15
FSP120	4.72	0.77	0.63	2.01	1.26	0.39	Carbon Steel	Brass	No	0.16
FSP150	5.91	0.98	0.79	2.48	1.57	0.51	Carbon Steel	Brass	No	0.17
FSP200	7.87	1.12	0.91	3.46	2.05	0.63	Carbon Steel	Brass	No	0.18
FSP260	10.24	1.46	1.10	4.53	2.87	0.75	Carbon Steel	Brass	No	0.19



BULLET HINGE - continued

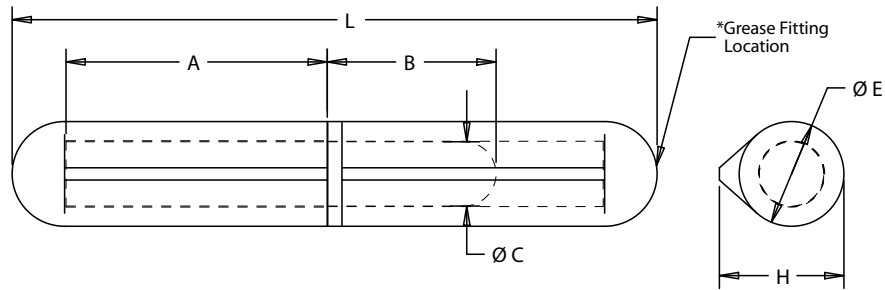

STEEL WELD-ON BULLET HINGE WITH BRASS PIN



Part No.	Hinge Length (in.) L	Thickness (in.) H	Diameter (in.) E	Pin Length A (in.)	Pin Length B (in.)	Pin Diameter (in.) C	Pin Material	Bushing Material	With Grease Fitting (y/n)	Wt. (lbs.)
FBP080	3.15	0.61	0.51	1.28	0.08	0.32	Brass	Brass	No	0.20
FBP150	5.91	0.98	0.79	2.48	1.57	0.51	Brass	Brass	No	0.22

STEEL WELD-ON BULLET HINGE WITH GREASE FITTING



Part No.	Hinge Length (in.) L	Thickness (in.) H	Diameter (in.) E	Pin Length A (in.)	Pin Length B (in.)	Pin Diameter (in.) C	Pin Material	Bushing Material	With Grease Fitting (y/n)	Wt. (lbs.)
FBP080GF	3.15	0.61	0.51	1.28	0.08	0.32	Brass	Brass	Yes	0.23
FBP100GF	3.94	0.77	0.63	1.65	1.16	0.39	Brass	Brass	Yes	0.24
FBP120GF	4.72	0.77	0.63	2.01	1.26	0.39	Brass	Brass	Yes	0.25
FBP150GF	5.91	0.98	0.79	2.48	1.57	0.51	Brass	Brass	Yes	0.26

Hinges

BUTT HINGE

STEEL AND STAINLESS STEEL BUTT HINGES

- No holes



BTS062012



BTSS123025

Part No.	Thickness (in.)	Open Width (in.)	Hinge Length (in.)	Material	Pin Diameter (in.)	Finish	Pin Retention	Wt. (lbs.)
BTS062012	.060	2.00	2.00	Carbon Steel	.125	Plain	Spun Ends	0.43
BTS072018	.075	2.00	2.00	Carbon Steel	.187	Plain	Spun Ends	0.44
BTS093018	.090	3.00	3.00	Carbon Steel	.187	Plain	Spun Ends	0.45
BTS123025	.120	3.00	3.00	Carbon Steel	.25	Plain	Spun Ends	0.46
BTS124025	.120	4.00	4.00	Carbon Steel	.25	Plain	Spun Ends	0.47
BTSS123025	.120	3.00	3.00	Stainless Steel	.25	Plain	Spun Ends	0.48
BTSS124025	.120	4.00	4.00	Stainless Steel	.25	Plain	Spun Ends	0.49

FORGED BUTT HINGE

- Width of opening: 1-1/2 in.
- Holes in Flat C-C: 4 in.
- Projection: 2 in.
- Diameter of eye: 1-1/8 in.
- Holes in eye: 7/32 in.



B2426E

Part No.	Open Width (in.)	Hinge Length (in.)	Material	Pin Diameter (in.)	Finish	Pin Retention	Wt. (lbs.)
B2426E	3.27	5.38	Carbon Steel	1/2	Plain	Cotter Pin	0.55

STEEL BUTT HINGE WING STYLE

- Flush-mounted wing style
- Pin not welded



H2550

Part No.	Open Width (in.)	Hinge Length (in.)	Material	Pin Diameter (in.)	Finish	Pin Retention	Wt. (lbs.)
H2550	2.50	5.50	Carbon Steel	1/2	Plain	Loose	0.50

ZINC PLATED STEEL BUTT HINGE

- Flush-mounted wing style
- Single end weld for left or right mount
- Stainless steel pin



H412550RH

Part No.	Open Width (in.)	Hinge Length (in.)	Material	Pin Diameter (in.)	Finish	Pin Retention	Wt. (lbs.)
H412538LH	1.25	4.00	Steel	3/8	Plain	Single End Weld	0.51
H412538RH	1.25	4.00	Steel	3/8	Plain	Single End Weld	0.52
H412550LH	1.25	4.00	Steel	1/2	Plain	Single End Weld	0.53
H412550RH	1.25	4.00	Steel	1/2	Plain	Single End Weld	0.54



FORMED AND STRAP HINGES

STAINLESS STEEL CARGO TRAILER FLUSH HINGE

- Countersunk holes and nylon bushings



B2426SSCL

Part No.	Strap Length (in.)	Strap Width (in.)	Pin Size (in.)	Material	Finish	Wt. (lbs.)
B2426SSCL	5.59	3.28	1/4	Stainless Steel	Polished	0.56
B2426SSCR	5.59	3.28	1/4	Stainless Steel	Polished	0.57

STAINLESS STEEL STRAP HINGE

- Nylon bushing



B2424SS

Part No.	Length (in.)	Thickness (in.)	Strap Length (in.)	Strap Width (in.)	Bracket Height (in.)	Bracket Width (in.)	Pin Size (in.)	Material	Finish	Wt. (lbs.)
B2424SS	4.00	0.125	3.62	1.00	2.75	4.00	5/16	Stainless Steel	Plain	0.63

STEEL STRAP HINGE

- Strap length is measured from center of pin to end of strap



B2423G

Part No.	Length (in.)	Thickness (in.)	Strap Length (in.)	Strap Width (in.)	Bracket Height (in.)	Bracket Width (in.)	Pin Size (in.)	Material	Finish	Wt. (lbs.)
B2423F	10.56	3/16	8.00	2.25	5.00	3.00	1/2	Steel	Plain	0.64
B2423G	15.19	3/16	12.00	2.25	5.00	3.00	1/2	Steel	Plain	0.65
B2423H	18.81	3/16	16.00	2.25	5.00	3.00	1/2	Steel	Plain	0.66

FORGED HINGE STRAP

- Strap can be welded, bolted, or riveted on.
- Designed to work with Buyers Products B2426E hinges.



B2429X



B2430W

Part No.	Strap Length (in.)	Strap Width (in.)	Pin Size (in.)	Material	Finish	Wt. (lbs.)
B2429X	4.375	1.50	1/2	Forged Steel	Plain	0.58
B2430W	24.00	1.50	33/64	Forged Steel	Plain	0.59

Hinges

FORMED AND STRAP HINGES - continued

FORMED STEEL STRAP HINGE

- Includes zinc washer, hex head cap screw with locknut, and plastic bushing



B2426FS



B2426FSL



B2426FSNB

Part No.	Style	Strap Length (in.)	Strap Thickness (in.)	Hinge Width (in.)	Hinge Height (in.)	Wt. (lbs.)
B2426FS	Short Leaf	3.85	0.31	4.33	2.44	0.62
B2426FSL	Long Leaf	5.85	0.31	4.33	2.44	0.60
B2426FSNB	Straight Strap	3.85	0.31	4.33	2.44	0.61

Accessories:

Part No.	Description	Wt. (lbs.)
3008647	Steel Bushing for B2426F Series Hinge, Replaces Standard Poly Bushing	0.01

CABLE/ZIP TIES

NYLON CABLE TIES

- 100% nylon
- Bent tip for ease of installation
- Available in natural or black weather resistant (WR)



Part No.	Length	Width	Tensile Strength (lbs.)	Color	Military Standard	Package Quantity	Package Wt. (lbs.)
BTN055CPK	5-1/2"	.180	50	Natural	MS-3367-5	100 PC	0.08
BTN075	7-1/2"	.180	50	Natural	MS-3367-1	1000 PC	2.50
BTN075CPK	7-1/2"	.180	120	Natural	MS-3367-1	100 PC	0.13
BTN011CPK	11"	.180	50	Natural	MS-3367-7	100 PC	0.18
BTN011	11"	.180	50	Natural	MS-3367-7	500 PC	4.25
BTN145	14-1/2"	.250	120	Natural	MS-3367-3	100 PC	0.98
BTN015	15"	.180	50	Natural	MS-3367-2	100 PC	0.57
BTN240	24"	.350	175	Natural	N/A	50 PC	1.40
BTN300	30"	.350	175	Natural	MS-3367-6	50 PC	2.08
BTN075WRCPK	7-1/2"	.180	50	Black	MS-3367-1	100 PC	0.26
BTN075WR	7-1/2"	.180	50	Black	MS-3367-1	1000 PC	2.60
BTN011WRCPK	11"	.180	50	Black	MS-3367-7	100 PC	0.24
BTN011WR	11"	.180	50	Black	MS-3367-7	500 PC	1.96
BTN145WR	14-1/2"	.250	120	Black	MS-3367-3	100 PC	0.98
BTN015WR	15"	.180	50	Black	MS-3367-2	100 PC	0.56

ADHESIVE MOUNT

- 1" square adhesive mount
- Also accepts #6 screw
- For all ties up to .180 wide
- 100 pcs. per bag
- Color: Natural



Part No.	Description	Wt. (lbs.)
B08462	Adhesive Mount	0.42



Tarp Systems



Product Shown:
5544406 ElectroCover™ Top
Side-Rail Spring Pivot

ElectroCover Systems	348 - 361
Aftermarket Tarp Gear Motors	356
CrankCover Manual Arm Tarp Systems	362 - 363
Retract-A-Pull Tarp Systems with Spring Assist	364 - 365

PullCover Manual Tarp Systems	366 - 369
Parts and Accessories	370 - 373
Mesh Tarps	374
Solid Tarps	375
Tarp Aftermarket Crossover	376

ElectroCover™ Side/Underbody Mount Electric Arm Tarp Systems

One-piece aluminum wind deflector (on some models)

90:1 High torque or 60:1 high speed tarp gear motor with chrome-plated plastic cover

Universal side mount pivots with die-cast housing (except underbody mount) 4-spring (fits 8'-19' dumps) 5-spring (fits 14'-23' dumps)

(6) Poly arm guides

Telescoping aluminum pivot arm assembly

5544000
Shown with optional
3036901 60° arm joint

Each System Includes

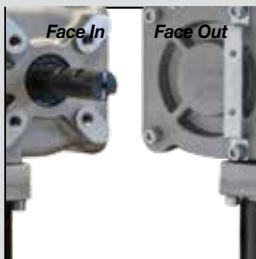

60:1 or 90:1 gear motors with chrome cover available with 1 or 3 year warranty.



60A, auto-reset circuit breaker



60', 8 Ga dual conductor battery cable



Rocker switch and solenoid with cover



ElectroCover™ Side/Underbody Mount Aluminum Arm

SEE PAGES 354-361 FOR PARTS AND ACCESSORIES



Tarps sold separately. See page 374-375

ELECTROCOVER™ SIDE SPRING PIVOT, WITH DEFLECTOR



ELECTROCOVER™ SIDE SPRING PIVOT, WITHOUT DEFLECTOR

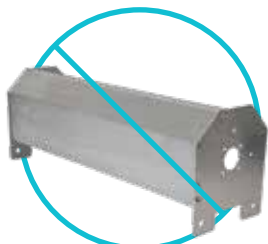

ELECTROCOVER™ UNDERBODY SPRING PIVOT, WITH DEFLECTOR



ELECTROCOVER™ UNDERBODY SPRING PIVOT, WITHOUT DEFLECTOR

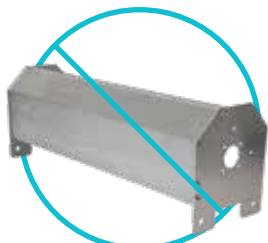

ELECTROCOVER™ ALUMINUM ARM JOINTS



3011868
30°



3036900
45°



3036901
60°



3011866
90°

Part No.	Gear Motor	Motor Warranty	Wt. (lbs.)
Fits 8' - 19' Dumps			
5544000	600W / 90:1	1 Yr.	126
5544300	600W / 90:1	3 Yr.	126
5544365	900W / 60:1	3 Yr.	128
5544395	900W / 90:1	3 Yr.	128
Fits 14' - 23' Dumps			
5545000	600W / 90:1	1 Yr.	142
5545300	600W / 90:1	3 Yr.	142
5545365	900W / 60:1	3 Yr.	144
5545395	900W / 90:1	3 Yr.	144

Fits 8' - 19' Dumps			
5544006	600W / 90:1	1 Yr.	114
5544306	600W / 90:1	3 Yr.	114
5544366	900W / 60:1	3 Yr.	116
5544396	900W / 90:1	3 Yr.	116
Fits 14' - 23' Dumps			
5545006	600W / 90:1	1 Yr.	130
5545306	600W / 90:1	3 Yr.	130
5545366	900W / 60:1	3 Yr.	132
5545396	900W / 90:1	3 Yr.	132

Part No.	Gear Motor	Motor Warranty	Wt. (lbs.)
Fits 8' - 19' Dumps			
5546000	600W / 90:1	1 Yr.	126
5546300	600W / 90:1	3 Yr.	126
5546365	900W / 60:1	3 Yr.	128
5546395	900W / 90:1	3 Yr.	128
Fits 14' - 23' Dumps			
5547000	600W / 90:1	1 Yr.	142
5547300	600W / 90:1	3 Yr.	142
5547365	900W / 60:1	3 Yr.	144
5547395	900W / 90:1	3 Yr.	144

Fits 8' - 19' Dumps			
5546006	600W / 90:1	1 Yr.	114
5546306	600W / 90:1	3 Yr.	114
5546366	900W / 60:1	3 Yr.	116
5546396	900W / 90:1	3 Yr.	116
Fits 14' - 23' Dumps			
5547000	600W / 90:1	1 Yr.	130
5547300	600W / 90:1	3 Yr.	130
5547365	900W / 60:1	3 Yr.	132
5547395	900W / 90:1	3 Yr.	132

Part No.	Joint Angle	Wt. (lbs.)
3011868	30°	1.66
3036900	45°	1.51
3036901	60°	1.51
3011866	90°	1.68

- Provides extra tarp arm clearance for trucks with tall cabs
- For use with Buyers electric tarp kits with aluminum arms
- 3011866 90° arm joint comes standard with kits

ElectroCover™ Top Side-Rail Electric Arm Tarp Systems



5544406
Shown without
deflector housing

Optional
5540000 Tension bow
and 3036900, 45° arm joints

Top Side-Rail mount
clears pre-wet tanks
on Municipal Dump truck applications

Universal Stainless Steel top side-rail
mount pivots with die-cast aluminum
housing 4-spring (fits 8'-19' dumps)

Each System Includes



60:1 or 90:1 gear motors with chrome cover available with 1 or 3 year warranty.



60A, auto-reset circuit breaker



60', 8 Ga dual conductor battery cable



Rocker switch and solenoid with cover



ElectroCover™ Top Side-Rail Aluminum Arm

SEE PAGES 354-361 FOR PARTS AND ACCESSORIES



Tarps sold separately. See page 374-375

ELECTROCOVER™ TOP SIDE-RAIL SPRING PIVOT, WITH DEFLECTOR **NEW**



Part No.	Gear Motor	Motor Warranty	Wt. (lbs.)
Fits 8' - 19' Dumps			
5544400	600W / 90:1	3 Yr.	207.79

ELECTROCOVER™ TOP SIDE-RAIL SPRING PIVOT, WITHOUT DEFLECTOR **NEW**

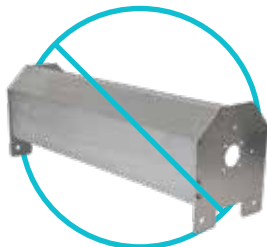

Part No.	Gear Motor	Motor Warranty	Wt. (lbs.)
Fits 8' - 19' Dumps			
5544406	600W / 90:1	3 Yr.	175

ELECTROCOVER™ ALUMINUM ARM JOINTS



3011868
30°



3036900
45°



3036901
60°



3011866
90°

Part No.	Joint Angle	Wt. (lbs.)
3011868	30°	1.66
3036900	45°	1.51
3036901	60°	1.51
3011866	90°	1.68

- 3011866 90° arm joint comes standard with kits
- Provides extra tarp arm clearance for trucks with tall cabs
- For use with Buyers electric tarp kits with aluminum arms

OPTIONAL TARP ARM RUBBER BUMPER



Part No.	Wt. (lbs.)
3054950*	1.76

- Fits Hex-shaped Aluminum and Round Steel Tarp arms



ElectroCover™ Side Mount Electric Arm Tarp Systems



One-piece aluminum wind deflector

90:1 High torque or 60:1 high speed tarp gear motor with chrome-plated plastic cover

Universal side mount pivot with welded lower arm
4-spring (fits 8'-19' dumps)
5-spring (fits 14'-23' dumps)

5548000
Shown with deflector housing

Telescoping steel pivot arm assembly with silver powder-coated finish

Each System Includes



60:1 or 90:1 gear motors with chrome-plated plastic cover available with 1 or 3 year warranty



60A, auto-reset circuit breaker



60', 8 Ga dual conductor battery cable



Rocker switch and solenoid with cover



SEE PAGES 354-361 FOR PARTS AND ACCESSORIES



Tarps sold separately. See page 374-375

SIDE SPRING PIVOT, WITH DEFLECTOR



Part No.	Gear Motor	Motor Warranty	Wt. (lbs.)
Fits 8' - 19' Dumps			
5548000	600W / 90:1	1 Yr.	117
5548300	600W / 90:1	3 Yr.	117
5548365	900W / 60:1	3 Yr.	117
5548395	900W / 90:1	3 Yr.	126
Fits 14' - 23' Dumps			
5549000	600W / 90:1	1 Yr.	126
5549300	600W / 90:1	3 Yr.	126
5549365	900W / 60:1	3 Yr.	126
5549395	900W / 90:1	3 Yr.	126

SIDE SPRING PIVOT, WITHOUT DEFLECTOR

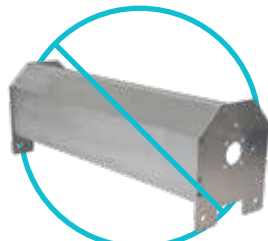

Part No.	Gear Motor	Motor Warranty	Wt. (lbs.)
Fits 8' - 19' Dumps			
5548006	600W / 90:1	1 Yr.	105
5548306	600W / 90:1	3 Yr.	105
5548366	900W / 60:1	3 Yr.	105
5548396	900W / 90:1	3 Yr.	114
Fits 14' - 23' Dumps			
5549006	600W / 90:1	1 Yr.	114
5549306	600W / 90:1	3 Yr.	114
5549366	900W / 60:1	3 Yr.	114
5549396	900W / 90:1	3 Yr.	114

ARM JOINTS



Part No.	Joint Angle	Wt. (lbs.)
3049502	30°	1.83
3049503	45°	1.83
3049504	60°	1.83
3040510	90°	1.83

- 3040510 90° arm joint comes standard with kits
- Provides extra tarp arm clearance for trucks with tall cabs
- For use with Buyers electric tarp kits with steel arms and manual tarp kits with steel arms

OPTIONAL TARP ARM RUBBER BUMPER



Part No.	Wt. (lbs.)
3054950*	1.76

- Fits Hex-shaped Aluminum and Round Steel Tarp arms



Parts and Accessories

ALUMINUM TENSION BOW KITS

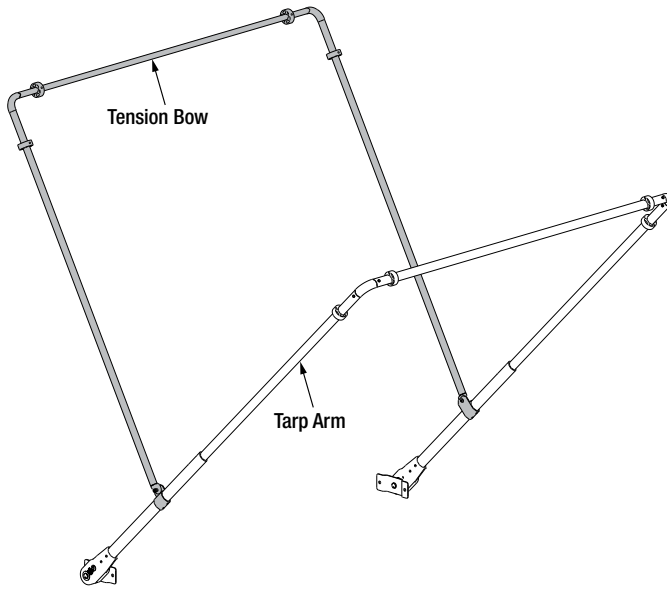

Part No.	Wt. (lbs.)
5540000	30

- Prevents tarp from flapping in transit
- Extruded aluminum tubing, cast aluminum corners, and poly bumpers included
- Works with all Buyers tarp kits with aluminum arms
- 30° (3011868), 45° (3036900) and 60° (3036901) tarp arm joints sold separately



4-SPRING UNIVERSAL ALUMINUM ARM KITS

Part No.	Wt. (lbs.)
3016666	59

- Cast aluminum spring housing
- Side tube telescopes for 8' - 19' dump bodies

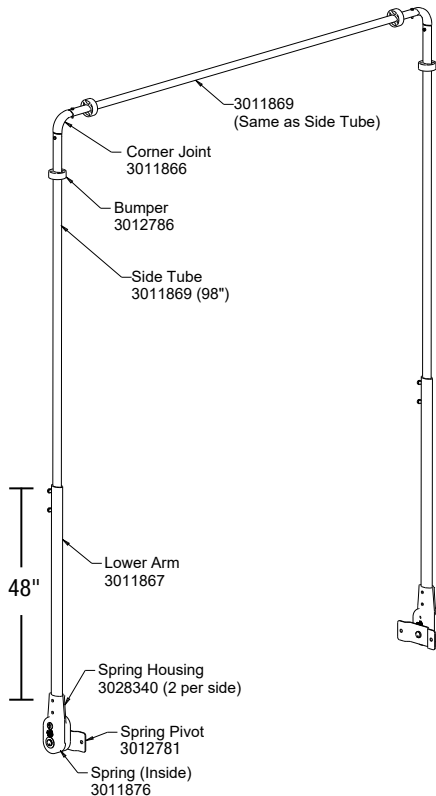

5-SPRING UNIVERSAL ALUMINUM ARM KITS

Part No.	Wt. (lbs.)
3016667	75

- Cast aluminum spring housing
- Side tube telescopes for 14' - 23' dump bodies

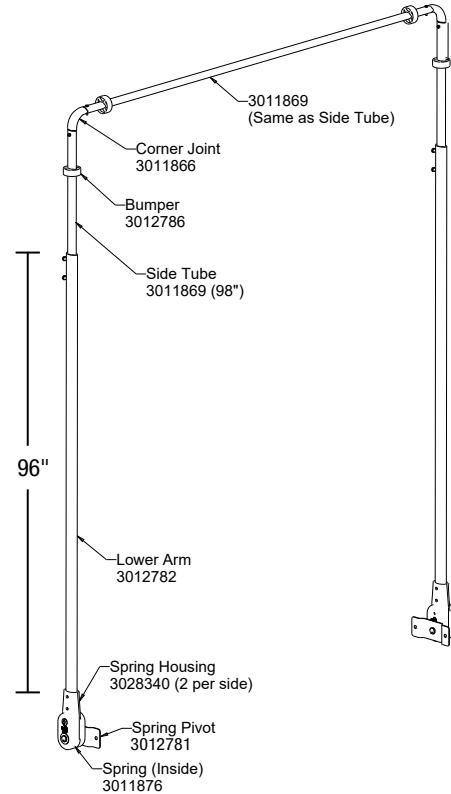

STEEL TENSION BOW KITS

Part No.	Wt. (lbs.)
5540003	54

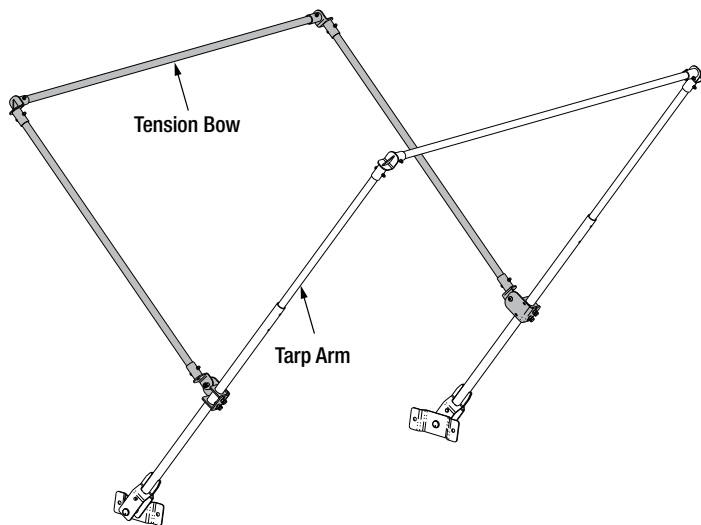

- Prevents tarp from flapping in transit
- Works with Buyers electric tarp kits with steel arms
- 30° (3049502), 45° (3049503) and 60° (3049504) tarp arm joints sold separately

4-SPRING UNIVERSAL STEEL ARM KITS

Part No.	Wt. (lbs.)
3049505	90.13

- Steel spring housing
- Side tube telescopes for 8' - 19' dump bodies
- 30° (3049502), 45° (3049503) and 60° (3049504) tarp joints sold separately

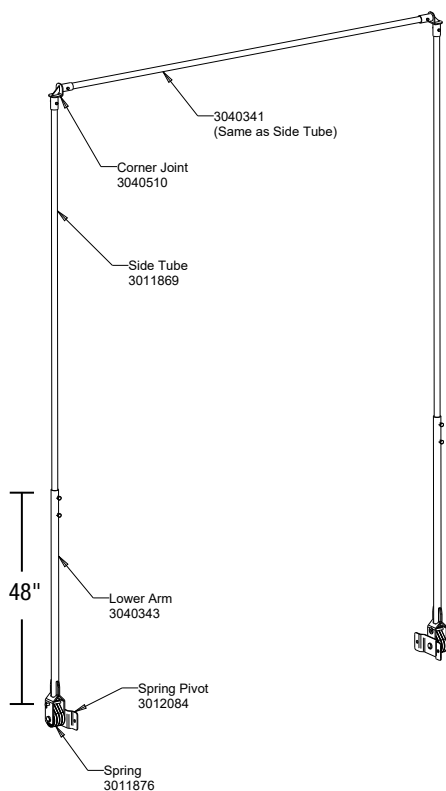

5-SPRING UNIVERSAL STEEL ARM KITS

Part No.	Wt. (lbs.)
3049506	112.78

- Steel spring housing
- Side tube telescopes for 14' - 23' dump bodies
- 30° (3049502), 45° (3049503) and 60° (3049504) tarp joints sold separately

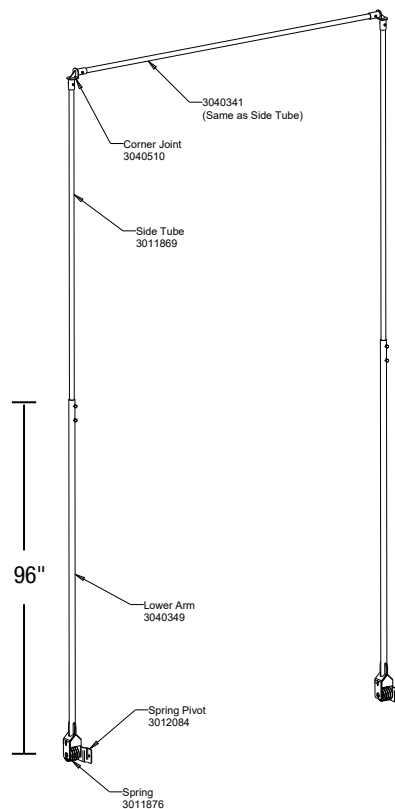

Parts and Accessories

ELECTRIC TARP GEAR MOTORS



- 3-1/8" x 3/4" output shaft
- Bronze alloy gear for extended life
- 5 Mounting holes, fits all 3 and 4-bolt configurations
- Gear motors include chrome-plated plastic cover
- Refer to next page for aftermarket crossover comparison chart

Part No.	Description	Warranty	Watts	HP	Gear Ratio	RPM	Wt. (lbs.)
5541095	BEST SELLER	1 Yr.	600	0.8	90:1	40	13.25
5543095	EXTENDED WARRANTY	3 Yr.	600	0.8	90:1	40	13.25
5541895	HIGH TORQUE	1 Yr.	900	1.2	90:1	40	13.5
5543895	EXTENDED WARRANTY, HIGH TORQUE	3 Yr.	900	1.2	90:1	40	13.5
5541065	HIGH SPEED	1 Yr.	900	1.2	60:1	60	13.5
5543965	EXTENDED WARRANTY, HIGH SPEED	3 Yr.	900	1.2	60:1	60	13.5

Replacement Gear Motor Cover

Part No.	Description	Compares To	Wt. (lbs.)
5541005	Cover for 600W	Donovan® 4278**/1801585	0.59
5541006	Cover for 900W	Donovan® 4278**	0.65

ELECTRIC TARP GEAR MOTORS (AFTERMARKET ONLY)



Part No.	Description	Warranty	Watts	HP	Gear Ratio	Shaft Dia. (in.)	Shaft Length (in.)	RPM	Wt. (lbs.)
5540122	HIGH TORQUE, HIGH SPEED	5 Yr.	900	1.2	73:1	.75	1.45	54	17.7

Compares to Roll-Rite® Super Duty® 10122**



Part No.	Description	Warranty	Watts	HP	Gear Ratio	Shaft Dia. (in.)	Shaft Length (in.)	RPM	Wt. (lbs.)
5540170	HIGH TORQUE, HIGH SPEED	3 Yr.	1500	2.1	60:1	.75	2.55	66	13.9

Compares to Mountain Tarp® K0170S**, US Tarp® 11248**



Part No.	Description	Warranty	Watts	HP	Gear Ratio	Shaft Dia. (in.)	Shaft Length (in.)	RPM	Wt. (lbs.)
5540310	HIGH TORQUE, HIGH SPEED	5 Yr.	900	1.2	60:1	.75	3.09	64	8.3

Compares to Roll-Rite® TarpMaster® 10310**



Part No.	Description	Warranty	Watts	HP	Gear Ratio	Shaft Dia. (in.)	Shaft Length (in.)	RPM	Wt. (lbs.)
5540360	HIGH TORQUE, HIGH SPEED	1 Yr.	900	1.2	60:1	.75	3.09	64	8.3

Compares to Roll-Rite® TarpMaster® 10360**



GEAR MOTOR AFTERMARKET CROSSOVER

Compares To:	Aero ^{®**}	Donovan ^{®**}	Mountain Tarp ^{®**}	Roll-Rite ^{®**}	Shur-Co ^{®**}	Super Winch ^{®**}	Tarps & Beyond ^{®**}	US Tarp ^{®**}
5541005		4278/1801585						
5541095	-	61X & 61L/ 1802061/1802066	-	1030/1031/10310	-	-	5000XT90	11521/13655
5543095	-	61G/1802061	-	-	-	-	-	-
5541895	Power Plus RS/RA	40909	-	-	1703823	719527	-	-
5543895	Power Plus RS/RA	40909 /1704878	K0170TS	-	1703823	719527	-	-
5541065	-	-	K0170S	-	-	-	5000XT60	11521/13655
5543965	-	-	-	-	-	-	-	-
5540310	-	-	-	TarpMaster [®] 10310	-	-	-	-
5540360	-	-	-	TarpMaster [®] 10360	-	-	-	-
5540122	-	-	-	Super Duty [®] 10122	-	-	-	-
5540170	-	-	K0170S/ K0170TS	-	-	-	-	11248

CONNECTOR KIT



Part No.	Wt. (lbs.)
5601015	0.78

- Quick connects
- Used with 6 gauge wire
- 2 per kit
- Comparable to: US Tarp[®] 14316**, Mountain Tarp[®] ETC5011

2-WAY TRAILER CONNECTORS



TC2002



TC2012



TC1002

Comparable to:
Aero[®] 0755-626453
Mountain Tarp[®] K0173
U.S. Tarp[®]14566



TC1012

Comparable to:
Donovan[®] 3848
Roll-Rite[®] 12760
Mountain Tarp[®] 1266
U.S. Tarp[®] 11264

Part No.	Description	Wt. (lbs.)
TC1012	Truck End, Vertical Pins	0.68
TC1002	Truck End, Horizontal Pins	0.68
TC2012	Trailer End, Vertical Pins	0.74
TC2002	Trailer End, Horizontal Pins	0.74

- Provides 12V power connection for trailer mounted tarp systems
- Die-cast metal and 5/16" round brass pins
- Trailer end with cable guard spring

Parts and Accessories

ROTARY SWITCH KIT



Part No.	Wt. (lbs.)
5540710	1.09

- 50 Amp rotary switch
- 4.5"L x 2.3"D x 2.3"H
- Switch bracket
- Red indicator light
- 40A circuit breaker, manual reset
- Comparable to: Aero 0311-962531, Donovan® 85N**, Roll-Rite® 1050**, U.S. Tarp® 11479**, Mountain Tarp K0176**

CIRCUIT BREAKER



Part No.	Wt. (lbs.)
3014119*	0.04

- 40 Amp Manual Reset
- Comparable to: Donovan® 1856, Mountain Tarp K018440, U.S. Tarp® 11156

SWITCH ONLY



Switch Back

Part No.	Wt. (lbs.)
SW710	0.39

- Switch and face plate only. No bracket
- Comparable to: Aero 0755-623456, Donovan® 1110551, Roll-Rite® 1905**, US Tarp® 11129**, Mountain Tarp K017E**

MOTOR REVERSING RELAY



Part No.	Wt. (lbs.)
5541100	0.54

- 12V, 80A
- Sealed, weatherproof
- 6 terminal poles
- Comparable to: Aero 0755-623456, Cole Hersee® 24452**, Donovan® 1464, Mountain Tarp® K0176M**, Roll-Rite® 10698, US Tarp® 13994 EZ Relay**

CIRCUIT BREAKERS



CB60

CB50

Part No.	Wt. (lbs.)
CB50**	0.23
CB60	0.23

**30A-300A ratings also available

- 12V
- Auto reset
- Comparable to: Donovan® 1461**

CONTACT PLATE



Part No.	Wt. (lbs.)
3015127	3

- 12V
- Reduces wire length on long dumps
- Comparable to: Donovan® 1379A**, Mountain Tarp® K0141**, US Tarp® 14995**



ROCKER SWITCH KIT



Complete Kit	
Part No.	Wt. (lbs.)
5541020	2.53

- Everything you need to operate a tarp gear motor:
 - Solenoid with cover
 - Rocker switch with bracket
 - Circuit breaker, 40 amp auto reset
 - Wire harness
 - Fasteners and wire connectors
- Included with all Buyers electric tarp systems

Rocker Switch Kit Items Sold Separately		
Part No.	Description	Wt. (lbs.)
1306600	A—Solenoid Switch	0.76
3014186	B—Optional Solenoid Cover	0.08

- 150A ground coils
- Silver plated contacts
- Ideal for any application that requires reversing motion
- Optional cover sold separately
- Comparable to: Donovan® 1464**, Roll-Rite® 10690**, US Tarp® 10698A** (cover), US Tarp® 12244** (solenoid)

Part No.	Description	Wt. (lbs.)
3014187	C—Rocker Switch	0.1
3014188	D—Rocker Switch Mounting Bracket	0.25

- 12V
- Double momentary open/close
- Switch and bracket sold separately
- Comparable to: Aero 0755-962102 (switch) Donovan® 1800602 (switch), Donovan® 1532** (bracket), Roll-Rite® 19300** (switch), Roll-Rite® 10390** (bracket), US Tarp® 13979** (switch), US Tarp® 10390** (bracket)

Part No.	Description	Wt. (lbs.)
3014214*	E — Auto Reset Circuit Breaker	0.05

- 40 AMP
- Comparable to: Mountain Tarp® K018440, Shur-Co 1704354

3 CONDUCTOR WIRE



Part No.	Gauge	Wt. (lbs.)
3014217	14	1.5

- Copper wire
- Three conductor
- 20'

DUAL CONDUCTOR WIRES



Part No.	Gauge	Wt. (lbs.)
3012783	6	15.4
3020919	8	10.5

- Copper wire
- Dual conductor
- 60'
- Comparable to: Donovan® 88** (6 gauge), Roll-Rite® 1133** (6 gauge), US Tarp® 11148** (6 gauge), Donovan® 2141** (8 gauge), US Tarp® 11279** (8 gauge) Roll-Rite® 100743 (8 gauge)

Parts and Accessories

WIND DEFLECTOR AND END PLATES, FULL TOP



3026457

3026462

3026458

Part No.	Description	Wt. (lbs.)
3026462	Aluminum Wind Deflector	16.93
3026457	End Plate, DS for 3026462	1.45
3026458	End Plate, PS for 3026462	1.45

- 98" Long x 8" Tall x 4" Return

WIND DEFLECTOR AND END PLATES, PARTIAL TOP



3011874

3011871

3011873

Part No.	Description	Wt. (lbs.)
3011871	Aluminum Wind Deflector	12
3011873	End Plate, DS for 3011871	1.45
3011874	End Plate, PS for 3011871	1.45

- 98" Long x 7-1/2" Tall x 1" Return
- Comparable to: Donovan® 1216**

UNDERBODY SPRING PIVOT ASSEMBLY



Part No.	Description	Wt. (lbs.)
3024915	Underbody Spring Assembly, DS	20.5
3024916	Underbody Spring Assembly, PS	20.5

- For electric underbody systems
- Bearings and all mounting hardware included
- 5/8", 15-Coil torsion spring
- Comparable to: Mountain Tarp® K0511B**(DS) K0512B**(PS)

Torsion Springs (DS, PS) Sold Separately

Part No.	Description	Wt. (lbs.)
3024912	Spring, DS	8.14
3024913	Spring, PS	8.14

TARP AXLE



Part No.	Wt. (lbs.)
3011870	14

- Extruded aluminum
- 97" Long x 2" Diameter
- 3/4" tarp hole axle
- Multi-mount accepts screw-in and slide-in tarps
- Comparable to: Donovan® 1809330, 1800737 Roll-Rite® 36940,



SPIRAL TORSION SPRING

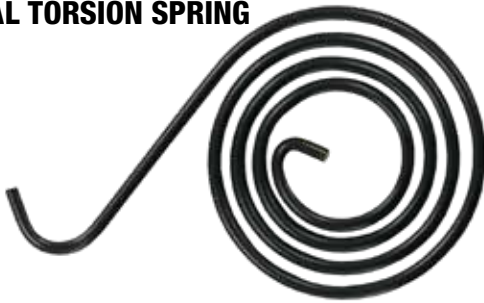

Part No.	Description	Wt. (lbs.)
3011876	Universal Flat Coil Spring	1.1

- 5/8" wide
- Tempered steel construction
- Black powder-coated
- Comparable to: Donovan® 1800763, Roll-Rite® 4723**, US Tarp® 11121**, Mountain Tarp K0199**

TARP STOP BRACKET KIT (PAIR)



Part No.	Wt. (lbs.)
5540001	2.5

- Used with electric and manual tarp arm systems
- Provides extra tarp arm support
- Reduces noise and wear from tarp arm rattle
- Aluminum with rubber landing pad
- Comparable to: Donovan® 1801999, Roll-Rite® 4695**, US Tarp® 11303**

RUBBER CENTERING WEDGE (PAIR)



Part No.	Wt. (lbs.)
5540002	1.23

- Used with electric and manual tarp arm systems
- Provides extra tarp arm support
- Reduces noise and wear from tarp arm rattle
- 8" L x 2-1/2" W x 3" H
- Comparable to: Roll-Rite® 7660**

TARP ARM BUMPER



Part No.	Wt. (lbs.)
3012786	0.27

- Included with Aluminum Tarp Kits
- 3-1/2" dia. x 1-1/4" wide
- Molded polyethylene with nut insert lock

TARP ARM BUMPER



Part No.	Wt. (lbs.)
3054950*	1.76

- Included with aluminum tarp kits
- 3-1/2" dia. x 6" wide
- Molded rubber
- Fits Buyers aluminum & steel tarp arms
- Comparable to: Donovan® 2285, Mountain Tarp® K0420D, U.S. Tarp® 13632

CrankCover™ Manual Arm Tarp Systems



Each System Includes



Die-cast aluminum housing, protects springs and strengthens arm joints



Tarp crank with friction brake (3020293)



(3013299) 10' nickel-plated chain and shaft assembly with (3024748) 18T sprocket and 3/4 x 14" Shaft



CrankCover™ Aluminum & Steel Arm Systems

CRANKCOVER™ ALUMINUM SIDE SPRING PIVOT, WITH DEFLECTOR



Part No.	Number of Springs	Wt. (lbs.)
5543000	3	97

CRANKCOVER™ ALUMINUM SIDE SPRING PIVOT, WITHOUT DEFLECTOR

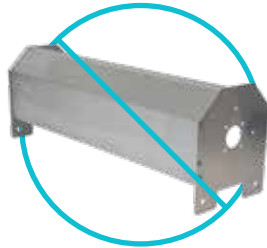

Part No.	Number of Springs	Wt. (lbs.)
5543006	3	85

CRANKCOVER™ STEEL SIDE SPRING PIVOT, WITH DEFLECTOR



Part No.	Number of Springs	Wt. (lbs.)
5543800*	3	156.5

CRANKCOVER™ STEEL SIDE SPRING PIVOT, WITHOUT DEFLECTOR

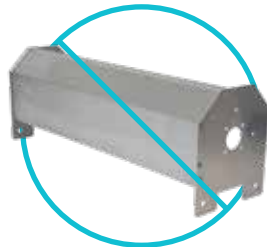

Part No.	Number of Springs	Wt. (lbs.)
5543806*	3	143.33



Tarps sold separately. See page 374-375

CrankCover™ Accessories

CHAIN COVER, DIAMOND TREAD ALUMINUM



Part No.	Wt. (lbs.)
5544622	4.68

- Adjustable, 2-piece design
- Polished aluminum diamond plate

CHAIN COVER, BLACK STEEL



Part No.	Wt. (lbs.)
5544621	19

- Adjustable, 2-piece design
- Black powder-coated steel

Retract-A-Pull™ Tarp Systems with Spring Assist



554275150

Each System Includes



3029712 Carbon steel tension bow catch plate (optional 3029712SS stainless steel catch plate upgrade available)



3029712SS



20' Pull rope with snap hook

Aluminum housing assembly



DTB98A



Retract-A-Pull™ Tarp Systems with Spring Assist

- Spring assist helps keep tension for easy retracting
- 98" Aluminum anti-sail tarp tension bow set with poly arm stops
- Ships pre-assembled with tarp on roller under tension (except 5542000 & 5542090)

RETRACT-A-PULL™ SYSTEM WITH MESH TARP



Part No.	Housing Length	Tarp Dimensions	Wt. (lbs.)
554250120	64"	5' x 12'	97.5
554260140	76"	6' x 14'	99.5
554265150	82"	6-1/2' x 15'	100.5
554265157*	84"	6-1/2' x 15'	71
554270155	88"	7' x 15'	100
554270150	91"	7' x 15'	101
554275150	96"	7-1/2' x 15'	102

- Comes pre-assembled

RETRACT-A-PULL™ SYSTEM WITH SOLID TARP



Part No.	Housing Length	Tarp Dimensions	Wt. (lbs.)
554260140	76"	6' x 14'	99.5
554265158*	84"	6-1/2' x 15'	91
554270156	88"	7' x 15'	102
554270152	91"	7' x 15'	105
554275152	96"	7-1/2' x 15'	108

- Comes pre-assembled

RETRACT-A-PULL™ SYSTEM HARDWARE KIT ONLY (TARP SOLD SEPARATELY)



Part No.	Housing Length	Wt. (lbs.)
5542000	96"	92
5542090	91"	90.5

- Does not come pre-assembled

OPTIONAL STAINLESS STEEL TENSION BOW CATCH PLATE



Part No.	Description	Wt. (lbs.)
3029712SS	9.15" x 3.5"	.79

Note: All of the above kits include black powder-coated tension bow catch plate. Upgrade to stainless steel by purchasing separately. Sold as a single unit



For additional tarps see page 374-375

PullCover™ Manual Tarp Systems

Tarp rollers with telescoping aluminum cross bars to fit exact width of truck

Solid or mesh tarp

DTB102 tarp tension bow (optional)

DTR7012

Each System Includes



Standard sewn-in pocket works with optional DTB96, DTB98A and DTB102 rear anti-sail tarp tension bow sets. *see pg. 370*



20' Pull rope with snap hook

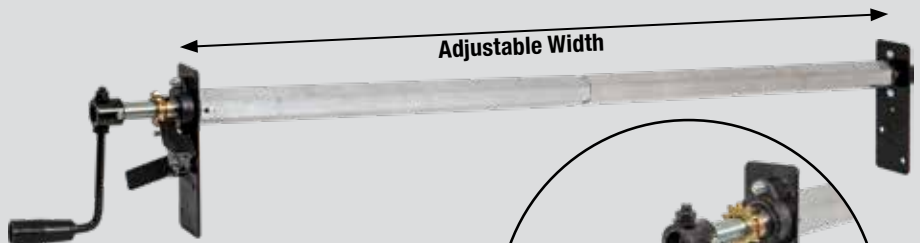

Mounting hardware included:
Tarp rollers, rope, tie down hooks, rubber straps and S-hooks





DTR7018

PULLCOVER™ ADJUSTABLE HEXAGONAL AXLE KIT (DTR SERIES), WITH MESH TARP



Part No.	Tarp Dimensions	Wt. (lbs.)
DTR5012	5' x 12'	24.75
DTR5014	5' x 14'	25
DTR5514	5-1/2' x 14'	28
DTR6014	6' x 14'	28
DTR6016	6' x 16'	27.01
DTR6515	6-1/2' x 15'	29
DTR6518	6-1/2' x 18'	28.5
DTR7012	7' x 12'	26.55
DTR7015	7' x 15'	31.5
DTR7018	7' x 18'	33
DTR7020	7' x 20'	35
DTR7022	7' x 22'	35
DTR7512	7-1/2' x 12'	29.5
DTR7515	7-1/2' x 15'	31
DTR7518	7-1/2' x 18'	33
DTR7520	7-1/2' x 20'	36
DTR8018	8' x 18'	33
DTR8022	8' x 22'	37

PULLCOVER™ ADJUSTABLE HEXAGONAL AXLE KIT (DTR SERIES), WITH SOLID TARP



Part No.	Tarp Dimensions	Wt. (lbs.)
DTR7015S	7' x 15'	36.5
DTR7018S	7' x 18'	40.5
DTR7021S	7' x 21'	43.5
DTR7515S	7-1/2' x 15'	38
DTR7520S	7-1/2' x 20'	42.5

PULLCOVER™ ADJUSTABLE HEXAGONAL AXLE KIT (DTR SERIES), TARP SOLD SEPARATELY



Part No.	Tarp Dimensions	Wt. (lbs.)
DTR	—	19.25

PullCover™ Manual Tarp Systems

PULLCOVER™ ADJUSTABLE HEXAGONAL AXLE KIT (DTR SERIES) WITH GROUND-LEVEL CRANK, TARP SOLD SEPARATELY



PULLCOVER™ ADJUSTABLE HEXAGONAL AXLE KIT (DTR SERIES) WITH SHORTER END MOUNT BRACKET, TARP SOLD SEPARATELY



TAPERED CAB SHIELD MOUNTING BRACKETS



Tapered Cab Shield DTR1 Mounting Brackets for DTR, DTR1 & DTG

Part No.	Description	Wt. (lbs.)
DTG	DTG Manual Dump Tarp Kit	30

- DTG series kits include all DTR kit hardware, but swap out DTR handle with a low-mounted crank and chain set. Crank includes friction brake

Part No.	Description	Wt. (lbs.)
DTR1	DTR1 Manual Dump Tarp Kit Specifically for Pre-Drilled Centers on Rugby® Dump Bodies	16.25

- Crank system *specifically for pre-drilled 3-1/4" bearing bolt centers on Rugby® Dump Bodies*



DTR1
Alternate Mounting

Part No.	Description	Wt. (lbs.)
3031692	Used on Crysteel® Dump Body	7
3031808	Used on Rugby® Dump Body	7

- Provides a 'square' mounting surface for dump bodies with tapered cab shields
- Black powder-coated steel
- For use with DTR1 tarp kits only



PULLCOVER™ ADJUSTABLE HEXAGONAL AXLE KIT WITH DEFLECTOR (TDH SERIES), MESH TARP **NEW**



Part No.	Tarp Dimensions	Wt. (lbs.)
TDH7512	7.5' x 12'	49.5
TDH7515	7.5' x 15'	51
TDH7518	7.5' x 18'	53

- Additional tarp sizes available on request



PULLCOVER™ ADJUSTABLE ROUND AXLE KIT (DTT SERIES), SOLID OR MESH TARP **NEW**



– OR –

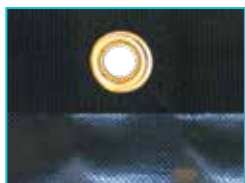

Part No.	Tarp	Tarp Dimensions	Wt. (lbs.)
DTT7018S	Solid	7' x 18'	33-15
DTT5012	Mesh	5' x 12'	23.4
DTT5511	Mesh	5.5' x 11'	23.3
DTT6014	Mesh	6' x 14'	25.5
DTT6515	Mesh	6.5' x 15'	26.5
DTT6518	Mesh	6.5' x 18'	28
DTT7012	Mesh	7' x 12'	25.3
DTT7015	Mesh	7' x 15'	27.15
DTT7018	Mesh	7' x 18'	29
DTT7512	Mesh	7.5' x 12'	27.48
DTT7515	Mesh	7.5' x 15'	27.8
DTT7518	Mesh	7.5' x 18'	29.75
DTT7520	Mesh	7.5' x 20'	30.85
DTT8018	Mesh	8' x 18'	27.48
DTT8022	Mesh	8' x 22'	33

- Same as "DTR" kits, but with 2.34" diameter round aluminum tubing, .18" aluminum end mounting plates and detented crank handle

PULLCOVER™ ADJUSTABLE ROUND AXLE (DTT SERIES), TARP SOLD SEPARATELY **NEW**



Part No.	Tarp	Dimensions	Wt. (lbs.)
DTT	–	Adjustable width	18

Comparable to Donovan® TurboTarp 2™

- Same as "DTR" kits, but with 2.34" diameter round aluminum tubing, .18" aluminum end mounting plates and detented crank handle



Parts and Accessories

REAR ANTI-SAIL TARP TENSION BOW SETS

- Fits into rear pocket tarp sleeve
- Works with manual dump tarp systems



★
GOOD



Part No.	Description	Wt. (lbs.)
DTB96	96" Black Powder- Coated Steel	11.5

- Black powder-coated steel
- Steel collars



★★
BETTER



Part No.	Description	Wt. (lbs.)
DTB98A	98" Aluminum	8.0

- Lightweight, corrosion resistant aluminum
- Corrosion resistant, poly collars



★★★
BEST



Part No.	Description	Wt. (lbs.)
DTB102	102" Black Powder-Coated Steel with Rollers	14.0

- Rollers provide smooth extension and retraction
- Plated steel collars



★★★★
BEST



Part No.	Description	Wt. (lbs.)
DTB102A*	102" Aluminum pipe with Rollers	14.0

- Rollers provide smooth extension and retraction
- Aluminum collars

STAMPED FLANGE BEARING



Part No.	Diameter	Wt. (lbs.)
3012784	3/4"	0.46

- 3/4" dia. flange bearing
- 3-1/4" bolt centers
- Used on Buyers electric kits and manual kits with arms
- Comparable to: US Tarp® 145**

CAST FLANGE BEARING



Part No.	Diameter	Wt. (lbs.)
1411000	1"	0.86

- 1" dia. flange bearing
- 3" bolt centers
- Used with DTR manual tarp arm systems

RUBBER TARP STRAPS

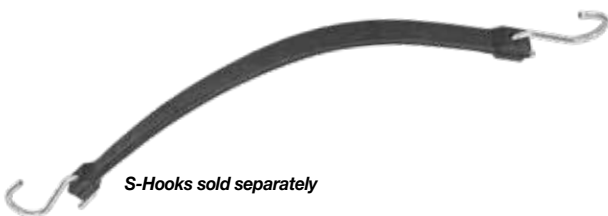

S-Hooks sold separately

Part No.	Description	Wt. (lbs.)
TS9	9" Rubber Tarp Strap (100/carton)	0.11
TS15	15" Rubber Tarp Strap (100/carton)	0.12
TS20	20" Rubber Tarp Strap (100/carton)	0.15
TS31	31" Rubber Tarp Strap (50/carton)	0.25
TS41	41" Rubber Tarp Strap (50/carton)	0.30

- EPDM rubber provides outstanding resistance to extreme weather conditions
- Heavy duty square ends for strength/tear resistance
- Made in USA

S-HOOK



Part No.	Length	Quantity per Carton	Wt. (lbs.)
9225	2.5"	100	4

- Sold separately from tarp straps
- 0.180" diameter
- Zinc-plated

Parts and Accessories

REPLACEMENT HANDLES

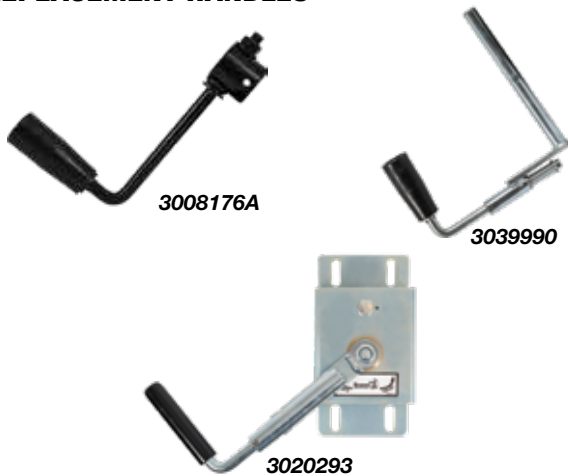

Part No.	Description	Wt. (lbs.)
3008176A	for DTR Series	1.44
3039990	for DTT Series	2.4
3020293	for Manual Arm 5543100 Series (Includes Brake)	6.44

- 3039990 Comparable to: US Tarp® 11661**
- 3020293 Comparable to: Donovan® 1800656, 1800088

ROPE ASSEMBLY



Part No.	Length	Wt. (lbs.)
3008225	20'	0.65

- 3/8" x 20' poly rope
- 3-5/16" snap hook
- Used on all manual and Pull-Style tarp arm systems

5 INCH LONG BINDING HOOKS



Part No.	Description	Wt. (lbs.)
B2448C	Bolt-On, Zinc Plated Binding Hook	0.29

- 1/2" Round cross section
- 11/32" Mounting holes (B2448C)

3-1/4 INCH LONG BINDING HOOKS

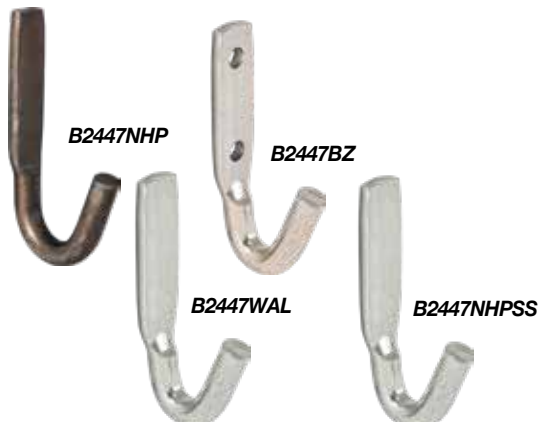

Part No.	Description	Wt. (lbs.)
B2447NHP	Weld-On, Tarp Hook	0.14
B2447BZ	Bolt-On, Zinc Plated Tarp Hook	0.13
B2447WAL	Weld-On Alum. Tarp Hook	0.15
B2447NHPSS	Weld-On, Stainless Steel Tarp Hook	0.00

- 3/8" Round cross section
- 9/13" Mounting holes (B2447BZ)



SQUARE GUDGEON



Part No.	Wt. (lbs.)
3027070	0.64

- 1-1/2" Cast steel tarp gudgeon
- Fits 2" pipe
- 3/4" Square key replacement
- Interchanges with Shur-Co® 1105033*

TARP JOINTS



Part No.	Description	Wt. (lbs.)
3001894	Roll Tarp Joint, 1-1/4" R, 3/8" PH x 1-3/8" 21	4.64
3001895	Male 21 Spline x 1-13/16" Male Stub Shaft	1.54

- Used with ground control tarp rollers
- Zinc-plated
- 3001894 Comparable to: U.S. Tarp® 1701243

CRANK ARM DRIVE



Part No.	Description	Wt. (lbs.)
3013299	10' Nickel-Plated Chain with Master Link	4.34
3024748	3/4" x 14" Shaft Assembly with 18T Sprocket	2.17

Works with 5543000 and 5543006 manual tarp arm systems

Mesh Tarps

HEAVY DUTY, MESH BLACK TARPS

- UV resistant, PVC coated vinyl with 1,000 denier polyester mesh
- Heavy duty double stitch hem
- Full perimeter brass grommets
- All hems reinforced with 2" heavy duty nylon webbing
- Front & Rear Full-width Tarp pockets for front axle and rear tension bow

12 oz.



Part No.	Dimensions (W x L)	Wt. (lbs.)
3047804*	6'8" x 18'	11
3011036	7' x 12'	7.3
3008210	7' x 15'	9.15
3042795	7'2" x 15'	10
3009456	7' x 18'	11
3009457	7' x 20'	12.54
3022116	7' x 22'	13.91
3042796	7'2" x 22'	14.5
3013395	7' x 24'	14.7
3013396	7' x 28'	17.15
3011035	7-1/2' x 12'	9.48
3008209	7-1/2' x 15'	9.8
3009458	7-1/2' x 18'	11.75
3009095	7-1/2' x 20'	12.85
3013397	7-1/2' x 24'	15.42
3013398	7-1/2' x 28'	18
3022117	8' x 18'	9.48
3009892	8' x 22'	15

* Front Pocket Only

MESH ROLL-OFF CONTAINER TARPS



3016005

Part No.	Dimensions (W x L)	Wt. (lbs.)
3016005	12' x 24'	24.25
3016006	12' x 26'	26.25

Tarp straps sold separately



HEAVY DUTY, SOLID VINYL BLACK TARPS

- Solid vinyl 18 oz. tarp is rated up to **330° F for asphalt (non-contact)**
- Heavy duty double stitch hem
- Full perimeter brass grommets
- All hems reinforced with 2" heavy duty nylon webbing
- Full Width Front & Rear Full-width Tarp pockets for front axle and rear tension bow

18 oz.

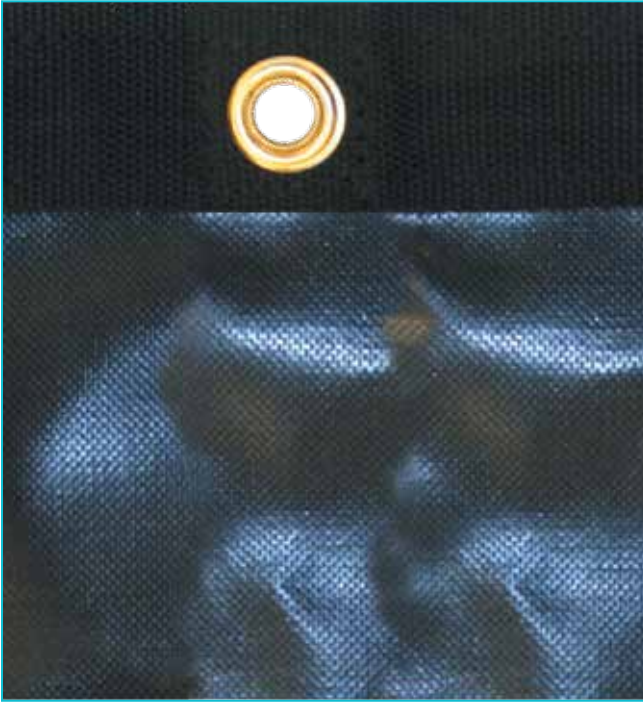

Part No.	Dimensions (W x L)	Wt. (lbs.)
3042304	6'5" x 15'	11
3011352	7' x 15'	13
3011351	7' x 18'	15
3016004	7' x 21'	22.37
3011353	7-1/2' x 15'	16.05
3011354	7-1/2' x 20'	17

SELECTING THE RIGHT TARP SIZE

Tarp length should typically be 2' to 3' longer than A & B combined. Tarp width should typically be no wider than C, provided it still covers the inside body width. Exceeding the dump body width can cause tarp to tangle when rolling up.

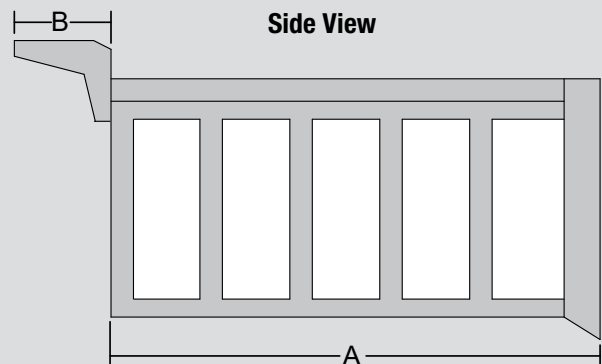
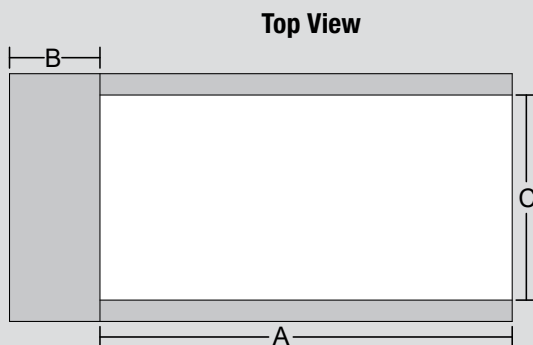

Tarp Aftermarket Crossover

BPC Part #	Description	Aero® Part #	Donovan® Part #	Mountain Tarp® Part #	Roll-Rite® Part #	US Tarp® Part #
Tarp Gear Motor						
5540170	1500W Gear Motor 60:1					11248
5541005	Bulletproof Slim 12 Volt Motor, Chrome Cover		4278/1801585			
5541095 or 5543095	600W Gear Motor, 90:1	0755-623457-SQ	1802061-66	K0170S	1030/1031	11521
5541065 or 5543965	Standard Bulletproof, 60:1	0755-623474	61G	K0170S		13732
5541095 or 5543095	Standard Bulletproof, 90:1	0755-623474	61G/1802061	K0170TS	10120	13957
5543895	Bulletproof HD, 90:1		4422/1704878	K0170TS		
5540122	Powerhouse Heavy Duty Tarp Motor				10122	
Electrical						
5541101	EZ Switch Kit	0755-962131	1495	K0176Q		12250
5541100	EZ Switch Relay	0755-623560	1464	K0176M	10698	13994
3014188	Aluminum Switch Bracket		1532		10390	14243
3014187	Rocker Switch	0755-962102	1897	K0176SO	19300	13979
3020919	8 Gauge Dual Conductor Wire		2141		100743	11279
3012783	6 Gauge Dual Conductor Wire	0755-626535		K0146	11330	11147
TC3012	Dual Conductor Plug Set - Vertical		3848	1266	12760	11264
TC3002	Dual Conductor Plug Set - Horizontal	0755-626453		K0173		14566
5540710	Rotary Switch Kit	0311-962531	85N	ETC5014		11479
SW710	Rotary Switch	0755-623456	600	K0176		11129
3015127	Trailer Contact Plate	0755-960150	4241	K0141	101736	14995
5601015	Connector Kit			ETC5011		14316
TC1012	Truck End, Vertical Pins		3848	1266	12760	11264
TC1002	Truck End, Horizontal Pins	0755-626453		K0173		14566
TC2012	Trailer End, Vertical Pins		3848	1266	12760	11264
TC2002	Trailer End, Horizontal Pins			K0173		14566
1306600	Solenoid Switch		1464		10690	12244
3014186	Solenoid Switch Cover				10690	10698A
3014119*	40 Amp Circuit Breaker, Manual		1856	K018440		11156
3014214*	40 Amp Circuit Breaker, Auto			K018440		
CB50	Circuit Breaker, Auto		1461			
CB60	Circuit Breaker, Auto		1461			
Cable System						
3050389	#40 Chain with Master Link, 12ft	0720-603557	1115	Z2007		11285
Tarp Spool						
3020293	Ground Level Crankbox		441	K0340		11668
3024748	Upper 18-Tooth Sprocket & Shaft		2403	K0105A		12357
3050389	#40 Chain with Master Link, 12ft		793	K0220		11285
5544621	Steel Chain Guard		114	K0201		12230
3011871	Aluminum Wind Deflector		1216			
3011873	End Plate, DS for 3011871		1216			
3011874	End Plate, PS for 3011871		1216			
3024915	Underbody Spring Assembly, DS			K0511B		
3024916	Underbody Spring Assembly, PS			K0512B		
Pivot						
3024756	3-Spring Pivot Pin		45330		45330	11183
3012781	4-Spring Pivot Pin		45340	K0256	45340	11132
3012781	5-Spring Pivot Pin		45350	K0257	45350	11272
3011876	Spiral Torsion Spring			K0199		11121
3001432	External Retaining Ring for Pivot Pin		47000	K0258	47000	11142
3011876	Universal Flat Coil Spring		4723	K0199	4723	11121
Accessories/Hardware						
3039990	Fold-away Crank Handle for Cab Level	0311-961089	4128	K0330L		11661
3054950*	Tarp Arm Rubber Bumper		2285	K0420D		13632
5540002	Rubber Centering Wedge				7660	
5540001	Tarp Stop Bracket Kit				4695	11303



Hydraulics



Product Shown:
SMR25S 25 Gallon Side Mount
Steel Reservoir

Reservoirs	378 - 385
Reservoir Accessories	386 - 389
Sensor Kits & Diffusers	390
Strainers	391
Filtration Kits	392
Filters	393 - 395
Pressure Switches	396
Wetline Kits	397 - 398
Hoses and Accessories	399 - 400
Clamps	401 - 403
Couplers	404 - 406
PTOs	407

Hydraulic Pumps	408 - 411
Air Shift Cylinders	412
Gauges	413
Motors	414
Directional Control Valves	415
Sectional Valves	416 - 417
Valves	418 - 420
Gate and Ball Valves	421
Spreader Valves	422 - 423
Central Hydraulic Systems	424 - 427
Power Units	428 - 430
Fittings	431 - 434

Reservoirs

STEEL RESERVOIRS

- Tough gauge H.R.P.O. steel construction and 1/4 turn chrome filler breather with strainer
- Interior baffle between suction and discharge
- Magnetic drain plug
- Corrosion resistant black powder-coated finish

7 GALLON SIDE MOUNT STEEL RESERVOIR



SMR7S

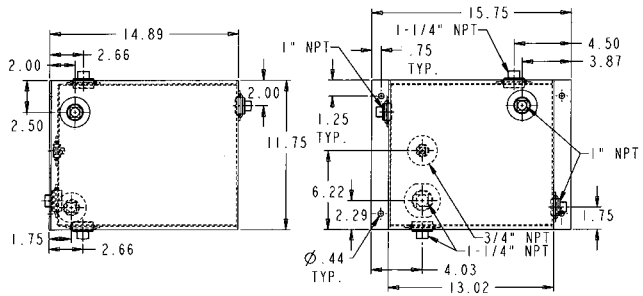

Part No.	Capacity (Gal.)	Usable Capacity (Gal.)	Material Gauge	Mount Position	Height	Depth	Width	Wt. (lbs.)
SMR7S	7	7	12 Gauge Steel	Side Mount	11.8	14.89	15.75	36

15 GALLON SIDE MOUNT STEEL RESERVOIR

- Oil level gauge with temperature indicator
- Large NPT suction/return ports & suction/return ports
- Pre-drilled for tank mounted filter, includes HFA91025 or HFA92525 only for SMR15SF10 & SMR15SF25 (shipped separately)



SMR15S



SMR15SF10

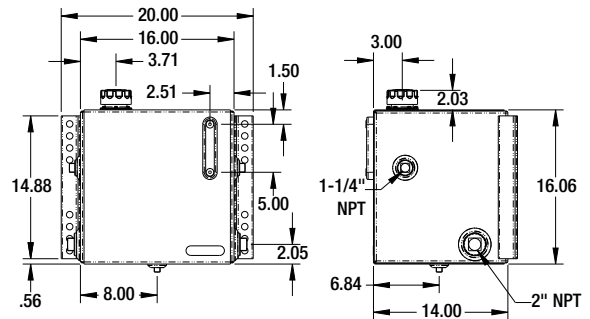

Part No.	Mircon Filter	Capacity (Gal.)	Usable Capacity (Gal.)	Material Gauge	Mount Position	Height	Depth	Width	Wt. (lbs.)
SMR15S	none	15	11	13 Gauge Steel	Side Mount	16.1	14.50	20.00	53
SMR15SF10	10 Micron Filter	15	11	13 Gauge Steel	Side Mount	16.1	14.50	20.00	58.13
SMR15SF25	25 Mirco Filter	15	11	13 Gauge Steel	Side Mount	16.1	14.50	20.00	57.93

25 GALLON SIDE MOUNT STEEL RESERVOIR

- Oil level gauge with temperature indicator
- Large 2" NPT suction/return ports & 1.25" suction/return ports
- Pre-drilled for tank mounted filter, includes HFA91025 or HFA92525 only for SMR25SF10 & SMR25SF25 (shipped separately)



SMR25S



SMR25SF10

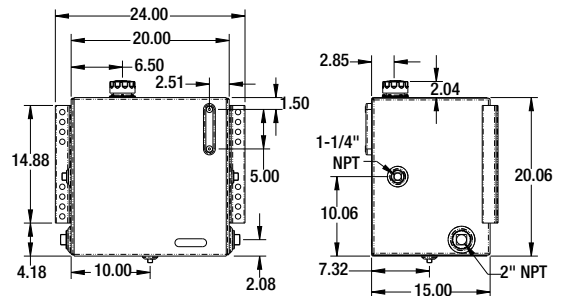

Part No.	Mircon Filter	Capacity (Gal.)	Usable Capacity (Gal.)	Material Gauge	Mount Position	Height	Depth	Width	Wt. (lbs.)
SMR25S	none	25	18	13 Gauge Steel	Side Mount	20.06	15.00	24.00	71
SMR25SF10	10 Micron Filter	25	18	13 Gauge Steel	Side Mount	20.06	15.00	24.00	73
SMR25SF25	25 Mirco Filter	25	18	13 Gauge Steel	Side Mount	20.06	15.00	24.00	73



Reservoirs

STEEL RESERVOIRS - continued

- Tough gauge H.R.P.O. steel construction and 1/4 turn chrome filler breather with strainer
- Interior baffle between suction and discharge
- Magnetic drain plug
- Corrosion resistant black powder-coated finish

70 GALLON SIDE MOUNT STEEL RESERVOIR

- Oil level gauge with temperature indicator
- Standard removable clean out cover
- Can accommodate tank-mounted HFA6 series return line filters



SMS70SQ

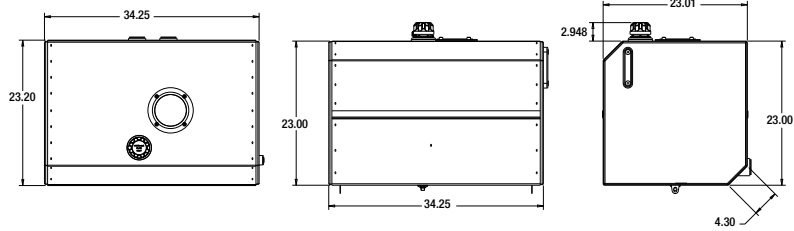

Part No.	Capacity (Gal.)	Usable Capacity (Gal.)	Material Gauge	Mount Position	Height	Depth	Width	Wt. (lbs.)
SMS70SQ	70	70	13 Gauge Steel	Side Mount	23	35.00	23.020	134

Accessories:

Part No.	Description	Wt. (lbs.)
SMS005BK	Bracket Kit For Side Mount Steel Hydraulic Reservoirs SMS50S And SMS70S	49.1

UPRIGHT STEEL RESERVOIR

- Upright design fits conveniently behind truck cab
- Includes level/temperature sight gauge
- Includes mounting hardware



UR50S

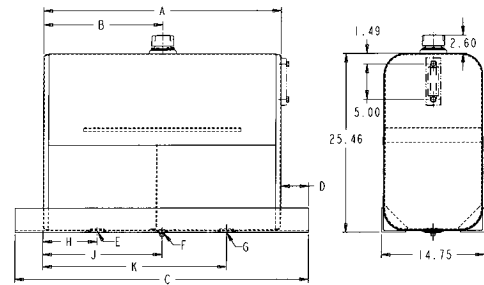

PART NO.	A	B	C	D	E	F	G	H	J	K
UR50S	34.00	17.00	42.00	4.00	1-1/4"NPT	3/4"NPT	2"NPT	7.75	17.00	26.25
UR70S	49.25	24.62	53.75	2.25	1-1/4"NPT	3/4"NPT	2"NPT	16.62	24.62	32.62

Part No.	Capacity (Gal.)	Usable Capacity (Gal.)	Material Gauge	Mount Position	Height	Depth	Width	Wt. (lbs.)
UR50S	50	50	12 Gauge Steel	Upright	25.5	34.00	14.750	151
UR70S	70	67.5	12 Gauge Steel	Upright	25.5	49.25	14.750	201

Accessories:

Part No.	Description	Wt. (lbs.)
UR50MK	Spring Kit For Upright Steel Hydraulic Reservoirs UR50S And UR50A	1.6

36 GALLON STEEL BULKHEAD RESERVOIR

- 10 or 25 micron in-tank return line filter and (2) 2" NPT suction ports (on each side)
- (1) 100 mesh (150 micron) stainless steel strainer and Nylon filler strainer-breather cap with 30 mesh strainer
- 1" built-in sight gauge standard with ports for optional LDR02A sight-temperature gauge
- (2) 0.824" diameter for through-tank mounting bolts
- 5/8" chain lifting loop



BH36SF10

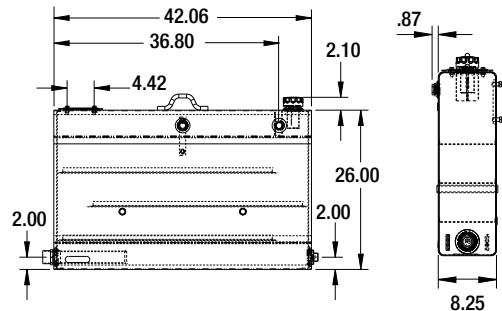

Part No.	Mircon Filter	Capacity (Gal.)	Usable Capacity (Gal.)	Material Gauge	Mount Position	Height	Depth	Width	Wt. (lbs.)
BH36SF10	10 Micron Filter	36	32	Carbon Steel	Upright	26	8.50	42.00	132
BH36SF25	25 Mirco Filter	36	32	Carbon Steel	Upright	26	42.00	8.50	132



STAINLESS STEEL RESERVOIRS

- 304 stainless steel construction with welded mounting angles and 1/4 turn nylon chrome filler breather with strainer
- Oil level gauge with temperature indicator
- Interior baffle between suction and discharge
- Magnetic drain plug

15 GALLON STAINLESS STEEL RESERVOIR

- Large 2" NPT suction/return ports & 1.25" suction/return ports
- Pre drilled for tank mounted filter, SMR15SSF10 and SMR15SSF25 included with HFA91025 or HFA92525 (shipped separately)



SMR15SS



SMR15SSF10

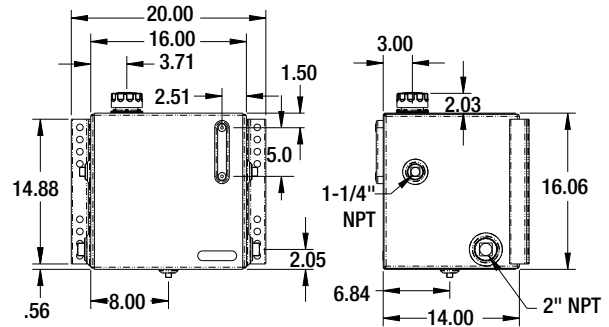

Part No.	Mircon Filter	Capacity (Gal.)	Usable Capacity (Gal.)	Material	Mount Position	Height	Depth	Width	Wt. (lbs.)
SMR15SS	none	15	11	Stainless Steel	Side Mount	16.06	14.00	20.00	53
SMR15SSF10	10 Micron Filter	15	11	Stainless Steel	Side Mount	16.06	14.00	20.00	55.8
SMR15SSF25	25 Mirco Filter	15	11	Stainless Steel	Side Mount	16.06	14.00	20.00	55.8

15 GALLON STAINLESS STEEL RESERVOIRS WITH VALVE ENCLOSURE

- 3/4", 1", & 1-1/4" NPT return ports on front with 2" NPT suction port and a 3/4" NPT port on top, inside enclosure
- 26 GPM tank mounted return line filter, 1-1/4 port
- Water resistant valve enclosure and removable valve mounting and hose routing plate
- 2" suction strainer
- Nylon rust free filler/breather unit



SMR15VESS



SMR15VESSC

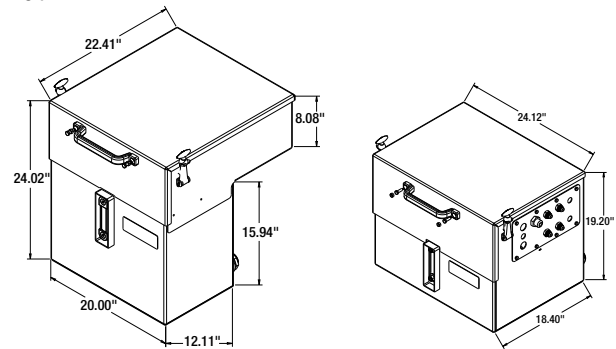

Part No.	Capacity (Gal.)	Usable Capacity (Gal.)	Reservoir Type	Material	Mount Position	Height	Depth	Width	Wt. (lbs.)
SMR15VESS	15	11	Standard	Stainless Steel	Side Mount	24.0	22.41	20.00	65.005
SMR15VESSC	15	11	Compact	Stainless Steel	Side Mount	19.2	18.40	24.12	131.9

SMR15VESS shown



Reservoirs

STAINLESS STEEL RESERVOIRS - continued

- 304 stainless steel construction with welded mounting angles and 1/4 turn nylon chrome filler breather with strainer
- Oil level gauge with temperature indicator
- Interior baffle between suction and discharge
- Magnetic drain plug

30 GALLON STAINLESS STEEL RESERVOIR

- 1-1/4" NPT suction port
- Pre drilled for tank mounted filter, SMR30SSF10 and SMR30SSF25 included with HFA91025 or HFA92525 (shipped separately)



SMR30SS



SMR30SS10

Part No.	Mircon Filter	Capacity (Gal.)	Usable Capacity (Gal.)	Material	Mount Position	Height	Depth	Width	Wt. (lbs.)
SMR30SS	none	30	30	Stainless Steel	Side Mount	20	18.38	20.75	92
SMR30SS10	10 Micron Filter	30	30	Stainless Steel	Side Mount	22	17.00	28.35	98.35
SMR30SS25	25 Mirco Filter	30	30	Stainless Steel	Side Mount	22	17.00	28.35	98.7

30 GALLON STAINLESS STEEL RESERVOIR WITH VALVE ENCLOSURE

- 304 stainless steel construction will stand up to salt and weather
- Features water-resistant stainless enclosure for the valve
- All-in-one design makes removal, access, and installation simple
- Includes 50 GPM tank-mounted return filter
- Includes fluid level/temperature gauge and nylon rust-resistant filler/breather



SMR30VESS



SMR30VESS1

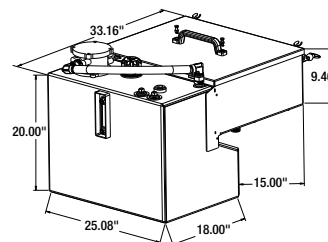

SMR30VESS

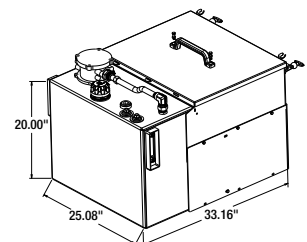

SMR30VESS1

Part No.	Side Cover	Capacity (Gal.)	Usable Capacity (Gal.)	Material	Mount Position	Height	Depth	Width	Wt. (lbs.)
SMR30VESS	No	30	30	Stainless Steel	Side Mount	20.0	33.16	25.08	264
SMR30VESS1	Yes	30	30	Stainless Steel	Side Mount	20.0	33.16	25.08	230



ALUMINUM RESERVOIRS

- Durable, light-weight aluminum construction for appearance and corrosion resistance

SIDE MOUNT CYLINDRICAL ALUMINUM RESERVOIR

- Versatile reservoir works for many hydraulic/fluid storage applications
- Features 2 in. NPT suction/return ports on either end of the tank (SMC25A has 1-1/4 in. NPT Ports)
- Attractive cylindrical design matches many fuel tanks for a neat, coordinated appearance
- Mounting hardware, insulated mounting straps, and a filler breather unit with basket strainer included (SMC25A includes level temp. gauge)

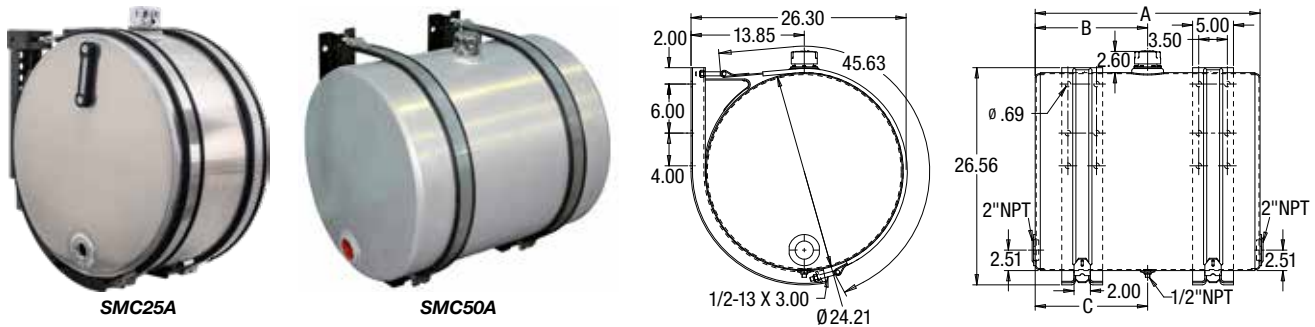

Part No.	Capacity	Usable Capacity	Material	Mount Position	Dia. (in.)	Width (A) (in.)	Width (B) (in.)	Width (C) (in.)	Wt. (lbs.)
SMC25A	25	25	Aluminum	Side Mount	24.21	14.38	7.19	77.3	65.00
SMC35A	35	35	Aluminum	Side Mount	24.21	19.25	9.63	9.63	69.86
SMC50A	50	50	Aluminum	Side Mount	24.21	27.50	13.75	13.75	77.83
SMC70A	70	70	Aluminum	Side Mount	24.21	39.50	19.75	19.75	88.65

SIDE MOUNT CYLINDRICAL ALUMINUM RESERVOIR WITH REAR PORTS

- Features dual rear 2 in. NPT suction/return ports for clean routing
- Durable, light-weight aluminum construction is extremely corrosion resistant and looks like a natural extension of your truck
- Internally baffled to reduce sloshing
- Versatile reservoir works for many hydraulic/fluid storage applications
- Heavy duty mounting brackets wrap underneath the tank for superior stability and support
- Insulated stainless steel mounting straps, temperature/level gauge, and Chrome-Plated Polymer Filler-Strainer Breather Cap included

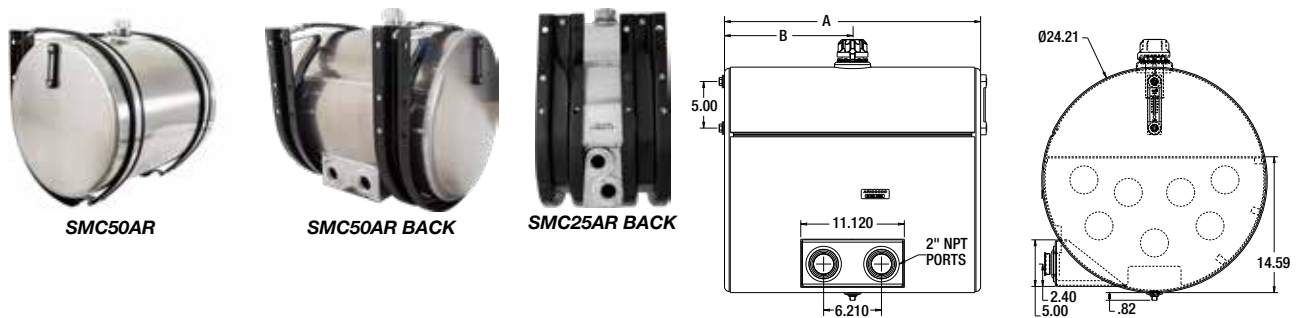

Part No.	Capacity	Usable Capacity	Material	Mount Position	Dia. (in.)	Width (A) (in.)	Width (B) (in.)	Wt. (lbs.)
SMC25AR	25	25	Aluminum	Side Mount	24.21	14.38	7.19	77.3
SMC35AR	35	35	Aluminum	Side Mount	24.21	19.0	9.63	83.07
SMC50AR	50	50	Aluminum	Side Mount	24.21	24.21	13.75	90.7
SMC70AR	70	70	Aluminum	Side Mount	24.21	39.5	19.75	101.5

SADDLE MOUNT BRACKET KIT FOR SMC SERIES RESERVOIRS & WETLINE KITS

- Work with all Buyers Products Company SMC Series saddle tanks and with others that are 24 inch in diameter
- Narrow width brackets accommodate shorter length tanks
- Includes two black powder-coated mounting brackets, stainless steel straps, rubber insulators and hardware
- **Universal mounting holes on rear of brackets match bolt pattern used on American Mobile® J-Bracket P/N- AMK-624**



Part No.	For Use With	Wt. (lbs.)
3054626	SMC Series reservoirs	40
SMC007BK	Wetline kits with 24in. dia. round tanks	40

Reservoirs

ALUMINUM RESERVOIRS - continued

25 GALLON SIDE MOUNT ALUMINUM RESERVOIR WITH MICRON FILTER

- Lightweight, high-quality aluminum construction
- Pre-drilled for an included 10 or 25 micron filter (shipped separately)
- Contaminant-catching magnetic drain plug
- Fluid level and temperature gauge included
- Interior baffle aids in fluid cooling
- Fully tested for optimal operation



SMR25AF10

Part No.	Capacity	Depth	Height	Material	Mount Position	Width	Usable Capacity	Wt. (lbs.)
SMR25AF10	25	15.04	20.15	Aluminum	Side Mount	24.00	25	42.8
SMR25AF25	25	15.04	20.15	Aluminum	Side Mount	24.00	25	42.6

UPRIGHT ALUMINUM RESERVOIR

- Upright design fits conveniently behind truck cab
- Quality aluminum construction for lighter weight and excellent heat dissipation
- Attractive diamond-tread design on upper half
- Fully baffled to keep oil cool and moving correctly
- Includes level/temperature sight gauge
- Includes mounting hardware



UR35A

Part No.	Capacity	Depth	Height	Material	Mount Position	Width	Usable Capacity	Wt. (lbs.)
UR35A	35	7.95	24.00	Aluminum	Upright	41.75	35	69
UR50A	50	14.13	24.85	Aluminum	Upright	33.88	50	69
UR70A	70	49.25	25.5	Aluminum	Upright	14.750	70	151

Accessories:

Part No.	Description	Wt. (lbs.)
UR50MK	Spring Kit For Upright Steel Hydraulic Reservoirs UR50S And UR50A	1.6



UR35A shown



POLYMER RESERVOIRS

25 GALLON SIDE-MOUNT POLYMER RESERVOIR

- Ideally sized for smaller trucks
- Durable and rustproof heavy duty (.375 in. minimum thickness) polymer
- 40 micron filler cap and sight fluid level/temperature gauge help protect your hydraulic system
- Easily adapts to two or three lines for most dump trailer applications
- Designed for short cycle time applications



SMR25P

Part No.	Capacity	Depth	Height	Material	Mount Position	Width	Usable Capacity	Wt. (lbs.)
SMR25P	25	18.50	21.8	Polyethylene	Side Mount	22.50	25	43

50 GALLON SIDE MOUNT POLYMER RESERVOIR

- Heavy duty polymer construction (.375 in. minimum thickness)
- Ideal for short run dump applications
- Keep fluid clean with the quarter-turn 40 micron filler cap
- Includes level/temperature sight gauge
- Fully baffled to control fluid movement and keep things cool



SMR50P

Part No.	Capacity	Depth	Height	Material	Mount Position	Width	Usable Capacity	Wt. (lbs.)
SMR50P	50	23.80	24.2	Polyethylene	Side Mount	31.00	50	76

UPRIGHT POLYMER RESERVOIR

- Lightweight and rust-free polypropylene
- Ideal for short run time applications such as dumping and roll-off
- Includes diffuser and 40 micron filler breather cap
- Includes dual 2 in. NPT field serviceable ports



UR50P

Part No.	Capacity	Depth	Height	Material	Mount Position	Width	Usable Capacity	Wt. (lbs.)
UR50P	50	16.25	29	Polyethylene	Upright	38.00	55	102

Reservoir Accessories

POLYMER FILLER-STRAINER BREATHER CAP ASSEMBLY

- Keeps contaminants out while you fill the reservoir tank
- Made of rust-free, high-impact technopolymer for long life.
- Handles temperatures from -22° F to 240° F.



TFAN3



TFAN3C

Part No.	Color	Material	For Use With	Wt. (lbs.)
TFAN3	Black	Glass Filled Nylon	Hydraulic Reservoirs	0.56
TFAN3C	Chrome	Glass Filled Nylon	Hydraulic Reservoirs	0.56

CHROME PLATED STEEL FILLER-STRAINER BREATHER CAP ASSEMBLY

- Keeps contaminants out while you fill the reservoir tank
- Allows your reservoir to "breathe" and prevents a vacuum from building up



TFA005715



TFA005715L



TC0015



BRA64000



BRA64500

Part No.	Locking	Color	Material	For Use With	Wt. (lbs.)
TFA005715	No	Chrome	Chrome Plated Steel	Hydraulic Reservoirs	0.70
TFA005715L	Yes	Chrome	Chrome Plated Steel	Hydraulic Reservoirs	0.74

Replacement Parts:

Part No.	Description	Wt. (lbs.)
TC0015	Replacement Cap with Chain for TFA005715 and TFA005715L	0.33
BRA64000	Cap Gasket for TFA005715 and TFA005715L	0.004
BRA64500	Basket Gasket for TFA005715 and TFA005715L	0.008

HEAVY DUTY PUSH-IN BREATHER CAP

- Acts as a ventilator to provide a free flow of clean air into your reservoir.
- Keeps out dirt and dust particles as small as 40 microns.



BECO61A



BECO61AB



FILLER/BREATHER WELD FLANGE ADAPTER

- Great for those fabricating their own hydraulic reservoirs
- Welds to the top of reservoirs to adapt to most standard filler breather units
- Provides 1" rise
- 12 gauge flange



TAF001

Part No.	Height	Material	Mount Position	Wt. (lbs.)
TAF001	1.13	Carbon Steel	Upright	0.61
TAF001A	1.13	Aluminum	Upright	0.22

BREATHER CAP

- Provides free flow of clean air into hydraulic fluid, oil, chemical, and coolant tanks or reservoirs.
- Large, oil-resistant filter elements dirt and dust particles as small as 40 micron.



HBF2

Part No.	Material	Thread Size	Wt. (lbs.)
HBF2	Carbon Steel	1/8 NPT	0.2
HBF4	Carbon Steel	1/4 NPT	0.15
HBF6	Carbon Steel	3/8 NPT	0.17
HBF8	Carbon Steel	1/2 NPT	0.29
HBF12	Carbon Steel	3/4 NPT	0.54
HBF16	Carbon Steel	1 NPT	0.7

MAGNETIC DRAIN PLUG WITH SQUARE HEAD

- Great for helping prevent metallic particle contamination
- 1/4" NPT Port Square head plug (PPM08)
- 3/4" NPT Port Square head plug (PPM12)



PPM12

Part No.	Side 1	Shape	Style	Material	Finish	Wt. (lbs.)
PPM08	1/2 NPT	Magnetic Drain	M	Carbon Steel	Zinc Plated	0.12
PPM12	3/4 NPT	Magnetic Drain	M	Carbon Steel	Zinc Plated	0.183

Reservoir Accessories

5 INCH RESERVOIR CLEANOUT FILTER FLANGE ASSEMBLY

- Assembly provides access for reservoir cleaning and internal suction strainer
- Flange only provides mounting surface for tank mounted HFA5 series return filters (or similar)



CPA56

Part No.	Size	For Use With	Wt. (lbs.)
CPA56	5 Inch Diameter	Hydraulic Tanks and Reservoirs	2.88

Accessories:

Part No.	Description	Wt. (lbs.)
CP56	Reservoir Cleanout Filter Flange Cover Plate Only	1.49
3005534	Reservoir Cleanout Filter Flange Gasket	0.119

8 AND 10 INCH STAINLESS STEEL RESERVOIR CLEANOUT PLATE ASSEMBLY **NEW**

- Provides access to the inside of the tank for cleaning and removing contaminants
- Kit includes the stainless steel cover plate, nitrile rubber gasket,, zinc-plated internal mounting bracket, and stainless steel fastener



CPA8

CPA8 Application

Part No.	Size	For Use With	Wt. (lbs.)
CPA8	8 Inch Diameter	Hydraulic Tanks and Reservoirs	4.17
CPA10	10 Inch Diameter	Hydraulic Tanks and Reservoirs	6.58

Accessories:

Part No.	Description	Wt. (lbs.)
CP8	8 Inch Reservoir Cleanout Filter Flange Cover Plate Only	1.83
CP10	10 Inch Reservoir Cleanout Filter Flange Cover Plate Only	2.40

SIGHT LEVEL GAUGES

- Zinc-plated
- Rated at 125 PSI / 250°



HSG075

Part No.	Size	Style	Temperature Indicator	Wt. (lbs.)
HSG075	.25"	Sight Glass	No	0.1
HSG100	1.00"	Sight Glass	No	0.2

OIL LEVEL GAUGE WITH TEMPERATURE INDICATOR

- Polycarbonate gauge center
- LDR02A has nylon outer body



LDR02A

LDR04

Part No.	Style	Mount Thread	Temperature Indicator	Wt. (lbs.)
LDR02A	Level Gauge With Polycarbonate Body and a Durable Molded Nylon Outer Shell	1/2-13	Yes	0.4
LDR04	Level Gauge with Polycarbonate Body	1/2-13	Yes	0.65

HYDRAULIC LIQUID LEVEL GAUGE

- Zinc-plated
- Rated at 125 PSI / 250°
- Nylon connector tube



HLLG1

Part No.	Style	Mount Thread	Temperature Indicator	Wt. (lbs.)
HLLG1	Level Gauge	1/2-13	No	0.2



WELDING FLANGES

STAMPED

- Choose from a wide variety of sizes and thicknesses
- Available in stamped aluminum, steel, and stainless steel to match your reservoir material
- Great for fabricating your own hydraulic tank or adding a port to your tank



FA025



FS025



FSSW025

Part No.	Material	Outer Diameter	Pilot	Thickness	Size	Construction	Wt. (lbs.)
ALUMINUM							
FA025	Aluminum	1.763	.623	.083	.540	Stamped	0.04
FA038	Aluminum	1.763	.750	.075	.675	Stamped	0.04
FA050	Aluminum	1.775	.930	.130	.840	Stamped	0.04
FA075	Aluminum	2.371	1.120	.168	1.050	Stamped	0.07
FA100	Aluminum	2.365	1.380	.160	1.315	Stamped	0.07
FA125	Aluminum	2.890	1.722	.240	1.550	Stamped	0.08
FA150	Aluminum	3.28	1.995	.268	1.900	Stamped	0.1
FA200	Aluminum	3.840	2.470	.530	2.375	Stamped	0.12
STEEL							
FS012	Carbon Steel	1.680	0.480	0.134	.125	Stamped	0.09
FS025	Carbon Steel	1.770	0.755	0.134	.25	Stamped	0.09
FS038	Carbon Steel	1.770	0.755	0.134	.375	Stamped	0.09
FS050	Carbon Steel	1.780	0.930	0.134	.50	Stamped	0.09
FS075	Carbon Steel	2.350	1.135	0.134	.75	Stamped	0.15
FS100	Carbon Steel	2.360	1.385	0.134	1.00	Stamped	0.15
FS125	Carbon Steel	2.868	1.740	0.134	1.25	Stamped	0.18
FS150	Carbon Steel	3.658	1.958	0.118	1.50	Stamped	0.3
FS200	Carbon Steel	3.705	2.455	0.118	2.00	Stamped	0.3
STAINLESS STEEL							
FSSW025	Stainless Steel	1.738	0.620	0.134	.25	Stamped	0.08
FSSW038	Stainless Steel	1.738	0.755	0.134	.375	Stamped	0.082
FSSW050	Stainless Steel	1.740	0.910	0.134	.50	Stamped	0.087
FSSW075	Stainless Steel	2.355	1.110	0.134	.75	Stamped	0.094
FSSW100	Stainless Steel	2.317	1.370	0.134	1.00	Stamped	0.1
FSSW125	Stainless Steel	2.847	1.745	0.134	1.25	Stamped	0.106
FSSW150	Stainless Steel	3.240	1.958	0.134	1.50	Stamped	0.113

FORGED

- Solid, rugged, forged steel construction
- Choose from a variety of sizes to meet your needs
- Great for fabricating your own hydraulic tank or adding a port to your tank



FDF012

Part No.	Material	Outer Diameter	Pilot	Size	Construction	Wt. (lbs.)
FDF025	Carbon Steel	1.312	0.937	.25	Forged	0.09
FDF038	Carbon Steel	1.312	0.937	.375	Forged	0.07
FDF050	Carbon Steel	1.625	1.125	.50	Forged	0.12
FDF075	Carbon Steel	1.937	1.375	.75	Forged	0.19
FDF100	Carbon Steel	2.250	1.687	1.00	Forged	0.34
FDF125	Carbon Steel	2.562	2.000	1.25	Forged	0.33
FDF150	Carbon Steel	2.812	2.250	1.50	Forged	0.37
FDF200	Carbon Steel	3.375	2.625	2.00	Forged	0.51
FDF250	Carbon Steel	4.062	3.156	2.50	Forged	1.1
FDF300	Carbon Steel	4.625	3.656	3.00	Forged	1.26
FDF400	Carbon Steel	5.812	4.719	4.00	Forged	2.12

Sensor Kits & Diffusers

OIL LEVEL SENSOR KITS

STANDARD

- Helps prevent damage to the hydraulic system from low oil level in reservoir
- Provides an in-cab visual alert to immediately notify you when oil level is too low
- Requires a 1" NPT port in reservoir top
- Indicator light presses into any 1/2" diameter hole
- Kit contains: 1 Electric Fluid Level Switch, 1 B272332 Light (Red), 1 E79855 Fuse, 2 E11 Insulate Female Disconnect, 4 E421005 FXF Connector, 1 E22D Decal - "Hydraulic Fluid Low"



E22

Part No.	Adjustable	Indicator Light	Slosh Shield	Thread	Mount Style	Wt. (lbs.)
E22	Yes	Yes	No	1 NPT	Thru Port	0.61

WITH SLOSH SHIELD

- Helps prevent damage to the hydraulic system from low oil level in reservoir
- Provides an in-cab visual alert to immediately notify you when oil level is too low
- Promotes accurate sensing even in more turbulent conditions within the reservoir
- Requires a 1" NPT port in reservoir top
- Indicator light presses into any 1/2" diameter hole
- Kit contains: 1 Electric Fluid Level Switch, 1 B272332 Light (Red), 1 E79855 Fuse, 2 E11 Insulate Female Disconnect, 4 E421005 FXF Connector, 1 E22D Decal - "Hydraulic Fluid Low"



E32

Part No.	Adjustable	Indicator Light	Slosh Shield	Thread	Mount Style	Wt. (lbs.)
E32	Yes	Yes	Yes	1 NPT	Thru Port	0.65

HORIZONTALLY MOUNTED SWITCH

- Horizontally mounted level switch installs into a 1/2NPT weld flange or half coupling
- Hex shaped body for easy tightening is threaded for interior or exterior installation
- Can be installed in a Normally-Open or a Normally-Closed orientation
- Rated for up to 200VDC/140VAC and 0.15A switching capacity / 0.3A carrying capacity with 24in long wire leads
- Kit contains: 1 Level Switch, 1 B272332 Light (Red), 1 E79855 Fuse, 2 E11 Insulate Female Disconnect, 4 E421005 FXF Connector, 1 E22D Decal - "Hydraulic Fluid Low"



E24

Part No.	Description	Mounting	Wt. (lbs.)
E24	Level switch, horizontal	1/2 NPT	0.30
E25	Level switch, horizontal, Low-Oil Kit	1/2 NPT	0.35

RETURN LINE DIFFUSER

- This 8-7/8" long diffuser is highly effective in reducing aeration, foaming, turbulence and noise caused by return lines



HD200125

Part No.	Bushing Finish	Diffuser Material	Overall Length	Wt. (lbs.)
HD200125	Zinc Plated	304 Stainless Steel	8.75	1.02



SINGLE ELEMENT SUMP STRAINER

- Cleanable 100 mesh stainless steel wire cloth
- 1" to 2-1/2" NPTF port size
- Extra-large filtering area with integral 3 PSI bypass valve
- Stops items 150 microns and larger from getting into your hydraulic system



SI1003

Part No.	Element Diameter	Element Length	Filter Material	Pressure Bypass	Nominal Rating	Wt. (lbs.)
SI1003	2.62	5.34	304 Stainless Steel	3	150	0.66
SI1253	3.36	6.84	304 Stainless Steel	3	150	0.71
SI1503	3.37	8.03	304 Stainless Steel	3	150	1.21
SI2003	3.93	9.86	304 Stainless Steel	3	150	1.18
SI2503	5.12	10.14	304 Stainless Steel	3	150	1.7

THRU-WALL SUMP STRAINER

- Cleanable 100 mesh stainless steel wire cloth
- Flow Rating: 5 GPM (19 L/min.) to 50 GPM (189 L/min.)
- 3 PSI bypass
- Stops items 150 microns and larger from getting into your hydraulic system
- Cast iron bushing



SW1000503

Part No.	Element Diameter	Element Length	Filter Material	Pressure Bypass	Nominal Rating	Wt. (lbs.)
SW1000503	1.00	3.50	304 Stainless Steel	3	150	0.68
SW1250753	1.38	6.70	304 Stainless Steel	3	150	0.48
SW1501003	1.56	6.50	304 Stainless Steel	3	150	0.59
SW2001253	2.00	7.50	304 Stainless Steel	3	150	1.1
SW2001253SS	2.00	7.50	304 Stainless Steel	3	150	1.2
SW3002003	3.00	7.81	304 Stainless Steel	3	150	.84

THRU-WALL SUMP STRAINER WITH MALE NPT END

- Cleanable 100 mesh stainless steel wire cloth
- Flow Rating: 49 GPM (5ft/sec)
- 3 PSI bypass
- 2" NPTMF Port
- Stops items 150 microns and larger from getting into your hydraulic system



SW2002003

Part No.	Element Diameter	Element Length	Filter Material	Pressure Bypass	Nominal Rating	Wt. (lbs.)
SW2002003	2.10	10.70	304 Stainless Steel	3	150	1.2

Filtration Kits

3 LINE FILTRATION KITS

INLINE FILTER

- Faster cycle times, more efficient operation with a dedicated return line.
- Keeps fluids contaminant-free for longer system life.
- Includes everything you need to set up a 3 line installation.
- Will handle flows up to 50 GPM.



U3LWF

Part No.	Filter Rating	Flow Rating	Wt. (lbs.)
U3LWF	25	50	17

UNDER FILTER

- Faster cycle times, more efficient operation with a dedicated return line.
- Keeps fluids contaminant-free for longer system life.
- Dual over-under filters can increase flow capacity up to 100 GPM.
- Includes everything you need to set up a 3 line installation.



U3LWF3

Part No.	Filter Rating	Flow Rating	Wt. (lbs.)
U3LWF3	25	100	20

SIDE-BY-SIDE FILTER

- Faster cycle times, more efficient operation with a dedicated return line.
- Keeps fluids contaminant-free for longer system life.
- Dual side-by-side filters can increase flow capacity up to 90 GPM.
- Includes everything you need to set up a 3 line installation.



U3LWF4

Part No.	Filter Rating	Flow Rating	Wt. (lbs.)
U3LWF4	25	90	22

RETURN LINE MANIFOLD

- Reduces tangled plumbing by consolidating your return lines into a single unit
- Rugged construction treated for maximum rust protection



RM10

Part No.	Bushing Finish	Diffuser Material	Overall Length	Wt. (lbs.)
RM10	Plain	Carbon Steel	15	6.8
RM10SS	Plain	Stainless Steel	15	7.9



FILTER HEAD - 7 GPM

- Filters contaminants as small as 10 microns from the oil returning to the reservoir, extending the life of your hydraulic system
- Flows up to 7 GPM for return and 2 GPM for suction line applications; up to 200 PSI working pressure
- 9/16"-18 UN (SAE-6) ports (FH000)
- 3/8" NPTF ports (FH001)
- 3/4" - 16 threaded neck



FH000

Part No.	Ports	Maximum Pressure	Maximum Flow Return (GPM)	Maximum Flow Suction (GPM)	Wt. (lbs.)
FH000	#6 SAE	200	7	2	0.58
FH001	3/8" NPTF	200	7	2	0.58

HFA1 SERIES 15 GPM RETURN LINE FILTER

- Filters contaminants as small as 10 microns from the oil returning to the reservoir, extending the life of your hydraulic system
- Flows up to 15 GPM for return and 5 GPM for suction line applications; up to 200 PSI working pressure
- 3/4" NPT Ports
- Two 1/8" NPT Gauge Ports



HFA11015

Part No.	Filter Media	In Tank/ Out of Tank	Maximum Flow Return (GPM)	Maximum Flow Suction (GPM)	Maximum Pressure (PSI)	PSI Bypass	Number of Elements	Thread Size (NPTF)	Micron Filter Rating	Wt. (lbs.)
HFA11015	Cellulose	External	15	5	200	15	1	1	10	1.68
HFA11025	Cellulose	External	15	5	200	25	1	1	10	1.68
HFA12515	Cellulose	External	15	5	200	15	1	1	25	1.68
HFA12525	Cellulose	External	15	5	200	25	1	1	25	1.68

Accessories:

Part No.	Description	Wt. (lbs.)
U1L6FE	Return Line Filter 25 Micron Replacement Element For HFA1/HFA6/HFA7-Series	1.04
U1L3FE	Return Line Filter 10 Micron Replacement Element For HFA1/HFA6/HFA7-Series	1.1
U3L007	Hydraulic Filter Bracket	1.3
FH115	15 GPM Return Line Filter Head 3/4 Inch NPT/15 PSI Bypass	0.58
FH125	15 GPM Return Line Filter Head 3/4 Inch NPT/25 PSI Bypass	0.58

HFA6 SERIES 15 GPM RETURN LINE FILTER HEAD 1/2 INCH NPT PORTS/25 PSI BYPASS

- Filters contaminants as small as 10 microns from the oil returning to the reservoir, extending the life of your hydraulic system
- Flows up to 15 GPM for return and 5 GPM for suction line applications; up to 200 PSI working pressure
- 1/2" NPT Ports
- Two 1/8" NPT Gauge Ports
- 1" - 12 threaded neck



FH625



U1L3FE

Part No.	Maximum Pressure	PSI Bypass	Maximum Flow Return (GPM)	Maximum Flow Suction (GPM)	Wt. (lbs.)
FH625	200	25	15	5	0.58

Accessories:

Part No.	Description	Wt. (lbs.)
U1L6FE	Return Line Filter 25 Micron Replacement Element For HFA1/HFA6/HFA7-Series	1.04
U1L3FE	Return Line Filter 10 Micron Replacement Element For HFA1/HFA6/HFA7-Series	1.1
U3L007	Hydraulic Filter Bracket	1.3

Filters

HFA2 SERIES 50 GPM RETURN LINE FILTER

- Filters contaminants as small as 10 microns from the oil returning to the reservoir, extending the life of your hydraulic system
- Flows up to 50 GPM for return and 15 GPM for suction line applications; up to 150 PSI working pressure
- 1-1/4" NPT ports
- Dual 1- 1/2" - 16 threaded neck



HFA21025

Part No.	Filter Media	In Tank/ Out of Tank	Maximum Flow Return (GPM)	Maximum Flow Suction (GPM)	Maximum Pressure	PSI Bypass	Number of Elements	Thread Size (NPTF)	Micron Filter Rating	Wt. (lbs.)
HFA21015	Cellulose	External	50	15	150	15	1	1-1/4	10	3.81
HFA21025	Cellulose	External	50	15	150	25	1	1-1/4	10	4.46
HFA22515	Cellulose	External	50	15	150	15	1	1-1/4	25	4.46
HFA22525	Cellulose	External	50	15	150	25	1	1-1/4	25	4.46

Accessories:

Part No.	Description	Wt.(lbs.)
FH225	50 GPM Return Line Filter Head 1-1/4 Inch NPT/25 PSI Bypass	1.81
FH215	50 GPM Return Line Filter Head 1-1/4 Inch NPT/15 PSI Bypass	1.71
U3L3FE	Return Line Filter 10 Micron Replacement Element For HFA2/HFA3/HFA4-Series	2.6
U3L6FE	Return Line Filter 25 Micron Replacement Element For HFA2/HFA3/HFA4-Series	2.1
U3L007	Hydraulic Filter Bracket	1.3

HFA3 SERIES 100 GPM RETURN LINE FILTER

- Filters contaminants as small as 10 microns from the oil returning to the reservoir, extending the life of your hydraulic system
- Flows up to 100 GPM for return and 35 GPM for suction line applications; up to 150 PSI working pressure
- 1-1/2" NPT ports
- Dual 1-1/4" - 16 threaded neck



HFA31015

Part No.	Filter Media	In Tank/ Out of Tank	Maximum Flow Return (GPM)	Maximum Flow Suction (GPM)	Maximum Pressure	PSI Bypass	Number of Elements	Thread Size (NPTF)	Micron Filter Rating	Wt. (lbs.)
HFA31015	Cellulose	External	100	35	150	15	2	1-1/2	10	6.56
HFA31025	Cellulose	External	100	35	150	25	2	1-1/2	10	6.56
HFA32525	Cellulose	External	100	35	150	25	2	1-1/2	25	6.56

Accessories:

Part No.	Description	Wt.(lbs.)
U3L007	Hydraulic Filter Bracket	1.3
FH315	100 GPM Return Line Filter Head 1-1/2 Inch NPT/15 PSI Bypass	2.31
FH325	100 GPM Return Line Filter Head 1-1/2 Inch NPT/25 PSI Bypass	2.31
U3L3FE	Return Line Filter 10 Micron Replacement Element For HFA2/HFA3/HFA4-Series	2.6
U3L6FE	Return Line Filter 25 Micron Replacement Element For HFA2/HFA3/HFA4-Series	2.1

HFA4 SERIES 90 GPM RETURN LINE FILTER

- Filters contaminants as small as 10 microns from the oil returning to the reservoir, extending the life of your hydraulic system
- Flows up to 90 GPM for return and 20 GPM for suction line applications; up to 150 PSI working pressure
- Both 1-1/2" NPT and 2" SAE Ports for each
- Dual 1-1/2" - 16 threaded necks



HFA41015

Part No.	Filter Media	In Tank/ Out of Tank	Maximum Flow Return (GPM)	Maximum Flow Suction (GPM)	Maximum Pressure	PSI Bypass	Number of Elements	Thread Size (NPTF)	Micron Filter Rating	Wt. (lbs.)
HFA41015	Cellulose	External	90	20	150	15	2	1-1/2	10	9.56
HFA41025	Cellulose	External	90	20	150	25	2	1-1/2	10	9.56
HFA42515	Cellulose	External	90	20	150	15	2	1-1/2	25	9.56
HFA42525	Cellulose	External	90	20	150	25	2	1-1/2	25	9.56

Accessories:

Part No.	Description	Wt.(lbs.)
U3L3FE	Return Line Filter 10 Micron Replacement Element For HFA2/HFA3/HFA4-Series	2.6
FH425	90 GPM Return Line Filter Head 1-1/2 Inch NPT/25 PSI Bypass	5.59
U3L6FE	Return Line Filter 25 Micron Replacement Element For HFA2/HFA3/HFA4-Series	2.1
FH415	90 GPM Return Line Filter Head 1-1/2 Inch NPT/15 PSI Bypass	5.28



HFA5 SERIES 50 GPM IN-TANK FILTER

- Space-saving in-tank design
- Filters contaminants down to 10 or 25 microns from the oil returning to the reservoir.
- Operating temperature -22°F to +212°F (-30°C to +100°C)
- 1-1/4" NPT inlet port



HFA51025

Part No.	Filter Media	In Tank/ Out of Tank	Maximum Flow Return (GPM)	Maximum Flow Suction (GPM)	Maximum Pressure	Number of Elements	Thread Size	Micron Filter Rating	Wt. (lbs.)
HFA51025	Cellulose	In-Tank	50	Return Only	100	1	1-1/4 NPTF	10	6.35
HFA52525	Cellulose	In-Tank	50	Return Only	100	1	1-1/4 NPTF	25	6.07

Accessories:

Part No.	Description	Wt. (lbs.)
U5L3FE	10 Micron Replacement Element	1.1
U5L6FE	25 Micron Replacement Element	1.1

HFA9 SERIES 26 GPM IN-TANK FILTER

- Space-saving in-tank design
- Filters contaminants down to 10 or 25 microns from the oil returning to the reservoir.
- Operating temperature -22°F to +212°F (-30°C to +100°C)
- 1" NPT inlet port



HFA91025

Part No.	Filter Media	In Tank/ Out of Tank	Maximum Flow Return (GPM)	Maximum Flow Suction (GPM)	Maximum Pressure	Number of Elements	Thread Size	Micron Filter Rating	Wt. (lbs.)
HFA91025	Cellulose	In-Tank	26	Return Only	100	1	1 NPTF	10	2.8
HFA92525	Cellulose	In-Tank	50	Return Only	100	1	1 NPTF	25	2.6

Accessories:

Part No.	Description	Wt. (lbs.)
U9L3FE	10 Micron Replacement Element	1.1
U9L6FE	25 Micron Replacement Element	1.1

HFA6 SERIES 100 GPM IN-TANK FILTER UNIT

- Filters contaminants as small as 10 microns from the oil returning to the reservoir, extending the life of your hydraulic system
- In-tank filter assembly; elements replaceable through filter cover
- Up to 200 PSI working pressure; flows up to 100 GPM
- For use with mineral & petroleum-based fluids
- Operating temperature -22°F to +212°F (-30°C to +100°C)
- Code 61, 4-bolt flange



HFA61025

Part No.	Filter Media	In Tank/ Out of Tank	Maximum Flow Return (GPM)	Maximum Flow Suction (GPM)	Maximum Pressure	Number of Elements	Thread Size	Micron Filter Rating	Wt. (lbs.)
HFA61025	Cellulose	In-Tank	105	Return only	200	1	2-1/2 (-40 CODE 61)	10	6.35

Filter Element Cross Reference Chart

BUYERS	U1L3FE	U1L6FE	U3L3FE	U3L6FE
AC	PF16	PF26	PF828	
Baldwin	BT839-10	BT839-25	BT287-10	
Canflo	RSE30-10	RSE30-25	RSE50-10	RSE50-25
Case			R25844	A57857
Caterpillar			342449 or 8J1600	
Cross	1A9021	1A9023	1A9251*	1A9253*
Deere			AT44696	AT44696 or AR43261
Deluxe	WD451	WD453	WD347	
Ditch Witch	155910		155954	
Fleet Guard	LF6056		LF680	
Fram	P1653A	P1654A	PH47-10	
Gresen	K22001	K22002	K23018*	K23019*
Hastings	P731	P732	P430	
Hydra-Mac			3401-303	3401-307
Lenz	CP752-10	CP752-30	1282-10-50	
LHA	SPE15-10	SPE15-25	SPE50-10	SPE50-25

BUYERS	U1L3FE	U1L6FE	U3L3FE	U3L6FE
Motorcraft	FH-10	FH-11	FL275	
MPF	S28	S29	S58	S59
NAPA	1551	1552	1758	1759
New Holland	20932		262546	
Owatonna		170-32375		
Parker	921999	925023	926169	926170
Pall			9500FS4UJH	
Prince	FA-10	FA-25	FB10	FB25
Purolator			R29	
Ripley	DP752-10	DP752-25		
Stieger		18-502	18-842	18-498
Tennant	52582	UCC	1500-4-10	1500-4-25
Vickers			575942 or 941107	
Wix	51551	515523	51759	
Zinga	AE10	AE25	SE10	SE25
Heil				75C425-1
Intl Harvester				69149-C1

* Should use flat seal Part No. HFFS

Buyers Products is not authorized by nor affiliated with the manufacturer's products listed above. This information is made available for the convenience of our customers and is not meant to indicate that the product is shipped to/from above companies

Pressure Switches

BUZZER LIGHT

- Combination warning light & buzzer operate simultaneously for 2-way warning of hazardous conditions
- 12 VDC, .2 AMPs
- Red lens, snaps out for easy bulb replacement (bulb included)
- 70 DB at 3 ft



BL10

Part No.	Body Up Style	Buzzer Included?	Indicator Light Included?	Wt. (lbs.)
BL10	Indicator Only	Yes	Yes	0.16

PRESSURE SWITCHES

STANDARD

- Helps prevent damage to the hydraulic system from low or high oil pressure
- Preset at 15 PSI (PS15)
- Preset at 25 PSI (PS25)
- Proof 350 PSI (Max pressure diaphragm will handle before failing)
- Normally open & normally closed (SPST)
- 1/8" NPT



PS15

Part No.	Adjustable	Pressure Setting	Style	Thread	Wt. (lbs.)
PS15	No	15	N.O. (SPST)	1/8 NPT	0.2
PS25	Yes	25	N.O. (SPST)	1/8 NPT	0.156

ADJUSTABLE

- Helps prevent damage to the hydraulic system from low or high oil pressure
- Adjustable range: 25-75 PSI (PS2575); 250-1,000 PSI (PS2501K)
- Max pressure diaphragm will handle before failing; Proof 1,000 PSI (PS2575); Proof 9,000 PSI (PS2501K)
- Open or Closed SPDT (PS2575)
- 1/8" NPT (PS2575); 1/4" NPT (PS2501K)



PS2575

Part No.	Adjustable	Pressure Setting	Style	Thread	Wt. (lbs.)
PS2575	Yes	25-75	N.O./N.C. (SPDT)	1/8 NPT	0.03
PS2501K	Yes	250-1000	N.O./N.C. (SPDT)	1/4 NPT	0.03

FILTER ELEMENT MONITORING KIT

- Dash mounted indicator light indicates when element is dirty
- Enables driver to monitor element condition under working conditions
- Pressure switch is pre-set at 25 PSI



PSK25

Part No.	Material	Range	Diameter	Thread	Proof Pressure	Wt. (lbs.)
PSK25	Brass	25 PSI	1.25	1/4 NPT	1000	1



WETLINE KITS

DUAL PRESSURE, DIRECT MOUNT PUMP

- Includes everything you need to operate a dump application or live floor
- Sleek in-cab pneumatic controls with console
- 50 gal or 70 gal upright steel reservoir included. Side-mount 50 gal reservoir also available
- All brackets, hoses, fittings, fasteners, pumps, and other hardware included



DLFK50CCW

Part No.	Reservoir Volume	Reservoir Material	Reservoir Position	Pump Rotation	Flow at 1800 RPM	Wt. (lbs.)
DLFK50CCW	50	Carbon Steel	Upright	Counterclockwise	32.5	390
DLFK50A24CCW	50	Aluminum	Upright	Counterclockwise	32.5	270
DLFK50CCW24	50	Carbon Steel	Upright	Counterclockwise	42	390
DLFK50CCWSM	50	Carbon Steel	Side Mount	Counterclockwise	32.5	379
DLFK70CCW	70	Carbon Steel	Upright	Counterclockwise	32.5	430

FOR LIVE FLOOR TRAILER, 37 GALLON

- Includes everything you need to operate a live floor trailer
- Designed for optimal speed and long life
- 37 gal steel reservoir included with tank-mounted 50 GPM return filter
- Features a dowelled 18 GPM or 24 GPM pump with built-in relief
- All hoses, fittings, clamps, fasteners and other hardware included



LFK3718

Part No.	Reservoir Volume	Reservoir Material	Reservoir Position	Pump Rotation	Flow at 1800 RPM	Wt. (lbs.)
LFK3718	37	Carbon Steel	Side Mount	Counterclockwise	32.5	143.24
LFK3724	37	Carbon Steel	Side Mount	Counterclockwise	42	143.24

FOR LIVE FLOOR TRAILER, 50 GALLON

- Includes everything you need to operate a live floor trailer (except PTO unit)
- Designed for optimal speed and long life
- 50 gal steel reservoir included with tank-mounted 50 GPM return filter
- Features a dowelled 18 GPM or 24 GPM pump with built-in relief
- All hoses, fittings, clamps, fasteners and other hardware included



LFK5018

Part No.	Reservoir Volume	Reservoir Material	Reservoir Position	Pump Rotation	Flow at 1800 RPM	Wt. (lbs.)
LFK5018	50	Carbon Steel	Side Mount	Counterclockwise	32.5	227.98
LFK5024	50	Carbon Steel	Side Mount	Counterclockwise	42	227.98
LFK5024ASMNT	50	Aluminum	Side Mount	Counterclockwise	42	227.98

Wetline Kits

WETLINE KITS - continued

SIDE-MOUNT RESERVOIR/DIRECT MOUNT PUMP

- Includes everything you need to set up a hydraulic system for your dump application (except PTO unit)
- Choose the combination of side-mount reservoir size and material for your needs
- All brackets, hoses, fittings, fasteners and other hardware included
- Pumps can be ordered clockwise or counterclockwise



SMWLK50ADMCCW

Part No.	Reservoir Volume	Reservoir Material	Reservoir Position	Pump Rotation	Flow at 1800	
					RPM	Wt. (lbs.)
SMWLK50ADMCCW	50	Carbon Steel	Side Mount	Counterclockwise	46	191
SMWLK50DMCCW	50	Carbon Steel	Side Mount	Counterclockwise	46	243
SMWLK50PDMCCW	50	Polyethylene	Side Mount	Counterclockwise	46	164.99
SMWLK50PDMCW	50	Polyethylene	Side Mount	Clockwise	46	164.99
SMWLK70ADMCCW	70	Aluminum	Side Mount	Counterclockwise	46	201
SMWLK70ADM CW	70	Aluminum	Side Mount	Clockwise	46	201
SMWLK70DMCCW	70	Carbon Steel	Side Mount	Counterclockwise	46	261
SMWLK70DMCW	70	Carbon Steel	Side Mount	Clockwise	46	261

UPRIGHT RESERVOIR/DIRECT MOUNT PUMP

- Includes everything you need to set up a hydraulic system for your dump application (except PTO unit)
- Choose the combination of upright reservoir size and material for your needs
- Pumps can be ordered with clockwise or counterclockwise operation
- All brackets, hoses, fittings, fasteners, and other hardware included



UWLK50PDMCW

Part No.	Reservoir Volume	Reservoir Material	Reservoir Position	Pump Rotation	Flow at 1800	
					RPM	Wt. (lbs.)
UWLK50ADMCCW	50	Aluminum	Upright	Counterclockwise	46	178.1
UWLK50ADM CW	50	Aluminum	Upright	Clockwise	46	175.1
UWLK50DMCCW	50	Carbon Steel	Upright	Counterclockwise	46	271
UWLK50DMCW	50	Carbon Steel	Upright	Clockwise	46	271
UWLK50PDMCCW	50	Polyethylene	Upright	Counterclockwise	46	284.69
UWLK50PDMCW	50	Polyethylene	Upright	Clockwise	46	284.69
UWLK70ADMCCW	70	Aluminum	Upright	Counterclockwise	46	193.1
UWLK70DMCCW	70	Carbon Steel	Upright	Counterclockwise	46	320
UWLK70DMCW	70	Carbon Steel	Upright	Clockwise	46	320



HIGH PRESSURE HOSE ASSEMBLY

- 1" high pressure SAE 100R2 (2 wire) hose assembly



HP1660

Part No.	Length (in.)	Inner Diameter	Fitting Side 1	Fitting Side 2	Working Pressure (PSI)	Wt. (lbs.)
HP1660	60	1.00	1 NPT	1 NPSM	2000	5
HP1672	72	1.00	1 NPT	1 NPSM	2000	6
HP1696	96	1.00	1 NPT	1 NPSM	2000	8
HP16108	108	1.00	1 NPT	1 NPSM	2000	9
HP16132	132	1.00	1 NPT	1 NPSM	2000	11
HP16144	144	1.00	1 NPT	1 NPSM	2000	11.32

SUCTION HOSE

- Internally reinforced 100R4 suction or return line hose



WLH10072

Part No.	Length (in.)	Inner Diameter	Working Pressure (PSI)	Wt. (lbs.)
WLH075600	600	0.75	300	20
WLH100120	120	1.00	250	7.5
WLH100600	600	1.00	250	37.5
WLH10072	72	1.00	250	3.6
WLH10096	96	1.00	250	4.68
WLH125120	120	1.25	200	4.5
WLH125144	144	1.25	200	9
WLH125600	600	1.25	200	55
WLH12572	72	1.25	200	6.6

SUCTION HOSE BARBED ADAPTER

- Hex style



BCA16180

Part No.	Side 1	Side 2	Shape	Style	Material	Finish	Wt. (lbs.)
BCA16180	1 NPT	1 Hose Barb	Straight	MM	Carbon Steel	Zinc Plated	0.414
BCA20180	1 1/4 NPT	1 Hose Barb	Straight	MM	Carbon Steel	Zinc Plated	0.662

Hoses and Accessories

COMBINATION NIPPLE

- Zinc plated steel
- Machined from schedule 40 pipe
- Close tolerances and defined serrations
- Long first serration for easy installation into hose



HCN100

Part No.	Side 1	Side 2	Shape	Style	Material	Finish	Wt. (lbs.)
BHEPS4x5	1 NPT	1 1/4 Hose Barb	Straight	MM	Carbon Steel	Zinc Plated	0.5
BHEPS5x6	1 1/4 NPT	1 1/2 Hose Barb	Straight	MM	Carbon Steel	Zinc Plated	0.53
BHES4x5	1 NPT	1 1/4 Hose Barb	Straight	MM	Carbon Steel	Plain	0.35
BHRPS6x5	1 1/2 NPT	1 1/4 Hose Barb	Straight	MM	Carbon Steel	Zinc Plated	0.83
HCN050	1/2 NPT	1/2 Hose Barb	Straight	MM	Carbon Steel	Zinc Plated	0.17
HCN075	3/4 NPT	3/4 Hose Barb	Straight	MM	Carbon Steel	Zinc Plated	0.2
HCN100	1 NPT	1 Hose Barb	Straight	MM	Carbon Steel	Zinc Plated	0.33
HCN125	1 1/4 NPT	1 1/4 Hose Barb	Straight	MM	Carbon Steel	Zinc Plated	0.54
HCN150	1 1/2 NPT	1 1/2 Hose Barb	Straight	MM	Carbon Steel	Zinc Plated	0.64
HCN200	2 NPT	2 Hose Barb	Straight	MM	Carbon Steel	Zinc Plated	0.98
HCN250	2 1/2 NPT	2 1/2 Hose Barb	Straight	MM	Carbon Steel	Zinc Plated	1.65
HCN300	3 NPT	3 Hose Barb	Straight	MM	Carbon Steel	Zinc Plated	2.05

IRON REDUCING BUSHING

- Used to reduce NPT pipe thread port to hex head
- Tough iron construction



RAB125075

Part No.	Side 1	Side 2	Shape	Style	Material	Finish	Wt. (lbs.)
RAB125075	1 1/4 NPT	3/4 NPT	Straight	MF	Carbon Steel	Zinc Plated	0.4
RAB125100	1 1/2 NPT	1 1/4 NPT	Straight	MF	Carbon Steel	Zinc Plated	0.26
RAB150125	1 1/4 NPT	1 NPT	Straight	MF	Carbon Steel	Zinc Plated	0.3
RAB200125	2 NPT	1 1/4 NPT	Straight	MF	Carbon Steel	Zinc Plated	0.67
RAB200150	2 NPT	1 1/2 NPT	Straight	MF	Carbon Steel	Zinc Plated	0.6

4 BOLT FLANGE ADAPTER KIT

- Converts split flange to NPT porting
- Complete with bolts, lock washers & O-ring



B432424U

Part No.	Side 1	Side 2	Shape	Style	Material	Finish	Wt. (lbs.)
B431616U	1 NPT	1 (-16 CODE 61)	Flange Adapter	FF	Carbon Steel	Plain	1.51
B432020U	1 1/4 NPT	1-1/4 (-20 CODE 61)	Flange Adapter	FF	Carbon Steel	Plain	2.04
B432424U	1 1/2 NPT	1-1/2 (-24 CODE 61)	Flange Adapter	FF	Carbon Steel	Plain	3.02
B433232U	2 NPT	2 (-32 CODE 61)	Flange Adapter	FF	Carbon Steel	Plain	4.9
B434040U	2 1/2 NPT	2-1/2 (-40 CODE 61)	Flange Adapter	FF	Carbon Steel	Plain	5.06



HOSE CLAMPS

BLACK VINYL COATED

- Sturdy, durable cold-rolled steel construction.
- Corrosion-resistant zinc finish
- Hose-protective black vinyl cushion
- Packaged in quantities of 25 pieces



HK0509

Part No.	Finish	Material	Clamping Diameter	Wt. (lbs.)
HK0509	Zinc Plated	Carbon Steel	0.250	0.28
HK0709	Zinc Plated	Carbon Steel	0.375	0.32
HK0809	Zinc Plated	Carbon Steel	0.438	0.5
HK0913	Zinc Plated	Carbon Steel	0.500	0.716
HK1013	Zinc Plated	Carbon Steel	0.563	0.98
HK1113	Zinc Plated	Carbon Steel	0.625	1.06
HK1213	Zinc Plated	Carbon Steel	0.688	1.14
HK1313	Zinc Plated	Carbon Steel	0.750	1.22
HK1413	Zinc Plated	Carbon Steel	0.813	1.3
HK1513	Zinc Plated	Carbon Steel	0.875	1.22
HK1713	Zinc Plated	Carbon Steel	1.000	1.45
HK1813	Zinc Plated	Carbon Steel	1.063	1.32
HK1913	Zinc Plated	Carbon Steel	1.125	1.64
HK2017	Zinc Plated	Carbon Steel	1.188	2.3
HK2117	Zinc Plated	Carbon Steel	1.250	2.4
HK2317	Zinc Plated	Carbon Steel	1.375	2.6
HK2517	Zinc Plated	Carbon Steel	1.500	2.74
HK2917	Zinc Plated	Carbon Steel	1.750	3.12
HK3117	Zinc Plated	Carbon Steel	1.875	3.32
HK3317	Zinc Plated	Carbon Steel	2.000	3.52
HK3417	Zinc Plated	Carbon Steel	2.156	3.76
HK3817	Zinc Plated	Carbon Steel	2.325	4.5

T-BOLT

- Heat treated 1/4"-28 UNF-3A plated steel T-bolts with plated steel locknuts
- A stainless steel welded liner closes the opening between clamp ends during tightening
- A smooth inner band prevents hoses from being cut or bulging and allows greater torquing capability than conventional worm gear clamps
- The band also assures equalized 360° clamping force around the hose for tight connections
- The band also assures equalized 360° clamping force around the hose for tight connections



HC500

Part No.	T-Bolt Thread Size	Nominal Diameter	Minimum Diameter	Maximum Diameter	Wt. (lbs.)
HC095	1/4-28	1.00	1.16	1.38	0.13
HC100	1/4-28	1.50	1.25	1.49	0.12
HC125	1/4-28	1.75	1.55	1.79	0.14
HC130	1/4-28	2.00	1.73	1.97	0.14
HC150	1/4-28	2.13	1.86	2.17	0.14
HC155	1/4-28	2.25	2.03	2.34	0.14
HC160	1/4-28	2.38	2.16	2.47	0.15
HC165	1/4-28	2.50	2.20	2.51	0.15
HC200	1/4-28	2.56	2.34	2.65	0.15
HC205	1/4-28	2.63	2.41	2.72	0.15
HC210	1/4-28	2.75	2.53	2.84	0.15
HC215	1/4-28	2.88	2.66	2.97	0.15
HC220	1/4-28	3.00	2.78	2.78	0.15
HC250	1/4-28	3.13	2.91	3.22	0.15
HC260	1/4-28	3.25	3.03	3.34	0.15
HC270	1/4-28	3.38	3.16	3.47	0.15
HC280	1/4-28	3.50	3.28	3.59	0.17
HC295	1/4-28	3.63	3.41	3.72	0.17
HC300	1/4-28	3.75	3.53	3.84	0.17
HC310	1/4-28	3.88	3.66	3.97	0.18
HC400	1/4-28	4.00	3.78	4.09	0.18
HC410	1/4-28	4.25	4.03	4.34	0.18
HC500	1/4-28	5.00	4.78	5.09	0.19
HC600	1/4-28	6.00	5.78	6.09	0.2

Clamps

WELDABLE PIPE CLAMPS

- Easy to assemble and disassemble
- Keeps pipes organized and in place

STANDARD



SSCP125

Part No.	Clamp For	Configuration	Clamp Inner Diameter (in.)	Wt. (lbs.)
SSCP038	3/8 Pipe	Single	21/32	0.2
SSCP050	1/2 Pipe	Single	27/32	0.24
SSCP075	3/4 Pipe	Single	1-1/32	0.29
SSCP100	1 Pipe	Single	1-5/16	0.41
SSCP125	1-1/4 Pipe	Single	1-21/32	0.4

HEAVY DUTY

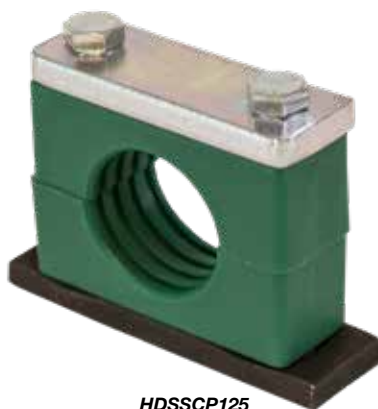

HDSSCP125

Part No.	Clamp For	Configuration	Clamp Inner Diameter (in.)	Wt. (lbs.)
HDSSCP025	1/4 Pipe	Single	17/32	0.7
HDSSCP038	3/8 Pipe	Single	21/32	0.7
HDSSCP050	1/2 Pipe	Single	27/32	0.8
HDSSCP100	1 Pipe	Single	1-5/16	1.3
HDSSCP125	1-1/4 Pipe	Single	1-21/32	1.3

WELDABLE PIPE CLAMPS - continued

TWIN

- Twin design keeps pipes organized and in place



TSCP125

Part No.	Clamp For	Configuration	Clamp Inner Diameter (in.)	Wt. (lbs.)
TSCP025	1/4 Pipe	Twin	17/32	0.29
TSCP038	3/8 Pipe	Twin	21/32	0.31
TSCP050	1/2 Pipe	Twin	27/32	0.38
TSCP075	3/4 Pipe	Twin	1-1/32	0.43
TSCP100	1 Pipe	Twin	1-5/16	0.63
TSCP125	1-1/4 Pipe	Twin	1-21/32	0.59

WELDABLE TUBING CLAMPS

- Easy to assemble and disassemble
- Keeps tubing organized and in place

STANDARD



SSCT025

Part No.	Clamp For	Configuration	Clamp Inner Diameter (in.)	Wt. (lbs.)
SSCT025	1/4in Tubing	Single	1/4	0.18
SSCT038	3/8in Tubing	Single	3/8	0.17
SSCT050	1/2in Tubing	Single	1/2	0.21
SSCT062	5/8in Tubing	Single	5/8	0.21
SSCT075	3/4in Tubing	Single	3/4	0.26
SSCT100	1in Tubing	Single	1	0.24
SSCT125	1-1/4in Tubing	Single	1-1/4	0.41



WELDABLE TUBING CLAMPS - continued

HEAVY DUTY

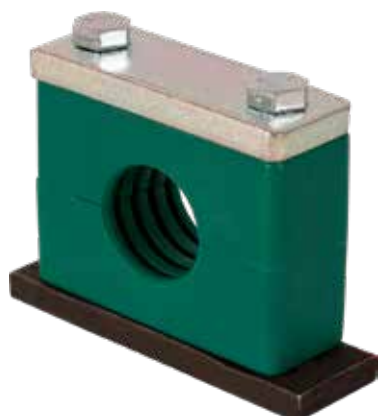

HDSSCT125

Part No.	Clamp For	Configuration	Clamp Inner Diameter (in.)	Wt. (lbs.)
HDSSCT025	1/4in Tubing	Single	1/4	0.7
HDSSCT031	5/16in Tubing	Single	5/16	0.7
HDSSCT038	3/8in Tubing	Single	3/8	0.7
HDSSCT050	1/2in Tubing	Single	1/2	0.7

TWIN

- Twin design keeps tubing organized and in place



TSCT025

Part No.	Clamp For	Configuration	Clamp Inner Diameter (in.)	Wt. (lbs.)
TSCT025	1/4in Tubing	Double	1/4	0.21
TSCT038	3/8in Tubing	Double	3/8	0.2
TSCT050	1/2in Tubing	Double	1/2	0.29
TSCT062	5/8in Tubing	Double	5/8	0.3
TSCT075	3/4in Tubing	Double	3/4	0.38
TSCT087	7/8in Tubing	Double	7/8	0.57
TSCT100	1in Tubing	Double	1	0.37
TSCT125	1-1/4in Tubing	Double	1-1/4	0.63

WELDABLE HOSE CLAMPS

- Easy to assemble and disassemble
- Keeps hoses organized and in place

STANDARD



SSCH100

Part No.	Clamp For	Configuration	Clamp Inner Diameter (in.)	Wt. (lbs.)
SSCH025	1/4 Hose	Single	5/8	0.22
SSCH038	3/8 Hose	Single	3/4	0.24
SSCH050	1/2 Hose	Single	7/8	0.38
SSCH062	5/8 Hose	Single	1-1/16	0.29
SSCH075	3/4 Hose	Single	1-3/16	0.28
SSCH100	1 Hose	Single	1-1/2	0.42

TWIN

- Twin design keeps hoses organized and in place



TSCH025

Part No.	Clamp For	Configuration	Clamp Inner Diameter (in.)	Wt. (lbs.)
TSCH025	1/4 Hose	Twin	5/8	0.28
TSCH038	3/8 Hose	Twin	3/4	0.39
TSCH050	1/2 Hose	Twin	7/8	0.24
TSCH062	5/8 Hose	Twin	1-1/16	0.49
TSCH075	3/4 Hose	Twin	1-3/16	0.48

Couplers

WING-TYPE HYDRAULIC QUICK COUPLER

COUPLERS

- Solid brass coupler halves
- Ductile iron wing section



QDWC16

Part No.	Description	Coupler Material	Wing Material	Flow Rate (GPM)	Size	Wt. (lbs.)
QDWC12	Complete Assembly	Brass	Cast Iron	12	#12 (3/4"-14) NPTF	2.28
QDWC121	Male End Only	Brass	Cast Iron	12	#12 (3/4"-14) NPTF	0.76
QDWC122	Female End Only	Brass	Cast Iron	12	#12 (3/4"-14) NPTF	1.24
QDWC16	Complete Assembly	Brass	Cast Iron	50	#16 (1"-11-1/2) NPTF	3.25
QDWC161	Male End Only	Brass	Cast Iron	50	#16 (1"-11-1/2) NPTF	1.35
QDWC162	Female End Only	Brass	Cast Iron	50	# 6 (1"-11-1/2) NPTF	1.9
QDWC20	Complete Assembly	Brass	Cast Iron	75	#20 (1-1/4"-11-1/2) NPTF	4.5
QDWC201	Male End Only	Brass	Cast Iron	75	#20 (1-1/4"-11-1/2) NPTF	1.7
QDWC202	Female End Only	Brass	Cast Iron	75	#20 (1-1/4"-11-1/2) NPTF	2.8
QDWC24	Complete Assembly	Brass	Cast Iron	100	#24 (1-1/2-11-1/2) NPTF	6.15
QDWC241	Male End Only	Brass	Cast Iron	100	#24 (1-1/2-11-1/2) NPTF	2.65
QDWC242	Female End Only	Brass	Cast Iron	100	#24 (1-1/2-11-1/2) NPTF	2.17

DUST CAP



QDDC121

Part No.	Material	Size	Wt. (lbs.)
QDDC121	Carbon Steel	0.750	0.3
QDDC161	Carbon Steel	1.000	0.4
QDDC201	Carbon Steel	1.250	0.55
QDDC241	Carbon Steel	1.500	0.812

DUST PLUG



QDDP122

Part No.	Material	Size	Wt. (lbs.)
QDDP122	Carbon Steel	0.750	0.41
QDDP162	Carbon Steel	1.000	0.6
QDDP202	Carbon Steel	1.500	0.7



SLEEVE-TYPE HYDRAULIC QUICK COUPLER

COUPLERS

- Rugged general purpose coupler with a single-acting sleeve
- Connects when system is not operating or when pressure has been relieved



B40004



B40004SS

Part No.	Body Size (in.)	Valve Style	Coupler Material	Seal Material	Connection (NPTF)	Flow Rate (GPM)	Wt. (lbs.)
B40002	1/4	Ball	Plated Steel	Buna-N	1/4 NPTF	4	0.35
B40002SS	1/4	Poppet	316 Stainless Steel	Viton	1/4 NPTF	4	0.4
B40003	3/8	Ball	Plated Steel	Buna-N	3/8 NPTF	9	0.67
B40003SS	3/8	Poppet	316 Stainless Steel	Viton	3/8 NPTF	9	0.7
B40004	1/2	Ball	Plated Steel	Buna-N	1/2 NPTF	20	0.8
B40004SS	1/2	Poppet	316 Stainless Steel	Viton	1/2 NPTF	18	0.8
B40005	3/4	Ball	Plated Steel	Buna-N	3/4 NPTF	45	1.5
B40005SS	3/4	Poppet	316 Stainless Steel	Viton	3/4 NPTF	40	1.6
B40006	1	Ball	Plated Steel	Buna-N	1 NPTF	80	2.17
B40006SS	1	Poppet	316 Stainless Steel	Viton	1 NPTF	75	2.2

RUBBER DUST PLUG

- Protects quick coupler end from dirt and dust
- Keeps contaminants out of your hydraulic system



B40002DP

Part No.	Material	Size	Wt. (lbs.)
B40002DP	Rubber	0.250	0.02
B40003DP	Rubber	0.375	0.04
B40004DP	Rubber	0.500	0.04
B40005DP	Rubber	0.750	0.11
B40006DP	Rubber	1.000	0.1

RUBBER DUST CAP

- Protects quick coupler end from dirt and dust
- Keeps contaminants out of your hydraulic system



B40002DC

Part No.	Material	Size	Wt. (lbs.)
B40002DC	Rubber	0.250	0.03
B40003DC	Rubber	0.375	0.04
B40004DC	Rubber	0.500	0.04
B40005DC	Rubber	0.750	0.07
B40006DC	Rubber	1.000	0.14

Couplers

FLUSH-FACE COUPLER

- Push-to-connect design; no need to retract the sleeve to connect
- Locking sleeve standard on all sizes to prevent accidental disconnection during operation
- 5,000 PSI rating and a 4-to-1 safety factor; manufactured to ISO 16028 specifications
- No air inclusion upon connection; very minimal spillage upon disconnection
- A push-on "toilet seat" style dust protector for the coupler side helps keep contaminants from entering the hydraulic system
- Note: The standard "FF" series couplings are NOT designed to connect or disconnect under pressure even though you are able to connect the plug into the coupler with up to 200 lbs. of residual pressure

MALE SIDE



FM0606

Part No.	Coupler Material	Male Plug (in.)	Female Coupler (in.)	Flow Rate (GPM)	Wt. (lbs.)
FM0606	Carbon Steel	3/8 Male plug	3/8 FNPT	15	0.42
FM0608	Carbon Steel	3/8 Male plug	1/2 FNPT	20	0.39
FM0808	Carbon Steel	1/2 Male plug	1/2 FNPT	25	0.72
FM0812	Carbon Steel	1/2 Male plug	3/4 FNPT	45	0.67

FEMALE SIDE



FF0606

Part No.	Coupler Material	Male Plug (in.)	Female Coupler (in.)	Flow Rate (GPM)	Wt. (lbs.)
FF0606	Carbon Steel	3/8 Male plug	3/8 FNPT	15	0.7
FF0608	Carbon Steel	3/8 Male plug	1/2 FNPT	20	0.67
FF0808	Carbon Steel	1/2 Male plug	1/2 FNPT	25	1.19
FF0812	Carbon Steel	1/2 Male plug	3/4 FNPT	45	1.13

RUBBER DUST PLUG FOR MALE FLUSH FACE COUPLER

- Protects quick coupler end from dirt and dust
- Keeps contaminants out of your hydraulic system



FF08FC

Part No.	Material	Size	Wt. (lbs.)
FF08FC	Rubber	0.500	0.06

RUBBER DUST CAP FOR FEMALE FLUSH FACE COUPLER

- Protects quick coupler end from dirt and dust
- Keeps contaminants out of your hydraulic system



FF08FC

Part No.	Material	Size	Wt. (lbs.)
FF08FC	Rubber	0.500	0.06



PTOS

HOT SHIFT PTO FOR FORD® 10 SPEED **NEW**

- Designed for use on Ford F-550 & down 10R-140 automatic non-HD transmissions, 130% output speed ratio
- Allows on the “fly” engaging of PTO to drive pump and supply hydraulic flow to hydraulic components
- Robust, low-profile housing allows easier installation on truck and clocking of pump for clearance
- Comes complete with 10-bolt PTO unit, wire harness, hoses, fittings and mounting hardware and gasket
- DIN 5462 8 Tooth Splined output shaft with 4-bolt mounting flange
- OPTIONAL- Bolt-on Adapter accessory P/N- B806735, permits installation of standard SAE A flanged- 5/8"-9 tooth splined shaft pump onto DIN 5462 PTO mount
- **More options available. Call 440-299-5430 or 8444-974-8324 (option 4) for availability.**

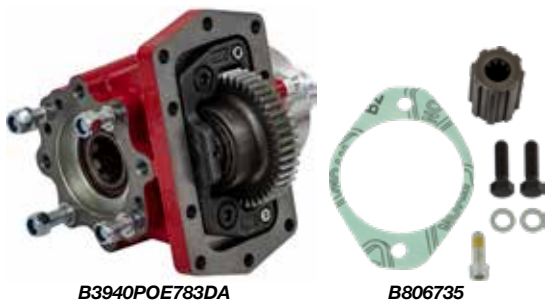

B3940POE783DA

B806735

Part No.	Description	Wt. (lbs.)
B3940POE783DA	Hot Shift PTO for Ford® 10 Speed	36

Accessories:

Part No.	Description	Wt. (lbs.)
B806735	Bolt-on Adapter Converts 8T DIN to SAE A 5/8-9T	0.65

P2000 SERIES PTOS

- Heavy-duty cast-iron body and pump mounting flange provides superior support of pump over units with “aluminum” flange
- Tapered roller bearings
- Rotatable mount flange (allows pump to be “clocked” for clearance)
- Parts are interchangeable with all common 8-bolt PTO’s
- Comes with SAE & Metric bolt kits, gaskets, light switch and air shift cover
- Multiple speed ratios for most Eaton Fuller, Road Ranger, 8-bolt bottom mount applications
- **More options available. Call 440-299-5430 or 8444-974-8324 (option 4) for availability.**



P2000XBN011RA

Part No.	Description	Wt. (lbs.)
P2000XBN011RA	PTO, 8 Bolt, Low Ratio, Direct Mount, Air Shift, Rotatable Mounting Flange, 7/8"-13 T Splined Shaft, Forward Position	40
P2000XBN013RA	PTO, 8 Bolt, Low Ratio, Direct Mount, Air Shift, Rotatable Mounting Flange, 7/8"-13 T Splined Shaft, Rear Position	40
P2000XCNO11RA	PTO, 8 Bolt, High Ratio, Direct Mount, Air Shift, Rotatable Mounting Flange, 7/8"-13 T Splined Shaft, Forward Position	40
P2000XCNO13RA	PTO, 8 Bolt, High Ratio, Direct Mount, Air Shift, Rotatable Mounting Flange, 7/8"-13 T Splined Shaft, Rear Position	40
P2000XENO11RA	PTO, 8 Bolt, Extra High Ratio, Direct Mount, Air Shift, Rotatable Mounting Flange, 7/8"-13 T Splined Shaft, Forward Position	40

GASKETS

6 HOLE GASKET

- Ideal for mounting a Buyers Products clutch pump/PTO on your engine

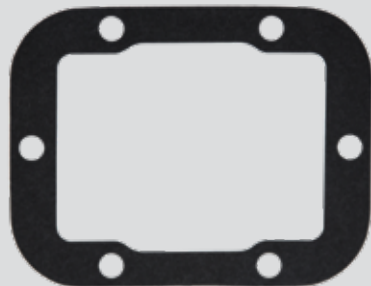

B35P91

Part No.	For Use With	Wt. (lbs.)
B35P91	0.010 Inch Thick 6-Hole Gasket For 1000 Series	0.01
B35P92	0.020 Inch Thick 6-Hole Gasket For 1000 Series	0.01

10 HOLE GASKETS

- Ideal for mounting a Buyers Products clutch pump/PTO on your engine



B35P151

Part No.	For Use With	Wt. (lbs.)
B35P151	0.010 Inch Thick 10-Hole Gasket For 2000 Series	0.01
B35P152	0.020 Inch Thick 10-Hole Gasket For 2000 Series	0.01

Hydraulic Pumps

STANDARD DUMP PUMP, DIRECT MOUNT

- Cast iron roller bearing dump pump
- Designed for 2 or 3 line installations
- Direct mount pump includes a 4 bolt SAE B mounting flange and 7/8"-13 spline input shaft
- For direct pumps, rotation must be specified; To identify pump rotation, view pump with shaft facing you and belly of pump down
- Relief valve set at 2500 PSI

MANUAL VALVE CONTROL



C1010DMCCW

Part No.	Rotation	Flow at 1000 RPM	Maximum Rotations Per Minute (RPM)	Pilot Diameter	Ports (rear/side)	Inlet Port Size	Gear Size	Wt. (lbs.)
C1010DMCW	Clockwise	25	2000	4.00	Rear	1 1/2 NPT	2.5	71
C1010DMCCW	Counter Clockwise	25	2000	4.00	Rear	1-1/2 NPT	2.5	71

WITH AIR CONTROL

- Comes with AS301 air shift cylinder (not installed)



C1010DMCCWAS

Part No.	Rotation	Flow at 1000 RPM	Maximum Rotations Per Minute (RPM)	Pilot Diameter	Ports (rear/side)	Inlet Port Size	Gear Size	Wt. (lbs.)
C1010DMCWAS	Clockwise	25	2000	4.00	Rear	1-1/2 NPT	2.5	76.34
C1010DMCCWAS	Counter Clockwise	25	2000	4.00	Rear	1-1/2 NPT	2.5	77

STANDARD DUMP PUMP, REMOTE MOUNT

- Cast iron roller bearing dump pump
- Designed for 2 or 3 line installations
- All Remote Mount C1010 Series have 2-1/2" diameter gears
- To identify pump rotation, view pump with shaft facing you and belly of pump down
- Relief set at 2500 PSI

MANUAL VALVE CONTROL



C1010

Part No.	Flow at 1000 RPM	Maximum Rotations Per Minute (RPM)	Pilot Diameter	Ports (rear/side)	Inlet Port Size	Gear Size	Wt. (lbs.)
C1010	25	2000	4.00	Rear	1-1/2 NPT	2.5	74

WITH AIR CONTROL

- Comes with AS301 air shift cylinder (not installed)



C1010AS

Part No.	Flow at 1000 RPM	Maximum Rotations Per Minute (RPM)	Pilot Diameter	Ports (rear/side)	Inlet Port Size	Gear Size	Wt. (lbs.)
C1010AS	25	2000	4.00	Rear	1-1/2 NPT	2.5	76.34



SMALL DUMP PUMP, DIRECT MOUNT

- Ideal for small dump applications
- Mounting: CH102 (direct mount) SAE B 4 bolt flange, 7/8-13T shaft
- Porting: 1-1/4" inlet, 3/4" NPT cylinder port, 3/4" NPT return port
- To identify pump rotation, view pump with shaft facing you and belly of pump down
- Buyers comparable pumps for: Commercial*, Permco*, Tyrone*, Vickers®* & others

MANUAL VALVE CONTROL



CH102115CCW

Part No.	Rotation	Flow at 1000 RPM	Maximum Rotations Per Minute (RPM)	Ports (rear/ side)	Inlet Port Size	Gear Size	Wt. (lbs.)
CH102115CCW	Counter Clockwise	11.7	2000	Rear	1-1/4 NPT	1.50	35
CH102115CW	Clockwise	11.7	2000	Rear	1-1/4 NPT	1.50	35
CH102120CCW	Counter Clockwise	16.1	2000	Rear	1 1/4 NPT	2.00	38
CH102120CW	Counter Clockwise	16.1	2000	Rear	1 1/4 NPT	2.00	42.42

SMALL DUMP PUMP, REMOTE MOUNT

- Ideal for small dump applications
- Mounting: CH101 (remote mount) 2 bolt mounting pad
- Porting: 1-1/4" inlet, 3/4" NPT cylinder port, 3/4" NPT return port
- Buyers comparable pumps for: Commercial*, Permco*, Tyrone*, Vickers®* & others
- CW & CCW rotation input shaft

AIR CONTROL



CH101115

Part No.	Flow at 1000 RPM	Maximum Rotations Per Minute (RPM)	Ports (rear/side)	Inlet Port Size	Gear Size	Wt. (lbs.)
CH101115	11.7	2000	Rear	1 1/4 NPT	1.50	35
CH101120	16.1	2000	Rear	1 1/4 NPT	2.00	38

PUMP SUPPORT BRACKET KIT

- Supports Buyers BPC1010-Series, C1010 -Series, Commercial C101/ C102, Permco DM640-Series
- Kit Includes: Transmission Plate, (2) Pump Plates,(2) Coupling Nuts, (2) 5/8" Bolts, (4) Flat Washers, (2) Lock Washers, Instructions
- 1/4" thick laser cut steel plates



Must use Support Bracket Kit with Direct Mount Dump Pumps, if not it will void the warranty

PB10

Part No.	Description	Wt. (lbs.)
PB10	Pump Support Bracket Kit	4.7

Hydraulic Pumps

DIRECT MOUNT HYDRAULIC PUMP 8T SPLINE **NEW**



BBEMD8S16

Part No.	Flow at 1000 RPM	Maximum Rotations Per Minute (RPM)	Pilot Diameter	Ports (rear/ side)	Inlet Port Size	Gear Size	Wt. (lbs.)
BBEMD6S12	7.66	2000	3.15	Both	3/4 #12 SAE ORB	1.25	14.77
BBEMD8S16	9.96	2000	3.15	Both	1" #16 SAE ORB	1.25	15.65

LIVE FLOOR HYDRAULIC PUMP WITH RELIEF PORT

- 4 Bolt SAE B Mount
- Counterclockwise rotation
- 1.00" relief port on rear cover
- Relief set @ 2800 PSI



H6134171

Part No.	Flow at 1000 RPM	Pilot Diameter	Ports (rear/side)	Inlet Port Size	Gear Size	Wt. (lbs.)
H6134171	18	4.00	Side	1-1/2 NPT	2.50	51
H6134251	24	4.00	Side	1-1/4 NPT	2.50	49.55

Accessories:

Part No.	Description	Wt.(lbs.)
H504	Pump Mounting Bracket for H21 and H50 Series Pumps	7.69

LIVE FLOOR HYDRAULIC PUMP

- 4 Bolt SAE B Mount
- Counterclockwise rotation
- No integral relief



H5134171

Part No.	Flow at 1000 RPM	Pilot Diameter	Ports (rear/side)	Inlet Port Size	Gear Size	Wt. (lbs.)
H5134171	18	4.00	Side	1-1/4 NPT	1.75	44
H5134251	24	4.00	Side	1-1/2 NPT	2.50	49.55

Accessories:

Part No.	Description	Wt.(lbs.)
H504	Pump Mounting Bracket for H21 and H50 Series Pumps	7.69

DUAL SHAFT HYDRAULIC PUMP

- Maximum operating pressure: 2500 PSI continuous duty
- Maximum RPM: 1800
- Bi-rotational pump
- Excellent for refuse applications



HDS36205

Part No.	Flow at 1000 RPM	Ports (rear/side)	Inlet Port Size	Gear Size	Wt. (lbs.)
HDS36205	22.3	Rear	1-1/4 NPT	2.000	47
HDS36255	27.8	Rear	1-1/2 NPT	2.500	49.75



H21 SERIES HYDRAULIC GEAR PUMP

- 2 & 4 Bolt SAE B Mount
- Bi-rotational pump

WITH SPLINE SHAFT

- 7/8 in., 13-tooth splined shaft



H2136101

Part No.	Flow at 1000 RPM	Maximum Rotations Per Minute (RPM)	Pilot Diameter	Ports (rear/side)	Inlet Port Size	Gear Size	Wt. (lbs.)
H2136101	6.8	2000	4.00	Rear/Side	1 NPT	1.00	29.92
H2136101SAE	6.8	2000	4.00	Rear/Side	#16 SAE	1.00	29.92
H2136121	8.7	2000	4.00	Rear/Side	1 NPT	1.25	30.3
H2136121SAE	8.7	2000	4.00	Rear/Side	#16 SAE	1.25	30.3
H2136151	11.3	2000	4.00	Rear/Side	1 NPT	1.5	31.8
H2136171	13	2000	4.00	Rear/Side	1-1/4 NPT	1.75	37.0
H2136201	15	2000	4.00	Rear/Side	1-1/4 NPT	2.00	36.38

Accessories:

Part No.	Description	Wt. (lbs.)
H504	Pump Mounting Bracket for H21 and H50 Series Pumps	7.69

WITH KEYED SHAFT



H2136153

Part No.	Flow at 1000 RPM	Maximum Rotations Per Minute (RPM)	Pilot Diameter	Ports (rear/side)	Inlet Port Size	Gear Size	Wt. (lbs.)
H2136153	11.3	2000	4.00	Rear/Side	1 NPT	1.5	33.00
H2136173	13	2000	4.00	Rear/Side	1-1/4 NPT	1.75	34.15
H2136203	15	2000	4.00	Rear/Side	1-1/4 NPT	2.00	34.33

Accessories:

Part No.	Description	Wt. (lbs.)
H504	Pump Mounting Bracket for H21 and H50 Series Pumps	7.69

H50 SERIES HYDRAULIC GEAR PUMP

- 2 & 4 Bolt SAE B Mount
- Bi-rotational pump

WITH SPLINE SHAFT



H5036171

Part No.	Flow at 1000 RPM	Maximum Rotations Per Minute (RPM)	Pilot Diameter	Ports (rear/side)	Inlet Port Size	Gear Size	Wt. (lbs.)
H5036171	18	2000	4.00	Rear/Side	1-1/4 NPT	1.75	48.00
H5036201	20	2000	4.00	Rear/Side	1-1/4 NPT	2.00	48.44
H5036221	21	2000	4.00	Rear/Side	1-1/2 NPT	2.25	52.20
H5036251	27	2000	4.00	Rear/Side	1-1/2 NPT	2.50	53.37

Accessories:

Part No.	Description	Wt. (lbs.)
H504	Pump Mounting Bracket for H21 and H50 Series Pumps	7.69

WITH KEYED SHAFT



H5036203

Part No.	Flow	Maximum Rotations Per Minute (RPM)	Pilot Diameter	Ports (rear/side)	Inlet Port Size	Gear Size	Flow at 1000 RPM	Wt. (lbs.)
H5036203	20	2000	4.00	Rear/Side	1 1/4 NPT	2.00	20	49.55
H5036253	27		4.00	Rear/Side	1 1/4 NPT	2.50	27	53.56

Accessories:

Part No.	Description	Wt. (lbs.)
H504	Pump Mounting Bracket for H21 and H50 Series Pumps	7.69

Air Shift Cylinders

AIR SHIFT CYLINDER WORKS WITH BUYERS PRODUCTS®, COMMERCIAL®, MUNCI®, & PERMCO® SERIES PUMPS

- Converts manual pump operation to pneumatically controlled pump
- Complete with pump activator cylinder and mounting hardware
- Valve, tubing, fitting, and bracket kit are sold separately (K1010TAS)
- Compatible with Commercial C101/C102, Buyers BPC1010, Muncie E Series, Permco DMD25/DM640, Tyrone T101/T102*



AS301



AS302

Part No.	Description	For Use With	Wt. (lbs.)
AS301	Air Shift Cylinder	C1010 dump pumps	1.67
AS302	Air Shift Cylinder with Tubing and Fittings	C1010 dump pumps	2.71

AIR SHIFT CYLINDER WORKS WITH BUYERS PRODUCTS® CH101/CH102 & PARKER® G101/G102 PUMPS

- Converts manual pump operation to pneumatically controlled pump
- Complete with pump activator cylinder and mounting hardware
- Valve, tubing, fitting, and bracket kit are sold separately (K1010TAS)
- Compatible with Buyers® CH101/CH102, Parker® G101G102



BASK16

Part No.	Description	For Use With	Wt. (lbs.)
BASK16	Air Shift Cylinder	CH101/CH102 Series Dump Pumps	1.43

AIR SHIFT CYLINDER WORKS WITH PERMCO® SERIES PUMPS

- Converts manual pump operation to pneumatically controlled pump
- Complete with pump activator cylinder and mounting hardware
- Valve, tubing, fitting, and bracket kit are sold separately (K1010TAS)
- Compatible with Permco® DM300/DM400



BASK16P

Part No.	Description	For Use With	Wt. (lbs.)
BASK16P	Air Shift Cylinder	Permco® DM300/DM400 Series Pumps	1.38



SILICONE FILLED PRESSURE GAUGES

- 2-1/2" diameter stainless steel case & bezel
- Built-in relief valve
- Dual scale; Accuracy $\pm 1.6\%$ full scale
- Deflection center 40% of scale, otherwise 2% FSD
- Standard stem is 1/4 NPT

PANEL CLAMP MOUNT



HPGP3

Part No.	Diameter	Style	Pressure Range	Wt. (lbs.)
HPGC100	2.5	Panel Clamp	100	0.66

CENTER BACK MOUNT



HPGCB160

Part No.	Diameter	Style	Pressure Range	Wt. (lbs.)
HPGCB160	2.5	Center Back	160	0.55
HPGCB300	2.5	Center Back	300	0.55

PANEL MOUNT



HPGP3

Part No.	Diameter	Style	Pressure Range	Wt. (lbs.)
HPGP3	2.5	Panel Flange	3000	0.65
HPGP5	2.5	Panel Flange	5000	0.66

STEM MOUNT



HPGS160

Part No.	Diameter	Style	Pressure Range	Wt. (lbs.)
HPGS100	2.5	Stem	100	0.51
HPGS160	2.5	Stem	160	0.5
HPGS200	2.5	Stem	200	0.53
HPGS3	2.5	Stem	3000	0.51
HPGS300	2.5	Stem	300	0.56
HPGS4	2.5	Stem	4000	0.51
HPGS5	2.5	Stem	5000	0.51

Motors

HYDRAULIC MOTOR

- Ideal for powering medium-duty applications such as compressors, augers, winches, cranes, and spreaders
- Industry-proven spool valve design combined with state-of-the-art gerotors
- Direction of shaft rotation and shaft speed can be controlled easily and smoothly throughout the speed range of the motor
- Excellent at providing a high degree of start-up torque or the right mixture of torque and flow rate
- **2P = 2 Bolt mount/NPT threads; 4P = 4 Bolt mount/NPT threads**
- *Special order items may require addition lead times*



CM002P



HM074P

Part No.	Flow (Continuous)	Input Mount Type	Pilot Diameter	Shaft Keyway	Displacement	Torque Rating (Continuous)	Port Size	Shaft Size	Wt. (lbs.)
CM002P	12	2 Bolt	3.25	0.25	3.1	650	1/2 NPT	1.00	13.22
CM004P	12	4 Bolt	1.75	0.25	3.1	650	1/2 NPT	1.00	12.74
CM004PH	12	4 Bolt	1.75	0.25	3.1	650	1/2 NPT	1.00	12.75
CM012P	15	2 Bolt	3.25	0.25	4.7	1044	1/2 NPT	1.00	14.02
CM014P	15	4 Bolt	1.75	0.25	4.7	1044	1/2 NPT	1.00	13.8
CM032P	15	2 Bolt	3.25	0.25	7.3	1100	1/2 NPT	1.00	14.28
CM034P	15	4 Bolt	1.75	0.25	7.3	1100	1/2 NPT	1.00	13.37
CM042P	15	2 Bolt	3.25	0.25	9.6	2059	1/2 NPT	1.00	16
CM044P	15	4 Bolt	1.75	0.25	9.6	2059	1/2 NPT	1.00	14.02
CM052P	15	2 Bolt	3.25	0.25	11.9	2343	1/2 NPT	1.00	15.5
CM062P	15	2 Bolt	3.25	0.25	14.6	2669	1/2 NPT	1.00	16
CM072P	15	2 Bolt	3.25	0.25	19.2	2669	1/2 NPT	1.00	16.32
CM074P	15	4 Bolt	1.75	0.25	19.2	3110	1/2 NPT	1.00	15.54
CM082P	15	2 Bolt	3.25	0.25	23.7	3110	1/2 NPT	1.00	14.87
CM084P	15	4 Bolt	1.75	0.25	23.7	2920	1/2 NPT	1.00	16.5
CM092P	20	2 Bolt	3.25	0.25	27.7	2920	1/2 NPT	1.00	23.17
CHAR-LYNN® MOTORS									
HM004P	12	4 Bolt	1.75	0.25	2.8	650	1/2 NPT	1.00	10.67
HM006P	12	2 Bolt	3.25	Cross drilled	2.8	650	1/2 NPT	1.00	11.3
HM034P	15	4 Bolt	1.75	0.25	7.3	1368	1/2 NPT	1.00	9.9
HM074P	15	4 Bolt	1.75	0.25	17.9	3110	1/2 NPT	1.00	12.56

	CM002P CM004P	CM012P CM014P	CM032P CM034P	CM042P CM044P	CM052P CM054P	CM062P CM064P	CM072P CM074P	CM082P CM084P
Displ. cm ³ /r [in ³ /r]	46 [2.8]	74 [4.5]	97 [5.9]	159 [9.7]	185 [11.3]	231 [14.1]	293 [17.9]	370 [22.6]
Max Speed (RPM) @ Continuous Flow	969	760	585	353	304	243	192	152
FLOW LPM [GPM]	Continuous	45 [12]	57 [15]	57 [15]	57 [15]	57 [15]	57 [15]	57 [15]
	Intermittent	53 [14]	68 [18]	68 [18]	76 [20]	76 [20]	76 [20]	76 [20]
Torque LPM [lb-in]	Continuous	73 [650]	118 [1044]	155 [1368]	233 [2059]	265 [2343]	302 [2669]	351 [3110]
	Intermittent**	99 [876]	158 [1401]	207 [1829]	319 [2824]	356 [3151]	415 [3671]	466 [4121]
Min. Starting Torque Nm [lb-in]	@ Cont. Pressure	59 [520]	95 [840]	124 [1100]	186 [1650]	211 [1870]	238 [2110]	282 [2500]
	@ Int. Pressure	81 [720]	130 [1150]	171 [1510]	262 [2320]	293 [2590]	339 [3000]	388 [3430]
Pressure ΔBar [ΔPSI]	Continuous*	124 [1800]	124 [1800]	124 [1800]	114 [1650]	110 [1600]	100 [1450]	93 [1350]
	Intermittent**(**)	165 [2400]	165 [2400]	165 [2400]	155 [2250]	148 [2150]	138 [2000]	124 [1800]

Maximum Case Pressure, without Case Drain is 103 Bar [1500 PSI]

* Maximum intermittent pressure at motor inlet port of 172 Bar [2500 PSI] without regard to A Bar [A PSI] and/or back pressure ratings or combination thereof.

** A simultaneous maximum torque and maximum speed NOT recommended.

6B Splined or Tapered shafts are recommended whenever operating above 282 Nm [2500 lb-in] of torque, especially for those applications subject to frequent reversals.

Δ Bar [Δ PSI] – True pressure difference between inlet port and outlet port.

Continuous Rating – Motor may be run continuously at these ratings.

Intermittent Operation – 10% of every minute.

Recommended Fluids – Premium quality, anti-wear type hydraulic oil. Minimum oil viscosity (at operating temperature) should be the highest of the following:

$$100 \text{ SUS or } \frac{300 \times \text{Bar}}{\text{RPM}} = \text{SUS} \left[\frac{20 \times \text{PSI}}{\text{RPM}} = \text{SUS} \right]$$

Recommended Maximum System Operating Temperature is 82° C [180° F]

Recommended Filtration – per ISO Cleanliness Code, level 18/13

To assure best motor life, run motor for approximately one hour at 30% of rated pressure before application to full load. Be sure motor is filled with fluid prior to any load applications.



DIRECTIONAL CONTROL VALVE

- **VH1 Handle Sold Separately**
- Cast-iron mono block design for reliability and versatility
- Adjustable main relief lets you tackle jobs of varying demands, with a maximum rating of 4000 PSI (when the main relief is set to a higher pressure)
- Rated working pressure: 2500 PSI (172 bar); max. shock and surge pressure: 4000 PSI (276 bar); rated flow capacity: up to 30 GPM (114 L/M)
- Mounting: any position 3 mounting holes for 3/8" bolts
- Integral load-holding check valves prevent reverse flow through valve when shifting
- Integral differential poppet type relief valve, adjustable (set @ 2000 PSI, 10 GPM)
- Balanced, select-fit spools provide minimum leakage and smooth operation; external spool seals permit easy replacement and reduce maintenance cost
- In/out 1-1/16" #12 SAE; work ports 1-1/16" #12 SAE or 3/4"-16 #8 SAE

1 SPOOL



HV13AGOOD0

Part No.	Main Relief Setting	Maximum Pressure	Inlet Port Size	Electrically Operated (y/n)	Handle Included	Wt. (lbs.)
HV11AG2EDO	2000	3500	3/4 SAE ORB (-12)	No	No	12.92
HV11AGOOD0	2000	3500	3/4 SAE ORB (-12)	No	No	12.92
HV11AG00FO	2000	3500	3/4 SAE ORB (-12)	No	No	13
HV11BGOOD0	2000	3500	3/4 SAE ORB (-12)	No	No	14
HV13AG2EDO	2000	3500	3/4 SAE ORB (-12)	No	No	14
HV13AGOOD0	2000	3500	3/4 SAE ORB (-12)	No	No	13.5
HV13PGOOD0	2000	3500	3/4 SAE ORB (-12)	No	No	15

2 SPOOL



HV211AAG2EDO

Part No.	Main Relief Setting	Maximum Pressure	Inlet Port Size	Electrically Operated (y/n)	Handle Included	Wt. (lbs.)
HV211AAG2EDO	2000	3500	3/4 SAE ORB (-12)	No	No	21.91
HV211AAGOOD0	2000	3500	3/4 SAE ORB (-12)	No	No	23.5
HV231AAG3EDO	2000	3500	3/4 SAE ORB (-12)	No	No	23
HV231NAG2ECO	2000	3500	3/4 SAE ORB (-12)	No	No	24
HV233AAG2EDO	2000	3500	3/4 SAE ORB (-12)	No	No	23.5

3 SPOOL



HV3311NAAG2ECO

Part No.	Main Relief Setting	Maximum Pressure	Inlet Port Size	Electrically Operated (y/n)	Handle Included	Wt. (lbs.)
HV3111AAAG2EDO	2000	3500	3/4 SAE ORB (-12)	No	No	33
HV3111AAAGOOD0	2000	3500	3/4 SAE ORB (-12)	No	No	33
HV3311NAAG2ECO	2000	3500	3/4 SAE ORB (-12)	No	No	33

ACCESSORIES FOR CONTROL VALVES



VH1



AS1



B302890

Part No.	Description	Wt. (lbs.)
VH1	Handle And Linkage Assembly Control Valve Accessory	0.33
AS1	Single Spool Air Cylinder Control Valve Accessory	0.83
B302890	Remote Valve Control Connection Kit Control Valve Accessory	0.75

Sectional Valves

SECTIONAL VALVES

21 GPM

- Cast-iron sectional design for reliability and versatility
- Adjustable main relief lets you tackle jobs of varying demands, with a maximum rating of 4300 PSI (when the main relief is set to a higher pressure)
- All ports are #12 SAE ORB (-12)
- Comes with handle kit



BV203

BV303035

Part No.	Description	Main Relief Setting	Port Relief (y/n)	Wt. (lbs.)
BV203	21 GPM Valves 3-Way, No Power Beyond	2250	No	17.42
BV20344P	21 GPM Valves 4-Way With 2 Port Reliefs And Power Beyond	2250	Yes	32
BV203PB	21 GPM Valves 3-Way/Power Beyond	2250	No	17.38
BV204	21 GPM Valves 4-Way, No Power Beyond	2250	No	17.19
BV204PB	21 GPM Valves 4-Way/Power Beyond	2250	No	17.77
BV204PR	21 GPM Valves 4-Way With 1 Port Relief	2250	Yes	17.77
BV204PRPB	21 GPM Valves 4-Way With 1 Port Relief And Power Beyond	2250	Yes	17.73

Accessories:

Part No.	Description	Wt. (lbs.)
BV100CYL	Single Spool BV20 Air shift Cylinder	1
BV303035	Valve Connection Kit For BV20 Valves	0.4

40 GPM

- Cast-iron sectional design for reliability and versatility
- Adjustable main relief lets you tackle jobs of varying demands, with a maximum rating of 4300 PSI (when the main relief is set to a higher pressure)
- All ports are #12 SAE ORB (-12)
- Comes with handle kit



BV403PB

BV303036

Part No.	Description	Main Relief Setting	Port Relief (y/n)	Wt. (lbs.)
BV403	40 GPM Valves 3-Way	2500	No	31.68
BV403PB	40 GPM Valves 3-Way With Power Beyond	2500	No	31.32
BV404	40 GPM Valves 4-Way	2500	No	31.13
BV404PR	40 GPM Valves 4-Way With 1 Port Relief	2500	Yes	31.32

Accessories:

Part No.	Description	Wt. (lbs.)
BV160CYL	Single Spool BV40 Air shift Cylinder	1.5
BV303036	Valve Connection Kit For BV40 Valves	0.4

HYDRAULIC VALVE

- 3 position, 3-way with air shift 1" NPT inlet work ports, 1-1/4 NPT return to tank
- 35 gallon nominal flow rating
- Relief valve preset @ 2,000 PSI (max allowable)
- Can also be shifted with handle (Part No. HV25H)
- HV25 handle and linkage kit sold separately



HV25

Part No.	Main Relief Setting	Maximum Pressure	Port Relief (y/n)	Inlet Port Size	Electrically Operated (y/n)	Wt. (lbs.)
HV25	2000	3000	Yes	1 NPT	N	22

Accessories:

Part No.	Description	Wt. (lbs.)
HV25H	Handle For HV25 Hydraulic Valve	1.1



ELECTRIC SECTIONAL VALVE

- 12V, 2.4 amps per coil rated to 11 GPM max flow (non proportional)
- All ports are #8 SAE straight thread
- Valve rated to 4300 PSI with higher pressure main relief (non standard)
- Main relief 1300-3000 PSI (set at 2150 PSI);
- Port relief angle 1900-4300 PSI (set at 2150 PSI); port relief dump 400-1900 PSI (set at 600 PSI)
- All valves have cylinder spools unless specified as motor
- All ports are #12 SAE ORB (-12)
- **More options available. Call 440-299-5430 or 8444-974-8324 (option 4) for availability.**



HVE33PB



HVESB



3030861



HVEH9



HVEH20

Part No.	Description	Main Relief Setting	Maximum Pressure	Number of spools	Wt. (lbs.)
HVE3	Electric Sectional Valve 3-Way	1300-3000 (Set at 2150)	3600	1	33.47
HVE334PB	Electric Sectional Valve 3-Way/3-Way/4-Way/PB	1300-3000 (Set at 2150)	3600	3	12
HVE33PB	Electric Sectional Valve 3-Way/3-Way/PB	1300-3000 (Set at 2150)	3600	2	17.04
HVE342PR4PRPB	Electric Sectional Valve 3-Way/4-Way 2-Relief Ports/4-Way Relief Port/PB	1300-3000 (Set at 2150)	3600	3	16
HVE342PRPB	Electric Sectional Valve 3-Way/4-Way 2-Port Reliefs/PB	1300-3000 (Set at 2150)	3600	2	17.47
HVE344PB	Electric Sectional Valve 3-Way/4-Way/4-Way/PB	1300-3000 (Set at 2150)	3600	3	12
HVE34M	Electric Sectional Valve 3-Way/4-Way Motor Spool	1300-3000 (Set at 2150)	3600	2	50.17
HVE34M3PB	Electric Sectional Valve 3-Way/4-Way Motor/3-Way/PB	1300-3000 (Set at 2150)	3600	3	15
HVE34PR3PR3PRPB	Electric Sectional Valve 3-Way/4-Way 2-Reliefs/3-Way 1-Relief/3-Way 1-Relief/PB	1300-3000 (Set at 2150)	3600	4	30.9
HVE3PB	Electric Sectional Valve 3-Way/PB	1300-3000 (Set at 2150)	3600	1	12.66
HVE4	Electric Sectional Valve 4-Way	1300-3000 (Set at 2150)	3600	1	10.93
HVE42PRPB	Electric Sectional Valve 4-Way 2-Relief Port/PB	1300-3000 (Set at 2150)	3600	1	11.3
HVE44	Electric Sectional Valve 4-Way/4-Way	1300-3000 (Set at 2150)	3600	2	18.03
HVE44PB	Electric Sectional Valve 4-Way/4-Way/PB	1300-3000 (Set at 2150)	3600	2	16.97
HVE4PB	Electric Sectional Valve 4-Way/PB	1300-3000 (Set at 2150)	3600	1	10.99
HVE4PR	Electric Sectional Valve 4-Way 1-Relief Port	1300-3000 (Set at 2150)	3600	1	12.5
HVE4PRPB	Electric Sectional Valve 4-Way 1 Relief Port/PB	1300-3000 (Set at 2150)	3600	1	10

Accessories:

Part No.	Description	Wt. (lbs.)
HVESB	Switch Panel for Electrically Operated Sectional Valve	0.98
HVEH9	9 Foot Harness For Electrically Operated Sectional valve	0.83
HVEH20	20ft Wire Harness For Electrically Operated Sectional valve	5.00
3030861	Switch Box For HVE 1 Spool Valve	0.98
3030867	20ft Wire Harness For Hoist Spool 1 Valve	1.75

Sectional Valve Terms

- Power Beyond (permits use of neutral flow at system pressure); also permits field conversion from closed center to open center (tandem) operation
- 3 Way = Power Up, Gravity Down
- 4 Way = Power Up, Power Down
- 3 Position = Spool / Handle has 3 positions: Up/Neutral/Down

- Spring Centered = Spool returns to neutral when operator releases
- Detent = Valve Spool stays in position until changed by operator
- Air Cylinder (Converts valve from manual to air operated)
- Cable Connection Kit (Converts valve from manual to cable operated)
- 1 PR = one port relief
- 2 PR = two port relief

Valves

SIDE PORTED PRIORITY FLOW DIVIDER VALVE

- Maximum operating pressure: 3000 PSI
- Once set, the unit maintains constant flow regardless of load variations; excess flow is returned to tank or used to power another function
- Priority flow dividers split the oil from a single inlet into two separate flows: 1. A controlled, adjustable flow which has priority on the oil entering the valve port "CF" 2. A secondary flow based on oil in excess of that demanded by the priority flow port "EX"
- Both flows may be used simultaneously at different pressures without affecting the priority flow rate
- External lockable adjusting knob controls priority flow rate
- Load may be applied to either port without affecting priority flow rate



HFDL075

Part No.	Material	Number of Ports	Maximum Flow Rate	Maximum Pressure	Port Size	Wt. (lbs.)
HFDL075	Cast Iron	3	30	3000	3/4 NPTF	7.71
HFDL075SAE	Cast Iron	3	30	3000	3/4 SAE ORB (-12)	7.71

PRIORITY FLOW DIVIDER VALVE

- Maximum operating pressure: 3000 PSI
- Priority flow dividers split the oil from a single inlet into two separate flows: 1. A controlled, adjustable flow which has priority on the oil entering the valve port closest to the adjustment dial 2. A secondary flow based on oil in excess of that demanded by the priority flow port furthest from the adjustment dial
- Both flows may be used simultaneously at different pressures without affecting the priority flow rate
- External adjusting knob controls priority flow rate
- Load may be applied to either port without affecting priority flow rate



HFD100

Part No.	Material	Number of Ports	Maximum Flow Rate	Maximum Pressure	Port Size	Wt. (lbs.)
HFD075	Cast Iron	3	20	3000	3/4 NPTF	7
HFD100	Cast Iron	3	30	3000	1 NPTF	7.5

FLOW CONTROL VALVE

- Available in NPT and SAE
- Provide precise control of flow, and automatically permit full flow in the opposite direction
- Cracking pressure for return check poppet: 5 PSI (0.4 bar)
- Maximum operating pressure: brass: F models, inline only: 2000 PSI (140 bar); steel: 400-800 sizes: 5000 PSI; 1200 sizes: 3000 PSI



F1200S

Part No.	Material	Number of Ports	Maximum Flow Rate	Maximum Pressure	Port Size	Wt. (lbs.)
F1200S	Carbon Steel	2	25	5000	3/4 NPTF	1.1
F1200SAE	Carbon Steel	2	25	5000	3/4 SAE ORB (-12)	2.33
F400B	Brass	2	5	2000	1/4 NPTF	0.48
F400S	Carbon Steel	2	5	5000	1/4 NPTF	1.066
F400SAE	Carbon Steel	2	5	5000	1/4 SAE ORB (-4)	1.9
F600S	Carbon Steel	2	8	5000	3/8 NPTF	0.79
F600SAE	Carbon Steel	2	8	5000	3/8 SAE ORB (-6)	1.1
F800S	Carbon Steel	2	15	5000	1/2 NPTF	2.402
F800SAE	Carbon Steel	2	15	5000	1/2 SAE ORB (-8)	2.46



TWO POSITION SELECTOR VALVE

- Maximum operating pressure: 3000 PSI
- Selector valves are designed with a hydraulically balanced spool that allows them to be shifted under full line pressure
- System pressure is bled off to a low pressure leg before reaching the seal, resulting in a reduced effort required to shift the spool
- The seal is operated in an unloaded condition



HSV100

Part No.	Material	Number of Ports	Maximum Flow Rate	Maximum Pressure	Port Size	Wt. (lbs.)
HSV050	Cast Iron	3	10	3000	1/2 NPTF	2.95
HSV075	Cast Iron	3	20	3000	3/4 NPTF	7.5
HSV100	Cast Iron	3	30	3000	1 NPTF	7.5

Accessories:

Part No.	Description	Wt. (lbs.)
HSV1C	Air Cylinder	1.09

IN-LINE RELIEF VALVE

- Pressure range: 1501-3000 PSI
- HRV07516 preset at 1650 PSI, HRV07518 preset at 2000 PSI, HRV10018 preset at 2000 PSI, HRV10025 preset at 2500 PSI
- Maximum operating pressure: 3000 PSI



HRV07516

Part No.	Material	Maximum Relief Pressure Setting	Number of Ports	Maximum Flow Rate	Maximum Pressure	Port Size	Wt. (lbs.)
HRV07516	Cast Iron	1501	3	30	3000	3/4 NPTF	2.2
HRV07518	Cast Iron	1501	3	20	3000	3/4 NPTF	2.2
HRV10018	Cast Iron	1501	3	30	3000	1 NPTF	2.43
HRV10025	Cast Iron	1501	3	50	3000	1 NPTF	8.09

CROSS-OVER RELIEF VALVE (NPTF PORT)

- Maximum operating pressure: 3000 PSI
- HCR050 set at 1000 PSI, but is adjustable between 500-1500 PSI
- HCR075 set at 1000 PSI
- NPTF ports



HCR050

Part No.	Material	Maximum Relief Pressure Setting	Number of Ports	Maximum Flow Rate	Maximum Pressure	Port Size	Wt. (lbs.)
HCR050	Cast Iron	1500	4	10	3000	1/2 NPTF	4.29
HCR075	Cast Iron	1500	4	20	3000	3/4 NPTF	7

Valves

PLOW COUPLER DRAIN VALVE

- Machined billet aluminum with anodized finish
- Relieves plow coupler pressure to disconnect plow couplers more easily
- 1/2" ORB pressure ports
- 1/4" ORB return port



6241005



6241005 Application

Part No.	Material	Wt. (lbs.)
6241005	Aluminum	3.45

DOUBLE CHECK VALVE

- Pilot operated
- Available with 1/2" N.P.T.F. or 1/2" SAE ports
- Working pressure: 3625 PSI / 250 BAR
- Maximum operating pressure: 4422 PSI / 315 BAR
- Cracking pressure: 72.5 PSI / 5 BAR
- Used to convert latch pin plow applications to power angle plows



HCVD08

Part No.	Material	Number of Ports	Maximum Flow Rate	Maximum Pressure	Port Size	Wt. (lbs.)
HCVD08	Oil Tempered Steel	2	15	3625	1/2 NPTF	3.15
HCVD08SAE	Oil Tempered Steel	2	15	3625	1/2 SAE ORB (-8)	3.15

STEEL CHECK VALVE

- Stops flow in one direction and free flows in the other direction
- Available in NPT and SAE
- Female ports on each end
- 5 PSI spring
- Max pressure: 4500 PSI



HCV050

Part No.	Maximum Pressure	Inlet Port Size	Electrically Operated (y/n)	Wt. (lbs.)
HCV038	4500	3/8 NPTF	No	0.43
HCV050	4500	1/2 NPTF	No	1
HCV075	4500	3/4 NPTF	No	1.7
HCV100	4500	1 NPTF	No	2.15



FULL FLOW GATE VALVE

- Complete with a screw-on bonnet, non-rising stem, solid wedge disc, and integral seats
- Recommended for non-steam use in residential and light commercial applications
- May be repacked while in service under pressure
- 200 PSI W.O.G. Non-shock



HGVO50

Part No.	Ball Material	Body Material	Maximum Pressure (Water, Oil, Gas)	Maximum Working Pressure	Thread Size	Wt. (lbs.)
HGVO38	Brass	Brass	200	200	3/8 NPT	0.5
HGVO50	Brass	Brass	200	200	1/2 NPT	0.6
HGV075	Brass	Brass	200	200	3/4 NPT	0.7
HGV100	Brass	Brass	200	200	1 NPT	1
HGV125	Brass	Brass	200	200	1 1/4 NPT	1.6
HGV150	Brass	Brass	200	200	1 1/2 NPT	2
HGV200	Brass	Brass	200	200	2 NPT	2.9
HGV250	Brass	Brass	200	200	2 1/2 NPT	6.1

BRASS BODY BALL VALVE

- For control of air, water, oil & gas
- 600 PSI W.O.G. Non-shock



HBV075

Part No.	Ball Material	Body Material	Maximum Pressure (Water, Oil, Gas)	Maximum Working Pressure	Thread Size	Wt. (lbs.)
HBV025	Hardened Steel	Brass	600	600	1/4 NPT	0.4
HBV038	Hardened Steel	Brass	600	600	3/8 NPT	0.3
HBV050	Hardened Steel	Brass	600	600	1/2 NPT	0.6
HBV075	Hardened Steel	Brass	600	600	3/4 NPT	0.8
HBV100	Hardened Steel	Brass	600	600	1 NPT	1.4
HBV125	Hardened Steel	Brass	600	600	1 1/4 NPT	1.94
HBV150	Hardened Steel	Brass	600	600	1 1/2 NPT	2.82
HBV200	Hardened Steel	Brass	600	600	2 NPT	3.5
HBV250	Hardened Steel	Brass	600	600	2 1/2 NPT	8.9

HIGH PRESSURE BALL VALVE

- Rugged carbon steel construction
- 3/8" to 1" NPTF
- Blow out proof stems
- Buna seals standard

3 PORT



HBV3W038

Part No.	Ball Material	Body Material	Maximum Pressure (Water, Oil, Gas)	Maximum Working Pressure	Thread Size	Wt. (lbs.)
HBV3W038	Hardened Steel	Carbon Steel	5800	5800	3/8 NPT	0.9
HBV3W050	Hardened Steel	Carbon Steel	5000	5800	1/2 NPT	1.5
HBV3W075	Hardened Steel	Carbon Steel	5000	5000	3/4 NPT	3.52
HBV3W100	Hardened Steel	Carbon Steel	5000	5000	1 NPT	5.32

2 PORT



HBVS038

Part No.	Ball Material	Body Material	Maximum Pressure (Water, Oil, Gas)	Maximum Working Pressure	Thread Size	Wt. (lbs.)
HBVS025	Hardened Steel	Carbon Steel	7250	7250	1/4 NPT	0.88
HBVS038	Hardened Steel	Carbon Steel	7250	7250	3/8 NPT	1.44
HBVS050	Hardened Steel	Carbon Steel	7250	7250	1/2 NPT	1.68
HBVS075	Hardened Steel	Carbon Steel	7250	7250	3/4 NPT	3.46
HBVS100	Hardened Steel	Carbon Steel	7250	7250	1 NPT	4.45

Spreader Valves

HYDRAULIC SPREADER VALVES

- Built-in differential style relief valve and on/off valve in a single, compact aluminum body
- Detent hand knob with 11 positive positions makes it easy to adjust flow
- All ports are 3/4" NPT except 1/2" NPT spinner port
- Relief cartridge standard setting: 1500 PSI (105 bar)

SINGLE FLOW

- Single flow regulator with built-in on/off control plus system relief



HV020

Part No.	What's Included	Flow (GPM)	Flow (LPM)	Wt. (lbs.)
HV020	Valve Only	20	76	6.09
HVC020	Valve and Console	20	76	19.21

Accessories:

Part No.	Description	Wt. (lbs.)
ACC01	Side Mount Accessory Plate	0.5
HVC1	Dual Flow Hydraulic Spreader Valve Console Only	13.12

DUAL FLOW

- Dual flow regulator with built-in on/off control plus system relief



HV1030SAE

Part No.	What's Included	Flow (GPM)	Flow (LPM)	Wt. (lbs.)
HV715	Valve Only	22	85	7
HV715SAE	Valve Only	22	85	7
HVC715	Valve and Console	22	85	20.77
HV1030	Valve Only	40	153	7.5
HV1030SAE	Valve Only	40	153	7
HVC1030	Valve and Console	40	153	21

Accessories:

Part No.	Description	Wt. (lbs.)
HVC1	Dual Flow Hydraulic Spreader Valve Console Only	13.12
ACC01	Side Mount Accessory Plate	0.5

LOAD SENSING SPREADER VALVE

- Internal load sensing checks to communicate pressure signals to load sensing pump
- Honed and matched hardened steel working parts for long life
- Detent hand knob with minimum/maximum stops (eleven positive positions)
- Fully pressure compensated
- #12 SAE O-Ring Port (auger, spinner, tank, pressure)
- #4 SAE O-Ring LS Port



HV515LS

Part No.	What's Included	Flow (GPM)	Flow (LPM)	Wt. (lbs.)
HV515LS	Valve Only	20	76	7
HV1030LS	Valve Only	40	153	7

Accessories:

Part No.	Description	Wt. (lbs.)
ACC01	Side Mount Accessory Plate	0.5
HVC1	Dual Flow Hydraulic Spreader Valve Console Only	13.12



ELECTRIC-HYDRAULIC PROPORTIONAL CONTROL KIT WITH GARMIN® GPS GROUND SPEED ANTENNA

- The SaltDogg® GPS Spreader Control provides proportional spreader operation
- The Garmin® GPS Antenna plugs in for hassle-free installation on any truck and provides exceptional spreader response
- The wire harness uses weather pack connectors for secure, corrosion free-connections
- The proportional valves are housed in a protective weather enclosure for reliable service and deliver 0-7GPM (HV715EPG) or 0-10GPM (HV1030EPG) for the spinner and 0-15GPM (HV715EPG) or 0-30GPM (HV1030EPG) for the auger-conveyor circuits
- HV715EP/HV1030EP: 12V programmable LED display controller with detented auger-conveyor/spinner controls (GPS feature not available)
- HV715EPG/HV1030EPG: 3 function controller with LED display: Spinner, Auger-Conveyor, and Electric Pre-Wet with GPS feature



HV715EP / HV1030EP



HV715EPG / HV1030EPG

Part No.	Description	What's Included	Flow (GPM)	Flow (LPM)	Wt. (lbs.)
HV715EP	Electric-Hydraulic Proportional Control Kit, 15 Gallon	Valve And Control	22	85	30
HV715EPG	Electric-Hydraulic Proportional Control Kit With Garmin® GPS Ground Speed Antenna, 15 Gallon	Valve, Control, GPS	22	85	31
HV1030EP	Electric-Hydraulic Proportional Control Kit, 30 Gallon	Valve And Control	40	153	27.64
HV1030EPG	Electric-Hydraulic Proportional Control Kit With Garmin® GPS Ground Speed Antenna, 30 Gallon	Valve, Control, GPS	40	153	31

GARMIN® GPS UNIT FOR ELECTRIC-HYDRAULIC PROPORTIONAL CONTROL KIT



GPS1

Part No.	For Use With	Wt. (lbs.)
GPS1	HV715EP/G and HV1030EP/G Series	0.7

PROPORTIONAL HYDRAULIC VALVE

- 12V DC PWM, open center
- 0-28 GPM flow rate
- 3 ports: pressure in, output, tank, #10 SAE ORB
- Relief set @ 1500, adjustable



LSV12

Part No.	For Use With	Wt. (lbs.)
LSV12	SaltDogg® Anti-Ice and Pre-Wet Systems	5







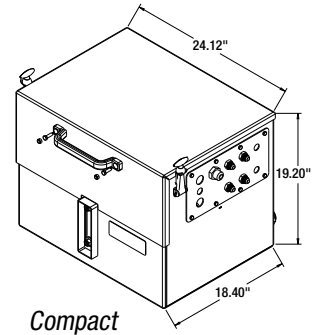
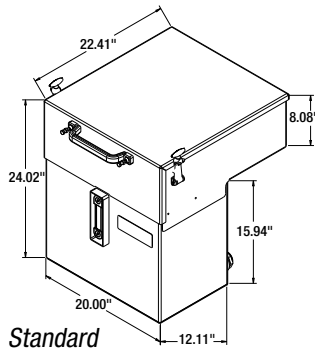







Central Hydraulic Systems

15 GALLON SYSTEMS

- 304 Stainless steel reservoir for corrosion resistance
- Ported valves eliminate excessive plumbing
- Pre-plumbed for quick installation (standard)
- Includes:
 - In-tank return filter
 - Stainless steel strainer
 - Poly filler/breather assembly
 - Sight temperature and level gauge
 - Easily removed enclosure lid



SYSTEM OPTIONS:

VALVING FUNCTIONS	PLOW/HOIST CONTROL	SPREADER CONTROL	RESERVOIR TYPE	SYSTEM PART NO.		
4 FUNCTION: ELECTRIC ON/OFF 	 3030861- Electric ON/OFF dump/hoist control	 HVC05 - Auger/conveyor, spinner controls with programmable blast	 3030999 - Standard	6381540		
			 3047258 - Compact	6381542		
		 HVC06 - Auger/conveyor, spinner, and pre-wet controls with programmable blast with Garmin® GPS ground speed control	 3030999 - Standard	6381541		
			 3047258 - Compact	6381544		
		6 FUNCTION: ELECTRIC ON/OFF 	 HVESB- ON/OFF Electric dump/hoist and plow control	 HVC05 - Auger/conveyor, spinner controls with programmable blast	 3031000 - Standard	6381560
					 3031000 - Standard	6381561
 HVC06 - Auger/conveyor, spinner, and pre-wet controls with programmable blast with Garmin® GPS ground speed control	 3050999 - Compact			6381564		



4 FUNCTION SYSTEMS - ELECTRIC/HYDRAULIC

Part No.	Description
6381540	4 Function , 15 Gal. Capacity, Manual Spreader Control

Contains:

3030999	Reservoir, 15 Gal. Assembly, 4 Function
HVH20	20ft Wire Harness, Valve Side
3030867	20ft Wire Harness, Hoist Spool
3030861	Switch Box For HVE 1 Spool Valve
HVC05	Controller for HV715EP or HV1030EP
HVH8	8ft Wire Harness, Power Side
HVEH9	9ft Wire Harness for HVE Valves

Part No.	Description
6381542	4 Function , 15 Gal. Capacity, Manual Spreader Control

Contains:

3047258	Compact Reservoir, 15 Gal. Assembly, 4 Function
HVH20	20ft Wire Harness, Valve Side
3030867	20ft Wire Harness, Hoist Spool
HVEH9	9ft Wire Harness for HVE Valves
3030861	Switch Box For HVE 1 Spool Valve
HVC05	Controller for HV715EP or HV1030EP
HVH9	8ft Wire Harness for HVC06

Part No.	Description
6381541	4 Function , 15 Gal. Capacity, GPS Ground Speed Control

Contains:

3030999	Reservoir, 15 Gal. Assembly, 4 Function
HVH20	20ft Wire Harness, Valve Side
3030867	20ft Wire Harness, Hoist Spool
HVH9	8ft Wire Harness for HVC06
HVEH9	9ft Wire Harness for HVE Valves
3030861	Switch Box For HVE 1 Spool Valve
HVC06	Controller with Ground Speed Input
GPS1	GPS Unit with Converter and Connector

Part No.	Description
6381544	4 Function , 15 Gal. Capacity, GPS Ground Speed Control

Contains:

3047258	Compact Reservoir, 15 Gal. Assembly, 4 Function
HVH20	20ft Wire Harness, Valve Side
3030867	20ft Wire Harness, Hoist Spool
HVH9	8ft Wire Harness for HVC06
HVEH9	9ft Wire Harness for HVE Valves
3030861	Switch Box For HVE 1 Spool Valve
HVC06	Controller with Ground Speed Input
GPS1	GPS Unit with Converter and Connector

6 FUNCTION SYSTEMS - ELECTRIC/HYDRAULIC

Part No.	Description
6381560	6 Function , 15 Gal. Capacity, Manual Spreader Control

Contains:

3031000	Reservoir, 15 Gal. Assembly, 6 Function
HVH20	20ft Wire Harness, Valve Side
HVEH20	20ft Wire Harness, HVE 3 Spool
HVC05	Controller for HV715EP or HV1030EP
HVH8	8ft Wire Harness, Power Side
HVESB	Switch Box for HVE 3 Spool Valve
HVEH9	9ft Wire Harness for HVE 3 Spool Power

Part No.	Description
6381561	6 Function , 15 Gal. Capacity, GPS Ground Speed Control

Contains:

3031000	Reservoir, 15 Gal. Assembly, 6 Function
HVH20	20ft Wire Harness, Valve Side
HVEH20	20ft Wire Harness, HVE 3 Spool
HVH9	8ft Wire Harness for HVC06
HVC06	Controller with Ground Speed Input
GPS1	GPS Unit with Converter and Connector
HVESB	Switch Box for HVE 3 Spool Valve
HVEH9	9ft Wire Harness for HVE Valves

Part No.	Description
6381564	6 Function , 15 Gal. Capacity, GPS Ground Speed Control

Contains:

3050999	Compact Reservoir, 15 Gal. Assembly, 6 Function
HVH20	20ft Wire Harness, Valve Side
HVEH20	20ft Wire Harness, HVE 3 Spool
HVH9	8ft Wire Harness for HVC06
HVC06	Controller with Ground Speed Input
GPS1	GPS Unit with Converter and Connector
HVESB	Switch Box for HVE 3 Spool Valve
HVEH9	9ft Wire Harness for HVE Valves

Central Hydraulic Systems

30 GALLON SYSTEMS

- 304 Stainless steel reservoir for corrosion resistance
- Bottom ported valves eliminate excessive plumbing
- Pre-plumbed for quick installation
- Includes:
 - In-tank return filter
 - Stainless steel strainer
 - Poly filler/breather assembly
 - Sight temperature and level gauge
 - Easily removed enclosure lid

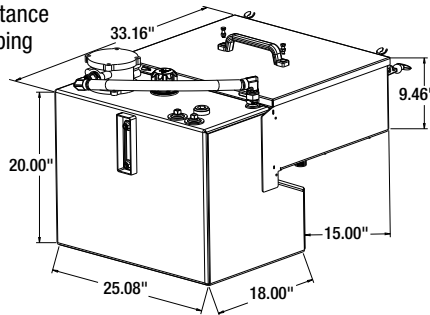



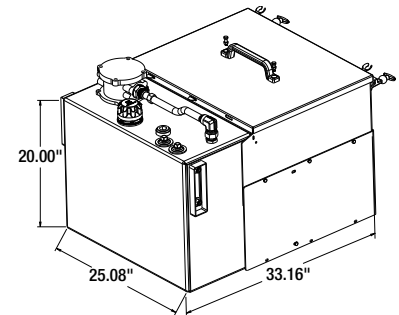









3034441 Reservoir



3041000 Reservoir

SYSTEM OPTIONS:

VALVING FUNCTIONS	PLOW/HOIST CONTROL & MOUNT	SPREADER CONTROL	RESERVOIR TYPE	SYSTEM PART NO.			
6 FUNCTION: <i>AIR PROPORTIONAL</i>		Proportional air dump/hoist with neutral safety interlock and plow joystick control	 HVC06T	 3034441	6383060		
		console with floor base	 HVC06T with GPS	 3034441	6383061		
		 console with seat mounted base	 3039773	 3034441	6383065		
		6 FUNCTION: <i>ELECTRIC PROPORTIONAL</i>	Proportional electric dump/hoist with neutral safety interlock and plow joystick control	 3039773	 3041000	6383063	
					console with floor base	 3041000	6383064
					 console with seat mounted base		



6 FUNCTION SYSTEMS - AIR PROPORTIONAL

Part No.	Description
6383060	6 Function , 30 Gal. Capacity, Air Proportional, No GPS, Floor Mounted Base
Contains:	
HVC06T	4.3" Touch Screen Spreader Controller
K70FDA	Dual Axis Feathering Air Control Valve
K70DFD	Single Lever Air Control Valve
HVH8	8ft Wire Harness, Power Side
HVH25	25ft Wire Harness, Valve Side
SK12	Body-Up Indicator Kit with Buzzer Light

Part No.	Description
6383061	6 Function , 30 Gal. Capacity, Air Proportional, with GPS, Floor Mounted Base
Contains:	
HVC06T	4.3" Touch Screen Spreader Controller
K70FDA	Dual Axis Feathering Air Control Valve
K70DFD	Single Lever Air Control Valve
HVH8	8ft Wire Harness, Power Side
HVH25	25ft Wire Harness, Valve Side
SK12	Body-Up Indicator Kit with Buzzer Light
GPS1	GPS Unit with Converter and Connector

Part No.	Description
6383065	6 Function , 30 Gal. Capacity, Air Proportional, No GPS, Seat Mounted Base
Contains:	
3039773	3 Channel Spreader Controller
K70FDA	Dual Axis Feathering Air Control Valve
K70DFD	Single Lever Air Control Valve
3039774	25ft Wire Harness, Main
3039775	4ft Wire Harness for 3039773
3045673	3ft Wire Harness, Spreader
SK12	Body-Up Indicator Kit with Buzzer Light

6 FUNCTION SYSTEMS - ELECTRIC PROPORTIONAL

Part No.	Description
6383063	6 Function , 30 Gal. Capacity, Electric Proportional, No GPS, Floor Mounted Base
Contains:	
3039773	3 Channel Spreader Controller
3039777	Dual Axis 2 Button Joystick
3044940	Single Axis Joystick with Push Button
3039774	25ft Wire Harness, Main
3039775	4ft Wire Harness for 3039773
3039776	Programmable Plow Module
3039778	Wire Harness, Plow Module to Joystick
3045673	3ft Wire Harness, Spreader
SK12	Body-Up Indicator Kit with Buzzer Light

Part No.	Description
6383064	6 Function , 30 Gal. Capacity, Electric Proportional, No GPS, Seat Mounted Base
Contains:	
3039773	3 Channel Spreader Controller
3039777	Dual Axis 2 Button Joystick
3044940	Single Axis Joystick with Push Button
3039774	25ft Wire Harness, Main
3039775	4ft Wire Harness for 3039773
3039776	Programmable Plow Module
3039778	Wire Harness, Plow Module to Joystick
3045673	3ft Wire Harness, Spreader
SK12	Body-Up Indicator Kit with Buzzer Light

OPTIONAL 6391308 - 8-Function "Smart Switch" Panel With Backlit Legends, LED Indicator Lights, 15A Load Rating Per Switch *Can be used with all 30 Gallon CHS Systems. Installs in the Control Console.* See page 250 for complete details.

Part No.	Description
6391308	8-Function "Smart Switch" Panel with Backlit Legends



Power Units

3-WAY DC POWER UNIT - ELECTRIC CONTROL SERIES

- Pump/motor/reservoir/control station
- Externally adjustable system relief valve and check valve
- Solenoid actuated, normally closed release valve is mounted externally
- Double filtration: suction filter and valve body
- 3-way function: power up/gravity down



PU319

Part No.	Manual or Push Button	Mounting Position	Motor Horsepower	Reservoir Volume (Gal)	Number of Cartridge Valves	Controller Included?	Wt. (lbs.)
PU319	Push Button	Horizontal	2	0.75	1	Y	26
PU319A	Push Button	Horizontal	2	0.75	1	Y	26
PU319LR	Push Button	Horizontal	2	1.50	1	Y	29
PU319LRA	Push Button	Horizontal	2	1.50	1	Y	30
PU319LRS	Push Button	Horizontal	2	1.50	1	Y	41
PU319LRSA	Push Button	Horizontal	2	1.50	1	Y	42

Accessories:

Part No.	Description	Wt. (lbs.)
HBF12P	DC Hydraulic Power Unit's Poly 3/4 Inch Breather Cap	0.04
17006	Control Box with 3 Wire Cord and Clamp	1.5

3-WAY VALVE DC POWER UNIT - ELECTRIC CONTROL SERIES

- Pump/motor/steel reservoir/control box with 6' cord
- Suction filter
- Large dump valve, 8 GPM max flow on down side
- 3-way function, power up - gravity down
- External flow control on down side



PU303LRSA

Part No.	Manual or Push Button	Mounting Position	Motor Horsepower	Reservoir Volume (Gal)	Number of Cartridge Valves	Controller Included?	Wt. (lbs.)
PU303LRS	Push Button	Horizontal	2	3.00	1	Y	47
PU303LRSA	Push Button	Horizontal	2	3.00	1	Y	48

Accessories:

Part No.	Description	Wt. (lbs.)
HBF12P	DC Hydraulic Power Unit's Poly 3/4 Inch Breather Cap	0.04

4-WAY DC POWER UNIT - ELECTRIC CONTROL SERIES

- Pump/motor/reservoir/factory wired control station and cable
- Externally adjustable system relief valve; cartridge valves are located outside the reservoir on PU642 & PU642LR. Inside on PU642S & PU642LRS
- Check valve
- 4-way function, power up - power down
- C-1 port is positively checked (2500 PSI), raise; C-2 port 800 PSI, lower
- Triple filtration: suction, high pressure return and valve



PU642

Part No.	Manual or Push Button	Mounting Position	Motor Horsepower	Reservoir Volume (Gal)	Number of Cartridge Valves	Controller Included?	Wt. (lbs.)
PU642	Push Button	Horizontal	2	0.86	2	Y	39
PU642A	Push Button	Horizontal	2	0.75	2	Y	40
PU642LR	Push Button	Horizontal	2	1.50	2	Y	40.25
PU642LRA	Push Button	Horizontal	2	1.50	2	Y	41
PU642LRS	Push Button	Horizontal	2	1.50	2	Y	47.88
PU642LRSA	Push Button	Horizontal	2	1.50	2	Y	50

Accessories:

Part No.	Description	Wt. (lbs.)
17006	Control Box with 3 Wire Cord and Clamp	1.5
HBF12P	DC Hydraulic Power Unit's Poly 3/4 Inch Breather Cap	0.04
17008	Control Box with 4 Wire 2 Cord and Clamp	1.5



4-WAY/3-WAY DC POWER UNIT - ELECTRIC CONTROL SERIES

- Pump/motor/reservoir/factory wired control station and cable
- Externally adjustable system relief valve
- Cartridge valves are located outside the reservoir on manifold block
- 4-way/3-way function: power up/gravity down
- C-1 & C2 plow angle 1200 PSI crossover relief, C-3 2000 PSI
- Triple filtration: suction, high pressure return and valve; plow lift and plow angle function supported



PU3593LRA

Part No.	Manual or Push Button	Mounting Position	Motor Horsepower	Reservoir Volume (Gal)	Number of Cartridge Valves	Controller Included?	Wt. (lbs.)
PU3593	Rocker Switch	Horizontal	2	0.32	4	Y	34
PU3593A	Push Button	Horizontal	2	0.32	4	Y	36
PU3593LR	Push Button	Horizontal	2	0.83	4	Y	42
PU3593LRA	Push button	Horizontal	2	0.83	4	Y	0
PU3593LRV	Push Button	Vertical	2	0.87	4	Y	42

Accessories:

Part No.	Description	Wt. (lbs.)
HBF12P	DC Hydraulic Power Unit's Poly 3/4 Inch Breather Cap	0.04

3 WAY VALVE DC POWER UNIT - MANUAL CONTROLS

- Pump/motor/reservoir
- Externally adjustable system relief valve
- Manually operated 3-way valve with cylinder port checked
- Electrical contact for synchronizing valve and motor; Power Up/Gravity Down
- .250" NPTF outlet
- Horizontal mounted; complete with suction filter and rod and ball handle



pu5003

Part No.	Manual or Push Button	Mounting Position	Motor Horsepower	Reservoir Volume (Gal)	Number of Cartridge Valves	Controller Included?	Wt. (lbs.)
PU5003	Manual	Horizontal	1.5	0.45	0	No	32

Accessories:

Part No.	Description	Wt. (lbs.)
HBF12P	DC Hydraulic Power Unit's Poly 3/4 Inch Breather Cap	0.04

3-WAY METERED RELEASE VALVE DC UNIT - MANUAL CONTROLS

- Pump/motor/reservoir
- Externally adjustable system relief valve
- Check valve and normally closed manually operated release valve with built-in metering for "fine control" of lowering speed
- Heavy duty motor start switch (power up/gravity down) and horizontal mounting
- .250" & .375" NPTF outlet ports
- Complete with suction filter and rod and ball handle



PU311

Part No.	Manual or Push Button	Mounting Position	Motor Horsepower	Reservoir Volume (Gal)	Number of Cartridge Valves	Controller Included?	Wt. (lbs.)
PU311	Manual	Horizontal	2	0.86	1	Y	32

Accessories:

Part No.	Description	Wt. (lbs.)
HBF12P	DC Hydraulic Power Unit's Poly 3/4 Inch Breather Cap	0.04

Power Units

4-WAY DC POWER UNIT - MANUAL CONTROLS

- Pump/motor/reservoir
- Externally adjustable system relief valve
- Tandem center valve condenser equipped for synchronization with pump/motor
- .250" NPTF valve outlet ports
- Complete with suction filter and rod and ball handle
- Horizontal mounting, with 4-way function (power up/power down)



PU310

Part No.	Manual or Push Button	Mounting Position	Motor Horsepower	Reservoir Volume (Gal)	Number of Cartridge Valves	Controller Included?	Wt. (lbs.)
PU310	Manual	Horizontal	2	1.00	1	Y	36.3
PU310LR	Manual	Horizontal	2	2.20	1	Y	46

Accessories:

Part No.	Description	Wt.(lbs.)
HBF12P	DC Hydraulic Power Unit's Poly 3/4 Inch Breather Cap	0.04

3 WAY/4 WAY DC POWER UNIT - MANUAL CONTROLS

- Pump/motor/reservoir
- Externally adjustable system relief valve
- 3-way/4-way valve, banked; 3-way valve has checked cylinder port and .250" NPTF outlet; 4-way valve is tandem center rotary shear type with .250" NPTF outlets
- Valve assembly is fitted with electrical contacts for synchronizing valve with motor
- Complete with suction filter and rod and ball handles
- Horizontal mounted; plow lift and plow angle functions supported



PU5007

Part No.	Manual or Push Button	Mounting Position	Motor Horsepower	Reservoir Volume (Gal)	Number of Cartridge Valves	Controller Included?	Wt. (lbs.)
PU5007	Manual	Horizontal	1.5	0.45	0	No	35

Accessories:

Part No.	Description	Wt.(lbs.)
HBF12P	DC Hydraulic Power Unit's Poly 3/4 Inch Breather Cap	0.04

DC POWER UNIT - NO VALVE

- Pump/motor/reservoir
- Externally adjustable system relief valve (no valve can be added to unit, must use external valve)
- .375" NPTF outlet port
- Suction filter and horizontal mounting
- Includes solenoid and strap
- Pump .130 in.3 / rev 12 Volt D.C.



PU304

Part No.	Manual or Push Button	Mounting Position	Motor Horsepower	Reservoir Volume (Gal)	Number of Cartridge Valves	Controller Included?	Wt. (lbs.)
PU304	Manual	Horizontal	2	1.00	1	No	31
PU304LR	Manual	Horizontal	2	2.20	1	No	41.75

Accessories:

Part No.	Description	Wt.(lbs.)
HBF12P	DC Hydraulic Power Unit's Poly 3/4 Inch Breather Cap	0.04

DC POWER UNIT - PUMP/MOTOR ONLY

- Pump/motor unit only; not a replacement motor/pump will not fit any other units
- Ideal for use with pre-existing reservoir and external valve
- Externally adjustable system relief valve
- .375" NPTF inlet and outlet ports
- .125" NPTF relief valve exhaust port
- Includes solenoid and strap



PU526

Part No.	Mounting Position	Motor Horsepower	Reservoir Volume (Gal)	Number of Cartridge Valves	Controller Included?	Wt. (lbs.)
PU526	Horizontal	2	0.00	1	N	25



Steel Pipe Fittings

- **Typical Applications:** Grease, instrumental and most hydraulic systems
- **Pressure:** Up to 3000 PSI depending on pipe size
- **Sealing Method:** 1-piece tapered pipe, dryseal (NPTF)
- **Vibration Rating:** Fair resistance
- **Material:** Carbon steel – AISI/ SAE 12L14
- **Advantages:** Dryseal pipe threads (NPTF), zinc plate, compact size, broad selection of styles and sizes.
- **Conformance:** Meets SAE specifications

Pipe Size	1/16"	1/8"	1/4"	3/8"	1/2"	3/4"	1"	1-1/4"	1-1/2"	2"
Thread Size	1/16 – 27	1/8 – 27	1/4 – 28	3/8 – 18	1/2 – 14	3/4 – 14	1 – 11½	1-1/4 – 11-1/2	1-1/2 – 11-1/2	2-11-1/2

REDUCER BUSHING



Part No.	① Male Pipe Thread	② Female Pipe Thread
H3109X4X2	1/4"	1/8"
H3109X6X2	3/8"	1/8"
H3109X6X4	3/8"	1/4"
H3109X8X2	1/2"	1/8"
H3109X8X6	1/2"	3/8"
H3109X12X6	3/4"	3/8"
H3109X12X8	3/4"	1/2"
H3109X16X6	1"	3/8"
H3109X20X16	1-1/4"	1"

HEX HEAD PLUG



Part No.	Male Pipe Thread
H3159X2	1/8"
H3159X4	1/4"
H3159X6	3/8"
H3159X8	1/2"
H3159X12	3/4"
H3159X16	1"

HEX SOCKET PLUG



Part No.	Male Pipe Thread
H3169X2	1/8"
H3169X4	1/4"

SQUARE HEAD PLUG



Part No.	Male Pipe Thread
H3179X2	1/8"
H3179X4	1/4"
H3179X8	1/2"
H3179X12	3/4"
H3179X16	1"

HEX NIPPLE



Part No.	① Male Pipe Thread	② Male Pipe Thread
H3069X4	1/4"	1/4"
H3069X16	1"	1"
H3069X20	1-1/4"	1-1/4"

Adapter



Part No.	① Female Pipe Thread	② Male Pipe Thread
H3209X8X6	1/2"	3/8"
H3209X12X8	3/4"	1/2"

STRAIGHT THREAD O-RING ADAPTER



Part No.	① Male Straight Thread	② Female Pipe Thread
H3269X6X4	3/8"	1/4"
H3269X10X6	5/8"	3/8"
H3269X10X8	5/8"	1/2"
H3269X10X12	5/8"	3/4"
H3269X16X16	1"	1"

COUPLING



Part No.	① Female Pipe Thread	② Female Pipe Thread
H3309X2	1/8"	1/8"
H3309X6	3/8"	3/8"
H3309X12	3/4"	3/4"
H3309X16	1"	1"

45° STREET ELBOW



Part No.	① Male Pipe Thread	② Female Pipe Thread
H3359X4	1/4"	1/4"
H3359X16	1"	1"

90° STREET ELBOW

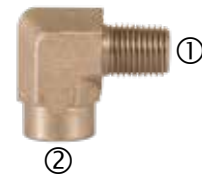

Part No.	① Male Pipe Thread	② Female Pipe Thread
H3409X4	1/4"	1/4"
H3409X6	3/8"	3/8"
H3409X8	1/2"	1/2"
H3409X16	1"	1"
H3409X20	1-1/4"	1-1/4"

90° ELBOW



Part No.	① Female Pipe Thread	② Female Pipe Thread
H3509X16	1"	1"
H3509X20	1-1/4"	1-1/4"

Fittings

45° ELBOW



Part No.	① Female Pipe Thread	② Female Pipe Thread
H3559X12	3/4"	3/4"

MALE BRANCH TEE



Part No.	① Male Pipe Thread	② Female Pipe Thread
H3609X12	3/4"	3/4"

TEE



Part No.	Female Pipe Thread
H3709X16	1"
H3709X20	1-1/4"

MALE RUN TEE



Part No.	① Male Pipe Thread	② Female Pipe Thread
H3759X8	1/2"	1/2"
H3759X16	1"	1"

STRAIGHT THREAD O-RING HEX SOCKET PLUG



Part No.	Port Size
H7238X2	1/8"
H7238X4	1/4"
H7238X8	1/2"
H7238X12	3/4"
H7238X20	1-1/4"

Tube Fittings J.I.C. 37

- **Typical Applications:** Hydraulic, instrumentation and chemical processing systems
- **Pressure:** Up to 10,000 PSI depending on tube size
- **Sealing Method:** 3-piece flare
- **Vibration Rating:** Good resistance
- **Material:** Carbon steel – AISI/ SAE 12L14
- **Used With:** Copper, brass, steel, aluminum and other tubing that can be flared
- **Advantages:** Zinc plate. Broad selection of styles and sizes. Interchangeable with all sources
- **Identifying Characteristics:** Short nut with sleeve protruding. Material is generally steel
- **Conformance:** Meets J.I.C., SAE (J154) Standards

Tube O.D.	1/8"	3/16"	1/4"	5/16"	3/8"	1/2"	5/8"	3/4"
Thread	5/16 – 24	3/8 – 24	7/16" – 20	1/2 – 20	9/16" – 18	3/4 – 16	7/8" – 14	11/16 – 12
Tube O.D.	7/8"	1"	1-1/4"	1-1/2"	2"			
Thread	13/16 – 12	15/16" – 12	1-5/8" – 12	1-7/8 – 12	2 – 1/2-12			

REDUCER



Part No.	Tube Reduction
H5015X6X4	3/8" to 1/4"
H5015X16X12	1" to 3/4"

NUT



Part No.	Tube O.D.
H5105X6	3/8"
H5105X8	1/2"
H5105X10	5/8"
H5105X12	3/4"

CAP



Part No.	Tube O.D.
H5129X6	3/8"

SLEEVE 3-PIECE



Part No.	Tube O.D.
H5165X8	1/2"

MALE CONNECTOR



Part No.	① Tube O.D.	② Pipe Thread
H5205X8	1/2"	3/8"
H5205X8X8	1/2"	1/2"
H5205X8X12	1/2"	3/4"
H5205X12X8	3/4"	1/2"
H5205X12	3/4"	3/4"
H5205X12X16	3/4"	1"
H5205X16	1"	1"

PLUG



Part No.	Tube O.D.
H5229X5	5/16"
H5229X12	3/4"

BULKHEAD UNION



Part No.	Tube O.D.
H5325X6	3/8"
H5325X8	1/2"
H5325X10	5/8"
H5325X12	3/4"



STRAIGHT THREAD O-RING CONNECTOR



Part No.	① Tube O.D.	② Port Size
H5315X4	1/4"	1/4"
H5315X4X6	1/4"	3/8"
H5315X6X4	3/8"	1/4"
H5315X6	3/8"	3/8"
H5315X6X8	3/8"	1/2"
H5315X8	1/2"	1/2"
H5315X8X10	1/2"	5/8"
H5315X8X12	1/2"	3/4"
H5315X10	5/8"	5/8"
H5315X12	3/4"	3/4"
H5315X16	1"	1"

45° MALE ELBOW



Part No.	① Tube O.D.	② Male Pipe Thread
H5355X6	3/8"	1/4"

SWIVEL NUT 45° ELBOW



Part No.	Tube O.D.
H5356X8	1/2"
H5356X12	3/4"

90° MALE ELBOW



Part No.	① Tube O.D.	② Male Pipe Thread
H5405X8X8	1/2"	1/2"

90° UNION ELBOW



Part No.	Tube O.D.
H5505X12	3/4"

SWIVEL NUT 90° ELBOW



Part No.	Tube O.D.
H5506X4	1/4"
H5506X6	3/8"
H5506X8	1/2"
H5506X10	5/8"
H5506X12	3/4"
H5506X16	1"

STRAIGHT THREAD O-RING 90° ELBOW



Part No.	① Tube O.D.	② Port Size
H5515X6	3/8"	3/8"
H5515X6X8	3/8"	1/2"
H5515X10	5/8"	5/8"
H5515X12	3/4"	3/4"

BULKHEAD UNION ELBOW



Part No.	Tube O.D.
H5525X8	1/2"

UNION TEE



Part No.	Tube O.D.
H5705X6	3/8"

SWIVEL NUT RUN TEE



Part No.	Tube O.D.
H5706X8	1/2"

SWIVEL NUT BRANCH TEE



Part No.	Tube O.D.
H5707X8	1/2"

STRAIGHT THREAD O-RING RUN TEE

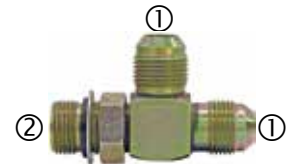

Part No.	① Tube O.D.	② Port Size
H5716X6	3/8"	3/8"

BULKHEAD RUN TEE



Part No.	Tube O.D.
H5726X8	1/2"

BULKHEAD NUT



Part No.	① Tube O.D.
H5924X6	3/8"
H5924X8	1/2"
H5924X10	5/8"
H5924X12	3/4"

90° STRAIGHT THREAD HOSE CONNECTOR



Part No.	① Male SAE Thread	② Hose I.D.
H890X20X16	1"	1 1/4"

Fittings

Swivel Adapters

• **Typical Applications:** Low, medium, & high hydraulic systems.

- **Pressure:** Up to 10,000 PSI depending on size.
- **Sealing Method:** Metal to metal, 30° cone - NPSM thread.
- **Plating:** Zinc, clear dichromate finish.

FEMALE 37° JIC SWIVEL TO MALE PIPE



Part No.	① Tube O.D.	② Male Pipe Thread
H9100X4X4	7/16"	1/4"
H9100X12X12	1-1/16"	3/4"
H9100X16X16	1-5/16"	1"

FEMALE PIPE SWIVEL TO MALE PIPE STRAIGHT



Part No.	① NPSM Swivel Nut	② Male Pipe Thread
H9205X6X4	3/8"	1/4"
H9205X12X8	3/4"	1/2"
H9205X16X16	1"	1"

FEMALE PIPE SWIVEL TO FEMALE PIPE STRAIGHT



Part No.	① NPSM Swivel Nut	② Female Pipe Thread
H9255X16X16	1"	1"

MALE STRAIGHT THREAD TO FEMALE PIPE SWIVEL 90° ELBOW



Part No.	① Straight Thread	② NPSM Swivel Nut
H9515X6X6	9/16-18	3/8-18
H9515X6X8	9/16-18	1/2-14
H9515X12X12	1-1/16-12	3/4-14
H9515X16X16	1-5/16-12	1-11½

FEMALE PIPE SWIVEL TO MALE PIPE 45° ELBOW



Part No.	① NPSM Swivel Nut	② Male Pipe Thread
H9355X4X4	1/4-18	1/4-18

FEMALE PIPE SWIVEL TO FEMALE PIPE 45° ELBOW



Part No.	① Straight Thread	② NPSM Swivel Nut
H9385X8X8	1/2-14	1/2-14
H9385X12X12	3/4-14	3/4-14

FEMALE PIPE SWIVEL TO MALE PIPE BRANCH TEE

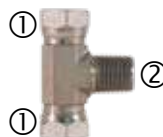

Part No.	① NPSM Swivel Nut	② Male Pipe Thread
H9406X8X8X8	1/2-14	3/4-14

FEMALE PIPE SWIVEL TO MALE PIPE 90° ELBOW



Part No.	① NPSM Swivel Nut	② Male Pipe Thread
H9405X4X4	1/4-18	1/4-18
H9405X6X6	3/8-18	3/8-18
H9405X6X8	3/8-18	1/2-14
H9405X8X12	1/2-14	3/4-14
H9405X12X12	3/4-14	3/4-14
H9405X16X16	1-11½	1-11½

FEMALE PIPE SWIVEL TO FEMALE PIPE 90° ELBOW



Part No.	① NPSM Swivel Nut	② Female Pipe Thread
H9455X24X24	1½-11½	1½-11½

MALE STRAIGHT THREAD TO FEMALE PIPE SWIVEL STRAIGHT



Part No.	① NPSM Swivel Nut	② Female Pipe Thread
H9315X10X8	7/8"	1/2"
H9315X10X12	7/8"	3/4"
H9315X12X12	1-1/16"	3/4"



Pneumatics



Product Shown:
K70DF: Single Lever Air Control Valve
BAV010: Manual Air Valve

Air Control Levers	436 - 438
Air Control Valves	439 - 441
Lift Axle Controls	442

Pneumatic Parts and Accessories	443 - 444
Tailgate Control	445
D.O.T. Air Fittings	446

Air Control Levers

K70 SERIES AIR CONTROL LEVER, SINGLE

- 5-port, 3-position, stackable air control valve with a push button auxiliary function
- Capable of many applications including PTO/Hoist control
- Movement of the handle in either direction allows controlled pressure output to work ports 'A' or 'B' respectively, in a proportional manner, allowing feathering



K70DF



K70C



K70DETCLIP

Part No.	Valve Actuation	Valve Action	Valve Primary Application	Wt. (lbs.)
K70DF	Manual Lever	Feather Down	PTO/Hoist Control	3
K70DFD	Manual Lever	Feather Down/Center Detent	PTO/Hoist Control	3
K70DFNKO	Manual Lever	Feather Down/Non-Disengage on PTO Function	PTO/Hoist Control	3

Accessories:

Part No.	Description	Wt. (lbs.)
K70DETCLIP	Air Valve Detent Clip for K70DF Series Valves	0.02
K70C	Black Steel Console For K70DF Series 3-1/2 (D) x 6-3/4 (W) x 10 (H) Inch	5.61

AIR CONTROL LEVERS: PROPORTIONAL AND FEATHERING **NEW**

- Capable of many applications including operation of hooklift / cable lift hoists, dump bodies, snow plows, cranes, wreckers, and more when paired with air controlled hydraulic system
- Handle movement in any direction allows controlled proportional feathering pressure output to related work ports
- Can operate adjacent functions simultaneously
- Available with push button on/off switch in top of handle for additional functionality



64510000



64510002



K70FDA

Part No.	Style	Operation	Handle	Mounting Style	Wt. (lbs.)
64510000	Dual axis joystick control	Spring return to center	Straight with standard knob	Round mounting plate	4.3
64510002	Dual axis joystick control	Spring return to center	Straight with on/off push button	Round mounting plate	4.3
K70FDA	Dual axis joystick control	Spring return to center	Straight with standard knob	Square mounting plate	8.0



AIR CONTROL LEVERS: PROPORTIONAL, FEATHERING, & STACKABLE **NEW**

- Air control valve available in a variety of handle configurations and includes hardware to stack
- Capable of many applications including operation of hooklift / cable lift hoists, dump bodies, snow plows, cranes, wreckers, and more when paired with air controlled hydraulic system
- Handle movement in either direction allows controlled proportional feathering pressure output to work ports 'A' or 'B' respectively
- Available with LED light or push button on/off switch in top of handle for additional functionality

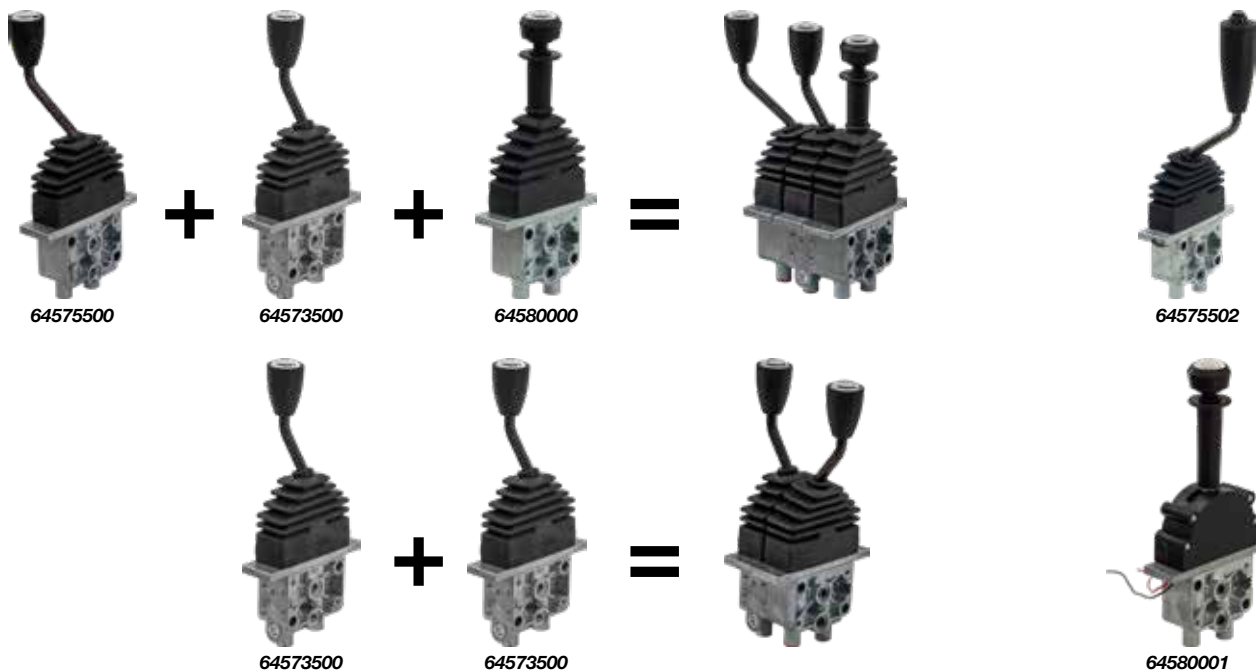

Part No.	Style	Operation	Handle Configuration	Knob Style	Wt. (lbs.)
64570000	Single axis lever control	Spring return to center	Straight	Standard knob	2.17
64573500	Single axis lever control	Spring return to center	35 deg offset	Standard knob	2.15
64573504	Single axis lever control	Spring return to center	35 deg offset	Tall handle	2.45
64575500	Single axis lever control	Spring return to center	55 deg offset	Standard knob	2.00
64575502	Single axis lever control	Spring return to center	55 deg offset	Tall handle with on/off push button	2.10
64580000	Single axis lever control	Neutral locking, Spring return to center	Straight	Standard knob	2.35
64580001	Single axis lever control	Neutral locking, Spring return to center	Straight	LED light in top of handle	2.30
6458000B	Blank spacer section / no handle	—	—	—	1.00

AIR CONTROL RELATED PARTS AND REPAIR COMPONENTS

Part No.	Description
6451000M	Mounting Adaptor Plate For Air Joystick Into 4 Bank Area
6457000B	Single Bank Cover Plate
645700C3	Console For Up To 3 Air Levers
645700H0	Handle Assembly, Straight With Standard Knob (For 64570000 Or 64510000)
645700P3	Pedestal, 3 Bank Top With Base & Offset Arm
645700P5	Pedestal, 5 Bank Top With Base & Offset Arm
645700P7	Pedestal, 7 Bank Top With Base & Offset Arm
645700RB	Rubber Boot
645700RK	Rebuild Kit - Internal O-Rings, Springs, And 2 Square Cut Rubber O-Rings For Between Sections
645700RL	Lens For Top Of Knob
645735H0	Handle Assembly, 35deg Offset With Standard Knob (For 64573500)
645735H4	Handle Assembly, 35deg Offset With Tall Blank Knob (For 64573504)
645755H0	Handle Assembly, 55deg Offset With Standard Knob (For 64575500)
645755H2	Handle Assembly, 55deg Offset With On/Off Push Button Switch (For 64575502)
645800RI	Led Indicator Light (For 64580001)

Air Control Levers

K80 SERIES MULTI-FUNCTION PTO/PUMP VALVE

- For dump trucks, dump trailer, transfer trailer, live floor trailer, asphalt/live bottom trailer, bottom dump, side dump, platform dump, and others
- NOTE: White Sleeve = Feathering / Orange Sleeve = Automatic Disengage
- K80F, K80DF, K85F, K85DF provide full range feathering qualities (valve regulates pressure from 10 to 125 P.S.I.)



K80F



K90C

K90TC

K90TGC

Part No.	Valve Actuation	Valve Action	Valve Primary Application	Wt. (lbs.)
K80	Manual Lever	Non-Feathering/Non-Disengage/Non-Return	PTO/Pump Valve	2.43
K80D	Manual Lever	Non-Feathering/Non-Disengage/Spring Return	PTO/Pump Valve	2.4
K80DF	Manual Lever	Feathering/Non-Disengage/Spring Return	PTO/Pump Valve	2.66
K80F	Manual Lever	Feathisengage/Springing/Non-Disengage/Non-Return	PTO/Pump Valve	2.59
K85DF	Manual Lever	Feathering/Disengage/Spring Return	PTO/Pump Valve	2.7
K85F	Manual Lever	Feathering/Disengage/Non-Return	PTO/Pump Valve	2.63

Accessories:

Part No.	Description	Wt. (lbs.)
K90C	Black Air Control Valve Console For K80/K90 Series 3-1/4 x 4-3/4 x 8 Inch High	2.5
K90TC	Black Air Control Valve Console For K80/K90 Series 3-1/4 x 4-3/4 x 14 Inch High	4.09
K90LC	Black Air Control Valve Console For K80/K90 Series 7-1/8 x 6-1/8 x 14-1/8 Inch High	14
K90TGC	Black Console Only 3-3/8 x 6-3/4 x 14 Inch High - Accepts K80/K90/BAV010	6.2

3-WAY, 2-POSITION AIR LEVER

- 3-way 2-position detent
- Manual air valve used for engaging PTOs
- On/Off action only

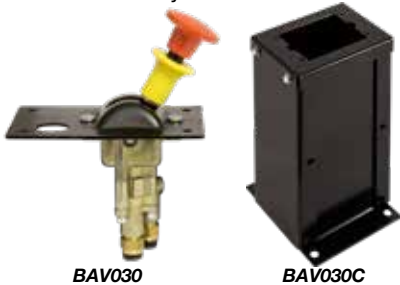

BAV030

BAV030C

Part No.	Valve Actuation	Valve Action	Valve Primary Application	Wt. (lbs.)
BAV030	Manual Lever	On/Off	Engaging PTO	0.92

Accessories:

Part No.	Description	Wt. (lbs.)
BAV030B	3/4 Inch Replacement Amber Bulb For BAV030	0.3125
BAV030C	Black Air Control Valve Console For BAV030 3-5/8 x 4-7/8 x 9 Inch	5.94

K90 SERIES SINGLE LEVER POWER TAKE OFF/HOIST CONTROL VALVE

- Controlled lowering (feathering)
- Automatic disengagement of the PTO in "Lower"
- Note: Dead Man Control - hoist lever returns to neutral position and stops motion when released on K90D only



K90D



K90C

K90TC

K90TGC

Part No.	Valve Actuation	Valve Action	Valve Primary Application	Wt. (lbs.)
K90	Manual Lever	Feathering	PTO/Pump Valve	3.3
K90D	Manual Lever	Feathering	PTO/Pump Valve	3.4

Accessories:

Part No.	Description	Wt. (lbs.)
K90C	Black Air Control Valve Console For K80/K90 Series 3-1/4 x 4-3/4 x 8 Inch High	2.5
K90TC	Black Air Control Valve Console For K80/K90 Series 3-1/4 x 4-3/4 x 14 Inch High	4.09
K90LC	Black Air Control Valve Console For K80/K90 Series 7-1/8 x 6-1/8 x 14-1/8 Inch High	14
K90TGC	Black Console Only 3-3/8 x 6-3/4 x 14 Inch High - Accepts K80/K90/BAV010	6.2



AIR SHIFT CYLINDER

- Converts manual pump operation to pneumatically controlled pump
- Complete with pump activator cylinder and mounting hardware
- Valve, tubing, fitting, and bracket kit are sold separately (K1010TAS)
- Compatible with Commercial C101/C102, Buyers BPC1010, Muncie E Series, Permco DMD25/DM640, Tyrone T101/T102*



AS301



AS302

Part No.	Description	For Use With	Wt. (lbs.)
AS301	Air Shift Cylinder	C1010 dump pumps	1.67
AS302	Air Shift Cylinder with Tubing and Fittings	C1010 dump pumps	2.71

AIR SHIFT CYLINDER

- Converts manual pump operation to pneumatically controlled pump
- Complete with pump activator cylinder and mounting hardware
- Valve, tubing, fitting, and bracket kit are sold separately (K1010TAS)
- Compatible with Buyers® CH101/CH102, Parker® G101G102



BASK16

Part No.	Description	For Use With	Wt. (lbs.)
BASK16	Air Shift Cylinder	CH101/CH102 Series Dump Pumps	1.43

AIR SHIFT CYLINDER FOR HYDRAULIC PUMP

- Converts manual pump operation to pneumatically controlled pump
- Complete with pump activator cylinder and mounting hardware
- Valve, tubing, fitting, and bracket kit are sold separately (K1010TAS)
- Compatible with Permco® DM300/DM400



BASK16P

Part No.	Description	For Use With	Wt. (lbs.)
BASK16P	Air Shift Cylinder	Permco® DM300/DM400 Series Pumps	1.38

AIR SHIFT CYLINDER

- Converts Buyers Products HSV075 and HSV100 Selector Valve from manual to air operation
- Ideal for dump trucks with pup trailers



HSV1C

Part No.	Description	For Use With	Wt. (lbs.)
HSV1C	Air Shift Cylinder	Buyers Products HSV075 and HSV100 Selector Valve	1.38

Air Control Valves

4-WAY, 3-POSITION AIR VALVE KIT

- Spring return to neutral with center locking detent
- Kits include Brass push lock fittings and 25ft of 1/4in diameter tubing
- Available in both Non-feathering and feathering functionality



K1010AS



K1010FAS

Part No.	Valve Actuation	Valve Action	Valve Primary Application	Wt. (lbs.)
K1010AS	Manual Lever	Non-Feathering	Neutral Locking Control Kit	2.4
BAV040	Manual Lever	Non-Feathering	Neutral Locking Control Only	2.4
K1010FAS	Manual Lever	Feathering	Neutral Locking Control Kit	2.4
K1010FAS1	Manual Lever	Feathering	Neutral Locking Control Only	2.4

Accessories:

Part No.	Description	Wt.(lbs.)
K1010C	Black Air Control Valve Console For K1010C 3-5/8 x 4-7/8 x 9 Inch	5.94

LEVER ACTUATED AIR CONTROL VALVE

- 2-3/4 in. tall lever (5-7/16 in. tall overall) makes for ease of operation
- The stackable valve sections bolt together to conserve space
- Comes with a 1-year warranty



BAV021T

Part No.	Valve Actuation	Valve Action	Valve Primary Application	Wt. (lbs.)
BAV021T	Toggle 3 Position	Neutral Lockout	Dump Truck Controls	1.03

TOGGLE ACTUATED AIR CONTROL VALVE

- 3 position toggle available in Spring return to center or 3 position detented configurations
- 1-1/8 in. long toggle lever
- 3-1/16 in. tall overall
- 3/4 in. Diameter threaded mounting stem with 2 nuts
- Kits include Brass push lock fittings, 25' x 1/4" diameter nylon D.O.T. approved tubing, Console adapter plate, and Stainless steel finger guard



K1010TAS



BAV020TD

Part No.	Valve Actuation	Valve Action	Valve Primary Application	Wt. (lbs.)
BAV020T	Manual Toggle	Limited Feathering	Sprint Return to Neutral	0.43
BAV020TD	Manual Toggle	Limited Feathering	3 Position Detented	0.43
K1010TAS	Manual Toggle Kit	Limited Feathering	Spring Return to Neutral	1.26

Accessories:

Part No.	Description	Wt.(lbs.)
BAV020FG	Air Valve Finger Guard	0.06
AC010AP	Air Valve Mounting Plate, 3-9/16 x 3-3/8	0.18



4-WAY, 3-POSITION AIR VALVE

- Detent spool allows for adjusting linkage without shutting off air pressure
- Center position blocks air at valve while opening both cylinder ports to atmosphere
- Requires 5/8 in. diameter hole for mounting
- (5) 1/4 in. NPT ports
- Black anodized aluminum



BAV015

Part No.	Valve Actuation	Depth (in.)	Width (in.)	Height (in.)	Valve Action	Valve Primary Application	Wt. (lbs.)
BAV015	Manual Push/Pull	1-1/2	1	5	4-Way, 3 Position	Air Tailgate Valve	0.67
BAV020	Manual Push/Pull	1-5/16	1	6-1/8	4-Way, 3 Position	Air Tailgate Valve	1.86

4-WAY, 2-POSITION AIR VALVE

- Panel mounted valve is ideal for operating double acting cylinders
- Black anodized aluminum
- Requires 1/2 in. diameter hole for mounting
- (5) 1/8 in. NPT ports
- Includes tailgate control faceplate



BAV010

Part No.	Valve Actuation	Depth (in.)	Width (in.)	Height (in.)	Valve Action	Valve Primary Application	Wt. (lbs.)
BAV010	Manual Push/Pull	1-3/8	13/16	4	4-Way, 2 Position	Air Tailgate Valve	0.5

4-WAY, 2-POSITION TOGGLE STYLE AIR VALVE

- Each valve has five 1/8 in. NPT ports
- 4-Way, 2-Position Air Valve rated for 150 PSI
- Valve is commonly used with lift axle applications



6451030

Part No.	Valve Actuation	Valve Action	Valve Primary Application	Wt. (lbs.)
6451030	Manual Toggle	4-Way, 2 Position	Toggle Air Valve	0.338

UNIVERSAL 3-WAY TOGGLE VALVE

- Toggle air valve comes with three 1/8 in. NPT Ports
- Valve is rated for uses up to 174 PSI
- Includes "on/off" face plate for operating use



6451000

Part No.	Valve Actuation	Valve Action	Valve Primary Application	Wt. (lbs.)
6451000	Manual Toggle	3-Way, 2 Position	On/Off Toggle	0.3

Lift Axle Controls

LIFT AXLE CONTROL ASSEMBLY WITH TOGGLE AIR VALVE

- In-cab controls for air suspension and lift axle
- Pre-plumbed and assembled
- Fittings/DOT tubing and mounting plate included
- 7.25"L x 3.75"T steel mounting plate is pre-drilled & powder coated
- Single acting unit
- Individual components available



6451051

Part No.	Valve Actuation	Valve Action	Valve Primary Application	Wt. (lbs.)
6451051	Manual Toggle	Single Acting	Raise/Lower Lift Axle	2.43

LIFT AXLE CONTROL ASSEMBLY WITH PUSH-PULL AIR VALVE

- In-cab controls for air suspension and lift axle
- Pre-plumbed and assembled
- Fittings/DOT tubing and mounting plate included
- 7.25"L x 3.75"T steel mounting plate is pre-drilled & powder coated
- Unit available in single or double acting; individual components also available



6451055

Part No.	Valve Actuation	Valve Action	Valve Primary Application	Wt. (lbs.)
6451050	Manual Push/Pull	Single Acting	Raise/Lower Lift Axle	2.4
6451055	Manual Push/Pull	Double Acting	Raise/Lower Lift Axle	2.89

Pneumatic Parts and Accessories

NPT BREATHER VENT

- Max pressure: 150 PSI
- Max temperature: 300 F
- 40 microns



BAV02002

Part No.	Side 1	Shape	Style	Material	Finish	Wt. (lbs.)
BAV01502	1/8 NPTF	Hex Head	M	Brass	Plain	0.02
BAV02002	1/4 NPT	Hex Head	M	Carbon Steel	Zinc Plated	0.02

UNIVERSAL AIR DRAIN VALVE

- Automatic, self-closing unit
- 5' vinyl-coated cable
- Uncrimped end for adjustable length (clip included)
- 1/4" NPTF male thread



6451010

Part No.	Valve Actuation	Valve Action	Valve Primary Application	Wt. (lbs.)
6451010	Pressure	Open/Close	Air Drain Valve	0.24



4-WAY, 2-POSITION SOLENOID AIR VALVE

- (5) 1/4 in. NPT ports
- Rugged 12 VDC coil comes complete with 2 ft flying leads
- Can be easily converted to 3-way operation by installing 2 pipe plug



BAV050SA

Part No.	Valve Actuation	Depth (in.)	Width (in.)	Height (in.)	Valve Action	Valve Primary Application	Wt. (lbs.)
BAV050SA	12 VDC	1-3/8	1	4-3/4	4-Way, 2 Position	Solenoid Tailgate Valve	0.57

Accessories:

Part No.	Description	Wt. (lbs.)
BSW050	Push-Pull Switch For BAV050SA	0.2

PRESSURE PROTECTION AIR VALVE

- 1/4" NPT ports
- 70 PSI closing



6451005

Part No.	Material	Valve Action	Valve Primary Application	Wt. (lbs.)
6451005	Plated Steel	Open/Close	Pressure Protection	0.53
6451040	Aluminum	Open/Close	Pressure Protection	0.30

PRESSURE GAUGE

- 2" dial
- 0-160 PSI
- 1/8" NPT male
- 12 VDC backlit gauge



6451035

Part No.	Description	Wt. (lbs.)
6451035	Pressure Gauge	0.23

PRESSURE REGULATOR

- Relieving type regulator has a locking knob and is rated to maximum 300 PSI inlet pressure
- Each regulator includes two 1/8 in. NPTF work ports, two 1/8 in. gauge ports, and two plugs
- Rated for maximum inlet pressure of 300 PSI with a regulating range of 2-160 PSI



6451025

Part No.	Valve Actuation	Valve Action	Valve Primary Application	Wt. (lbs.)
6451025	Manual	Regulator	Pressure Regulator	0.4

Pneumatic Parts and Accessories

AIR PTO/AIR HOIST CONSOLE

- Black powder-coat steel console
- Top panel punched and lettered for mounting a CHELSEA type PTO air valve and a WILLIAMS type hoist air valve
- 5/8" diameter capped hole for air tailgate switch or PTO light is standard



AC010M

Part No.	Depth	Height	Width	Works With	Wt. (lbs.)
AC010	6.125	14.125	7.000	Chelea Type PTO Air Valve & A Williams Type Hoist Air Valve	12
AC010M	6.125	14.125	7.000	Muncie Type PTO Air Valve & A Williams Type Hoist Air Valve	12
SAC010M	6.125	6.500	7.000	Muncie Type PTO Air Valve & A Williams Type Hoist Air Valve	6

FILTER/REGULATOR/LUBRICATOR

- Compact design
- Metal bowls with sight glass and quick detach
- Die cast, modular design with built-in mounts
- Manual moisture drain; replaceable filter; lubricator can be unbolted
- 50-150 PSI gauge included
- 41° F - 140° F temperature range



FRL14150



FRL12150

Part No.	Description	NPT (in.)	Max PSI	Wt. (lbs.)
FRL14150	Filter/Regulator/Lubricator	1/4	150	1.75
FRL12150	Filter/Regulator/Lubricator	1/2	150	5.3

HOSE REEL

- Black powder-coat finish
- Dual pedestal base & formed support arms
- Full flow steel axle, 90° balanced pressure, sealed brass swivel joint
- Declutching gear protects spring from reverse winding
- Four direction, anti-snap roller guide
- Durable, black exterior grade hose with crimped fitting rated for 300 PSI air/water (maximum hose temperature 210° F/100° C)



HR1250

Part No.	Hose Inside Diameter	Maximum Temperature	Hose Length	Maximum Pressure	Wt. (lbs.)
HR1250	0.500	210	50	300	58.5

Accessories:

Part No.	Description	Wt. (lbs.)
3028095	50 Foot Rubber Hose - 3/8 Inch Diameter (Works with Hose Reel #HR3850)	9.19
3028096	50 Foot Rubber Hose - 1/2 Inch Diameter (Works with Hose Reel #HR1250)	14.9



TAILGATE CYLINDERS

- Extruded aluminum body
- 5/8in-18 threaded piston rod can be used with a variety of ends and is threaded for 1-1/2in for adjustment
- Retracted lengths are center to center dimensions that include a B27087C adjustable yoke on all configurations except cylinder only where it is measured as center of pivot to end of rod
- 1/4 NPT port threads
- Integrated Pillow valves (prevents piston from slamming when fully open or closed)
- Available in 1/2in clevis style (V) or hinge style (HM) base end mounting
- Available in a variety of kit and control configurations designated by the part number suffix

CYLINDER ONLY



TGC25006C

CYLINDER KITS



TGC32506V



TGC32506HM

CYLINDER AND VALVE KITS



TGC32506VK



TGC32506HMK

CYLINDER AND ELECTRICAL OPERATED VALVE KITS



TGC32506VKSA



TGC32506HMSKA

CYLINDER AND VALVE KITS WITH TUBING AND FITTINGS



TGC25006VSPK



Part No.	Mount	Stroke	Bore	Retracted Length (in.)	Rod Dia (in.)	Control	Wt. (lbs.)
C kits include cylinder only with a removable base mounted clevis							
TGC25006C	Clevis	6	2.5	13-1/4	3/4	None	5.5
TGC25008C	Clevis	8	2.5	15-1/4	3/4	None	6.2
TGC32506C	Clevis	6	3.25	15-1/4	1	None	9.5
TGC23508C	Clevis	8	3.25	17-1/4	1	None	10.2
V and HM kits include cylinder and related hardware, including B27087C adjustable yoke for piston rod, jam nut, and clevis pins							
TGC25006V	Clevis	6	2.5	Min 13-3/4 to Max 14-3/4	3/4	None	6.1
TGC25006HM	Hinge	6	2.5	Min 13-3/4 to Max 14-3/4	3/4	None	9.5
TGC25008V	Clevis	8	2.5	Min 15-3/4 to Max 16-3/4	3/4	None	6.7
TGC25008HM	Hinge	8	2.5	Min 15-3/4 to Max 16-3/4	3/4	None	10.2
TGC32506V	Clevis	6	3.25	Min 15-3/4 to Max 16-3/4	1	None	10.1
TGC32506HM	Hinge	6	3.25	Min 15-3/4 to Max 16-3/4	1	None	13.6
TGC32508V	Clevis	8	3.25	Min 17-3/4 to Max 18-3/4	1	None	10.8
TGC32508HM	Hinge	8	3.25	Min 17-3/4 to Max 18-3/4	1	None	14.3
VK and HMK kits include cylinder, hardware, and BAV010 manual push / pull valve							
TGC25006VK	Clevis	6	2.5	Min 13-3/4 to Max 14-3/4	3/4	BAV010	6.6
TGC25006HMK	Hinge	6	2.5	Min 13-3/4 to Max 14-3/4	3/4	BAV010	10
TGC25008VK	Clevis	8	2.5	Min 15-3/4 to Max 16-3/4	3/4	BAV010	7.3
TGC25008HMK	Hinge	8	2.5	Min 15-3/4 to Max 16-3/4	3/4	BAV010	10.7
TGC32506VK	Clevis	6	3.25	Min 15-3/4 to Max 16-3/4	1	BAV010	10.6
TGC32506HMK	Hinge	6	3.25	Min 15-3/4 to Max 16-3/4	1	BAV010	14.1
TGC32508VK	Clevis	8	3.25	Min 17-3/4 to Max 18-3/4	1	BAV010	11.3
TGC32508HMK	Hinge	8	3.25	Min 17-3/4 to Max 18-3/4	1	BAV010	14.8
VKSA or HMKSA kits include cylinder, hardware, BAV050SA electric operated valve installed on cylinder, BSW050 push/pull electric switch, and 100ft of 1/4in tubing							
TGC25006VKSA	Clevis	6	2.5	Min 13-3/4 to Max 14-3/4	3/4	BAV050SA	7.2
TGC25006HMKSA	Hinge	6	2.5	Min 13-3/4 to Max 14-3/4	3/4	BAV050SA	10.6
TGC25008VKSA	Clevis	8	2.5	Min 15-3/4 to Max 16-3/4	3/4	BAV050SA	7.9
TGC25008HMKSA	Hinge	8	2.5	Min 15-3/4 to Max 16-3/4	3/4	BAV050SA	11.3
TGC32506VKSA	Clevis	6	3.25	Min 15-3/4 to Max 16-3/4	1	BAV050SA	11.2
TGC32506HMKSA	Hinge	6	3.25	Min 15-3/4 to Max 16-3/4	1	BAV050SA	14.7
TGC32508VKSA	Clevis	8	3.25	Min 17-3/4 to Max 18-3/4	1	BAV050SA	11.9
TGC32508HMKSA	Hinge	8	3.25	Min 17-3/4 to Max 18-3/4	1	BAV050SA	15.4
VSPK kits include cylinder, hardware, BAV020 manual push / pull valve, 75ft of 1/4in tubing, and 7 push to connect fittings							
TGC25006VSPK	Clevis	6	2.5	Min 13-3/4 to Max 14-3/4	3/4	BAV020	10.0
TGC25008VSPK	Clevis	8	2.5	Min 15-3/4 to Max 16-3/4	3/4	BAV020	10.7
TGC32506VSPK	Clevis	6	3.25	Min 15-3/4 to Max 16-3/4	1	BAV020	14.0
TGC32508VSPK	Clevis	8	3.25	Min 17-3/4 to Max 18-3/4	1	BAV020	14.7

D.O.T. Air Fittings

BRASS/POLY D.O.T. PUSH-IN AIR FITTINGS

- Brass/Poly construction
- Meet D.O.T. FMVSS 571.106 air brake performance specifications

MALE CONNECTOR



Part No.	Tube O.D.	Pipe Thread
BC00M25P125	1/4"	1/8"
BC00M25P25	1/4"	1/4"
BC00M375P25	3/8"	1/4"
BC00M375P375	3/8"	3/8"

MALE CONNECTOR



Part No.	Tube O.D.	Pipe Thread
NC00M25P125	1/4"	1/8"
NC00M25P25	1/4"	1/4"
NC00M375P25	3/8"	1/4"
NC00M375P375	3/8"	3/8"

UNION CONNECTOR



Part No.	Tube O.D.
BUC0P25	1/4"
BUC0P375	3/8"

UNION CONNECTOR



Part No.	Tube O.D.
NUC0P25	1/4"
NUC0P375	3/8"
NUC0P500	1/2"
NUC0P625	5/8"
NUC0P750	3/4"

MALE ELBOW



Part No.	Tube O.D.	Pipe Thread
BE90M25P125	1/4"	1/8"
BE90M25P25	1/4"	1/4"
BE90M375P25	3/8"	1/4"

SWIVEL MALE ELBOW



Part No.	Tube O.D.	Pipe Thread
BE90M25P125S	1/4"	1/8"
BE90M25P25S	1/4"	1/4"
BE90M375P25S	3/8"	1/4"
BE90M375P375S	3/8"	3/8"

SWIVEL MALE ELBOW



Part No.	Tube O.D.	Pipe Thread
NE90M25P125S	1/4"	1/8"
NE90M25P25S	1/4"	1/4"
NE90M375P25S	3/8"	1/4"
NE90M375P375S	3/8"	3/8"

UNION ELBOW



Part No.	Tube O.D.
NUE90P25	1/4"
NUE90P375	3/8"

SWIVEL MALE BRANCH TEE



Part No.	Tube O.D.	Pipe Thread
BBT0M25P125S	1/4"	1/8"
BBT0M25P25S	1/4"	1/4"

SWIVEL MALE BRANCH TEE



Part No.	Tube O.D.	Pipe Thread
NBT0M25P125S	1/4"	1/8"
NBT0M25P25S	1/4"	1/4"

MALE RUN TEE



Part No.	Tube O.D.	Pipe Thread
BRT0M25P125	1/4"	1/8"

SWIVEL MALE RUN TEE



Part No.	Tube O.D.	Pipe Thread
BRT0M25P125S	1/4"	1/8"

SWIVEL MALE RUN TEE



Part No.	Tube O.D.	Pipe Thread
NRT0M25P125S	1/4"	1/8"

UNION TEE



Part No.	Tube O.D.
BUT0P25	1/4"
BUT0P375	3/8"

UNION TEE



Part No.	Tube O.D.
NUT0P25	1/4"
NUT0P375	3/8"

DOT NYLON AIR TUBING

- Made of durable nylon for flexibility and performance



Part No.	Color	Length (ft.)	Tube O.D. (in.)	Wt. (lbs.)
NT04100	Black	100	0.250	1.71
NT04250	Black	250	0.250	3.53
NT06100	Black	100	0.375	3.19
NT06500	Black	500	0.375	15.5
NT08100	Black	100	0.500	5.75
NT08500	Black	500	0.500	22.25
NTB06100	Blue	100	0.375	3.19



Cables & Controls



Remote Valve Control Systems	448 - 449
Push Pull Shift Systems	450 - 451
Control Cables	452 - 457
Pump and PTO Connection Kits	458 - 459

Knobs and Hardware	460 - 461
Ball Joints & Rod End Bearings	462 - 463
Rod Ends and Yoke Ends	464 - 467
Nylon Cable Ties	468

Remote Valve Control Systems

SINGLE-AXIS REMOTE VALVE CONTROL

- Weatherproof zinc diecast control
- Units can be mounted singly or stacked for multi-spool valves
- Can be mounted on interior or exterior of vehicle
- Valve lever has "momentary" spring to center action
- 9/16" stroke each way from center neutral position

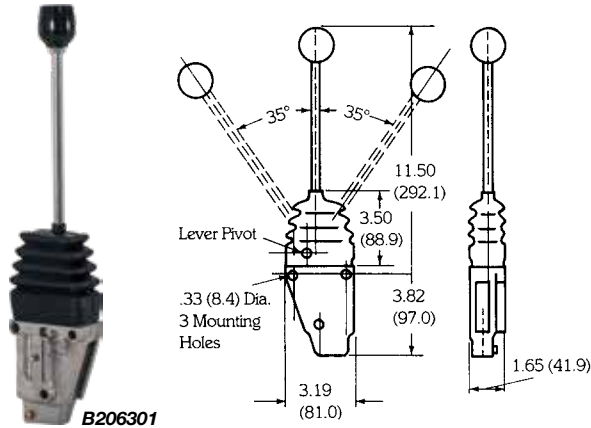

Part No.	Description	Wt. (lbs.)
B206301	Single Axis Remote Valve Control	2.95

Accessories:

Part No.	Description	Wt. (lbs.)
B206301RO	Rubber Boot Cover for B206301	0.48
VSK001	Knob, for B206301, 3/8in-24 Thd	0.13

SINGLE-AXIS REMOTE VALVE CONTROL WITH 70° HANDLE

- Center locking or non-locking
- 70° handle with composite pivot, can be reconfigured for a straight handle
- For use with RVC "B302845" series cables
- Rear cable connection eliminates the need to bend cables
- Units can be mounted singly or stacked for multi-spool valves
- Knobs accept stick-on function label (VSK040)
- 9/16" stroke



B206401 shown with brackets

Part No.	Description	Wt. (lbs.)
B206401	Single Axis Remote Valve Control, Non-locking, Composite, 70° Offset Handle	1.06
B206401001	Single Axis Remote Valve Control, Center-locking, Composite, 70° Offset Handle	1.20

Accessories:

Part No.	Description	Wt. (lbs.)
3014204	Mounting Brackets	0.48
3014332	Mounting Hardware, Single (2-1/2" Bolts)	0.13

SINGLE-AXIS REMOTE VALVE CONTROL WITH DETENT

- Added safety feature of detents
- Weatherproof zinc diecast control
- Can be mounted on interior or exterior of vehicle
- Units can be mounted singly or stacked for multi-spool valves
- 9/16" stroke each way from center neutral position

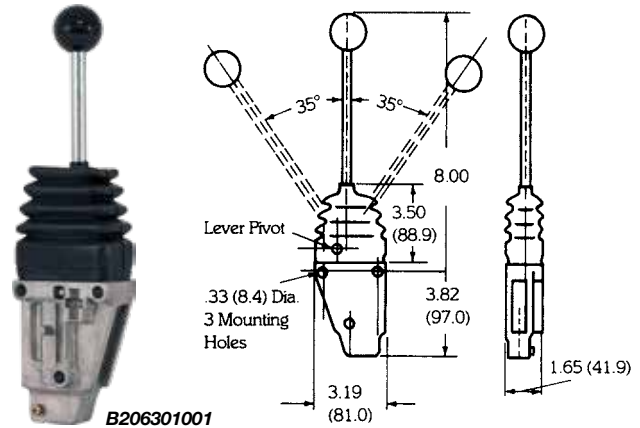

Part No.	Description	Wt. (lbs.)
B206301001	Single Axis Remote Valve Control with Center Detent	2.5

B206301002	Single Axis Remote Valve with End Detents	2.5
-------------------	---	-----

DUAL-AXIS REMOTE VALVE CONTROL

- Dual axis controls are used to control two valves simultaneously
- 9/16" stroke

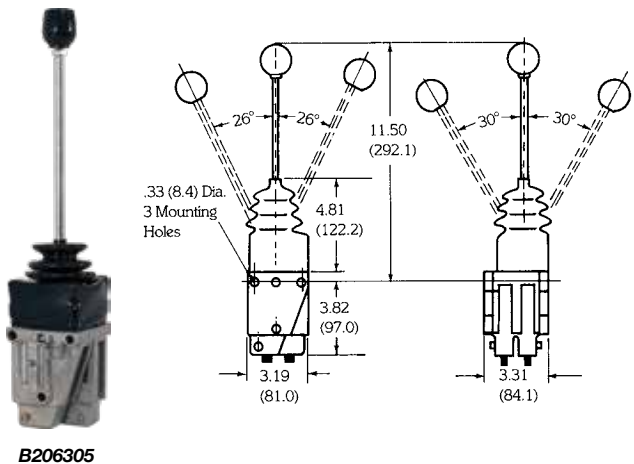

Part No.	Description	Wt. (lbs.)
B206305	Dual Axis Remote Valve Control	4.44

REMOTE VALVE CONTROL CABLES

- 1.5 in. travel
- Durable stainless steel core
- Available in a variety of lengths

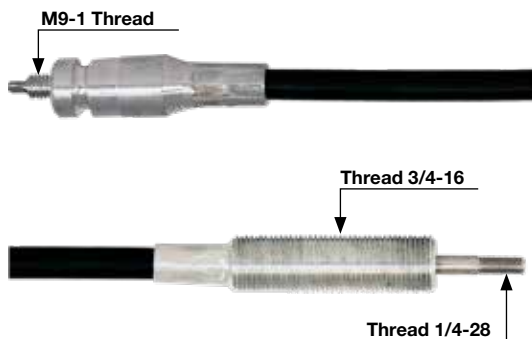

Part No.	Cable Length (in.)	Wt. (lbs.)
B302845048	48	1.31
B302845060	60	1.41
B302845072	72	2.23
B302845084	84	2.44
B302845096	96	2.00
B302845108	108	2.07
B302845120	120	2.44
B302845132	132	2.44
B302845144	144	2.93
B302845168	168	3.25
B302845180	180	3.38

REMOTE VALVE CABLE CONTROL CONNECTION KITS

- Works with any Remote Valve Control B206 Series Controller
- Connects cable directly to valve section and spool



B303032

Part No.	Section Connection	Spool Connection	Works With Valve Brand	Works With Valve Model	Wt. (lbs.)
B302889	2 bolt adjustable pattern, 1/4-20 x 1.25	1/4in wide rod end with 1/4in pin & 1/2in wide clevis with 5/16in pin	Parker/Racine	VDP12/ML25 1/2"	0.75
B302889M	2 bolt adjustable pattern, 1/4-20 x 1.25 & 2	1/4in wide rod end with 1/4in pin & 1/2in wide clevis with 5/16in pin	Gresen	V31	0.75
B302890	2 bolt adjustable pattern, 1/4-20 x 1.25	1/2in wide clevis with 3/16in pin	Buyers/Cross	BA,BC,CA,CD	0.75
B303032	2 bolt adjustable pattern, 1/4-20 x 1.25	1/4in wide rod end with 1/4in pin	Gresen/Energy	"25P,CP,CS,V20,V42, CV50,CVP,CVA,200"	0.75
B303034	2 bolt adjustable pattern, 1/4-20 x 1.25	7/16in wide clevis with 3/8in pin	Rexroth	30-S2 MP18	0.75
B303035	2 bolt pattern, 1/4-28 x 1	12mm wide clevis with 7mm pin	Buyers/Cross	20-30 GPM Sectional	0.75
B303418F	2 bolt pattern, 1/4-20 x 1	7/16in wide clevis with 3/8in pin	Commercial	A20 Front Entry	0.75
B303418R	2 bolt pattern, 1/4-20 x 1.25	3/8-16 threaded stud	Commercial	A20 Rear Entry	0.75
BV303035	4 bolt rect pattern 25.5mm x 28.5mm	18mm wide clevis with 9mm pin	Buyers	BV20 Series	0.3
BV303036	4 bolt rect pattern 34mm x 34mm	18mm wide clevis with 10mm pin	Buyers	BV40 Series	0.4

REMOTE VALVE CONTROL MOUNTING SYSTEMS

- Consoles are 13 gauge steel
- Black powder-coat finish for corrosion resistance
- Console includes all required fasteners

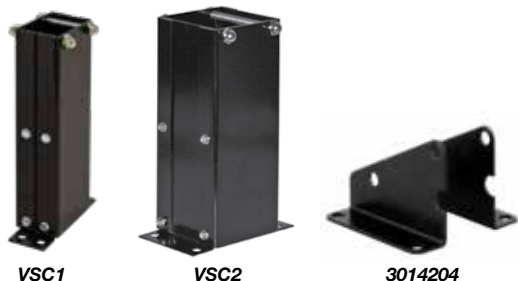

VSC1

VSC2

3014204

Part No.	Description	Maximum Number of Controls	Wt. (lbs.)
VSC1	Single Lever Console (9" H x 1-3/4" W)	1	3.20
VSC2	Dual Lever Console (9" H x 3-3/8" W)	2	4.25
VSC3	Triple Lever Console (9" H x 4-15/16" W)	3	6.07
VSC4	Quad Lever Console (9" H x 6-9/16" W)	4	6.00
3014204	Mounting Brackets for Single Axis RVC B206401/B206401001	-	0.48
3014332	Mounting Hardware for 1 Lever Control (2 studs & 4 nuts)	1	0.13
3014333	Mounting Hardware for 2 Lever Controls (2 studs & 4 nuts)	2	0.18

Push Pull Shift Systems

B SERIES LEVER CONTROLS

- Button operated safety detents for use with all 3" travel clamp type push pull cables
- Standard twin lamp illumination
- Durable zinc alloy construction for corrosion resistance
- Hoist, single lever center detent
- **NOTE: Levers and consoles sold separately**



Part No.	Works with Cable Type	Works with Cable Thread Size	Detent Type	Cable Travel (in.)	Air PTO	Backlight	Wt. (lbs.)
BSSPU52	5200 Series	1/4-28	Center	3	No	Yes	3.85
BSSPU62	6200 Series	5/16-24	Center	3	No	Yes	3.85
BDS52	5200 Series	1/4-28	Multiple	3	No	Yes	7.5
BDS62	6200 Series	5/16-24	Multiple	3	No	Yes	7.5
BA52	5200 Series	1/4-28	Center	3	Yes	Yes	4.66
BA62	6200 Series	5/16-24	Center	3	Yes	Yes	4.5
BTA52	5200 Series	1/4-28	Center	3	Yes	Yes	8.18
BTA62	6200 Series	5/16-24	Center	3	Yes	Yes	8.5
3XBSSPU52	5200 Series	1/4-28	Center	3	No	Yes	11.19

Accessories:

Part No.	Description	Wt. (lbs.)
3001081	B Series Lever Hoist Assembly	1.75

CONSOLES FOR B SERIES LEVERS

- Black powder-coated finish for corrosion resistance
- **NOTE: Levers and consoles sold separately**



Part No.	Description	Wt. (lbs.)
BTS	Black Powder Coated Steel Console For All B-Series Single Lever Control	7.60
BTD	Black Powder Coated Steel Console For All B-Series Dual Lever Controls (or single lever controls with air PTO switch mount)	11.68
BTT	Black Powder Coated Steel Console For All B-Series Triple Lever Controls (or dual lever controls with air PTO switch mount)	14.36



HEAVY DUTY CABLE CONTROL

- Zinc plated steel construction for corrosion resistance
- 4-position forged handle provides mounting flexibility
- Adjustable lever stop limits travel to prevent stress at output end of cable
- An ideal replacement for solid rod installations



HDCL362

Part No.	Works with Cable Type	Works with Cable Thread Size	Detent Type	Cable Travel (in.)	Air PTO	Wt. (lbs.)
HDCL352	5200 Series	1/4-28	None	3	No	4
HDCL362	6200 Series	5/16-24	None	3	No	3.9

SHIFT CONTROL CABLE CONNECTION KIT

- For both B-Series and Q-Series controls



BQ52105

Part No.	Description	Material	Finish	Color	Wt. (lbs.)
BQ52105	For use w/ 1/4 - 28 THD cables	Carbon Steel	Zinc Plated	None	0.1
BQ62106	For use w/ 5/16 - 24 THD cables	Carbon Steel	Zinc Plated	None	0.1

BLANK CONSOLES

- Made of 13 gauge steel
- Black powder-coated finish for corrosion resistance
- Includes all required fasteners



AC010B



BC12914



ACC01

Part No.	Description	Wt. (lbs.)
AC010B	Blank Console (14-1/8" H x 7" W x 6-1/8" D)	13.58
SAC010B	Blank Console (6-1/2" H x 7" W x 6-1/8" D)	6.00
BC12914	Blank Console (14" H x 12" W x 9" D)	23.95
AC010B3	Blank Top for AC010B or SAC010B	1.46
ACC01	Side Mount Accessory Plate	0.50

Control Cables

PUSH-PULL CABLES

5200 SERIES CONTROL CABLES

- Stocked 4 ft. – 20 ft. lengths
- BBU models include bulkhead nuts and washers
- CCU models for use with cable clamps
- 40 lb. - 100 lb load range
- 8 in. minimum bend radius

Length in inches is determined by measuring overall length from one end of rod to the other end of rod.

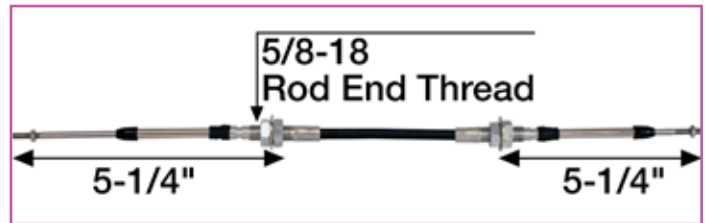
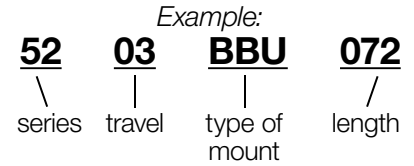

Part No.	Cable Length (in.)	Total Travel (in.)	Cable Diameter (in.)	Conduit Diameter (in.)	End Type	Rod End Thread Size	Wt. (lbs.)
BBU SERIES - Includes bulkhead nuts and washers							
5203BBU048	48	3	0.125	.41	Rod	1/4-28	1.75
5203BBU060	60	3	0.125	.41	Rod	1/4-28	2
5203BBU072	72	3	0.125	.41	Rod	1/4-28	2.35
5204BBU072	72	4	0.125	0.41	Rod	1/4-28	2.23
5203BBU084	84	3	0.125	.41	Rod	1/4-28	2.25
5204BBU096	96	4	0.125	0.41	Rod	1/4-28	2.63
5203BBU096	96	3	0.125	.41	Rod	1/4-28	2.44
5203BBU108	108	3	0.125	.41	Rod	1/4-28	2.69
5203BBU120	120	3	0.125	.41	Rod	1/4-28	3.1
5203BBU132	132	3	0.125	.41	Rod	1/4-28	3
5203BBU144	144	3	0.125	.41	Rod	1/4-28	3.13
5203BBU156	156	3	0.125	.41	Rod	1/4-28	3.25
5203BBU168	168	3	0.125	.41	Rod	1/4-28	3.56
5203BBU192	192	3	0.125	.41	Rod	1/4-28	4
5203BBU228	228	3	0.125	.41	Rod	1/4-28	5.81
5203BBU240	240	3	0.125	.41	Rod	1/4-28	4.31
CCU SERIES - for use with cable clamps							
5203CCU048	48	3	0.125	.41	Rod	1/4-28	1.56
5203CCU060	60	3	0.125	.41	Rod	1/4-28	1.75
5203CCU072	72	3	0.125	.41	Rod	1/4-28	2
5203CCU084	84	3	0.125	.41	Rod	1/4-28	2.07
5203CCU096	96	3	0.125	.41	Rod	1/4-28	2.25
5203CCU108	108	3	0.125	.41	Rod	1/4-28	2.5
5203CCU120	120	3	0.125	.41	Rod	1/4-28	2.56
5203CCU132	132	3	0.125	.41	Rod	1/4-28	2.75
5203CCU144	144	3	0.125	.41	Rod	1/4-28	2.94



PUSH-PULL CABLES - continued

6200 SERIES CONTROL CABLES

- Stocked 4 ft. – 20 ft. lengths in 12 in increments
- BBU models include bulkhead nuts and washers
- CCU models for use with cable clamps
- 110 lb. - 200 lb load range
- 10 in. minimum bend radius

Length in inches is determined by measuring overall length from one end of rod to the other end of rod.

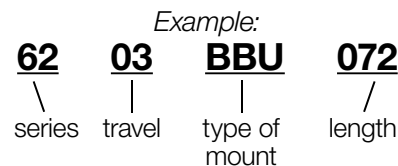

6203BBU

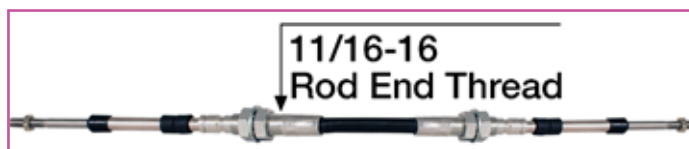

Part No.	Cable Length (in.)	Total Travel (in.)	Cable Diameter (in.)	Conduit Diameter (in.)	End Type	Rod End Thread Size	Wt. (lbs.)
BBU SERIES - Includes bulkhead nuts and washers							
6203BBU048	48	3	0.188	.51	Rod	5/16-24	2.22
6203BBU060	60	3	0.188	.51	Rod	5/16-24	2.5
6203BBU072	72	3	0.188	.51	Rod	5/16-24	2.75
6203BBU084	84	3	0.188	.51	Rod	5/16-24	3
6203BBU096	96	3	0.188	.51	Rod	5/16-24	3.25
6203BBU108	108	3	0.188	.51	Rod	5/16-24	3.25
6203BBU120	120	3	0.188	.51	Rod	5/16-24	3.25
6203BBU132	132	3	0.188	.51	Rod	5/16-24	3.88
6203BBU144	144	3	0.188	.51	Rod	5/16-24	3.13
6203BBU168	168	3	0.188	.51	Rod	5/16-24	4.69
6203BBU216	216	3	0.188	.51	Rod	5/16-24	5.69
6203BBU240	240	3	0.188	.51	Rod	5/16-24	5.75
CCU SERIES - for use with cable clamps							
6203CCU072	72	3	0.188	.51	Rod	5/16-24	2.5
6203CCU084	84	3	0.188	.51	Rod	5/16-24	2.81
6203CCU096	96	3	0.188	.51	Rod	5/16-24	3
6203CCU120	120	3	0.188	.51	Rod	5/16-24	3.38
6203CCU204	204	3	0.188	.51	Rod	5/16-24	5.19

NUT AND WASHER KIT FOR 5200/6200 SERIES CABLES



BNW016

Part No.	Description	Material	Finish	Wt. (lbs.)
BNW015	5/8 for use with 5200 series cable	Carbon Steel	Zinc Plated	0.19
BNW016	11/16 for use with 6200 series cable	Carbon Steel	Zinc Plated	0.19

Control Cables

MID-LATCH CABLES

PLAIN END MID-LATCH CONTROL CABLE WITH 5 INCH TRAVEL

- Mid-latch controls satisfy OSHA requirements for latching hoist controls for dump body application
- Ideal for operating hydraulic valves and forward-reverse P.T.O.s



Part No.	Cable Dia (in.)	Conduit Dia (in.)	Cable Length (ft.)	Total Travel (in.)	Mount Thread Size (in.)	End Type	Cable Core Material	Wt. (lbs.)
R38LL5X12	0.091	0.375	12.00	5.00	5/8-18	Plain/Cut to Length	Stainless Steel	3.2
R38LL5X15	0.091	0.375	15.00	5.00	5/8-18	Plain/Cut to Length	Stainless Steel	3.32

Accessories:

Part No.	Description	Wt. (lbs.)
R38LL5H0	Mid-Latch 5in. Travel Replacement Head	0.7



VERNIER CABLES

3100 & 4100 SERIES VERNIER ADJUSTABLE LOCKING CONTROL CABLE

- 3/4 in -16 UNF head mounting thread
- Control knob can be rotated to adjust cable position, or pushed and pulled by pressing button
- Cut to length design



Part No.	Cable Diameter (in.)	Conduit Diameter (in.)	Cable Length (ft.)	Total Travel (in.)	End Type	Cable Core Material	Wt. (lbs.)
VCGT3100X06	0.075	0.260	6.00	3.25	Plain	Stainless Steel	1.94
VCGT3100X10	0.075	0.260	10.00	3.25	Plain	Stainless Steel	2.19
VCGT3100X15	0.075	0.260	15.00	3.25	Plain	Stainless Steel	2.63
VCGT3100X20	0.075	0.260	20.00	3.25	Plain	Stainless Steel	2.96
VCGT3100X25	0.075	0.260	25.00	3.25	Plain	Stainless Steel	3.28
VCGT3100X30	0.075	0.260	30.00	3.25	Plain	Stainless Steel	3.65
VCGTX06	0.088	0.375	6.00	3.25	Plain	Stainless Steel	2.25
VCGTX10	0.088	0.375	10.00	3.25	Plain	Stainless Steel	2.75
VCGTX15	0.088	0.375	15.00	3.25	Plain	Stainless Steel	3.38
VCGTX20	0.088	0.375	20.00	3.25	Plain	Stainless Steel	4
VCGTX25	0.088	0.375	25.00	3.25	Plain	Stainless Steel	4.63
VCGTX30	0.088	0.375	30.00	3.25	Plain	Stainless Steel	5
VCGTX35	0.088	0.375	35.00	3.25	Plain	Stainless Steel	5.88

Accessories:

Part No.	Description	Wt. (lbs.)
VCGTH0	Vernier Adjustable Locking Control Cable Replacement Head	0.7

MACK® REPLACEMENT THROTTLE CABLE

- Designed for panels with 5/8 in. square mounting holes
- Easily trim to size



Part No.	Cable Diameter (in.)	Cable Length (ft.)	Wt. (lbs.)
R109	.054	9.00	0.75

Control Cables

CONTROL CABLES

R38D SERIES CONTROL CABLE WITH 5 INCH TRAVEL

- Knob part No. 65
- 3/8 in. - 24 THD. & 1/2 in. - 20 THD.
- .375 in. diameter conduit
- .088 in. diameter stainless steel core
- Long lay construction
- Includes clip as shown



Part No.	Cable Dia (in.)	Cable Length (ft.)	Total Travel (in.)	Mount Thread Size (in.)	End Type	Cable Core Material	Wt. (lbs.)
R38D6X06	0.088	6.00	5.00	1/2-20	Plain	Stainless Steel	2.13
R38D6X08	0.088	8.00	5.00	1/2-20	Plain	Stainless Steel	2.13
R38D6X10	0.088	10.00	5.00	1/2-20	Plain	Stainless Steel	2.34
R38D6X12	0.088	12.00	5.00	1/2-20	Plain	Stainless Steel	2.75
R38D6X15	0.088	15.00	5.00	1/2-20	Plain	Stainless Steel	3.00
R38D6X20	0.088	20.00	5.00	1/2-20	Plain	Stainless Steel	3.63
R38D6X25	0.088	25.00	5.00	1/2-20	Plain	Stainless Steel	4.25
R38D6X30	0.088	30	5.0	1/2-20	Plain	Stainless Steel	4.88

Accessories:

Part No.	Description	Wt. (lbs.)
65	2 Inch Knob For PTO Cables Plain 3/8-24 Thread.	0.13
4100	Clip	0.06

R38DR SERIES CONTROL CABLE WITH 3 INCH TRAVEL AND ROD END CONTROL

- Knob Part No. 65
- 1/2 in. - 20 THD., 5/8 in. - 18 THD., & 1/4 in. - 28 THD.
- .375 in. diameter conduit
- .088 in. diameter stainless steel core
- Long lay construction
- Order nuts and washers separately, shown with combination bulkhead and clamp mount



Part No.	Cable Dia (in.)	Cable Length (ft.)	Total Travel (in.)	Mount Thread Size (in.)	End Type	Cable Core Material	Wt. (lbs.)
R38DR3X06	0.088	6.00	3.00	1/2-20	Rod	Stainless Steel	2.13
R38DR3X08	0.088	8.00	3.00	1/2-20	Rod	Stainless Steel	2.38
R38DR3X10	0.088	10.00	3.00	1/2-20	Rod	Stainless Steel	2.63
R38DR3X12	0.088	12.00	3.00	1/2-20	Rod	Stainless Steel	2.88
R38DR3X15	0.088	15.00	3.00	1/2-20	Rod	Stainless Steel	3.25

Accessories:

Part No.	Description	Wt. (lbs.)
BNW015	Control Cable Nut and Washer Kit	0.29
65	2 Inch Knob For PTO Cables Plain 3/8-24 Thread.	0.13



CONTROL CABLES - continued

R09D SERIES CONTROL CABLE WITH 3-1/2 INCH TRAVEL

- 7/16 in. - 20 THD
- .260 in. diameter conduit
- .073 in. diameter oil tempered core
- Variable locking detent



Part No.	Cable Dia (in.)	Cable Length (ft.)	Total Travel (in.)	Mount Thread Size (in.)	End Type	Cable Core Material	Wt. (lbs.)
R09D3.5X06	0.073	6	3.5	7/16-20	Plain	Oil Tempered Steel	0.67
R09D3.5X10	0.073	10	3.5	7/16-20	Plain	Oil Tempered Steel	0.90
R09D3.5X15	0.073	15	3.5	7/16-20	Plain	Oil Tempered Steel	1.21

R05B SERIES CONTROL CABLE WITH 5 INCH TRAVEL

- 3/8 in. - 24 THD
- .312 in. diameter spiral wound conduit
- .085 in. diameter stainless steel core
- Spiral wound conduit can be cut with side cutting pliers



Part No.	Cable Dia (in.)	Cable Length (ft.)	Total Travel (in.)	Mount Thread Size (in.)	Cable Core Material	Wt. (lbs.)
R05B5X06	0.085	6	5.0	1/2-20	Stainless Steel	1.176
R05B5X10	0.085	10	5.0	1/2-20	Stainless Steel	2.38
R05B5X15	0.085	15	5.0	1/2-20	Stainless Steel	3.05

R21C SERIES CHOKE CABLE

- 3/8 in. - 24 THD
- .055 in. diameter conduit
- 2 1/2 in. total travel



Part No.	Cable Dia (in.)	Cable Length (ft.)	Total Travel (in.)	Mount Thread Size (in.)	Cable Core Material	Wt. (lbs.)
R21CX06	0.055	6	2.5	3/8-24	Oil Tempered Steel	0.33
R21CX08	0.055	8	2.5	3/8-24	Oil Tempered Steel	0.34
R21CX10	0.055	10	2.5	3/8-24	Oil Tempered Steel	1
R21CX15	0.055	15	2.5	3/8-24	Oil Tempered Steel	0.72

Pump and PTO Connection Kits

BPT PTO CONNECTION KIT - DUAL GEAR

- For double gear CHELSEA® and similar PTOs
- Includes: All required fasteners & hardware



BPT Contents

BPT Assembly

Part No.	Works with Cable Type	Compatible Cable Thread Size (in.)	Connects To	Wt. (lbs.)
BPT	5200 & 6200 Series	1/4-28 & 5/16-24	Double Gear Chelsea & Similar P.T.O.s	0.88

BPTSG PTO CONNECTION KIT - SINGLE GEAR

- For single gear CHELSEA® and similar PTOs
- Fits all Muncie® PTOs
- Includes: All required fasteners & hardware



BPTSG Contents

BPTSG Assembly

Part No.	Works with Cable Type	Compatible Cable Thread Size (in.)	Connects To	Wt. (lbs.)
BPTSG	5200 & 6200 Series	1/4-28 & 5/16-24	Single Gear Chelsea & all Muncie P.T.O.s	0.88

BPU PUMP CONNECTION KIT FOR C1010 PUMP

- For BPC1010, Commercial C101™ & similar pumps
- Includes: All required fasteners & hardware

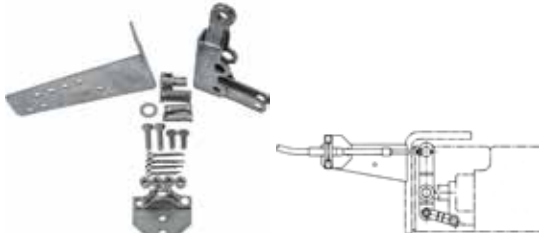

BPU Contents

BPU Assembly

Part No.	Works with Cable Type	Compatible Cable Thread Size (in.)	Connects To	Wt. (lbs.)
BPU	5200 & 6200 Series	1/4-28 & 5/16-24	Buyers BPC1010 commercial C101 & similar pumps	1.54

BPUGD PUMP CONNECTION KIT FOR G101 PUMP

- For Commercial G101™ remote mount pumps
- Includes: All required fasteners & hardware



BPUGD

BPUGD Assembly

Part No.	Works with Cable Type	Compatible Cable Thread Size (in.)	Connects To	Wt. (lbs.)
BPUGD	5200 & 6200 Series	1/4-28 & 5/16-24	Commercial G101	2.65

BPU102DM PUMP CONNECTION KIT FOR C1010DM PUMP

- For BPC1010DM, Commercial C102™ & similar pumps

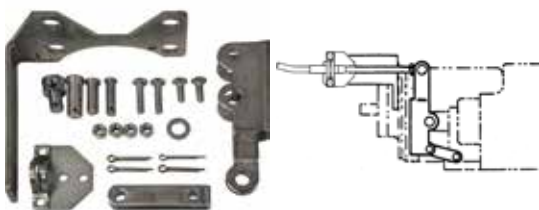

BPU102DMCCW Contents

BPU102DMCCW Assembly

Part No.	Works with Cable Type	Compatible Cable Thread Size (in.)	Connects To	Rotation	Wt. (lbs.)
BPU102DMCW	5200 & 6200 Series	1/4-28 & 5/16-24	Buyers BPC1010DM, Commercial C102 and Similar Parts	Clockwise	1.7
BPU102DMCCW	5200 & 6200 Series	1/4-28 & 5/16-24	Buyers BPC1010DM, Commercial C102 and Similar Parts	Counter Clockwise	1.7



BPUGDM PUMP CONNECTION KIT FOR G102 PUMP

- For Commercial G102™ pumps



BPUGDMCW Contents

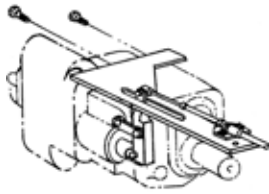

BPUGDMCW Assembly

Part No.	Works with Cable Type	Compatible Cable Thread Size (in.)	Connects To	Rotation	Wt. (lbs.)
BPUGDMCCW	5200 & 6200 Series	1/4-28 & 5/16-24	Commercial G102 Pump	Counter Clockwise	2.6
BPUGDMCW	5200 & 6200 Series	1/4-28 & 5/16-24	Commercial G102 Pump	Clockwise	2.6

H101CK PUMP CONNECTION KIT FOR H101 SERIES PUMP

- For use with Buyers H101 Series, Permco DMR300™ and DMR400™ Series Remote Mount Pumps



H101CK Contents



H101CK Assembly

Part No.	Works with Cable Type	Compatible Cable Thread Size (in.)	Connects To	Wt. (lbs.)
H101CK	5200 & 6200 Series	1/4-28 & 5/16-24	Buyers H101 Series, Permco DMR300 and DMR400 Series Remote Mount Pumps	2.38

H102CKCW PUMP CONNECTION KIT FOR H102 SERIES PUMP

- For use with Buyers H102 Series, Permco DMD300™ and DMD400™ Series Direct Mount Pumps



H102CKCW Contents

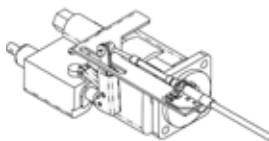

H102CKCW Assembly

Part No.	Works with Cable Type	Compatible Cable Thread Size (in.)	Connects To	Rotation	Wt. (lbs.)
H102CKCW	5200 & 6200 Series	1/4-28 & 5/16-24	Buyers H102 Series, Permco DMD300 and DMD400 Series Direct Mount Pumps	Clockwise	2.32
H102CKCCW	5200 & 6200 Series	1/4-28 & 5/16-24	Buyers H102 Series, Permco DMD300 and DMD400 Series Direct Mount Pumps	Counter Clockwise	2.48

BSV PUMP CONNECTION KIT FOR A-35 VALVES

- For Commercial A-20™, A-35™ & similar valves



BSV3552 Contents



BSV3552 Assembly

Part No.	Works with Cable Type	Compatible Cable Thread Size (in.)	Connects To	Wt. (lbs.)
BSV3552	5200 Series	1/4-28	Commercial A-20, A-35 and Similar Valves	1.85

Knobs and Hardware

BOWDEN PIN

- Brass construction with .098 in. wire hole

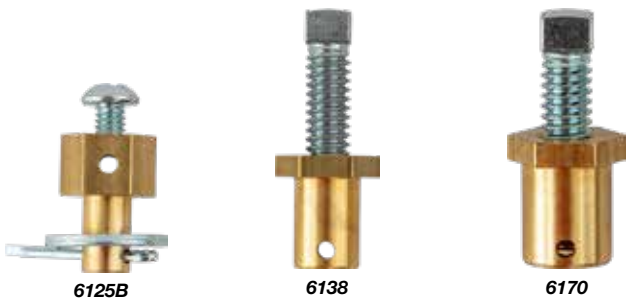

Part No.	Description	Material	Wt. (lbs.)
6125B	1/4 in. Bowden pin	Brass	0.01
6138	3/8 in. Bowden pin	Brass	0.03
6170	7/16 in. Bowden pin	Brass	0.03

THROTTLE STOP ASSEMBLY

- Zinc-plated screw
- Brass construction with .088 in. wire hole



Part No.	Description	Material	Wt. (lbs.)
516	Brass construction w/ .088 in. wire hole	Brass	0.02

MOUNTING PLATE

- Provides an adjustable mounting base for all output ends of clamp-type push pull cables



Part No.	Material	Finish	Wt. (lbs.)
356	Carbon Steel	Zinc Plated	0.15

UNIVERSAL PIVOT PIN

- For 1/4 in. thick levers with 7/16 in. diameter hole
- For both 1/4 in. - 28 THD and 5/16 in. - 24 THD



Part No.	Material	Finish	Wt. (lbs.)
P5262	Carbon Steel	Zinc Plated	0.06

VINYL COATED CONDUIT STRAP

- Coated with black vinyl for greater vibration absorption and resistance to corrosion and wear
- Easily mount and secure with just one fastener



Part No.	Description	Material	Finish	Wt. (lbs.)
250	For use with .260 in. conduit	Carbon Steel	Vinyl Coated	0.01
375	For use with .375 in. conduit	Carbon Steel	Vinyl Coated	0.01

CLAMP

- Provides a 1/4 in. hole to secure output end of all .375 conduit



Part No.	Description	Wt. (lbs.)
4100	Clamp	0.06

3/8 INCH-24 THREAD BULKHEAD FITTING

- Provides 3/8 in. - 24 Thd. on output end of all .375 in. conduit
- Use with VCGT, RF04D, R38D Cables



1238

Part No.	Material	Finish	Wt. (lbs.)
1238	Hardened Steel	Plain	0.03

3/8 INCH-24 THREAD BULKHEAD FITTING FOR .260 CONDUIT

- Provides 3/8 in. -24 Thd. on output end of all .260 conduit
- Use with VCGT 3100 Series Cables
- Replaces 1209R



1207R

Part No.	Material	Finish	Wt. (lbs.)
1207R	Multiple	Plain	0.09

REPLACEMENT KNOBS



VSK001



B659KB



65



651

Part No.	Thread Size	Material	Color	Wt. (lbs.)
VSK001	3/8-24	Polymer	Black	0.13
B659KB	1/2-13	Polymer	Black	0.13
65	3/8-24	Polymer	Black	0.13
651	3/8-24	Polymer	Black	0.13
20	1/4-28	Polymer	Black	0.13

REMOTE VALVE CONTROL LABELS



Part No.	Description	Wt. (lbs.)
VSK040	Remote Valve Control Knob Decal Sheet	0.13

Ball Joints & Rod End Bearings

BALL JOINT

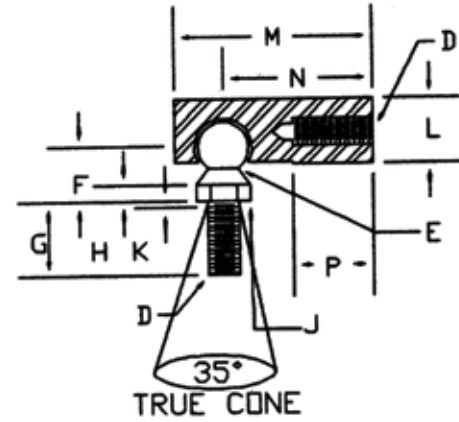

Part No.	D	E	F	G	H	J	K	L	M	N	P	Wt. (lbs.)
BJ31	10-32	.172	7/16	7/16	1/8	5/16	1/16	3/8	1-1/16	7/8	7/16	0.13
BJ52	1/4-28	.193	15/32	9/16	1/8	3/8	3/32	7/16	1-7/32	31/32	1/2	0.08
BJ62	5/16-24	.232	17/32	11/16	5/32	7/16	3/32	1/2	1-13/32	1-1/8	9/16	0.08
BJ72	3/8-24	.297	11/16	7/8	3/16	1/2	3/32	5/8	1-11/16	1-3/8	3/4	0.25
BJ82	1/2-20	.417	7/8	11/8	1/4	5/8	1/8	3/4	2-3/8	1-15/16	1	0.31

ROD END BEARING

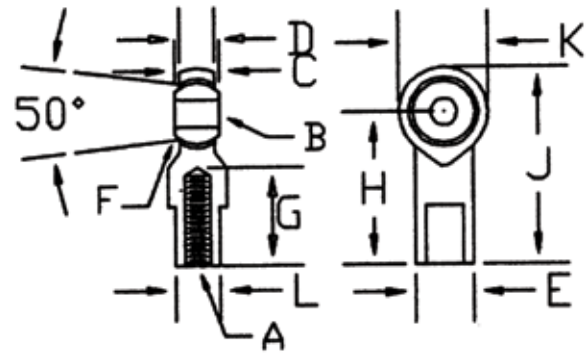

Part No.	A	B	C	D	E	F	G	H	J	K	L	M	Wt. (lbs.)
BRE32F	10-32 UNF-2	.1895 - .1925	.310	.250	.406	.437	.562	1.062	1.375	.625	.310	.308	0.13
BRE52F	1/4-28 UNF-2	.2495 - .2525	.373	.281	.468	.516	.750	1.312	1.687	.750	.373	.357	0.08
BRE62F	5/16-24 UNF-2	.3120 - .3150	.435	.342	.500	.622	.750	1.375	1.812	.870	.435	.444	0.13
BRE72F	3/8-24 UNF-2	.3745 - .3775	.498	.404	.687	.716	.937	1.625	2.125	.995	.560	.514	0.13
BRE82F	1/2-20 UNF-2	.4995 - .5025	.623	.500	.875	.937	1.187	2.125	2.781	1.307	.748	.700	0.13



ROD END BEARING WITH STUD

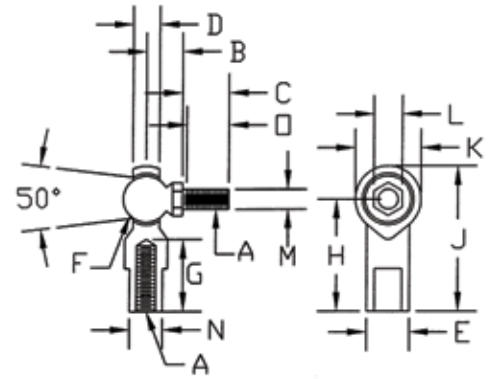

Part No.	A	B	C	D	E	F	G	H	J	K	L	M	N	O	Wt. (lbs.)
BRE32S	10-32 UNF-2	.485	.500	.250	.406	.437	.562	1.062	1.375	.625	.310	.373	.310	.437	0.13
BRE52S	1/4-28 UNF-2	.485	.562	.281	.468	.516	.750	1.312	1.687	.750	.373	.435	.373	.470	0.13
BRE62S	5/16-24 UNF-2	.531	.687	.342	.500	.622	.750	1.375	1.812	.870	.435	.544	.435	.594	0.13
BRE72S	3/8-24 UNF-2	.656	.875	.404	.687	.716	.937	1.625	2.125	.995	.498	.613	.560	.781	0.18
BRE82S	1/2-20 UNF-2	.875	1.125	.500	.875	.937	1.187	2.125	2.781	1.307	.623	.748	.748	1.00	0.35

ROD END BEARING MALE THREAD

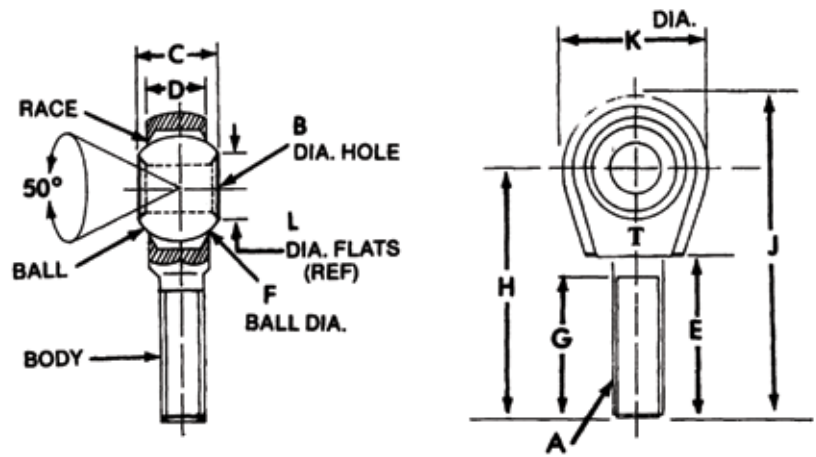

Part No.	A	B	C	D	E	F	G	H	J	K	L	Wt. (lbs.)
BRE32M	10-32 UNF-2	.1895 - .1925	.310	.250	.812	.437	.750	1.250	1.562	.625	.308	0.03
BRE52M	1/4-28 UNF-2	.2495 - .2525	.373	.281	1.094	.516	1.000	1.562	1.937	.750	.357	0.06
BRE62M	5/16-24 UNF-2	.3120 - .3150	.435	.342	1.364	.622	1.250	1.875	2.312	.870	.444	0.06
BRE72M	3/8-24 UNF-2	.3745 - .3775	.498	.404	1.364	.716	1.250	1.937	2.437	.995	.514	0.10
BRE82M	1/2-20 UNF-2	.4995 - .5025	.623	.500	1.713	.937	1.500	2.438	3.094	1.307	.700	0.23

Rod Ends and Yoke Ends

CLEVIS ROD END YOKE WITH PIN AND COTTER PIN

- Clear zinc-plated for corrosion resistance



B27086ANFZKT

Part No.	Base to Hole Center (in.)	Neck Dia. (in.)	Height of Yoke Arm (in.)	Center Hole to Neck (in.)	Inner Arm to Arm (in.)	Width (in.)	Hole Dia. (in.)	Neck Length (in.)	Clevis Pin Hole Dia. (in.)	Thread Size (in.)	Clevis Pin Incl. (y/n)	Wt. (lbs.)
B27081AZKT	1.563	0.313	0.313	1.000	0.188	0.438	0.188	0.563	0.375	3/16-32	Yes	0.04
B27082AZKT	2.000	0.438	0.438	1.250	0.281	0.625	0.250	0.750	0.500	1/4-28	Yes	0.09
B27083AZKT	2.250	0.500	0.500	1.438	0.344	0.750	0.313	0.813	0.594	5/16-24	Yes	0.13
B27083A14ZKT	2.250	0.500	0.500	1.438	0.344	0.750	0.313	0.813	0.594	1/4-28	Yes	0.14
B27084AZKT	2.500	0.625	0.625	1.625	0.438	0.875	0.375	0.875	0.688	3/8-24	Yes	0.22
B27084A14ZKT	2.500	0.625	0.625	1.625	0.438	0.875	0.375	0.875	0.688	1/4-28	Yes	0.23
B27084A56ZKT	2.500	0.625	0.625	1.625	0.438	0.875	0.375	0.875	0.688	5/16-24	Yes	0.22
B27086A56ZKT	3.000	0.813	0.813	1.875	0.563	1.125	0.500	1.125	0.938	5/16-24	Yes	0.44
B27086A38ZKT	3.000	0.813	0.813	1.875	0.563	1.125	0.500	1.125	0.938	3/8-24	Yes	0.44
B27086ANFZKT	3.000	0.813	0.813	1.875	0.563	1.125	0.500	1.125	0.938	1/2-20	Yes	0.44
B27087CKT	1.903	0.844	0.847	1.250	0.594	1.281	0.500	0.563	0.969	5/8-18	Yes	0.37

CLEVIS PIN

- SAE Standard



B27081/23AZ

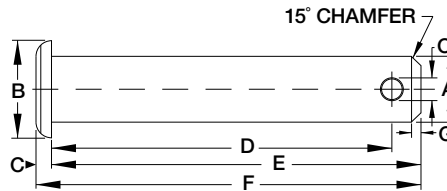

Part No.	Finish	A	B	C	D (Min.)	E	F	G	(O) Drill No.	Wt. (lbs.)
B27081/22AZ	Zinc Plated Clear	0.250	0.375	0.094	0.672	0.797	0.891	0.063	49 (.073)	0.01
B27081/23AZ	Zinc Plated Clear	0.313	0.438	0.094	0.813	0.969	1.063	0.078	38 (.101)	0.02
B27081/24AZ	Zinc Plated Clear	0.375	0.500	0.125	0.938	1.094	1.219	0.078	38 (.101)	0.04
B27081/26AZ	Zinc Plated Clear	0.500	0.625	0.156	1.203	1.359	1.540	0.109	29 (.136)	0.09
B27081/26C	Zinc Plated Clear	0.500	0.625	0.156	1.766	1.984	2.141	0.109	29 (.136)	0.12
B27081/26D	Zinc Plated Yellow	0.500	0.625	0.156	1.982	2.203	2.359	0.109	29 (.136)	0.14
B27081/27AZ	Zinc Plated Clear	0.625	0.813	0.203	1.469	1.719	1.922	.109	29 (.136)	0.17
B27081/27BZ	Zinc Plated Clear	0.500	0.625	0.156	1.562	1.781	1.983	0.109	29 (.136)	0.09
B27081/27C	Zinc Plated Yellow	0.500	0.625	0.156	1.344	1.563	1.750	0.156	29 (.136)	0.09
B27081/28AZ	Zinc Plated Clear	0.750	0.938	0.250	1.750	2.047	2.297	0.156	19 (.166)	0.30
B27081/210C	Zinc Plated Clear	0.625	0.813	0.188	1.625	1.750	1.953	0.062	29 (.136)	0.18
3007113	Zinc Plated Clear	0.313	0.438	0.094	2.364	2.510	2.750	.143	29 (.136)	0.06



BLANK FORGED ROD END

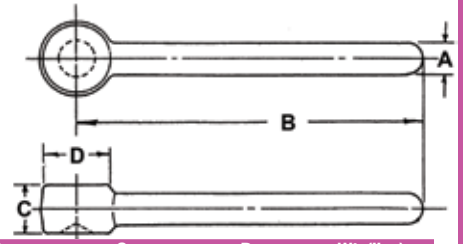

Part No.	Description	A	B	C	D	Wt. (lbs.)
B27026EB	Blank Rod End	1/2"	6"	9/16"	3-1/32"	0.44
B27027EB	Blank Rod End	5/8"	6"	11/16"	1-1/4"	0.70
B27028EB	Blank Rod End	3/4"	6"	13/16"	1-1/2"	1.10
B270210EB	Blank Rod End	1"	6"	1-3/32"	2-1/32"	2.11

FORGED ROD END

- Machined with NC thread

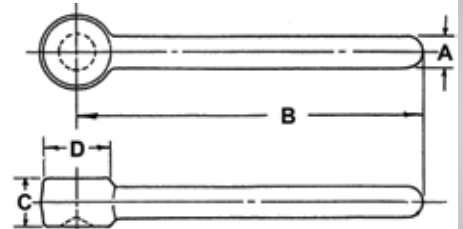

Part No.	Description	A	B	C	D	Wt. (lbs.)
B27024BM	Machined with NC Thread Rod End	3/8"	3-1/2"	7/16"	1-1/16"	0.12
B27026BM	Machined with NC Thread Rod End	1/2"	3-1/2"	9/16"	3-1/32"	0.27
B27026EM	Machined with NC Thread Rod End	1/2"	6"	9/16"	3-1/32"	0.34
B27026M10	Machined with NC Thread Rod End	1/2"	10"	9/32"	3-1/32"	0.56
B27027EM	Machined with NC Thread Rod End	5/8"	6"	11/16"	1-1/4"	0.53
B27028EM	Machined with NC Thread Rod End	3/4"	6"	13/16"	1-1/2"	0.88
B270210EM	Machined with NC Thread Rod End	1"	6"	1-3/32"	2-1/32"	1.58
B270212KM	Machined with NC Thread Rod End	1-1/4"	12"	1-1/4"	2-3/8"	4.40

FORGED ROD END

- Machined with NC thread
- Zinc plated

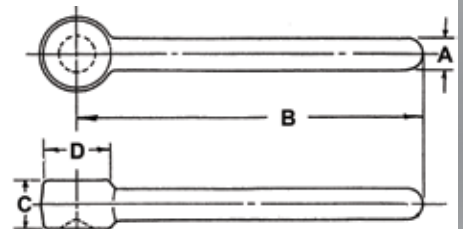

Part No.	Description	A	B	C	D	Wt. (lbs.)
B27028LMZ	Machined with NC Thread Rod End	3/4"	7"	1/2"	1-1/2"	1.04
B270210HMZ	Machined with NC Thread Rod End	1"	9-1/4"	1"	2"	2.20

ADJUSTABLE YOKE END, SPREAD

- Machine forged
- Spread
- Fine thread



Part No.	Description	Wt. (lbs.)
B27086C	1/2" Adjustable Yoke End, Spread	0.32

Rod Ends and Yoke Ends

ADJUSTABLE YOKE END, STRAIGHT

- Machine forged
- Meet S.A.E. standards
- Custom sizes & finishes available

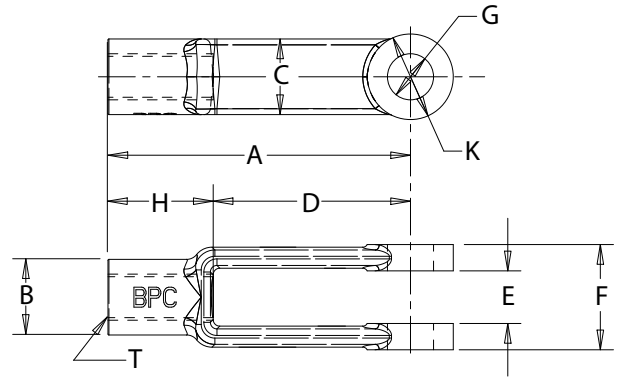

Part No.	A	B	C	D	E	F	G	H	K	T (Thread)	Wt. (lbs.)
B27081AZ	1.563"	0.313"	0.313"	1.000"	0.188"	0.438"	0.188"	0.563"	0.375"	3/16-32 NF	0.03
B27082A	2.000"	0.438"	0.438"	1.250"	0.281"	0.625"	0.250"	0.750"	0.500"	1/4-28 NF	0.07
B27082AZ	2.000"	0.438"	0.438"	1.250"	0.281"	0.625"	0.250"	0.750"	0.500"	1/4-28 NF	0.07
B27083A	2.250"	0.500"	0.500"	1.438"	0.344"	0.750"	0.313"	0.813"	0.594"	5/16-24 NF	0.11
B27083AZ	2.250"	0.500"	0.500"	1.438"	0.344"	0.750"	0.313"	0.813"	0.594"	5/16-24 NF	0.11
B27083A14Z	2.250"	0.500"	0.500"	1.438"	0.344"	0.750"	0.313"	0.813"	0.594"	1/4-28 NF	0.11
B27084A	2.500"	0.625"	0.625"	1.625"	0.438"	0.875"	0.375"	0.875"	0.688"	3/8-24 NF	0.17
B27084AZ	2.500"	0.625"	0.625"	1.625"	0.438"	0.875"	0.375"	0.875"	0.688"	3/8-24 NF	0.17
B27084A14Z	2.500"	0.625"	0.625"	1.625"	0.438"	0.875"	0.375"	0.875"	0.688"	1/4-28 NF	0.17
B27084A56ZY	2.500"	0.625"	0.625"	1.625"	0.438"	0.875"	0.375"	0.875"	0.688"	5/16-24 NF	0.17
B27084A12	2.500"	0.625"	0.625"	1.625"	0.438"	0.875"	0.375"	0.875"	0.688"	1/2-20 NF	0.17
B27085A	2.875"	0.719"	0.719"	1.875"	0.500"	1.000"	0.438"	1.000"	0.813"	7/16-20 NF	0.24
B27086ANF	3.000"	0.813"	0.813"	1.875"	0.563"	1.125"	0.500"	1.125"	0.938"	1/2-20 NF	0.39
B27086ANFZ	3.000"	0.813"	0.813"	1.875"	0.563"	1.125"	0.500"	1.125"	0.938"	1/2-20 NF	0.39
B27086ANC	3.000"	0.813"	0.813"	1.875"	0.563"	1.125"	0.500"	1.125"	0.938"	1/2-13 NC	0.39
B27086ANCZ	3.000"	0.813"	0.813"	1.875"	0.563"	1.125"	0.500"	1.125"	0.938"	1/2-13 NC	0.39
B27086A14Z	3.000"	0.813"	0.813"	1.875"	0.563"	1.125"	0.500"	1.125"	0.938"	1/4-28 NF	0.39
B27086A56ZY	3.000"	0.813"	0.813"	1.875"	0.563"	1.125"	0.500"	1.125"	0.938"	5/16-24 NF	0.39
B27086A38ZY	3.000"	0.813"	0.813"	1.875"	0.563"	1.125"	0.500"	1.125"	0.938"	3/8-24 NF	0.39
B27086B	4.188"	0.813"	0.813"	3.063"	0.563"	1.125"	0.500"	1.125"	0.938"	1/2-20 NF	0.39
B27087ANF	4.938"	1.063"	1.063"	3.688"	0.688"	1.375"	0.625"	1.250"	1.188"	5/8-18 NF	0.85
B27087ANFZ	4.938"	1.063"	1.063"	3.688"	0.688"	1.375"	0.625"	1.250"	1.188"	5/8-18 NF	0.85
B27087ANC	4.938"	1.063"	1.063"	3.688"	0.688"	1.375"	0.625"	1.250"	1.188"	5/8-11 NC	0.85
B27087B	4.469"	1.063"	0.750"	3.250"	0.563"	1.438"	0.500"	1.219"	1.063"	5/8-18 NF	0.64
B27087C	1.903"	0.844"	0.847"	1.250"	0.594"	1.281"	0.500"	0.563"	0.969"	5/8-18 NF	0.24
B27088ANF	6.063"	1.250"	1.250"	4.563"	0.813"	1.625"	0.750"	1.500"	1.438"	3/4-16 NF	1.15
B27088ANC	6.063"	1.250"	1.250"	4.563"	0.813"	1.625"	0.750"	1.500"	1.438"	3/4-10 NC	1.15
B270810C	2.313"	1.125"	1.250"	1.500"	0.563"	1.500"	0.625"	0.813"	1.250"	5/8-18 NF	0.68

*LH = Left Hand Thread



Rod Ends and Yoke Ends

ADJUSTABLE YOKE END



- Machine forged
- Curved

Part No.	Description	Wt. (lbs.)
B27087BB	5/8" Adjustable Yoke End, Curved Clevis, 5/8" - 18" unf	0.64
B27086EZ	1/2" Adjustable Yoke End, Curved Clevis, 5/8" - 20" unf	0.50

OFFSET YOKE END



- Machine Forged

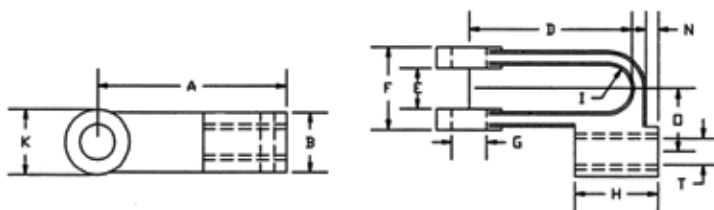

Part No.	A	B	C	D	E	F	G	H	I	K	O	T	Wt. (lbs.)
B26996A	2-1/4"	13/16"	17/8"	9/16"	11/8"	1/2"	11/8"	5/16"	15/16"	1/8"	53/64"	1/2-20 NF	0.38

PLAIN YOKE END



- Meets S.A.E. standard

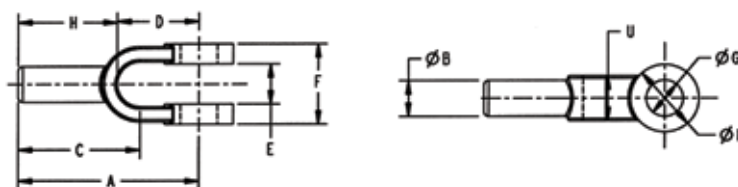

Part No.	A	B	C	D	E	F	G	H	K	U	Wt. (lbs.)
B27094A	2-1/8"	3/8"	1-33/64"	2-7/32"	7/16"	7/8"	3/8"	1-1/4"	11/16"	5/8"	0.11
B27096A	2-1/2"	1/2"	1-11/16"	1-1/8"	9/16"	1-1/8"	1/2"	1-3/8"	15/16"	5/8"	0.24
B27097A	4-5/8"	5/8"	3-5/8"	1-7/16"	11/16"	1-3/8"	5/8"	3-1/4"	1-3/16"	1"	0.46

Nylon Cable Ties

CABLE/ZIP TIES

NYLON CABLE TIES

- 100% nylon
- Bent tip for ease of installation
- Available in natural or black weather resistant (WR)



Part No.	Length	Width	Tensile Strength (lbs.)	Color	Military Standard	Package Quantity	Package Wt. (lbs.)
BTN055CPK	5-1/2"	.180	50	Natural	MS-3367-5	100 PC	0.08
BTN075	7-1/2"	.180	50	Natural	MS-3367-1	1000 PC	2.50
BTN075CPK	7-1/2"	.180	120	Natural	MS-3367-1	100 PC	0.13
BTN011CPK	11"	.180	50	Natural	MS-3367-7	100 PC	0.18
BTN011	11"	.180	50	Natural	MS-3367-7	500 PC	4.25
BTN145	14-1/2"	.250	120	Natural	MS-3367-3	100 PC	0.98
BTN015	15"	.180	50	Natural	MS-3367-2	100 PC	0.57
BTN240	24"	.350	175	Natural	N/A	50 PC	1.40
BTN300	30"	.350	175	Natural	MS-3367-6	50 PC	2.08
BTN075WRCPK	7-1/2"	.180	50	Black	MS-3367-1	100 PC	0.26
BTN075WR	7-1/2"	.180	50	Black	MS-3367-1	1000 PC	2.60
BTN011WRCPK	11"	.180	50	Black	MS-3367-7	100 PC	0.24
BTN011WR	11"	.180	50	Black	MS-3367-7	500 PC	1.96
BTN145WR	14-1/2"	.250	120	Black	MS-3367-3	100 PC	0.98
BTN015WR	15"	.180	50	Black	MS-3367-2	100 PC	0.56

ADHESIVE MOUNT

- 1" square adhesive mount
- Also accepts #6 screw
- For all ties up to .180 wide
- 100 pcs. per bag
- Color: Natural



Part No.	Description	Wt. (lbs.)
B08462	Adhesive Mount	0.42



PTO Driveline

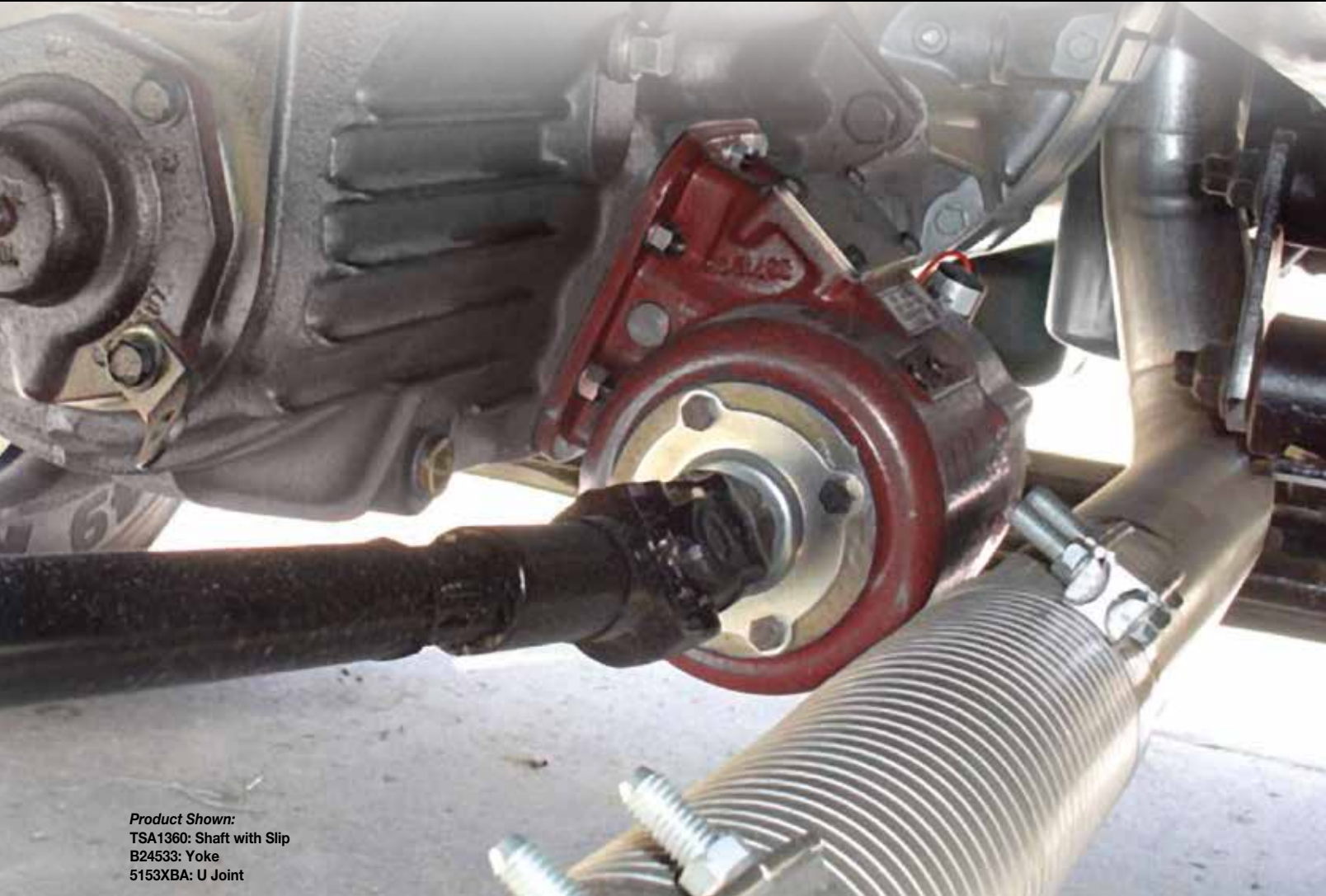

Product Shown:
TSA1360: Shaft with Slip
B24533: Yoke
5153XBA: U Joint

Universal Joint Assemblies,	
End Yokes	470
Slip Yokes and Joint Assemblies	471
H7 Tubular Shaft Assemblies,	
Spline Adapters, & H3 Joints	472
Yokes and Flanges	473

Driveshaft Assemblies	474 - 475
Keys & Hardware	476
Grease Fittings	477
Pillow Blocks	478 - 479
Flange Bearings	479 - 480

Universal Joint Assemblies, End Yokes

H7 SERIES END YOKE

- H7-Series needle bearing uses NB7A "U" joint

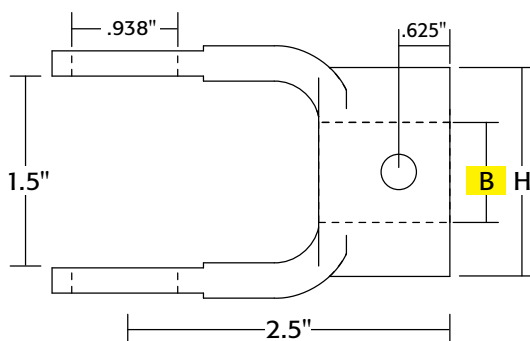

Style A - Round Bore



Style B - Round Bore
ID or OD Welding



Style C - Square Bore



Style D - Hex Bore



Style E - Spline Bore



Style F - Quick Detach
Bore

Part No.	Bore Size	Keyway Size	Keyway AT	Set Screw Size	Set Screw AT	H
STYLE A - Round Bore at B						
74373	5/8"	3/16"	1	3/8"-16	4	1-5/8"
7413	3/4"	3/16"	1	3/8"-16	4	1-5/8"
7423	3/4"	1/4"	1	3/8"-16	4	1-5/8"
7453	7/8"	3/16"	1	3/8"-16	4	1-5/8"
74263	7/8"	1/4"	1	3/8"-16	4	1-5/8"
7463	7/8"	1/4"	2	3/8"-16	4	1-5/8"
74293	1"	1/4"	1	3/8"-16	4	2"
7493	1"	1/4"	2	3/8"-16	4	2"
74393	1"	1/4"	2	3/8"-16	1	2"
74443	1"	-	-	3/8" Pin hole	-	2"
74103	1-1/8"	1/4"	2	3/8"-16	4	2"
74183	1-1/4"	1/4"	2	3/8"-16	4	2"
74123	1-1/4"	5/16"	2	3/8"-16	1	2"
74223	1-1/4"	5/16"	2	3/8"-16 (2)	1-4	2"
STYLE B - Round Bore ID or OD Welding						
74323	1-1/4" I.D. / 2" O.D. Weld Yoke					
STYLE C - Square Bore at B						
7422	3/4"	-	Square	3/8"-16	4	1-5/8"
7412	7/8"	-	Square	3/8"-16	4	2"
7452	1"	-	Square	3/8"-16	4	2"
STYLE D - Hex Bore at B						
74282	7/8"	-	Hex	3/8"-16	4	2"
7432	1-1/8"	-	Hex	3/8"-16	4	2"
STYLE E - Spline Bore at B						
74481	7/8"-13 SP.	Spline	3/8"-16	3	-	2"
STYLE F - Quick Detach Bore (for use with quick attached spline adapters)						
74141	1-3/8"-6 SP.	Spline	O.D.	-	-	2"



Slip Yokes and Joint Assemblies

H7 SERIES END YOKE

- H7-Series needle bearing uses NB7A "U" joint

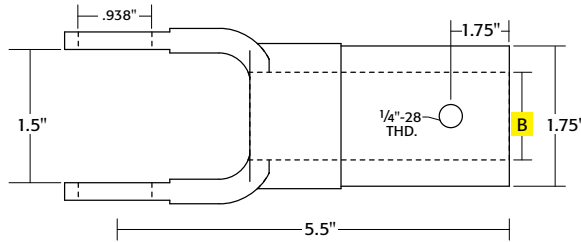

Style A - Round Bore



Style C - Square Bore



Style D - Hex Bore



Style E - Spline Bore

Part No.	Bore Size	Keyway Size	Keyway AT	Lubricator AT
STYLE A - Round Bore at B				
73133	7/8"	1/4"	1	2
73383	1"	1/4"	1	2
73163	1-1/4"	5/16"	2	4
STYLE C - Square Bore at B				
7312	3/4"	-	-	3
7322	7/8"	-	-	3
73122	1"	-	-	3
STYLE D - Hex Bore at B				
73162	7/8"	-	-	3
7332	1-1/8"	-	-	3
STYLE E - Spline Bore at B				
7381	1-1/8"-10 SP.	-	-	3

H7 SERIES UNIVERSAL JOINT ASSEMBLIES

- Maximum recommended torque (continuous duty 1000 RPM): needle bearing - 800 inch pounds
- Maximum recommended angle of operation 15° continuous duty
- Interchangeable with other major manufacturers.



H7 Standard Length



H7 Slip Length

ORDERING PRE-ASSEMBLED UNIVERSAL JOINT ASSEMBLIES

Contact customer service to order pre-assembled joint assemblies.

Build The Assembly Part Number:

- End Yoke Part Number
- Choose Length: Standard (010) or Slip (020)
- * End Yoke or Slip Yoke Part Number

*In Ordering Slip Joints- Step 3 will be a Slip yoke size.

Part No.	Yoke 1 Style / Size	Yoke 2 Style / Size	Length
Example Assemblies, Contact Customer Service for other configurations			
74130107413	3/4" Round 3/16" Key	3/4" Round 3/16" Key	Standard Length
7429301074293	1" Round with 1/4" Key	1" Round with 1/4" Key	Standard Length
7429302073122	1" Round with 1/4" Key	1" Square	Slip Length
7429301074443	1" Round with 1/4" Key	1" Round with 3/8" PH	Standard Length
7444301074443	1" Round 3/8" PH	1" Round 3/8" PH	Standard Length

H7 Tubular Shaft Assemblies, Spline Adapters, & H3 Joints

TUBULAR SHAFT ASSEMBLIES TSA7 SERIES

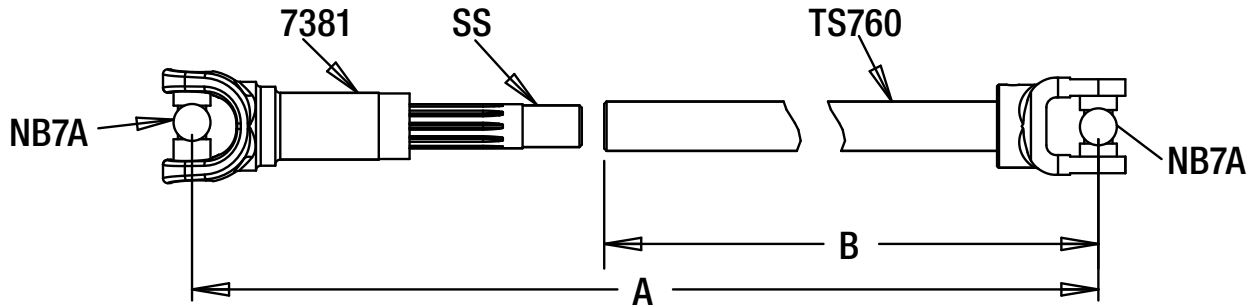

Part No.	Journal Assembly	Yoke & Stub 1-1/8-10 Spline Kit	Tube & Weld Yoke	Overall Length	A	B Tube & Weld Yoke	Wt. (lbs.)
TSA760	NB7A	Yoke# 7381; Stub# SS	TS760	60"	55"	46-1/2"	12.16
TSA772	NB7A	Yoke# 7381; Stub# SS	TS772	72"	67"	58-1/2"	11.20

TSA7 WITH MIDSHIP STUB

- MSS Stubshaft use with TS760 and TS772 yoke and tubes, KAN Woodruff Key, P16 Pillow Block and H7EY1R1/4KW

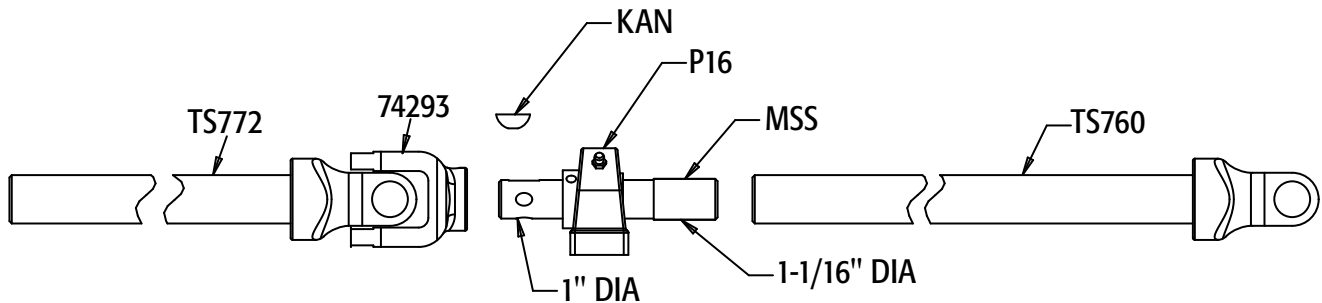

Part No.	Description	Wt. (lbs.)
MSS	B1310 Midship Stub Shaft for 1-1/4in. x 0.095 in. wall tubing	2.05

SHAFT ADAPTERS

- These 1-3/8"-6 spline shaft adapters are grooved to accommodate quick detach yokes and designed for use with part number 74141 for easy connection of different shafts

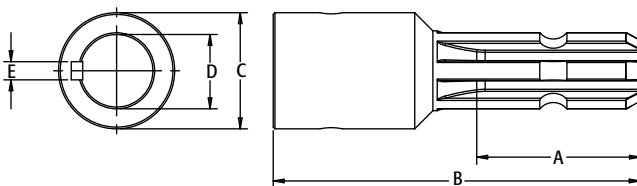

Part No.	A Spline Length	B Overall Length	C O.D.	D Bore	E Keyway
SA1	3.00	6.32	2.00	1.00	1/4"
SA3	3.00	6.32	2.00	1.25	5/16"
SA4	3.00	7.13	2.75	1.50	3/8"



Part No.	Description
74141	1-3/8" SP. Quick Detach Bore H7 Series Joint

H3 STANDARD PIN & BLOCK JOINTS

- Ideal for tarp systems
- Max rating 400 lbs @1000rpm
- 15° Max operation angle

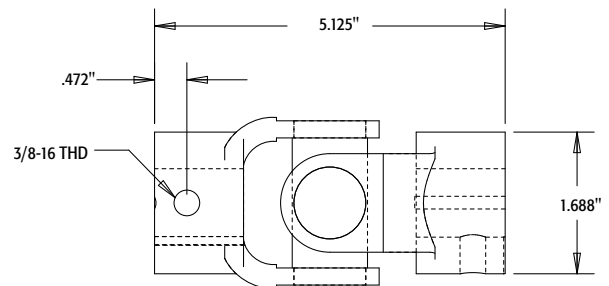

Part No.	Sizes Stocked
H3393X393	1R-1/4KW x 1" Round 1/4KW
H3013X013	3/4R-3/16KW x 3/4-3/16KW



B1310 SERIES JOINT ASSEMBLIES

- Compatible with other major manufacturers' driveline components
- Perfect for heavy-duty applications - up to 1560 inch pounds of torque at 1000 RPM continuous duty
- Variety of sizes and bore types available
- Allows for smooth and continuous torque transfer when used with Buyers Products 5153XBA U-joints
- Gives you the ability to disassemble a drive shaft where space is tight

B1310 SERIES END YOKES

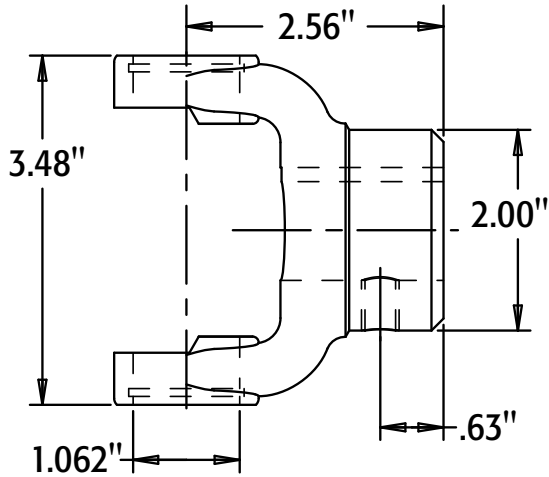

B1310 SERIES SLIP YOKES

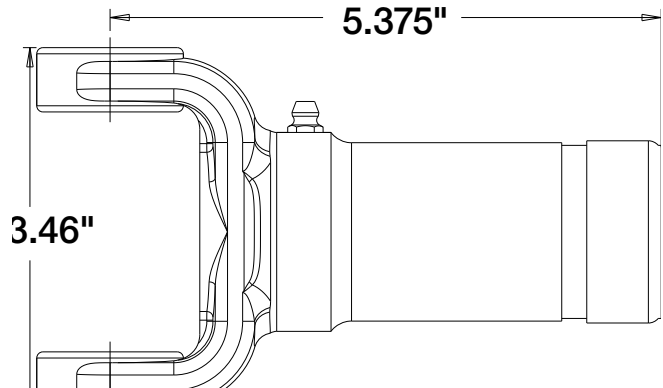

Part No.	Description	Wt. (lbs.)
B24473	1" Round, 1/4" KW	1.80
B24503	1-1/8" Round, 1/4" KW	1.66
B24533	1-1/4" Round, 5/16" KW	1.73
B24573	1-1/4" Round, 1/4" KW	1.73
B241103	1-1/4" Round, No Keyway No Setscrew	1.76
B243331	7/8" 13 Spline Bore	2.00
B2432	1-1/8" Hex Bore	2.40

Part No.	Description	Wt. (lbs.)
B23128KX	1-3/8" 16 Spline Bore	2.32
B23130	1-1/8" 10 Spline Bore	1.91
11840H	1-1/8" Hex Bore	1.91

B1310 SERIES FLANGE YOKES

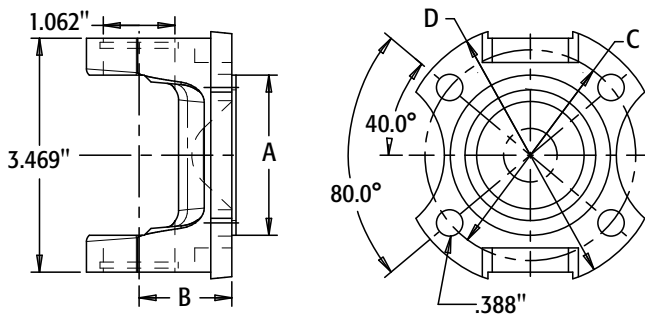

B1310 SERIES COMPANION FLANGE

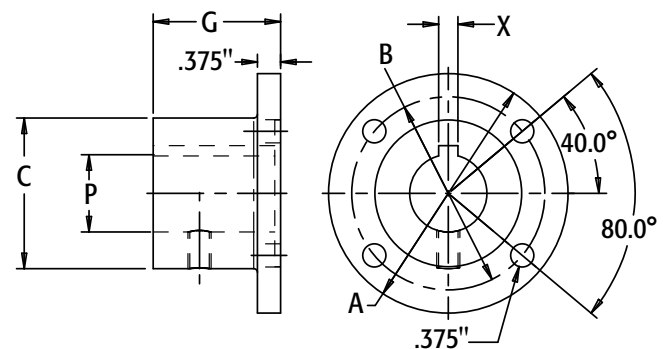

Part No.	A	B	C	D	Wt. (lbs.)
B22329	2.375	1.375	3.125	3.875	1.50
B22479	2.750	1.375	3.750	4.625	2.00

Part No.	A	B	C	Pilot	G	P	X	Wt. (lbs.)
B21333	3.875	3.125	2.44	2.375	2	1.25	.3125	3

Driveshaft Assemblies

B1310 2IN. TUBULAR SHAFT ASSEMBLY

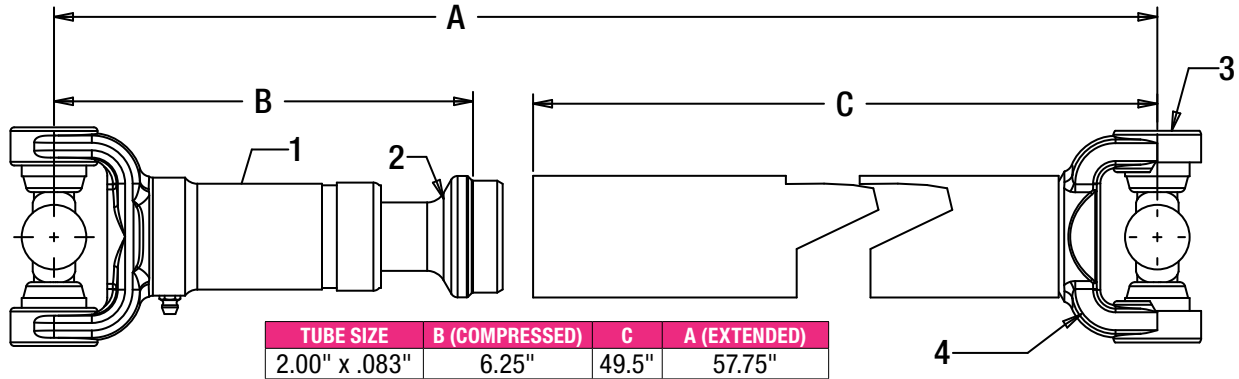

Part No.	Description	Wt. (lbs.)
B9553SF	B1310 Tubular Shaft Assembly	15.0
B23128KX ①	Slip Yoke, 1-3/8"-16 Spline	2.32
B2401031 ②	Stub Shaft, 1-3/8"-16 Spline	2.25
5153XBA ③	Cross Bearing	1.17
B228357TY ④	Tube and Yoke	9.26

B24533

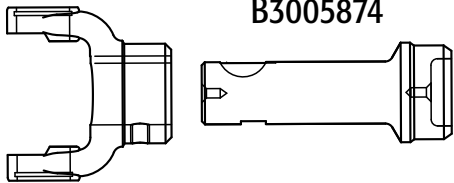

B3005874

B228357TY



- Stub is used with a P20 pillow block, KBN Woodruff Key and B24533 end yoke

Part No.	Description	Wt. (lbs.)
B3005874	B1310 Midship Stub Shaft for 2in. x 0.083 in. wall tubing	2.05

B1310 1-1/4IN. SOLID SHAFT ASSEMBLY

- Solid Shaft Assembly is used for close coupled applications

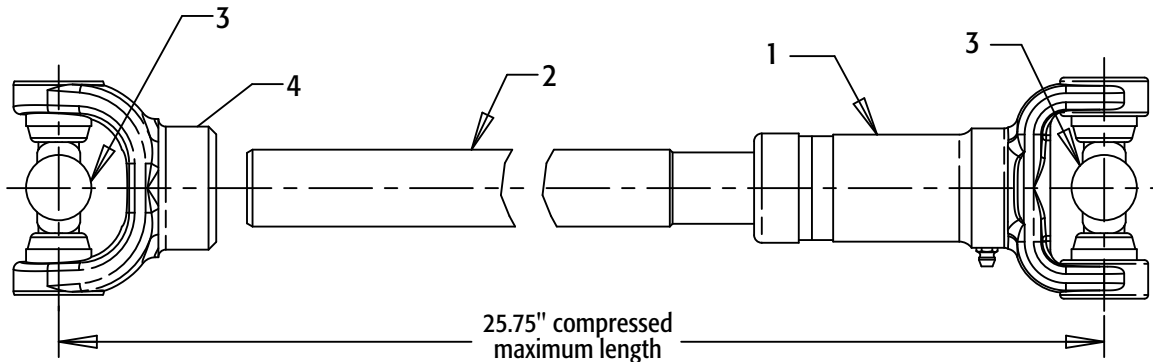

Part No.	Description	Wt. (lbs.)
B91382SF	B1310 Solid Shaft Assembly	13.56
B23128KX ①	Slip Yoke, 1-3/8"-16 Spline	2.32
B248031 ②	Solid Shaft, 1-1/4in. diameter, 24in. long overall, 1-3/8"-16 Spline	8.31
5153XBA ③	Cross Kit	1.17
B241103 ④	Weld Yoke	1.76



TUBULAR SHAFT ASSEMBLIES TSA13 SERIES

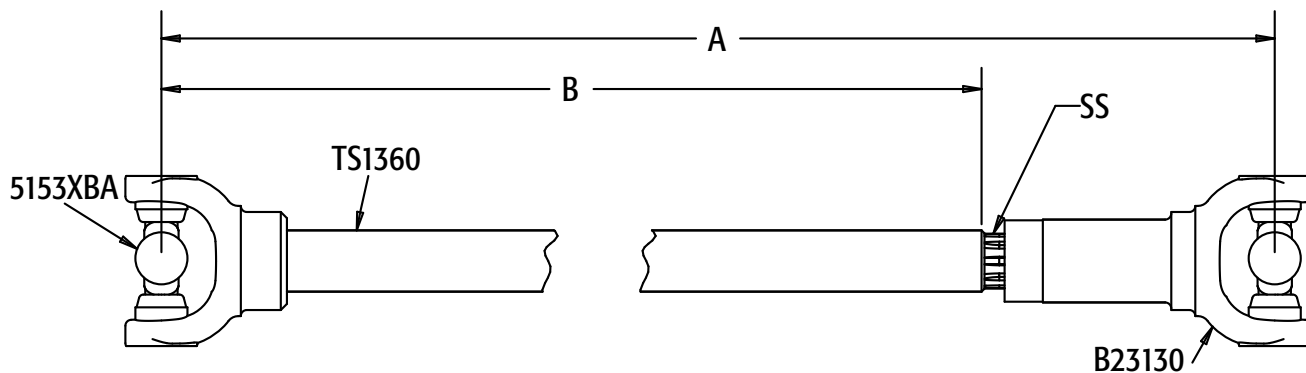

Part No.	Journal Assembly	Slip Yoke	Stub Shaft	Tube & Weld Yoke	Overall Length	A	B Tube & Weld Yoke	Wt. (lbs.)
TSA1360	5153XBA	B23130 1-1/8-10 SP	SS	TS1360	60"	55"	46-1/2"	13.29
TSA1372	5153XBA	B23130 1-1/8-10 SP	SS	TS1372	72"	67"	58-1/2"	14.75

TSA13 WITH MIDSHIP STUB

- MSS stub shaft use with TS1360 and TS1372 yoke and tubes, KAN Woodruff Key, P16 pillow block and B24473 1"R end yoke

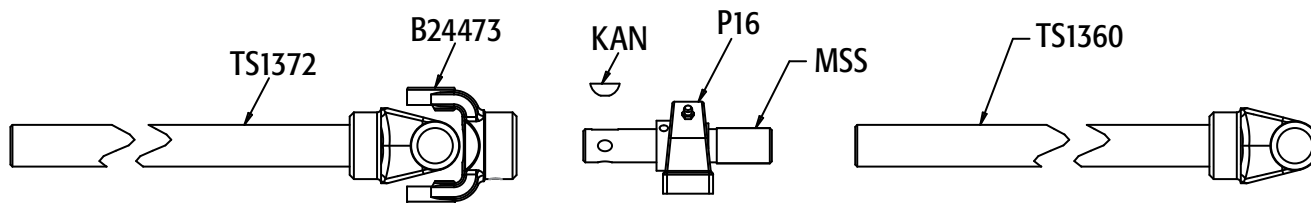

Part No.	Description	Wt. (lbs.)
MSS	B1310 Midship Stub Shaft for 1-1/4in. x 0.095 in. wall tubing	2.05

JOURNAL ASSEMBLY



NB7A



5153XBA

Part No.	Description	Cap Diameter	Clip Style	Wt. (lbs.)
NB7A	H7 Series U-Joint	15/16"	Inside Lock	0.50
5153XBA	B1310 Series U-Joint	1-1/16"	Outside Lock	1.17

Keys & Hardware

SQUARE KEYS/KEY STOCK



Part No.	Description	Wt. (lbs.)
KS302	3/16" Sq. Key x 2" Long	0.13
KS402	1/4" Sq. Key x 2" Long	0.13
KS404	1/4" Sq. Key x 4" Long	0.13
KS502	5/16" Sq. Key x 2" Long	0.13
KS504	5/16" Sq. Key x 4" Long	0.13
KS602	3/8" Sq. Key x 2" Long	0.13
3010989	1/2" Sq. Key x 2" Long	0.20
KS312	3/16" Sq. x 12" Long	0.13
KS412	1/4" Sq. x 12" Long	0.25
KS512	5/16" Sq. x 12" Long	0.38
KS612	3/8" Sq. x 12" Long	0.50

WOODRUFF KEYS



Part No.	Description	Wt. (lbs.)
K5N	1/8" x 5/8"	0.01
K15N	1/4" x 1"	0.02
K18N	1/4" x 1-1/8"	0.03
K24N	1/4" x 1-1/2"	0.05
KAN	1/4" x 7/8"	0.02
KBN	5/16" x 1"	0.03
KCN	5/16" x 1-1/8"	0.04

STEP KEYS



Part No.	Description	Wt. (lbs.)
KS4512	1/4" x 5/16" x 12"	0.25
KS5612	5/16" x 3/8" x 12"	0.35

SQUARE HEAD SET SCREW CAP POINT

- Sold in multiples of 100



Part No.	Description	Wt. (lbs.)
34	3/8"-16 Thd. x 3/4" (3/32" Dia. Hole)	0.03
14	1/4"-20 x 3/4" NC (No Hole)	0.01

ALLEN HEAD SET SCREWS

- Sold in multiples of 100



Part No.	Description	Wt. (lbs.)
32	3/8"-16 Thd. x 1/2"	0.01
38	3/8"-16 Thd. x 3/8"	0.01



NPT THREAD GREASE FITTINGS

- Sold in multiples of 100



Part No.	Thread Size	Overall Size	Ball Check	Angle	Wt. (lbs.)
800	1/8" NPT	49/64"	Yes	Straight	0.01
815	1/8" NPT	1-1/4"	Yes	Straight	0.03
851	1/8" NPT	7/8"	Yes	45°	0.02
852	1/8" NPT	29/32"	Yes	67-1/2°	0.02
853	1/8" NPT	7/8"	Yes	90°	0.02
900	1/4" NPT	1/4"	Yes	Straight	0.03

1/4"-28 TAPER THREAD GREASE FITTINGS

- Sold in multiples of 100



Part No.	Thread Size	Overall Size	Ball Check	Angle	Wt. (lbs.)
400	1/4"-28	39/64"	Short	Straight	0.01
450	1/4"-28	29/32"	Short	45°	0.02
455	1/4"-28	5/16"	Short	90°	0.02

DRIVE-IN GREASE FITTINGS

- Sold in multiples of 100



Part No.	Hole Size	Overall Size	Ball Check	Angle	Wt. (lbs.)
500	5/16"	5/8"	–	Straight	0.01
511	3/16"	5/8"	–	Straight	0.01
515	1/4"	5/8"	–	Straight	0.01

Pillow Blocks

PRECISION GROUND PILLOW BLOCK - ECCENTRIC LOCKING COLLAR STYLE

- Self-aligning, replaceable bearings are produced with eccentric locking collars which allow for higher RPM & provide longer life
- wSP suffix means grease fitting in bottom of housing in lieu of standard

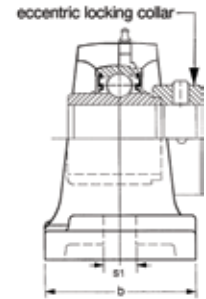
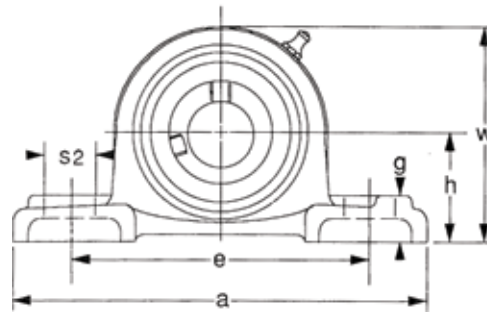

Part No.	Shaft Dia	H	A	E	B	S1	S2	G	W	Bolt Used	Wt. (lbs.)
P12	3/4"	1-5/16"	5"	3-3/4"	1-1/2"	1/2"	3/4"	19/32"	2-31/64"	3/8"	1.15
P12SP	3/4"	1-5/16"	5"	3-3/4"	1-1/2"	1/2"	3/4"	19/32"	2-31/64"	3/8"	1.15
P14	7/8"	1-7/16"	5-1/2"	4-1/8"	1-1/2"	1/2"	3/4"	19/32"	2-25/32"	3/8"	1.90
P15	15/16"	1-7/16"	5-1/2"	4-1/8"	1-1/2"	1/2"	3/4"	19/32"	2-25/32"	3/8"	1.90
P16	1"	1-7/16"	5-1/2"	4-1/8"	1-1/2"	1/2"	3/4"	19/32"	2-25/32"	3/8"	1.90
P16SP	1"	1-7/16"	5-1/2"	4-1/8"	1-1/2"	1/2"	3/4"	19/32"	2-25/32"	3/8"	1.90
P18	1-1/8"	1-11/16"	6-1/2"	4-3/4"	1-7/8"	21/32"	13/16"	11/16"	3-5/16"	1/2"	3.25
P20	1-1/4"	1-7/8"	6-9/16"	5"	1-7/8"	21/32"	13/16"	3/4"	3-21/32"	1/2"	4.10
P24	1-1/2"	1-15/16"	7-1/4"	5-13/32"	2-1/8"	21/32"	13/16"	25/32"	3-27/32"	1/2"	4.75

PRECISION GROUND PILLOW BLOCK - SET SCREW STYLE

- Self-aligning, replaceable bearing, with extended inner race, set screw locking

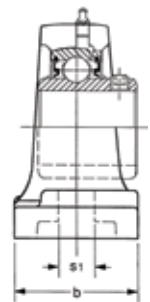
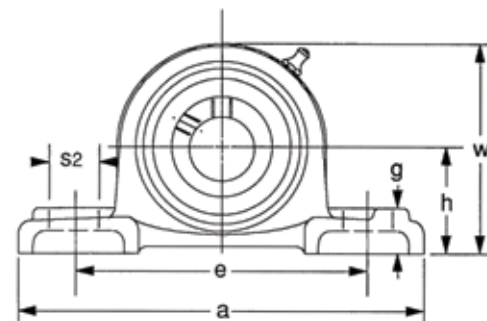

Part No.	Shaft Dia	H	A	E	B	S1	S2	G	W	Bolt Used	Wt. (lbs.)
P16SCR	1"	1-7/16"	5-1/2"	4-1/8"	1-1/2"	1/2"	3/4"	5/8"	2-25/32"	3/8"	1.9
P18HEX	1-1/8 Hex	1-7/8"	6-9/16"	5"	1-7/8"	21/32"	13/16"	3/4"	3-21/32"	1/2"	3.65



BRONZE BEARING PILLOW BLOCK

- Self-aligning



Part No.	Description	Overall Height	Overall Width	Bolt Hole Center to Center	Wt. (lbs.)
BF16G	1" Pillow Block	2.25	4.63	3.375	0.70

SPREADER AND JACKSHAFT BEARING

- Cast iron housing for use on spreaders, wreckers & similar type applications

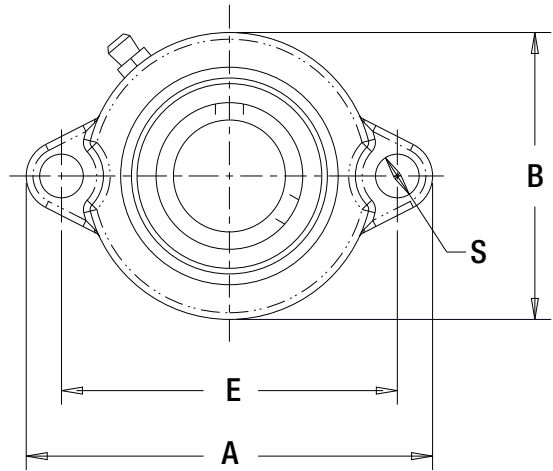

Part No.	Description	Bore	A	B	E	S	Wt. (lbs.)
2FS16	2 Hole Mount Bearing	1"	3-3/4"	3"	2-25/32"	25/64"	0.9

Flange Bearings

2 HOLE ECCENTRIC LOCKING COLLAR STYLE OR SET SCREW FLANGE UNITS

- These quality flange units are produced with self-aligning replaceable bearings and an eccentric locking collar

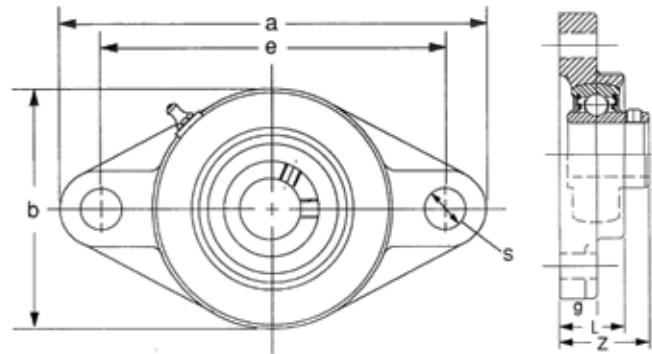

PART NO.	SHAFT DIA.	A	E	G	L	S	B	Z	BOLT USED	Wt. (lbs.)
LOCK COLLAR STYLE										
2F12	3/4"	4-13/32"	3-17/32"	7/16"	1-5/32"	13/32"	2-3/8"	1-25/32"	3/8"	1.20
2F16	1"	4-7/8"	3-57/64"	17/32"	1-7/32"	1/2"	2-3/4"	1-27/32"	3/8"	2.00
2F20	1-1/4"	6-1/8"	5-1/8"	9/16"	1-7/16"	35/64"	3-3/4"	2-1/8"	7/16"	3.40
SET SCREW STYLE										
2F12SCR	3/4"	4-7/16"	3-35/64"	7/16"	1"	15/32"	2-3/8"	15/16"	3/8"	1.20
2F16SCR	1"	5-1/8"	3-57/64"	1/2"	1-1/16"	5/8"	2-11/16"	1-13/32"	1/2"	1.40
2F18SCR	1-1/8"	5-13/16"	4-39/64"	1/2"	1-7/32"	5/8"	3-5/32"	1-19/32"	1/2"	2.00
2F20SCR	1-1/4"	5-13/16"	4-39/64"	1/2"	1-7/32"	5/8"	3-5/32"	1-19/32"	1/2"	2.00
2F24SCR	1-1/2"	6-7/8"	5-43/64"	9/16"	1-13/32"	5/8"	3-15/16"	2-1/32"	1/2"	3.50
2F14SCRHEX	7/8" Hex	5-1/8"	3-7/8"	17/32"	1-1/16"	5/8"	2-44/64"	1-7/16"	1/2"	1.30

4 HOLE ECCENTRIC LOCKING COLLAR STYLE OR SET SCREW FLANGE UNITS

- These quality flange units are produced with self-aligning replaceable bearings and an eccentric locking collar

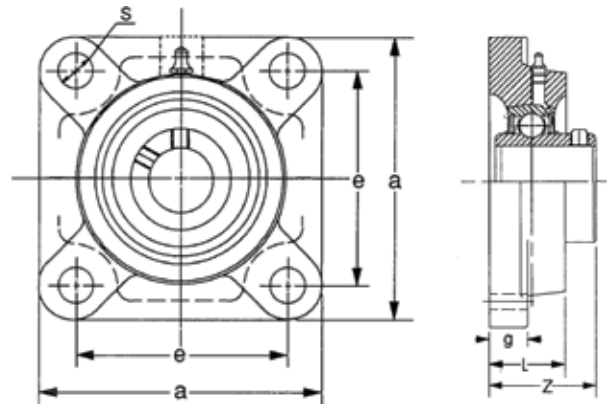

PART NO.	SHAFT DIA.	A	E	G	L	S	Z	BOLT USED	Wt. (lbs.)
LOCK COLLAR STYLE									
4F16	1"	3-3/4"	2-3/4"	7/16"	1-3/8"	29/64"	1-57/64"	3/8"	2.15
4F20	1-1/4"	4-5/8"	3-5/8"	1/2"	1-1/2"	33/64"	2-5/32"	7/16"	4.00
4F24	1-1/2"	5-1/8"	4"	5/8"	1-5/8"	35/64"	2-11/32"	1/2"	4.75
SET SCREW STYLE									
4F12SCR	3/4"	3-3/8"	2-33/64"	15/32"	1"	15/32"	1-5/16"	3/8"	1.40 lbs.
4F16SCR	1"	3-3/4"	2-3/4"	9/16"	11/16"	15/32"	1-13/32"	3/8"	1.80 lbs.
4F20SCR	1-1/4"	4-1/4"	3-17/64"	9/16"	17/32"	15/32"	1-19/32"	3/8"	2.40 lbs.
4F24SCR	1-1/2"	5-1/8"	4-1/64"	5/8"	1-13/32"	5/8"	2-1/32"	1/2"	4.20 lbs.
4F28SCR	1-3/4"	5-13/32"	4-9/64"	23/32"	1-1/2"	5/8"	2-1/16"	1/2"	5.10 lbs.
4F30SCR	1-15/16"	5-5/8"	4-3/8"	23/32"	1-9/16"	5/8"	2-5/32"	1/2"	5.80 lbs.
4F32SCR	2"	6-3/8"	5-1/8"	25/32"	1-11/16"	3/4"	2-5/16"	5/8"	7.50 lbs.



Retail Showroom Displays



Truck Tool Box Displays

482

Lighting Displays

483 - 484

Lighting Countermats

485

Towing Display

486

Truck Tool Box Displays

Contact your Buyers Products sales representative and/or log into your buyersproducts.com account for additional details

TRAILER TONGUE DISPLAY STAND



- Works with all Buyers Products Trailer Tongue Tool Boxes
- Not intended for use as a retail selling shelf fixture



Part No.	Description
3047012	Trailer Tongue Display Stand

UNDERBODY TRUCK TOOL BOX DISPLAY STAND



- Works with all Buyers Products 18x18x36 Underbody Truck boxes
- Not intended for use as a retail selling shelf fixture



Part No.	Description
99170	Underbody Truck Tool Box Display Stand

CROSSOVER AND GULL WING DISPLAY STAND



- Works with Buyers Products Crossover and Gull Wings truck tool boxes that are 18x20x71
- Not intended for use as a retail selling shelf fixture



Part No.	Description
3052089	Crossover and Gull Wing Display Stand



Contact your Buyers Products sales representative and/or log into your buyersproducts.com account for additional details

DOT LIGHTING DISPLAY



- Products shown: 5624156, 5624150, 5623414, 5627524, 5622150, 5622522, 5626553, 5626156, 5626550

Part No.	Description
3047422	DOT Lighting Display

DOT LIGHTING DISPLAY



- Products shown: 5624132, 5624130, 5623414, 5627524, 5622154, 5622526, 5626432, 5626132, 5626130

Part No.	Description
3047423	DOT Lighting Display

WARNING LIGHTS DISPLAY



- Products shown: 8892230, 8892242, 8892200, 8891900, 8892800, 8892400, 8892102, 8890302, 5624432, 5626432

Part No.	Description
3047424	Warning Lights Display with Converter

WORK LIGHTS DISPLAY



- Products shown: 1492290, 1492115, 1492113, 1492135

Part No.	Description
3037650	Work Lights Display for Counter Top

Lighting Displays

Contact your Buyers Products sales representative and/or log into your buyersproducts.com account for additional details

MINI LIGHT BARS DISPLAY



- Products shown: 8891042, 8891060

Part No.	Description
3050254	Mini Light Bars Display with, 8891042 and 8891060

LOW PROFILE LED SAM® PLOW LIGHT COUNTER DISPLAY



Part No.	Description
3044830	Low Profile LED SAM Plow Light Counter Display

LED SAM® PLOW LIGHT COUNTER DISPLAY



Part No.	Description
3044831	LED SAM Plow Light Counter Display

LED SAM® PLOW LIGHT WITH MULTI-MOUNT SIGNAL COUNTER DISPLAY



Part No.	Description
3052069	LED SAM Plow Light with Multi-Mount Signal Counter Display



Towing Display

Contact your Buyers Products sales representative and/or log into your buyersproducts.com account for additional details

DISPLAY RACK FOR BALL MOUNT HITCHES, PINTLE HOOKS & RECEIVER ADAPTERS



- Can accommodate a variety of 2, 2-1/2, and 3 Inch Ball Mount Hitches, Pintle Hooks & Receiver Adapters.
- Product Not included

Part No.	Description
3055695	46 in. Display Rack for Ball Mount Hitches, Pintle Hooks & Receiver Adapters

DISPLAY RACK FOR 2 INCH RECEIVER PRODUCTS



- Holds 14 2 in. receiver products
- Product not included

Part No.	Description
3006316	Display Rack for 2 Inch Receiver Products



AISI: American Iron and Steel Institute

BHN: Brinell Hardness Number - commonly used to define the hardness of materials like metals and alloys by measuring the force needed to cause an indentation.

CA13 rating: specifies minimum brightness for amber colored lights

DOT: Department of Transportation - the agency dealing with regulations concerning both the manufacture and operation of motor vehicles and equipment

FMVSS 108: Federal Motor Vehicle Safety Standard regulating all type, location, and performance requirements for automotive lighting, signaling and reflective devices

FMVSS 571.106: DOT specs for air push lock fittings on mobile applications

FP: Female pipe

FSD: Full scale deflection

GPM: Gallons per minute

HDPE: High Density Polyethylene

HG: Inches of Mercury - vacuum

HRPO: Hot rolled, Pickled and oiled pertaining to steel treatment

ICC: Interstate Commerce Commission - the former federal agency that regulated requirements for motor carriers

JIC: Joint Industry Committee - the organization set up to standardize hydraulic fitting specifications and symbols

LED: Light Emitting Diode – two-lead semiconductor light source that emits light when activated

Lumens: A measure of brightness in which one lumen is equal to the light of a light candle from one foot away

MBS: Minimum Breaking Strength - force required to make the lifting equipment fail or yield, also known as the Minimum Breaking Load (MBL).

MGTW: Maximum Gross Trailer Weight - The largest weight of both trailer and its contents that can be safely towed by a coupling device

MICRON: Micrometer = .001mm or .000039 inch equal to 1 thousandth of a millimeter

MORB: Male O-ring Boss

MP: Male Pipe

MVL: Maximum Vertical Load - The maximum recommended static vertical load (down) that can be applied to a coupling device for safe operation.

NPSF: National Pipe Female Swivel

NPSM: National Pipe Swivel Male

NPT: National Pipe Thread

NPTF: National Pipe Thread Fine

PSI: Pounds per square inch

PTO: Power Take off Option

RPM: Revolutions per minute

SAE: Society of Automotive Engineers – set standards for automotive equipment including lighting and towing

SAE J585: Standards for tail lamps

SAE J845: Standards for optical warning devices for authorized emergency, maintenance and service vehicles

SAE J994: Standards for back-up alarms

SST: Stainless Steel

TFT LCD: Thin-Film-Transistor Liquid-Crystal Display

TPI: Threads per inch

UHMW: Ultra High Molecular Weight – highest density polyethylene

UNC: Unified National course - thread standard for bolts, nuts and fasteners fine thread

UNF: Unified National Fine - thread standard for bolts, nuts and fasteners

VDC: Voltage Direct Current - measurement in a DC system

WLL: Working Load Limit - maximum working load designed by the manufacturer

WOG: Water, oil and gas

Glossary

Class 1: Warning lights are the brightest and primarily reserved for emergency vehicles or other vehicles that may need to demand right of way, warn of an emergency situation or work highly trafficked roadways

Class 2: Warning lights are geared for utility trucks that could be on or off road, but need to provide a significant level of movement notification

SAE J845 and J595: Professional, industry standards for warning lights. Include guidelines for flash timing, photometry, color and environmental requirements (SAE J845 applies to 360 degree beacons and lightbars; SAE J595 applies to directional lights)

California Title 13: State of California has additional requirements that apply specifically to warning lights

PC Rated: Light beam emitted spread out 90 degrees to either side of its centerline for a total of 180 degrees of coverage

IP Rating (Ingress Protection): A two-digit number that follows the code letters "IP" - the first digit represents protection against ingress of solid objects, the second digit represents protection against ingress of liquids. (X represents that protection level was not formally tested for that category). The larger the value of each digit, the greater the protection

ICON DEFINITION



The light beam emitted from this light spreads out 90 degrees to either side of its centerline for a total of 180 degrees of coverage



Ingress protection from solids is rated at a 6 meaning that it allows no ingress of dust. Ingress protection from liquids is rated at a 5 meaning that it has protection against low pressure jets of water



Ingress protection from solids is rated at a 6 meaning that it allows no ingress of dust. Ingress protection from liquids is rated at a 6 meaning that it has protection against high pressure jets of water



Ingress protection from solids is rated at a 6 meaning that it allows no ingress of dust. Ingress protection from liquids is rated at a 7 meaning that it has protection against immersion in water between 15cm to 1m deep for 30 minutes



Ingress protection from solids is rated at a 6 meaning that it allows no ingress of dust. Ingress protection from liquids is rated at an 8 meaning that it has protection against immersion in water under pressure for long periods



Ingress protection from solids is rated at a 6 meaning that it allows no ingress of dust. Ingress protection from liquids is rated at an 9K meaning that it has protection against high pressure and temperature water jets.



Ingress protection from solids has not been formally tested. Ingress protection from liquids is rated at a 6 meaning that it has protection against high pressure jets of water



Ingress protection from solids has not been formally tested. Ingress protection from liquids is rated at an 8 meaning that it has protection against immersion in water under pressure for long periods



Meets the industry standards for warning lights to be rated SAE J595 Class 1



Meets the industry standards for warning lights to be rated SAE J595 Class 2



Meets the industry standards for warning lights to be rated SAE J845 Class 1



Meets the industry standards for warning lights to be rated SAE J845 Class 2



Meets the requirements that apply to warning lights in the state of California



PROConnect™ designates compatible lights; PROConnect™ light models can be mixed and still synchronize flash pattern and phasing



BUYERS PRODUCTS WARRANTY POLICY

(please see below for separate LED lighting policies)

Buyers Products warrants all products and hardware manufactured, and/or distributed by it (except those specified) to be free from defects in material and workmanship for a period of one (1) year from date of shipment. Parts must be properly installed and used under normal conditions. Any product which has been altered, including modification, misuse, accident, or lack of maintenance will not be considered under warranty. Normal wear is excluded. The sole responsibility of Buyers Products under this warranty is limited to repairing or replacing any part or part which are returned, prepaid, and are found to be defective by Buyers Products. Authorization from Buyers Products must be obtained before returning any part. No charges for transportation or labor performed on Buyers' products will be allowed under this warranty.

LED LIGHTING

1-YEAR

Buyers Products Company warranties all **Rotating Beacons**, and **Incandescent products** to the original owner against defects in workmanship and material for a period of one (1) year from the date of purchase unless otherwise specified.

5-YEAR

Buyers Products Company warranties all **LED Strobe**, **LED Strip Lights**, **LED Tube Lights**, and **LED Work Light** products to the original owner against defects in workmanship and material for a period of five (5) years from the date of purchase unless otherwise specified.

LIMITED LIFETIME

Buyers Products Company warranties all **DOT LED Lighting** products to the original owner against defects in workmanship and material for the lifetime of the product unless otherwise specified.

Buyers Products must review each warranty claim and reserves the right to offer a refund for the original sale price of the product or replace the defective light. The one (1) year warranty is non-transferable, applies to the original owner, and is subject to the following terms and conditions. The warranty will be void in cases of misuse, severe abuse, and failure to properly install the light. Breakage of the lens or housing, corrosion at the plug, wire wicking, voltage spikes, and product failure caused by road chemicals and acid type washes are not warrantable claims. This warranty gives you specific legal rights and you may also have other legal rights that vary from state to state.

Index

PART NO.	PAGE NO.	PART NO.	PAGE NO.	PART NO.	PAGE NO.	PART NO.	PAGE NO.
0091050Z.....	109	1308110.....	272	1492161.....	165	1492263.....	164
0091060Z.....	109	1308111.....	272	1492162.....	165	1492290.....	158
0091405H.....	118	1308115.....	272	1492163.....	165	1492300.....	152
0091410H.....	118	1308124.....	272	1492165.....	165	1492301.....	152
0091415H.....	118	1308126.....	272	1492171.....	167	1492302.....	149
01070.....	145	1308128.....	272	1492172.....	167	1492303.....	153
01075.....	145	1308136.....	272	1492182.....	166	1493215.....	150
01076.....	145	1308150.....	272	1492183.....	166	1496505.....	298
01077.....	145	1311100.....	172	1492184.....	166	1501110.....	264
01080.....	145	1311101.....	172	1492185.....	166	1501150.....	264
01090.....	142	1311102.....	172	1492190.....	158	1501153.....	264
01100.....	143	1311103.....	172	1492191.....	161	1501155.....	264
01120.....	143	1311110.....	172	1492193.....	154	1501193.....	264
01130.....	143	1312000.....	170	1492194.....	158	1501250.....	264
01140.....	143	1312100.....	170	1492196.....	158	1501260.....	264
1.....	304	1312200.....	171	1492197.....	155	1501270.....	264
10032.....	78	14.....	476	1492198.....	155	1501310.....	265
10033.....	78	1411000.....	371	1492200.....	148	1501312.....	140, 266
10036.....	72	1492100.....	151	1492201.....	148	1501400.....	265
10039.....	72	1492106.....	161	1492202.....	148	1501410.....	265
10040.....	73	1492107.....	161	1492203.....	148	1501416.....	140, 266
10042.....	73	1492110.....	150	1492215.....	150	1501675.....	265
10044.....	73	1492111.....	150	1492217.....	154	1501680.....	265
10045.....	71	1492112.....	150	1492220.....	157	17006.....	428
10050.....	71	1492113.....	151	1492222.....	156	17008.....	428
10052.....	71	1492114.....	149	1492223.....	155	1701000.....	29
10055.....	71	1492115.....	150	1492225.....	156	1701001.....	29
10057.....	71	1492116.....	150	1492226.....	157	1701005.....	28
102406002.....	326	1492117.....	154	1492227.....	153	1701005B.....	28
11215.....	95	1492118.....	157	1492228.....	160	1701006.....	28
11220.....	95	1492119.....	156	1492230.....	162	1701006B.....	28
11275.....	95	1492125.....	149	1492231.....	162	1701010.....	28
11840H.....	473	1492126.....	149	1492232.....	162	1701010B.....	28
1207R.....	461	1492127.....	151	1492233.....	163	1701011.....	28
1238.....	461	1492128.....	156	1492235.....	159	1701011B.....	28
1304719.....	255	1492129.....	152	1492236.....	153	1701012.....	28
1306070.....	256	1492130.....	149	1492237.....	153	1701015.....	28
1306300.....	256	1492133.....	207	1492238.....	161	1701016.....	28
1306317.....	255, 340	1492134.....	154	1492239.....	152	1701030.....	29
1306505.....	256	1492135.....	159	1492240.....	155	1701031.....	29
1306515.....	256	1492137.....	152	1492242.....	163	1701040.....	29
1306600.....	256, 359, 376	1492138.....	160	1492245.....	163	1701041.....	29
1308103.....	272	1492139.....	160	1492246.....	161	1701052.....	60
1308105.....	272	1492145.....	148	1492260.....	164	1701062.....	61
1308106.....	272	1492146.....	148	1492261.....	164	1701072.....	61
1308107.....	272	1492160.....	165	1492262.....	164	1701077.....	61



PART NO.	PAGE NO.	PART NO.	PAGE NO.	PART NO.	PAGE NO.	PART NO.	PAGE NO.
1701082.....	61	1702311	13	1702940	30	1703900.....	12, 45
1701280.....	55	1702315.....	11	1702940TRAY	30	1704300	11
1701281	55	1702317	11	1702950.....	30	1704303	11
1701283.....	56	1702325.....	11	1702950TRAY	30	1704305	11
1701285.....	55	1702400.....	12	1702960	30	1704310.....	11
1701351	31	1702403.....	12	1702960TRAY	30	1704315.....	11
1701356.....	31	1702405.....	12	1702965.....	16	1704320.....	11, 15
1701361	31	1702410	12	1702980.....	30	1704400	12
1701363.....	31	1702415	12	1702980TRAY	30	1704403	12
1701364.....	31	1702417	12	1702990	30	1704405	12
1701365.....	31	1702425.....	12, 15	1702990TRAY	30	1704410.....	12
1701380.....	55	1702500.....	19	1703000	30	1704415.....	12
1701385.....	55	1702503.....	19	1703000TRAY	30	1704420.....	12, 15
1701551	32	1702505.....	19	1703020.....	30	1704700.....	16
1701556.....	32	1702510	19	1703020TRAY	30	1704703.....	16
1701561	32	1702595.....	17	1703100.....	14	1704705.....	16
1701563.....	32	1702600.....	17	1703103.....	14	1704710.....	16
1701564.....	32	1702603.....	17	1703150.....	14	1704715.....	16
1701565.....	32	1702605.....	17	1703203.....	14	1705100.....	23
1701568.....	32	1702610	17	1703205.....	14	1705101	23
1701578.....	36	1702650.....	18	1703300.....	11, 45	1705102.....	23
1701678	37	1702653.....	18	1703303.....	11, 45	1705103.....	23
1701679.....	55	1702655.....	18	1703304.....	13, 45	1705105.....	23
1701680.....	55	1702660.....	18	1703305.....	11	1705110	23
1701770.....	31	1702700.....	16	1703310.....	11	1705113	23
1702100.....	14	1702703.....	16	1703312.....	11	1705115	23
1702103.....	14	1702705.....	16	1703320.....	11	1705118	23
1702105.....	14	1702710	16	1703321.....	11	1705119	23
1702110	14	1702715.....	16	1703322.....	11	1705120.....	23
1702115	14	1702725.....	16	1703324.....	11	1705125.....	23
1702200.....	14	1702840.....	30	1703326.....	11	1705127	23
1702203.....	14	1702840TRAY	30	1703328.....	11	1705130.....	23
1702205.....	14	1702850.....	30	1703330.....	11	1705133.....	23
1702210.....	14	1702850TRAY	30	1703349.....	11	1705135.....	23
1702215.....	14	1702860.....	30	1703350.....	11	1705140.....	23
1702225.....	26	1702860TRAY	30	1703351.....	13	1705145.....	23
1702230.....	26	1702880.....	30	1703352.....	13	1705147	23
1702235.....	26	1702880TRAY	30	1703353.....	11	1705148.....	23
1702240.....	26	1702890.....	30	1703355.....	13	1705149.....	23
1702250.....	26	1702890TRAY	30	1703400	12, 45	1705150.....	23
1702295.....	11	1702895.....	30	1703403	12	1705153.....	23
1702300.....	11	1702895TRAY	30	1703405.....	12	1705160.....	23
1702303.....	11	1702905.....	12	1703495.....	12	1705163.....	23
1702305.....	11	1702910.....	12	1703700.....	16	1705166.....	23
1702306.....	13	1702920.....	30	1703703.....	16	1705169.....	23
1702310.....	11	1702920TRAY	30	1703705.....	16	1705180.....	57

Index

PART NO.	PAGE NO.	PART NO.	PAGE NO.	PART NO.	PAGE NO.	PART NO.	PAGE NO.
1705181	57	1705515	21	1706505	20	1721351	31
1705182	57	1705520	21	1706510	20	1721356	31
1705183	57	1705580	21	1706515	20	1721361	31
1705200	26	1705585	21	1706960	20	1721363	31
1705201	26	1705640	35	1706963	20	1721364	31
1705203	26	1705641	34	1706965	20	1721365	31
1705205	26	1705650	35	1706970	20	1721551	32
1705210	26	1705651	34	1706975	20	1721556	32
1705215	26	1705660	35	1706980	20	1721561	32
1705280	57	1705795	26	1706985	20	1721563	32
1705281	57	1705800	26	1706990	20	1721564	32
1705282	57	1705803	26	1707020	54	1721565	32
1705283	57	1705805	26	1708310	11	1721568	32
1705284	57	1705810	26	1708410	12	1721578	36
1705285	57	1705815	26	1708710	16	1721678	37
1705286	57	1705825	26	1709410	50	1721770	31
1705295	26	1705833	26	1709415	50	1722351	31
1705300	26	1705835	26	1709420	50	1722356	31
1705303	26	1705840	26	1709425	50	1722361	31
1705305	26	1705845	26	1709430	50	1722363	31
1705310	26	1705850	26	1710410	51	1722364	31
1705315	26	1705895	21	1710413	51	1722365	31
1705325	26	1705900	21	1710420	51	1722410	51
1705333	26	1705903	21	1710423	51	1722413	51
1705335	26	1705905	21	1712110	53	1722420	51
1705340	26	1705910	21	1712120	53	1722423	51
1705345	26	1705915	21	1712200	25	1722551	32
1705350	26	1705920	21	1712205	25	1722556	32
1705381	58	1705925	21	1712210	25	1722561	32
1705384	58	1705930	21	1712230	53	1722563	32
1705395	21	1705931	21	1712240	53	1722564	32
1705401	21	1705933	21	1712250	53	1722565	32
1705403	21	1705935	21	1712255	53	1722568	32
1705405	21	1705940	21	1712260	53	1722578	36
1705410	21	1705945	21	1713005	52	1722678	37
1705415	21	1705950	21	1713015	52	1722770	31
1705420	21	1706400	20	1713025	52	1723005	52
1705425	21	1706403	20	1713030	52	1723015	52
1705430	21	1706405	20	1713035	52	1723025	52
1705431	21	1706410	20	1717100	27	1723030	52
1705433	21	1706415	20	1717105	27	1723035	52
1705435	21	1706420	20	1717110	27	1725100	24
1705440	21	1706425	20	1720410	51	1725101	24
1705445	21	1706430	20	1720413	51	1725103	24
1705450	21	1706500	20	1720420	51	1725105	24
1705510	21	1706503	20	1720423	51	1725110	24



PART NO.	PAGE NO.	PART NO.	PAGE NO.	PART NO.	PAGE NO.	PART NO.	PAGE NO.
1725115	24	1733035	52	1752815	10	1801085	93
1725116	24	1734300	15	1752825	10	1801100	91
1725118	24	1734303	15	1752835	10	1801102	91
1725119	24	1734305	15	1752836	10	1801111	91
1725120	24	1734400	15	1753151	33	1801121	91
1725125	24	1734403	15	1753161	33	1801125	93
1725130	24	1734405	15	1753163	33	1801208A	91
1725133	24	1734500	15	1753168	33	1801214	91
1725135	24	1734503	15	1754800	10	1801215	91
1725140	24	1734505	15	1754803	10	1801220	91
1725145	24	1735100	25	1754805	10	1801226	91
1725147	24	1735101	25	1754807	10	1801301	91
1725148	24	1735103	25	1754809	10	1801310	91
1725149	24	1735105	25	1754811	10	1801401	91
1725150	24	1735110	25	1754814	10	1801500	91
1725153	24	1735115	25	1754817	10	1801505	91
1725160	24	1735116	25	1762600	22	1801510	91
1725640	35	1735119	25	1762603	22	1802000	84
1725641	34	1735120	25	1762606	22	1802005	86
1725650	35	1735125	25	1762609	22	1802007	86
1725651	34	1735130	25	1762621	22	1802010	86
1725660	35	1735133	25	1762624	22	1802015	86
1729410	50	1735135	25	1762627	22	1802020	86
1729415	50	1735140	25	1762630	22	1802025	86
1729420	50	1735145	25	1762639	22	1802026	86
1729425	50	1739410	50	1762642	22	1802027	86
1729430	50	1739415	50	1762645	22	1802028	86
1732300	15	1739420	50	1762648	22	1802050	86
1732303	15	1739425	50	1763103	22	1802055	86
1732305	15	1739430	50	1763106	22	1802056	86
1732310	15	1744124	59	1763124	22	1802061	86
1732315	15	1744136	59	1763127	22	1802130	86
1732320	15	1751651	33	1763142	22	1802131	86
1732400	15	1751661	33	1763145	22	1802134	86
1732403	15	1751663	33	1801050	92	1802135	86
1732405	15	1751668	33	1801050L	92	1802136	86
1732410	15	1752151	33	1801051	92	1802148	86
1732415	15	1752156	33	1801051L	92	1802161	86
1732500	15	1752161	33	1801052	92	1802162	86
1732503	15	1752163	33	1801052L	92	1802167	86
1732505	15	1752168	33	1801053	92	1802168	86
1732510	15	1752799	10	1801055	92	1802175	86
1733005	52	1752800	10	1801059	92	1802200	82
1733015	52	1752803	10	1801060	92	1802202	82
1733025	52	1752805	10	1801060L	92	1802205	82
1733030	52	1752810	10	1801080	93	1802207	82

Index

PART NO.	PAGE NO.	PART NO.	PAGE NO.	PART NO.	PAGE NO.	PART NO.	PAGE NO.
1802208	82	1804005	98	1903060	133	3006636A	120
1802215	83	1804007	98	1903065	133	3006909	92
1802225	84	1804015	98	1903070	133	3007113	330, 464
1802250	82	1804017	98	1903085	133	3008086	46, 302
1802252	82	1804020	136	1903110	142	3008176A	372
1802279	83	1804025	136	19CH545	62, 65, 314, 317	3008209	374
1802280	83	1804035	98	1Z	304	3008210	374
1802500	84	1804040	136	2	304	3008225	372
1802600	85	1804055	97	20	461	3008647	346
1802603	85	1804060	93	2040	122	3008745	66, 327
1802800	85	1804250	97	2050	124	3009095	374
1803005	79	1809025	90	2055	125	3009122	47
1803007	79	1809027A	88	250	460	3009123	47
1803010	79	1809029	88	2F12	480	3009253	340
1803013	79	1809030B	88	2F12SCR	480	3009456	374
1803015	79	1809031A	88	2F16	480	3009457	374
1803017	79	1809035A	88	2F16SCR	480	3009458	374
1803050	80	1809036	88	2F18SCR	480	3009892	374
1803051	80	1809037A	88	2F20	480	3009938	47
1803055	80	1809038A	88	2F20SCR	480	3009988	318
1803056	80	1809039A	88	2F24SCR	480	3010629	340
1803058	80	1809040	88	2FS16	479	3010635	340
1803059	80	1809042	88	2W	304	3010636	340
1803060	81	1809043	88	2Z	304	3010816	299
1803065	81	1809050	89	3	304	3010989	476
1803075	80	1809055	89	3001432	376	3011035	374
1803076	80	1809060A	89	3001894	373	3011036	374
1803090	81	1809061A	89	3001895	373	3011351	375
1803095	81	1809065	89	3002478	76	3011352	375
1803210	83	1809067	89	3002713	62, 314	3011353	375
1803215	83	1809070	90	3002879	296	3011354	375
1803306	79	1809075	89	3002880	296	3011866	349, 351
1803307	79	1809077	89	3003316	73	3011868	349, 351
1803308	79	1809079	88	3004167	295	3011870	360
1803312	79	1809080	88	3004604	60	3011871	360, 376
1803313	79	1809085	89	3005222A	120	3011873	360, 376
1803314	79	1901006	136	3005318	60	3011874	360, 376
1803318	79	1903005	132	3005345	94	3011876	361, 376
1803319	79	1903005LH	132	3005521A	120	3012035	311
1803405	79	1903020	132	3005525A	120	3012781	376
1803410	79	1903030	132	3005528	119, 120	3012783	359, 376
1803415	79	1903035	132	3005534	388	3012784	371
1803454	80	1903040	133	3005833	62, 314	3012786	361
1803456	80	1903045	133	3006073A	120	3013299	373
1803458	80	1903050	142	3006316	486	3013332	321
1804003	98	1903055	142	3006554	268	3013395	374



PART NO.	PAGE NO.	PART NO.	PAGE NO.	PART NO.	PAGE NO.	PART NO.	PAGE NO.
3013396.....	374	3022117.....	374	3028096.....	444	3044831.....	484
3013397.....	374	3022840.....	340	3028786.....	66, 327	3045158.....	92
3013398.....	374	3023432.....	258	3028819.....	266	3045502.....	66
3013531.....	311	3023460.....	66, 327	3029712SS.....	365	3045504.....	66
3013658.....	310	3024136.....	63, 315	3030056.....	174	3045506.....	66
3013872.....	103, 104	3024137.....	63, 315	3030481.....	65	3045508.....	66, 327
3014119.....	254, 358, 376	3024138.....	63, 315	3030564.....	63, 315	3045512.....	66, 327
3014186.....	256, 359, 376	3024139.....	63, 315	3030861.....	417	3045514.....	66, 327
3014187.....	252, 359, 376	3024631.....	175	3030867.....	417	3046249.....	311
3014188.....	252, 359, 376	3024632.....	175	3031043.....	174	3046270.....	311
3014204.....	448, 449	3024633.....	175	3031368.....	63, 315	3046272.....	311
3014214.....	254, 359, 376	3024634.....	175	3031546.....	174	3046364.....	174
3014217.....	359	3024635.....	175	3031692.....	368	3046838.....	311
3014332.....	448, 449	3024636.....	175	3031808.....	368	3046902.....	311
3014333.....	449	3024637.....	175	3032932.....	175	3046909.....	311
3014981.....	100	3024638.....	175	3032933.....	175	3047012.....	482
3015127.....	358, 376	3024639.....	175	3034110.....	165, 167	3047140.....	66
3015603.....	75	3024640.....	175	3034278.....	296	3047422.....	483
3015862.....	331	3024642.....	175	3034279.....	296	3047423.....	483
3015863.....	331	3024646.....	176	3034374.....	174	3047424.....	483
3016004.....	375	3024647.....	176	3034400.....	176	3047804.....	374
3016005.....	374	3024648.....	176, 269	3034842.....	328	3047900.....	485
3016006.....	374	3024649.....	176	3035509.....	277	3047901.....	485
3016342.....	211	3024748.....	373, 376	3035768.....	167	3047902.....	485
3016366.....	268	3024756.....	376	3035770.....	167	3048064.....	208
3016367.....	268	3024912.....	360	3035781.....	166	3048967.....	164
3016368.....	268	3024913.....	360	3035896.....	48, 168	3049352.....	66, 321
3016369.....	268	3024915.....	360, 376	3036319.....	63, 315	3049502.....	353
3016370.....	268	3024916.....	360, 376	3036808.....	299	3049503.....	353
3016371.....	268	3024975.....	277	3036900.....	349, 351	3049504.....	353
3016382.....	268	3025.....	322	3036901.....	349, 351	3049505.....	355
3016383.....	268	3025060.....	60	3037014.....	47	3049506.....	355
3016666.....	354	3025442.....	176	3037014B.....	47	3050254.....	484
3016667.....	354	3025858.....	268	3037650.....	483	3050386.....	303
3018069.....	277	3025859.....	268	3039693.....	92	3050387.....	303
3018091.....	75	3025860.....	268	3039855.....	313	3050389.....	376
3018195.....	100	3025864.....	268	3039990.....	372, 376	3052069.....	484
3018538.....	92	3026115.....	176	3040510.....	353	3052089.....	482
3019101.....	65	3026116.....	176	3040770.....	66, 327	3052380.....	66, 325
3020.....	322	3026457.....	360	3040855.....	174	3053887.....	174
3020293.....	372, 376	3026458.....	360	3042304.....	375	3054626.....	383
3020620.....	84	3026462.....	360	3042509.....	176	3054950.....	351, 353, 361, 376
3020694.....	296	3026538.....	299	3042795.....	374	3055695.....	486
3020695.....	296	3026981.....	174	3042796.....	374	3056416.....	335
3020919.....	359, 376	3027070.....	373	3043331.....	66	3056417.....	335
3022116.....	374	3028095.....	444	3044830.....	484	3056418.....	335

Index

PART NO.	PAGE NO.	PART NO.	PAGE NO.	PART NO.	PAGE NO.	PART NO.	PAGE NO.
3056419.....	335	5201010.....	296	5232216.....	309	5483106.....	138
3059049.....	311	5201012.....	297	5232412.....	310	5483106CC.....	138
3059112.....	311	5201014.....	297	5232417.....	309	5483215.....	137
32.....	476	5201015.....	270	5233000.....	308	5483220.....	137
34.....	476	5201017.....	270	5233000YEL.....	308	5483305.....	137
356.....	460	5201030.....	144	5233001.....	308	5531010.....	262, 263
375.....	460	5201040.....	144	5233612.....	310	5531020.....	262, 263
38.....	476	5201100.....	297	5236586.....	307	5534010.....	262, 263
39LL71.....	62, 65, 314, 317	5201101.....	297	5239012.....	56, 310	5534020.....	262, 263
3W.....	304	5203BBU048.....	452	5239018.....	56, 310	5535000.....	263
3XBSSPU52.....	450	5203BBU060.....	452	5239024.....	56, 310	5540000.....	354
3Z.....	304	5203BBU072.....	452	5391211.....	120	5540001.....	361, 376
4.....	304	5203BBU084.....	452	5401000.....	268	5540002.....	361, 376
400.....	477	5203BBU096.....	452	5404927.....	270	5540003.....	355
400BZ.....	282	5203BBU108.....	452	5404927B.....	270	5540122.....	356, 357, 376
4010.....	323	5203BBU120.....	452	5405427.....	270	5540170.....	356, 357, 376
405BC.....	282	5203BBU132.....	452	5405427B.....	270	5540310.....	356, 357
405BZ.....	282	5203BBU144.....	452	5422010.....	110	5540360.....	356, 357
405SS.....	282	5203BBU156.....	452	5422012.....	110	5540710.....	358, 376
4100.....	456, 460	5203BBU168.....	452	5423203.....	117	5541005.....	356, 357, 376
441466.....	274	5203BBU192.....	452	5431700.....	107	5541006.....	356
450.....	477	5203BBU228.....	452	5431800.....	108	5541020.....	359
455.....	477	5203BBU240.....	452	5431805.....	108	5541065.....	356, 357
4F12SCR.....	480	5203CCU048.....	452	5431905.....	106	5541065 or 5543965.....	376
4F16.....	480	5203CCU060.....	452	5471000.....	96	5541095.....	356, 357
4F16SCR.....	480	5203CCU072.....	452	5471001.....	96	5541095 or 5543095.....	376
4F20.....	480	5203CCU084.....	452	5480005.....	140, 266	5541100.....	358, 376
4F20SCR.....	480	5203CCU096.....	452	5480006.....	140, 266	5541101.....	376
4F24.....	480	5203CCU108.....	452	5480007.....	141, 266	5541895.....	356, 357
4F24SCR.....	480	5203CCU120.....	452	5480008.....	141, 266	5542000.....	365
4F28SCR.....	480	5203CCU132.....	452	5480011.....	145	5542090.....	365
4F30SCR.....	480	5203CCU144.....	452	5480015.....	141, 267	554250120.....	365
4F32SCR.....	480	5204BBU072.....	452	5480017.....	141, 267	554260140.....	365
4W.....	304	5204BBU096.....	452	5480375.....	136	554265150.....	365
4Z.....	304	5206750.....	144	5482030.....	134	554265157.....	365
5.....	304	5230710.....	307	5482031.....	134	554265158.....	365
500.....	477	5230912.....	309	5482100.....	134	554270150.....	365
511.....	477	5230915.....	309	5482105.....	134	554270152.....	365
5121000.....	335	5231112.....	309	5483000.....	139	554270155.....	365
515.....	477	5231130.....	309	5483000CC.....	139	554270156.....	365
5153XBA.....	475	5231212.....	309	5483005.....	139	554275150.....	365
5153XBA.....	474	5231512.....	309	5483005CC.....	139	554275152.....	365
516.....	460	5231515.....	309	5483027.....	139	5543000.....	363
5201000.....	296	5232000.....	308	5483100.....	138	5543006.....	363
5201005.....	270	5232000YEL.....	308	5483105.....	138	5543095.....	356, 357
5201007.....	295	5232001.....	308	5483105CC.....	138	5543800.....	363



PART NO.	PAGE NO.	PART NO.	PAGE NO.	PART NO.	PAGE NO.	PART NO.	PAGE NO.
5543806	363	5549306	353	562133202	48, 168	5622941	48, 168
5543895	356, 357, 376	5549365	353	5621534	232	5623000	233
5543965	356, 357	5549366	353	5621711	219	5623001	233
5544000	349	5549395	353	5621719	219	5623316	233
5544006	349	5549396	353	5621720	219	5623317	233
5544300	349	5601000	258	5621827	48, 168	5623413	214
5544306	349	5601005	258	5621928	48, 168	5623414	214
5544365	349	5601006	259	5622032	232	5623423	214
5544366	349	5601010	258	5622050	215	5623424	214
5544395	349	5601015	246, 376	5622101	215	5623433	214
5544396	349	5601016	246	5622102	215	5623434	214
5544400	351	5601017	246	5622103	218	5623443	214
5544406	351	5601018	246	5622104	218	5623444	214
5544621	363, 376	5601020	246	5622120	48, 168	5623520	233
5544622	363	5601021	246	5622130	232	5623521	233
5545000	349	5601022	246	5622132	232	5623654	48, 168
5545006	349	5601023	246	5622133	232	5623750	218
5545300	349	5601025	246	5622134	232	5623755	48, 168
5545306	349	5601026	246	5622150	215	5623812	218
5545365	349	5601032	246	5622154	215	5623822	218
5545366	349	5601033	246	5622201	215	5623957	48, 168
5545395	349	5601066	259	5622202	215	5624050	220, 221, 222, 227, 229, 230
5545396	349	5601100	259	5622203	218	5624110	220
5546000	349	5601101	259	5622204	218	5624118	222
5546006	349	5601107	258	5622205	218	5624119	222
5546300	349	5601114	259	5622206	218	5624130	221
5546306	349	5609000	234, 237	5622250	215	5624131	221
5546365	349	5609001	235, 237	5622254	215	5624150	220
5546366	349	5613500	100	5622304	218	5624151	220
5546395	349	5620250	215, 216, 217, 218, 233	5622436	48, 168	5624156	220
5546396	349	5620251	221, 224, 225, 227, 229, 230, 231, 232, 233	5622505	216, 217	5624157	220
5547000	349	5620350	220, 221, 222, 223, 224, 225, 227, 228, 233	5622506	216, 217	5624210	227
5547300	349	5620351	233	5622512	216	5624211	227
5547365	349	5620352	220, 223, 227, 233	5622514	216	5624310	229
5547395	349	5620354	233	5622517	217	5624324	230
5548000	353	5620355	220, 222, 223, 225, 233	5622522	216	5624325	230
5548006	353	5621002	48, 168, 252, 272	5622524	216	5624350	229
5548300	353	5621004	220, 221, 222, 227, 229, 230	5622525	216	5624356	229
5548306	353	5621010	233	5622526	217	5624357	229
5548365	353	5621012	233	5622527	217	5624424	201, 221
5548366	353	562109166	48, 168	5622537	48, 168	5624432	202
5548395	353			5622550	216	5624433	160
5548396	353			5622551	217	5624872	48, 168
5549000	353			5622716	218	5624973	48, 168
5549006	353			5622726	218	5625111	226
5549300	353			5622754	233		

Index

PART NO.	PAGE NO.	PART NO.	PAGE NO.	PART NO.	PAGE NO.	PART NO.	PAGE NO.
5625115	225	5626926	202	6203CCU204	453	6451055	442
5625117	226	5627501	214	6241005	420	64570000	437
5625332	232	5627503	214	6381540	424-425	6457000B	437
5625336	169	5627511	214	6381541	424-425	645700C3	437
5625337	169	5627512	214	6381542	424-425	645700H0	437
5625338	169	5627513	214	6381544	424-425	645700P3	437
5625377	48, 168	5627514	214	6381560	424-425	645700P5	437
5625576	169	5627517	214	6381561	424-425	645700P7	437
5626026	202	5627521	214	6381564	424-425	645700RB	437
5626050	222, 223, 224, 225, 227, 228, 230, 231	5627522	214	6383060	426-427	645700RK	437
5626090	48, 168	5627523	214	6383061	426-427	645700RL	437
5626130	224	5627524	214	6383063	426-427	64573500	437
5626131	224	5627527	214	6383064	426-427	64573504	437
5626132	225	5627532	214	6383065	426-427	645735H0	437
5626156	222	5627533	219	6391001	249	645735H4	437
5626157	222	5627534	219	6391002	249	64575500	437
5626191	48, 168	56296144	48, 168	6391003	249	64575502	437
5626206	227	56297145	48, 168	6391004	249	645755H0	437
5626208	228	58R14	337	6391005	257	645755H2	437
5626209	228	58R5SS	337	6391100	251	64580000	437
5626210	228	58R6	337	6391101	249, 251	64580001	437
5626211	228	5910024	58	6391102	251	6458000B	437
5626226	202	5W	304	6391103	251	645800RI	437
5626310	231	5Z	304	6391104	251	65	456, 461
5626311	231	6010	306	6391105	251	651	461
5626324	231	6025	304	6391106	251	66000	328
5626325	231	6035	318	6391204	187	66003	328
5626336	169	6125B	460	6391205	177	66004	328
5626337	169	6138	460	6391206	177	66006	328
5626338	169	6170	460	6391207	186, 187	66010	328
5626356	230	6203BBU048	453	6391208	177, 250	66015	328
5626357	230	6203BBU060	453	6391209	177, 250	66045	328
5626424	201, 224	6203BBU072	453	6391215	251	66050	328
5626432	202	6203BBU084	453	6391308	250, 427	66051	328
5626510	223	6203BBU096	453	6451000	441	66053	127, 328
5626520	225	6203BBU108	453	64510000	436	66054	328
5626521	225	6203BBU120	453	64510002	436	66056	328
5626550	223	6203BBU132	453	6451000M	437	66060	328
5626551	223	6203BBU144	453	6451005	443	66061	328
5626552	223	6203BBU168	453	6451010	442	66063	328
5626553	223	6203BBU216	453	6451025	443	66064	328
5626700	226	6203BBU240	453	6451030	441	66066	328
5626734	226	6203CCU072	453	6451035	443	66067	328
5626738	226	6203CCU084	453	6451040	443	66070	328
5626780	226	6203CCU096	453	6451050	442	66073	328
		6203CCU120	453	6451051	442	66100	329



PART NO.	PAGE NO.	PART NO.	PAGE NO.	PART NO.	PAGE NO.	PART NO.	PAGE NO.
66101.....	329	7432.....	470	8591001.....	277	8890320.....	191
66102.....	329	74323.....	470	8591005.....	277	8890400.....	189
66103.....	329	74373.....	470	8591010.....	277	8890402.....	189
66105.....	329	74393.....	470	8591020.....	277	8890409.....	189
66107.....	329	74443.....	470	8591100.....	282	8890410.....	189
66110.....	329	74481.....	470	8592424.....	277	8890600.....	191
66111.....	329	7452.....	470	8592425.....	277	8890601.....	191
66115.....	329	7453.....	470	8592426.....	277	8890700.....	190
66120.....	329	7463.....	470	8592427.....	277	8890702.....	190
66122.....	329	7493.....	470	8592428.....	277	8890708.....	190
66125.....	329	800.....	477	8597215.....	99, 283	8890709.....	190
66127.....	329	8000SSL.....	62, 314	8597220.....	99, 283	8890929.....	192
66128.....	329	8000SSN.....	62, 314	8620.....	76	8891001.....	213
66129.....	329	815.....	477	8882150.....	245	8891002.....	213
66130.....	329	82123879.....	298	8883000.....	242	8891003.....	213
66135.....	329	82123889.....	298	8883010.....	242	8891004.....	206
66141.....	329	82123899.....	298	8883020.....	242	8891006.....	206
66142.....	329	82123909.....	298	8883030.....	242	8891010.....	183
66150.....	329	82123919.....	298	8883040.....	243	8891015.....	207
66155.....	329	82123929.....	298	8883050.....	243	8891016.....	247
66160.....	329	82123939.....	298	8883053.....	244	8891017.....	247
66170.....	329	82123949.....	298	8883060.....	243	8891018.....	247
70055.....	73	82124269.....	298	8883062.....	244	8891031.....	179
7312.....	471	82124639.....	299	8883101.....	244	8891032.....	179
73122.....	471	82124649.....	299	8883102.....	244	8891039.....	179
73133.....	471	82124659.....	299	8883103.....	244	8891040.....	179
73162.....	471	82124749.....	299	8883104.....	244	8891042.....	179
73163.....	471	851.....	477	8883105.....	244	8891049.....	179
7322.....	471	85104.....	269	8883106.....	244	8891050.....	180
7332.....	471	85141.....	269	8883108.....	244	8891052.....	180
73383.....	471	85142.....	269	8883110.....	245	8891059.....	180
7350038.....	96	85152.....	269	8883116.....	245	8891060.....	180
7381.....	471	85162.....	269	8883132.....	245	8891062.....	180
74103.....	470	85164.....	269	8883165.....	245	8891068.....	180
7412.....	470	85166.....	269	8883182.....	245	8891069.....	180
74123.....	470	85177.....	269	8883210.....	243	8891080.....	182
7413.....	470	852.....	477	8883215.....	245	8891082.....	182
74130107413.....	471	8520.....	71, 72	888CH510.....	65, 317	8891089.....	182
74141.....	470, 472	85204.....	269	8890300.....	191	8891090.....	183
74183.....	470	853.....	477	8890301.....	191	8891091.....	183
7422.....	470	8530.....	73	8890302.....	191	8891092.....	183
74223.....	470	8590017.....	276	8890305.....	191	8891099.....	183
7423.....	470	8590195.....	276	8890306.....	191	8891100.....	183
74263.....	470	8590196.....	276	8890307.....	191	8891102.....	183
74282.....	470	8590245.....	276	8890308.....	191	8891104.....	206
74293.....	470	8591000.....	277	8890310.....	191	8891105.....	206

Index

PART NO.	PAGE NO.	PART NO.	PAGE NO.	PART NO.	PAGE NO.	PART NO.	PAGE NO.
8891109.....	183	8891706.....	197	8892242.....	188	8894050.....	187
8891110.....	182	8891709.....	197	8892243.....	188	8894056.....	187
8891111.....	182	8891710.....	197	8892244.....	188	8894134.....	186
8891119.....	182	8891711.....	197	8892245.....	188	8894142.....	186
8891120.....	205	8891800.....	199	8892248.....	188	8895100.....	184
8891130.....	205	8891829.....	192	8892249.....	188	8895105.....	184
8891131.....	205	8891900.....	194	8892250.....	188	8895115.....	184
8891132.....	205	8891901.....	194	8892255.....	188	8895120.....	184
8891135.....	205	8891902.....	194	8892300.....	193	8895152.....	184
8891144.....	234	8891903.....	194	8892301.....	193	8895153.....	184
8891145.....	234	8891904.....	194	8892320.....	193	8895155.....	184
8891160.....	181	8891910.....	194	8892325.....	193	8895250.....	184
8891161.....	181	8891911.....	194	8892400.....	199	8895301.....	184
8891162.....	181	8891912.....	194	8892401.....	199	8895302.....	184
8891166.....	234	8891913.....	194	8892410.....	199	8895400.....	185, 212
8891167.....	234	8891914.....	194	8892411.....	199	8895404.....	185, 212
8891168.....	234	8891920.....	194, 195	8892412.....	199	8895405.....	184
8891169.....	234	8891925.....	194, 195	8892420.....	199	8895551.....	185
8891170.....	181	8892102.....	195	8892425.....	199	8895553.....	185
8891172.....	181	8892105.....	195	8892426.....	199	8895554.....	185
8891177.....	235	8892106.....	195	8892600.....	195	8895556.....	185
8891178.....	235	8892107.....	195	8892602.....	195	8895560.....	184
8891179.....	181	8892108.....	195	8892620.....	195	8895580.....	184
8891200.....	200	8892109.....	195	8892700.....	198	88CH545.....	62, 63, 64, 65, 314, 315, 316, 317
8891201.....	200	8892140.....	190	8892701.....	198	900.....	477
8891215.....	200	8892141.....	190	8892710.....	198	901BP.....	128
8891216.....	200	8892200.....	189	8892711.....	198	90M.....	320
8891225.....	200	8892201.....	189	8892712.....	198	91050.....	109
8891226.....	200	8892202.....	189	8892800.....	198	91052.....	109
8891227.....	200	8892203.....	189	8892801.....	198	91055.....	109
8891325.....	200	8892204.....	189	8892802.....	198	91058.....	109
8891326.....	200	8892205.....	189	8892810.....	198	91060.....	109
8891327.....	200	8892206.....	189	8892825.....	198	91061.....	109
8891400.....	196	8892207.....	189	8893024.....	174	91065.....	109
8891401.....	196	8892208.....	189	88930243.....	174	91091.....	108
8891402.....	196	8892209.....	189	8893048.....	178	91097.....	108
8891403.....	196	8892210.....	189	8893049.....	174	91205.....	119
8891500.....	197	8892225.....	189	88930492.....	174	91210.....	119
8891501.....	197	8892230.....	188	88930493.....	174	91215.....	119
8891502.....	197	8892231.....	188	8893060.....	174	91220.....	120
8891506.....	197	8892232.....	188	88930603.....	174	91225.....	119
8891600.....	206	8892233.....	188	88930604.....	174	91260.....	120
8891602.....	206	8892234.....	188	88930605.....	174	91261.....	120
8891700.....	197	8892239.....	188	8893148.....	178	91265.....	120
8891701.....	197	8892240.....	188	8894037.....	187	91266.....	120
8891702.....	197	8892241.....	188	8894047.....	187		



PART NO.	PAGE NO.	PART NO.	PAGE NO.	PART NO.	PAGE NO.	PART NO.	PAGE NO.
91269.....	120	B1018LSP.....	280	B2344.....	312	B2414LSP.....	280
91310.....	120	B1018PPB.....	279	B23505LH.....	127	B2418ASBC.....	282
91340.....	120	B1020PPB.....	279	B23505RH.....	127	B2418LSP.....	280
91410.....	118	B117518PPB.....	279	B23506.....	127	B2420LSP.....	280
91415.....	118	B1218LSP.....	280	B23510.....	127	B2423F.....	345
91540.....	106	B1237PPB.....	279	B2351001.....	127	B2423G.....	345
91543.....	106	B1237PPW.....	279	B2351002.....	127	B2423H.....	345
91545.....	106	B1412LSP.....	280	B23510HDG.....	127	B2424SS.....	345
91550.....	106	B16140.....	105	B23515.....	127	B2424YC.....	279
91553.....	106	B16140BK.....	105	B2373C.....	306	B2426E.....	344
91555.....	106	B16140Z.....	105	B2373G.....	306	B2426FS.....	346
91558.....	107	B16145.....	105	B2373J.....	306	B2426FSSL.....	346
91560.....	109	B1812LSP.....	280	B2373K.....	306	B2426FSNB.....	346
91562.....	109	B1820LSP.....	280	B2373R.....	306	B2426SSCL.....	345
91595.....	108	B20.....	130	B2373W.....	306	B2426SSCR.....	345
91600.....	106	B20143.....	105	B2374G.....	306	B2429X.....	345
91610.....	119	B20145.....	105	B2374GZ.....	306	B2430W.....	345
9225.....	146, 371	B2014LSP.....	280	B2392L.....	323	B2430YC.....	279
93500.....	118	B2018LSP.....	280	B2394L.....	323	B2432.....	473
99170.....	482	B2020LSP.....	280	B239911P.....	313	B243331.....	473
A34.....	341	B2024LSP.....	280	B239914AL.....	313	B2436ASBC.....	282
A36.....	341	B2030LSP.....	280	B239916AL.....	313	B2436YC.....	279
A41.....	341	B206301.....	448	B239918AL.....	313	B24473.....	473
AC010.....	444	B206301001.....	448	B239918C.....	313	B2447BZ.....	372
AC010AP.....	440	B206301002.....	448	B239920C.....	313	B2447NHP.....	372
AC010B.....	451	B206301RO.....	448	B239936C.....	313	B2447NHPSS.....	372
AC010B3.....	451	B206305.....	448	B2399A.....	312	B2447WAL.....	372
AC010M.....	444	B206401.....	448	B2399B.....	312	B2448C.....	372
ACC01.....	422, 451	B206401001.....	448	B2399B2C.....	312	B24503.....	473
AFSSP080.....	342	B21.....	130	B2399B6C.....	312	B24533.....	473
AFSSP100.....	342	B210880.....	213	B2399BC.....	313	B24573.....	473
AS1.....	415	B21333.....	473	B2399C.....	312	B248031.....	474
AS301.....	412, 439	B215805.....	325	B2399D.....	312	B2485AA.....	325
AS302.....	412, 439	B215806.....	325	B2399W.....	312	B2487B.....	325
AST215.....	311	B2159C.....	325	B239CZ.....	323	B24LP.....	280
AST460.....	311	B2162FF.....	303	B23SS.....	130	B24LXP.....	281
AST60.....	311	B2162FFZ.....	303	B2401031.....	474	B24PPY.....	278
AST624.....	311	B2162H.....	303	B2402AL.....	131	B24PSRPB.....	278
AST660.....	311	B2162N.....	303	B2408W.....	101	B24PSRPW.....	278
ATVS100.....	300	B22329.....	473	B2408W375.....	101	B24SPP.....	281
ATVS15A.....	300	B22479.....	473	B2408W50.....	101	B24SRP.....	281
B03822SC.....	95	B228357TY.....	474	B2409C.....	96	B2575.....	318
B03835SC.....	95	B23.....	130	B2409W375.....	101	B2586.....	320
B076A.....	102	B23128KX.....	473	B241103.....	473	B2588B.....	304
B08462.....	346, 468	B23128KX.....	474	B241103.....	474	B2588BZ.....	304
B1001.....	273	B23130.....	473	B2412LSP.....	280	B2588W.....	304

Index

PART NO.	PAGE NO.	PART NO.	PAGE NO.	PART NO.	PAGE NO.	PART NO.	PAGE NO.
B2589B	304	B27081/24AZ	330, 464	B27087C	466	B31648SC	95
B2589BZ	304	B27081/26AZ	330, 464	B27087CKT	330, 464	B32F	130
B2589W	304	B27081/26C	330, 464	B27088ANC	466	B33	129
B2590KZ	305, 318	B27081/26D	330, 464	B27088ANF	466	B35P151	407
B2590LH	305, 318	B27081/27AZ	330, 464	B27094A	467	B35P152	407
B2590RH	305, 318	B27081/27BZ	330, 464	B27096A	467	B35P91	407
B2595	318	B27081/27C	330, 464	B27097A	467	B35P92	407
B2595KZ	318	B27081/28AZ	330, 464	B2744A	310	B36LP	280
B2595LKB	318	B270810C	466	B2744S	310	B36LXP	281
B2595SH	318	B27081AZ	466	B2797BPC	307	B36PPY	278
B2596	318	B27081AZKT	330, 464	B2797SS	307	B36PSRPB	278
B2596KSS	318	B27082A	466	B2797Z	307	B36PSRPW	278
B2596KZ	318	B27082AZ	466	B2799B	102	B36SPP	281
B2596LKB	318	B27082AZKT	330, 464	B2800A	102	B36SRP	281
B2596LKBSS	318	B27083A	466	B2800AB	102	B38	122
B2596SS	318	B27083A14Z	466	B2800AC	102	B38B	122
B2597	305	B27083A14ZKT	330, 464	B2801A	102	B38BF	122
B2598H	319	B27083AZ	466	B284001	335, 336	B38I	122
B2598HU	319	B27083AZKT	330, 464	B28F	131	B38IW	122
B2598LP	319	B27084A	466	B3005874	474	B38R	123
B2598SSC	319	B27084A12	466	B302845048	449	B38RP	128
B2599LH	319	B27084A14Z	466	B302845060	449	B38RZW	123
B2599RH	319	B27084A14ZKT	330, 464	B302845072	449	B38RZY	123
B2600	319	B27084A56ZKT	330, 464	B302845084	449	B38S	123
B2600LK	319	B27084A56ZY	466	B302845096	449	B38SP	131, 306
B2600LKSS	319	B27084AZ	466	B302845108	449	B38W	122
B2600SS	319	B27084AZKT	330, 464	B302845120	449	B38ZW	122
B26996A	467	B27085A	466	B302845132	449	B38ZY	122
B270210EB	465	B27086A14Z	466	B302845144	449	B3940POE783DA	407
B270210EM	465	B27086A38ZKT	330, 464	B302845168	449	B39W	123
B270210HMZ	465	B27086A38ZY	466	B302845180	449	B40	124
B270212KM	465	B27086A56ZKT	330, 464	B302889	449	B4000	273
B27024BM	465	B27086A56ZY	466	B302889M	449	B40002	405
B27026BM	465	B27086ANC	466	B302890	415, 449	B40002DC	405
B27026EB	465	B27086ANCZ	466	B303032	449	B40002DP	405
B27026EM	465	B27086ANF	466	B303034	449	B40002SS	405
B27026M10	465	B27086ANFZ	466	B303035	449	B40003	405
B27027EB	465	B27086ANFZKT	330, 464	B303418F	449	B40003DC	405
B27027EKZ	324	B27086B	466	B303418R	449	B40003DP	405
B27027EM	465	B27086C	465	B30LP	280	B40003SS	405
B27028EB	465	B27086EZ	467	B30LXP	281	B40004	405
B27028EM	465	B27087ANC	466	B30PPY	278	B40004DC	405
B27028LMZ	336, 465	B27087ANF	466	B30PSRPB	278	B40004DP	405
B27081/210C	330, 464	B27087ANFZ	466	B30PSRPW	278	B40004SS	405
B27081/22AZ	330, 464	B27087B	466	B30SPP	281	B40005	405
B27081/23AZ	330, 464	B27087BB	467	B30SRP	281	B40005DC	405



PART NO.	PAGE NO.	PART NO.	PAGE NO.	PART NO.	PAGE NO.	PART NO.	PAGE NO.
B40005DP.....	405	B701SM.....	129	BAV040	440	BH82516	71
B40005SS.....	405	B703	129	BAV050SA.....	332, 443	BH850MM.....	71
B40006.....	405	B705	129	BBEMD6S12.....	410	BHC207Z.....	321
B40006DC.....	405	B801	128	BBEMD8S16.....	410	BHC227Z.....	321
B40006DP.....	405	B801A.....	128	BBT0M25P125S.....	446	BHC801Z.....	321
B40006SS.....	405	B801AK.....	128	BBT0M25P25S.....	446	BHEPS4x5.....	400
B40B45.....	257	B801SS.....	128	BC00M25P125.....	446	BHEPS5x6.....	400
B40BF.....	124	B806735.....	407	BC00M25P25.....	446	BHES4x5.....	400
B40I.....	124	B8978.....	105, 107	BC00M375P25.....	446	BHRPS6x5.....	400
B40LP.....	280	B8979.....	105, 107	BC00M375P375.....	446	BJ31.....	462
B40LXP.....	281	B9000.....	274	BC12914.....	451	BJ52.....	462
B40MP.....	124	B901.....	128	BC2A.....	110	BJ62.....	462
B431616U.....	400	B9021.....	105	BC3AP.....	110	BJ72.....	462
B432020U.....	400	B91382SF.....	474	BC45T24.....	74	BJ82.....	462
B432424U.....	400	B915PPB.....	279	BC4APD.....	110	BKPT809B.....	100
B433232U.....	400	B93234SC.....	95	BCA16180.....	399	BL10.....	339, 396
B434040U.....	400	B93248SC.....	95	BCA20180.....	399	BLHP200.....	84, 87
B4500.....	273	B93272SC.....	95	BCHF1.....	110	BLHP300.....	87
B46.....	124	B95.....	338	BDB12281.....	104	BLHP350.....	87
B46BF.....	124	B9553SF.....	474	BDB1238.....	104	BLHP500.....	84
B46I.....	124	B95W.....	338	BDB12492H.....	104	BM2395AA11.....	326
B48.....	125	B96W.....	338	BDB125015.....	104	BNW015.....	453, 456
B48I.....	125	B98596.....	256	BDB125015W.....	104	BNW016.....	453
B50.....	125	B9909.....	105, 107	BDB12503.....	104	BP100A.....	76
B5055.....	126	B9912.....	105, 107	BDB1385.....	104	BP125A.....	76
B5055I.....	126	B99121.....	105, 107	BDB13850Z.....	104	BP141624.....	45
B50BF.....	125, 126	BA0972.....	248	BDB1394.....	104	BP200.....	76
B50I.....	125	BA1.....	257	BDL253.....	103	BP225.....	77
B51.....	126	BA102.....	248	BDS52.....	450	BP242486.....	49
B52.....	126	BA107.....	248	BDS62.....	450	BP242486B.....	49
B52150.....	276	BA52.....	450	BE90M25P125.....	446	BP242486W.....	49
B52169.....	276	BA62.....	450	BE90M25P125S.....	446	BP242496.....	49
B5264.....	273	BASK16.....	412, 439	BE90M25P25.....	446	BP242496B.....	49
B5500.....	273	BASK16P.....	412, 439	BE90M25P25S.....	446	BP242496W.....	49
B5540.....	273	BAV010.....	332, 441	BE90M375P25.....	446	BP760A.....	77
B56734BLK.....	103	BAV015.....	332, 441	BE90M375P25S.....	446	BP824624.....	40
B575A.....	324	BAV01502.....	334, 442	BE90M375P375S.....	446	BP824624B.....	41
B575CZ.....	324	BAV020.....	332, 441	BEC061A.....	386	BP824624W.....	41
B575GZ.....	324	BAV02002.....	334, 442	BEC061AB.....	386	BP825524.....	38
B5760.....	273	BAV020FG.....	440	BFE16G.....	479	BP826224.....	38
B5800.....	273	BAV020T.....	440	BH152516.....	71	BP826254.....	44
B5801.....	273	BAV020TD.....	440	BH2395AA11.....	326	BP826524.....	38
B6000L.....	273	BAV021T.....	440	BH36SF10.....	380	BP826524B.....	39
B601.....	128	BAV030.....	438	BH36SF25.....	380	BP826524W.....	39
B63322.....	255	BAV030B.....	438	BH81780.....	71	BP826554.....	44
B659KB.....	461	BAV030C.....	438	BH82000.....	71	BP827024.....	38

Index

PART NO.	PAGE NO.	PART NO.	PAGE NO.	PART NO.	PAGE NO.	PART NO.	PAGE NO.
BP827054	44	BRE72S	463	BTS072018	344	CB50PB	254
BP855524B	39	BRE82F	462	BTS093018	344	CB60	254, 358, 376
BP855524BSST	39	BRE82M	463	BTS123025	344	CB60PB	254
BP855524W	39	BRE82S	463	BTS124025	344	CB80PB	254
BP855548B	44	BRT0M25P125	446	BTSS123025	344	CB90PB	254
BP855548W	44	BRT0M25P125S	446	BTSS124025	344	CC400	268
BP855924	40	BSC3835	95	BTT	450	CC600	268
BP855924B	41	BSC3842	95	BUC0P25	446	CC800	268
BP855924BSST	41	BSGD2030	279	BUC0P375	446	CCD0714	331
BP855924W	41	BSGD2424	279	BUT0P25	446	CCD0714SS	331
BP880	77	BSGD2430	279	BUT0P375	446	CCD0815	331
BP925824	38	BSGD2436	279	BV100CYL	416	CCD0815SS	331
BP925824B	39	BSGS2018	279	BV160CYL	416	CCD1314	331
BP925824W	39	BSGS2424	279	BV203	416	CCD1415	331
BP964824	43	BSGS2430	279	BV20344P	416	CCD1415SS	331
BP964824B	43	BSGS2436	279	BV203PB	416	CDC01Z	65, 317
BP964824BLL	43	BSSPU52	450	BV204	416	CH101115	409
BP964824P	43	BSSPU62	450	BV204PB	416	CH101120	409
BP964824W	43	BSV3552	459	BV204PR	416	CH102115CCW	409
BP964824WLL	43	BSW050	443	BV204PRPB	416	CH102115CW	409
BP965724	42	BSW90030	252	BV303035	416, 449	CH102120CCW	409
BP965724B	42	BTA52	450	BV303036	416, 449	CH102120CW	409
BP965724W	42	BTA62	450	BV403	416	CH510	62, 314
BPT	458	BTB030	336	BV403PB	416	CH545	62, 63, 64, 65, 314, 315, 316, 317
BPTSG	458	BTD	450	BV404	416	CL375	338
BPU	458	BTL020B2	335	BV404PR	416	CM002P	414
BPU102DMCCW	458	BTL030B2	335	C1010	408	CM004P	414
BPU102DMCW	458	BTL030B656	335	C1010AS	408	CM004PH	414
BPUGD	458	BTL030M2	335	C1010DMCCW	408	CM012P	414
BPUGDMCCW	459	BTN011	146, 346, 468	C1010DMCCWAS	408	CM014P	414
BPUGDMCW	459	BTN011CPK	146, 346, 468	C1010DMCW	408	CM032P	414
BQ52105	451	BTN011WR	146, 346, 468	C1010DMCWAS	408	CM034P	414
BQ62106	451	BTN011WRCPK	146, 346, 468	CB100	254	CM042P	414
BRA64000	386	BTN015	146, 346, 468	CB100PB	254	CM044P	414
BRA64500	386	BTN015WR	146, 346, 468	CB120PB	254	CM052P	414
BRE32F	462	BTN055CPK	146, 346, 468	CB150	254, 340	CM062P	414
BRE32M	463	BTN075	146, 346, 468	CB150PB	254	CM072P	414
BRE32S	463	BTN075CPK	146, 346, 468	CB151	254	CM074P	414
BRE52F	462	BTN075WR	146, 346, 468	CB151PB	254	CM082P	414
BRE52M	463	BTN075WRCPK	146, 346, 468	CB200PB	254	CM084P	414
BRE52S	463	BTN145	146, 346, 468	CB201	254	CM092P	414
BRE62F	462	BTN145WR	146, 346, 468	CB201PB	254	CP10	388
BRE62M	463	BTN240	146, 346, 468	CB251PB	254	CP56	388
BRE62S	463	BTN300	146, 346, 468	CB300	254	CP8	388
BRE72F	462	BTS	450	CB30PB	254	CPA10	388
BRE72M	463	BTS062012	344	CB50	254, 358, 376		



PART NO.	PAGE NO.	PART NO.	PAGE NO.	PART NO.	PAGE NO.	PART NO.	PAGE NO.
CPA56	388	DTR5514	367	F600SAE	418	FM0606	406
CPA8	388	DTR6014	367	F800S	418	FM0608	406
CT150RW	233	DTR6016	367	F800SAE	418	FM0808	406
CT151RW	233	DTR6515	367	FA025	389	FM0812	406
D210	274	DTR6518	367	FA038	389	FNE031018034	66, 327
D2120	274	DTR7012	367	FA050	389	FRL12150	444
D232	274	DTR7015	367	FA075	389	FRL14150	444
D26U	274	DTR7015S	367	FA100	389	FS012	389
D312	274	DTR7018	367	FA125	389	FS025	389
D324	274	DTR7018S	367	FA150	389	FS038	389
D412	274	DTR7020	367	FA200	389	FS050	389
D424	274	DTR7021S	367	FBP080	343	FS075	389
D46	274	DTR7022	367	FBP080GF	343	FS100	389
DBV2500	340	DTR7512	367	FBP100GF	343	FS125	389
DBV3500	340	DTR7515	367	FBP120GF	343	FS150	389
DH300	326	DTR7515S	367	FBP150	343	FS200	389
DH304	326	DTR7518	367	FBP150GF	343	FS2797CH	307
DH305	326	DTR7520	367	FDFO25	389	FSP050	342
DH500	327	DTR7520S	367	FDFO38	389	FSP070	342
DH5006	327	DTR8018	367	FDFO50	389	FSP100	342
DH5006SS	327	DTR8022	367	FDFO75	389	FSP120	342
DH500SS	327	DTT	369	FDFO100	389	FSP150	342
DH501	327	DTT5012	369	FDFO125	389	FSP200	342
DH502	327	DTT5511	369	FDFO150	389	FSP260	342
DLFK50A24CCW	397	DTT6014	369	FDFO200	389	FSS070	342
DLFK50CCW	397	DTT6515	369	FDFO250	389	FSS100	342
DLFK50CCW24	397	DTT6518	369	FDFO300	389	FSSW025	389
DLFK50CCW5M	397	DTT7012	369	FDFO400	389	FSSW038	389
DLFK70CCW	397	DTT7015	369	FF0606	406	FSSW050	389
DM0212BF	61	DTT7018	369	FF0608	406	FSSW075	389
DM0212BM	61	DTT7018S	369	FF0808	406	FSSW100	389
DM1212B	61	DTT7512	369	FF0812	406	FSSW125	389
DP100	326	DTT7515	369	FF08FC	406	FSSW150	389
DTB102	370	DTT7518	369	FFD625SS	313	FWD24	101
DTB102A	370	DTT7520	369	FFD626SS	313	FWD32	101
DTB96	370	DTT8018	369	FH000	393	FWD36	101
DTB98A	370	DTT8022	369	FH001	393	G9542	100
DTG	368	E22	390	FH115	393	GPS1	423
DTR	367	E32	390	FH125	393	H101CK	459
DTR1	368	F1200S	418	FH215	394	H102CKCCW	459
DTR4510	263	F1200SAE	418	FH225	394	H102CKCW	459
DTR5012	367	F400B	418	FH315	394	H2136101	411
DTR5014	367	F400S	418	FH325	394	H2136101SAE	411
DTR5508	262, 263	F400SAE	418	FH415	394	H2136121	411
DTR5511	263	F600S	418	FH425	394	H2136121SAE	411
				FH625	393	H2136151	411

Index

PART NO.	PAGE NO.	PART NO.	PAGE NO.	PART NO.	PAGE NO.	PART NO.	PAGE NO.
H2136153.....	411	H3409X16	431	H5315X4X6	433	H9100X4X4	434
H2136171.....	411	H3409X20.....	431	H5315X6	433	H9205X12X8	434
H2136173.....	411	H3409X4	431	H5315X6X4	433	H9205X16X16	434
H2136201	411	H3409X6	431	H5315X6X8	433	H9205X6X4	434
H2136203	411	H3409X8	431	H5315X8	433	H9255X16X16.....	434
H2550	344	H3509X16	431	H5315X8X10.....	433	H9315X10X12.....	434
H3013X013.....	472	H3509X20.....	431	H5315X8X12.....	433	H9315X10X8.....	434
H3069X16	431	H3559X12	432	H5325X10	432	H9315X12X12.....	434
H3069X20.....	431	H3609X12	432	H5325X12	432	H9355X4X4	434
H3069X4	431	H3709X16	432	H5325X6.....	432	H9385X12X12	434
H3109X12X6.....	431	H3709X20.....	432	H5325X8	432	H9385X8X8.....	434
H3109X12X8.....	431	H3759X16.....	432	H5355X6.....	433	H9405X12X12	434
H3109X16X6.....	431	H3759X8	432	H5356X12	433	H9405X16X16	434
H3109X20X16	431	H412538RH.....	344	H5356X8.....	433	H9405X4X4	434
H3109X4X2	431	H412550LH	344	H5405X8X8.....	433	H9405X6X6.....	434
H3109X6X2	431	H412550RH.....	344	H5505X12	433	H9405X6X8.....	434
H3109X6X4	431	H5015X16X12.....	432	H5506X10	433	H9405X8X12	434
H3109X8X2	431	H5015X6X4	432	H5506X12	433	H9406X8X8X8	434
H3109X8X6	431	H5036171	411	H5506X16	433	H9455X24X24	434
H3159X12.....	431	H5036201	411	H5506X4	433	H9515X12X12.....	434
H3159X16.....	431	H5036203.....	411	H5506X6.....	433	H9515X16X16.....	434
H3159X2	431	H5036221	411	H5506X8	433	H9515X6X6	434
H3159X4.....	431	H5036251	411	H5515X10.....	433	H9515X6X8	434
H3159X6.....	431	H5036253.....	411	H5515X12.....	433	HBF12	387
H3159X8	431	H504	410	H5515X6	433	HBF12P	428, 429
H3169X2	431	H5105X10.....	432	H5515X6X8	433	HBF16	387
H3169X4	431	H5105X12.....	432	H5525X8	433	HBF2	387
H3179X12.....	431	H5105X6	432	H5705X6	433	HBF4	387
H3179X16.....	431	H5105X8	432	H5706X8.....	433	HBF6.....	387
H3179X2	431	H5129X6.....	432	H5707X8	433	HBF8	387
H3179X4.....	431	H5134171	410	H5716X6	433	HBV025.....	421
H3179X8.....	431	H5134251	410	H5726X8	433	HBV038.....	421
H3209X12X8	431	H5165X8	432	H5924X10.....	433	HBV050.....	421
H3209X8X6	431	H5205X12	432	H5924X12.....	433	HBV075	421
H3269X10X12.....	431	H5205X12X16.....	432	H5924X6	433	HBV100	421
H3269X10X6	431	H5205X12X8	432	H5924X8	433	HBV125	421
H3269X10X8	431	H5205X16	432	H6134171	410	HBV150	421
H3269X16X16.....	431	H5205X8	432	H6134251	410	HBV200	421
H3269X6X4	431	H5205X8X12	432	H7238X12	432	HBV250	421
H3309X12	431	H5205X8X8	432	H7238X2.....	432	HBV3W038.....	421
H3309X16	431	H5229X12	432	H7238X20.....	432	HBV3W050.....	421
H3309X2	431	H5229X5	432	H7238X4	432	HBV3W075	421
H3309X6	431	H5315X10.....	433	H7238X8	432	HBV3W100	421
H3359X16	431	H5315X12.....	433	H890X20X16	433	HBVS025.....	421
H3359X4	431	H5315X16.....	433	H9100X12X12.....	434	HBVS038.....	421
H3393X393.....	472	H5315X4	433	H9100X16X16.....	434	HBVS050.....	421



PART NO.	PAGE NO.	PART NO.	PAGE NO.	PART NO.	PAGE NO.	PART NO.	PAGE NO.
HBVS075.....	421	HDS36255.....	410	HK1013.....	401	HPGS100.....	413
HBVS100.....	421	HDSSCP025.....	402	HK1113.....	401	HPGS160.....	413
HC095.....	401	HDSSCP038.....	402	HK1213.....	401	HPGS200.....	413
HC100.....	401	HDSSCP050.....	402	HK1313.....	401	HPGS3.....	413
HC125.....	401	HDSSCP100.....	402	HK1413.....	401	HPGS300.....	413
HC130.....	401	HDSSCP125.....	402	HK1513.....	401	HPGS4.....	413
HC150.....	401	HDSSCT025.....	403	HK1713.....	401	HPGS5.....	413
HC155.....	401	HDSSCT031.....	403	HK1813.....	401	HR1250.....	444
HC160.....	401	HDSSCT038.....	403	HK1913.....	401	HRV07516.....	419
HC165.....	401	HDSSCT050.....	403	HK2017.....	401	HRV07518.....	419
HC200.....	401	HFA11015.....	393	HK2117.....	401	HRV10018.....	419
HC205.....	401	HFA11025.....	393	HK2317.....	401	HRV10025.....	419
HC210.....	401	HFA12515.....	393	HK2517.....	401	HSG075.....	388
HC215.....	401	HFA12525.....	393	HK2917.....	401	HSG100.....	388
HC220.....	401	HFA21015.....	394	HK3117.....	401	HSV050.....	419
HC250.....	401	HFA21025.....	394	HK3317.....	401	HSV075.....	419
HC260.....	401	HFA22515.....	394	HK3417.....	401	HSV100.....	419
HC270.....	401	HFA22525.....	394	HK3817.....	401	HSV1C.....	419, 439
HC280.....	401	HFA31015.....	394	HLLG1.....	388	HV020.....	422
HC295.....	401	HFA31025.....	394	HM004P.....	414	HV1030.....	422
HC300.....	401	HFA32525.....	394	HM006P.....	414	HV1030EP.....	423
HC310.....	401	HFA41015.....	394	HM034P.....	414	HV1030EPG.....	423
HC400.....	401	HFA41025.....	394	HM074P.....	414	HV1030LS.....	422
HC410.....	401	HFA42515.....	394	HP10.....	329	HV1030SAE.....	422
HC500.....	401	HFA42525.....	394	HP11.....	329	HV11AG2ED0.....	415
HC600.....	401	HFA51025.....	395	HP12.....	329	HV11AGOOD0.....	415
HCN050.....	400	HFA52525.....	395	HP13.....	329	HV11AG00F0.....	415
HCN075.....	400	HFA61025.....	395	HP16108.....	399	HV11BGOOD0.....	415
HCN100.....	400	HFA91025.....	395	HP16132.....	399	HV13AG2ED0.....	415
HCN125.....	400	HFA92525.....	395	HP16144.....	399	HV13AGOOD0.....	415
HCN150.....	400	HFD075.....	418	HP1660.....	399	HV13PGOOD0.....	415
HCN200.....	400	HFD100.....	418	HP1672.....	399	HV211AAG2ED0.....	415
HCN250.....	400	HFDL075.....	418	HP1696.....	399	HV211AAGOOD0.....	415
HCN300.....	400	HFDL075SAE.....	418	HP545WC.....	87	HV231AAG3ED0.....	415
HCR050.....	419	HGV038.....	421	HP6253WC.....	87	HV231NAG2ECO.....	415
HCR075.....	419	HGV050.....	421	HP6253WCP.....	87	HV233AAG2ED0.....	415
HCV038.....	420	HGV075.....	421	HP6256WC.....	87	HV25.....	416
HCV050.....	420	HGV100.....	421	HP6258WC.....	87	HV25H.....	416
HCV075.....	420	HGV125.....	421	HP625SC.....	87	HV3111AAAG2ED0.....	415
HCV100.....	420	HGV150.....	421	HP630SC.....	87	HV3111AAAGOOD0.....	415
HCVD08.....	420	HGV200.....	421	HP9.....	329	HV3311NAAG2ECO.....	415
HCVD08SAE.....	420	HGV250.....	421	HPGC100.....	413	HV515LS.....	422
HD200125.....	390	HK0509.....	401	HPGCB160.....	413	HV715.....	422
HDCL352.....	451	HK0709.....	401	HPGCB300.....	413	HV715EP.....	423
HDCL362.....	451	HK0809.....	401	HPGP3.....	413	HV715EPG.....	423
HDS36205.....	410	HK0913.....	401	HPGP5.....	413	HV715SAE.....	422

Index

PART NO.	PAGE NO.	PART NO.	PAGE NO.	PART NO.	PAGE NO.	PART NO.	PAGE NO.
HVC020.....	422	K90	438	L883501	64	LL9000	63, 315
HVC1	422	K90C	438	L8855	65, 317	LL90003	63, 315
HVC1030	422	K90D	438	L8915	64, 316	LR1	142
HVC715	422	K90LC	438	LB1	240	LS1665120.....	305
HVE3	417	K90TC	438	LB1SS	240	LS1665144.....	305
HVE334PB.....	417	K90TGC.....	438	LB3163.....	238	LS166545	305
HVE33PB.....	417	KAN.....	476	LB3163ALDT	238	LS166548	305
HVE342PR4PRPB	417	KBN.....	476	LB3163SST	238	LS166554	305
HVE342PRPB.....	417	KCN.....	476	LB3253	238	LS166572.....	305
HVE344PB.....	417	KP20025.....	100	LB3253ALDT	238	LS166590	305
HVE34M	417	KP20031	100	LB3253SST	238	LSV12.....	423
HVE34M3PB.....	417	KP20038.....	100	LB383	237	LT10	291
HVE34PR3PR3PRPB.....	417	KP20050.....	100	LB383ALDT	237	LT12	291
HVE3PB.....	417	KPL200	101	LB383ALSM.....	237	LT13	290
HVE4	417	KS302	476	LB383P	237	LT14	290
HVE42PRPB.....	417	KS312	476	LB383SL.....	237	LT15	293
HVE44	417	KS402	476	LB383SST	237	LT17	293
HVE44PB.....	417	KS404	476	LB384	237	LT18	290
HVE4PB.....	417	KS412.....	476	LB4773SST.....	236	LT19	290
HVE4PR.....	417	KS4512	476	LB5638	135	LT20.....	292, 294
HVE4PRPB.....	417	KS502	476	LB6123.....	239	LT21	290
HVEH20.....	417	KS504	476	LB6123ALDT	239	LT22.....	292
HVEH9.....	417	KS512.....	476	LB6123SST	239	LT23.....	292
HVESB.....	417	KS5612	476	LB6183.....	240	LT24.....	292
HW800S.....	135	KS602	476	LB6183ALDT	240	LT25.....	295
K1010AS.....	440	KS612	476	LB6183SST	240	LT30.....	293
K1010C.....	440	L001.....	336	LB6303SST.....	241, 282	LT32.....	293
K1010FAS.....	440	L001C.....	336	LB6304SST.....	241, 282	LT35.....	295
K1010FAS1.....	440	L1883.....	62, 314	LB6305SST.....	241, 282	LT37.....	295
K1010TAS.....	440	L1980.....	62, 314	LB663	239	LT40	291, 294
K15N	476	L3885	62, 314	LB663SL.....	239	LT44	59, 271, 294
K18N	476	L3885RLS.....	62, 314	LB663SST	239	LT45	294
K24N.....	476	L3890RLS.....	62, 314	LB8133.....	238	LT46.....	294
K5N.....	476	L38RLSCH545	62, 65, 314, 317	LB8443SST.....	236	LT59.....	295
K70C.....	436	L3980	62, 314	LB8445SST.....	236	LW10.....	103
K70DETCLIP.....	436	L8815.....	64, 316	LB8663SST.....	236	LW625.....	103
K70DF.....	436	L8815GO	64, 65, 316, 317	LB8665SST.....	236	LW847.....	103
K70DFD.....	436	L8816.....	65, 317	LDR02A.....	388	M3100.....	255
K70DFNKO	436	L8816R.....	65, 317	LDR04	388	M3200	255
K70FDA.....	436	L881XGO	62, 65, 314, 317	LFK3718.....	397	M3300	255
K80	438	L8825.....	64, 316	LFK3724.....	397	M3400	255
K80D.....	438	L882501	64, 316	LFK5018.....	397	MFBH2375A.....	282
K80DF.....	438	L882502	64, 316	LFK5024.....	397	MFBH2375F.....	282
K80F	438	L8835	64, 316	LFK5024ASMNT	397	MFV2375	282
K85DF.....	438			LL71	62, 314	MSS	472, 475
K85F	438						



PART NO.	PAGE NO.	PART NO.	PAGE NO.	PART NO.	PAGE NO.	PART NO.	PAGE NO.
N1883	62, 314	P16	478	PM87	78	QDWC122	404
N1980	62, 314	P16SCR	478	PM90	78	QDWC16	404
N3885	62, 314	P16SP	478	PPM08	387	QDWC161	404
N3980	62, 314	P18	478	PPM12	387	QDWC162	404
NB7A	475	P18HEX	478	PS15	396	QDWC20	404
NBTOM25P125S	446	P20	478	PS25	396	QDWC201	404
NBTOM25P25S	446	P2000XBN011RA	407	PS2501K	396	QDWC202	404
NC00M25P125	446	P2000XBN013RA	407	PS2575	396	QDWC24	404
NC00M25P25	446	P2000XCNO11RA	407	PSK25	396	QDWC241	404
NC00M375P25	446	P2000XCNO13RA	407	PU303LRS	428	QDWC242	404
NC00M375P375	446	P2000XEN011RA	407	PU303LRSA	428	R109	455
NE90M25P125S	446	P24	478	PU304	430	R21CX06	457
NE90M25P25S	446	P45AC4	74	PU304LR	430	R21CX08	457
NE90M375P25S	446	P45AC4BK	74	PU310	430	R21CX10	457
NE90M375P375S	446	P45AC4K	74	PU310LR	430	R21CX15	457
NRTOM25P125S	446	P45AC4MK	74	PU311	429	R38D6X06	456
NT04100	446	P45AC6	74	PU319	428	R38D6X08	456
NT04250	446	P45AC6BK	74	PU319A	428	R38D6X10	456
NT06100	446	P45AC6K	74	PU319LR	428	R38D6X12	456
NT06500	446	P45AC6MK	74	PU319LRA	428	R38D6X15	456
NT08100	446	P5262	460	PU319LRS	428	R38D6X20	456
NT08500	446	PB10	409	PU319LRSA	428	R38D6X25	456
NTB06100	446	PH10	72	PU3593	429	R38D6X30	456
NUC0P25	446	PH15	73	PU3593A	429	R38DR3X06	456
NUC0P375	446	PH20	73	PU3593LR	429	R38DR3X08	456
NUC0P500	446	PH30	73	PU3593LRA	429	R38DR3X10	456
NUC0P625	446	PH45	73	PU3593LRV	429	R38DR3X12	456
NUC0P750	446	PH50	75	PU5003	429	R38DR3X15	456
NUE90P25	446	PH50AC	75	PU5007	430	R38LL3H0	454
NUE90P375	446	PH50ACMK	75	PU526	430	R38LL5H0	454
NUTOP25	446	PH55	75	PU642	428	R38LL5X12	454
NUTOP375	446	PH55AC	75	PU642A	428	R38LL5X15	454
OP181810	284	PH6	72	PU642LR	428	R38LLR3X10	454
OP18X18	284	PLB11SS	173	PU642LRA	428	RAB038025	334
OP18X18P	284	PLB12SS	173	PU642LRS	428	RAB050038	334
OP18X18R	284	PLB15SS	173	PU642LRSA	428	RAB125075	400
OP242410	284	PLB17SS	173	QDDC121	404	RAB125100	400
OP242415	284	PM1012	78	QDDC161	404	RAB150125	400
OP24X24P	284	PM105	78	QDDC201	404	RAB200125	400
OP24X24R	284	PM107	78	QDDC241	404	RAB200150	400
P11C	70, 71, 72	PM25612	78	QDDP122	404	RB1780	70, 71
P12	478	PM25812	78	QDDP162	404	RB2000	70, 71
P12SP	478	PM3109	78	QDDP202	404	RB2516	70, 71
P14	478	PM812	78	QDWC12	404	RB50MM	70, 71
P15	478	PM84	78	QDWC121	404	RC10L	271

Index

PART NO.	PAGE NO.	PART NO.	PAGE NO.	PART NO.	PAGE NO.	PART NO.	PAGE NO.
RC10S	271	RT255818	97	SG2229	283	SL685ALP	209
RC11S	271	RT25806	97	SH35	66	SL695A	210
RC18PPB	278	RT25806B	97	SH36	66	SL696A	210
RC18PPW	278	RT25808	97	SH36SS	66	SL70AC	204
RC24PPB	278	RT25808B	97	SH675	335	SL70AG	204
RC24PPW	278	RT25810	97	SH675SS	335	SL70AO	204
RC30PPB	278	RT25810B	97	SI1003	391	SLH100	324
RC30PPBLU	278	RT25812	97	SI1253	391	SMC007BK	383
RC30PPR	278	RT25812B	97	SI1503	391	SMC25A	383
RC30PPW	278	RT25814	97	SI2003	391	SMC25AR	383
RC36PPB	278	RT25818	97	SI2503	391	SMC35A	383
RC36PPW	278	RT25818B	97	SK10	339	SMC35AR	383
RC40PPB	278	RT25824	97	SK11	338	SMC50A	383
RC40PPW	278	RT25824B	97	SK12	339	SMC50AR	383
RC8M	271	RT25836	97	SK16	339	SMC70A	383
RL650A	212	RT25836B	97	SL100	324	SMC70AR	383
RLB3812	135	RT25848	97	SL40AR	204	SMR15S	378
RM10	392	RT25848B	97	SL41AR	204	SMR15SF10	378
RM102000	70	RT305808	97	SL42A0	203	SMR15SF25	378
RM10SS	392	RT305812	97	SL42CA	203	SMR15SS	381
RM122516	70	RT305818	97	SL475A	210	SMR15SSF10	381
RM1225E	136	RTA252	98	SL500A	211	SMR15SSF25	381
RM12P	72	RTA2520	99	SL501A	210	SMR15VESS	381
RM5P	72	RTA302	99	SL502A	210	SMR15VESSC	381
RM62000	70	RTA3252	99	SL550ALP	208	SMR25AF10	384
RM62516	70	RTD211218	137	SL551ALP	208	SMR25AF25	384
R05B5X06	457	RVA24	94	SL575ALP	208	SMR25P	385
R05B5X10	457	S48	341	SL576ALP	208	SMR25S	378
R05B5X15	457	S50	341	SL62AB	203	SMR25SF10	378
R09D3.5X06	457	S63	341	SL62AC	203	SMR25SF25	378
R09D3.5X10	457	S65	341	SL62AG	203	SMR30S	379
R09D3.5X15	457	S73	341	SL62A0	203	SMR30SF10	379
RS1	308	SA1	472	SL62CA	203	SMR30SF25	379
RS132715F	139	SA1447WDNH	305	SL62CB	203	SMR30SS	382
RS1SS	308	SA1454WDNH	305	SL62C0	203	SMR30SS10	382
RS2	308	SA3	472	SL62G0	203	SMR30SS25	382
RS2SS	308	SA4	472	SL640ALP	211	SMR30VESS	382
RS2W	308	SAC010B	451	SL645ALP	209	SMR30VESS1	382
RS2Y	308	SAC010M	444	SL647ALP	209	SMR37SQ	379
RS3	308	SBH2	94	SL650A	212	SMR50P	385
RS3SS	308	SC38B	96	SL65A0	204	SMR7S	378
RS3Y	308	SC44B	96	SL65C0	204	SMS005BK	379, 380
RT255806	97	SC50B	96	SL660A	211	SMS50SQ	379
RT255808	97	SC58B	96	SL665A	209	SMS70SQ	380
RT255810	97	SG1501048	311	SL667A	209	SMWLK50ADMCCW	398
RT255812	97	SG2228	283	SL675ALP	209	SMWLK50DMCCW	398



PART NO.	PAGE NO.	PART NO.	PAGE NO.	PART NO.	PAGE NO.	PART NO.	PAGE NO.
SMWLK50PDMCCW	398	TAF001.....	387	TDH7518	369	TGL3410.....	336
SMWLK50PDMCW	398	TAF001A.....	387	TFA005715.....	386	TGL3410HDW.....	336
SMWLK70ADMCCW	398	TC0015	386	TFA005715L.....	386	TGL3410SS	336
SMWLK70ADM CW	398	TC1002	111, 376	TFAN3	386	TGL3410ST	336
SMWLK70DMCCW	398	TC1004	111	TFAN3C.....	386	TGL34BKT.....	336
SMWLK70DMCW.....	398	TC1006	112	TGBE2754.....	337	TGL34BKTF.....	336
SS15.....	341	TC1007.....	112	TGBE3125	337	TGL34BKTSS	336
SS15N	341	TC1007B	117	TGBE3138	337	TGL34CL.....	336
SS16	341	TC1007P	113	TGBE6438.....	337	TGL34CLCS.....	336
SS17.....	341	TC1007Z.....	113	TGC02TFK.....	334	TGL34CLSS.....	336
SS19	341	TC1012.....	111, 376	TGC23508C.....	333, 445	TGL34SB.....	336
SS20	341	TC1046B	117	TGC25006C.....	333, 445	TGL34SBR.....	336
SS21	341	TC1067P	116	TGC25006HM.....	333, 445	TH612714.....	270
SS8	341	TC107.....	117	TGC25006HMK	333, 445	TH9934	270
SSCH025.....	402	TC1077P	116	TGC25006HMKSA ...	333, 445	TL257M.....	248
SSCH038.....	402	TC1244.....	117	TGC25006V.....	333, 445	TL382.....	320
SSCH050.....	402	TC1456	117	TGC25006VK.....	333, 445	TLP100.....	320
SSCH062.....	402	TC1474P	114	TGC25006VKA	333, 445	TLP625	320
SSCH075.....	402	TC1770B	114	TGC25006VSPK.....	333, 445	TLP750	320
SSCH100.....	402	TC1770P	114	TGC25008C.....	333, 445	TNP716625750	103
SSCP038.....	403	TC1774P.....	115	TGC25008HM.....	333, 445	TNP716750100	103
SSCP050.....	403	TC1775P.....	115	TGC25008HMK	333, 445	TR6211518	302
SSCP075.....	403	TC1967P	114	TGC25008HMKSA ...	333, 445	TR6211520.....	302
SSCP100	403	TC2002	111, 376	TGC25008V.....	333, 445	TR6211522.....	302
SSCP125	403	TC2004	111	TGC25008VK.....	333, 445	TR6211524.....	302
SSCT025.....	403	TC2006	112	TGC25008VKSA	333, 445	TR6211588.....	302
SSCT038.....	403	TC2007	112	TGC25008VSPK.....	333, 445	TS15.....	146, 371
SSCT050.....	403	TC2007P	113	TGC32506C.....	333, 445	TS20	146, 371
SSCT062.....	403	TC2007Z	113	TGC32506HM.....	333, 445	TS31	146, 371
SSCT075	403	TC2012.....	111, 376	TGC32506HMK	333, 445	TS41	146, 371
SSCT100	403	TC2061	112	TGC32506HMKSA ...	333, 445	TS9	146, 371
SSCT125	403	TC2064P	114	TGC32506V.....	333, 445	TSA1360.....	475
ST93	142	TC2074P.....	115	TGC32506VK.....	333, 445	TSA1372.....	475
STG1210.....	283	TC2074T.....	115	TGC32506VKSA	333, 445	TSA760	472
SW1000503	391	TC2075P	116	TGC32506VSPK.....	333, 445	TSA772	472
SW1250753	391	TC2076P	116	TGC32508HM.....	333, 445	TSCH025.....	402
SW1501003.....	391	TC2274P.....	116	TGC32508HMK.....	333, 445	TSCH038.....	402
SW2001253	391	TC2967P	114	TGC32508HMKSA ...	333, 445	TSCH050.....	402
SW2001253SS	391	TC3002	376	TGC32508V.....	333, 445	TSCH062.....	402
SW2002003.....	391	TC3012.....	376	TGC32508VK.....	333, 445	TSCH075.....	402
SW3002003.....	391	TCH10H.....	271	TGC32508VKSA	333, 445	TSCP025	402
SW700	252	TCH10V	271	TGC32508VSPK.....	333, 445	TSCP038.....	402
SW710	253, 358, 376	TCH12V	271	TGCAM0001.....	337	TSCP050.....	402
SW900	253, 340	TCH14V	272	TGCAM0002.....	337	TSCP075.....	402
SW911	253	TDH7512	369	TGCAM0003.....	337	TSCP100	402
SW9111.....	253	TDH7515	369	TGCAM0004.....	337	TSCP125	402

Index

PART NO.	PAGE NO.	PART NO.	PAGE NO.	PART NO.	PAGE NO.	PART NO.	PAGE NO.
TSCT025	403	VCGT3100X15	455	WJ211	322		
TSCT038	403	VCGT3100X20	455	WJ212	322		
TSCT050	403	VCGT3100X25	455	WJ213	322		
TSCT062	403	VCGT3100X30	455	WJ215	322		
TSCT075	403	VCGTH0	455	WJ225	321		
TSCT087	403	VCGTX06	455	WJ225R	321		
TSCT100	403	VCGTX10	455	WJ96WCB	322		
TSCT125	403	VCGTX15	455	WLH075600	399		
U1L3FE	393	VCGTX20	455	WLH100120	399		
U1L6FE	393	VCGTX25	455	WLH100600	399		
U3L007	393, 394	VCGTX30	455	WLH10072	399		
U3L3FE	394	VCGTX35	455	WLH10096	399		
U3L6FE	394	VH1	415	WLH125120	399		
U3LWF	392	VSC1	449	WLH125144	399		
U3LWF3	392	VSC2	449	WLH125600	399		
U3LWF4	392	VSC3	449	WLH12572	399		
U5L3FE	395	VSC4	449	WN5811Z	324		
U5L6FE	395	VSK001	448, 461				
U9L3FE	395	VSK040	461				
U9L6FE	395	WC0888	286				
UB623512	302	WC091060	288				
UB623514	302	WC091061	288				
UB623516	46, 302	WC1085H	286				
UB623518	302	WC1086	285				
UB623520	302	WC1086UWH	285				
UB623522	302	WC1087	285				
UB623524	302	WC1088	285				
UR35A	384	WC1267	288				
UR50A	384	WC1467A	286				
UR50MK	380, 384	WC1468A	286				
UR50P	385	WC1588	288				
UR50S	380	WC24483	287				
UR70A	384	WC2556A	286				
UR70S	380	WC35225	287				
UTVS16	300	WC6096A	288				
UWLK50ADMCCW	398	WC6810L	285				
UWLK50ADMCW	398	WC6810LP	285				
UWLK50DMCCW	398	WC7118A	288				
UWLK50DMCW	398	WC796R	286				
UWLK50PDMCCW	398	WC8118	287				
UWLK50PDMCW	398	WC9642Y	287				
UWLK70ADMCCW	398	WCB186	288				
UWLK70DMCCW	398	WJ205	322				
UWLK70DMCW	398	WJ205RO	322				
VCGT3100X06	455	WJ206	322				
VCGT3100X10	455	WJ208	322				





**TRUCK
TOOL
BOXES**



CARGO CONTROL



TOWING



LIGHTING & ELECTRICAL

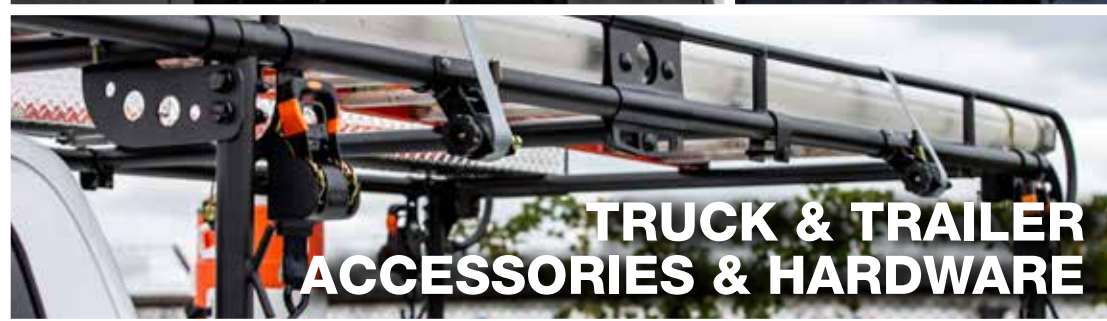

**TRUCK & TRAILER
ACCESSORIES & HARDWARE**



HYDRAULICS



TARP SYSTEMS



**CABLES
& CONTROLS**

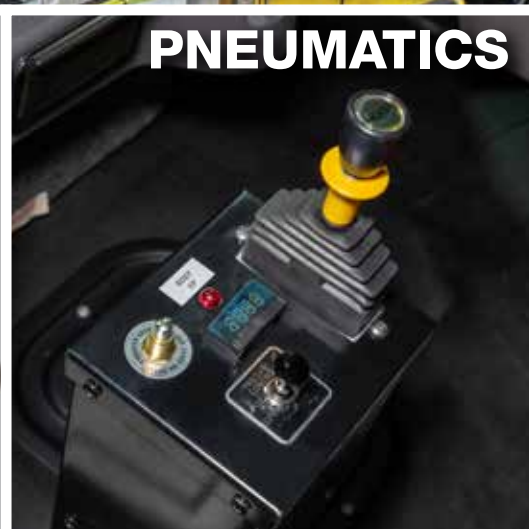

PNEUMATICS



**PTO
DRIVELINE**

**NOTHING
WORKS
LIKE A
DOGG™**

BUYERSPRODUCTS.COM

