



LIGHTING & ELECTRICAL

NEW PRODUCT ADDITIONS SUPPLEMENT
SPRING 2020



NOTHING WORKS LIKE A DOGG[®]

Our History



1946
Buyers Products Company founded by Sam Ruven and Bessie Kleinman as a distributor of driveline components.

Tracom

1992
Buyers acquired Trailer Components Manufacturing (Tracom) for CNC precision machining and tooling, as well as state-of-the-art welding.

Buyers
PRODUCTS COMPANY

2002
Buyers moved its corporate headquarters to a brand new 235,000 sq. ft. state-of-the-art office and distribution center.

SnowDogg
Buyers

2007
Buyers began manufacturing the SnowDogg stainless steel snowplow at our Mentor, Ohio facility.

Buyers
PRODUCTS COMPANY

2013
Buyers acquired an additional 500,000 sq.ft. manufacturing facility in Mentor, Ohio allowing for expansion of our aluminum and stainless steel manufacturing.

SaltDogg
Buyers

**ALL YOUR WORK
TRUCK PRODUCTS
ALL THE TIME.**

2017
Buyers launches new website with business partner portal, to make online ordering and account maintenance easy for customers.

Buyers

Buyers continued to grow its product offerings and build valued relationships with customers and suppliers. Increased demand for products led to the pursuit of supply chain manufacturing solutions.

PROGRESSIVE
POWDER COATING, INC.

1995
Buyers acquired Progressive Powder Coating. Our Nordson automatic powder application booth is used to powder coat our Buyers toolboxes and other truck and trailer accessories.

Romotech
Rotational Molding Technologies, Inc.

2004
Buyers acquired Romotech in New Paris, Indiana. Our Ferry Industries Rotospeed molding machines are used to manufacture our poly salt spreaders.

Boomerang
RUBBER, INC.

2009
Buyers began our operations at Boomerang Rubber, in Botkins, Ohio manufacturing mudflaps, wheel chocks and other rubber truck and trailer accessories.

Buyers
PRODUCTS COMPANY

2016
Buyers establishes a 22,000 sq ft Engineering Tech Center in Mentor, Ohio. It's multi-use lab, design, training and prototyping space is dedicated to the research and development of innovative product.

Our Corporate Family of Companies



Founded in 1946, Buyers Products is a fully integrated manufacturer and a leader in the truck equipment industry. Our engineering, manufacturing and assembly operations take place in the USA, under the Buyers family of companies. **Buyers Products' mission is to improve our Customers' profitability and productivity while enhancing the quality of our products and services.**





WORK LIGHTS 4-5

Flood Lights 4-5

PLOW LIGHTS 6

WARNING LIGHTS 7-13

Strobe Lights 7-8

Light Bar with Hand Held Controller 9

Traffic Advisors 10

Mini Light Bars 11

Micro Beacons 11

Drill-Free Light Bar Mounts 12

LED Strobe Road Flare 13

DOT LIGHTS 14-15

Stop, Turn, Tail and Backup Lights 14

Turn Signal Lights 15

NEW PRODUCTS:

Ultra Bright 3" LED Flood Light

pg. 4



Ultra Bright Flood Light with Heated Lens

pg. 4



LED 48" Light Bar with Wireless Hand Held Remote Control

pg. 14



LED Micro Beacons

pg. 17



Work Lights

Ultra Bright 3" LED Flood Light

5-YEAR
W
12-24
VOLTS
IP
67
IP
69K

Number of LEDs	4
Lumens	2,329 - 3,039
Lead Length	20"
Mount / Base	8mm Stud, SST



Part No.	Color	Amp	Connection	Wt. (lbs.)	Cat.
1492227*	Clear	3.55	Deutsch	1.45	562 (N)

Light adjusts for maximum power depending on temperature.
Available April 2020

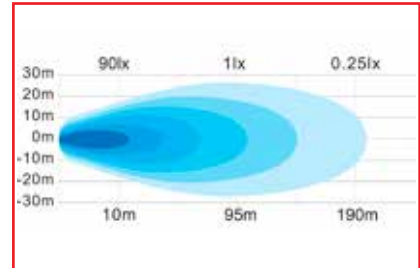
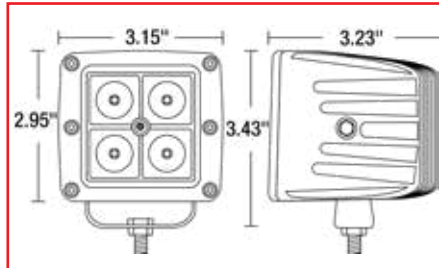

Ultra Bright 4" LED Flood Light with Heated Lens

5-YEAR
W
12-24
VOLTS
IP
67

Number of LEDs	4
Lumens	4,500
Lead Length	7"
Mount / Base	10mm Stud, SST



Part No.	Color	Amp	Connection	Wt. (lbs.)	Cat.
1492198*	Clear	6.6	Blunt Cut	3.31	562 (N)

Heated tempered glass lens helps prevent ice from building up.
Available April 2020

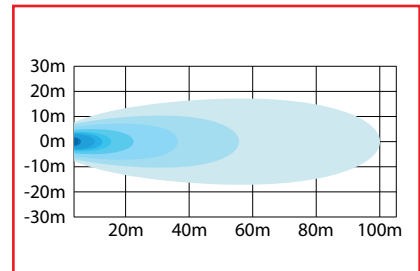
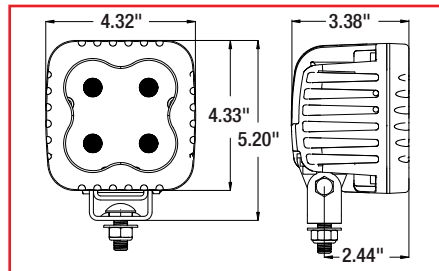

Ultra Bright 4.5" LED Combination Flood / Strobe Light

5-YEAR
W
12-24
VOLTS
IP
67
IP
69K

Number of LEDs	16
Lumens	3,810 - 7,421
Lead Length	20"
Mount / Base	10mm Stud, SST



Part No.	Color	Amp	Connection	Wt. (lbs.)	Cat.
1492230*	Clear - Flood Amber - Strobe	6.67 - Flood 1.33 - Strobe	Deutsch	1.45	562 (N)

Light functions as a bright flood light or a warning strobe light.
Light adjusts for maximum power depending on temperature.
Available April 2020

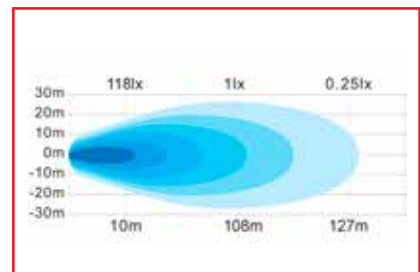
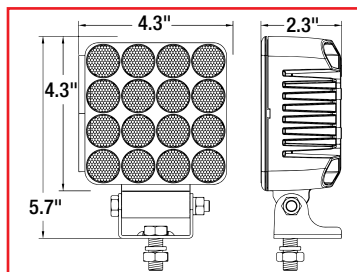

Ultra Bright 8" LED Spot / Flood Light

5-YEAR
W
12-24
VOLTS
IP
67

Number of LEDs	20
Lumens	9,100
Lead Length	20"
Mount / Base	Bracket

Part No.	Color	Amp	Connection	Wt. (lbs.)	Cat.
 1492195*	Clear	5.7	Blunt Cut	4.08	562 (N)

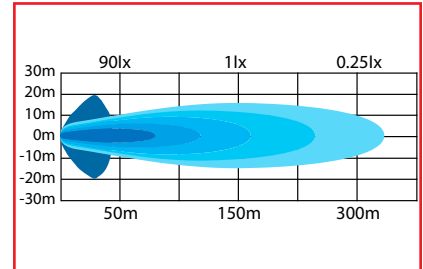
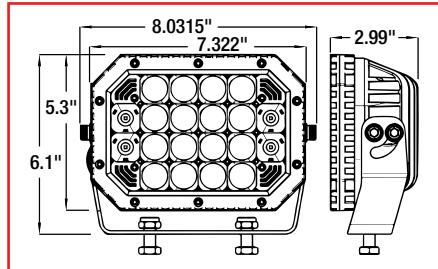

Ultra Bright 7.5" LED Flood Light

5-YEAR
W
12-24
VOLTS
IP
67
IP
69K

Number of LEDs	6
Lumens	2,565 - 2,767
Lead Length	20"
Mount / Base	Recessed

Part No.	Color	Amp	Connection	Wt. (lbs.)	Cat.
 1492228*	Clear	2.18	Deutsch	1.16	562 (N)

Includes angled mounting bracket.

Light adjusts for maximum power depending on temperature.

Available April 2020

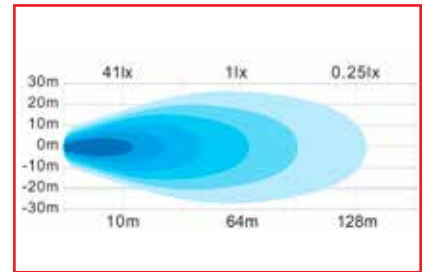
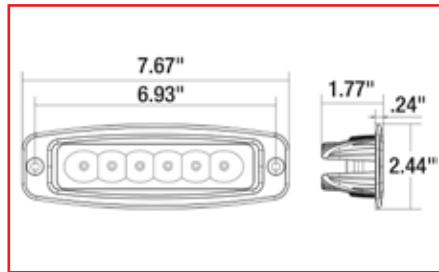

Shown with the included angle bracket

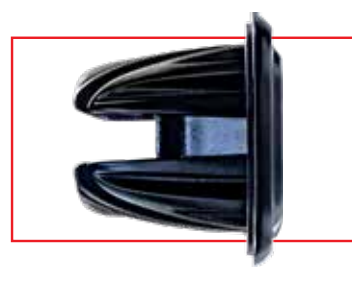

Shown without angle bracket

LED Plow Lights

Low Profile Heated LED Plow Light Kit

12-24 VOLTS	Number of LEDs	15 Clear LEDs
IP 68	Color Temperature	5200K - 5700K
	Connection	19" 6 Pin Deutsch Connector
	Mount	Dual Post Mount
	Housing	Black Powder Coated Aluminum

Part No.	Lumens	Amp	Wt. (lbs.)	Cat.
1312100*	High Beam 3600 lm Low Beam 1800 lm	4.0	12	900 (N)

Heated tempered glass lens helps prevent ice from building up.
Over twice as bright as traditional halogens, with a much longer lifespan.
12V relay may be required (not included), for heated function on certain trucks.

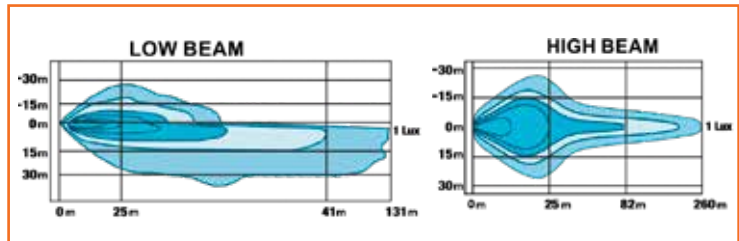
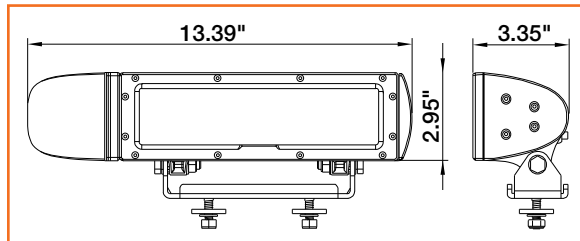

Universal Heated LED Snow Plow Headlights

12-24 VOLTS	Number of LEDs	13 Clear LEDs
IP 65	Color Temperature	5300K - 6000K
	Connection	11" 6 Pin Deutsch Connector
	Mount	Single Post Mount
	Housing	Black Powder Coated Aluminum

Part No.	Lumens	Amp	Wt. (lbs.)	Cat.
1312000*	High Beam 2,500 lm Low Beam 1,200 lm	5.5	9.8	900 (N)

Heated tempered glass lens helps prevent ice from building up.
Over twice as bright as traditional halogens, with a much longer lifespan.
12V relay may be required (not included), for heated function on certain trucks.

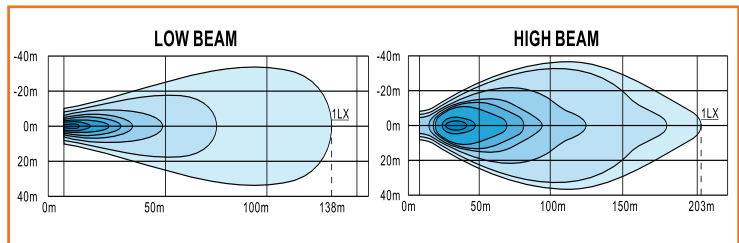
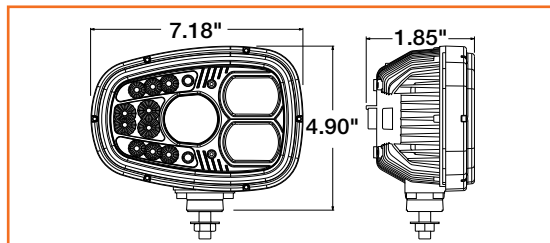

Ultra Thin Dual Row 5" LED Strobe Light



Number of LEDs	12
Housing	Aluminum
Number of Flash Patterns	30
Synchronous	Yes
Alternating	Yes

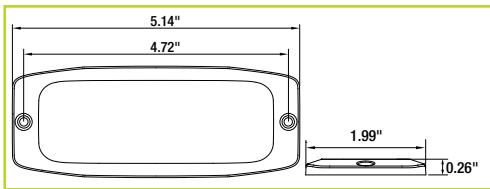

SAE J595 Class 1 Lights



	Part No.	Color	Amp	Wt. (lbs.)	Cat.
	8890400*	Amber	1.5	0.2	889 (N)
	8890401*	Clear	1.5	0.2	889 (N)
	8890403*	Red	1.5	0.2	889 (N)
	8890404*	Blue	1.5	0.2	889 (N)

	Part No.	Color	Amp	Wt. (lbs.)	Cat.
	8890402*	Amber/Clear	1.5	0.2	889 (N)
	8890405*	Red/Blue	1.5	0.2	889 (N)
	8890406*	Amber/Red	1.5	0.2	889 (N)
	8890407*	Clear/Red	1.5	0.2	889 (N)
	8890408*	Amber/Blue	1.5	0.2	889 (N)
	8890409*	Green	1.5	0.2	889 (N)
	8890410*	Amber/Green	1.5	0.2	889 (N)

Thin 4.5" Horizontal Dual Color LED Strobe Light



Number of LEDs	12
Housing	Aluminum
Number of Flash Patterns	28
Synchronous	Yes
Alternating	Yes

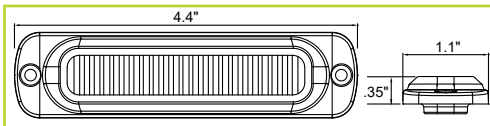

Dual Color SAE J595 Class 1 Lights



	Part No.	Color	Amp	Wt. (lbs.)	Cat.
	8892102*	Clear/Amber	1.0	0.15	889 (N)
	8892105*	Red/Blue	1.0	0.15	889 (N)
	8892106*	Amber/Red	1.0	0.15	889 (N)
	8892107*	Red/Clear	1.0	0.15	889 (N)
	8892108*	Amber/Blue	1.0	0.15	889 (N)
	8892109*	Amber/Green	1.0	0.15	889 (N)

Strobes must be mounted in horizontal orientation to achieve Class 1 rating

Accessories

	Part No.	Description	Wt. (lbs.)	Cat.
	8891920	Chrome Bezel for Thin Mount LED Lights	0.02	889 (N)
	8891921	White PVC Bezel for Thin Mount LED Lights	0.03	889 (N)
	8891925	Black, 90 Degree Mounting Bracket	0.06	889 (N)

Strobe Lights

Ultra Thin Wide Angle 5" LED Strobe Light



Number of LEDs	12
Housing	Aluminum
Synchronous	Yes
Alternating	Yes



8890300

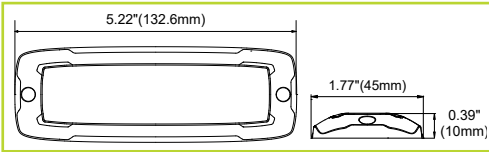

8890320



8890321

Single Color SAE J595 Class 1 Lights

SAE J595 CLASS 1

	Part No.	Color	Amp	Flash	Wt. (lbs.)	Cat.
	8890300*	Amber	0.88	16	0.24	889 (N)
	8890301*	Clear	0.88	16	0.24	889 (N)

Dual Color Lights

	Part No.	Color	Amp	Flash	Wt. (lbs.)	Cat.
	8890302*	Amber/Clear	0.88	26	0.24	889 (N)
	8890305*	Red/Blue	0.88	26	0.24	889 (N)
	8890306*	Amber/Red	0.88	26	0.24	889 (N)
	8890307*	Clear/Red	0.88	26	0.24	889 (N)
	8890308*	Amber/Blue	0.88	26	0.24	889 (N)
	8890310*	Amber/Green	0.88	26	0.24	889 (N)

Accessories

	Part No.	Description	Wt. (lbs.)	Cat.
	8890320*	Chrome Bezel For 8890300 Series Strobe Lights	0.04	889 (N)
	8890321*	White Bezel For 8890300 Series Strobe Lights	0.04	889 (N)

Ultra Thin Wide Angle 4" LED Strobe Light



Number of LEDs	6
Housing	Aluminum
Number of Flash Patterns	16
Synchronous	Yes
Alternating	Yes



8890600

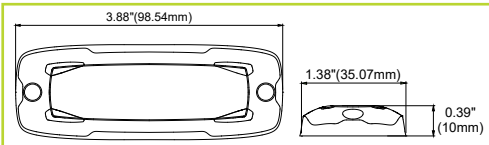

Single Color SAE J595 Class 1 Lights

SAE J595 CLASS 1

	Part No.	Color	Amp	Wt. (lbs.)	Cat.
	8890600*	Amber	0.88	0.18	889 (N)
	8890601*	Clear	0.88	0.18	889 (N)

Available May 2020



LED 48" Wireless Light Bar with Traffic Advisor

**5-YEAR
W
12-24
VOLTS
IP
67**

Number of LEDs	136
Number of Flash Patterns	13
Lead Length	25'
Housing	Aluminum
Mount	Feet and Strap Kit Included

Light features a wireless hand held remote that displays the patterns being used.

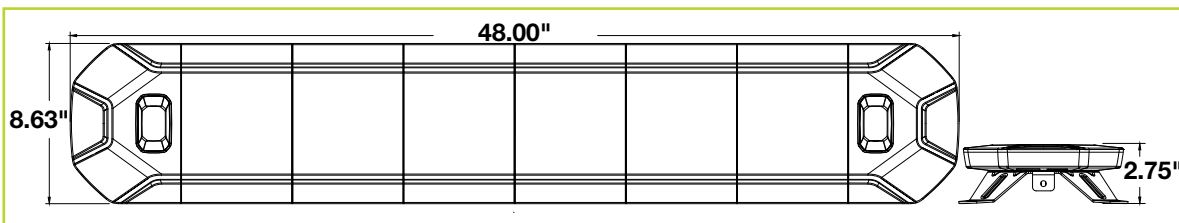

Single Color SAE J845 Class 1 Light Bar

SAE J845
CLASS
1

Part No.	Color	Amp	Wt. (lbs.)	Cat.
8893048*	Amber	11.30	20	889 (N)

Available May 2020



Dual Color SAE J845 Class 1 Light Bar

SAE J845
CLASS
1

Part No.	Color	Amp	Wt. (lbs.)	Cat.
8893148*	Amber/Clear	11.30	20	889 (N)

Available May 2020



Traffic Advisors

LED Traffic Advisor / Strobe with Flood Light



	50 Strobe
Number of Flash Patterns	16 Traffic Arrows
	1 Flood
Color	Amber for Strobe and Traffic Arrows Clear for Flood
Lead Length	25'
Housing	Aluminum
Mount	Rear Angle Mounts Included

Combines an SAE J595 Class 1 strobe, traffic advisor with 16 different arrows, and a bright flood light into a single versatile fixture.



2 LIGHTS IN ONE!



8894142
In Strobe Mode



8894142
In Flood Light Mode



Six switch panel for directional warning lights

LED Traffic Advisor / Strobe / Flood SAE J595 Class 1 Light



Part No.	LEDs	A	B	C	Amp	Wt. (lbs.)	Cat.
8894134*	96 LEDs	33.7"	2.1"	1.25"	3.0	5.5	889 (N)
8894142*	108 LEDs	41.7"	2.1"	1.25"	3.0	6.6	889 (N)

Accessories

Part No.	Description	Wt. (lbs.)	Cat.
6391207	Switch Panel, (4) On/Off, (2) Momentary	0.39	639 (N)



8894134 shown installed on Buyers Kabgard™ 85204

Mini Light Bars and Micro Beacons

15" Octagonal LED Mini Light Bar Series

5-YEAR
W
12-24
VOLTS

Number of LEDs	56
Number of Flash Patterns	10
Lead Length	15' with ON/OFF and Pattern Switch
Mount	Permanent or Magnetic

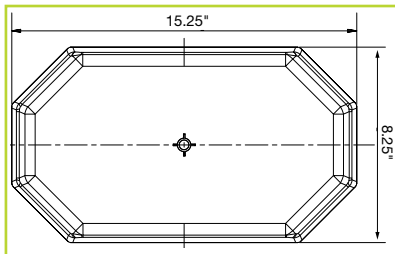

Permanent mounting studs and magnetic mounts



SAE J845
CLASS
1

Single Color SAE J845 Class 1 Light Bar

Part No.	Color	Amp	Wt. (lbs.)	Cat.
8891060	Amber	3.2	5.5	889 (N)



SAE J845
CLASS
1

Dual Color SAE J845 Class 1 Light Bar

Part No.	Color	Amp	Wt. (lbs.)	Cat.
8891062	Amber/Clear	3.2	5.5	889 (N)



SAE J845
CLASS
1

Dual Color SAE J845 Class 1 Light Bar

Part No.	Color	Amp	Wt. (lbs.)	Cat.
8891068*	Amber/Blue	3.2	5.5	889 (N)

LED Micro Beacon

5-YEAR
W
12-24
VOLTS
IP
67
SAE J845
CLASS
2

Number of LEDs	18
Flash	132 Flasher per Minute

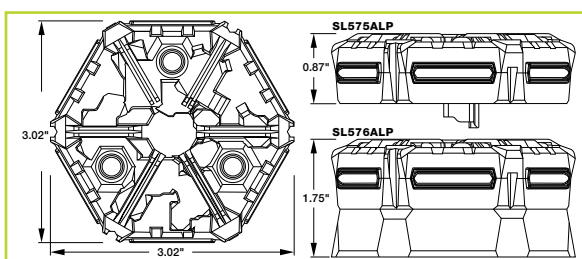

Permanent Mount Beacon

Part No.	Connection	Mounting	Amp	Wt. (lbs.)	Cat.
SL575ALP*	7" Blunt Cut	5 mm Stud	1.3	0.19	889 (N)



Magnetic Mount Beacon

Part No.	Wiring	Mounting	Amp	Wt. (lbs.)	Cat.
SL576ALP*	12.5' Auxiliary Plug	Magnetic	1.3	0.6	889 (N)



Drill-Free Light Bar Mounts

Drill-Free Light Bar Cab Mount

Construction	Rustproof Aluminum
Finish	Black Powder-Coated
Capacity	30 lbs.
Size	22" L x 10"W



8895152 shown with light bar 8891060 (not included)



8895115



8895301

Ford Trucks

Part No.	Make/Model	Wt. (lbs.)	Cat.
8895152*	Ford F-150 (2015+), Ford F-250-550 (2017+) and Ranger (2019+) *Replaced 8895150*	7.25	889 (N)
8895250	Ford SuperDuty with Legacy Steel Cab F-250-550 (2006-2016)	7.25	889 (N)

Installs in third light OEM location, no drilling required

For GM/Chevy Trucks

Part No.	Make/Model	Wt. (lbs.)	Cat.
8895115*	1500-4500 LT / LD with Spoiler (2020)	3.5	889 (N)
8895095	1500-3500 STD & XTD (2007-2013)	7.25	889 (N)
8895100	1500-3500 (2014-2018, All Models), 1500-3500 (2019 All Models) Except 1500 LT & LTZ	7.25	889 (N)
8895105	For Chevy Colorado-GMC Canyon (2015-2017) with "103" Antenna	7.25	889 (N)

Dodge/RAM Trucks

Part No.	Make/Model	Wt. (lbs.)	Cat.
8895301*	1500 Classic / 2500-5500 All Models (2019+)	8.0	889 (N)
8895300	1500-4500 (2010-2018) <i>Only</i>	7.25	889 (N)
8895350	Dodge-Ram Cab & Chassis 5500 (2010-2018) <i>*Only for 5500*</i>	7.25	889 (N)

Installs in third light OEM location, no drilling required

Fleet Series Drill-Free Light Bar Cab Mount

Construction	Rustproof Aluminum
Finish	Black Powder-Coated
Capacity	30 lbs.
Size	22" L x 10"W



8895550 shown with light bar

Ford Trucks

Part No.	Make/Model	Wt. (lbs.)	Cat.
8895550	Ford F-150 (2015+) and Ford F-250/550 (2017+)	6.46	889 (N)

Installs in third light OEM location, no drilling required



4" LED Rechargeable Magnetic Road Flares

IP 67

LEDs Per Flare	16
Number of Flash Patterns	10
Color	Amber
Run Time	8 - 60 Hours
Recharge Time	4 - 5 Hours
Housing	Crush-Proof with Magnetic Bottom
Charger	120V Wall Charger 12V Vehicle Charger



8891016
Single road strobe/flare



8891017
Case of 4 road strobe/flares



8891018
Case of 6 road strobe/flares

Single Road Strobe Flare

Part No.	Number of Flares	Amp	Wt. (lbs.)	Cat.
 8891016*	1	0.5	0.85	889 (N)

4 Road Strobe Flare Case

Part No.	Number of Flares	Amp	Wt. (lbs.)	Cat.
 8891017*	4	0.5	5.00	889 (N)

6 Road Strobe Flare Case

Part No.	Number of Flares	Amp	Wt. (lbs.)	Cat.
 8891018	6	0.5	6.42	889 (N)



Stop, Turn, Tail & Backup Lights

4" Round LED Stop/Turn/Tail/Backup Light



Number of LEDs	13
Lens Color	Red / Clear
Size	4"
Connection	PL-3 Connection and PL-2 Connection
Compliance Family	FMVSS 108

2 LIGHTS IN ONE!



5624132
Light only (sold in qty of 10)



5624050
(sold in qty of 10)

5620251
(sold in qty of 25)

5620350
(sold in qty of 25)

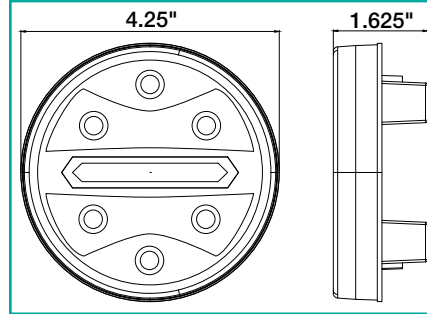

Part No.	Mounting	Amp	Std. Qty.	Wt. (lbs.)	Cat.
5624132*	Grommet	0.46	10	0.50	889 (N)

Featuring "Light Stripe" LED light tube technology.
Bulk. Part number indicates single light only. Must order in multiples of 10.
Available May 2020

Accessories

Part No.	Description	Std. Qty.	Wt. (lbs.)	Cat.
5624050	Black Grommet for use with 5624132	10	0.15	562 (N)
5620251	2-Pin Right Angle Male Plug with Stripped Power Lead and #10 Ring on Ground	25	0.03	562 (N)
5620350	3-Pin Right Angle Male Plug with Stripped Power Leads and #10 Ring on Ground	25	0.03	562 (N)

Bulk. Part number indicates single item only. 5624050 must be ordered in multiples of 10, 5620251 and 5620350 must be ordered in multiples of 25.

6" Oval LED Stop/Turn/Tail/Backup Light



Number of LEDs	17
Lens Color	Red / Clear
Size	6"
Connection	PL-3 Connection and PL-2 Connection
Compliance Family	FMVSS 108

2 LIGHTS IN ONE!



5626132
Light only (sold in qty of 10)

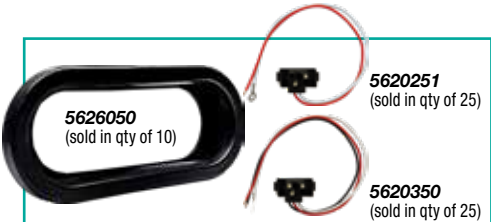

5626050
(sold in qty of 10)

5620251
(sold in qty of 25)

5620350
(sold in qty of 25)

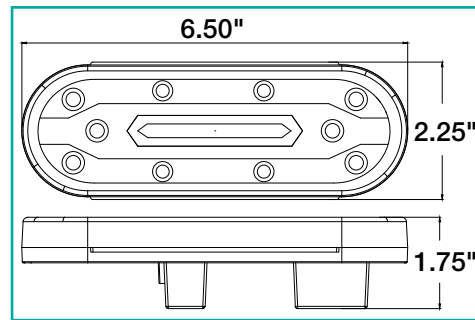

Part No.	Mounting	Amp	Std. Qty.	Wt. (lbs.)	Cat.
5626132*	Grommet	0.46	10	0.50	889 (N)

Featuring "Light Stripe" LED light tube technology.
Bulk. Part number indicates single light only. Must order in multiples of 10.
Available May 2020

Accessories

Part No.	Description	Std. Qty.	Wt. (lbs.)	Cat.
5626050	Black Grommet for use with 5626132	10	0.15	562 (N)
5620251	2-Pin Right Angle Male Plug with Stripped Power Lead and #10 Ring on Ground	25	0.03	562 (N)
5620350	3-Pin Right Angle Male Plug with Stripped Power Leads and #10 Ring on Ground	25	0.03	562 (N)

Bulk. Part number indicates single item only. 5626050 must be ordered in multiples of 10, 5620251 and 5620350 must be ordered in multiples of 25.



4" Round Turn Signal Light with 10 LEDs



Number of LEDs	10
Lens Color	Orange
Amp	0.221
Size	4"
Connection	PL-3 Connection
Compliance Family	FMVSS 108

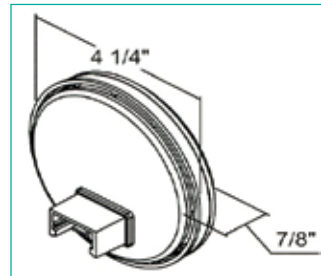

Part No.	Mounting	Amp	Std. Qty.	Wt. (lbs.)	Cat.
5624210	Grommet (Included)	0.221	1	0.70	562 (N)

Part No.	Mounting	Amp	Std. Qty.	Wt. (lbs.)	Cat.
5624211*	Grommet (Sold Separately)	0.221	10	0.36	562 (N)

Bulk. Part number indicates single light only. Must order in multiples of 10.

Accessories

Part No.	Description	Std. Qty.	Wt. (lbs.)	Cat.
5624050	Black Grommet for use with 5624211	10	0.15	562 (N)
5620350	3-Pin Right Angle Male Plug with Stripped Power Leads and #10 Ring on Ground	25	0.03	562 (N)

Bulk. Part number indicates single item only. 5624050 must be ordered in multiples of 10, 5620350 must be ordered in multiples of 25.



The Buyers family of manufacturing companies

Tracom

B **Boomerang**
RUBBER, INC.

Romotech
Rotational Molding Technologies, Inc.

P **PROGRESSIVE**
POWDER COATING, INC.



www.buyersproducts.com

Buyers
PRODUCTS COMPANY

SnowDogg
by Buyers

SaltDogg
by Buyers

ScoopDogg
by Buyers

DumperDogg
by Buyers

LITLIGHTINGSUP_A