



TRUST THE TOWING EXPERTS

2021 CATALOG & APPLICATION GUIDES

**INTENTIONALLY LEFT BLANK
FOR TWO-PAGE VIEWING**

YOUR ONE-STOP SHOP

FOR TOWING & TRUCK ACCESSORIES



curtmfg.com



ariesautomotive.com



luvernetruck.com



uwsta.com



LIPPERT
COMPONENTS®

Guided by three generations of family leadership, LCI has grown tremendously over the last 62 years. Today, LCI is an industry leader of premium components to the RV, marine, heavy truck, equestrian trailer, bus and residential industries.

CURT has joined the LCI family, bringing its robust product portfolio to these related industries and rounding out the LCI offering to better serve the aftermarket. Our cultures, our values and our vision are well-aligned to ultimately bring greater success to our customers.



NEW, EASIER ORDERING SYSTEM

Driven by our desire to provide you with the best experience possible when doing business with us, we have launched an all-new ordering system called OrderHub™. OrderHub™ has all of the same capabilities as ComNet and more!

Please visit curtmfg.com/orderhub-features to learn more!

OrderHub™ Highlights



Easy-to-use interface



Mobile-friendly platform



Fully integrated with our websites



Synchronized across all brands

This means no more going to a separate website to place orders and no more logging into multiple accounts. Through OrderHub™, you can place orders for CURT, ARIES, LUYERNE and UWS products all at the same time, all in one location.

OrderHub™ will continue to offer the best features of the old system and several new and exciting tools.

Why Use OrderHub™

- Reservation of inventory
- Multi-warehouse inventory visibility
- Enhanced quick order / upload order
- Single email sign-on for all brands
- Order multiple brands at the same time
- Retail pricing management / my pricing downloads
- Scalable to meet new requests and customer needs
- Single site to do part research / purchase products

NEW PRODUCTS



Custom-Fit Trailer Hitches

Custom hitches are at the heart of our new product efforts. We offer many first-to-market designs, in-house testing and an industry-leading finish. **Page 12**



Universal Weld-On Trailer Hitches

We've expanded our weld-on hitch offering to better accommodate service body trucks. New options include 18" drop, 20K ratings and more. **Page 20**



Rambler™ Tow Bar & Base Plates

Years of engineering experience have been the platform for our all-new flat towing line, including tow bars, custom base plates and more. **Page 216**



30K Spyder™ 5th Wheel Rail Gooseneck

The popular Spyder™ 5th wheel gooseneck hitch is now available in a 30K capacity. It drops into any standard rails and features a 2-5/16" ball. **Page 242**



PowerRide™ 30K 5th Wheel Hitch

This brand new 5th wheel is engineered to provide a tough, heavy-duty 30K capacity while offering enhanced ergonomics and features. **Page 188**



S-Series™ 5th Wheel Sliders

The all-new S16™ and S25™ sliders for short-bed 5th wheel towing feature a quiet design and automatic latches for streamlined operation. **Page 204**



Custom Wiring

We continue to advance our plug-and-play, custom wiring line with new technology, like potted housings and many first-to-market applications. **Page 30**



Powered by
flic

Echo® Manual Override Button

This Bluetooth accessory for the Echo® brake controller allows for as-needed manual activation of the trailer brakes, while promoting hands-free driving. **Page 139**



Protective MultiPro / Multi-Flex Tailgate Sensors

This sensor detects when a hitch accessory is installed in the receiver, stopping the inner tailgate from dropping down and inflicting costly damage. **Page 156**



QuickPin™ No-Latch Trailer Couplers

This revolutionary new, no-latch trailer coupler offers stress-free coupling. Instead of a traditional latch, it uses a single pin for easy, secure hookup. **Page 246**



EasyDrop™ & PowerForce™ Trailer Jacks

Our new jacks include an electric model with a unique 2-to-7-way connector, and a drill-operated model for quick, easy raising and lowering. **Page 251**



Rebellion™ XD Cushion Hitches

The Rebellion™ XD line is expanding with new dual-ball kits and a 2-1/2" shank option rated up to 20K. We've also added custom Rebellion™ XD locks. **Page 106**



RV Towing Starter Kit

This kit contains everything new travel trailer owners need to start towing, including Rockerball™, sway control, anti-rattle, and Echo® brake controller. **Page 102**



Anti-Rattle Hitch Clamps

Our new anti-rattle clamps help stop annoying vibrations, and they require no tools for install! They can be used on hollow and solid shank accessories. **Page 123**



Universal Tri-Ball Coupler Lock

One lock for all your trailers! This lock features a tri-ball insert to fit 1-7/8", 2" or 2-5/16" trailer couplers. It also has a unique security feature. **Page 120**



Aluminum Tray-Style Bike Rack

This all-new bike rack weighs only 45 lbs. and fits 20" to 29" tires, including fat tires and e-bikes. It has secure, ratcheting arms and a simple assembly. **Page 266**



Seat Defender™ Removable Seat Covers

These removable seat covers stop damage before it happens. They install quickly, remove easily and are machine-washable. **Page 272**



Jeep Wrangler JK Roof Rack Crossbars

These crossbars are the perfect way to add storage space to the Jeep Wrangler. They feature no-drill, quick-release clamps for easy installation. **Page 278**

5th wheel, accessory	210
5th wheel, base rail	206
5th wheel, bracket kit	206
5th wheel, hitch	184
5th wheel, lock	210
5th wheel, lube plate	211
5th wheel, OEM puck product	202
5th wheel, roller	205
5th wheel, slider	204
Adapter, 4-way flat	158
Adapter, 4-way round	159
Adapter, 6-way round	159
Adapter, 7-way round & RV blade	161
Adapter, dinghy towing	162
Adapter, Dodge factory harness	150
Adapter, for LED trailer lights	160
Adapter, with LED tester cover	160
Anti-rattle	123
Ball mount, 1-1/4" class 1 & 2	100
Ball mount, 1-1/4" Euro Mount®	99
Ball mount, 2" adjustable	110
Ball mount, 2" class 3	101
Ball mount, 2" class 4	104
Ball mount, 2" forged	105
Ball mount, 2" Fusion™ mount	104
Ball mount, 2" loaded	103
Ball mount, 2" multi-ball	110
Ball mount, 2" specialty mount	113
Ball mount, 2-1/2" forged	105
Ball mount, 3" forged	105
Ball mount, ATV	113
Ball mount, channel mount	108
Ball mount, Rebellion™ XD	106
Ball mount, reducer sleeve	115
Ball mount, towing starter kit	102
Ball mount, tri-ball	111
Ball mount, vertical	115
Bearing protector	262
Bike rack, accessory	270
Bike rack, aluminum tray-style	266
Bike rack, clamp-on	270
Bike rack, hitch-mounted, premium	269
Bike rack, hitch-mounted	269
Bike rack, steel tray-style	268
Brake controller harness	143
Brake controller	138
Breakaway batteries and cases	147
Breakaway kit, push-to-test	146
Cable lock	122
Cargo bag	280
Cargo carrier, ATV	275
Cargo carrier, aluminum	274
Cargo carrier, basket-style	277
Cargo carrier, tray-style	276
Cargo net	280

Cargo strap	281
Chain, bulk	256
Chain, custom	256
Clevis hook	259
Clevis pin	111
Converter, taillight	148
Coupler	246
Coupler, channel-mount	248
Coupler, latch lock	120
Coupler, trailer lock	120
Custom wiring	150
Dual-output socket, backup alarm	158
Echo® manual override button	139
Electrical, custom wiring extension	154
Electrical, bracket, Easy-Mount™	168
Electrical, bracket, mounting	169
Electrical, breaker	173
Electrical, bonded 4-wire spool	171
Electrical, butt connector	172
Electrical, flashers and fuses	173
Electrical, quick connector	172
Electrical, RV harness	157
Electrical, slit loom	173
Electrical, snap lock	172
Electrical, terminal	172
Electrical, tester	171
Extension harness, 7-way RV blade	155
Fabrication component	133
Gooseneck, 5th wheel rail	242
Gooseneck, over-bed hitch	240
Gooseneck, over-bed install brkt	241
Gooseneck, OEM-style anchors	230
Gooseneck, OEM-style 3" ball	231
Gooseneck, OEM-style hitch	232
Gooseneck, Double Lock™ Original	236
Gooseneck, Double Lock EZr™	234
Gooseneck, X5™ adapter plate	237
Grip Step™ hitch step	131
Hitch bar	133
Hitch pin & clip, 1/2" and 5/8"	116
Hitch tube cover	130
Hitch lock	118
Jack, PowerForce™ & EasyDrop™	251
Jack, A-frame, marine, swivel	252
Jack, direct weld	254
Lights, auxiliary LED indicator	276
Lights, towing	170
Lights, trailer	170
Literature	286
Lock	121
Lunette ring	249
MultiPro/Multi-Flex tailgate sensor	156
Pintle, mount	126
Pintle, combination and regular	125
Pintle, replacement ball	128

Point-of-purchase, banner	286
Point-of-purchase, display stand	286
Point-of-purchase, gondola display	286
Point-of-purchase, planogram	286
Point-of-purchase, poster	286
Point-of-purchase, window sticker	286
Point-of-purchase, header card	286
Plugs & sockets, 2-way flat	164
Plugs & sockets, 4-way flat	163
Plugs & sockets, 4-way round	165
Plugs & sockets, 5-way flat	165
Plugs & sockets, 6-way round	166
Plugs & sockets, 6-way square	166
Plugs & sockets, 7-way	167
Quick link	261
Receiver tube adapter	114
Receiver tube extender	114
Reducer bushing	96
Roof rack crossbars	279
Roof rack cargo carrier	278
Roof rack kayak holders	279
Rope hooks and rings	284
Safety cable	258
Safety chain	257
Safety hook	260
Safety pin	117
Seat Defender™	272
SecureLatch™ Series	124
Sway control, unit and repl. parts	181
Tow bar, adjustable	220
Tow bar, Rambler™	217
Tow hooks and straps	112
Tow mirror, extended view	132
Trailer ball	94
Trailer ball, covers and repl. parts	95
Trailer ball, RockerBall™	92
Trailer ball, Switch Ball™	97
Trailer ball, wrench	96
Trailer hitch, bumper mount	14
Trailer hitch, Commercial Duty	13
Trailer hitch, custom-fit	13
Trailer hitch, front mount	23
Trailer hitch, multi-fit	14
Trailer hitch, rear mount, app guide	30
Trailer hitch, RV	22
Trailer hitch, universal weld-on	20
Trailer hitch, Xtra Duty	13
USCAR replacement product	152
Weight distribution, TruTrack™	176
Weight distribution, trunnion bar	178
Weight distribution, round bar	179
Weight distribution, shank	180
Wheel bearing kit	262
Wheel chock lock	122
Winches and straps	255

UNDERSTANDING TOWING

Towing basics and electrical guides

006 - 009

TRAILER HITCHES

Rear and front mount, multi-fit and RV hitches

010 - 029

APPLICATION GUIDE

Hitch and wiring applications listed by make and model

030 - 089

TOWING ACCESSORIES

Brake controllers, custom wiring, adapters and connectors

090 - 133

TOWING ELECTRICAL

Ball mounts, trailer balls, locks, pintles and more

134 - 173

WEIGHT DISTRIBUTION

TruTrack™ systems, WD hitch kits and sway control

174 - 181

5TH WHEEL HITCHES

OEM puck system options, sliders and hitches up to 30K

182 - 213

FLAT TOWING

Tow bars, base plates, wiring and accessories

214 - 225

GOOSENECK HITCHES

OEM puck system kits, Double Lock EZr™ and more

226 - 243

TRAILER PARTS & ACCESSORIES

Jacks, couplers, lunette rings, safety chains and more

244 - 263

CARGO MANAGEMENT

Cargo carriers, bike racks, cargo straps and tie-downs

264 - 285

MARKETING MATERIALS

Literature, signage and display stands

286 - 287

NUMERICAL TRAILER HITCHES

Numerical listing of front and rear mount trailer hitches

288 - 300

NUMERICAL PRODUCTS

Complete, numerically sorted product listing

301 - 306

NUMERICAL CUSTOM WIRING

Custom wiring listed numerically

307 - 312



UNDERSTANDING TOWING

TRUST THE TOWING EXPERTS

Adjustable dual-ball channel mount



FOR MORE INFORMATION



TOWING 101
A beginner's guide to understanding the basics of towing
[visit curtmfg.com/introduction](http://curtmfg.com/introduction)



| CURT University

This self-serve tool is a one-stop shop for marketing resources, including presentations, flyers, merchandising, videos and more!

| Towing 101

The beginners guide is perfect for educating new employees. It covers all key aspects of towing, from hitch selection to trailer hook-up.

| Product support team

If you have questions about CURT products or how to use them, our Product Support Team is standing by. Simply call 877.287.8634 ext 2.

SECTION INDEX



08
Towing
Basics



09
CURT
University

TOWING BASICS

Gross trailer weight (GTW)

The gross trailer weight is the total weight of a trailer and its cargo. For example, GTW = boat + trailer + cooler + fishing gear. It is vitally important to know the GTW to ensure safe towing. It can be measured using the CURT BetterWeigh™ (page 98) or a vehicle scale.

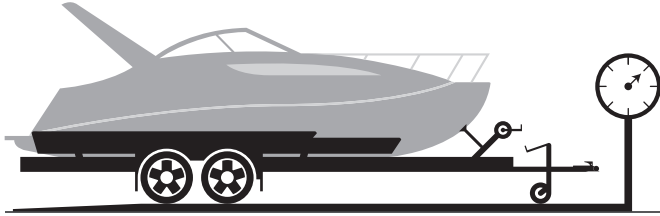

Weight carrying capacity (WC)

The weight carrying capacity is the total weight a trailer hitch is safely rated to tow without the assistance of a weight distribution system. When towing, the weight capacity is always limited to the lowest-rated towing component.

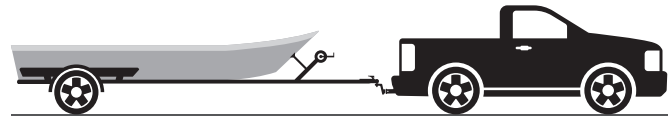

Tongue weight (TW)

Tongue weight is the downward force of the trailer at the coupling point. Proper TW should be about 10% to 15% of the GTW. TW can be measured using the CURT BetterWeigh™ (page 98), using a commercial scale or bathroom scale, following the method below.

Multiply scale reading by three

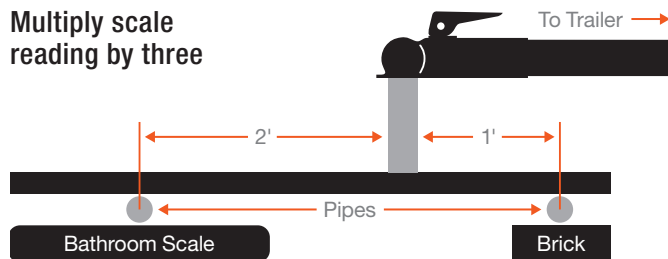

Weight distribution capacity (WD)

The weight distribution capacity is the maximum amount of weight a trailer hitch can safely tow with a weight distribution hitch installed. A weight distribution hitch distributes a portion of the TW across the vehicle and trailer to promote level towing. See page 174 for WD products.

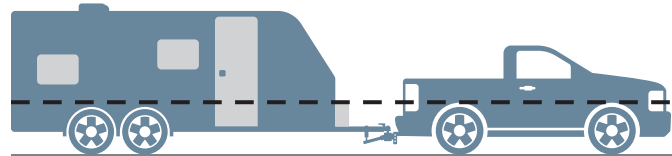

Measuring ball mount drop and rise

When selecting a ball mount, it is important to determine drop / rise for leveling the trailer. Use the diagram below to find this value. B minus A equals C. If C is negative, this indicates the amount of drop needed. If positive, it indicates rise.

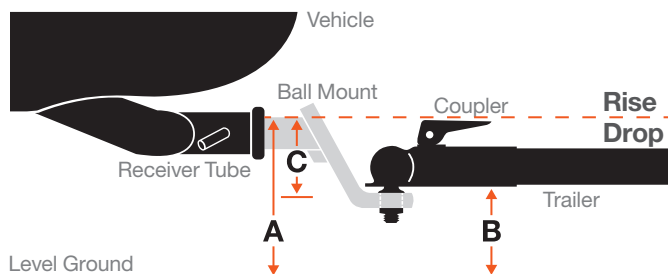

Level towing

Using a ball mount with the proper amount of drop or rise will allow for level towing across both trailer and vehicle. Without a level vehicle-trailer combination, the trailer can tend to wander and can even impair the driver's control over the vehicle.

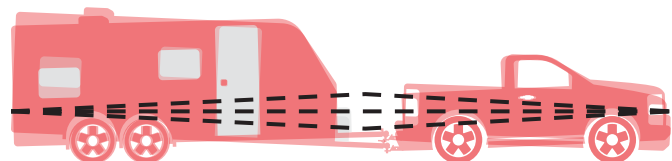



PUT OUR MARKETING ASSETS TO WORK FOR YOU!

CURT UNIVERSITY

CURT University is a self-service learning tool for CURT products and resources and provides easy access to nearly all of our marketing support materials. It is designed to educate our customers to enhance their sales and grow their business!



Scan or visit
curtmfg.com/university



Photos

Our photo library contains nearly 100,000 professional product photos of our products. This provides an accurate view of each part, a snapshot of key features and a look at what's included in each package.

This library is available for use on your website and in your store!



Videos

Our in-house video team has produced over 1,300 videos with more published every week. Our primary focus is installation videos and feature videos, but we also have a number of educational how-tos.

Our videos can easily be embedded on your website through YouTube. In-store options are also available.



How-To Guides

When it comes to towing, users, both new and experienced, are asking questions. We offer a growing number of how-to guides on our website to help you provide answers.

Our Towing 101 guide is a great place to start, laying out the basics of equipment, installation and safe towing practices.



Literature

Our in-house creative team works tirelessly to publish a variety of high-caliber literature pieces, everything from new product flyers to the in-depth catalog you're currently browsing!

Place our literature in your store to give your associates and customers a tangible reference as they come to a buying decision.



Merchandising

We offer a number of custom-built displays to furnish your store and showcase our products in a professional light. Choose from floor models and planogram options.

We also offer posters, header cards, counter mats and other signage to communicate the advantages of choosing CURT.



Presentations

Educate yourself and train your associates on the key selling points of our products. For each product category, we maintain high-quality training presentations, complete with unique selling points, photography and videos.



TRAILER HITCHES

TRUST THE TOWING EXPERTS

Class 3 rear-mount trailer hitch



FEATURED PRODUCTS



Rear mount hitches

CURT is the industry leader in first-to-market hitch designs, and each one is engineered and tested to the highest safety standards.



Weld-on hitches

We've expanded our weld-on hitch offering to better accommodate service body trucks, including 20K and 18" drop options.



Front mount hitches

CURT front mount hitches are vehicle-specific and provide a useful receiver for a cargo carrier, snow plow or even for parking a trailer.

PRODUCT INDEX



12

Class 1 & 2
Trailer Hitches

Made in USA



12

Class 3 & 4
Trailer Hitches

Made in USA



12

Class 5
Trailer Hitches

Made in USA



14

Multi-Fit
Trailer Hitches



14

Bumper
Hitches

Made in USA



20

Weld-On
Trailer Hitches

Made in USA



22

Adjustable
RV Hitches

Made in USA



22

RV Bumper
Hitches

Made in USA



24

Front Mount
Hitches

Made in USA



CUSTOM-FIT TRAILER HITCHES

For trailer hitch application guide go to page 30

CURT custom hitches are broken out into five distinct classes based on their receiver tube size and weight ratings. Despite these classes, weight ratings vary by part number. Each hitch is made for vehicle-specific application and is always limited by the lowest-rated towing component.

Product Details

- Made with a vehicle-specific design for a custom fit
- Tested for safety in accordance with SAE J684
- Precisely welded for superior strength and fit
- Protected by a durable black powder coat finish
- Co-cured in a rust-resistant liquid A-coat
- Equipped with an open-back receiver for easy cleaning
- Limited lifetime warranty (see last page for details)



Advantages of CURT trailer hitches



Proud to manufacture all of our custom hitches in the USA (may include imported hardware)



Constructed with a combination of manual and robotic welding for superior strength and fit



Liquid A-coat applied inside and out and co-cured with powder coat for maximum rust resistance



Industry-leading, in-house safety and performance testing, according to SAE specifications



CUSTOM-FIT TRAILER HITCHES

Below is a quick comparison of the five different hitch classes as well as front mount hitches.

For a complete vehicle application guide, see page 30.

1 1/4 INCH CLASS 1 & 2 HITCHES

- Available with included ball mount, pin and clip (see page 30 for ordering options)



2 INCH CLASS 3 & 4 HITCHES

- Many models feature a concealed main body for an OE look



2 INCH & 2 1/2 INCH CLASS 5 HITCHES

- Constructed with a large, powerful main body
- Features wide safety chain openings for heavy-duty hooks



2 INCH FRONT MOUNT HITCHES

- Ideal for attaching a snow plow, cargo carrier or other front hitch accessory
- Up to 9,000 lbs. straight-line pull
- Easily maneuver a trailer into a tight spot
- See page 24 for application information



QUICK COMPARISON

Hitch Class	Rec. Size	GTW (lbs.)	TW (lbs.)	WD (lbs.)	WDTW (lbs.)	Finish
Class 1	1-1/4"	Up to 2,000 lbs.	Up to 200 lbs.	--	--	Gloss black
Class 2	1-1/4"	Up to 3,500 lbs.	Up to 350 lbs.	--	--	Gloss black
Class 3	2"	Up to 8,000 lbs.	Up to 800 lbs.	Up to 12,000 lbs.	Up to 1,200 lbs.	Gloss black
Class 4	2"	Up to 10,000 lbs.	Up to 1,000 lbs.	Up to 12,000 lbs.	Up to 1,200 lbs.	Gloss black
Class 5 - Xtra Duty	2"	Up to 17,000 lbs.	Up to 2,550 lbs.	Up to 17,000 lbs.	Up to 2,550 lbs.	Carbide black
Class 5 - Commercial Duty	2-1/2"	Up to 20,000 lbs.	Up to 2,700 lbs.	Up to 20,000 lbs.	Up to 2,700 lbs.	Carbide black
Front Mount	2"	Up to 5,000 lbs.	Up to 500 lbs.	--	--	Gloss black

Trailer hitch weight ratings vary by part number and are limited to vehicle manufacturer's stated capacities

MULTI-FIT TRAILER HITCHES

For multi-fit hitch application guide see adjacent page

For retail settings or if a CURT custom hitch is not available for a particular vehicle, a multi-fit hitch is a dependable alternative. These hitches are made to fit a wide variety of vehicle applications, and most require little or no drilling for installation.

Product Details

- Versatile frame design to fit a variety of vehicles
- Available with 1-1/4" or 2" receiver tube
- Gross trailer weight ratings ranging from 3,500 lbs. up to 15,000 lbs.
- Select models compatible with WD hitch
- Requires little or no drilling on most models
- Robotically welded for superior strength and fit
- Includes mounting hardware (grade-8 on #15510, #15511)
- Durable gloss black powder coat finish
- Informative, full-color retail box (excluding #15510, #15511)
- Limited lifetime warranty (see last page for details)



Multi-fit hitches are designed to perfectly balance a wide range of fitment and an integrated look, providing a safe, secure towing solution

Did you know?

The class 3 #13902 and #13903 provide a comprehensive retail option for pickups.



2 INCH

BUMPER HITCHES

- Includes safety chain hookups and imported mounting hardware
- Limited lifetime warranty (see last page for details)



19030



19031



19050

Pkg#	Fits	Years	GTW / TW	Bolt Pattern
19030	Most factory steel bumpers (bolts onto the bottom of step bumper)	--	5,000 / 500 lbs.	8-1/2" width on center
19031	Westin and DMI bumpers (bolts onto the bottom of step bumper)	--	5,000 / 500 lbs.	10-1/2" width on center
19050	Dodge pickups with one-piece factory steel step bumper	94 - 02	4,000 / 400 lbs.	8" width on center

Multi-Fit Trailer Hitches

Make / Model	Style	Years	Rec. Size	Part#	Foot Notes	GTW / TW (lbs.)	WD / WDTW (lbs.)
Chevrolet							
Astro	Extended chassis	85 - 05	1.25	12923	4, 5	3.5 / 350	--
			2	13900	4, 5	5.0 / 500	--
Blazer	--	92 - 94	2	13900	4	5.0 / 500	--
		83 - 94	1.25	12923	4	3.5 / 350	--
	Full-size	80 - 91	2	13900	4	5.0 / 500	--
C/K 1500	Excluding stepside and king cab	62 - 99	1.25	12923	4	3.5 / 350	--
	8' bed	88 - 99	2	13900	4	5.0 / 500	--
	8' bed, excluding stepside	62 - 87	2	13900	4	5.0 / 500	--
			2	15511	2	15 / 1500	16 / 1600
			2	15510	1	15 / 1500	16 / 1600
C/K 2500	Excluding stepside and king cab	62 - 99	1.25	12923	4	3.5 / 350	--
	8' bed	88 - 99	2	13900	4	5.0 / 500	--
	8' bed, excluding stepside	62 - 87	2	13900	4	5.0 / 500	--
			2	15511	2	15 / 1500	16 / 1600
			2	15510	1	15 / 1500	16 / 1600
	Cab & chassis	88 - 99	2	15510	1	15 / 1500	16 / 1600
			2	15511	2	15 / 1500	16 / 1600
C/K 3500	8' bed	62 - 87	2	15510	1	15 / 1500	16 / 1600
			2	15511	2	15 / 1500	16 / 1600
	Cab & chassis	88 - 99	2	15510	1	15 / 1500	16 / 1600
			2	15511	2	15 / 1500	16 / 1600
Express	Full-size van	96 - 21	2	13900	4	5.0 / 500	--
G-Series	Full-size van	78 - 96	2	13900	4	5.0 / 500	--
S10	4WD, short bed	98 - 04	2	13900	4	5.0 / 500	--
	Long bed, excluding Baja	83 - 04	1.25	12923	4	3.5 / 350	--
			2	13900	4	5.0 / 500	--
Silverado 1500	--	99 - 18	2	13901*	--	5.0 / 500	7.5 / 750
			2	13902	--	8.0 / 800	12 / 1200
	8' bed	99 - 06	2	13900	4	5.0 / 500	--
Silverado 1500 Classic	--	07 - 07	2	13901*	--	5.0 / 500	7.5 / 750
			2	13902	--	8.0 / 800	12 / 1200
	8' bed	07 - 07	2	13900	4	5.0 / 500	--
Silverado 1500 HD	--	05 - 06	2	13901*	--	5.0 / 500	7.5 / 750
		01 - 03	2	13901*	--	5.0 / 500	7.5 / 750
Silverado 1500 HD Classic	--	07 - 07	2	13901*	--	5.0 / 500	7.5 / 750
Silverado 1500 LD	--	19 - 19	2	13901*	--	5.0 / 500	7.5 / 750
			2	13902	--	8.0 / 800	12 / 1200
Silverado 2500	--	99 - 04	2	13901*	--	5.0 / 500	7.5 / 750
			2	13902	--	8.0 / 800	12 / 1200
	8' bed	99 - 04	2	13900	4	5.0 / 500	--
Silverado 2500 HD	--	01 - 19	2	13902	--	8.0 / 800	12 / 1200
		01 - 14	2	13901*	--	5.0 / 500	7.5 / 750
	8' bed	01 - 06	2	13900	4	5.0 / 500	--
Silverado 2500 HD Classic	--	07 - 07	2	13901*	--	5.0 / 500	7.5 / 750
			2	13902	--	8.0 / 800	12 / 1200
	8' bed	07 - 07	2	13900	4	5.0 / 500	--

1. Receiver tube drops 5-1/2" on the rear of the vehicle
2. Receiver tube drops 7-1/2" on the rear of the vehicle
3. Two sets of mounting brackets included, only one set will be used based on application

4. Adjustable frame
 5. Spare tire may need relocating
 6. Excluding 20" spare tire
- * Continued while supplies last

Applications continued on the following page

Multi-Fit Trailer Hitches

Make / Model	Style	Years	Rec. Size	Part#	Foot Notes	GTW / TW (lbs.)	WD / WDTW (lbs.)
Chevrolet (continued)							
Silverado 3500	--	01 - 06	2	13901*	--	5.0 / 500	7.5 / 750
			2	13902	--	8.0 / 800	12 / 1200
Silverado 3500 Classic	8' bed	01 - 06	2	13900	4	5.0 / 500	--
	--		07 - 07	2	13901*	--	5.0 / 500
Silverado 3500 HD	--	07 - 19	2	13902	--	8.0 / 800	12 / 1200
			2	13901*	--	5.0 / 500	7.5 / 750
Suburban	--	92 - 06	1.25	12923	4	3.5 / 350	--
			2	13900	4	5.0 / 500	--
Tahoe	--	95 - 06	2	13900	4	5.0 / 500	--
Venture	--	97 - 04	1.25	12923	4	3.5 / 350	--
			2	13900	4	5.0 / 500	--
Chrysler							
Town & Country	Excl. Stow-n-Go	88 - 07	1.25	12923	4	3.5 / 350	--
			2	13900	4	5.0 / 500	--
Voyager	--	00 - 03	2	13900	4	5.0 / 500	--
Dodge							
Caravan	Excl. Stow-n-Go	88 - 07	1.25	12923	4	3.5 / 350	--
			2	13900	4	5.0 / 500	--
Dakota	--	86 - 04	1.25	12923	4	3.5 / 350	--
			2	13900	4	5.0 / 500	--
D/W Series Pickups	Excluding 1-ton	62 - 87	2	13900	4	5.0 / 500	--
	--	72 - 93	2	15510	1	15 / 1500	16 / 1600
			2	15511	2	15 / 1500	16 / 1600
Ram 1500	--	02 - 10	2	13902	--	8.0 / 800	12 / 1200
			94 - 01	1.25	12923	4	3.5 / 350
Ram 2500	--	03 - 10	2	13902	--	8.0 / 800	12 / 1200
			94 - 01	1.25	12923	4	3.5 / 350
Ram 3500	--	03 - 10	2	13902	--	8.0 / 800	12 / 1200
			94 - 01	1.25	12923	4	3.5 / 350
Ramcharger	--	78 - 93	1.25	12923	4	3.5 / 350	--
			2	13900	4	5.0 / 500	--
Ford							
Aerostar	Extended chassis	86 - 97	2	13900	4	5.0 / 500	--
Bronco	--	78 - 97	1.25	12923	4	3.5 / 350	--
			2	13900	4	5.0 / 500	--
Bronco II	--	84 - 90	1.25	12923	4	3.5 / 350	--
			2	13900	4	5.0 / 500	--
Escape	--	01 - 04	2	13900	4	5.0 / 500	--
E-150	--	03 - 14	2	13900	4	5.0 / 500	--
E-150 Econoline	--	80 - 98	1.25	12923	4	3.5 / 350	--
			80 - 02	2	13900	4	5.0 / 500
E-250	--	03 - 14	2	13900	4	5.0 / 500	--
E-250 Econoline	--	80 - 98	1.25	12923	4	3.5 / 350	--
			80 - 02	2	13900	4	5.0 / 500

- Receiver tube drops 5-1/2" on the rear of the vehicle
- Receiver tube drops 7-1/2" on the rear of the vehicle
- Two sets of mounting brackets included, only one set will be used based on application

- Adjustable frame
- Spare tire may need relocating
- Excluding 20" spare tire
- * Continued while supplies last

Applications continued on the following page

Multi-Fit Trailer Hitches

Make / Model	Style	Years	Rec. Size	Part#	Foot Notes	GTW / TW (lbs.)	WD / WDTW (lbs.)
Ford (continued)							
F-100	--	67 - 83	2	15510	1	15 / 1500	16 / 1600
			2	15511	2	15 / 1500	16 / 1600
	Excluding flareside	67 - 83	1.25	12923	4	3.5 / 350	--
			2	13900	4	5.0 / 500	--
F-150	--	06 - 20	2	13903	3	8.0 / 800	12 / 1200
			2	13901*	--	5.0 / 500	7.5 / 750
		2	13902	--	8.0 / 800	12 / 1200	
	6' flareside bed	97 - 03	2	13900	4, 5	5.0 / 500	--
	8' bed	99 - 03	2	13900	4	5.0 / 500	--
	--	75 - 96	2	15510	1	15 / 1500	16 / 1600
			2	15511	2	15 / 1500	16 / 1600
	Excluding flareside	75 - 96	1.25	12923	4	3.5 / 350	--
			2	13900	4	5.0 / 500	--
	F-150 Heritage	--	04 - 04	2	13901*	--	5.0 / 500
2				13902	--	8.0 / 800	12 / 1200
F-250	--	97 - 99	2	13901*	--	5.0 / 500	7.5 / 750
			2	15510	1	15 / 1500	16 / 1600
		2	15511	2	15 / 1500	16 / 1600	
	Excluding flareside	74 - 99	1.25	12923	4	3.5 / 350	--
2			13900	4	5.0 / 500	--	
F-250 Super Duty	--	99 - 16	2	13901*	--	5.0 / 500	7.5 / 750
			2	13902	--	8.0 / 800	12 / 1200
	8' bed	99 - 16	2	13900	4, 6	5.0 / 500	--
F-350	--	67 - 97	2	15510	1	15 / 1500	16 / 1600
			2	15511	2	15 / 1500	16 / 1600
F-350 Super Duty	8' bed	99 - 16	2	13900	4, 6	5.0 / 500	--
			2	13901*	--	5.0 / 500	7.5 / 750
			2	13902	--	8.0 / 800	12 / 1200
F-450 Super Duty	Crew cab	08 - 16	2	13901*	--	5.0 / 500	7.5 / 750
			2	13902	--	8.0 / 800	12 / 1200
	2WD, cab & chassis	99 - 07	2	15510	1	15 / 1500	16 / 1600
			2	15511	2	15 / 1500	16 / 1600
Ranger	--	83 - 11	1.25	12923	4	3.5 / 350	--
	Short bed, excluding flareside	83 - 06	2	13900	4	5.0 / 500	--
	Long bed	83 - 11	2	13900	4, 5	5.0 / 500	--
Windstar	--	99 - 03	2	13900	4	5.0 / 500	--

1. Receiver tube drops 5-1/2" on the rear of the vehicle
2. Receiver tube drops 7-1/2" on the rear of the vehicle
3. Two sets of mounting brackets included, only one set will be used based on application

4. Adjustable frame
 5. Spare tire may need relocating
 6. Excluding 20" spare tire
- * Continued while supplies last

Applications continued on the following page

Multi-Fit Trailer Hitches

Make / Model	Style	Years	Rec. Size	Part#	Foot Notes	GTW / TW (lbs.)	WD / WDTW (lbs.)
GMC							
C/K 1500	Excluding stepside and king cab	62 - 99	1.25	12923	4	3.5 / 350	--
	8' bed	88 - 99	2	13900	4	5.0 / 500	--
	8' bed, excluding stepside	62 - 87	2	13900	4	5.0 / 500	--
			2	15511	2	15 / 1500	16 / 1600
			2	15510	1	15 / 1500	16 / 1600
C/K 2500	Excluding stepside and king cab	62 - 99	1.25	12923	4	3.5 / 350	--
	8' bed	88 - 99	2	13900	4	5.0 / 500	--
	8' bed, excluding stepside	62 - 87	2	13900	4	5.0 / 500	--
			2	15511	2	15 / 1500	16 / 1600
			2	15510	1	15 / 1500	16 / 1600
	Cab & chassis	88 - 99	2	15510	1	15 / 1500	16 / 1600
			2	15511	2	15 / 1500	16 / 1600
C/K 3500	8' bed	62 - 87	2	15510	1	15 / 1500	16 / 1600
			2	15511	2	15 / 1500	16 / 1600
	Cab & chassis	88 - 99	2	15510	1	15 / 1500	16 / 1600
			2	15511	2	15 / 1500	16 / 1600
G-Series	Full-size van	78 - 96	2	13900	4	5.0 / 500	--
Jimmy	--	92 - 94	2	13900	4	5.0 / 500	--
		83 - 94	1.25	12923	4	3.5 / 350	--
	Full-size	80 - 91	2	13900	4	5.0 / 500	--
Safari	Extended chassis	85 - 05	1.25	12923	4, 5	3.5 / 350	--
			2	13900	4, 5	5.0 / 500	--
Savana	Full-size van	96 - 17	2	13900	4	5.0 / 500	--
Sierra 1500	--	99 - 18	2	13901*	--	5.0 / 500	7.5 / 750
			2	13902	--	8.0 / 800	12 / 1200
	8' bed	99 - 06	2	13900	4	5.0 / 500	--
Sierra 1500 Classic	--	07 - 07	2	13901*	--	5.0 / 500	7.5 / 750
			2	13902	--	8.0 / 800	12 / 1200
	8' bed	07 - 07	2	13900	4	5.0 / 500	--
Sierra 1500 HD	--	05 - 06	2	13901*	--	5.0 / 500	7.5 / 750
		01 - 03	2	13901*	--	5.0 / 500	7.5 / 750
Sierra 1500 HD Classic	--	07 - 07	2	13901*	--	5.0 / 500	7.5 / 750
Sierra 1500 Limited	--	19 - 19	2	13901*	--	5.0 / 500	7.5 / 750
			2	13902	--	8.0 / 800	12 / 1200
Sierra 2500	--	99 - 04	2	13901*	--	5.0 / 500	7.5 / 750
			2	13902	--	8.0 / 800	12 / 1200
	8' bed	99 - 04	2	13900	4	5.0 / 500	--
Sierra 2500 HD	--	01 - 19	2	13902	--	8.0 / 800	12 / 1200
		01 - 14	2	13901*	--	5.0 / 500	7.5 / 750
	8' bed	01 - 06	2	13900	4	5.0 / 500	--
Sierra 2500 HD Classic	--	07 - 07	2	13901*	--	5.0 / 500	7.5 / 750
			2	13902	--	8.0 / 800	12 / 1200
	8' bed	07 - 07	2	13900	4	5.0 / 500	--
Sierra 3500	--	01 - 06	2	13901*	--	5.0 / 500	7.5 / 750
			2	13902	--	8.0 / 800	12 / 1200
	8' bed	01 - 06	2	13900	4	5.0 / 500	--

- Receiver tube drops 5-1/2" on the rear of the vehicle
- Receiver tube drops 7-1/2" on the rear of the vehicle
- Two sets of mounting brackets included, only one set will be used based on application

- Adjustable frame
 - Spare tire may need relocating
 - Excluding 20" spare tire
- * Continued while supplies last

Applications continued on the following page

Multi-Fit Trailer Hitches

Make / Model	Style	Years	Rec. Size	Part#	Foot Notes	GTW / TW (lbs.)	WD / WDTW (lbs.)
GMC (continued)							
Sierra 3500 Classic	8' bed	07 - 07	2	13901*	--	5.0 / 500	7.5 / 750
			2	13902	--	8.0 / 800	12 / 1200
Sierra 3500 HD	--	07 - 19	2	13902	--	8.0 / 800	12 / 1200
		07 - 14	2	13901*	--	5.0 / 500	7.5 / 750
Sonoma	4WD, short bed	98 - 04	2	13900	4	5.0 / 500	--
	Long bed	83 - 04	1.25	12923	4	3.5 / 350	--
	2		13900	4	5.0 / 500	--	
Suburban	--	92 - 99	1.25	12923	4	3.5 / 350	--
			2	13900	4	5.0 / 500	--
Yukon	--	92 - 06	2	13900	4	5.0 / 500	--
Yukon XL 1500 / 2500	--	00 - 06	2	13900	4	5.0 / 500	--
Isuzu							
Hombre	4WD	98 - 00	2	13900	4	5.0 / 500	--
Jeep							
Cherokee XJ	--	84 - 01	2	13900	4	5.0 / 500	--
Grand Cherokee	--	93 - 98	2	13900	4	5.0 / 500	--
Liberty	--	02 - 06	2	13900	4	5.0 / 500	--
Wagoneer	--	87 - 90	1.25	12923	4	3.5 / 350	--
Mazda							
Pickup	--	90 - 06	2	13900	4	5.0 / 500	--
Tribute	--	01 - 04	2	13900	4	5.0 / 500	--
Nissan							
Frontier	4.5' or 6.25' bed	87 - 04	2	13900	4	5.0 / 500	--
Pickup	4.5' bed	87 - 04	2	13900	4	5.0 / 500	--
	6' bed	87 - 94	1.25	12923	4	3.5 / 350	--
		87 - 04	2	13900	4	5.0 / 500	--
Oldsmobile							
Bravada	--	91 - 94	1.25	12923	4	3.5 / 350	--
Silhouette	--	97 - 05	1.25	12923	4	3.5 / 350	--
Plymouth							
Trail Duster	--	74 - 91	1.25	12923	4	3.5 / 350	--
			2	13900	4	5.0 / 500	--
Voyager	--	88 - 98	1.25	12923	4	3.5 / 350	--
		84 - 03	2	13900	4	5.0 / 500	--
Pontiac							
6000	--	82 - 84	1.25	12923	4	3.5 / 350	--
Montana	--	99 - 06	1.25	12923	4	3.5 / 350	--
Trans Sport	--	97 - 98	1.25	12923	4	3.5 / 350	--
Ram							
1500	--	11 - 20	2	13902	--	8.0 / 800	12 / 1200
1500 Classic	--	19 - 21	2	13902	--	8.0 / 800	12 / 1200
2500 / 3500	--	11 - 19	2	13902	--	8.0 / 800	12 / 1200
Toyota							
Pickup	6' bed, excluding T100	87 - 95	1.25	12923	4	3.5 / 350	--
	8' bed, excluding T100	87 - 94	2	13900	4	5.0 / 500	--
Tundra	--	00 - 06	2	13900	4	5.0 / 500	--

1. Receiver tube drops 5-1/2" on the rear of the vehicle
2. Receiver tube drops 7-1/2" on the rear of the vehicle
3. Two sets of mounting brackets included, only one set will be used based on application

4. Adjustable frame
 5. Spare tire may need relocating
 6. Excluding 20" spare tire
- * Continued while supplies last



2 INCH

UNIVERSAL WELD-ON TRAILER HITCHES

NEW

- Compatible with most service body trucks and other large pickup trucks
- Adjustable frame fits a variety of vehicles (side plates do not come pre-welded)
- Class 5 ratings with capacities available up to 20,000 lbs. Side plates must be welded 42" apart or less to achieve 20K rating (select models)
- Co-cured in a rust-resistant liquid A-coat and finished with a highly durable black powder coat
- Tested for safety in accordance with SAE J684
- Limited lifetime warranty (see last page for details)



15921



15923



15924

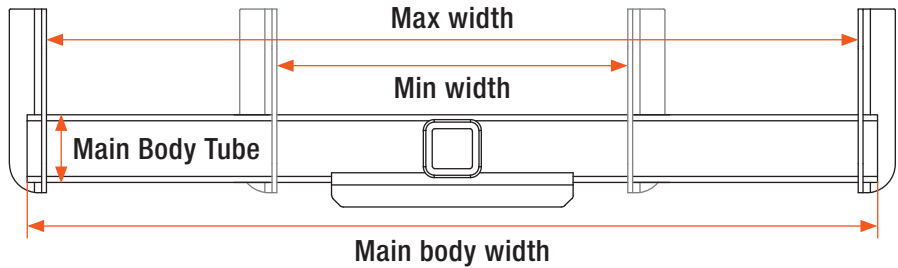
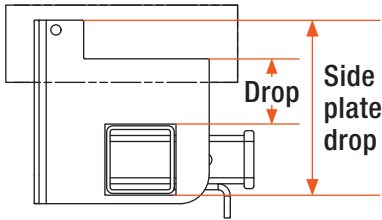

Part#	GTW	Receiver Tube Size	Main Body Width	Main Body Tube	Side Plate Drop	Drop	Max Width	Min Width
15901	15,000 lbs.	2"	45"	4" x 4"	9-1/2"	3-1/8"	43"	18"
15902	15,000 lbs.	2"	45"	4" x 4"	18"	11-1/2"	43"	18"
15903	15,000 lbs.	2"	62"	4" x 4"	18"	11-1/2"	60"	18"
15920	N 16,000 lbs.	2"	44"	3-1/2" x 3-1/2"	Not included	--	--	--
15927	N 16,000 lbs.	2"	44"	3-1/2" x 3-1/2"	9"	3 1/8"	42"	18"
15928	N 16,000 lbs.	2"	44"	3-1/2" x 3-1/2"	18"	11-1/2"	42"	18"
15921*	N 20,000 lbs.	2-1/2"	44"	3-1/2" x 3-1/2"	Not included	--	--	--
15923*	N 20,000 lbs.	2-1/2"	44"	3-1/2" x 3-1/2"	9"	3-1/4"	42"	18"
15924*	N 20,000 lbs.	2-1/2"	44"	3-1/2" x 3-1/2"	18"	11-1/2"	42"	18"
15922*	N 20,000 lbs.	2-1/2"	62"	3-1/2" x 3-1/2"	Not included	--	--	--
15925*	N 20,000 lbs.	2-1/2"	62"	3-1/2" x 3-1/2"	9"	3-1/4"	60"	18"
15926*	N 20,000 lbs.	2-1/2"	62"	3-1/2" x 3-1/2"	18"	11-1/2"	60"	18"

*Side plates must be welded 42" apart or less to achieve 20K rating

FULLY OUTFIT YOUR WORK TRUCK

Check out our other brands!



Topside and underbody tool boxes
 Extra-thick aluminum construction
 Class 3 DOT-compliant transfer tanks



Fleet-approved running boards
 Heavy-duty rubber mud flaps
 Rugged, no-drill grille guards



2 INCH GRIP STEP™ HITCH STEPS

- Fits any 2" x 2" receiver tube opening
- Provides a 26" hitch-mounted step on the front or rear of the vehicle
- Fleet-approved, expanded metal treads for maximum traction and safety
- Powder-coated aluminum construction to be strong, lightweight and rust-free
- 6" drop provides easier access into larger vehicles (designed for use in drop position only - #32002)
- Includes hitch pin & clip

NEW



32001

NEW



32002

Part#	Drop	Step Finish	Shank Finish
32001 N	--	Textured black	Black
32002 N	6"	Textured black	Black



2 INCH

ADJUSTABLE RV TRAILER HITCHES

- Co-cured in a rust-resistant liquid A-coat and protected by a gloss black powder coat finish
- May include imported installation hardware
- Limited lifetime warranty (see last page for details)



Designed for towing a trailer or small vehicle behind an RV

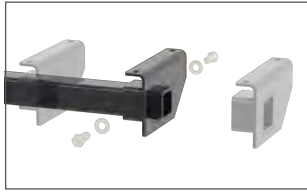

Three-piece, adjustable design fits multiple frame sizes



13704

Part#	GTW / TW	WD / WDTW	Frame	Drop
13701	5,000 / 500 lbs.	6,000 / 600 lbs.	Fits box frames up to 51" wide	2"
13702	5,000 / 500 lbs.	6,000 / 600 lbs.	Fits box frames up to 51" wide	--
13704	5,000 / 500 lbs.	--	Fits box frames up to 66" wide	--
13703	3,500 / 350 lbs.	--	Fits box, C-channel and I-beam frames up to 72" wide	--



2 INCH

RV BUMPER HITCHES

- Includes safety chain hookups and imported grade 8 mounting hardware
- Limited lifetime warranty (see last page for details)

Pkg#	GTW / TW	Fits
19100	3,500 / 350 lbs.	4" x 4" channel bumpers
19101	3,500 / 350 lbs.	2" x 4" channel bumpers



19100



19101

FISH WIRE

- Makes it easier to lead bolts and spacers through tough-to-reach holes
- Ideal for installing a trailer hitch on a vehicle with a hollow frame
- Coiled end accepts threaded bolts

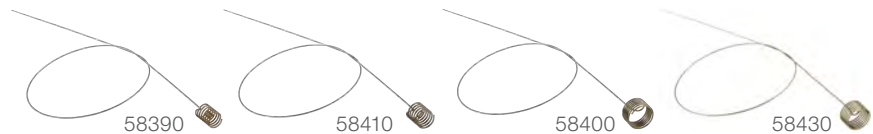

Part#	Length	Coil Diameter	Material
58390	18"	3/8"	Spring steel
58410	18"	7/16"	Spring steel
58400	18"	1/2"	Spring steel
58430	18"	5/8"	Spring steel



Ideal for installing a trailer hitch on a vehicle with a hollow frame

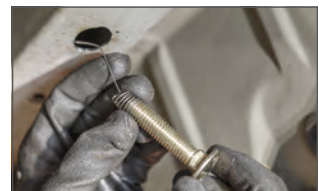

Makes it easier to lead hardware through tough-to-reach holes



ADD MORE FUNCTIONALITY TO YOUR VEHICLE



2
INCH

FRONT MOUNT HITCHES

- 2" x 2" receiver tube opening
- Up to 5,000 lbs. GTW / 500 lbs. TW
- Compatible with a tow hook or shackle mount (9,000 lbs. straight-line pull)
- Allows for easy maneuvering of a trailer into a tight spot
- Tested for safety in accordance with SAE J684
- Precisely welded for superior strength and fit
- May include imported installation hardware (grade-8)
- Limited lifetime warranty (see last page for details)
- **See page 24 for application information**

For front mount application guide go to page 24



Ideal for attaching a snow plow, cargo carrier or other front hitch mount accessories

BETTERWEIGH™ MOBILE TOWING SCALE

- Measures real-time vehicle-trailer weights, including tongue weight, for safer towing
- No more complicated at-home measurements or trips to the scale
- Bluetooth connection provides active readouts on the driver's smartphone
- No-install, plug-and-play setup into vehicle diagnostic port (OBD-II) below the dash
- Accurate within + / - 5%
- Offers easy brake controller setup by measuring exact trailer brake gain needed
- **See page 98 for more information**



51701



Scan to see it in action!

Download the app:
BetterWeigh Towing Scale



Pkg#	Description
51701	Mobile towing scale



2
INCH

FRONT MOUNT HITCH APPLICATION GUIDE

Front Mount Hitches

Make / Model	Style	Years	Part#	Foot Notes	GTW / TW (lbs.)	Price Code	Install Time	Main Body
Buick								
Enclave	--	08 - 12	31045*	D, ●	3,500 / 350	53	30 - 60	Exposed
Rainier	--	04 - 07	31055	D, ●	3,500 / 350	78	30 - 60	Exposed
Cadillac								
Escalade	Excl. hybrid	07 - 20	31012	D	5,000 / 500	55	30 - 60	Concealed
	--	00 - 06	31302	D, ●	5,000 / 500	67	60	Concealed
Escalade EXT	--	07 - 13	31012	D	5,000 / 500	55	30 - 60	Concealed
Chevrolet								
Avalanche	Excl. Z71	07 - 13	31012	D	5,000 / 500	55	30 - 60	Concealed
Avalanche 1500	--	02 - 06	31302	D, ●	5,000 / 500	67	30 - 60	Concealed
Avalanche 2500	--	02 - 06	31302	D, ●	5,000 / 500	67	30 - 60	Concealed
Blazer	4WD, Excl. ZR2	96 - 04	31021	●	3,500 / 350	29	30 - 60	Exposed
	--	92 - 94	31042	●	5,000 / 500	41	30 - 60	Concealed
C1500	--	88 - 99	31042	●	5,000 / 500	41	30 - 60	Concealed
C1500 Suburban	--	92 - 99	31043	--	5,000 / 500	47	30 - 60	Exposed
C2500	--	88 - 00	31043	--	5,000 / 500	47	30 - 60	Exposed
C2500 Suburban	--	92 - 99	31043	--	5,000 / 500	47	30 - 60	Exposed
C3500	--	88 - 00	31043	--	5,000 / 500	47	30 - 60	Exposed
Colorado	Excl. ZR2	15 - 20	31074	D, ●	5,000 / 500	41	30 - 60	Concealed
	Excl. Z71 with front stabilizer bar	10 - 12	31221	D, ●	5,000 / 500	59	30 - 60	Concealed
	Z71 with front stabilizer bar	10 - 12	31030	D, ●	5,000 / 500	47	30 - 60	Exposed
	--	04 - 09	31221	D, ●	5,000 / 500	59	30 - 60	Concealed
Express 1500	--	96 - 03	31016	--	5,000 / 500	27	30 - 60	Exposed
Express 2500	--	96 - 03	31016	--	5,000 / 500	27	30 - 60	Exposed
Express 3500	--	96 - 03	31016	--	5,000 / 500	27	30 - 60	Exposed
K1500	--	88 - 99	31042	●	5,000 / 500	41	30 - 60	Concealed
K1500 Suburban	--	92 - 99	31042	●	5,000 / 500	41	30 - 60	Concealed
K2500	--	88 - 00	31042	●	5,000 / 500	41	30 - 60	Concealed
K2500 Suburban	--	92 - 99	31042	●	5,000 / 500	41	30 - 60	Concealed
K3500	--	88 - 00	31042	●	5,000 / 500	41	30 - 60	Concealed
S10	4WD, Excl. ZR2	94 - 04	31021	●	3,500 / 350	29	30 - 60	Exposed
Silverado 1500	Excl. 2.7L or 3.0L	19 - 20	31088	●	5,000 / 500	45	30 - 60	Concealed
	--	14 - 18	31012	D	5,000 / 500	55	30 - 60	Concealed
	--	14 - 18	31069	D	5,000 / 500	41	30 - 60	Concealed
	--	07 - 13	31322	D, ●	5,000 / 500	47	30 - 60	Concealed
	--	99 - 06	31302	D, ●	5,000 / 500	67	30 - 60	Concealed
Silverado 1500 Classic	--	07 - 07	31302	D, ●	5,000 / 500	67	30 - 60	Concealed
Silverado 1500 HD	--	01 - 06	31108	D, ●	5,000 / 500	47	30 - 60	Concealed
Silverado 1500 HD Classic	--	07 - 07	31108	D, ●	5,000 / 500	47	30 - 60	Concealed
Silverado 1500 LD	--	19 - 19	31069	D	5,000 / 500	41	30 - 60	Concealed
	--	19 - 19	31012	D	5,000 / 500	55	30 - 60	Concealed
Silverado 2500	--	99 - 04	31108	D, ●	5,000 / 500	47	30 - 60	Concealed
Silverado 2500 HD	--	15 - 19	31071	●	5,000 / 500	37	30 - 60	Concealed
	--	11 - 14	31023	D, ●	5,000 / 500	22	30 - 60	Concealed
	--	07 - 10	31109	●	5,000 / 500	41	30 - 60	Concealed
	--	01 - 06	31108	D, ●	5,000 / 500	47	30 - 60	Concealed

● = No drilling required
D = Minor fascia trim

* Continued while supplies last

Applications continued on the following page

Front Mount Hitches

Make / Model	Style	Years	Part#	Foot Notes	GTW / TW (lbs.)	Price Code	Install Time	Main Body
Chevrolet (continued)								
Silverado 2500 HD Classic	--	07 - 07	31108	D, ●	5,000 / 500	47	30 - 60	Concealed
Silverado 3500	--	01 - 06	31108	D, ●	5,000 / 500	47	30 - 60	Concealed
Silverado 3500 Classic	--	07 - 07	31108	D, ●	5,000 / 500	47	30 - 60	Concealed
Silverado 3500 HD	--	15 - 19	31071	●	5,000 / 500	37	30 - 60	Concealed
		11 - 14	31023	D, ●	5,000 / 500	22	30 - 60	Concealed
		07 - 10	31109	●	5,000 / 500	41	30 - 60	Concealed
Suburban	--	15 - 20	31073	D	5,000 / 500	37	30 - 60	Concealed
Suburban 1500	--	07 - 14	31012	D	5,000 / 500	55	30 - 60	Concealed
		00 - 06	31302	D, ●	5,000 / 500	67	30 - 60	Concealed
Suburban 2500	--	01 - 06	31108	D, ●	5,000 / 500	47	30 - 60	Concealed
Tahoe	Excl. PPV or SSV	15 - 20	31073	D	5,000 / 500	37	30 - 60	Concealed
	Excl. hybrid	07 - 14	31012	D	5,000 / 500	55	30 - 60	Concealed
	--	00 - 06	31302	D, ●	5,000 / 500	67	30 - 60	Concealed
	--	95 - 99	31042	●	5,000 / 500	41	30 - 60	Concealed
Trailblazer	--	02 - 09	31055	D, ●	3,500 / 350	78	30 - 60	Exposed
Traverse	--	09 - 12	31045*	D, ●	3,500 / 350	53	30 - 60	Exposed
Chrysler								
Aspen	--	07 - 09	31297	D, ●	5,000 / 500	78	30 - 60	Exposed
Dodge								
Dakota	--	05 - 07	31228	D, ●	3,500 / 350	97	30 - 60	Exposed
		08 - 10	31230	D, ●	3,500 / 350	79	30 - 60	Exposed
	4WD	00 - 04	31080	●	3,500 / 350	75	30 - 60	Concealed
	--	98 - 99	31097	D, ●	3,500 / 350	67	30 - 60	Exposed
Durango	Excl. SRT	11 - 20	31033	D	3,000 / 300	69	30 - 60	Concealed
	--	04 - 09	31297	D, ●	5,000 / 500	78	30 - 60	Exposed
	--	00 - 03	31080	●	3,500 / 350	75	30 - 60	Concealed
	--	98 - 99	31097	D, ●	3,500 / 350	67	30 - 60	Exposed
Ram 1500	4WD	09 - 10	31374	D	5,000 / 500	43	30 - 60	Concealed
	Excl. extended crew cab	06 - 08	31320	D, ●	5,000 / 500	65	30 - 60	Concealed
	Extended crew cab	06 - 08	31017	D	3,500 / 350	53	30 - 60	Exposed
	Sport	06 - 07	31321*	--	5,000 / 500	65	30 - 60	Concealed
	--	02 - 05	31320	D, ●	5,000 / 500	65	30 - 60	Concealed
	Excl. Sport	94 - 01	31604	--	5,000 / 500	63	30 - 60	Concealed
Ram 2500	4WD	10 - 10	31015	D, ●	5,000 / 500	49	30 - 60	Concealed
	--	03 - 09	31017	D	3,500 / 350	53	30 - 60	Exposed
	--	94 - 02	31604	--	5,000 / 500	63	30 - 60	Concealed
Ram 3500	--	10 - 10	31065	D	3,500 / 350	47	30 - 60	Exposed
	Excl. Laramie	03 - 09	31017	D	3,500 / 350	53	30 - 60	Exposed
	--	94 - 02	31604	--	5,000 / 500	63	30 - 60	Concealed
Ford								
E-150	--	08 - 14	31053	D	5,000 / 500	35	30 - 60	Exposed
		03 - 07	33055	--	5,000 / 500	35	30 - 60	Concealed
E-150 Econoline	--	91 - 02	33055	--	5,000 / 500	35	30 - 60	Concealed
E-250	--	08 - 14	31053	D	5,000 / 500	35	30 - 60	Exposed
		03 - 07	33055	--	5,000 / 500	35	30 - 60	Concealed
E-250 Econoline	--	91 - 02	33055	--	5,000 / 500	35	30 - 60	Concealed
E-350 Econoline	--	91 - 98	33055	--	5,000 / 500	35	30 - 60	Concealed
E-350 Super Duty	--	08 - 14	31053	D	5,000 / 500	35	30 - 60	Exposed
		99 - 07	33055	--	5,000 / 500	35	30 - 60	Concealed

● = No drilling required
D = Minor fascia trim

* Continued while supplies last

Applications continued on the following page

Front Mount Hitches

Make / Model	Style	Years	Part#	Foot Notes	GTW / TW (lbs.)	Price Code	Install Time	Main Body
Ford (continued)								
Escape	--	11 - 12	31025*	D	3,500 / 350	57	30 - 60	Exposed
		05 - 10	31650	D	3,500 / 350	67	90+	Exposed
Excursion	--	00 - 05	31114	●	5,000 / 500	75	30 - 60	Concealed
Expedition	--	18 - 20	31083	●	5,000 / 500	47	30 - 60	Concealed
		09 - 17	31068	D, ●	5,000 / 500	59	30 - 60	Exposed
	4WD	07 - 08	31368	D, ●	5,000 / 500	59	30 - 60	Concealed
	4WD with factory tow hooks	03 - 06	31352	D, ●	5,000 / 500	59	30 - 60	Concealed
	4WD with factory tow hooks	99 - 02	31038	●	5,000 / 500	49	30 - 60	Concealed
		97 - 98	31049	●	5,000 / 500	47	30 - 60	Concealed
Explorer	Excl. 2.0L EcoBoost	11 - 16	31052	D	3,500 / 350	67	30 - 60	Exposed
	--	07 - 10	31545	●	5,000 / 500	71	30 - 60	Concealed
	Excl. Sport	02 - 06	31540	D	5,000 / 500	41	30 - 60	Concealed
	--	97 - 01	31051	--	3,500 / 350	65	30 - 60	Concealed
Explorer Sport Trac	--	07 - 10	31545	●	5,000 / 500	71	30 - 60	Concealed
		01 - 05	31407	●	3,500 / 350	35	30 - 60	Exposed
		01 - 05	31029*	--	5,000 / 500	57	30 - 60	Exposed
F-150	--	15 - 20	31083	●	5,000 / 500	47	30 - 60	Concealed
		09 - 14	31068	D, ●	5,000 / 500	59	30 - 60	Exposed
		04 - 08	31352	D, ●	5,000 / 500	59	30 - 60	Concealed
	4WD with factory tow hooks	99 - 03	31038	●	5,000 / 500	49	30 - 60	Concealed
		97 - 98	31049	●	5,000 / 500	47	30 - 60	Concealed
	--	92 - 96	31026	--	5,000 / 500	65	30 - 60	Concealed
F-150 Heritage	4WD with factory tow hooks	04 - 04	31038	●	5,000 / 500	49	30 - 60	Concealed
F-250	4WD with factory tow hooks	99 - 99	31038	●	5,000 / 500	49	30 - 60	Concealed
		97 - 98	31049	●	5,000 / 500	47	30 - 60	Concealed
	Heavy duty, 2WD	97 - 97	31311	●	5,000 / 500	45	30 - 60	Exposed
	4WD	92 - 97	31310	●	5,000 / 500	41	30 - 60	Concealed
	2WD	92 - 96	31311	●	5,000 / 500	45	30 - 60	Exposed
F-250 Super Duty	--	17 - 20	31078	D, ●	5,000 / 500	53	30 - 60	Concealed
	4WD	11 - 16	31018	D, ●	5,000 / 500	57	30 - 60	Concealed
	--	08 - 10	31008	D, ●	5,000 / 500	41	30 - 60	Concealed
		04 - 07	31114	●	5,000 / 500	75	30 - 60	Concealed
	With blocker beam	99 - 03	31014	--	5,000 / 500	75	30 - 60	Concealed
	Without blocker beam	99 - 03	31114	●	5,000 / 500	75	30 - 60	Concealed
F-350	4WD	92 - 97	31310	●	5,000 / 500	41	30 - 60	Concealed
	2WD diesel only	97 - 97	31311	●	5,000 / 500	45	30 - 60	Exposed
	2WD	92 - 96	31311	●	5,000 / 500	45	30 - 60	Exposed
F-350 Super Duty	Excl. dual rear wheels	20 - 20	31078	D, ●	5,000 / 500	53	30 - 60	Concealed
	--	17 - 19	31078	D, ●	5,000 / 500	53	30 - 60	Concealed
	4WD	11 - 16	31018	D, ●	5,000 / 500	57	30 - 60	Concealed
	--	08 - 10	31008	D, ●	5,000 / 500	41	30 - 60	Concealed
		04 - 07	31114	●	5,000 / 500	75	30 - 60	Concealed
	With blocker beam	99 - 03	31014	--	5,000 / 500	75	30 - 60	Concealed
	Without blocker beam	99 - 03	31114	●	5,000 / 500	75	30 - 60	Concealed
F-450 Super Duty	--	17 - 19	31078	D, ●	5,000 / 500	53	30 - 60	Concealed
F-450 / F-550 Super Duty	--	08 - 10	31008	D, ●	5,000 / 500	41	30 - 60	Concealed
		99 - 07	31114	●	5,000 / 500	75	30 - 60	Concealed
Ranger	Excl. with front cross member and Canadian built 2WD models	92 - 11	31063	D	3,500 / 350	65	30 - 60	Concealed

● = No drilling required
D = Minor fascia trim

* Continued while supplies last

Applications continued on the following page

Front Mount Hitches

Make / Model	Style	Years	Part#	Foot Notes	GTW / TW (lbs.)	Price Code	Install Time	Main Body
GMC								
Acadia	--	09 - 11	31045*	D, ●	3,500 / 350	53	30 - 60	Exposed
C1500	--	88 - 99	31042	●	5,000 / 500	41	30 - 60	Concealed
C1500 Suburban	--	92 - 99	31043	--	5,000 / 500	47	30 - 60	Exposed
C2500	--	88 - 00	31043	--	5,000 / 500	47	30 - 60	Exposed
C2500 Suburban	--	92 - 99	31043	--	5,000 / 500	47	30 - 60	Exposed
C3500	--	88 - 00	31043	--	5,000 / 500	47	30 - 60	Exposed
Canyon	--	15 - 20	31074	D, ●	5,000 / 500	41	30 - 60	Concealed
	Excl. Z71 with front stabilizer bar	10 - 12	31221	D, ●	5,000 / 500	59	30 - 60	Concealed
	Z71 with front stabilizer bar	10 - 12	31030	D, ●	5,000 / 500	47	30 - 60	Exposed
	--	04 - 09	31221	D, ●	5,000 / 500	59	30 - 60	Concealed
Envoy	--	02 - 09	31055	D, ●	3,500 / 350	78	30 - 60	Exposed
Jimmy	4WD	94 - 01	31021	●	3,500 / 350	29	30 - 60	Exposed
K1500	--	88 - 99	31042	●	5,000 / 500	41	30 - 60	Concealed
K1500 Suburban	--	92 - 99	31042	●	5,000 / 500	41	30 - 60	Concealed
K2500	--	88 - 00	31042	●	5,000 / 500	41	30 - 60	Concealed
K2500 Suburban	--	92 - 99	31042	●	5,000 / 500	41	30 - 60	Concealed
K3500	--	88 - 00	31042	●	5,000 / 500	41	30 - 60	Concealed
Savana 1500	--	96 - 03	31016	--	5,000 / 500	27	30 - 60	Exposed
Savana 2500	--	96 - 03	31016	--	5,000 / 500	27	30 - 60	Exposed
Savana 3500	--	96 - 03	31016	--	5,000 / 500	27	30 - 60	Exposed
Sierra 1500	Excl. 2.7L or 3.0L	19 - 20	31088	●	5,000 / 500	45	30 - 60	Concealed
	--	14 - 18	31012	D	5,000 / 500	55	30 - 60	Concealed
	--	14 - 18	31069	D	5,000 / 500	41	30 - 60	Concealed
	--	07 - 13	31322	D, ●	5,000 / 500	47	30 - 60	Concealed
	--	99 - 06	31302	D, ●	5,000 / 500	67	30 - 60	Concealed
Sierra 1500 Classic	--	07 - 07	31302	D, ●	5,000 / 500	67	30 - 60	Concealed
Sierra 1500 HD	--	01 - 06	31108	D, ●	5,000 / 500	47	30 - 60	Concealed
Sierra 1500 HD Classic	--	07 - 07	31108	D, ●	5,000 / 500	47	30 - 60	Concealed
Sierra 1500 Limited	--	19 - 19	31069	D	5,000 / 500	41	30 - 60	Concealed
			31012	D	5,000 / 500	55	30 - 60	Concealed
Sierra 2500	--	99 - 04	31108	D, ●	5,000 / 500	47	30 - 60	Concealed
Sierra 2500 HD	--	15 - 19	31071	●	5,000 / 500	37	30 - 60	Concealed
		11 - 14	31023	D, ●	5,000 / 500	22	30 - 60	Concealed
		07 - 10	31109	●	5,000 / 500	41	30 - 60	Concealed
		01 - 06	31108	D, ●	5,000 / 500	47	30 - 60	Concealed
Sierra 2500 HD Classic	--	07 - 07	31108	D, ●	5,000 / 500	47	30 - 60	Concealed
Sierra 3500	--	01 - 06	31108	D, ●	5,000 / 500	47	30 - 60	Concealed
Sierra 3500 Classic	--	07 - 07	31108	D, ●	5,000 / 500	47	30 - 60	Concealed
Sierra 3500 HD	--	15 - 19	31071	●	5,000 / 500	37	30 - 60	Concealed
		11 - 14	31023	D, ●	5,000 / 500	22	30 - 60	Concealed
		07 - 10	31109	●	5,000 / 500	41	30 - 60	Concealed
Sonoma	4WD	94 - 04	31021	●	3,500 / 350	29	30 - 60	Exposed
Yukon	--	15 - 20	31073	D	5,000 / 500	37	30 - 60	Concealed
	Excl. hybrid	07 - 14	31012	D	5,000 / 500	55	30 - 60	Concealed
	--	00 - 06	31302	D, ●	5,000 / 500	67	30 - 60	Concealed
	--	92 - 99	31042	●	5,000 / 500	41	30 - 60	Concealed
Yukon XL	--	15 - 20	31073	D	5,000 / 500	37	30 - 60	Concealed
Yukon XL 1500	--	00 - 06	31302	D, ●	5,000 / 500	67	30 - 60	Concealed
Yukon XL 2500	--	01 - 06	31108	D, ●	5,000 / 500	47	30 - 60	Concealed

● = No drilling required
D = Minor fascia trim

* Continued while supplies last

Applications continued on the following page

Front Mount Hitches

Make / Model	Style	Years	Part#	Foot Notes	GTW / TW (lbs.)	Price Code	Install Time	Main Body
Honda								
Pilot	--	12 - 15	31064	--	3,500 / 350	55	30 - 60	Exposed
		09 - 11	31024*	D	3,500 / 350	49	30 - 60	Exposed
		03 - 08	33328	D, ●	3,500 / 350	67	30 - 60	Exposed
Ridgeline	--	17 - 20	31082	D	5,000 / 500	55	30 - 60	Exposed
		06 - 14	33328	D, ●	3,500 / 350	67	30 - 60	Exposed
Hummer								
H3	--	06 - 10	31270	●	3,000 / 300	59	30 - 60	Exposed
Jeep								
Cherokee	--	84 - 01	31084	D	3,000 / 300	27	30 - 60	Exposed
Comanche	--	86 - 92	31084	D	3,000 / 300	27	30 - 60	Exposed
Commander	4WD	06 - 10	31056	--	3,500 / 350	65	30 - 60	Exposed
Gladiator	--	20 - 21	31086	D, ●	3,500 / 350	22	30 - 60	Concealed
Grand Cherokee	Excl. SRT, SRT8, Trailhawk, and models with factory tow hooks	11 - 17	31033	D	3,000 / 300	69	30 - 60	Concealed
	--	05 - 10	31047	--	3,000 / 300	63	90+	Exposed
	--	02 - 04	31048	--	3,500 / 350	63	30 - 60	Concealed
Liberty	--	08 - 13	31020	D	3,000 / 300	69	30 - 60	Concealed
		03 - 07	31022	--	3,500 / 350	53	30 - 60	Exposed
Wagoneer	Except Grand Wagoneer	84 - 90	31084	D	3,000 / 300	27	30 - 60	Exposed
Wrangler	JL	18 - 21	31086	D, ●	3,500 / 350	22	30 - 60	Concealed
	JK, Excl. Hard Rock and 75th Anniversary bumpers	07 - 18	31432	D, ●	3,500 / 350	47	30 - 60	Concealed
	JK, with hard rock bumper	07 - 18	31433	●	3,500 / 525	61	30 - 60	Exposed
	--	97 - 06	31028	--	3,500 / 350	45	30 - 60	Exposed
	--	87 - 06	31408	D, ●	3,500 / 350	25	30 - 60	Exposed
Lincoln								
Mark LT	--	06 - 08	31352	D, ●	5,000 / 500	59	30 - 60	Concealed
Navigator	--	09 - 17	31068	D, ●	5,000 / 500	59	30 - 60	Exposed
	4WD	07 - 08	31368	D, ●	5,000 / 500	59	30 - 60	Concealed
Mazda								
Tribute	--	05 - 11	31650	D	3,500 / 350	67	90+	Exposed
Mercury								
Mariner	--	11 - 11	31025*	D	3,500 / 350	57	30 - 60	Exposed
		05 - 10	31650	D	3,500 / 350	67	90+	Exposed
Mountaineer	--	07 - 10	31545	●	5,000 / 500	71	30 - 60	Concealed
Mitsubishi								
Raider	--	08 - 09	31230	D, ●	3,500 / 350	79	30 - 60	Exposed
Nissan								
Armada	--	17 - 20	31081	●	5,000 / 500	67	30 - 60	Exposed
Frontier	--	05 - 20	31241	●	3,500 / 350	55	30 - 60	Exposed
Pathfinder	--	05 - 12	31241	●	3,500 / 350	55	30 - 60	Exposed
Titan	4WD	09 - 15	31061	--	5,000 / 500	69	30 - 60	Exposed
	--	04 - 08	31199	--	5,000 / 500	63	30 - 60	Exposed
Titan XD	--	16 - 17	31077	●	5,000 / 500	45	30 - 60	Exposed
Xterra	--	05 - 15	31514	●	3,500 / 350	71	30 - 60	Exposed

● = No drilling required
D = Minor fascia trim

* Continued while supplies last

Applications continued on the following page

Front Mount Hitches

Make / Model	Style	Years	Part#	Foot Notes	GTW / TW (lbs.)	Price Code	Install Time	Main Body
Ram								
1500	Excl. Rebel or diesel	19 - 21	31090	●	5,000 / 500	63	30 - 60	Concealed
	Excl. Rebel	19 - 21	31087*	●	5,000 / 500	49	30 - 60	Concealed
	4WD	11 - 18	31374	D	5,000 / 500	43	30 - 60	Concealed
1500 Classic	4WD, Excl. Warlock	19 - 21	31374	D	5,000 / 500	43	30 - 60	Concealed
2500	--	19 - 20	31089	D, ●	5,000 / 500	49	30 - 60	Concealed
	4WD	11 - 18	31015	D, ●	5,000 / 500	49	30 - 60	Concealed
3500	4WD	13 - 18	31067	D, ●	5,000 / 500	61	30 - 60	Concealed
	--	11 - 12	31065	D	3,500 / 350	47	30 - 60	Exposed
Suzuki								
Equator	--	09 - 12	31241	●	3,500 / 350	55	30 - 60	Exposed
Toyota								
4Runner	Limited	10 - 20	31054	●	3,500 / 350	71	30 - 60	Exposed
	SR5	14 - 21	31076	●	3,500 / 350	75	30 - 60	Exposed
		10 - 13	31054	●	3,500 / 350	71	30 - 60	Exposed
	SR5 Premium	18 - 21	31076	●	3,500 / 350	75	30 - 60	Exposed
	Trail	14 - 16	31076	●	3,500 / 350	75	30 - 60	Exposed
		10 - 13	31367	●	3,500 / 350	71	30 - 60	Exposed
	TRD Off-Road	17 - 21	31076	●	3,500 / 350	75	30 - 60	Exposed
	TRD Off-Road Premium	18 - 21	31076	●	3,500 / 350	75	30 - 60	Exposed
--	07 - 09	31367	●	3,500 / 350	71	30 - 60	Exposed	
FJ Cruiser	--	07 - 14	31367	●	3,500 / 350	71	30 - 60	Exposed
Land Cruiser	--	08 - 18	31198	●	5,000 / 500	41	30 - 60	Exposed
Sequoia	--	08 - 20	31198	●	5,000 / 500	41	30 - 60	Exposed
		01 - 07	31180	--	5,000 / 500	49	30 - 60	Exposed
Tacoma	--	16 - 21	31075	D, ●	3,500 / 350	47	30 - 60	Exposed
		05 - 15	31313	●	3,500 / 350	75	30 - 60	Exposed
		01 - 04	31013	--	5,000 / 500	45	30 - 60	Exposed
Tundra	--	07 - 20	31198	●	5,000 / 500	41	30 - 60	Exposed
		00 - 06	31180	--	5,000 / 500	49	30 - 60	Exposed

● = No drilling required
D = Minor fascia trim

* Continued while supplies last

TRAILER HITCHES & CUSTOM WIRING APPLICATION GUIDE

With over 1,000 different custom-fit hitch designs and over 400 custom wiring products, CURT has an application for virtually every vehicle on the road today. Our Application Guide makes it easy to locate the correct part for your customer's vehicle, simply using the make, model, style and year. For the most up-to-date fitment data, we also offer an online version at curtmfg.com.

CLASS 1 & 2 TRAILER HITCH ORDERING OPTIONS

Hitch only



With ball mount, pin & clip



Ordering Option	Add-On#	Example Order#
Hitch only	None	11290
Hitch with ball mount, pin & clip	3	112903



HOW TO CONFIRM VEHICLE MODEL YEAR

Each VIN (vehicle identification number) is unique and has become standard in all vehicles manufactured since 1981. Of this 17-digit number, the 10th digit represents the model year. Use the table below to find the year that corresponds with each letter or number. **Note:** A VIN will never contain the letters I (i), O (o), Q (q), U (u) or Z (z).

Example VIN tag

DATE: 06/20	GVWR 7200LB / 3266KG
FRONT GAWR: 3750LB	REAR GAWR: 3850LB
1701 KB WITH 1745KG WITH	
P275 / 65R18 TIRES P275/65R18 TIRES	
18X7.5J RIMS 18X7.5J RIMS	
AT 240 KPO/35PSI COLD AT 240 KPO/35PSI COLD	
THIS VEHICLE CONFORMS TO ALL APPLICABLE FEDERAL MOTOR VEHICLE SAFETY STANDARDS IN EFFECT ON THE DATE OF MANUFACTURE SHOWN ABOVE.	
VIN: XXXXXXXXX M XXXXXXX	
TYPE: TRUCK	

VIN-to-year chart

Code	Year	Code	Year	Code	Year	Code	Year
A	1980	R	1994	8	2008	N	2022
B	1981	S	1995	9	2009	P	2023
C	1982	T	1996	A	2010	R	2024
D	1983	V	1997	B	2011	S	2025
E	1984	W	1998	C	2012	T	2026
F	1985	X	1999	D	2013	V	2027
G	1986	Y	2000	E	2014	W	2028
H	1987	1	2001	F	2015	X	2029
J	1988	2	2002	G	2016	Y	2030
K	1989	3	2003	H	2017	1	2031
L	1990	4	2004	J	2018	2	2032
M	1991	5	2005	K	2019	3	2033
N	1992	6	2006	L	2020	4	2034
P	1993	7	2007	M	2021	5	2035

M indicates a 2021 model year

TRAILER HITCH GUIDE FOOTNOTE KEY

Trailer Hitches Application Guide Footnote Key

A Allow additional installation time	H Will not fit vehicles with twin tailpipes	R Boxed due to bolt-on arms
AA Main body concealed	HE Hole enlargement required	T Minor modifications required
B Relocate or modify exhaust	I Will not fit with full size spare	TG Compatible with Tommy Gate lifts
BB Main body exposed	J No spare tire relocation	U May require battery removal
CC Roll pan modification required	K OEM-style hitch	V Undercar trimming (not fascia) required
CF Carbide black finish	L Fixed draw bar	VT Vertical receiver tube
D Minor fascia trim required	M Round tube main body	W Only vehicles with boxed rear bumper
E Noticeable fascia trim required	N Continued while supplies last	X 158" WB models must remove brace 118" WB models must relocate spare tire
F Will not fit vehicles with ground effects	P Not with roll pan bumper	Y Extra shipping cost as parcel
G Add'l install w/ load level air compressors	Q Temporary bumper removal	Z No drilling required

CUSTOM WIRING GUIDE FOOTNOTE KEY

Custom Wiring Application Guide Footnote Key

T1 Multiple parts available. Visit curtmfg.com	T18 SE models only	T35 Excluding Police Package
T2 Replaces factory connector with 4-flat	T19 Excluding SE models	T36 Built after 11/02
T3 Replaces factory connector with 6-way	T20 Limited 2.0L and EX 2.0L models only	T37 US vehicles only
T4 Replaces factory connector with 7-way	T21 Excluding LTZ	T38 Excluding Limited
T5 Adds 4-flat to factory equipped 7-way	T22 Excluding plug-in models	T39 Limited only
T6 Without LED taillights	T23 CX & CXL only	T40 Hybrid Blue only
T7 With LED taillights	T24 2-door	T41 Excluding Hybrid Blue
T8 With factory tow package	T25 Excluding Premier	T42 Excluding SX
T9 Without factory tow package	T26 Premier only	T43 V6 only
T10 Hybrid only	T27 LTZ only	T44 Excluding WRX models
T11 Excluding hybrid	T28 LX & Touring only	T45 Excluding 2012 base model
T12 Excluding EX and Limited	T29 Excluding LX & Touring	T46 Excluding GSR & R-Line models
T13 Excluding right hand drive	T30 Excluding SE & SEL	T47 Titanium only
T14 AWD models only	T31 SE & SEL only	T48 S or SE only
T15 Excluding Grand Touring	T32 Flareside bed	T49 Built in USA
T16 WRX only	T33 Excluding flareside bed	T50 Built in Mexico
T17 Single rear wheels	T34 Built before 11/02	N Continued while supplies last

APPLICATION GUIDE ELECTRICAL SYSTEM NOTES

Electrical System Notes & Abbreviations

1 2-wire system - No converter needed, 20-minute install See page 163 and 165 for suggested splice-in plugs	5 3-wire system - Use powered converter, 45-minute install
2 2-wire system - Use powered converter, 45-minute install See page 148 for suggested splice-in converter	6 3-wire system - Use HD powered converter, 45-minute install
3 2-wire system - Use multi-function converter, 45-minute install See page 148 for suggested splice-in converter	7 System requires PWM-ST converter, 45-minute install
4 3-wire system - Use non-powered converter, 20-minute install	8 System requires PWM-STT converter, 45-minute install
	9 System requires low-side switching converter, 45-minute install
	10 System type to be determined at time of install
	11 Vehicle plug may require dealer activation

PULSE WIDTH MODULATION (PWM) SYSTEM TYPES: **ST** - Stop, Tail and **STT** - Stop, Tail, Turn



TOWING ACCESSORIES

TRUST THE TOWING EXPERTS

RockerBall™ towing starter kit

FEATURED PRODUCTS

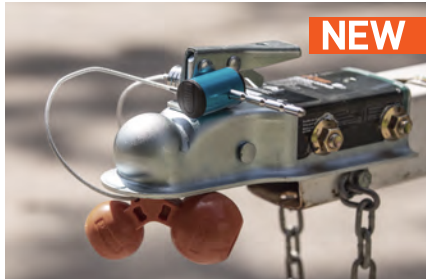

Universal coupler lock

One lock for all trailers! This unique tri-ball lock fits 1-7/8", 2" and 2-5/16" couplers, and it has built-in safety points for max theft deterrence.



Rebellion™ XD 2-1/2"

New to the Rebellion™ XD family, this heavy-duty cushion hitch fits class 5 2-1/2" receivers. It is available with a pre-kitted dual ball.



Anti-rattle hitch clamps

Stop annoying vibrations with our new clamp-style anti-rattles. They fit hollow or solid shanks and are available for 2" and 2-1/2" receivers.

PRODUCT INDEX



92
Trailer
Balls



98
BetterWeigh™
Towing Scale



99
Ball
Mounts



105
Forged
Ball Mounts



106
Adjustable
Ball Mounts



112
Tow Hook
Mounts



114
Extenders
& Adapters



116
Hitch Locks,
Pins & Clips



121
Specialty Locks
& Anti-Rattles



124
Pintle Hooks
& Mounts



130
Trailer Hitch
Accessories



133
Fab
Components

TRAILER BALLS



**SHOCKDROP™
TECHNOLOGY**

For Rebellion™ XD cushion hitches see page 106

ShockDrop™ technology is an adaptive, dynamic towing system that is engineered to reduce vibrations, rattling and strain on the vehicle. It does this by using an integrated, flexible polyurethane isolator for improved comfort and control. Compared to other cushion hitch options, ShockDrop™ is simple and virtually maintenance-free.

Enhanced comfort.

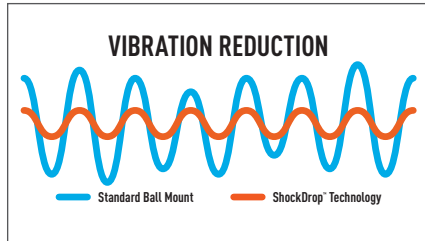

Unlike a traditional metal-on-metal towing connection, ShockDrop™ absorbs unevenness in the road to maximize comfort

Improved control.

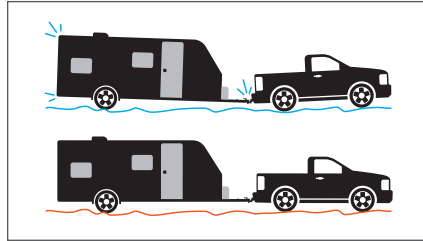

ShockDrop™ dynamically reacts to jarring, limiting its effects and giving the driver increased control on the road

Unmatched confidence.

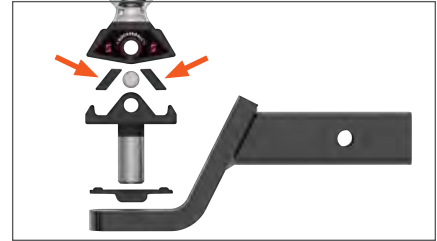

Unlike a cushion hitch with an airbag or bearings, ShockDrop™ is virtually maintenance-free and is tested for thousands of cycles



**ROCKERBALL™
TRAILER BALLS**

For RockerBall™ products see adjacent page

- Dampens jerking and jarring from bumps and potholes for smoother towing
- Cushioned isolators reduce rattling and vibration for a more comfortable ride
- Reduces shock loads to the vehicle during sudden braking or acceleration
- Minimizes stress on tow vehicle's brakes and suspension for extended longevity
- Virtually maintenance-free with no airbag or bearings to service
- Anti-swivel base keeps RockerBall™ locked in place
- Forged steel construction with a durable carbide black powder coat finish on base and chrome plating on ball
- Tested for safety to meet SAE J684 specifications
- Not compatible with Rebellion™ XD ball mount



Scan to learn more



40047



Dynamic trailer balls featuring ShockDrop™ technology reduce jerking and jarring



Retrofits onto most existing ball mounts to improve current towing experience

40247



Grease zerk fitting provides easy lubrication



COMFORT. CONTROL. CONFIDENCE.



ROCKERBALL™ STARTER KITS

- Includes all the accessories needed to complement a trailer hitch in one kit; ball mount, RockerBall™ and anti-rattle kit



Part#	Shank Size	GTW / TW	Ball Diameter	Drop	Length	Included Parts
45143	2"	7,500 / 750 lbs.	2"	3"	8-1/4"	45050 ball mount, 40047 RockerBall™, 22321 anti-rattle hitch pin
45144	2"	7,500 / 750 lbs.	2"	5"	9-1/4"	45070 ball mount, 40047 RockerBall™, 22321 anti-rattle hitch pin



ROCKERBALL™ TRAILER BALLS

Scan to learn more



Shank Diameter (C)	Shank Length (B)	Rise (D)	Tongue Width (E)	GTW	Pkg Box#	Pkg Throne#
2" Ball Diameter (A)						
3/4"	2-1/8"	1-1/2"	2"	3,500 lbs.	--	40246
1"	2-1/8"	1-1/2"	2-1/2"	7,500 lbs.	40047	40247
2-5/16" Ball Diameter (A)						
1"	2-1/2"	1-5/8"	2-1/2"	7,500 lbs.	--	40248
1-1/4"	2-7/8"	1-5/8"	3"	12,000 lbs.	--	40249

Measuring RockerBall™

- A: Ball diameter
- B: Shank length
- C: Shank diameter
- D: Rise
- E: Tongue width

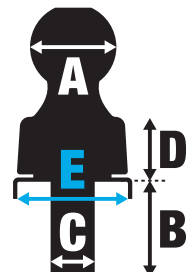

STANDARD TRAILER BALLS

- Chrome-plated, stainless steel and raw trailer balls available
- Fine threads provide superior holding strength
- Tested for safety to meet U.S. VESC specifications

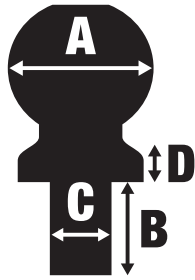

Measuring a trailer ball

- A: Ball diameter
- B: Shank length
- C: Shank diameter
- D: Rise

Chrome-plated

NEW

Stainless steel

Raw

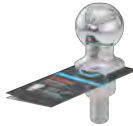

Bulk tag



Half throne



Bulk tag



Full throne



Bulk tag

Shank Diameter (C)	Shank Length (B)	Rise (D)	GTW	Chrome Bulk#	Chrome Full Throne#	Chrome Half Throne#	Stainless Bulk#	Stainless Full Throne#	Raw Bulk#
1-7/8" Ball Diameter (A)									
3/4"	1-5/8"	0"	2,000 lbs.	40001	40061	40161 N	--	--	--
3/4"	2-1/8"	0"	2,000 lbs.	40015	40063	--	40050	40080	--
3/4"	3"	0"	2,000 lbs.	40016	40071	--	--	--	--
1"	2-1/8"	0"	3,500 lbs.	40002	40062	40162 N	40051	40081	--
1"	2-1/8"	2"	3,500 lbs.	40032	--	--	--	--	--
1"	2-3/16"	1"	3,500 lbs.	40031	--	--	--	--	--
1"	3"	0"	3,500 lbs.	40017	40072	--	--	--	--
2" Ball Diameter (A)									
3/4"	1-3/4"	0"	3,500 lbs.	40003	40064	40164 N	--	--	--
3/4"	2-1/8"	0"	3,500 lbs.	40018	40065	--	40052	40082	--
3/4"	3"	0"	3,500 lbs.	40019	40073	--	--	--	--
1"	2-1/8"	0"	6,000 lbs.	40004	40066	40166 N	40053	40083	--
1"	2-1/8"	0"	7,500 lbs.	40037	40070	40170 N	--	--	--
1"	2-1/8"	1"	6,000 lbs.	40033	--	--	--	--	--
1"	2-1/8"	2"	6,000 lbs.	40034	--	--	--	--	--
1"	2-1/4"	0"	12,000 lbs.	40038*	--	--	--	--	--
1"	3"	0"	6,000 lbs.	40020	40074	--	--	--	--
1-1/4"	2-5/8"	0"	10,000 lbs.	40090	40069	40190 N	40056	--	--
2-5/16" Ball Diameter (A)									
1"	2-1/8"	0"	7,500 lbs.	40005	40067	40167 N	40054	40084	--
1"	2-1/4"	0"	10,000 lbs.	40007	--	--	--	--	--
1"	2-1/4"	0"	12,000 lbs.	40039*	--	--	--	--	40042*
1"	3"	0"	6,000 lbs.	40021	40075	--	--	--	--
1-1/4"	2-5/8"	0"	10,000 lbs.	40006	40068	40168 N	--	--	--
1-1/4"	2-5/8"	0"	15,000 lbs.	40030*	40078*	40178* N	40055	--	--
1-1/4"	2-5/8"	0"	30,000 lbs.	--	--	--	--	--	40085*
1-1/4"	2-5/8"	1"	10,000 lbs.	40035	--	--	--	--	--
1-1/4"	2-5/8"	1"	25,000 lbs.	--	--	--	--	--	40086*
1-1/4"	2-5/8"	2"	10,000 lbs.	40036	--	--	--	--	--
1-1/4"	2-5/8"	2"	25,000 lbs.	--	--	--	--	--	40087*
1-1/4"	2-3/4"	0"	20,000 lbs.	40008*	40009*	--	--	--	--
1-1/4"	3"	0"	6,000 lbs.	40022	40076	--	--	--	--
2"	3-1/2"	0"	30,000 lbs.	--	--	--	--	--	40088**
3" Ball Diameter (A)									
2"	3-1/4"	0"	30,000 lbs.	--	--	--	--	--	40089**
50mm Ball Diameter (A)									
3/4"	50mm	0"	1,600 kg.	40099	--	--	--	--	--

*Heat-treated

**Heat-treated, coarse-threaded

ATV-LAWN TRACTOR TRAILER BALLS

- Fits ATVs, UTVs or lawn tractors with 5/8" ball hole
- Constructed from high-strength, hot-forged steel
- Enhanced durability with chrome-plated finish
- Fine threading for superior holding strength
- Tested for safety to meet U.S. VESC V-5 specifications



Ball Diameter	Shank Diameter	Shank Length	Rise	GTW	Torque Specification	Bulk#	Pkg#
1-7/8"	5/8"	1-3/4"	0"	2,000 lbs.	90 lb-ft.	40095	40096
2"	5/8"	1-3/4"	0"	2,000 lbs.	90 lb-ft.	40097	40098

TRAILER BALL COVERS

- Protects trailer ball when not in use

Bulk#	Pkg#	Finish	Fits
21800	21801	Black rubber	1-7/8" and 2" trailer balls
21810	21811	Black rubber	2-5/16" trailer balls



REPLACEMENT NUTS & WASHERS

- Fits trailer ball shanks with fine threads
- Helical lock washer ensures a secure mount
- Constructed from zinc-plated steel
- Tested for safety to meet U.S. VESC V-5 specifications

Pkg#	Torque Specification	Description
40103	160 lb-ft.	3/4" nut and lock washer
40104	250 lb-ft.	1" nut and lock washer
40105	450 lb-ft.	1-1/4" nut and lock washer



REDUCER BUSHINGS

- Reduces hole size, allowing use of trailer balls with smaller shank diameters



Bulk#	Pkg#	Reduces From	Reduces To	Finish
21100	21101	1"	3/4"	Yellow zinc-plated
21200	21201	1-1/4"	1"	Yellow zinc-plated
21300	21301*	1-3/8"	1-1/4"	Yellow zinc-plated

* Continued while supplies last



Reduces the hole size of your ball mount to fit smaller trailer balls

BALL MOUNT TONGUE SLEEVE

- Allows for single-wrench trailer ball torquing
- For use with CURT and other 'wrench flat' trailer balls
- See our trailer ball box-end wrench below
- Patent #8,376,387



Tighten your trailer ball with a single wrench

Pkg#	Fits	Ball Hole Size	Finish
45007	2-1/2" tongue width	1"	Gloss black

TRAILER BALL BOX-END WRENCH

- Six-point design ensures the best grip and protects against rounding of the nut
- Forged, hardened steel construction with a durable chrome plating



Six-point design protects against rounding the nut on the trailer ball

Part#	Length	Wrench Sizes	Fits
20001	15-1/2"	1-1/8" and 1-1/2"	3/4" and 1" shanks

SWITCH BALL™ TRAILER BALLS

- Exclusive 'J' groove design for secure attachment to the shank
- No tools, coins or pins required for trailer ball install or removal
- Shank bears the weight, freeing the coupler from binding
- Built from high-strength steel
- Protected by a premium grade, nickel chrome-plated finish
- Neck covers protect the Switch Ball™ neck from the elements when not in use
- Tested for safety in accordance with SAE J684
- U.S. patent #5,169,168; Canadian patent #1,325,445

Features

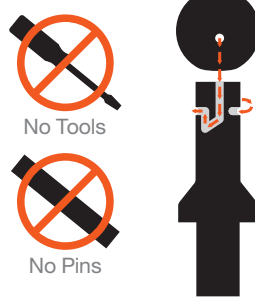

Measuring a Switch Ball™

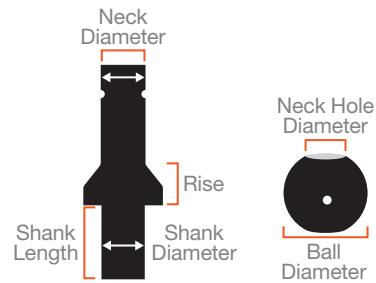

Place the ball on the shank



Twist the ball down onto the shank to lock



42178



42280

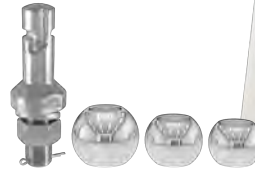

42225



41352



41353

Bulk#	Pkg#	Ball Diameter and GTW			Shank GTW	Shank Length	Shank Diameter	Neck Diameter	Neck Hole Diameter	Rise	Finish
		1-7/8"	2"	2-5/16"							
Switch Ball™ Trailer Ball Sets											
--	42178	3,500 lbs.	6,000 lbs.	--	--	2-1/4"	1"	1"	--	0"	Chrome-plated
--	42225	3,500 lbs.	6,000 lbs.	8,000 lbs.	--	2-1/4"	1"	1-1/8"	--	3/4"	Chrome-plated
--	42280	--	6,000 lbs.	8,000 lbs.	--	2-1/4"	1"	1-1/8"	--	3/4"	Chrome-plated
--	41782	3,500 lbs.	6,000 lbs.	--	--	1-5/8"	3/4"	1"	--	0"	Chrome-plated
--	41783*	3,500 lbs.	6,000 lbs.	--	--	2-1/4"	3/4"	1"	--	0"	Chrome-plated
Switch Ball™ Neck Covers											
--	41352*	--	--	--	--	--	--	1"	--	--	Black rubber
--	41353*	--	--	--	--	--	--	1"	--	--	Red rubber
--	41355*	--	--	--	--	--	--	1-1/8"	--	--	Red rubber
Replacement Trailer Balls											
41780*	--	6,000 lbs.	--	--	--	--	--	--	1"	--	Chrome-plated
42780*	--	8,000 lbs.	--	--	--	--	--	--	1-1/8"	--	Chrome-plated
42200*	--	--	8,000 lbs.	--	--	--	--	--	1-1/8"	--	Chrome-plated
42203*	--	--	--	8,000 lbs.	--	--	--	--	1-1/8"	--	Chrome-plated
Replacement Shanks											
41341*	--	--	--	--	3,500 lbs.	2-1/4"	3/4"	1"	--	0"	Chrome-plated

* Continued while supplies last



CONVENIENT, REAL-TIME WEIGHT READINGS

BETTERWEIGH™ MOBILE TOWING SCALE

- Measures real-time vehicle-trailer weights for safer, easier towing and hauling
- No more complicated at-home measurements or trips to the scale
- Bluetooth connection provides active readouts on the driver's smartphone
- No-install, plug-and-play setup into vehicle diagnostic port (OBD-II) below the dash
- Accurate within + / - 5%
- Offers easy brake controller setup by measuring exact trailer brake gain needed



Scan to see it in action!

Download the app:
BetterWeigh Towing Scale



Pkg#	Description
51701	Mobile towing scale

What BetterWeigh™ measures



How BetterWeigh™ works | $\text{weight} = \text{force} \div \text{acceleration}$

Force is divided

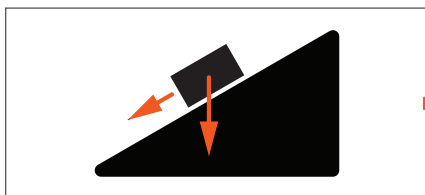

Force is determined by measuring slip across the torque converter as the vehicle accelerates through 15 mph

By acceleration

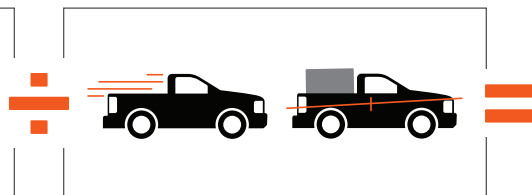

An integrated accelerometer detects how quickly the vehicle takes off and measures changes in the vehicle's pitch

To calculate the weight

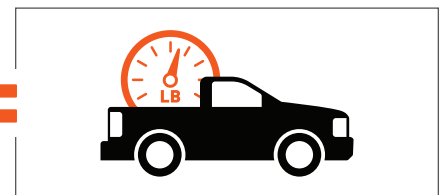

BetterWeigh™ calculates towing weights by gathering data from the OBD-II port and applying Newton's Second Law



SIMPLE, SECURE TRAILER HOOKUP

BALL MOUNTS

1 1/4
INCH

EURO MOUNT® BALL MOUNTS

- Fits any 1-1/4" receiver tube opening
- Installs easily with no tools or torque specifications required
- Permanently attached trailer ball cannot be loosened or stolen
- Highly durable carbide black powder coat finish
- Patents: #D610,051 S; #D610,492 S; #D610,493 S; #D610,494 S; #D610,954 S



Engineered with a sleek, modern look, similar to popular European designs



45551 (1-7/8" ball)
45552 (2" ball)



45571 (1-7/8" ball)
45572 (2" ball)



45561 (1-7/8" ball)
45562 (2" ball)



45591 (1-7/8" ball)
45592 (2" ball)



45581 (1-7/8" ball)
45582 (2" ball)

Part#	GTW / TW	Ball Diam.	Ball Height	Length
45551	3,500 / 350 lbs.	1-7/8"	2-3/4"	10"
45571	3,500 / 350 lbs.	1-7/8"	4-5/8"	7-1/4"
45561	3,500 / 350 lbs.	1-7/8"	5-1/8"	9-3/4"
45591	3,500 / 350 lbs.	1-7/8"	5-1/8"	11-1/4"
45581*	3,500 / 350 lbs.	1-7/8"	Negative 3/4"	8-3/4"
45552	3,500 / 350 lbs.	2"	2-3/4"	10"
45572	3,500 / 350 lbs.	2"	4-5/8"	7-1/4"
45562	3,500 / 350 lbs.	2"	5-1/8"	9-3/4"
45592	3,500 / 350 lbs.	2"	5-1/8"	11-1/4"
45582*	3,500 / 350 lbs.	2"	Negative 3/4"	8-3/4"

* Continued while supplies last

Required Ball Height = A - B

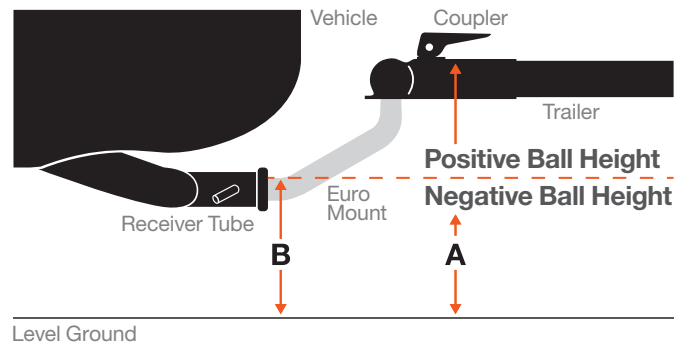

Level Ground

MEASURING A BALL MOUNT

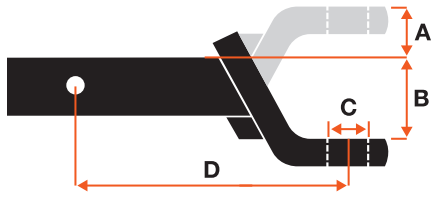

A: Rise

Distance the ball platform is set above the top of the shank.

B: Drop

Distance the ball platform is set below the top of the shank.

C: Hole Size

Size of trailer ball shank that is required to fit the ball mount.

D: Length

Distance from the pin hole center to the ball hole center.

1 1/4
INCH

CLASS 1 & 2 BALL MOUNTS

- Fits any 1-1/4" x 1-1/4" receiver tube opening
- Multiple drop and rise options to accommodate various vehicle-trailer combinations
- Compatible with anti-rattle to help stop vibration (see page 123)



Multiple drop and rise options accommodate various vehicle-trailer combinations



Part#	GTW / TW	Drop	Rise	Length	Tongue Hole Size	Shank Type	Finish
Class 1 Ball Mounts							
45018	2,000 / 200 lbs.	1-1/4"	5/8"	6-3/4"	3/4"	Hollow	Gloss black
45019	2,000 / 200 lbs.	1-1/4"	5/8"	9-3/4"	3/4"	Hollow	Gloss black
45027	2,000 / 200 lbs.	3-1/4"	2-5/8"	6-1/4"	3/4"	Hollow	Gloss black
45022	2,000 / 200 lbs.	3-1/4"	2-5/8"	7-1/4"	3/4"	Hollow	Gloss black
45026	2,000 / 200 lbs.	3-1/4"	2-5/8"	9-3/8"	3/4"	Hollow	Gloss black
45028	2,000 / 200 lbs.	6"	4-5/8"	5-9/16"	3/4"	Solid	Gloss black
45021	2,000 / 200 lbs.	--	3-3/4"	9-1/2"	3/4"	Solid	Gloss black
45023	2,000 / 200 lbs.	--	3-3/4"	11-1/2"	3/4"	Solid	Gloss black
45024	2,000 / 200 lbs.	--	5"	9-9/16"	3/4"	Solid	Gloss black
45025	2,000 / 200 lbs.	--	5"	11-9/16"	3/4"	Solid	Gloss black
Class 2 Ball Mounts							
45503	3,500 / 350 lbs.	1"	3/8"	7-13/16"	3/4"	Solid	Gloss black
45518	3,500 / 350 lbs.	1-1/4"	3/4"	6-3/4"	3/4"	Solid	Gloss black
45519	3,500 / 350 lbs.	1-1/4"	3/4"	9-3/4"	3/4"	Solid	Gloss black
45017	3,500 / 350 lbs.	3-1/4"	2-5/8"	6-1/4"	3/4"	Solid	Gloss black
45521	3,500 / 350 lbs.	3-1/4"	2-5/8"	7-1/4"	3/4"	Solid	Gloss black
45016	3,500 / 350 lbs.	3-1/4"	2-5/8"	9-3/8"	3/4"	Solid	Gloss black
45520	3,500 / 350 lbs.	--	3-1/8"	9-3/4"	3/4"	Solid	Gloss black
45510	3,500 / 350 lbs.	--	3-1/8"	10-5/16"	3/4"	Solid	Gloss black
45522	3,500 / 350 lbs.	--	3-1/8"	11-1/4"	3/4"	Solid	Gloss black
45000	3,500 / 350 lbs.	--	3-7/8"	13-1/2"	3/4"	Solid	Gloss black
45014	3,500 / 350 lbs.	--	5"	9-5/8"	3/4"	Solid	Gloss black
45015	3,500 / 350 lbs.	--	5"	11-5/8"	3/4"	Solid	Gloss black



2 CLASS 3 BALL MOUNTS

INCH

- Fits any 2" x 2" receiver tube opening
- Multiple drop and rise options to accommodate various vehicle-trailer combinations
- Increased drop on select models allows for level towing with lifted vehicles
- Compatible with anti-rattle to help stop vibration (see page 123)
- White box kits include a pin & clip



Black Bulk#	Chrome Bulk#	White Box Kit#	With Pin & Clip Poly Bag#	GTW / TW	Drop	Rise	Length	Tongue Hole Size	Shank Type
45030	45290	45032	45033	7,500 / 750 lbs.	2"	3/4"	7-1/2"	1"	Hollow
45010	--	45012	--	7,500 / 750 lbs.	2"	3/4"	8-1/4"	1"	Hollow
45040	--	--	--	7,500 / 750 lbs.	2"	3/4"	10-1/4"	1"	Hollow
45020	--	--	--	7,500 / 750 lbs.	2"	3/4"	10-1/4"	1"	Hollow
45260	--	--	--	7,500 / 750 lbs.	2"	3/4"	12-1/4"	1"	Hollow
45250	--	--	--	7,500 / 750 lbs.	2"	3/4"	12-1/4"	1"	Hollow
45050	45296	45052	--	7,500 / 750 lbs.	4"	2"	8-1/4"	1"	Hollow
45060	--	--	--	7,500 / 750 lbs.	4"	2"	10-1/4"	1"	Hollow
45270	--	--	--	7,500 / 750 lbs.	4"	2"	13"	1"	Hollow
45070	45297	--	--	7,500 / 750 lbs. drop 6,000 / 600 lbs. rise	6"	4"	9-1/4"	1"	Hollow
45080	--	--	--	7,500 / 750 lbs. drop 6,000 / 600 lbs. rise	6"	4"	12-1/4"	1"	Hollow
45280	--	--	--	7,500 / 750 lbs. drop 6,000 / 600 lbs. rise	6"	4"	14-1/4"	1"	Hollow
45090	--	--	--	5,000 / 500 lbs. drop 3,500 / 350 lbs. rise	8"	6"	11-1/2"	1"	Hollow
45100	--	--	--	5,000 / 500 lbs. drop 3,500 / 350 lbs. rise	8"	6"	13"	1"	Hollow
45110	--	--	--	5,000 / 500 lbs. drop 3,500 / 350 lbs. rise	10"	8"	13"	1"	Hollow
45112	--	--	--	5,000 / 500 lbs. drop 3,500 / 350 lbs. rise	10"	8"	14"	1"	Hollow

1 1/4
INCH

&

2
INCH

TOWING STARTER KITS

Scan to
learn more



RockerBall™ starter kits

- Dynamic trailer ball and ball mount kit featuring ShockDrop™ technology
- Dampens jerking and jarring from bumps and potholes for smoother towing
- Includes anti-rattle kit to help stop rattling and vibration
- [For more details on the advantages of RockerBall™, see page 92](#)



45144



45143



45534



45554



Standard starter kits

- Includes all the accessories needed to complement a trailer hitch in one kit
- Reusable case is able to be shelved or hung on pegs (#45534, #45554)
- Compatible with anti-rattle to help stop vibration (see page 123)

Part#	Shank Size	GTW / TW	Ball Diameter	Drop	Length	Included Parts
RockerBall™ Starter Kits						
45143	2"	7,500 / 750 lbs.	2"	3"	8-1/4"	45050 ball mount, 40047 RockerBall™, 22321 anti-rattle
45144	2"	7,500 / 750 lbs.	2"	5"	9-1/4"	45070 ball mount, 40047 RockerBall™, 22321 anti-rattle
Standard Starter Kits						
45534*	2"	7,500 / 750 lbs.	2"	2"	8-1/4"	45030 ball mount, 40037 trailer ball, 23515 hitch lock, 22272 hitch tube cover, 21500 pin & clip, case
45554*	2"	7,500 / 750 lbs.	2"	4"	8-1/4"	45050 ball mount, 40037 trailer ball, 23515 hitch lock, 22272 hitch tube cover, 21500 pin & clip, case

*Includes sturdy, reusable case

2

INCH

RV TOWING STARTER KIT

- Complete kit to maximize comfort and control when towing a small travel trailer
- Ideal for vehicles less than 5,000 lbs. GVW and trailers 3,500 to 5,000 lbs. GTW
- Pre-torqued RockerBall™ dampens jerking and jarring for smoother towing, [see page 92 for more information](#)
- Echo® brake controller uses Bluetooth and smartphone to control trailer brakes, [see page 139 for more information](#)
- Sway control unit helps limit lateral trailer movement to reduce sway



45190

Pkg#	Shank Size	GTW / TW	Ball Diameter	Drop	Length	Included Parts
45190 N	2"	7,500 / 750 lbs.	2-5/16"	1"	7-1/2"	40248 RockerBall™, 45820 sway tab mount, 51180 Echo® brake controller, 17200 sway control and 22323 anti-rattle

2 INCH LOADED BALL MOUNTS

- Fits any 2" x 2" receiver tube opening
- Includes a factory-torqued trailer ball and pin & clip
- Three-packs include an informative point-of-purchase tray
- Compatible with anti-rattle to help stop vibration (see page 123)



45148



45147



45037
multi-pack



45064 (2" ball)
45065 (2-5/16" ball)



45034 (1-7/8" ball)
45036 (2" ball)
45041 (2-5/16" ball)



45293 (1-7/8" ball)
45295 (2" ball)



45055 (1-7/8" ball)
45056 (2" ball)
45042 (2-5/16" ball)



45331



45332

Part#	White Box#	Three-Pack#	GTW / TW	Ball Diameter	Drop	Length	Shank Type	Finish
1-1/4" x 1-1/4" Loaded Ball Mounts								
45148	--	--	3,500 / 350 lbs.	2"	3-1/4"	7-1/4"	Solid	Gloss black
45147	--	--	3,500 / 350 lbs.	2"	1-1/4"	9-3/4"	Solid	Gloss black
2" x 2" Loaded Ball Mounts								
45034	--	--	3,500 / 350 lbs.	1-7/8" (40002)	2"	8-1/4"	Hollow	Gloss black
--	45293	--	3,500 / 350 lbs.	1-7/8" (40002)	2"	8-1/4"	Hollow	Chrome-plated
45036	--	45037	7,500 / 750 lbs.	2" (40037)	2"	8-1/4"	Hollow	Gloss black
--	45295	--	7,500 / 750 lbs.	2" (40037)	2"	8-1/4"	Hollow	Chrome-plated
45041	--	--	7,500 / 750 lbs.	2-5/16" (40005)	2"	8-1/4"	Hollow	Gloss black
45331	--	--	15,000 / 1,500 lbs.	2-5/16" (40030)	2"	8-1/2"	Solid	Carbide black
45055	--	--	3,500 / 350 lbs.	1-7/8" (40002)	4"	8-1/4"	Hollow	Gloss black
45056	--	45057	7,500 / 750 lbs.	2" (40037)	4"	8-1/4"	Hollow	Gloss black
45042	--	--	7,500 / 750 lbs.	2-5/16" (40005)	4"	8-1/4"	Hollow	Gloss black
45332	--	--	15,000 / 1,500 lbs.	2-5/16" (40030)	4"	8-1/2"	Solid	Carbide black
45064	--	--	7,500 / 750 lbs.	2" (40037)	6"	9-1/4"	Hollow	Gloss black
45065	--	--	7,500 / 750 lbs.	2-5/16" (40005)	6"	9-1/4"	Hollow	Gloss black

2

INCH

FUSION™ BALL MOUNTS

- Fits any 2" x 2" receiver tube opening
- Welded trailer ball cannot be loosened or stolen
- Compatible with anti-rattle to help stop vibration (see page 123)



45141 (2" ball) -
includes hitch lock



45131 (1-7/8" ball)
45134 (2" ball)



45142 (2" ball) -
includes hitch lock



45151 (1-7/8" ball)
45154 (2" ball)



45152 (1-7/8" ball)
45155 (2" ball)

Part#	GTW / TW	Ball Diameter	Drop	Rise	Length	Finish	Includes
45131	5,000 / 500 lbs.	1-7/8"	2"	--	7-1/2"	Gloss black	Pin & clip
45134	7,500 / 750 lbs.	2"	2"	--	7-1/2"	Gloss black	Pin & clip
45141	7,500 / 750 lbs.	2"	2"	--	7-1/2"	Gloss black	Hitch lock
45151	5,000 / 500 lbs.	1-7/8"	4"	--	8-1/8"	Gloss black	Pin & clip
45154	7,500 / 750 lbs.	2"	4"	--	8-1/8"	Gloss black	Pin & clip
45142	7,500 / 750 lbs.	2"	4"	--	8-1/8"	Gloss black	Hitch lock
45152	5,000 / 500 lbs.	1-7/8"	--	2"	8-1/8"	Gloss black	Pin & clip
45155	7,500 / 750 lbs.	2"	--	2"	8-1/8"	Gloss black	Pin & clip

2

INCH

CLASS 4 BALL MOUNTS

- Fits any 2" x 2" receiver tube opening
- Increased drop allows for level towing with lifted vehicles
- Compatible with anti-rattle to help stop vibration (see page 123)



45310



45312



45311



45313



45336



45446



45338



45448

Part#	GTW / TW	Drop	Rise	Length	Tongue Hole Size	Shank Type	Finish
45310	10,000 / 1,000 lbs.	2"	1"	9-3/8"	1-1/4"	Hollow	Gloss black
45311	10,000 / 1,000 lbs.	4"	2-3/4"	9-3/8"	1-1/4"	Hollow	Gloss black
45336	10,000 / 1,000 lbs.	6"	4-3/4"	9-3/8"	1-1/4"	Hollow	Gloss black
45338	10,000 / 1,000 lbs.	8"	6-3/4"	9-3/8"	1-1/4"	Hollow	Gloss black
45312	12,000 / 1,200 lbs.	2"	1"	9-3/8"	1-1/4"	Solid	Gloss black
45313	12,000 / 1,200 lbs.	4"	3"	9-3/8"	1-1/4"	Solid	Gloss black
45446	12,000 / 1,200 lbs.	6"	5"	9-3/8"	1-1/4"	Solid	Gloss black
45448	12,000 / 1,200 lbs.	8"	7"	9-3/8"	1-1/4"	Solid	Gloss black

2 INCH DUAL-LENGTH BALL MOUNTS

- Fits any 2" x 2" receiver tube opening
- Two hitch pin holes for varying length
- Compatible with anti-rattle to help stop vibration (see page 123)



45220



45230



45240

Part#	GTW / TW	Drop	Rise	Length	Hole Size	Finish
45220	7,500 / 750 lbs.	2"	3/4"	7-1/2" or 10-1/2"	1"	Gloss black
45230	7,500 / 750 lbs.	4"	2"	8-1/8" or 11-1/8"	1"	Gloss black
45240	7,500 / 750 lbs. drop 6,000 / 600 lbs. rise	6"	4"	9-1/4" or 12-1/4"	1"	Gloss black



Two pin holes for varying length

2 INCH & 2 1/2 INCH & 3 INCH FORGED BALL MOUNTS

- Fits 2", 2-1/2" or 3" receiver tube openings
- Solid, forged steel for superior strength
- Compatible with anti-rattle to help stop vibration (see page 123)



45340



45341



45342



45456



45458



45459



45460



45430



45431



45432

Part#	Shank Size	GTW / TW	Drop	Rise	Length	Tongue Hole Size	Finish
2" x 2" Xtra Duty Forged Ball Mounts							
45340	2" x 2"	17,000 / 2,550 lbs.	2"	1"	8-1/2"	1-1/4"	Carbide black
45341	2" x 2"	17,000 / 2,550 lbs.	4"	3"	8-1/2"	1-1/4"	Carbide black
45342	2" x 2"	17,000 / 2,550 lbs.	6"	5"	9-1/2"	1-1/4"	Carbide black
2-1/2" x 2-1/2" Commercial Duty Forged Ball Mounts							
45456	2-1/2" x 2-1/2"	20,000 / 2,700 lbs.	2"	1/2"	8-1/2"	1-1/4"	Carbide black
45458	2-1/2" x 2-1/2"	20,000 / 2,700 lbs.	4"	2-1/2"	8-1/2"	1-1/4"	Carbide black
45459	2-1/2" x 2-1/2"	20,000 / 2,700 lbs.	6"	4-1/2"	9"	1-1/4"	Carbide black
45460	2-1/2" x 2-1/2"	20,000 / 2,700 lbs. drop 16,000 / 2,160 lbs. rise	8"	6-1/2"	10"	1-1/4"	Carbide black
3" x 3" Industrial Duty Forged Ball Mounts							
45430	3" x 3"	21,000 / 2,800 lbs.	4"	2"	9"	1-1/4"	Carbide black
45431	3" x 3"	21,000 / 2,800 lbs.	6"	4"	10"	1-1/4"	Carbide black
45432	3" x 3"	21,000 / 2,800 lbs.	8"	6"	10-1/2"	1-1/4"	Carbide black

For RockerBall™ products
see page 92



Scan to
learn more

COMFORT. CONTROL. CONFIDENCE.



2
INCH

&

2½
INCH

REBELLION™ XD ADJUSTABLE CUSHION HITCH BALL MOUNTS

- Reduces shock loads to the vehicle during sudden braking or acceleration
- Minimizes stress on tow vehicle's brakes and suspension for extended longevity
- Lighter-weight design for less stress on the trailer hitch receiver
- Cast steel construction with textured, dark grey teridium finish for a premium look on your vehicle
- Tested for safety to meet SAE J684 specifications
- Informative, full-color retail box



NEW

45951



NEW

45955

Enhanced comfort.

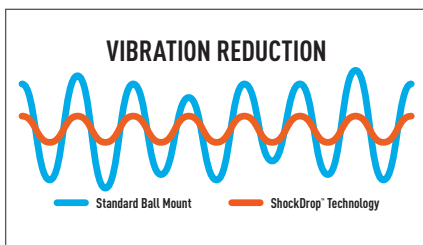

Unlike a traditional metal-on-metal towing connection, ShockDrop™ absorbs unevenness in the road to maximize comfort

Improved control.

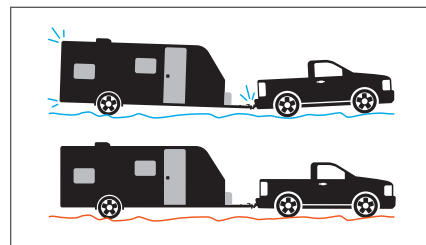

ShockDrop™ dynamically reacts to jarring, limiting its effects and giving the driver increased control on the road

Unmatched confidence.

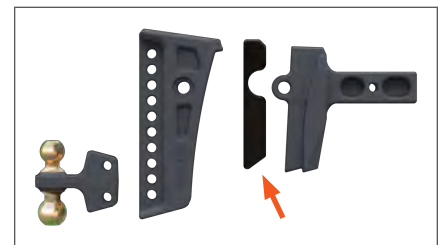

Unlike a cushion hitch with an airbag or bearings, ShockDrop™ is virtually maintenance-free and is tested for thousands of cycles

Pkg#	Shank Size	Includes	Ball Size	GTW / TW	Max Drop	Length	Tongue Hole Size
45949	2"	Shank and tongue (no ball)	--	15,000 / 1,500 lbs.	6"	12-1/4"	1-1/4"
45981 N	2"	Shank, tongue and trailer ball	2"	10,000 / 1,000 lbs. (limited by ball)	6"	12-1/4"	1-1/4"
45980 N	2"	Shank, tongue and trailer ball	2-5/16"	15,000 / 1,500 lbs.	6"	12-1/4"	1-1/4"
45951 N	2"	Shank and dual-ball	2"	10,000 / 1,000 lbs	6"	12-1/4"	1-1/4"
			2-5/16"	15,000 / 1,500 lbs.			
45955 N	2-1/2"	Shank and dual-ball	2"	10,000 / 1,000 lbs	8"	14-1/4"	--
			2-5/16"	20,000 / 2,000 lbs			

REBELLION™ XD ATTACHMENTS

- Cast steel build for optimum strength
- Includes four bolts to mount pintle hitch (#45950)
- Attachment pins not included



Pintle mount accepts any CURT mount-style pintle hook or ball & pintle hitch (45950)



Cast steel, dual-ball tongue allows you to flip the ball over for versatile towing options



Integrated rubber dampener for enhanced vibration resistance

Pkg#	Description	Dimensions	Capacity	Finish
45950	Pintle mount attachment	3-5/16" (W) x 1-3/4" (H) hole spacing	Limited to Rebellion™ XD ball mount	Dark grey teridium
45952	Dual-ball attachment	2" ball	10,000 lbs.	Dark grey teridium with chrome balls
		2-5/16" ball	15,000 lbs.	

REBELLION™ XD LOCKS

- Locks replace standard clips and hitch pin for increased security
- Unique, integrated design fits all CURT Rebellion™ XD accessories
- Easy-to-operate, 1/4-turn lock activation
- Locks keyed alike for convenient one-key operation (#45932 only)



Locks replace standard clips and hitch pin for increased security

Pkg#	Description	Fits	Finish
45932 N	Tongue & hitch lock set	Hitch lock fits 2" and 2-1/2" receiver tubes	Black powder-coated aluminum and stainless steel
45938 N	Tongue lock only	Fits Rebellion™ XD shank pins only	Black powder-coated aluminum

REBELLION™ XD REPLACEMENT PARTS

Part#	Description	Notes
45940	Tongue mount	Pins sold separately
45959	Accessory mount pins	Two pins (clip sold separately)
45960	Accessory mount clip	One clip (pins sold separately)



2

INCH

SLIM ADJUSTABLE CHANNEL MOUNT

- Shank can be flipped to maximize rise or drop
- Weighs only 15 lbs. for easy handling, compared to other adjustable hitches
- One-pin dual-ball attachment for quick, easy adjustment
- Patent #8,033,563



Weighs only 15 lbs. for easy handling

Pkg#	Shank Size	2" Ball GTW / TW	2-5/16" Ball GTW / TW	Max Drop	Max Rise	Length	Ball Finish
45903	2"	8,000 / 800 lbs.	10,000 / 1,000 lbs.	3-3/4"	3-1/2"	10" or 11"	Yellow zinc-plated

2

INCH

&

2 1/2

INCH

ADJUSTABLE CHANNEL MOUNTS & ACCESSORIES

For standard channel mounts see adjacent page

Standard Channel Mounts

- Adjustable channel allows for precise trailer leveling
- Shank can be flipped to maximize rise or drop
- Channels measure 3" wide (I.D.) with holes spaced 1" on center
- Pintle mounts include safety pin (#25012)
- Durable carbide black powder coat finish
- Includes pins & clips
- Patent #8,033,563 (excl #45901)



Integrated rubber dampener for enhanced vibration resistance (select models)



Built-in anti-rattle helps promote quiet towing (select models)

Hitch Step Accessory

- Provides a convenient 16" step on the front or rear of the vehicle
- Attaches to any CURT channel mount for versatile height adjustment (excl #45903)
- Cast steel construction with a highly durable black powder coat finish

Pkg#	Tongue Weight	Step Width	Includes
45909	500 lbs.	16"	Hitch step only (no pins)



45909



Folds up and out of the way when not in use

Accessory Lock Set

- Channel lock replaces one channel-mount pin
- 5/8" hitch lock fits 2" or 2-1/2" receiver tubes
- Locks keyed alike for convenient one-key operation

Pkg#	Includes
23556	One 5/8" hitch lock and one channel mount lock



23556

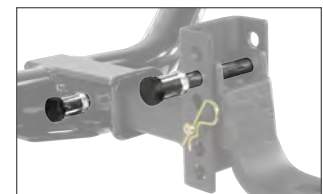

Secure the mount from theft

2 & **2½**
INCH INCH **ADJUSTABLE CHANNEL MOUNTS**



45901



45900



45902



45907



45908



45926



45927



45928

Pkg#	Shank Size	Ball Mount GTW / TW	2" Ball GTW / TW	2-5/16" Ball GTW / TW	Max Drop	Max Rise	Length	Hole Size	Ball Finish
45901	2"	6,000 / 600 lbs.	--	--	6-3/4"	5-1/4"	11" or 12"	1"	--
45900	2"	--	10,000 / 1,000 lbs.	14,000 / 1,400 lbs.	6"	5-1/4"	11" or 12"	--	Yellow zinc-plated
45902	2-1/2"	--	10,000 / 1,000 lbs.	20,000 / 2,000 lbs.	6"	5-1/4"	11" or 12"	--	Yellow zinc-plated
45907	2"	--	--	13,000 / 1,300 lbs.	6"	5-1/4"	11" or 12"	1-1/4"	Chrome-plated
45908	2-1/2"	--	--	20,000 / 2,000 lbs.	6"	5-1/4"	11" or 12"	1-1/4"	Chrome-plated
45926	2"	--	10,000 / 1,000 lbs.	14,000 / 1,400 lbs.	10-1/8"	9-1/8"	11" or 12"	--	Yellow zinc-plated
45927	2-1/2"	--	10,000 / 1,000 lbs.	20,000 / 2,000 lbs.	10-3/8"	8-7/8"	11" or 12"	--	Yellow zinc-plated
45928	3"	--	10,000 / 1,000 lbs.	21,000 / 2,100 lbs.	10-5/8"	8-5/8"	11" or 12"	--	Yellow zinc-plated

CHANNEL MOUNT REPLACEMENT PARTS



45921



45925



45916



45919
45920
45922



45912
45923

Part#	Description	Replacement For
45910	Replacement shank	45900 and 45907
45911	Replacement shank	45901
45917	Replacement shank	45902 and 45908
45912	Replacement dual-ball	45900 and 45926
45923	Replacement dual-ball	45902 and 45927
45925	Replacement pins, 5/8" diameter	All channel mounts
45916	Replacement anti-rattle set screw	45902 and 45908

Part#	Description	Replacement For
45921	Replacement anti-rattle rubber bumper	45900, 45901 and 45907
45919	Replacement ball and pintle combo, 2" ball with 10,000 lbs. GTW	All channel mounts
45920	Replacement ball and pintle combo, 2-5/16" ball with 13,000 lbs. GTW	45907
45922	Replacement ball and pintle combo, 2-5/16" ball with 20,000 lbs. GTW	45908

2

INCH

ADJUSTABLE TRI-BALL MOUNT

- Fits any 2" x 2" receiver tube opening
- Adjustable height allows for precise trailer leveling
- Includes three 5/8" diameter pins & clips
- Compatible with anti-rattle to help stop vibration (see page 123)



Bulk#	Pkg#	Description	GTW	Ball Diameter	Max Drop	Max Rise	Length
--	45799	Complete tri-ball assembly	6,000 / 7,500 / 10,000 lbs.	1-7/8", 2", 2-5/16"	5-3/4"	5-3/4"	16"
45800	--	Replacement tri-ball head for 45799	6,000 / 7,500 / 10,000 lbs.	1-7/8", 2", 2-5/16"	--	--	--
45059	--	Adjustable shank for 45799 or 45008	10,000 lbs.	--	5-3/4"	5-3/4"	8-3/4"
45802	--	Replacement tube mount for 45799	10,000 lbs.	--	--	--	--

2

INCH

ADJUSTABLE MULTI-PURPOSE BALL MOUNT

- Fits any 2" x 2" receiver tube opening
- Adjustable height allows for precise trailer leveling
- Includes three 5/8" diameter pins & clips (#45049)
- Compatible with anti-rattle to help stop vibration (see page 123)
- Patent #8,534,695



Welded trailer balls and removable clevis bar for lunette rings

Bulk#	Pkg#	Description	Ball Diameter and Maximum GTW / TW		Max Drop	Max Rise	Length
			2"	2-5/16"			
--	45049	Complete mount and shank assembly	7,500 / 750 lbs.	10,000 / 1,000 lbs.	4-1/2"	6-1/2"	14-3/16"
--	45008	Replacement head for 45049	7,500 / 750 lbs.	10,000 / 1,000 lbs.	--	--	--
45059	--	Adjustable shank for 45008 or 45799	10,000 / 1,000 lbs. - no ball included		--	--	--

2

INCH

ADJUSTABLE BALL MOUNT

- Fits any 2" x 2" receiver tube opening
- Adjusts in 1-1/2" increments for precise trailer leveling
- Compatible with anti-rattle to help stop vibration (see page 123)
- Includes pin & clip (#21500)

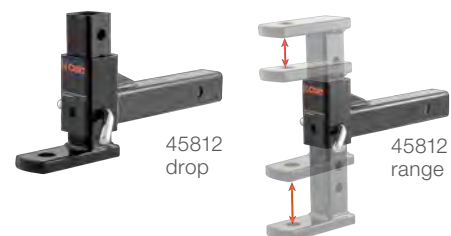

Part#	GTW / TW	Max Drop	Max Rise	Length	Tongue Hole Size	Finish
45812	5,000 / 500 lbs.	7-1/2"	6-1/4"	12-1/2"	1"	Gloss black

2 INCH & 2 1/2 INCH MULTI-BALL MOUNTS

- Fits 2" or 2-1/2" receiver tube openings
- Allows for quick switching between trailer ball sizes
- Permanently attached trailer balls cannot be loosened or stolen
- Compatible with anti-rattle to help stop vibration (see page 123)



Hollow Shank#	Solid Shank#	Trailer Balls	Ball Diameter and Maximum GTW / TW			Length	Ball Finish	Shank Finish
			1-7/8"	2"	2-5/16"			
For 2" x 2" Receiver Tube Openings								
--	45660	2	--	7,500 / 750 lbs.	10,000 / 1,000 lbs.	8-1/2"	Black	Gloss black
45002	45665	2	--	7,500 / 750 lbs.	10,000 / 1,000 lbs.	8-1/2"	Chrome	Gloss black
--	45675*	3	3,500 / 350 lbs.	5,000 / 500 lbs.	10,000 / 1,000 lbs.	7" and 8-1/2"	Chrome	Gloss black
45652	45650	3	5,000 / 500 lbs.	7,500 / 750 lbs.	10,000 / 1,000 lbs.	7" and 8-1/2"	Black	Gloss black
45001	45655	3	5,000 / 500 lbs.	7,500 / 750 lbs.	10,000 / 1,000 lbs.	7" and 8-1/2"	Chrome	Gloss black
For 2-1/2" x 2-1/2" Receiver Tube Openings								
45651	--	3	5,000 / 500 lbs.	10,000 / 1,000 lbs.	14,000 / 1,400 lbs.	7-1/4" and 8-1/4"	Black	Gloss black

*Tow hook limited to trailer hitch capacity

CLEVIS PINS

- Heavy-duty hitch pin for hitch accessories or towing with a UTV or lawn tractor
- Extra-wide, rubber-coated handle for better grip
- Welded steel construction for reliable strength
- Black powder-coated pin for enhanced protection
- Includes clevis pin and cotter pin



Part#	Pin Diameter	Pin Length	Pin Finish
45803	1"	5-1/2"	Black powder coat
45804	5/8"	4"	Black powder coat
45805	1/2"	3-5/8"	Black powder coat

2 INCH CLEVIS PIN BALL MOUNT

- Fits any 2" x 2" receiver tube opening
- Clevis pin accepts a tow hook or strap
- Can also be used as a standard ball mount
- Includes clevis pin (trailer ball sold separately)
- Solid steel shank for optimum strength



Part#	GTW / TW	Length	Tongue Hole Size	Finish
45821	6,000 / 600 lbs.	8-3/4"	1"	Gloss black

2 INCH & 2 1/2 INCH D-RING SHACKLE AND TOW HOOK MOUNTS

- Fits 2" or 2-1/2" receiver tube openings
- GTW and TW are limited to trailer hitch capacity



Can be used with CURT vehicle recovery strap 83066 or similar

Part#	Shank Size	Description	Length	Finish
45832	2"	Use with tow straps, complete with shackle and solid shank	7-1/2"	Carbide black
45831	2-1/2"	Use with tow straps, complete with shackle and solid shank	7-1/2"	Carbide black
45825	2"	Use with 83066 vehicle recovery strap or similar	7-1/2"	Gloss black
45500	2"	Use with 83066 vehicle recovery strap or similar	10"	Carbide black

TOW HOOKS & TOW STRAP

See page 256 for chain options

- Commonly used on 4WD pickups, SUVs and vans
- Constructed from forged, heat-treated steel
- Spring clip provides added security for rope or strap attachment



Bulk#	Pkg#	Description	Capacity	Break Strength	Finish
--	22401	Tow hook with hardware	10,000 lbs.	--	Chrome-plated
--	22411	Tow hook with hardware	10,000 lbs.	--	Black
22420	--	Tow hook	10,000 lbs.	--	Chrome-plated
22430	--	Tow hook	10,000 lbs.	--	Black
83066	--	Tow strap, 2" wide by 30' long	9,000 lbs. GVW	18,000 lbs.	Nylon

2 INCH SWAY TAB BALL MOUNT

- Fits any 2" x 2" receiver tube opening
- Provides a mounting tab for a sway control trailer ball (ball sold separately)
- Compatible with anti-rattle (see page 123)
- See page 181 for sway control units and balls



45820

45820 shown with 40093 ball (not included)



Coupled sway control (17200)

Part#	GTW / TW	Drop	Rise	Length	Tongue Hole Size
45820	7,500 / 750 lbs.	2"	3/4"	7-1/2"	1"

2 INCH SPECIALIZED ADAPTERS

- Fits any 2" x 2" receiver tube opening
- Top receiver increases ground clearance for a cargo carrier or other hitch-mounted accessories
- Top receiver not for towing use
- Provides two receiver tubes for multiple accessories, such as a cargo carrier and a ball mount (#45792)
- Ideal for carrying a bike rack while towing a trailer (#45810)



45794 provides added ground clearance



45792 provides two receiver tubes



45810 provides a ball mount and receiver tube to tow a trailer and an additional accessory



Part#	Description	GTW / TW	Drop	Rise	Length	Hole Size	Finish
45794	Raised receiver adapter (only for use in the rise position)	Not for towing use / 350 lbs.	--	4-1/4"	5-1/4"	--	Gloss black
45792	Dual receiver extender with pin & clip	3,500 / 350 lbs.	--	5-13/16"	8"	--	Gloss black
45810	Multi-use ball mount with pin & clip	7,500 / 750 lbs.	2"	5-13/16"	12-1/4"	1"	Gloss black

ATV

2 INCH ATV TOWING STARTER KITS

- Kit includes 3-in-1 ATV ball mount, bolt-on ATV adapter and pin & clip
- Never exceed the ATV's maximum tow rating
- Ball mount features a trailer ball, 5/8" hole and a clevis pin
- Adapter bolts onto ATV tongue to provide a 2" x 2" receiver tube
- Welded D-ring accepts tow straps or hooks
- Durable gloss black powder coat finish
- Patent #8,915,514 and #8,276,932



Installs on ATV and provides a variety of hook-up options



No-swivel design



45006



45005



45029

Kit#	Ball Mount#	Adapter#	Ball Diameter	Rise	Length	Hole Size
45029	45005	45006	1-7/8"	1/4"	6"	5/8"
45038	45009	45006	2"	1/4"	6"	5/8"

2 INCH & **2½** INCH & **3** INCH

TRAILER HITCH RECEIVER TUBE ADAPTERS & EXTENDERS

Adapters

- Adapts a receiver tube opening to a different size
- #45048 can be cut down from 34" to 24" and has integrated safety chain loops and electrical bracket
- Protected by a durable black powder coat finish

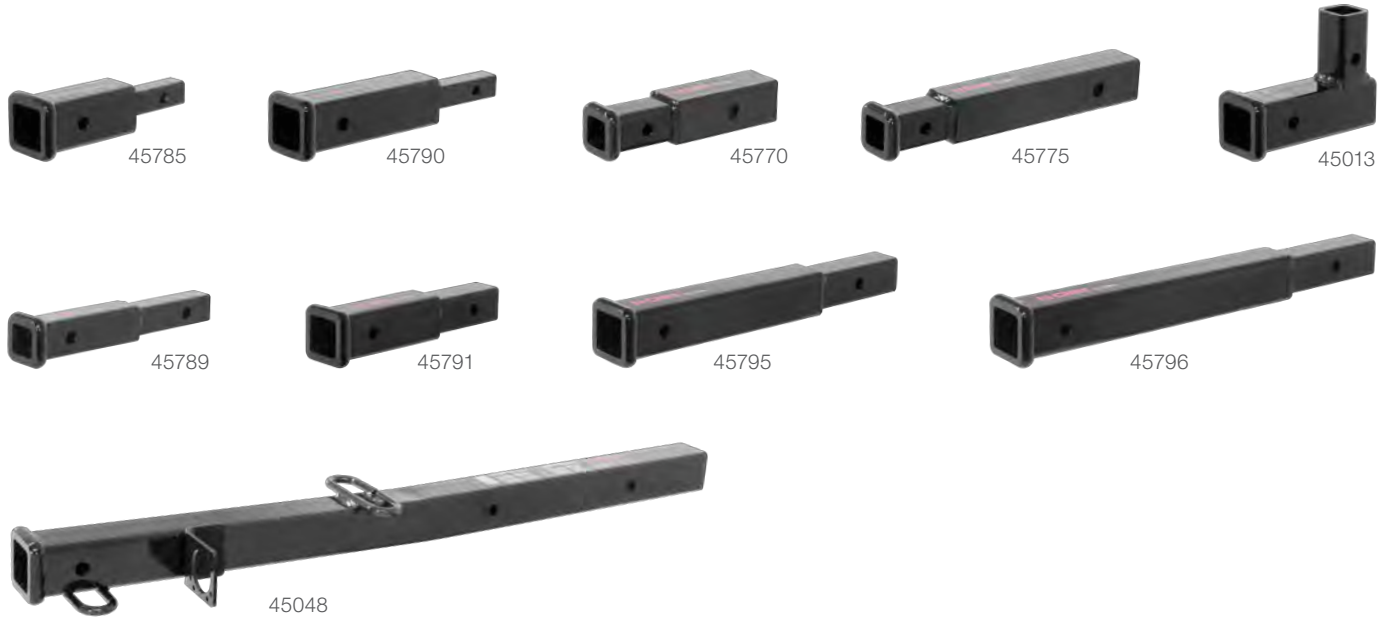

Extenders

- Solid steel shank for optimum strength
- Protected by a durable black powder coat finish



Adds clearance for a trailer or hitch-mounted accessory (45791)



Moves coupling point farther from the vehicle to avoid obstructions

Measuring adapters and extenders



Length is measured between pin-holes, from center to center

Part#	Adapts From	Adapts To	GTW / TW	Weight Dist. GTW / TW	Length	Finish
Adapters						
45785	1-1/4"	2"	Not for towing use / 350 lbs.	--	6-1/4"	Gloss black
45790	1-1/4"	2"	Not for towing use / 350 lbs.	--	10"	Gloss black
45770	2"	1-1/4"	3,500 / 350 lbs.	--	4"	Gloss black
45775	2"	1-1/4"	3,500 / 350 lbs.	--	9-1/2"	Gloss black
45013	Vertical 2"	Standard 2"	5,000 / 500 lbs.	--	4-1/4"	Gloss black
45048	2-1/2"	2"	4,500 / 450 lbs.	6,000 / 600 lbs.	34"	Gloss black
			6,000 / 600 lbs.	8,000 / 800 lbs.	24"	
Extenders						
45789	--	--	Not for towing use / 350 lbs.	--	7"	Gloss black
45791	--	--	3,500 / 350 lbs.	--	8"	Gloss black
45795	--	--	3,500 / 350 lbs.	--	14"	Gloss black
45796	--	--	3,500 / 350 lbs.	--	18"	Gloss black

3 INCH → **2½** INCH → **2** INCH **REDUCER SLEEVES**

- #45405 reduces a 2-1/2" x 2-1/2" receiver tube opening to fit a 2" x 2" shank
- #45408 two-piece set reduces a 3" receiver tube opening to fit a 2-1/2" shank or 2" shank
- Limited to trailer hitch capacity



45408 set includes two reducers to fit multiple accessories



Reduces the receiver tube opening to fit smaller shank sizes



45405 - single



45408 - nested set

Part#	Reduces From	Reduces To	Length	Finish
45405	2-1/2"	2"	5-1/2"	Carbide black
45408	3"	2-1/2"	6-1/4"	Carbide black
	2-1/2"	2"		

How to use a reducer sleeve



1¼ INCH & **2** INCH **VERTICAL RECEIVER TUBE BALL MOUNTS**

- Converts a vertical receiver tube into a ball mount tongue (#45507, #45003)
- Adapts a 2" vertical receiver into a 2" standard receiver (#45013)



45507



45003



45013

Part#	Shank Size	GTW / TW	Tongue Hole Size	Adapts From	Adapts To	Length	Finish
45507	1-1/4"	3,500 / 300 lbs.	3/4"	Vertical 1-1/4"	Ball mount tongue	9-3/4"	Gloss black
45003	2"	4,000 / 400 lbs.	1"	Vertical 2"	Ball mount tongue	9"	Gloss black
45013	2"	5,000 / 500 lbs.	--	Vertical 2"	Standard 2"	4-1/4"	Gloss black

TOWING SECURITY

HITCH PINS & CLIPS

- Secures ball mounts and other receiver tube inserts
- Bent handle for an easier grip

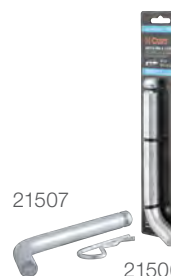
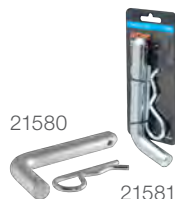
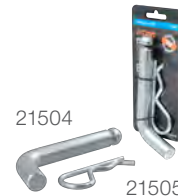
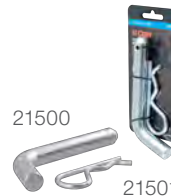

Bent handle for an easier grip during insertion and removal



Vinyl-coated pin & clip for a more solid, easy grip (select models)



Grooved pin allows clip insertion at any angle (select models)



High-strength steel construction with a durable zinc-plated finish

Bulk#	Pkg#	Three-Pack#	Fits Receiver Tube Opening	Pin Diameter	Finish	Clip Attachment
21400	21401	--	1-1/4" x 1-1/4"	1/2"	Zinc-plated	Hole
21403	21404	--	1-1/4" x 1-1/4"	1/2"	Zinc-plated	Groove
21410	21411	--	1-1/4" x 1-1/4"	1/2"	Zinc-plated, coated grip	Hole
--	21502	--	1-1/4" x 1-1/4"	1/2"	Zinc-plated	Hole
			2" x 2"	5/8" adapter		
21500	21501	--	2" x 2"	5/8"	Zinc-plated	Hole
21504	21505	--	2" x 2"	5/8"	Zinc-plated	Groove
21510	21511	--	2" x 2"	5/8"	Zinc-plated, coated grip	Hole
21578	21579	--	2" x 2"	5/8"	Black zinc-plated	Hole
21580	21581	--	2" x 2"	5/8"	Zinc-plated	Hole
			2-1/2" x 2-1/2"			
21582	21583	--	2" x 2"	5/8"	Zinc-plated	Groove
			2-1/2" x 2-1/2"			
21507	21506	--	2-1/2" x 2-1/2"	5/8"	Zinc-plated	Groove
			3" x 3"			
21600	21601	21602	--	Fits 1/2" or 5/8"	Zinc-plated	--

SWIVEL HITCH PINS

- Quickly secures ball mounts and other receiver tube inserts with no clip needed
- Permanently attached swivel clip cannot be lost
- Bent handle for an easier grip



Pkg#	Fits Receiver Tube Opening	Pin Diameter	Finish	Description
21541	1-1/4" x 1-1/4"	1/2"	Chrome-plated	Swivel pin
23581	1-1/4" x 1-1/4"	1/2"	Stainless steel	Swivel pin
21551	2" x 2"	5/8"	Chrome-plated	Swivel pin
23582	2" x 2"	5/8"	Stainless steel	Swivel pin
21561	1-1/4" x 1-1/4"	1/2"	Zinc-plated	Swivel pin with adapter sleeve
	2" x 2"	5/8"		



Quickly secures shank with no additional clip needed

SAFETY PINS

- Quickly secures coupler latches, pintle hooks, jack legs or caster wheels
- Square retainer wire clip provides added clearance
- Protected by a durable zinc-plated finish



Bulk#	Pkg#	Pin Diameter	Pin Length	Chain Length
25080	25081	1/4"	2-3/4"	--
25012	25013	1/4"	2-3/4"	12"
25010	25011	5/16"	3"	--
25034	25035	5/16"	3"	12"
28278	28279	3/8"	2-3/4"	--
28000	28001	3/8"	3"	12"



Quickly secures coupler latches, pintle hooks, jack legs or wheels



Square retainer wire clip provides added clearance (28278)

HITCH LOCKS

- Easy-to-operate, 1/4-turn lock activation
- Watertight dust cap prevents internal corrosion
- Two keys included for added convenience
- Space-saving, full-color retail packaging



Pkg#	Fits Tube Size	Pin Diameter	Finish	Lock Style
23020	1-1/4" x 1-1/4"	1/2"	Chrome-plated	Dead bolt
23501	1-1/4" x 1-1/4"	1/2"	Chrome-plated	Barbell
23024	1-1/4" x 1-1/4"	1/2"	Chrome-plated	Dead bolt with adapter sleeve
	2" x 2"	5/8"		
23517	1-1/4" x 1-1/4"	1/2"	Stainless steel	Barbell with adapter sleeve
	2" x 2"	5/8"		
23506	1-1/4" x 1-1/4"	1/2"	Chrome-plated with blue anodized aluminum	Barbell, right angle with adapter sleeve
	2" x 2"	5/8"		
23515	2" x 2"	5/8"	Chrome-plated	Barbell
23530*	2" x 2"	5/8"	Chrome-plated	Barbell with anti-rattle
23516	2" x 2"	5/8"	Stainless steel	Barbell
23518	2" x 2"	5/8"	Black	Barbell
23502	2" x 2"	5/8"	Stainless steel with blue anodized aluminum	Barbell, right angle
23510	2" x 2"	5/8"	Chrome-plated	Barbell, right angle
23528	Up to 2-1/2"	5/8"	Chrome-plated	Barbell
23519	Up to 2-1/2"	5/8"	Stainless steel	Barbell
23504	Up to 2-1/2"	5/8"	Chrome-plated with blue anodized aluminum	Barbell, right angle
23021	Up to 3"	5/8"	Chrome-plated	Dead bolt
23025	Up to 3"	5/8"	Chrome-plated	Barbell

* Continued while supplies last



HITCH & COUPLER LOCK SETS

- Locks keyed alike for convenient one-key operation
- Easy-to-operate, 1/4-turn lock activation
- Watertight dust caps prevent internal corrosion
- Four keys included for added convenience
- Space-saving, retail packaging



23526



23527



23505



23086



23088



Locks keyed alike for convenient one-key operation



Watertight dust caps prevent internal corrosion



Trailer coupler locks fit flat lip couplers (size varies by model)



Easy-to-operate, 1/4-turn lock activation

Pkg#	Fits Receiver Tube Opening	Fits Latch Span	Fits Coupler	Lock Pin Diameter	Coupler Pin Diameter	Finish	Description
23526	2" x 2"	7/8"	--	5/8"	1/4"	Chrome-plated	Hitch lock (23515) & coupler lock (23520)
23527	2" x 2"	2-1/2"	--	5/8"	1/4"	Chrome-plated	Hitch lock (23515) & coupler lock (23522)
23505	2" x 2"	Adjustable from 1" to 3"	--	5/8"	1/4"	Chrome-plated	Hitch lock & coupler lock (23503)
23086	2" x 2"	Adjustable from 1/2" to 2-1/2"	1-7/8" and 2" flat lip couplers	5/8"	1/4"	Chrome-plated (hitch & coupler lock) Grey powder coat (trailer coupler lock)	Hitch lock, coupler lock & trailer coupler lock (23079)
23088	2" x 2"	Adjustable from 1/2" to 2-1/2"	2-5/16" flat lip couplers	5/8"	1/4"	Chrome-plated (hitch & coupler lock) Grey powder coat (trailer coupler lock)	Hitch lock, coupler lock & trailer coupler lock (23081)

UNIVERSAL TRI-BALL COUPLER LOCK

- Highly theft and tamper-resistant design with built-in safety measures
- Simple lasso design keeps all parts together, avoiding lost pieces
- Glass-filled orange polymer for high strength and increased visibility
- Easy-to-operate, 1/4-turn lock activation
- Includes two keys for added convenience

Scan to learn more



Unique tri-ball inserts into coupler and secures latch with lasso lock



Coupler lock can also be used while towing to secure the trailer

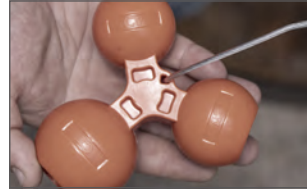

Built-in safety points allow the ball to break off when forcefully tampered with, leaving the ball in the coupler and blocking hookup



Pkg#	Fits Coupler Size	Fits Latch Span	Coupler Pin Diameter	Finish
23082 N	1-7/8", 2" and 2-5/16"	Adjustable from 1" to 3"	1/4"	Orange polymer

COUPLER LATCH LOCKS

- Easy-to-operate, 1/4-turn lock activation
- Watertight dust cap prevents internal corrosion
- Two keys included for added convenience
- Space-saving, full-color retail packaging

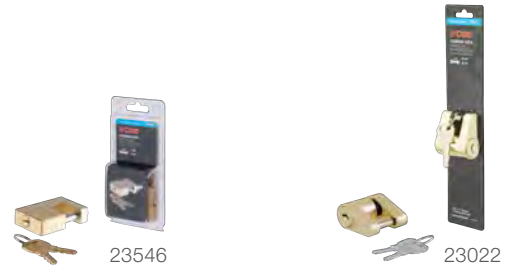

Pkg#	Fits Latch Span	Pin Diameter	Finish	Lock Style
23546	3/4"	1/4"	Solid brass	Padlock
23022	3/4"	1/4"	Brass-plated	Padlock
23521	3/4"	1/4"	Black	Padlock
23520	7/8"	1/4"	Chrome-plated	Barbell
23522	2-1/2"	1/4"	Chrome-plated	Barbell
23523	3-3/8"	1/4"	Chrome-plated	Barbell
23503	Adjustable from 1" to 3"	1/4"	Chrome with blue anodized aluminum	Barbell, right angle



Secure your trailer from theft (23503 shown)

TRAILER COUPLER LOCKS

- Designed to deter trailer theft by preventing a trailer ball from being inserted into the coupler
- Two keys included for added convenience



Secure your unattended trailer and deter theft (23081 shown)



Universal design fits all coupler types and styles (23659 shown)



23079



23081



23659



23179

Pkg#	Fits	Finish	Description
23079	1-7/8" and 2" couplers	Grey powder coat	Aluminum lock for flat lip couplers
23081	2-5/16" couplers	Grey powder coat	Aluminum lock for flat lip couplers
23659	Universal	Hammer-tone epoxy	Die-cast trailer lock with dual-ratchet locking system
23179	Universal	Ballistic grade nylon	Solid, hardened steel trailer lock with dual-ratchet locking system

5TH WHEEL HITCH LOCK

- Locks a 5th wheel hitch into the rails, taking the place of a pin & clip
- Extra-long 1/2" diameter pin fits all industry-standard base rails
- Weather-resistant dust cap helps prevent internal corrosion
- Easy-to-access, 1/8-turn lock activation
- Includes two keys for added convenience

Pkg#	Pin Diameter	Finish
23256	1/2"	Black powder-coated aluminum



Key slot angled upward for easier ergonomic access



23256



Flush-mount on the base rail for enhanced security

KINGPIN LOCK

- Locks on to 5th wheel kingpin to deter theft
- Built with an aluminum body for corrosion resistance
- Two keys included for added convenience
- Space-saving, full-color retail packaging

Pkg#	Description	Finish
23255	5th wheel trailer kingpin lock	Chrome-plated



23255



Universal design fits most 5th wheel trailer kingpins

SPARE TIRE LOCK

- Secures spare tires to prevent theft
- Two keys included for added convenience

Pkg#	Fits	Finish
23562	Side-mount spare tires	Chrome-plated



23562



Secure spare tires to prevent theft

MULTI-USE CABLE LOCK

- Features versatile locking and cinching capabilities
- 3/8" high-strength braided steel cable
- Protected by a vinyl coating for rust resistance
- Two keys included for added convenience

Pkg#	Length	Steel Cable	Finish
23666	6'	3/8" diameter	Vinyl-coated, braided steel



23666



Secures bike racks and other cargo to deter theft

WHEEL CHOCK LOCK

- Chocks and locks the wheel to prevent roll-away
- Expandable width fits most tire sizes
- Red rubber-coated arms protect the wheel's finish
- Three keys included for added convenience

Pkg#	Fits Tire Sizes		Finish
23175	4.8" - R12	215 / 70R15	Yellow powder coat with red rubber-coated arms
	7.5" - R16	225 / 75R15	
	195 / 75R14	235 / 75R15	
	205 / 60R16	235 / 80R16	
	205 / 70R15	33" x 12.5" - R15	



23175



Secures unattended trailers by clamping onto the wheel

WHEEL CHOCK SET

- Raised tread offers a better grip on the wheel
- Saw-tooth edges on the base provide solid traction on the ground
- Always to be used with vehicle brake
- Not for commercial use

Part#	Description	Includes
22800	For use with wheels up to 17" wide	Two chocks



22800



Adds safety during vehicle maintenance or to parked trailers

TRAILER SAFETY CHAIN HOLDER BRACKET

- Requires 1-1/8" clearance on the shank between receiver collar and accessory
- Hooks maintain proper safety chain function for trailer disconnect

Pkg#	Clamps Onto	Includes	Finish
45806 N	2" shanks	Hardware	Zinc-plated



Provides intermediate hangers to keep safety chains off the ground

ANTI-RATTLE HITCH CLAMPS & PINS

Clamp-style

- Stops rattling and prevents shank movement
- Compatible with hollow and solid shank accessories
- No-tool installation and easy-to-adjust clamp lever
- Lightweight aluminum and high-strength steel
- Durable, clear finish for corrosion resistance

Pin-style

- Stops rattling and prevents shank movement
- Compatible with hollow shank accessories only
- Protected by a durable yellow zinc-plated finish



22325



22320



22315



22321



22323



Stops rattling and prevents shank movement for hollow and solid shanks (clamp-style)



No-tool installation and easy-to-adjust clamp lever (clamp-style)

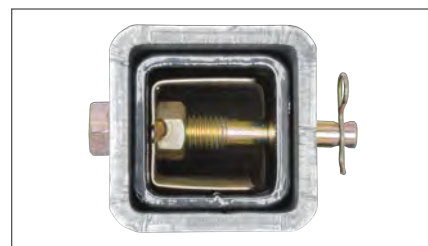

Insert into hollow shanks to prevent sway and stop rattling (pin-style)

Pkg#	Fits Shank Type	Fits Tube Size	Pin Diameter	Clip Attachment	Finish
Clamps					
22325 N	Hollow or solid	2" x 2"	--	--	Clear
22320 N	Hollow or solid	2-1/2" x 2-1/2"	--	--	Clear
Pins					
22315	Hollow only	1-1/4" x 1-1/4"	1/2"	Hole	Yellow zinc-plated
22321	Hollow only	2" x 2"	1/2"	Hole	Yellow zinc-plated
22323 N	Hollow only	2" x 2"	5/8"	Groove	Yellow zinc-plated

SL™ SECURELATCH™ SERIES AUTO-LOCKING TECHNOLOGY

SecureLatch™ streamlines the trailer hookup process with a revolutionary auto-locking design. Unlike any other coupling device, the primary latching mechanism automatically locks into place as you back up to the coupler. No manual coupling required! Simply insert the secondary safety pin, and you're ready to tow.

Scan to
learn more



How Auto-Locking Technology Works

Strike the plate.



As you back up the vehicle, a built-in back plate helps position the coupler or lunette ring for easier hookup

Drop the coupler.



As the coupler is lowered onto the pintle hitch, SecureLatch™ automatically locks without any manual coupling required

Tow with confidence.



Finally, insert the secondary safety pin, connect the safety chains and you're ready to tow with confidence and without chucking

What makes SecureLatch™ different?

Auto-locking system,
no manual coupling

Available in various
configurations

Austempered, cast iron
for superior strength
and wear resistance

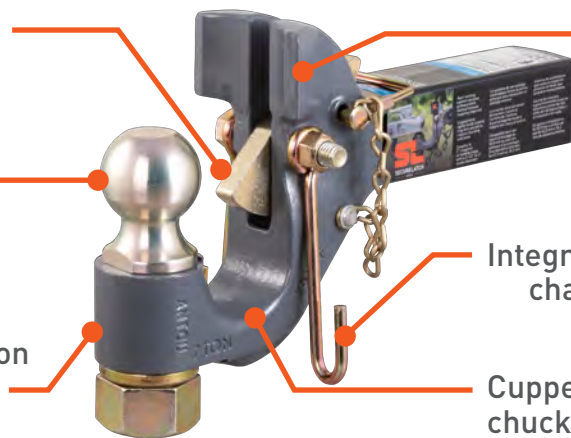

Built-in back plate
for easier hookup

Integrated safety
chain hangers

Cupped hook reduces
chucking and noises

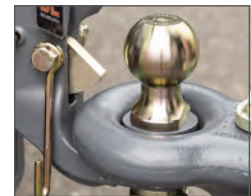

Check out the full series of hooks, mounts, channels and lunette rings!



PINTLES & MOUNTS



SECURELATCH™ PINTLE HOOKS & HITCHES

For lunette rings see pages 127 & 250

- Non-shank models fit slotted SecureLatch™ or standard pintle mounts (holes spaced 1-3/4" high x 3-5/16" wide)
- Battleship grey finish for excellent exterior durability
- Bright gold zinc-plated hardware for long-lasting corrosion resistance (bolt kit sold separately)
- Informative, full-color retail box or shank label
- For SecureLatch™ pintle mounts see page 126



48407



48406



48405



48420



48430



48440



48411



48410



48505

Bulk#	Pkg#	GTW*	Ball Capacity	Fits Tube Size	Ball Diameter	Overall Length	Ball Length	Hook Length	Fits Lunette Ring
Receiver-Mount Ball & Pintle Hitches									
48407	--	14,000 lbs.	10,000 lbs.	2"	2"	12-1/2"	9"	7"	2-1/2" or 3" I.D.
48406	--	14,000 lbs.	14,000 lbs.	2"	2-5/16"	12-1/2"	9"	7"	2-1/2" or 3" I.D.
Receiver-Mount Pintle Hooks									
48405	--	14,000 lbs.	--	2"	--	13-1/2"	--	9"	2-1/2" or 3" I.D.
Ball & Pintle Hitches									
--	48411	20,000 lbs.	10,000 lbs.	--	2"	--	--	--	2-1/2" or 3" I.D.
--	48410	20,000 lbs.	14,000 lbs.	--	2-5/16"	--	--	--	2-1/2" or 3" I.D.
Pintle Hooks									
--	48505	30,000 lbs.	--	--	--	--	--	--	2-1/2" or 3" I.D.
Replacement Parts									
48551	--	Safety chain hangers (set of two)							
48420	--	2" ball diameter with 10,000 lbs. GTW							
48430	--	2-5/16" ball diameter with 14,000 lbs. GTW							

*Vertical load not to exceed 15% GTW or tow vehicle vertical weight limit



SLOTTED BOLT PLATE FOR MAX ADJUSTABILITY



SECURELATCH™ ADJUSTABLE PINTLE MOUNTS

Scan to
learn more



- Slotted bolt plate provides max adjustability, instead of fixed height positions (for use in drop position only)
- Quick, easy, one-tool height adjustments – no disassembly required
- Torqued bolt plates provide 48,000 lbs. total clamp load for secure connection
- Accepts SecureLatch™ pintle hooks and ball hitches (sold separately)
- Cast iron construction is austempered for superior strength and wear resistance (#48543)
- High-strength fabricated steel construction (#48548)
- Battleship grey finish for excellent exterior durability
- Bright gold zinc-plated hardware for long-lasting corrosion resistance
- [See page 125 for pintles](#)

Measuring a pintle mount

See table for corresponding measurements

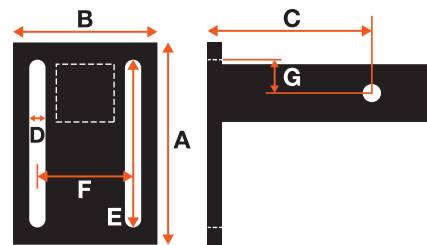

48543



48548

Bulk#	GTW	Plate Height (A)	Plate Width (B)	Shank Length (C)	Slot Width (D)	Slot Height (E)	Slot Space Width (F)	Top Slot Height (G)
For 2" x 2" Receiver Tube Openings								
48543	24,000 lbs.	9-1/2"	5-1/8"	6-3/4"	17/32"	7-3/4"	3-3/8"	5/8"
For 2-1/2" x 2-1/2" Receiver Tube Openings								
48548	30,000 lbs.	10-5/8"	5-1/8"	7-3/8"	17/32"	9"	3-3/8"	3/4"
Replacement Bolt Kit								
48549	Four 1/2" x 2" carriage bolts / Four top lock nuts / Two bolt plates							



SECURELATCH™ FLUSH-MOUNT LUNETTE RING

For pintles and mounts
go to page 125 & 126

- Vertically offset base allows ring to be flipped for maximum height adjustment
- Drop-in pin accepts lock to deter theft (turns 90 degrees while coupled)
- Cast iron construction is austempered for superior strength and wear resistance
- Battleship grey finish for excellent exterior durability
- Bright gold zinc-plated pin for long-lasting corrosion resistance



Drop-in pin accepts lock to deter theft (turns 90° while coupled)

Bulk#	Pkg#	Description	GTW	Rings Hole Size	Ring Thickness	Bolt Hole Spacing	Base Size	
--	48661	Lunette ring	60,000 lbs.	2-1/2" I.D.	1-1/2"	4-1/2" center to center	6-1/4" square	
48553	--	Replacement bolt kit - Includes four 3/4" hex head bolts / four nylock nuts / four flat washers						



SECURELATCH™ CHANNELS & LUNETTE RINGS

Scan to
learn more



- Vertically offset base allows ring to be flipped for maximum height adjustment
- Drop-in pin accepts lock to deter theft (turns 90 degrees while coupled)
- Strong 2-hole bolt pattern fits 3" channel only (#48625)
- Heavy-duty 3-hole bolt pattern fits 2-3/4" channel only (#48626)
- Cast iron construction is austempered for superior strength and wear resistance
- Hardware included with #48641 kit only
- Battleship grey finish for excellent exterior durability (lunette rings only)
- Raw finish for immediate welding (channels only)
- Bright gold zinc-plated pin for long-lasting corrosion resistance



Bulk#	Pkg#	GTW	Number of Positions	Ring Hole Size	Ring Thickness	Vertical Hole Spacing	Channel Width	Channel Height	Description
--	48625	25,000 lbs.	--	3" I.D.	1-1/2"	2" on center	3" I.D.	--	Lunette ring only
--	48626	40,000 lbs.	--	3" I.D.	1-1/2"	2" on center	2-3/4" I.D.	--	Lunette ring only
--	48641	40,000 lbs.	4-position	3" I.D.	1-1/2"	2" on center	2-3/4" I.D.	11-3/4"	Lunette ring and channel
48651	--	--	4-position	--	--	2" on center	2-3/4" I.D.	11-3/4"	Channel fits 48626 only
48610	--	--	3-position	--	--	2" on center	3" I.D.	7-1/2"	Channel only
48650	--	--	5-position	--	--	2" on center	3" I.D.	11-3/4"	Channel only
48552	--	Replacement bolt kit - Includes three 5/8" hex head bolts / three 5/8" nylock nuts / six 5/8" washers							

FORGED PINTLE HOOKS & HITCHES

- Receiver style available to fit 2" or 2-1/2" receiver tube openings
- Flush-mount style fits any CURT pintle mount (excl. SecureLatch™)
- Spring-loaded locking arm for secure coupling
- Constructed from solid, forged steel for superior strength
- Changeable trailer ball features a hard chrome finish (select models)
- Includes safety pin and bolt kit where applicable

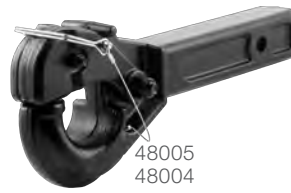

48205
48210
48215
48231



Bulk#	Pkg#	GTW*	Ball Capacity	Fits Tube Size	Ball Diameter	Overall Length	Ball Length	Hook Length	Fits Lunette Ring
Receiver-Mount Ball & Pintle Hitches									
48006	--	16,000 lbs.	12,000 lbs.	2"	2-5/16"	15-1/4"	11-1/4"	9-1/2"	2-1/2" or 3" I.D.
48007	--	16,000 lbs.	10,000 lbs.	2"	2"	15-1/4"	11-1/4"	9-1/2"	2-1/2" or 3" I.D.
48012	--	20,000 lbs.	20,000 lbs.	2-1/2"	2-5/16"	15"	11"	9-1/2"	2-1/2" or 3" I.D.
Receiver-Mount Pintle Hooks									
48005	--	10,000 lbs.	--	2"	--	14-1/2"	--	9-1/2"	2-1/2" I.D.
48004	--	20,000 lbs.	--	2"	--	14-1/2"	--	9-1/2"	2-1/2" I.D.
48010	--	20,000 lbs.	--	2-1/2"	--	14-3/4"	--	9-1/2"	2-1/2" I.D.
Ball & Pintle Hitches									
--	48180	16,000 lbs.	6,000 lbs.	--	1-7/8"	--	--	--	2-1/2" or 3" I.D.
--	48190	16,000 lbs.	10,000 lbs.	--	2"	--	--	--	2-1/2" or 3" I.D.
--	48200	16,000 lbs.	16,000 lbs.	--	2-5/16"	--	--	--	2-1/2" or 3" I.D.
Pintle Hooks									
--	48205	10,000 lbs.	--	--	--	--	--	--	2-1/2" or 3" I.D.
--	48210	20,000 lbs.	--	--	--	--	--	--	2-1/2" or 3" I.D.
--	48215	30,000 lbs.	--	--	--	--	--	--	2-1/2" or 3" I.D.
--	48231	60,000 lbs.	--	--	--	--	--	--	2-1/2" or 3" I.D.
Replacement Bolt Kits and Pintle Balls									
48330	--	Replacement hardware for all pintles (excl 48321) Four 12mm x 50mm hex bolts (class 10.9), four 12mm hex nuts (class 8) and four 12mm lock washers							
48332	--	Replacement hardware for 48231 only Four 5/8" x 3" socket head cap screw (grade 8), four 5/8" hex nuts (grade 8) and four 5/8" lock washers							
48810	--	1-7/8" ball diameter with 6,000 lbs. GTW							
48820	--	2" ball diameter with 10,000 lbs. GTW							
48830	--	2-5/16" ball diameter with 16,000 lbs. GTW							

*Vertical load not to exceed 15% GTW or tow vehicle vertical weight limit

2 INCH & 2½ INCH PINTLE MOUNTS

- Mounts any CURT flush-mount style pintle hook or ball & pintle hitches
- Height adjustment allows for precise trailer leveling (for use in drop position only)
- Bent face plate and solid shank provides superior strength (#48343)
- 2-1/2" shank is ideal for class 5 Commercial Duty hitches (page 13)
- Protected by a highly durable carbide black powder coat finish
- Informative, full-color retail labels

Measuring a pintle mount

See table for corresponding measurements

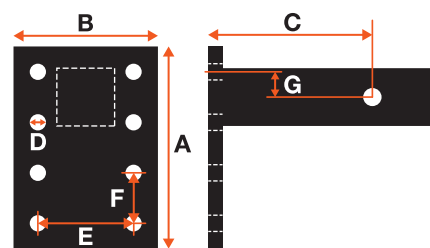

Bulk#	Pkg#	GTW	Pintle Positions	Plate Height (A)	Plate Width (B)	Shank Length (C)	Hole Size (D)	Hole Space Width (E)	Hole Space Height (F)	Top Hole Height (G)
For 2" x 2" Receiver Tube Openings										
48326	--	20,000 lbs.	1-position	3-1/2"	5"	6"	9/16"	3-5/16"	1-3/4"	7/8"
48327	--	20,000 lbs.	1-position	3-1/2"	5"	8"	9/16"	3-5/16"	1-3/4"	7/8"
48323	--	10,000 lbs.	3-position	7"	5"	6"	9/16"	3-5/16"	1-3/4"	7/8"
48324	--	10,000 lbs.	3-position	7"	5"	8"	9/16"	3-5/16"	1-3/4"	7/8"
48328	--	15,000 lbs.	3-position	7"	5"	6"	9/16"	3-5/16"	1-3/4"	7/8"
48325	--	15,000 lbs.	3-position	7"	5"	8"	9/16"	3-5/16"	1-3/4"	7/8"
48343	--	17,000 lbs.	3-position	7-1/4"	6-1/2"	6"	9/16"	3-5/16"	1-3/4"	7/8"
48341	--	10,000 lbs.	6-position	13"	5"	10"	9/16"	3-5/16"	1-3/4"	7/8"
48342	--	10,000 lbs.	6-position	13"	5"	12"	9/16"	3-5/16"	1-3/4"	7/8"
For 2-1/2" x 2-1/2" Receiver Tube Openings										
48340	--	20,000 lbs.	1-position	3-1/2"	5"	8"	9/16"	3-5/16"	1-3/4"	7/8"
48329	--	18,000 lbs.	3-position	7"	5"	8"	9/16"	3-5/16"	1-3/4"	7/8"
48348	--	20,000 lbs.	3-position	7-1/4"	5"	7-1/8"	9/16"	3-5/16"	1-3/4"	7/8"
48349	--	20,000 lbs.	6-position	12-1/2"	5"	7-1/8"	9/16"	3-5/16"	1-3/4"	7/8"
Replacement Bolt Kit										
48330	48333	Four 1/2"-13 x 2-1/4" hex bolts (grade 8) / Four 1/2"-13 hex nuts (grade 8) / Four 1/2" lock washers								

HITCH ACCESSORIES

1/4" & 2" & 2 1/2" RUBBER HITCH TUBE COVERS

- Protects 1-1/4", 2" or 2-1/2" receiver tube opening
- Adds a clean, finished look and keeps debris out



Friction fit does not require a pin & clip to hold in place

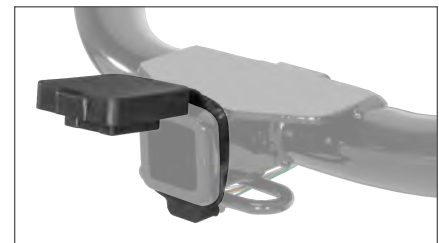

Convenient holder mounts a 4-way flat connector (21728)

Bulk#	Pkg#	Fits Receiver Tube Size	Finish
Rubber Hitch Tube Covers			
22271	22275	1-1/4" x 1-1/4"	Black rubber
22272	22276	2" x 2"	Black rubber
22277	22278	2-1/2" x 2-1/2"	Black rubber
Rubber Hitch Tube Cover with 4-Way Flat Holder			
--	21728	2" x 2"	Black rubber

1/4" & 2" STEEL & PLASTIC HITCH TUBE COVERS

- Adds a clean, finished look and keeps debris out
- Available in high-strength steel or rust-free plastic
- Securely mounts using a pin and clip (not included)



Bulk#	Pkg#	Fits Receiver Tube Size	Finish
Steel Hitch Tube Covers			
21900*	21901	1-1/4" x 1-1/4"	Chrome-plated
22100*	22101	2" x 2"	Chrome-plated
22110*	22111	2" x 2"	Chrome-plated
22750	22751	2" x 2"	Black
Plastic Hitch Tube Covers			
22170	22171	2" x 2"	Chrome-plated
22180	22181	2" x 2"	Black



Protects receiver tube openings when not being used for towing

* Continued while supplies last

PROTECTIVE MULTIPRO / MULTI-FLEX TAILGATE SENSORS

For more information go to page 156

- Prevents deployment of inner tailgate panel when ball mount is installed
- Helps avoid costly tailgate damage
- Easy installation requires no wire cutting or splicing
- No extra electronic components or batteries required
- Sleek, durable design suited for all work conditions



Prevents deployment of inner tailgate panel when ball mount is installed

Pkg#	Fits Receiver Tube	Includes
58265 N	2"	Sensor cap and wiring harnesses
58266 N	2-1/2"	Sensor cap and wiring harnesses

2 INCH GRIP STEP™ HITCH STEPS

- Fits any 2" x 2" receiver tube opening
- Provides a 26" hitch-mounted step on the front or rear of the vehicle
- Fleet-approved, expanded metal treads for maximum traction and safety
- Powder-coated aluminum construction to be strong, lightweight and rust-free
- 6" drop provides easier access into larger vehicles (designed for use in drop position only - #32002)
- Includes hitch pin & clip



Part#	Drop	Step Finish	Shank Finish
32001 N	--	Textured black	Black
32002 N	6"	Textured black	Black

2 INCH HITCH-MOUNTED ACCESSORIES

- Fits any 2" x 2" receiver tube opening

Part#	Description
31006	Spare tire mount (mounting hardware not included)
31001	Step pad with anti-skid surface
31002	License plate holder
31007	Skid shield
31010	Winch mount
31005	Winch mount handles
31009*	Winch mount with handles

* Continued while supplies last



Step pad provides easy under-the-hood access (31001)



Extra protection for the front or rear and hitch (31007)



Allows a winch to be easily attached to a receiver (31009)



24" height accepts multiple tire sizes (31006)

EXTENDED VIEW TOW MIRROR

- Compatible with pickup or SUV left or right side mirror
- Fully adjustable design can be used in horizontal or vertical position
- Hinging arm and elastic straps provide easy and secure installation



Attaches to side mirror to expand view with a trailer



Articulating head allows precise angling



20002

Pkg#	Adds	Fits
20002	5" to 7-1/2" to existing mirror	Mirrors from 4" to 11" high

TOWING ACCESSORIES STORAGE BAG

- Durable fabric construction with heavy-duty zipper
- Comfort-grip handles for easy portability
- High-strength webbing straps full wrap the bag
- Metal lining along the opening keeps bag open and upright for easy access
- Reinforced bottom helps support heavy tools

Part#	Number of Interior Pockets
70004 N	12

NEW



70004

FISH WIRE

- Makes it easier to lead bolts and spacers through tough-to-reach holes
- Ideal for installing a trailer hitch on a vehicle with a hollow frame
- Coiled end accepts threaded bolts

Part#	Length	Coil Diameter
58390	18"	3/8"
58410	18"	7/16"
58400	18"	1/2"
58430	18"	5/8"



58430

PROFESSIONAL FINISHING PACK

- Great for hitch and wiring installations
- Features 11 commonly used automotive trim panel retainers and frame hole plugs

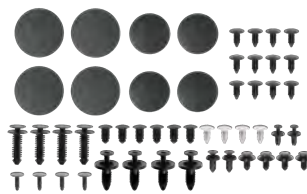

22322

Pkg#	Description
22322	50 automotive finishing pieces in a poly bag

FAB COMPONENTS



RAW STEEL RECEIVER TUBING

- Raw finish allows for immediate welding
- 1/2" reinforcing collar for increased strength
- Features a pre-drilled hitch pin hole



Part#	Finish	Receiver Tube Size	Tube Length
49506	Raw	1-1/4" x 1-1/4"	6"
49512	Raw	1-1/4" x 1-1/4"	12"
49524	Raw	1-1/4" x 1-1/4"	24"
49060	Raw	2" x 2"	6"
49090	Raw	2" x 2"	9"
49120	Raw	2" x 2"	12"
49180	Raw	2" x 2"	18"
49240	Raw	2" x 2"	24"
49360	Raw	2" x 2"	36"
49480	Raw	2" x 2"	48"
49516	Raw	2-1/2" x 2-1/2"	6"
49510	Raw	2-1/2" x 2-1/2"	10"
49511	Raw	2-1/2" x 2-1/2"	18"
49513	Raw	3" x 3"	12"
49515	Raw	3" x 3"	18"



RAW STEEL HITCH BARS

- Raw finish allows for immediate welding
- Rounded corners for easier insertion into the receiver
- Constructed from high-strength, hot-rolled steel
- Features a pre-drilled hitch pin hole

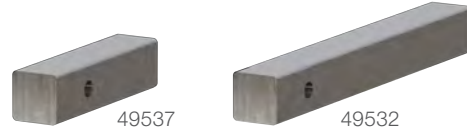

Part#	Finish	Bar Length	Shank Size
49537	Raw	8"	2" x 2"
49529	Raw	10"	2" x 2"
49530	Raw	12"	2" x 2"
49531	Raw	14"	2" x 2"
49532*	Raw	16"	2" x 2"
49533	Raw	18"	2" x 2"
49534*	Raw	20"	2" x 2"
49535*	Raw	22"	2" x 2"
49536	Raw	24"	2" x 2"

* Continued while supplies last

WELD-ON ACCESSORIES

- Features a pre-drilled trailer hitch pin hole (#49717)
- Reinforcing collar provides added strength (#49770)
- Accepts 2x4 studs or adds a tie-down for straps and chains (#83072)
- Provides a safety chain attachment point (#49950)

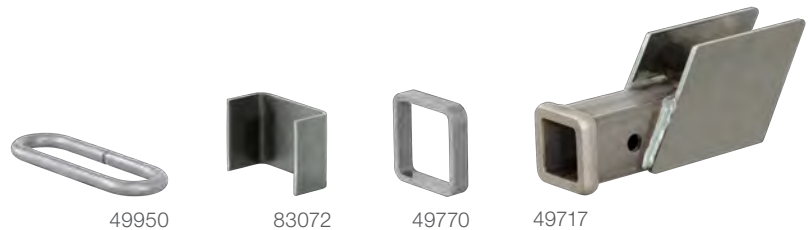

Part#	Description	GTW / TW	Receiver Tube Size	Inside Width	Inside Depth	Finish
49717	Hitch box	5,000 / 500 lbs.	2" x 2"	--	--	Raw
49770	Reinforcement collar	--	2" x 2"	--	--	Raw
83072	Stake pocket	--	--	3-1/2"	1-5/8"	Raw
49950	Safety chain loop	10,000 lbs.	--	--	--	Raw



TOWING ELECTRICAL

TRUST THE TOWING EXPERTS

Echo® mobile brake controller

FEATURED PRODUCTS



Echo® manual override button

This wireless accessory for the Echo® brake controller allows manual activation of the trailer brakes, while supporting hands-free driving.



Dinghy towing adapters

Specifically designed for flat towing applications, we've added several coiled adapters, providing a reliable connection to the RV.



Protective GM tailgate sensor

This receiver-mounted sensor detects when a hitch accessory is installed to avoid damaging the new MultiPro / Multi-Flex tailgate.

PRODUCT INDEX



138
Brake
Controllers



143
Brake Controller
Harnesses



146
Breakaway
Kits



148
Taillight
Converters



150
Custom
Wiring



152
USCAR
Products



154
Wiring Harness
Extensions



157
RV
Harnesses



158
Electrical
Adapters



163
Plugs, Sockets
& Brackets



170
Towing
Lights

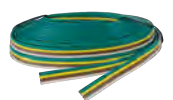

171
Accessories
& Testers

TOWING ELECTRICAL SUBCATEGORY COLOR GUIDE

CURT has identified seven subcategories within the Towing Electrical category to make it easier for retail consumers to find the correct products. Each subcategory is given a unique color that we apply in our literature and retail packaging for easy visibility.

BRAKE CONTROLLERS

CUSTOM WIRING

RV HARNESSES

ELECTRICAL CONVERTERS

PLUGS & SOCKETS

ELECTRICAL ADAPTERS

ACCESSORIES & TESTERS

ELECTRICAL CONNECTOR WIRING GUIDE

- Rear views of plugs & sockets shown in the representative illustrations below
- Colors illustrated may not correspond with wiring found on the tow vehicle or trailer

7-way RV blade traditional configuration

Vehicle side

Trailer side

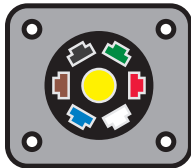

Function	Color
+12 volt	Black
Electric brakes	Blue
Reverse lights	Yellow
Left turn / brakes	Red
Right turn / brakes	Brown
Taillights	Green
Ground	White

6-way round

Vehicle side

Trailer side



Function	Color
+12 volt	Black
Electric brakes	Blue
Left turn / brakes	Yellow
Right turn / brakes	Green
Taillights	Brown
Ground	White

4-way flat

Vehicle side

Trailer side

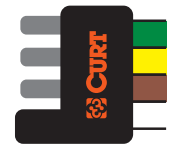

Function	Color
Left turn / brakes	Yellow
Right turn / brakes	Green
Taillights	Brown
Ground	White

WIRING SYSTEMS

Two-wire system

The two-wire system is the simplest form of vehicle and trailer wiring and is still used by some vehicles today. This system sends the stop and turn signals along one wire, and the taillight signal along a second wire.

Three-wire system

The three-wire system is the most common in the automotive industry. It sends the stop, taillight and turn signals along three separate wires. Vehicles with this system usually require a converter.

PWM system

More and more vehicles today use a PWM (pulse width modulation) system. Sometimes called a 'multiplex', this type of wiring is able to control multiple lighting functions through a single wire by varying the signal intensity. PWM systems can use incandescent or LED lights. There are generally two types: ST systems and STT systems.

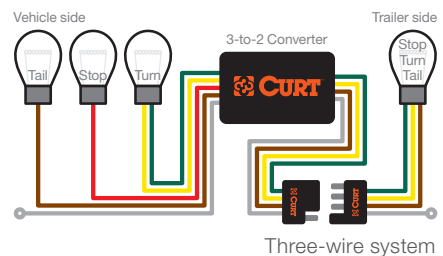



THE INNOVATION LEADER IN BRAKE CONTROLLERS

BRAKE CONTROLLERS

HOW TO SELECT A BRAKE CONTROLLER

There are two basic types of brake controllers. Inertia-based brake controllers use accelerometers to measure the change in velocity or inertia of the tow vehicle when braking. Time-based brake controllers apply a steadily increasing amount of brake power, based on the gain setting and sensitivity adjustment specified by the driver.

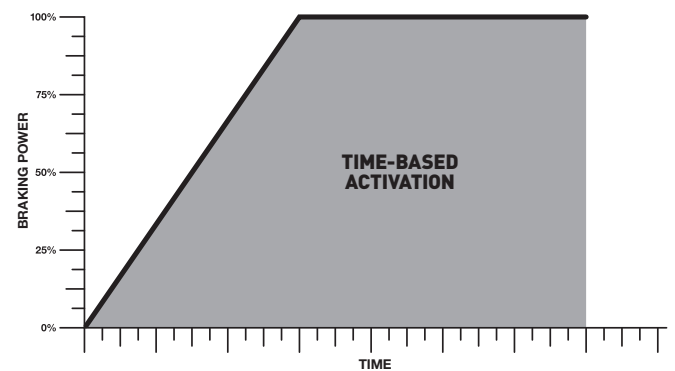
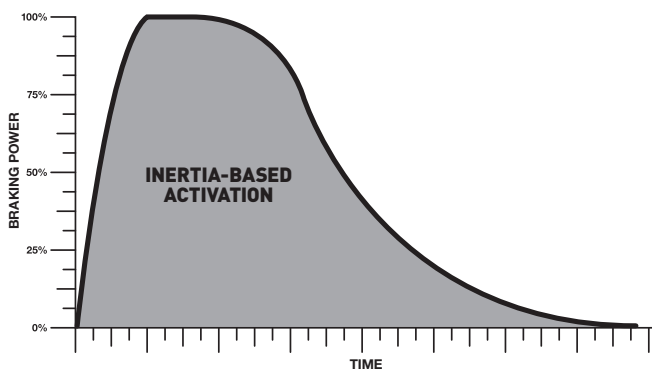

Answer the following questions to help determine which brake controller is the best fit for your customer.

What are they towing?

Heavy-duty

An inertia-based brake controller is ideal for towing heavy or fragile cargo. It will perform much smoother stops, resulting in less stress on the cargo and on the vehicle.

Light-duty

If your customer is planning to tow a relatively lightweight trailer, a time-based brake controller may be sufficient. CURT's time-based controllers are more budget-friendly and perform well with lighter loads.

How often do they tow?

Frequently

If your customer is planning to tow more than twice a year, the precision of an inertia-based brake controller will help protect the life of the vehicle and trailer.

Occasionally

If your customer will only tow once or twice a year, they may prefer the simplicity and relatively lower cost of a time-based controller. Time-based controllers also require very little effort to set up.

BRAKE CONTROLLERS

For a full list of benefits see pages 139 - 141

- Easily calibrated for all towing needs
- Compatible with anti-lock brakes and cruise control
- Includes mounting hardware, if necessary
- Optional spare bracket allows for convenient use of the same brake controller in multiple vehicles (select models)
- Informative, full-color retail packaging
- Limited lifetime warranty (see last page for details)



Echo® Mobile
Bluetooth-enabled
Smartphone-ready
Portable design



Spectrum™
Integrated OE look
Hidden main module
Tri-color LED display

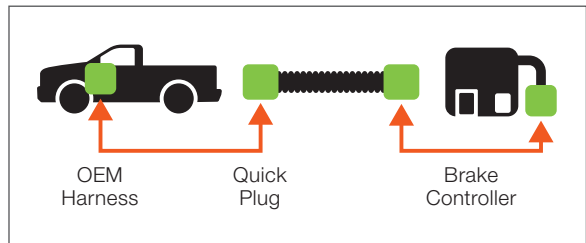

Quick plug equipped for fast, easy installation (excluding Echo®)



Assure™ NEW
Full text readout
Tri-axis sensitivity
Adjustable screen



TriFlex™
Tri-axis sensitivity
Auto adjustment
Digital display



Discovery™
Time-based
Adjustable output
Digital display



Venturer™
Time-based
Adjustable output
Ramp-up LED display

Dynamic power adjustment

Applies to Echo®, Spectrum™, Assure™ and TriFlex™



4.0 ▶ **3.2** Automatic power reduction for incline

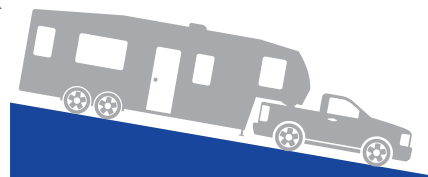

4.0 ▶ **5.3** Automatic power increase for decline

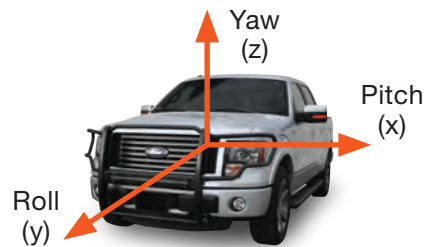

Tri-axis circuit detects inertia on three planes for greater sensitivity over dual-axis models

Note: Values represented are for illustration only. The actual preset and adaptive values may differ from those shown here.

Name	Pkg#	Six-Pack#	Repl. Bracket#	Axles	Brakes	Activation Method	Display	Vertical Mount Angle	Level Adjust	Warranty
Echo®	51180	--	--	1 - 2	2 - 4	Tri-axis inertia	Phone app	N/A	Auto	Limited lifetime
Spectrum™	51170	--	--	1 - 4	2 - 8	Tri-axis inertia	Tri-color LED	Any	Auto	Limited lifetime
Assure™ N	51160	--	51164	1 - 4	2 - 8	Tri-axis inertia	OLED screen	Any	Auto	Limited lifetime
TriFlex™	51140	51142	51144	1 - 4	2 - 8	Tri-axis inertia	Digital	-20° to +70°	Auto	Limited lifetime
Discovery™	51120	51122	51124	1 - 4	2 - 8	Time-based	Digital	Any	Auto	Limited lifetime
Venturer™	51110	--	51114	1 - 3	2 - 6	Time-based	LED	Any	Auto	Limited lifetime

BRAKE CONTROLLERS

ECHO® MOBILE BRAKE CONTROLLER

Scan to learn more



- Wireless, portable design allows for easy transfer from one vehicle to another
- Bluetooth connection to control all brake settings from your smartphone
- Custom-designed app monitors brake activity and sends status updates
- Zero-tool, plug-and-play install between vehicle-trailer 7-way connectors
- Triple-axis, motion-sensing accelerometer for highly responsive, smooth stops
- Stores multiple user and vehicle-trailer profiles
- Multi-color LED indicates power, trailer detection and wireless connectivity
- Potted circuit board is sealed off from the elements for lasting durability
- Retention strap and locking tab help keep Echo® firmly installed into 7-way
- Automatic calibration reduces setup requirements
- Incoming calls can be received while app is running
- Built-in reverse-polarity and short-circuit protection

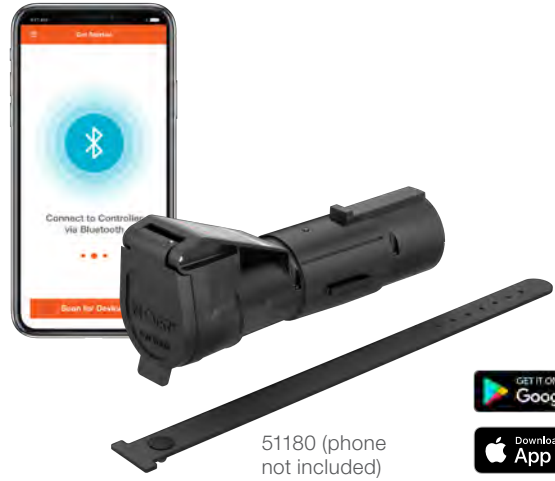

51180 (phone not included)



- Compatible with low-volt, PWM, ABS, cruise control and electric over hydraulic
- If Bluetooth connection is lost, the brake controller will continue to function safely, using the most recently programmed settings
- Not compatible, but will not interfere, with Apple CarPlay or Android Auto



Insert Echo® between the vehicle and trailer



Download the app on your smartphone



Configure settings in the app and tow

BRAKE CONTROLLERS

ECHO® MANUAL OVERRIDE BUTTON

- Wireless accessory supports hands-free driving
- Compatible with Echo® and programmable for other Flic applications (Flic & Shortcut labs are trademarks of Shortcut Labs AB© 2020)
- Long-range Bluetooth maintains a strong connection
- Includes double-sided adhesive pad for easy mounting on the dash
- Soft-touch material for comfortable use
- Replaceable battery with lifespan up to three years
- Small-footprint, 1-1/8" diameter



NEW

51189 button actual size (1-1/8") powered by



Pkg#	Description
51189 N	For use with Echo® brake controller and phone app

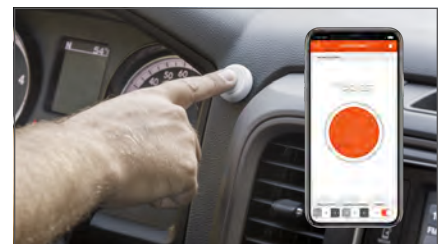

Enables manual activation of trailer brakes, using Echo® and phone app



DASH INTEGRATION FOR OE LOOK AND FEEL

BRAKE CONTROLLERS

SPECTRUM™ BRAKE CONTROLLER

- Triple-axis, motion-sensing accelerometer for highly responsive, smooth stops
- Easily accessible manual override with the press of a button
- Features two installation options: drill mount or surface adhesive mount
- User-selectable power output and trailer brake light activation
- Automatic leveling and calibration eliminate setup requirements
- Equipped with a quick plug for easy, plug-and-play installation
- Operates 2-8 trailer brakes at a time (1-4 axles)
- Built-in reverse-polarity and short-circuit protection
- Compatible with low-volt, PWM, ABS, cruise control and electric over hydraulic
- Tow vehicle 'low voltage' and trailer disconnect indicators
- Includes mounting hardware



1-7/8" diameter

51170 interface
actual size (1-7/8")



51170 all
components



Controls all brake settings with a simple push-button rotary knob



Clean, dash-mounted, OEM-style user interface with 10 tri-color LEDs



Main module can be mounted out of sight to maintain a consistent, original equipment look

**BRAKE
CONTROLLERS**

**ASSURE™
#51160**

- Pressure-sensitive manual override button for precise braking power
- Large, high-quality 1-1/2" OLED screen displays full text readout
- Display can be tilted for different mounting options, above or below the dash
- Triple-axis, motion-sensing accelerometer for highly responsive, smooth stops
- Sleek, low-profile design with tactile buttons
- User-selectable power output and trailer brake light activation
- Nine levels of sensitivity adjustment for varying loads or driving conditions
- Auto sleep mode prevents battery drain
- Built-in reverse-polarity and short-circuit protection
- Compatible with low-volt, PWM, ABS, cruise control and electric over hydraulic



**BRAKE
CONTROLLERS**

**TRIFLEX™
#51140**

- Triple-axis, motion-sensing accelerometer for highly responsive, smooth stops
- Nine levels of sensitivity adjustment for varying loads or driving conditions
- User-selectable power output and trailer brake light activation
- Digital display with 0.1 increments
- Built-in reverse-polarity and short-circuit protection
- Tow vehicle 'low voltage' and trailer disconnect indicators
- Compatible with low-volt, PWM, ABS, cruise control and electric over hydraulic
- Compact size: 3-1/4" wide, 4" deep, 7/8" tall



**BRAKE
CONTROLLERS**

**DISCOVERY™
#51120**

- Increases brake power based on gain setting and sensitivity adjustment
- Features adjustable power and ramp time
- No internal moving parts and no leveling required
- Digital display with 0.1 increments



**BRAKE
CONTROLLERS**

**VENTURER™
#51110**

- Increases brake power based on gain setting and sensitivity adjustment
- Features adjustable power and ramp time
- No internal moving parts and no leveling required
- LED indicator lengthens as power is applied



BRAKE CONTROLLERS

COMPETITOR-TO-CURT ADAPTER

- Allows CURT brake controllers to be used with Tekonsha, Reese, Draw-Tite or Pro Series vehicle-specific brake controller harnesses (Brands are registered trademarks of Horizon Global™)



Pkg#	Description
51520	Connects CURT brake controllers to competitor harnesses

BRAKE CONTROLLERS

QUICK PLUG WITH PIGTAILS

- For vehicles not equipped with factory tow package wiring
- Splices into a vehicle for a quick plug brake controller connection
- Compatible with any CURT brake controller (not necessary on Echo®)



Bulk#	Pkg#	Description
51515	51516	Quick plug with 24" pigtails

BRAKE CONTROLLERS

BRAKE CONTROLLER WIRING KITS

Adapter with brake controller wiring kit

- Adapts a 4-way flat vehicle socket to fit 7-way RV blade trailer plugs
- Includes wiring and components to splice in a brake controller connection



Pkg#	Includes	Size	Qty
57186	Adapter (4-way to 7-way)	4-way flat to 7-way RV blade	1
	Cross-linked wire	10-gauge	25 feet
	Snap lock	12-10 gauge	1
	Flasher	--	1
	Circuit breaker	30-amp	1
	Circuit breaker	40-amp	1
	3/8" ring terminals	12-10 gauge	2
	#10 ring terminals	12-10 gauge	5
	Butt connectors	12-10 gauge	4
	Hex head screws	#10 - 3/4"	8
	Cable ties	8-1/2"	6

Universal brake controller wiring kit

- For tow vehicles not equipped with factory tow package wiring
- Compatible with 2, 4, 6 or 8-brake systems (1-4 axles)
- Designed for use with CURT quick plugs #51515 or #51516
- Brake controller and trailer connector are not included



Pkg#	Includes	Size	Qty
51500	Duplex wire	10-gauge	10 feet
	Cross-linked wire	10-gauge	20 feet
	Circuit breaker	30-amp	1
	3/8" ring terminals	12-10 gauge	2
	#10 ring terminals	12-10 gauge	2
	1/2" ring terminals	12-10 gauge	2
	Butt connectors	12-10 gauge	3
	Cable ties	8-1/2"	8

BRAKE CONTROLLER HARNESS APPLICATION GUIDE

- Quick plug harness installs in less than ten minutes
- Connects a CURT brake controller to specific vehicle applications
- Includes 24" of wire for flexible installation
- Slit-loom sleeve keeps wires contained and protected



Brake controller harness locations

BH1 - Under dash, left of steering column, near emergency brake pedal

BH2 - Under dash, near center console

BH3 - Under dash, in junction box left of steering column

BH4 - Behind storage pocket, above ashtray

BH5 - Under dash, behind center access panel on passenger side

BH6 - Under dash, near brake pedal

BH7 - Behind storage pocket in center of dash

BH8 - Under dash, to right of emergency brake pedal

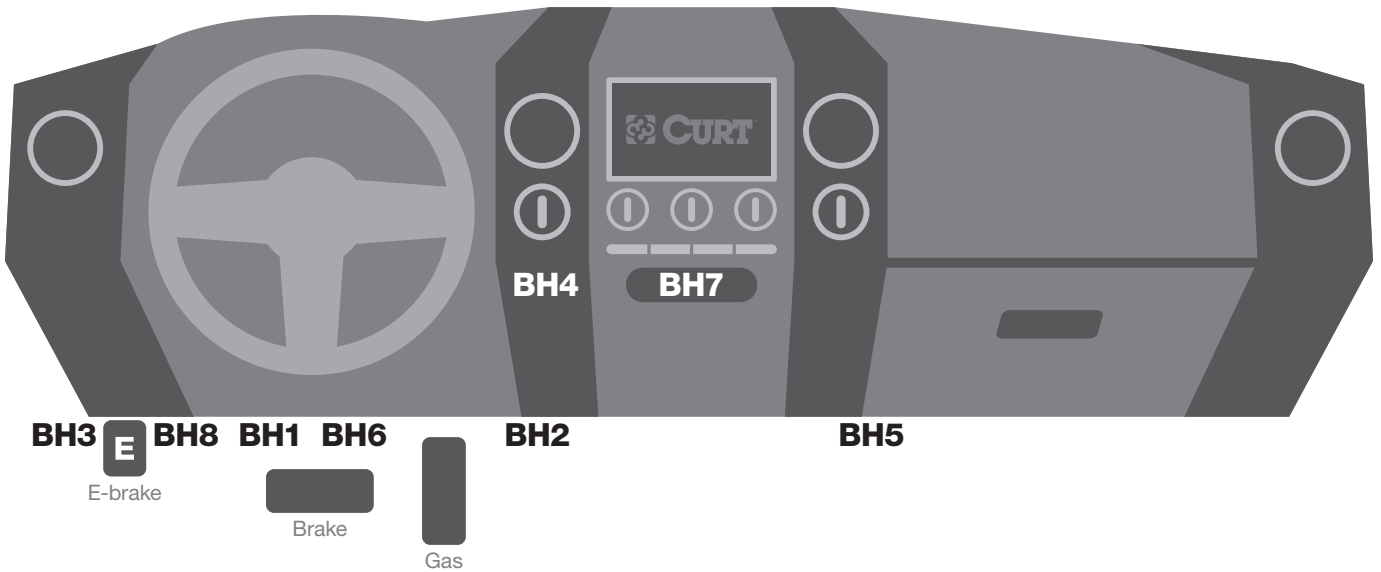

Brake Controller Harnesses				
Make / Model (Style)	Years	Bulk#	Pkg#	Location
Acura				
MDX	14 - 20	--	51523*	BH1
Audi				
Q5	09 - 20	--	51522	BH2
Q7	07 - 20	--	51522	BH2
SQ5	14 - 17	--	51522	BH2
Buick				
Enclave	08 - 17	51422	51423	BH1
Cadillac				
Escalade	14 - 20	51451	51452	BH3, BH1
	03 - 06	51352	51353	BH3
	02 - 02	51342	51343	BH3
Escalade ESV	14 - 20	51451	51452	BH3, BH1
	03 - 06	51352	51353	BH3
Escalade EXT	03 - 06	51352	51353	BH3
	02 - 02	51342	51343	BH3
Avalanche 1500	03 - 06	51352	51353	BH3
	02 - 02	51342	51343	BH3

Brake Controller Harnesses				
Make / Model (Style)	Years	Bulk#	Pkg#	Location
Chevrolet				
Avalanche 2500	03 - 06	51352	51353	BH3
	02 - 02	51342	51343	BH3
Silverado 1500	19 - 21	--	51525	BH1
	14 - 18	51451	51452	BH3, BH1
	03 - 06	51352	51353	BH3
	99 - 02	51342	51343	BH3
Silverado 1500 Classic	07 - 07	51352	51353	BH3
Silverado 1500 HD	03 - 06	51352	51353	BH3
	01 - 02	51342	51343	BH3
Silverado 1500 HD Classic	07 - 07	51352	51353	BH3
Silverado 1500 LD	19 - 19	51451	51452	BH3, BH1
Silverado 2500	03 - 04	51352	51353	BH3
	99 - 02	51342	51343	BH3

* Continued while supplies last
See page 143 for installation location designators
Applications continued on the following page

Brake Controller Harnesses

Make / Model (Style)	Years	Bulk#	Pkg#	Location
Chevrolet (continued)				
Silverado 2500 HD	20 - 21	--	51525	BH1
	14 - 19	51451	51452	BH3, BH1
	03 - 06	51352	51353	BH3
	01 - 02	51342	51343	BH3
Silverado 2500 HD Classic	07 - 07	51352	51353	BH3
Silverado 3500	03 - 06	51352	51353	BH3
	01 - 02	51342	51343	BH3
Silverado 3500 Classic	07 - 07	51352	51353	BH3
Silverado 3500 HD	20 - 21	--	51525	BH1
	14 - 19	51451	51452	BH3, BH1
Suburban	21 - 21	--	51525	BH1
	15 - 20	51451	51452	BH3, BH1
Suburban 1500	14 - 14	51451	51452	BH3, BH1
	03 - 06	51352	51353	BH3
	00 - 02	51342	51343	BH3
Suburban 2500	03 - 06	51352	51353	BH3
	00 - 02	51342	51343	BH3
Suburban 3500 HD	16 - 19	51451	51452	BH3, BH1
Tahoe	21 - 21	--	51525	BH1
	15 - 20	51451	51452	BH3, BH1
	03 - 06	51352	51353	BH3
	00 - 02	51342	51343	BH3
Traverse	09 - 17	51422	51423	BH1
Chrysler				
Aspen	07 - 09	51332	51333	BH1
Pacifica (with fact. tow pkg)	17 - 20	51446	51447	BH8
Dodge				
Dakota	97 - 10	51332	51333	BH1
Durango (with factory tow pkg on #51446 / #51447)	11 - 19	51446	51447	BH8
	98 - 09	51332	51333	BH1
Ram 1500	10 - 10	51438	51439	BH8
	95 - 09	51332	51333	BH1
Ram 2500	10 - 10	51438	51439	BH8
	95 - 09	51332	51333	BH1
Ram 3500	10 - 10	51438	51439	BH8
	95 - 09	51332	51333	BH1
Ford				
Bronco	94 - 96	51322	51323	BH2, BH1
	92 - 93	51312	51313	BH1
E-150	09 - 14	51432	51433	BH5
	03 - 08	51322	51323	BH2, BH1
E-150 Club Wagon	03 - 05	51322	51323	BH2, BH1
E-150 Econoline	92 - 02	51322	51323	BH2, BH1
E-150 Econoline Club Wagon	92 - 02	51322	51323	BH2, BH1
E-250	09 - 14	51432	51433	BH5
E-250 Econoline	92 - 02	51322	51323	BH2, BH1
E-350 Econoline	92 - 98	51322	51323	BH2, BH1
E-350 Econoline Club Wagon	92 - 02	51322	51323	BH2, BH1
E-350 Super Duty	09 - 14	51432	51433	BH5
E-450 Econoline Super Duty	00 - 02	51322	51323	BH2, BH1
E-450 Super Duty	09 - 14	51432	51433	BH5
Excursion	00 - 05	51322	51323	BH2, BH1

Brake Controller Harnesses

Make / Model (Style)	Years	Bulk#	Pkg#	Location
Ford (continued)				
Expedition	18 - 20	--	51524	BH4
	15 - 17	51436	51437	BH7
	13 - 14	51432	51433	BH5
	97 - 12	51322	51323	BH2, BH1
Explorer	02 - 20	51322	51323	BH2, BH1
F-150	09 - 20	51436	51437	BH7
	94 - 08	51322	51323	BH2, BH1
	92 - 93	51312	51313	BH1
F-150 Heritage	04 - 04	51322	51323	BH2, BH1
F-250	94 - 97	51322	51323	BH2, BH1
F-250 HD	97 - 97	51322	51323	BH2, BH1
	F-250 Super Duty	17 - 20	51436	51437
08 - 16		51432	51433	BH5
05 - 07		51372	51373	BH4
99 - 04		51322	51323	BH2, BH1
F-350	94 - 96	51322	51323	BH2, BH1
F-350 Super Duty	17 - 20	51436	51437	BH7
	08 - 16	51432	51433	BH5
	05 - 07	51372	51373	BH4
	99 - 04	51322	51323	BH2, BH1
F-450 Super Duty	17 - 20	51436	51437	BH7
	08 - 16	51432	51433	BH5
	05 - 07	51372	51373	BH4
F-550 Super Duty	17 - 20	51436	51437	BH7
	11 - 16	51432	51433	BH5
	06 - 06	51372	51373	BH4
Flex	12 - 20	51436	51437	BH7
	09 - 11	51322	51323	BH2, BH1
Police Interceptor Utility	13 - 18	51322	51323	BH2, BH1
Windstar	95 - 03	51322	51323	BH2, BH1
GMC				
Acadia	07 - 18	51422	51423	BH1
Acadia Limited	17 - 17	51422	51423	BH1
Sierra 1500	19 - 21	--	51525	BH1
	14 - 18	51451	51452	BH3, BH1
	03 - 06	51352	51353	BH3
	99 - 02	51342	51343	BH3
Sierra 1500 Classic	07 - 07	51352	51353	BH3
Sierra 1500 HD	03 - 06	51352	51353	BH3
	01 - 02	51342	51343	BH3
Sierra 1500 HD Classic	07 - 07	51352	51353	BH3
Sierra 1500 Limited	19 - 19	51451	51452	BH3, BH1
Sierra 2500	03 - 04	51352	51353	BH3
	99 - 02	51342	51343	BH3
Sierra 2500 HD	20 - 21	--	51525	BH1
	14 - 19	51451	51452	BH3, BH1
	03 - 06	51352	51353	BH3
	01 - 02	51342	51343	BH3
Sierra 2500 HD Classic	07 - 07	51352	51353	BH3

* Continued while supplies last
 See page 143 for installation location designators
Applications continued on the following page

Brake Controller Harnesses				
Make / Model (Style)	Years	Bulk#	Pkg#	Location
GMC (continued)				
Sierra 3500	03 - 06	51352	51353	BH3
	01 - 02	51342	51343	BH3
Sierra 3500 Classic	07 - 07	51352	51353	BH3
Sierra 3500 HD	20 - 21	--	51525	BH1
	14 - 19	51451	51452	BH3, BH1
Yukon	21 - 21	--	51525	BH1
	15 - 20	51451	51452	BH3, BH1
	03 - 06	51352	51353	BH3
	00 - 02	51342	51343	BH3
Yukon XL	21 - 21	--	51525	BH1
	15 - 20	51451	51452	BH3, BH1
Yukon XL 1500	03 - 06	51352	51353	BH3
	00 - 02	51342	51343	BH3
Yukon XL 2500	03 - 06	51352	51353	BH3
	00 - 02	51342	51343	BH3
Honda				
Passport	19 - 21	51392	51393	BH1
Pilot	09 - 21	51392	51393	BH1
Ridgeline	06 - 20	51392	51393	BH1
Hummer				
H2	03 - 07	51352	51353	BH3
Infiniti				
QX56	04 - 13	51382	51383	BH1
QX60	14 - 18	51382	51383	BH1
QX80	14 - 20	51382	51383	BH1
Jeep				
Cherokee	14 - 19	51459	51460	BH1
Gladiator	20 - 21	51527	51526	BH1
Grand Cherokee	11 - 20	51446	51447	BH8
Wrangler (JL, Unlimited)	18 - 21	51527	51526	BH1
Kia				
Borrego	09 - 11	51442*	51443*	BH1
Land Rover				
LR3	05 - 09	51322	51323	BH2, BH1
LR4	10 - 15	51322	51323	BH2, BH1
Range Rover	05 - 15	51322	51323	BH2, BH1
Range Rover Evoque	12 - 17	51322	51323	BH2, BH1
Range Rover Sport	06 - 15	51322	51323	BH2, BH1
Lexus				
GX460	10 - 15	51362	51363	BH1
GX470	03 - 09	51362	51363	BH1
LX470	03 - 07	51362	51363	BH1
LX570	08 - 15	51362	51363	BH1
Lincoln				
Mark LT	06 - 08	51322	51323	BH2, BH1
MKT	12 - 19	51436	51437	BH7
	10 - 11	51322	51323	BH2, BH1
Navigator	15 - 20	51436	51437	BH7
	13 - 14	51432	51433	BH5
	98 - 12	51322	51323	BH2, BH1

Brake Controller Harnesses				
Make / Model (Style)	Years	Bulk#	Pkg#	Location
Mercury				
Mountaineer	02 - 10	51322	51323	BH2, BH1
Nissan				
Armada	05 - 20	51382	51383	BH1
Frontier	05 - 20	51382	51383	BH1
NV1500	12 - 20	51382	51383	BH1
NV200	13 - 18	51382	51383	BH1
NV2500	12 - 20	51382	51383	BH1
NV3500	12 - 20	51382	51383	BH1
Pathfinder	05 - 20	51382	51383	BH1
Pathfinder Armada	04 - 04	51382	51383	BH1
Titan	04 - 20	51382	51383	BH1
Titan XD	16 - 19	51382	51383	BH1
Xterra	05 - 15	51382	51383	BH1
Ram				
1500 (Excl. factory integrated brake ctrl - ITBC)	15 - 20	51457	51458	BH2
1500	13 - 14	--	51453	BH8
	11 - 12	51438	51439	BH8
1500 Classic (Excl. factory integrated brake ctrl - ITBC)	19 - 20	51457	51458	BH2
2500 (Excl. factory integrated brake ctrl - ITBC)	15 - 20	51457	51458	BH2
2500	13 - 14	--	51453	BH8
	11 - 12	51438	51439	BH8
3500 (Excl. factory integrated brake ctrl - ITBC)	15 - 20	51457	51458	BH2
3500	13 - 14	--	51453	BH8
	11 - 12	51438	51439	BH8
4500 (Excl. factory integrated brake ctrl - ITBC)	16 - 18	51457	51458	BH2
5500 (Excl. factory integrated brake ctrl - ITBC)	16 - 18	51457	51458	BH2
Saturn				
Outlook	07 - 09	51422	51423	BH1
Toyota				
4Runner	03 - 20	51362	51363	BH1
Land Cruiser	03 - 20	51362	51363	BH1
Sequoia	03 - 20	51362	51363	BH1
Tacoma	16 - 20	51455	51456	BH4
	07 - 15	51362	51363	BH1
Tundra	15 - 18	51455	51456	BH4
	03 - 14	51362	51363	BH1
Volkswagen				
Atlas	18 - 20	--	51522	BH2
Touareg	04 - 17	--	51522	BH2

* Continued while supplies last
See page 143 for installation location designators

Check to ensure battery is charged before towing

- Activates electric trailer brakes in the event of a breakaway
- Meets DOT requirements for holding / breakaway situations
- Compatible on trailers with up to three axles
- LED lights indicate a good charge, battery charging or low battery (#52042, #52044)
- Bolt-on mounting system for secure installation on the trailer
- Required in most states



Pkg#	Loads From	Includes	Replacement Part#
Push-to-Test Breakaway Kits			
52044	Top	Push-to-test, lockable battery case	--
		12-volt 5-amp rechargeable battery	52023
		Built-in battery charger	--
		Nylon breakaway switch	52010
		Mounting hardware	--
52042	Side	Includes the same parts as 52044	--
Soft-Trac 1 Breakaway Kits			
52040	Side	Lockable battery case	--
		12-volt 5-amp rechargeable battery	52023
		Nylon breakaway switch	52010
		Battery charger	52025
		Mounting hardware	--
52041	Side	Includes the same parts as 52040 Battery charger not included	--
Soft-Trac 2 Breakaway Kits			
52028	Top	Lockable battery case with bracket	52029
		12-volt 5-amp rechargeable battery	52023
		Nylon breakaway switch	52010
		Battery charger	52025
52026	Top	Includes the same parts as 52028 Battery charger not included	--

BREAKAWAY KIT & BATTERY CASE REPLACEMENT PARTS

- For use with trailer breakaway systems
- Connects tow vehicle to trailer breakaway battery (#52010, #52011)
- Features a high-temp metal mounting tab and nylon pull-pin (#52020)
- Protects battery and charger from the elements and corrosion
- Constructed from durable polyethylene plastic

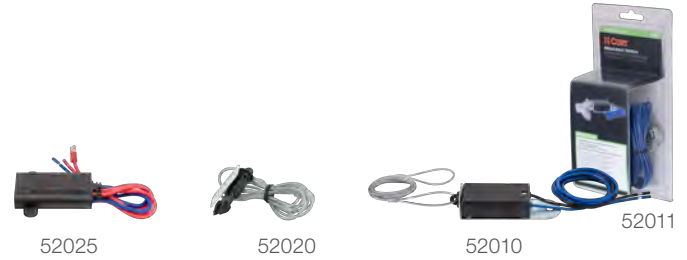

Bulk#	Pkg#	Width	Height	Depth	Description	Loads From	Includes
Breakaway Replacement Parts							
52010	52011	--	--	--	Breakaway switch with 10' leads	--	Nylon case with weldable high-temp, metal tab and silver contact points
52020	--	--	--	--	48" lanyard	--	--
52023	--	3-1/2"	4"	2-3/4"	Sealed lead acid battery for 1-3 axle trailers (12-volt, 5 amps per hour)	--	--
52025	--	--	--	--	12-volt battery charger plug	--	--
Replacement Battery Cases							
52029	--	5"	3-1/4"	3-7/8"	3-1/8" inside bracket depth	Top	Weldable metal bracket for easy mounting on A-frame or jack posts
52030	--	5"	3-1/4"	3-7/8"	--	Side	--
52027	--	5"	3-3/8"	3-3/4"	Watertight case with rubber gaskets and screw-tight lid	Top	Four-screw lid
52022	--	6"	5-1/2"	3-1/4"	--	Top	Lockable tab and a bolt-on mount
52090	--	5-7/8"	5-3/8"	3-1/2"	--	Top	Metal bracket / locking bar for security

BETTERWEIGH™ MOBILE TOWING SCALE

- Offers easy brake controller setup by measuring exact trailer brake gain needed
- No more complicated at-home measurements or trips to the scale
- Bluetooth connection provides active readouts on the driver's smartphone
- No-install, plug-and-play setup into vehicle diagnostic port (OBD-II) below the dash
- Accurate within + / - 5%
- **See page 98 for more information**



Scan to see
it in action!

Download the app:
BetterWeigh Towing Scale



Pkg#	Description
51701	Mobile towing scale



On vehicles with two-wire electrical systems that require a powered converter, the converter's red wire is not used as a stoplight connection and needs to be grounded.

**ELECTRICAL
CONVERTERS**

TAILLIGHT CONVERTERS

For vehicles that are not compatible with CURT custom wiring options, a taillight converter provides a reliable alternative. CURT taillight converters splice into the vehicle's wiring system and provide a standard 4-way flat trailer connector. **Use the Application Guide on page 30 to find the right wiring solution for your customer.**

**ELECTRICAL
CONVERTERS**

3-TO-2-WIRE TAILLIGHT CONVERTERS

For taillight converter applications go to page 30

- Potted enclosure increases water and vibration resistance for mounting on vehicle exterior (#56496 / #59496)
- Provides improved overvolt, ESD and short-circuit protection (#56496 / #59496)
- No heavy-duty flasher required
- Four snap locks included for fast, secure splicing (excluding #58240)
- Kits contain 10-amp powered converter wiring kit #55151



Kit#	Pkg#	Bulk#	30-Pack#	Powered	Circuit-Protected	Signal Circuit	Taillight Circuit	Surface Mount Tech.
59496	56496	--	56497	Yes	Yes	3.0 amps	6.0 amps	Yes
55179	55178	55177	--	--	--	2.1 amps	5.0 amps	No
--	56130	--	--	--	--	3.0 amps	5.0 amps	Yes
--	56175	--	--	--	Yes	3.0 amps	5.0 amps	Yes
59187	56187	--	--	Yes	--	3.0 amps	5.0 amps	Yes
59190	56190	--	--	Yes	Yes	7.5 amps	7.5 amps	Yes
--	--	58240**	--	--	--	2.1 amps	5.0 amps	Yes

** Comes with blunt-cut wires instead of 4-way flat output

**ELECTRICAL
CONVERTERS**

MULTI-FUNCTION TAILLIGHT CONVERTER

- Converts 2-wire, 3-wire or PWM systems to 2-wire trailer light wiring
- Potted enclosure significantly increases resistance to water and vibration
- Constructed with SMT circuitry for better performance and durability
- Microcontroller senses current to rapidly react to overload
- Provides improved overload, short-circuit and thermal protection
- Low-voltage operation allows function down to seven volts
- Four snap locks included for fast, secure splicing
- #59236 contains 15-amp powered converter wiring kit #55152



Kit#	Pkg#	Powered	Circuit- Protected	Signal Circuit	Taillight Circuit
59236	56236	Yes	Yes	5.0 amps	7.5 amps

ELECTRICAL CONVERTERS

LOW-SIDE SWITCHING TAILLIGHT CONVERTER

- SMT circuitry for better performance and durability
- Snap locks included for fast, secure splicing
- No heavy-duty flasher required

Pkg#	Powered	Signal Circuit	Taillight Circuit
56195	Yes	2.1 amps	4.2 amps



56195

ELECTRICAL CONVERTERS

2-TO-3-WIRE TAILLIGHT CONVERTER

- Used for dinghy towing
- Constructed with SMT circuitry for better performance and durability
- No heavy-duty flasher or direct battery connection required
- Not compatible with LED trailer lighting systems

Pkg#	Powered	Signal Circuit	Taillight Circuit
56196	No	2.1 amps	5.0 amps



56196

ELECTRICAL CONVERTERS

24-VOLT TAILLIGHT CONVERTER

- Primarily used for 24V automotive systems, buses, trucks and cab and chassis wiring
- 3-wire to 2-wire converter compatible with incandescent and LED trailer lighting systems
- No heavy-duty flasher or direct battery connection required
- Does not reduce output to 12 volts

Pkg#	Powered	Signal Circuit	Taillight Circuit	Wire Length	Wire Size
56424	No	2.1 amps	7.5 amps	26"	16-gauge



56424

ELECTRICAL CONVERTERS

POWERED TAILLIGHT CONVERTER WIRING KITS

- Routes power from vehicle battery to powered converter



55151



55152

Pkg#	Includes	Size	Qty
55151 (10-amps)	Cross-linked wire	12-gauge	20 feet
	In-line fuse holder	10-amp (red)	1
	ATC10 fuse	10-amp (red)	1
	3/8" ring terminal	12-10 gauge	1
	Butt connector	12-10 gauge	2
	Hex head screw	#8 - 1/2"	1
	Cable tie	14-1/2"	1
	Cable ties	6"	8

Pkg#	Includes	Size	Qty
55152* (15-amps)	Cross-linked wire	12-gauge	20 feet
	In-line fuse holder	15-amp (yellow)	1
	ATC10 fuse	15-amp (blue)	1
	3/8" ring terminal	12-10 gauge	1
	Butt connector	12-10 gauge	2
	Hex head screw	#8 - 1/2"	1
	Cable tie	14-1/2"	1
	Cable ties	6"	8

CUSTOM WIRING

CUSTOM WIRING & T-CONNECTORS

For custom wiring application guide go to page 30

Custom wiring is the easiest way to equip a vehicle with a trailer wiring connection. There are two types: harnesses and connectors. Both are made vehicle-specific and install with no cutting or splicing.

- Provides a standard 4-way flat connector on the vehicle for plugging in trailer wiring
- Simple plug-and-play design eliminates the need for cutting or splicing
- Equipped with a taillight converter if needed
- Dust cover included to keep 4-way flat clean when not in use



Harnesses

Custom wiring harnesses use multiple plugs to 'T' into the taillight assembly

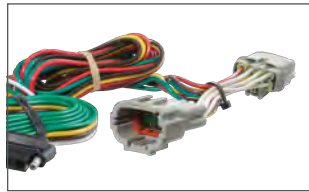

Connectors

Custom wiring connectors use a single plug to plug into a specific OEM socket



CUSTOM WIRING

DODGE FACTORY HARNESS ADAPTER

- Adapts Dodge harness applications to fit USCAR replacement plugs (pictured right)
- Simple plug-and-play design eliminates the need for cutting or splicing
- Slit loom keeps wires contained and well protected



Provides this USCAR socket



Dodge Factory Harness Adapter	
Make / Model	Years
Chrysler	
Aspen	07 - 08
Pacifica	04 - 08
Dodge	
Dakota	00 - 09
Durango	00 - 08
Ram 1500	00 - 08
Ram 1500 Van	01 - 03
Ram 2500	00 - 09

Dodge Factory Harness Adapter	
Make / Model	Years
Dodge (continued)	
Ram 2500 Van	01 - 03
Ram 3500	00 - 09
Ram 3500 Van	01 - 03
Sprinter 2500	03 - 09
Sprinter 3500	03 - 09
Freightliner	
Sprinter 2500	03 - 09
Sprinter 3500	03 - 09

Dodge Factory Harness Adapter	
Make / Model	Years
Jeep	
Commander	06 - 10
Grand Cherokee	00 - 10
Liberty	05 - 08
Mitsubishi	
Raider	06 - 09

#57300 fits all applications listed in this table

CUSTOM WIRING

REPLACEMENT USCAR SOCKET

- Replaces damaged or missing USCAR vehicle harnesses
- Retrofits weatherproof USCAR-type 7-way to vehicles not equipped by using CURT part numbers 55415, 55515, 55664, 55774, 56514, 56515 or 57101

Pkg#	Length	Replaces	Provides
56229	24" wires	Existing vehicle harness connector	USCAR connector end



CUSTOM WIRING

ELECTRICAL ADAPTERS

DUAL-OUTPUT ADAPTERS WITH BACKUP ALARM

- Integrated backup alarm sounds when vehicle is in reverse (97 decibels)
- Provides a 7-way RV blade and 4-way flat socket
- Dust covers included to keep connectors clean when not in use
- Metal bracket securely mounts wiring to the vehicle or trailer hitch



Pkg#	Fits	Plugs Into	Output
Custom Wiring			
57100	Dodge, Chrysler, Jeep	Factory rectangular 8-prong	7-way RV blade and 4-way flat
57101	See USCAR replacement products on page 152	USCAR socket	7-way RV blade and 4-way flat
Adapter			
57102	Universal adapter	4-way flat, manual wiring needed	7-way RV blade and 4-way flat

USCAR CUSTOM WIRING HARNESSES & CONNECTORS



All plug into this USCAR socket

- Products listed fit the applications in the table below
- Fits USCAR-equipped vehicles with factory tow plugs (shown below)
- See page 169 for USCAR mounting bracket #58520
- Weather-resistant dust cover features a rubber insert to seal out moisture (#55416)



55416



55415



56415



55515



55384



55774

Pkg#	Plugs Into	Provides	Output
55664	USCAR socket	Two output connections	6-way round and 4-way flat
55774	USCAR socket	Two output connections	7-way RV blade and 4-way flat
55515	USCAR socket	Replacement end	4-way flat
56515	USCAR socket	Replacement end	5-way flat
55384	T's into USCAR socket	Additional connection	4-way flat
56584	T's into USCAR socket	Additional connection	5-way flat
57101	USCAR socket	Two output connections and backup alarm (97 decibels)	7-way RV blade and 4-way flat
55416	USCAR socket	Heavy-duty replacement socket	7-way RV blade
55415	USCAR socket	Replacement socket	7-way RV blade
56415	USCAR socket	Replacement for twist-lock brackets	7-way RV blade

USCAR Custom Wiring

Make / Model	Style	Years
Audi		
Q7	--	17 - 17
Buick		
Enclave	--	08 - 21
Rainier	--	04 - 07
Cadillac		
Escalade	--	02 - 21
Escalade ESV	--	03 - 21
Escalade EXT	--	02 - 13
XT5	--	17 - 21
XT6	--	20 - 21
Chevrolet		
Avalanche	--	07 - 13
Avalanche 1500 / 2500	--	02 - 06
Blazer	AWD	19 - 21
Colorado	--	04 - 21
Equinox	--	18 - 21
Express 1500	--	09 - 09
Express 2500 / 3500	--	09 - 21
Express 4500	--	09 - 09
Silverado 1500	--	99 - 21
Silverado 1500 Classic	--	07 - 07
Silverado 1500 HD	--	01 - 06
Silverado 1500 HD Classic	--	07 - 07

USCAR Custom Wiring

Make / Model	Style	Years
Chevrolet (continued)		
Silverado 1500 LD	--	19 - 19
Silverado 2500	--	99 - 04
Silverado 2500 HD	--	01 - 21
Silverado 2500 HD Classic	--	07 - 07
Silverado 3500	--	01 - 06
Silverado 3500 Classic	--	07 - 07
Silverado 3500 HD	--	07 - 21
Suburban	--	15 - 21
Suburban 1500	--	00 - 14
Suburban 2500	--	00 - 13
Suburban 3500 HD	--	16 - 19
Tahoe	--	00 - 21
Trailblazer	--	02 - 09
Trailblazer EXT	--	02 - 06
Traverse	--	09 - 20
Chrysler		
Aspen	--	07 - 09
Pacifica	--	17 - 21
Dodge		
Durango	With factory tow pkg	11 - 21
	--	07 - 09
Ram 1500	--	09 - 10
Ram 2500 / 3500	--	10 - 10

USCAR Custom Wiring		
Make / Model	Style	Years
Ford		
E-150 / E-250	--	03 - 10
E-150 / E-350 Club Wagon	--	03 - 05
E-150 / E-250 Econoline	--	97 - 02
E-150 / E-350 Econoline Club Wagon	--	97 - 02
E-350 Econoline	--	97 - 98
E-350 Super Duty	--	99 - 10
E-450 Econoline Super Duty	--	00 - 02
E-450 Super Duty	--	03 - 10
Excursion	--	00 - 05
Expedition	--	97 - 20
Explorer	--	00 - 21
Explorer Sport Trac	--	09 - 09
F-150	--	97 - 21
F-150 Heritage	--	04 - 04
F-250	--	97 - 99
F-250 HD	--	97 - 97
F-250 / F-350 / F-450 / F-550	Super Duty	99 - 21
Flex	--	09 - 16
Police Interceptor Utility	--	18 - 18
Ranger	--	00 - 20
Transit 150 / 250 / 350 / 350HD	--	15 - 20
GMC		
Acadia	--	07 - 21
Acadia Limited	--	17 - 17
Canyon	--	04 - 21
Envoy	--	02 - 09
Envoy XL	--	02 - 06
Envoy XUV	--	04 - 05
Savana 1500	--	09 - 09
Savana 2500 / 3500	--	09 - 21
Savana 4500	--	09 - 09
Sierra 1500	--	99 - 21
Sierra 1500 Classic	--	07 - 07
Sierra 1500 HD	--	01 - 06
Sierra 1500 HD Classic	--	07 - 07
Sierra 1500 Limited	--	19 - 19
Sierra 2500	--	99 - 04
Sierra 2500 HD	--	01 - 21
Sierra 2500 HD Classic	--	07 - 07
Sierra 3500	--	01 - 06
Sierra 3500 Classic	--	07 - 07
Sierra 3500 HD	--	07 - 21
Terrain	--	18 - 21
Yukon	--	00 - 21
Yukon XL	--	15 - 21
Yukon XL 1500	--	00 - 14
Yukon XL 2500	--	00 - 13
Honda		
Passport	--	19 - 21
Pilot	--	09 - 21
Ridgeline	--	06 - 20

USCAR Custom Wiring		
Make / Model	Style	Years
Hummer		
H2	--	03 - 09
H3	--	06 - 10
H3T	--	09 - 10
Infiniti		
JX35	--	13 - 13
QX56	--	04 - 13
QX60 / QX80	--	14 - 21
Isuzu		
Ascender	--	03 - 08
Jeep		
Cherokee	--	14 - 21
Gladiator	--	20 - 20
Grand Cherokee	With fact. tow pkg	19 - 21
	Built before May 18	18 - 18
	--	11 - 17
Wrangler	JK	07 - 18
	JL	18 - 20
Kia		
Borrego	--	09 - 11
Lincoln		
Aviator	--	03 - 05
Mark LT	--	06 - 08
Navigator	--	98 - 20
Mercury		
Mountaineer	--	02 - 10
Nissan		
Armada	--	05 - 20
Frontier	--	05 - 21
Pathfinder	--	05 - 20
Pathfinder Armada	--	04 - 04
Titan	--	04 - 21
Titan XD	--	16 - 21
Oldsmobile		
Bravada	--	02 - 04
Ram		
1500	--	11 - 19
1500 Classic	--	19 - 19
2500 / 3500	--	11 - 21
4500 / 5500	--	11 - 20
ProMaster 1500 / 2500 / 3500	--	14 - 21
Saab		
9-7x	--	05 - 09
Saturn		
Outlook	--	07 - 10
Toyota		
4Runner	--	15 - 21
Land Cruiser	--	18 - 21
Sequoia	--	12 - 21
Tacoma	--	07 - 21
Tundra	--	10 - 21

CUSTOM WIRING HARNESS EXTENSIONS

- Routes a 7-way RV blade socket into truck bed while retaining use of rear socket
- No cutting or splicing
- Allows for easy connection of 5th wheel or gooseneck wiring
- Spring-loaded dust cover
- Requires 2-1/8" hole saw for installation



56070 (7') / 56000 (10')



56071 (7') / 56001 (10')

Custom Wiring Harness Extensions					
Make / Model	Years	7' Pkg#	7' Bulk 10-Pack#	10' Pkg#	10' Bulk 10-Pack#
Chevrolet / GMC					
Silverado / Sierra 1500	19 - 21	56072	--	--	--
	99 - 18	56070	56070010	56000	56000010
Silverado / Sierra 1500 Classic	07 - 07	56070	56070010	56000	56000010
Silverado / Sierra 1500 HD	01 - 06	56070	56070010	56000	56000010
Silverado / Sierra 1500 HD Classic	07 - 07	56070	56070010	56000	56000010
Silverado / Sierra 1500 LD / Limited	19 - 19	56070	56070010	56000	56000010
Silverado / Sierra 2500	99 - 04	56070	56070010	56000	56000010
Silverado / Sierra 2500 HD	20 - 21	56072	--	--	--
	01 - 19	56070	56070010	56000	56000010
Silverado / Sierra 2500 HD Classic	07 - 07	56070	56070010	56000	56000010
Silverado / Sierra 3500	01 - 06	56070	56070010	56000	56000010
Silverado / Sierra 3500 Classic	07 - 07	56070	56070010	56000	56000010
Silverado / Sierra 3500 HD	20 - 21	56072	--	--	--
	07 - 19	56070	56070010	56000	56000010
Dodge					
Dakota	95 - 10	56071	--	56001	--
Ram 1500	09 - 10	56070	56070010	56000	56000010
	95 - 08	56071	--	56001	--
Ram 2500 / 3500	10 - 10	56070	56070010	56000	56000010
	95 - 09	56071	--	56001	--
Ford					
F-150	15 - 20	57008 ¹	--	57010 ¹	--
	97 - 14	56070	56070010	56000	56000010
F-150 Heritage	04 - 04	56070	56070010	56000	56000010
F-250	97 - 99	56070	56070010	56000	56000010
F-250 HD	97 - 97	56070	56070010	--	--
F-250 / F-350 Super Duty	17 - 20	57008 ¹	--	57010 ¹	--
	99 - 16	56070	56070010	56000	56000010
F-450 / F-550 Super Duty	99 - 20	56070	56070010	56000	56000010
Nissan					
Titan	04 - 20	56070	56070010	56000	56000010
Titan XD	16 - 20	56070	56070010	56000	56000010
Ram					
1500 / 2500 / 3500	11 - 20	56070	56070010	56000	56000010
1500 Classic	19 - 20	56070	56070010	56000	56000010
Toyota					
Tundra	10 - 20	56070	56070010	56000	56000010

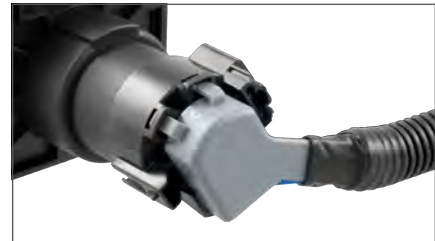

Right-angle plug for easy installation



7' routes socket into rear of the truck bed



10' routes socket closer to truck cab



#55417 covers gaps to provide a clean, factory look in Chev / GMC truck beds

¹ Includes 57007 isolator kit to prevent corrosion of aluminum bodies
² Includes 55417 Chev / GMC truck bed cover to provide a clean, factory look

CUSTOM WIRING HARNESS EXTENSION ISOLATOR KIT

- Neoprene well nuts isolate steel bolts from aluminum surfaces
- Securely mounts a 7-way RV blade extension harness in the truck bed
- Designed for specific Ford applications

Custom Wiring Harness Extension Isolator Kit

Make / Model	Years	Part#
Ford		
F-150	15 - 20	57007
F-250 / F-350 Super Duty	17 - 20	57007

PLUGS & SOCKETS

7-WAY RV BLADE EXTENSION

- Routes existing 7-way RV blade socket into full-size pickup truck bed
- Universal size fits any 7-way RV blade socket
- Allows for easy connection of 5th wheel or gooseneck wiring
- 7' extension length accommodates virtually any size truck bed
- Spring-loaded dust cover keeps connector clean when not in use

Pkg#	Length	Fits
56080	7'	7-way RV blade socket

GM TRUCK BED 7-WAY OPENING COVER PLATE

- Covers gaps to provide a clean, factory look in the truck bed
- Easy, snap-in installation
- Slotted holes for adjustability
- Compatible with spray-in liners

NEW

55417



Bulk#	Adapts
55417 N	CURT 7-way sockets to fit 2020+ factory Chevrolet / GMC truck bed connector openings

PLUGS & SOCKETS

7-WAY RV BLADE REPLACEMENT HARNESSES

- Replaces the trailer-end plug of any 7-way harness
- Wires protected by heavy-duty, weather-resistant cable
- Cold-weather harnesses feature soft thermoplastic elastomer casing to remain flexible in cold temperatures (temperature rating from -40°F up to 221°F)
- Double-sided blades for improved connectivity

Bulk#	Pkg#	Length	Description
56601	56621	6'	Replacement harness
56602	56622	8'	Replacement harness
56603	56623	10'	Replacement harness
56611	--	6'	Cold-weather replacement harness
56612	--	8'	Cold-weather replacement harness
56613	--	10'	Cold-weather replacement harness



56080



56601 (6')
56602 (8')
56603 (10')

56621 (6')
56622 (8')
56623 (10')



56611 (6')
56612 (8')
56613 (10')



STOP DAMAGE BEFORE IT HAPPENS

CUSTOM WIRING

PROTECTIVE MULTIPRO / MULTI-FLEX TAILGATE SENSORS

NEW

- Prevents deployment of inner tailgate panel when ball mount is installed
- Helps avoid costly tailgate damage
- Compatible with GMC MultiPro and Chevrolet Multi-Flex tailgates
- Easy installation requires no wire cutting or splicing
- No extra electronic components or batteries required
- Sleek, durable design suited for all work conditions
- Does not interfere with trailer or towing accessories



Prevents deployment of inner tailgate panel when ball mount is installed



Helps avoid costly tailgate damage



Sleek, durable design suited for all work conditions

Pkg#	Fits Receiver Tube	Includes
58265 N	2"	Sensor cap and wiring harnesses
58266 N	2-1/2"	Sensor cap and wiring harnesses

**RV
HARNESSES**

RV HARNESSES

- Integrated block diodes isolate sensitive vehicle electronics from RV signals
- Uses towed vehicle's existing taillights, brake lights and turn signals
- Optional harness add-on equips vehicle with standard 4-way flat for towing a trailer (not available for all RV harnesses; see table)

For RV harness application guide see page 224



Connects a towed vehicle to an RV using a standard 4-way flat trailer plug



Simple plug-and-play design eliminates the need for cutting or splicing



Includes harness, 4-flat extension, mounting bracket and hardware

**RV
HARNESSES**

SPLICE-IN RV HARNESS

- Connects a towed vehicle to an RV using a standard 4-way flat trailer plug
- Splices into vehicle's electrical system with included butt connectors
- Color-coded wires with wiring guide for easier installation
- Integrated block diodes isolate sensitive vehicle electronics from RV signals
- Uses towed vehicle's existing taillights, brake lights and turn signals
- Not compatible with PWM electrical systems



Part#	Description
58979 N	Splice-in RV harness

**RV
HARNESSES**

RV HARNESS DIODE KIT

- Allows RV to power lights only on the towed vehicle without power feeding back
- Requires trailer-side 4-way flat plug with 20' wires or similar

Pkg#	Amps / Block	Volts / Block	Includes
58999	3 amps	24 volts max	Four diode blocks / 12 spade terminals



4-WAY FLAT

- Allows a standard 4-way flat to connect to other trailer plug types
- Informative, full-color retail packaging



57186



57187



57184

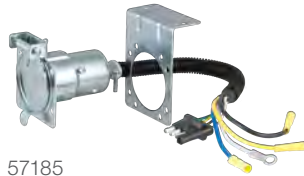

57185



57183



57626

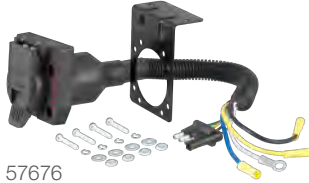

57676



57604



57624



57672



57674



57102

Pkg#	From Vehicle	To Trailer	Notes	Material
Single Output				
57184	4-way flat	7-way RV blade	See mounting brackets on pages 168 and 169	Plastic
57183	4-way flat	6-way round	See mounting brackets on pages 168 and 169	Die-cast
57185	4-way flat	7-way RV blade	Includes mounting bracket	Steel
57186	4-way flat	7-way RV blade	Includes wiring and components to splice in a brake controller connection	Plastic
57187	4-way flat	5-way flat	Ideal for towing a boat trailer with surge brakes	Plastic
57626*	4-way flat	6-way round	Integrated test lamps display proper connections	Plastic
57676*	4-way flat	7-way RV blade	Integrated test lamps display proper connections	Plastic
Dual Output				
57604*	4-way flat	4-way flat 6-way round	--	Plastic
57624*	4-way flat	4-way flat 6-way round	Integrated test lamps display proper connections	Plastic
57672*	4-way flat	4-way flat 7-way RV blade	--	Plastic
57674*	4-way flat	4-way flat 7-way RV blade	Integrated test lamps display proper connections	Plastic
57102*	4-way flat	4-way flat 7-way RV blade	Audible back-up alarm when vehicle in reverse (97 decibels)	Plastic

* Includes mounting bracket and hardware

ELECTRICAL ADAPTERS

ACCESSORY SOCKET

- Powers accessories with the vehicle's 2-, 4- or 5-way flat connector
- Provides a cigarette lighter type socket

Bulk#	From Vehicle	Output	Material
58312	2-way flat	Accessory socket power adapter	Plastic
	4-way flat		
	5-way flat		



ELECTRICAL ADAPTERS

4-WAY ROUND

- Adapts a 4-way round vehicle socket to fit 4-way flat trailer plugs
- Simple plug-and-play design eliminates the need for cutting or splicing



Bulk#	Pkg#	From Vehicle	To Trailer	Material
58414	--	4-way round	4-way flat	Plastic
57224	57225	4-way round	4-way flat	Plastic
57444	--	4-way round	4-way flat	Die-cast

ELECTRICAL ADAPTERS

6-WAY ROUND

- Allows a standard 6-way round to connect to other trailer plug types
- Simple plug-and-play design eliminates the need for cutting or splicing



57621



Bulk#	Pkg#	From Vehicle	To Trailer	Center Pin Function	Material
57620	57621	6-way round	4-way flat	--	Plastic
--	57667	6-way round	7-way RV blade	Taillights	Die-cast and plastic

ELECTRICAL ADAPTERS

6- OR 7-WAY WITH LED DUST COVERS

- LED tester confirms proper function of vehicle-side wiring connector
- Dust cover keeps connector clean when not in use
- Simple plug-and-play design eliminates the need for cutting or splicing



57627



57245



57255



57265

Pkg#	From Vehicle	To Trailer	Center Pin Function
57627	6-way round	4-way flat	--
57245	7-way RV blade	4-way flat	--
57255	7-way RV blade	6-way round	Auxiliary power
57265	7-way RV blade	6-way round	Brake lights



57265 LED cover

ELECTRICAL ADAPTERS

7-WAY RV BLADE FOR LED TRAILER LIGHTS

Did you know?

These adapters are designed for vehicles with a lamp-out indicator. When towing a trailer with LED taillights, the low electrical draw of the LEDs will trigger the indicator. These adapters allow the vehicle to recognize the LED taillights and function normally.

- Allows a 7-way RV blade to connect to other trailer plug types
- Enables vehicles with a 7-way RV blade socket to recognize LED trailer lights
- Built-in, integrated resistors for computers that do not recognize LED lights
- Simple plug-and-play design eliminates the need for cutting or splicing

Pkg#	From Vehicle	To Trailer	Material
57003	7-way RV blade	7-way RV blade	Plastic
57004	7-way RV blade	4-way flat	Plastic
		5-way flat	
57005	7-way RV blade	6-way round	Plastic



57004



57005



57003

ELECTRICAL ADAPTERS

7-WAY RV BLADE AND ROUND

- Simple plug-and-play design eliminates the need for cutting or splicing



57240



57250

57251



57260

57261



57660

57661

Bulk#	Pkg#	From Vehicle	To Trailer	Center Pin Function
57240	57241	7-way RV blade	4-way flat	--
57250	57251	7-way RV blade	5-way flat	--
57260	57261	7-way RV blade	6-way round	Auxiliary power
57660	57661	7-way RV blade	6-way round	Brake lights
57040	57041	7-way round	4-way flat	--



57040

57041

ELECTRICAL ADAPTERS

7-WAY RV BLADE WITH BACKUP ALARM OPTION

- Allows a 7-way RV blade to connect to other trailer plug types
- Integrated backup alarm sounds when vehicle is in reverse (97 decibels)
- Simple plug-and-play design eliminates the need for cutting or splicing



57724



57725



57720



57726

Pkg#	From Vehicle	To Trailer	Center Pin Function
57724	7-way RV blade	4-way flat	--
57725	7-way RV blade	5-way flat	--
57720	7-way RV blade	6-way round	Brake lights
57726	7-way RV blade	6-way round	Auxiliary power
57727	7-way RV blade	7-way RV blade (extender)	--



57727

DINGHY TOWING ADAPTER HARNESSSES

- Plugs into CURT RV harness 4-flat to provide a standard connector under the dinghy vehicle's hood
- Allows for flexible mounting on the front of the dinghy vehicle versus welded connector bracket
- 6' length is ideal for equipping dinghy vehicle for flat towing behind RV
- Some manual wiring required



Pkg#	From Dinghy Vehicle	To RV	Length	Material
58980 N	4-way flat	7-way RV blade	6 feet	Plastic
58981 N	4-way flat	6-way round	6 feet	Plastic

ELECTRICAL ADAPTERS

DINGHY TOWING ADAPTERS

- Ideal for connecting motorhomes to dinghy vehicle for flat towing
- UV-resistant coiled cable extends without scraping the ground
- Simple plug-and-play design eliminates the need for cutting or splicing
- Constructed from die-cast or durable plastic
- Informative, full-color, retail packaging



Pkg#	From Dinghy Vehicle	To RV	Extends	Included Socket	Socket Housing
57271	4-way flat	7-way RV blade	5 feet	--	Plastic
57280 N	4-way flat	7-way RV blade	8 feet	--	Plastic
57281	5-way flat	7-way RV blade	5 feet	--	Plastic
57282 N	5-way flat	7-way RV blade	8 feet	--	Plastic
57283 N	6-way round	7-way RV blade	8 feet	One 6-way round	Plastic and die cast
57284 N	7-way RV blade	7-way RV blade	8 feet	One USCAR 7-way RV blade	Plastic
57285 N	4-way round	7-way RV blade	8 feet	One 4-way round	Plastic and die cast
57286 N	6-way round	6-way round	8 feet	Two 6-way round	Die cast

PLUGS & SOCKETS

4-WAY FLAT

- Splices into existing wiring to supply power from the vehicle to the trailer
- Looped wires can also be used as a wire extension for an existing connector
- Constructed with 16-gauge bonded wires and durable molded rubber
- Operates on a two-wire system



Bulk#	Pkg#	Pkg Kit#	Location	Wire Length	Description
58030	58031	58033*	Trailer	12"	Plug with bonded wire
--	58348	58349*	Trailer	48"	Plug with bonded wire
58040	58041	58044*	Vehicle	60"	Socket with bonded wire
--	58304	58344*	Vehicle	12"	Socket with bonded wire
--			Trailer	12"	Plug with bonded wire
--	58355	58305*	Vehicle	48"	Socket with bonded wire
--			Trailer	12"	Plug with bonded wire
58050	58051	--	Vehicle	72"	Socket with bonded loop
--			Trailer		Plug with bonded loop
58380	58381	--	Vehicle	12"	Socket with bonded loop
--			Trailer		Plug with bonded loop
--	57220	--	Trailer	20 feet	Plug with bonded wire

* Includes snap locks and hardware (varies by part number)

** Includes snap locks, hardware and mounting bracket



PLUGS & SOCKETS

2-WAY FLAT

- Splices into existing wiring to supply power to an electrical accessory
- 18-gauge looped wire can also be used as an extension for an existing connector
- Constructed with bonded wires and durable molded rubber

Bulk#	Pkg#	Location	Wire Length	Description
58020	58021	Vehicle	12"	Socket with bonded loop
		Trailer		Plug with bonded loop



PLUGS & SOCKETS

4-WAY FLAT LICENSE PLATE LIGHT PLUGS

- 1-1/4" plug fits a typical license plate light hole
- Includes dust cover
- Constructed with durable molded rubber
- Refer to state and local laws before removing license plate light



Bulk#	Pkg#	Location	Wire Length	Description
58404	57404	Vehicle	--	Adapter
		Trailer		
58405	57405	Vehicle	36"	Socket with bonded wire
58406*	57406	Vehicle	60"	Socket with bonded wire

* Continued while supplies last

PLUGS & SOCKETS

4- & 5-WAY FLAT DUST COVERS

- Protects connector from water, dust and road grime when not in use
- Helps prevent internal corrosion for a long operating life
- Attachment loop allows for fast, easy installation
- Constructed from durable molded rubber



Bulk#	Pkg#	Location	Material	Fits
58200	58201	Vehicle	Rubber	4-way flat
58750	--	Trailer	Rubber	4-way flat
--	58761	Vehicle	Rubber	4-way flat
		Trailer		
58202	58203	Vehicle	Rubber	5-way flat



PLUGS & SOCKETS

5-WAY FLAT

- Ideal for trailers with surge brakes, commonly found on larger boat trailers
- Splices into existing wiring to supply power from the vehicle to the trailer
- Looped wires can also be used as a wire extension for an existing connector
- Constructed with 16-gauge wires and durable molded rubber



58530

58531



58545



58540

58541

Bulk#	Pkg#	Pkg Kit#	Location	Wire Length	Description
58530	58531	58545*	Vehicle	60"	Socket with wire
58540	58541	--	Trailer	48"	Plug with wire
58550	58551	--	Vehicle	72"	Socket with loop
			Trailer		Plug with loop

* Kit includes five snap locks, mounting bracket and hardware



58550

58551

PLUGS & SOCKETS

4-WAY ROUND

- Splices into existing wiring to supply power from the vehicle to the trailer
- Concealed terminals help ensure a reliable connection
- Constructed from strong die-cast metal
- Dust- and water-resistant design to withstand the elements



58060

58061



58070

58071



58671



58677

Bulk#	Pkg#	Pkg Kit#	Location	Material	Description
58060	58061	--	Trailer	Die-cast	Round plug
58070	58071	--	Vehicle	Die-cast	Round socket
--	58671	58677*	Trailer	Die-cast	Round plug (58060)
			Vehicle	Die-cast	Round socket (58070)

* Includes mounting bracket, wiring and hardware

PLUGS & SOCKETS

6-WAY ROUND

- Splices into existing wiring to supply power from the vehicle to the trailer
- Concealed terminals help ensure a reliable connection
- Spring-loaded dust covers keep connectors clean when not in use



58120



58082



58083



58093



58130



58080



58081



58092



58090



58091

Bulk#	Pkg#	Pkg Kit#	Location	Material	Description
58080	58081	--	Trailer	Die-cast	Round plug
58120	--	--	Trailer	Chrome plastic	Round plug
58082	58083	--	Trailer	Die-cast	Round plug with spring
58090	58091	--	Vehicle	Die-cast	Round socket
58130	--	--	Vehicle	Plastic	Round socket
--	58092	58093*	Trailer	Die-cast	Round plug (58080)
--			Vehicle	Die-cast	Round socket (58090)

* Kit includes five snap locks, mounting bracket and hardware

PLUGS & SOCKETS

6-WAY SQUARE

- 6-way square connectors are commonly used on popup campers
- Splices into existing wiring to supply power from the vehicle to the trailer
- Looped wires can also be used as a wire extension for an existing connector

Pkg#	Location	Wire Length	Description
58034	Vehicle	12"	Square socket with loop
	Trailer		Square plug with loop
58035*	Vehicle	12"	Square socket with wire

* Continued while supplies last



58034



58035

PLUGS & SOCKETS

7-WAY ROUND

- 7-way round connectors are commonly used on semi- and utility trailers
- Splices into existing wiring to supply power from the vehicle to the trailer
- Constructed from strong die-cast metal



58170



58160



58161



58180

58181

Bulk#	Pkg#	Location	Material	Description
58170	--	Vehicle	Die-cast	Round socket
58160	58161	Trailer	Die-cast	Round plug
58180	58181	Trailer	Die-cast	Round plug with spring

PLUGS & SOCKETS

7-WAY RV BLADE

- Concealed terminals help ensure a reliable connection
- Ergonomic design offers a comfortable, more secure grip (#58145)
- Weather-resistant dust cover features a rubber insert to seal out moisture (#58155)



58140



58141

58145



58155



Bulk#	Pkg#	Pkg Kit#	Location	Material	Description
58140	58141	--	Trailer	Plastic	RV blade plug
--	58145	--	Trailer	Plastic	Heavy-duty RV blade plug
58150	58151	--	Vehicle	Plastic	RV blade socket
--	58155	--	Vehicle	Plastic	Heavy-duty RV blade socket
58190	--	--	Trailer	Die-cast	RV blade plug
58220	--	--	Vehicle	Steel	RV blade socket
--	58417	--	Vehicle	Plastic	RV blade socket with mounting bracket
--	--	58152*	Trailer	Plastic	RV blade plug
			Vehicle	Plastic	RV blade socket

* Kit includes six snap locks, mounting bracket and hardware

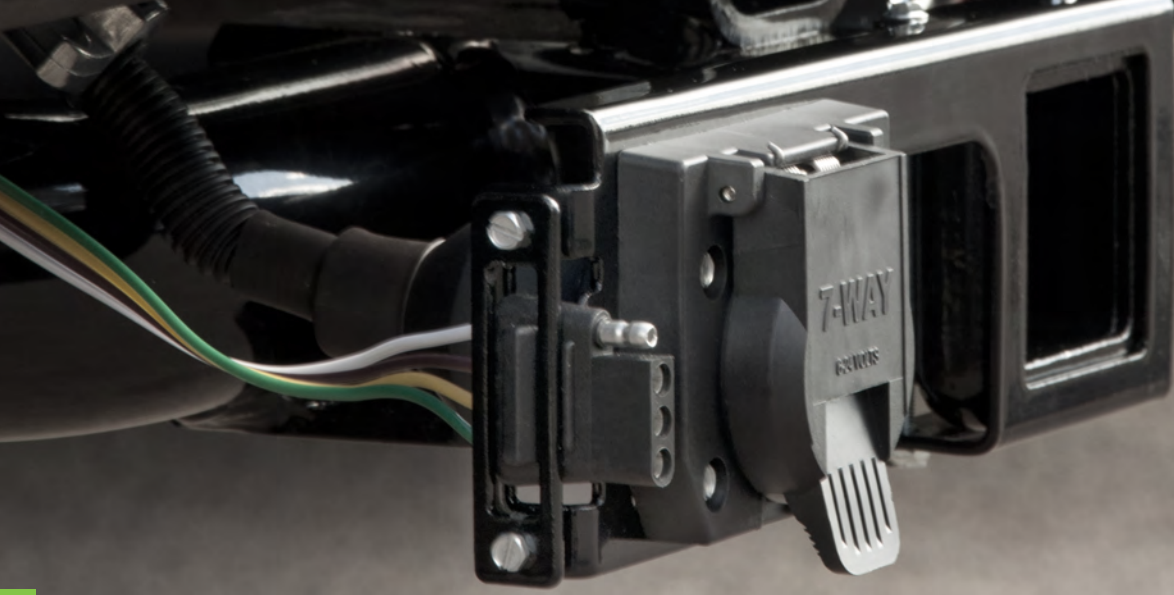

PATENTED. NO-DRILL. HITCH-MOUNTED DESIGN.

PLUGS & SOCKETS

EASY-MOUNT™ ELECTRICAL BRACKETS

- Allows connectors to be hitch-mounted with no drilling or clamping required
- Two threaded stainless steel bolts provide secure attachment to the hitch
- Notched design allows convenient access to pin & clip
- Steel body will not break like competitive plastic products
- Protected by a durable powder coat finish
- Bulk retail boxes contain 10 poly-bagged units
- Patent #9,016,707

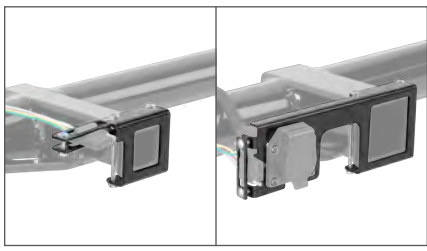

Slotted holes to fit multiple connector types (varies by part number, see table below)



Pkg#	Bulk Retail 10-Pack#	Receiver Tube Opening	Holds
58002	58002010*	1-1/4" x 1-1/4"	4- or 5-way flat sockets
58001	58001010	2" x 2"	4- or 5-way flat sockets
58000	58000010	2" x 2"	4- or 5-way flat and 6- or 7-way sockets
58003	--	2-1/2" x 2-1/2"	4- or 5-way flat and 6- or 7-way sockets

* Continued while supplies last



ELECTRICAL SOCKET MOUNTING BRACKETS

- Allows for secure connector attachment to the vehicle or trailer hitch
- Steel body will not break like competitive plastic products
- Mounting hardware not included (excluding #58303)



Bulk#	Bulk 12-Pack#	Pkg#	Fits	Description	Finish
For 4-Way Flat, 5-Way Flat and 6-Way Round Connectors					
58300	--	58301	4-way flat	--	Gloss black
--	--	58303	5-way flat	--	Carbide black
--	57207*	57208	4- or 6-way round sockets	--	Gloss black
58210	--	--	4- or 6-way round sockets	--	Zinc-plated
For 7-Way Round and 7-Way RV Blade Connectors					
58222	--	--	7-way round socket #58170	--	Zinc-plated
--	57205	57206	7-way RV blade socket #55415, #58150 and #58220	Increased strength, slotted screw holes	Gloss black
58230	--	58231	7-way RV blade sockets #58150 and #58220	--	Zinc-plated
58290	--	58291	7-way RV blade sockets #58150 and #58220	--	Gloss black
58510	--	--	7-way RV blade sockets #58150 and #58220	Increased strength	Gloss black
58520	--	--	7-way USCAR factory Ford, GM and Nissan sockets	--	Gloss black
For Mounting Connector Brackets to Trailer Hitches					
--	57203	57204	4- or 5-way flat and 6-way round brackets	Short, universal clamp-on mount	Gloss black
--	57201	57202	7-way round or RV blade sockets	Long, universal clamp-on mount	Gloss black

* Continued while supplies last

ACCESSORIES & TESTERS

LENSES & COMBO LIGHTS

- Exceeds DOT requirements for stop, tail, rear and side reflectors, side markers and license plate illumination
- Two extra connections provide hookups for other lights
- Features a molded housing with standard red lenses
- Phosphor-bronze contacts for good connection in any weather
- Bolt-on mounting system for secure installation on the trailer



Pkg#	Vehicle Side	Lens Color	License Plate Illumination
53440	Passenger	Red	No
53441	Driver	Red	Yes
53445	Rear replacement lens		
53515	Side replacement lens		

ACCESSORIES & TESTERS

SUBMERSIBLE COMBO LIGHTS

- Great for replacing lights on a boat trailer
- Exceeds DOT requirements for stop, tail, rear and side reflectors, clearance and license plate illumination
- Watertight design allows for full water immersion
- Bolt-on mounting system for secure installation on the trailer
- Legal for trailers over 80" wide



Pkg#	Vehicle Side	Lens Color	License Plate Illumination
53452	Passenger	Red	No
53453	Driver	Red	Yes

ACCESSORIES & TESTERS

TRAILER LIGHT KIT

- Exceeds DOT highway standards
- Designed to replace all necessary trailer lights on most trailers
- Easily connects to any standard automobile lighting system
- Frame mounting clips keep wires contained and protected
- Ideal for trailers up to 80" wide



Pkg#	Length	Plug	Includes
53540	20'	4-way flat	Two combination lights, two marker lights, license plate bracket and frame mounting clips

ACCESSORIES & TESTERS

TOWING LIGHTS

- Easily adds tow lights to a dinghy-towed vehicle or trailer without lights
- Non-scratch magnetic base protects vehicle finish
- Perfect for boats, RVs and flat towing applications
- 20' cord with 4-way flat plug allows for plug-and-play convenience
- Snap locks included for simple, secure splice-in connection
- Patent# D355,270



Bulk#	Pkg#	Length	Plug	Description	
	53200	53204*	20'	4-way flat	Auxiliary towing lights

* Includes a sturdy, reusable case

ACCESSORIES & TESTERS

CONNECTOR TESTERS

- Confirms proper function of vehicle-side wiring connector
- Constructed with LED lights for long-lasting use



Bulk#	Pkg#	Description	Material
58260	58261	LED 4-way flat	Plastic
57505	--	LED 5-way flat	Plastic
58650	--	LED 6-way round	Plastic
58270	58271	LED 7-way RV blade	Plastic

ACCESSORIES & TESTERS

BRAKE CONTROLLER TESTERS

- Tests vehicle wiring for battery voltage, brake voltage and signal circuits (#51498)
- Designed to bench test a brake controller for proper function (#51521)
- Tests brake voltage, pedal activation, short-circuit / overload and disconnect (#51521)



Bulk#	Tests	Plug	Socket
51498	Vehicle-side wiring functions	7-way RV blade	--
51521*	Brake controller unit	--	Quick plug

* Continued while supplies last

ACCESSORIES & TESTERS

BONDED 4-WIRE SPOOL

- Standard 4-way wire for rewiring a trailer or a similar application



Pkg#	Gauge	Length	Description
57001	16	25'	Bonded four-wire spool (green, yellow, brown, white)

SNAP LOCKS & WIRE NUTS

- Instantly splices two wires together using only a pliers
- Aluminum blade pierces both channels to eliminate any stripping or soldering
- Latching safety lock ensures a reliable connection
- Side gap allows for easy insertion of existing wire
- Constructed from high-impact plastic to protect against corrosion



Bulk#	Gauge	Description	Quantity
58280	18-14	Tap connector	100
59906	18-14	Double-run tap connector	100
59956	18-14	Tap connector with gel sealant	100
59905	12-10	Tap connector	100
59901	18-10	Wire nut	100

RING & SPADE TERMINALS

- Allows wires to be fastened down for a firm connection
- Perfect for installing towing electrical components or similar applications
- Vinyl-insulated to ensure a long-lasting connection
- Flared opening allows for easy wire insertion

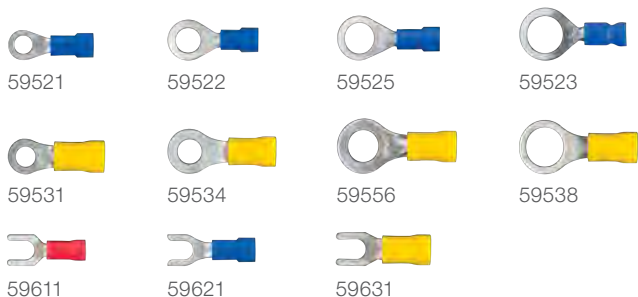

Bulk#	Gauge	Stud Size	Color	Quantity
Ring Terminals				
59521	16-14	#10	Blue	100
59522	16-14	1/4"	Blue	100
59525	16-14	5/16"	Blue	100
59523	16-14	3/8"	Blue	100
59531	12-10	#10	Yellow	100
59534	12-10	1/4"	Yellow	100
59556	12-10	5/16"	Yellow	100
59538	12-10	3/8"	Yellow	100
Spade Terminals				
59611	22-18	#10	Red	100
59621	16-14	#10	Blue	100
59631	12-10	#10	Yellow	100

BUTT & QUICK CONNECTORS

- Quick connectors provide a firm wire connection with the option to disconnect later
- Butt connectors splice wires together with no taping required
- Perfect for installing towing electrical components or similar applications
- Vinyl-insulated to ensure a long-lasting connection
- Flared opening allows for easy wire insertion

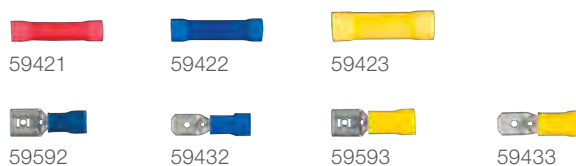

Bulk#	End	Gauge	Color	Quantity
Butt Connectors				
59421	--	22-18	Red	100
59422	--	16-14	Blue	100
59423	--	12-10	Yellow	100
Quick Connectors				
59592	Female	16-14	Blue	100
59432	Male	16-14	Blue	100
59593	Female	12-10	Yellow	100
59433	Male	12-10	Yellow	100

**ACCESSORIES
& TESTERS**

HEAVY-DUTY FLASHERS, CIRCUIT BREAKERS & FUSES

- Recommended for applications where over-current protection is required
- Turn signal flashers are 12-volt, two-terminal flashers

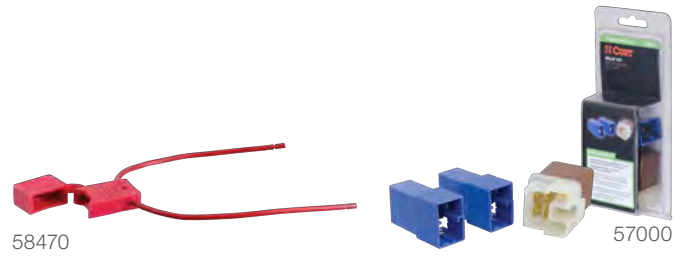

Bulk#	Amps	Description	Qty
Fuses and Holder			
58440	10 amps	ATC fuse	100
58450	15 amps	ATC fuse	100
58460	20 amps	ATC fuse	100
58470	10 amps	In-line fuse holder	12
Relays			
57000	--	'04 to present Nissan Armada and Titan without factory tow package	1

Bulk#	Amps	Description	Qty
Flashers			
58310	14 amps	Flasher 1-4 lamps or 2-8 hazard	1
58320	14 amps	Flasher 2-3 lamps or 2-6 hazard	1
Circuit Breaker			
58341	15 amps	Universal circuit breaker	1
58351	20 amps	Universal circuit breaker	1
58361	30 amps	Universal circuit breaker	1
58371	40 amps	Universal circuit breaker	1

**ACCESSORIES
& TESTERS**

SLIT LOOM & CLAMP

- Protects loose wires against vibration and damage
- Keeps multiple wires contained in a single channel
- Slit lengthwise for easy application to wires
- Stronger and easier to use than a braided sleeve or wire spiral wrap



Bulk#	Pkg#	Description	Amount
58823	--	1/4" convoluted slit loom	Per foot
59824	59825	3/8" convoluted slit loom	Per foot / 25'
59826	59827	1/2" convoluted slit loom	Per foot / 25'
--	59828	3/8" ID nylon loom clamp	25 per bag

**ACCESSORIES
& TESTERS**

ELECTRICAL TAPE & ZIP TIES

- Self-locking ties for securing wires and cables
- Zip tie mechanism allows for tight bundling
- Tapered end for easier insertion into lock



Bulk#	Length	Quantity	Specifications	Description
59728	7-1/4"	100	--	Zip ties
59732	14-1/4"	100	--	Zip ties
59740	60'	10-pack	7 mil x 3/4"	Electrical tape



WEIGHT DISTRIBUTION

TRUST THE TOWING EXPERTS

TruTrack™ weight distribution system



FEATURED PRODUCTS



TruTrack™ system

With active sway control and weight distribution, TruTrack™ offers smooth, safe towing and is available in 5-8K, 8-10K and 10-15K options.



TruTrack™ brackets

Replacement support brackets for the TruTrack™ weight distribution hitch are available to fit 6", 8" and 10" trailer frames.



Deep drop shank

The #17132 WD shank offers a drop of up to 8", and it fits 2-1/2" receivers – perfect for CURT Commercial Duty hitches.

PRODUCT INDEX



176
TruTrack™
WD Systems



178
Trunnion Bar
WD Hitches



179
MV Round Bar
WD Hitches



180
WD
Shanks



181
Sway
Control



181
Hook-Up
Brackets

HOW WEIGHT DISTRIBUTION WORKS

CURT weight distribution hitches are designed to distribute the tongue weight of a trailer across all axles of the vehicle-trailer combination, allowing for more control and safer towing.

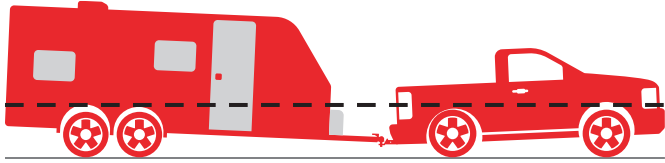

Without weight distribution

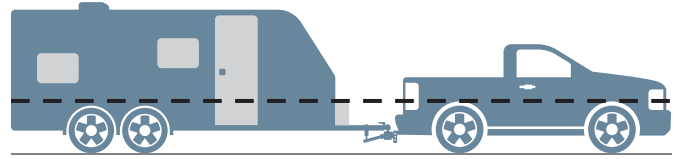

With weight distribution

2

INCH

TRUTRACK™ WEIGHT DISTRIBUTION SYSTEMS

- Integrated sway control actively resists sway and levels the vehicle and trailer
- Welded head with cast pieces provides solid spring bar attachment
- Uses spring & cam system with hardened components, instead of metal friction
- Brackets use friction to resist lateral movement, replacing a sway control
- Fits virtually all A-frame trailers
- 2" shank can be used in the drop or rise position
- Durable carbide black powder coat finish and industrial chrome-plated cam components



Quick, easy tilt adjustment, no disassembly required (excl 17501)



Adjustable brackets provide fixed support unlike chain models

For additional shank options see page 180

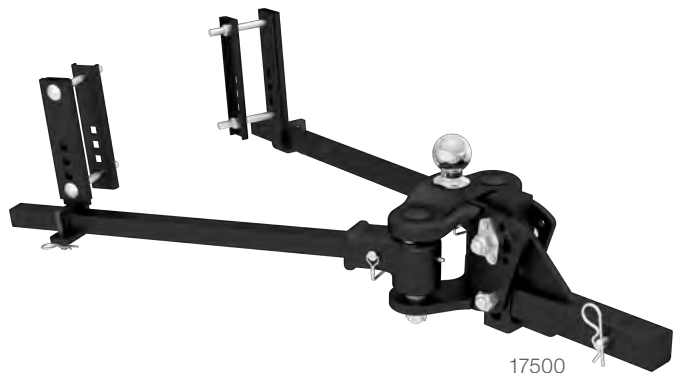

17500

Did you know?

TruTrack™ is designed to work in two neutral spring bar settings to fit almost all A-frame trailers. The spring bars can be positioned in the 30- or 70-degree position (+/-5 degrees). Adjustment takes only 15 to 20 minutes, start to finish.

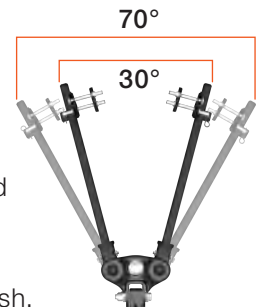

17499

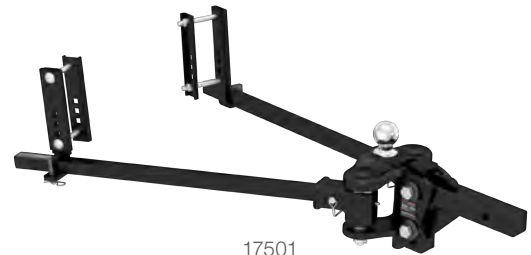

17501

Pkg#	GTW	TW	Bar Length	Description
17499	5,000 - 8,000 lbs.	500 - 800 lbs.	35-9/16"	WD system only (trailer ball not included)
17500	8,000 - 10,000 lbs.	800 - 1,000 lbs.	35-9/16"	WD system (17500) and pre-torqued 2-5/16" trailer ball (40006)
17501	10,000 - 15,000 lbs.	1,000 - 1,500 lbs.	35-9/16"	WD system (17501) and pre-torqued 2-5/16" trailer ball (40030)

TRUTRACK™ WEIGHT DISTRIBUTION SYSTEMS & REPLACEMENT PARTS

Scan to learn more



How active sway control works

Spring-loaded bearings maintain pressure

Bearings within the head maintain pressure on the spring bars, actively aligning the trailer with the vehicle.

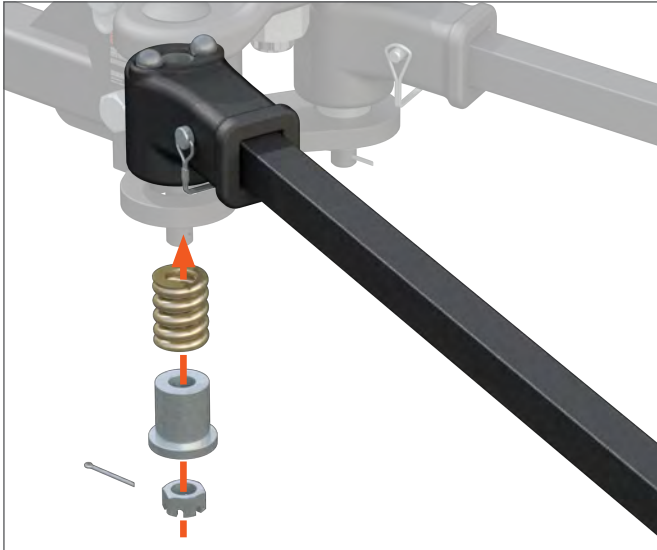

Active resistance

Lateral forces compress the bearings into a rotational groove to actively resist sway. More sway = greater resistance.



Increased control

Downward force on the spring bars increases sway control. More trailer weight = more sway control.



Smooth turning

When turning, the bearings compress to their critical limit, freeing them to make a smooth turn.

Replacement Parts

Fig#	Part#	Description	Fits
1	17535	Spring bar	17499
1	17536	Spring bar	17500
1	17537	Spring bar	17501
2	17506	Head (ball not included)	17499
2	17507	Head (ball not included)	17500
2	17509	Head (ball not included)	17501
3	17512	Lift handle	All
4	17508	Support brackets, 6", qty 2	All
4	17515	Support brackets, 8", qty 2	All
4	17516	Support brackets, 10", qty 2	All
5	17513	L-pins & clips	All
6	17550	Hardware kit includes: - 3/4" x 4" hex bolt, qty 1 - 3/4" x 5" hex bolt, qty 1 - 3/4" nylock nuts, qty 2 - Lynch pin, qty 2 - Head tilt spacer, qty 2 - Hitch pin & clip	17499, 17500
6	17554	Hardware kit includes: - 3/4" x 5" hex bolt, qty 2 - 5/8" x 1-1/2" hex bolt, qty 1 - 3/4" conical washers, qty 4 - 1/2" flat washers, qty 2 - Adjustment rod, short, qty 1 - Adjustment rod, long, qty 1 - 3/4" nylock nuts, qty 2 - Lynch pin, qty 2 - Hitch pin & clip	17501

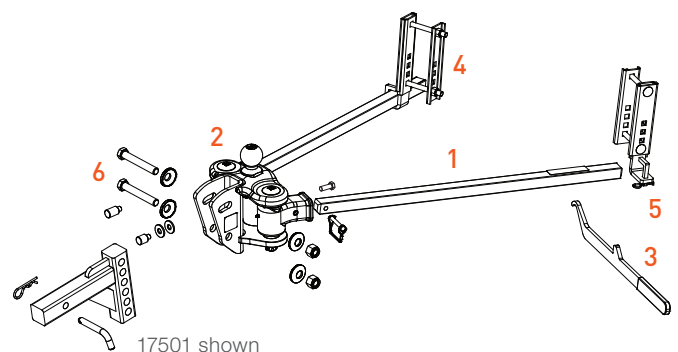
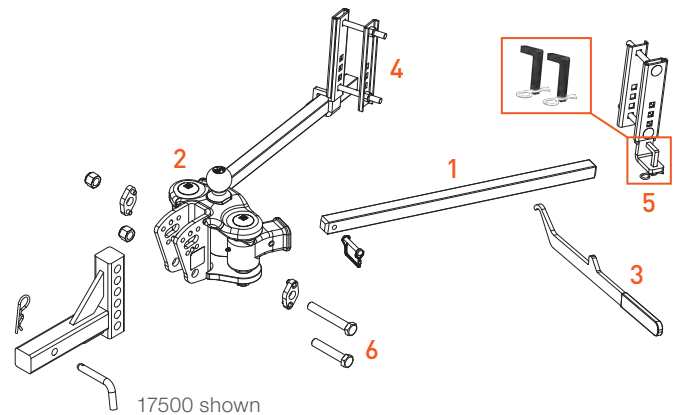

TRUNNION BAR KITS & WD HITCHES

- Up to 15,000 lbs. GTW / 1,500 lbs. TW
- Weight ratings are limited to vehicle manufacturer's stated capacities
- Heavy-duty, formed head with trunnion, forged steel spring bars
- Features built-in sway control attachment tabs
- 2" shank can be flipped to provide necessary drop or rise (see page 180 for shank options)
- Hookup brackets and lift handle allow for easy leveraging of spring bars
- Durable carbide black powder coat finish



Kit#	Hitch#	GTW	TW	Bar Length	Kit Includes
--	17300*	5,000 - 6,000 lbs.	500 - 600 lbs.	30-5/8"	--
--	17301*	6,000 - 8,000 lbs.	600 - 800 lbs.	30-5/8"	--
--	17302	8,000 - 10,000 lbs.	800 - 1,000 lbs.	30-5/8"	--
--	17330*	5,000 - 6,000 lbs.	500 - 600 lbs.	28-3/8"	--
--	17331*	6,000 - 8,000 lbs.	600 - 800 lbs.	28-3/8"	--
17322	17332	8,000 - 10,000 lbs.	800 - 1,000 lbs.	28-3/8"	Sway control (17200), pre-torqued 2-5/16" trailer ball (40006) and chains pre-assembled to spring bars
17422	17333	10,000 - 15,000 lbs.	1,000 - 1,500 lbs.	28-3/8"	Sway control (17200), pre-torqued 2-5/16" trailer ball (40006) and chains pre-assembled to spring bars

* Continued while supplies last

Replacement Parts

Fig#	Part#	Description	Fits
1	17309*	Spring bar with assembled chain	17300
1	17308*	Spring bar with assembled chain	17301
1	17303	Spring bar with assembled chain	17302
1	17334*	Spring bar with assembled chain	17330
1	17335*	Spring bar with assembled chain	17331
1	17336	Spring bar with assembled chain	17332
1	17337	Spring bar with assembled chain	17333
2	17307	Head	All
3	17008	Hookup bracket, qty 1	All
4	17112	Lift handle	All
5	17312	Head angle adjustment rod kit	All
6	17350	Hardware kit includes: - 3/4" x 5" hex bolts, qty 2 - 5/8" x 1-3/4" hex bolt, qty 1 - 1/2" x 2" hex bolts, qty 2 - 1/2" x 4" hex bolts, qty 2 - 3/4" conical washers, qty 4 - 1/2" flat washers, qty 2 - 3/4" nylock nuts, qty 2 - Adjustment rod, short, qty 1 - Adjustment rod, long, qty 1 - Bracket clips, qty 2 - Hitch pin & clip	All

* Continued while supplies last

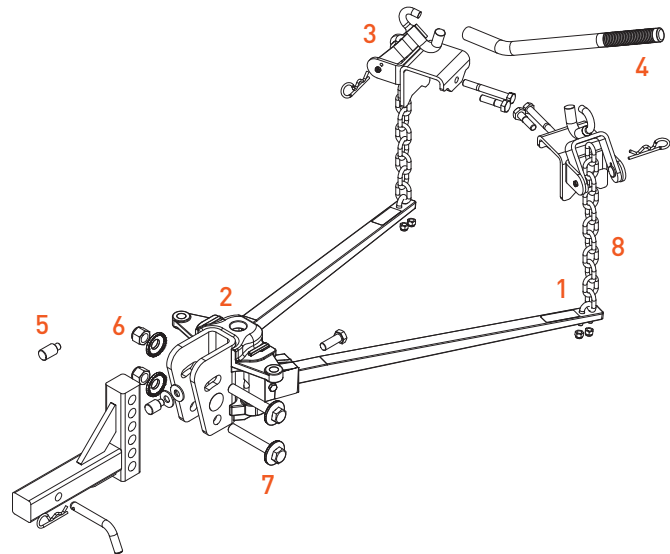

Fig#	Part#	Description	Fits
7	17314	Conical washers, qty 4	All
8	17111	Chain kit includes: - Chains, qty 2 - 3/8" U-bolts, qty 2 - 3/8" flat washers, qty 4 - 3/8" nylock nuts, qty 4	All

* Continued while supplies last

2
INCH

MV ROUND BAR WD HITCHES & KITS

For additional shank options see page 180

- Up to 14,000 lbs. GTW / 1,400 lbs. TW
- Weight ratings are limited to vehicle manufacturer's stated capacities
- Grease zerks fitting provides easy, continuous lubrication
- Heavy-duty, fabricated head with round, forged steel spring bars
- Features built-in sway control attachment tabs
- 2" shank can be flipped to provide necessary drop or rise
- Hookup brackets and lift handle allow for easy leveraging of spring bars
- Durable carbide black powder coat finish



Kit#	Hitch#	GTW	TW	Bar Length	Kit Includes
--	17050	5,000 - 6,000 lbs.	500 - 600 lbs.	31-3/16"	--
--	17051	6,000 - 8,000 lbs.	600 - 800 lbs.	31-3/16"	--
17062	17052	8,000 - 10,000 lbs.	800 - 1,000 lbs.	31-3/16"	Sway control (17200), pre-torqued 2-5/16" trailer ball (40006) and chains pre-assembled to spring bars
17063	17057	10,000 - 14,000 lbs.	1,000 - 1,400 lbs.	31-3/16"	Sway control (17200), pre-torqued 2-5/16" trailer ball (40006) and chains pre-assembled to spring bars

Replacement Parts

Fig#	Part#	Description	Fits
1	17071	Spring bar with assembled chain	17050
1	17072	Spring bar with assembled chain	17051
1	17073	Spring bar with assembled chain	17052, 17062
1	17074	Spring bar with assembled chain	17057, 17062
2	17075	Head	All
3	17208	Hookup brackets, qty 2 - 17112 required to lift brackets	All
4	17112	Lift handle	17208
5	17111	Chain kit includes: - Chains, qty 2 - 3/8" U-bolts, qty 2 - 3/8" flat washers, qty 4 - 3/8" nylock nuts, qty 4	
6	17076	Hardware kit includes: - 3/4" x 4-1/2" hex bolts, qty 2 - 3/4" conical washers, qty 2 - 1/2" flat washers, qty 7 - 3/4" nylock nuts, qty 2 - Adjustment rod, qty 1 - Hitch pin & clip	All

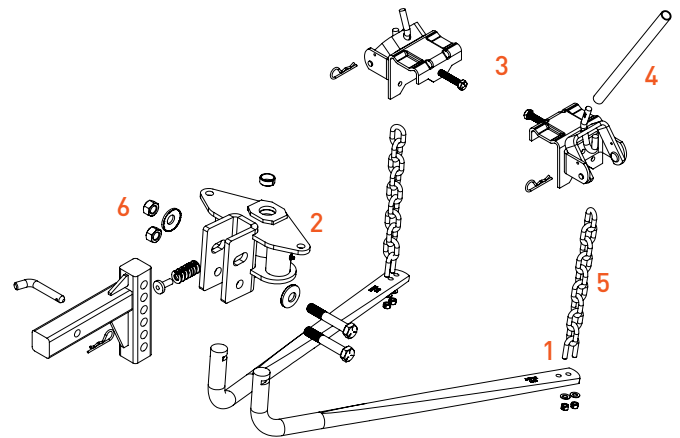

2 INCH & 2½ INCH WEIGHT DISTRIBUTION SHANKS

- Provides an adjustable mount for most weight distribution hitches
- Features multiple holes for adjustable head height
- Can be flipped to provide necessary drop or rise (select models)
- 3/4" holes are spaced 1-1/4" from center to center
- Constructed from solid steel for reliable strength
- Protected by a durable black powder coat finish
- Limited to spring bar capacity



Measuring a WD shank

See table for corresponding measurements

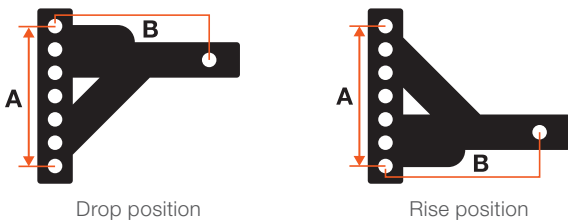

Measuring a WD shank with WD hitch head

See table for corresponding measurements

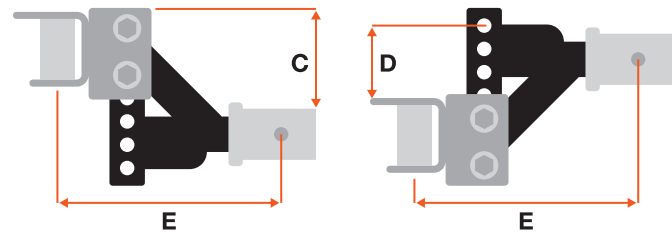

Part#	Measuring a WD Shank		Measuring a WD Shank with WD Hitch Head		
	Height (A)	Length (B)	Rise (C)	Drop (D)	Length (E)
For 2" x 2" Receiver Tube Openings					
17100	7-1/2"	8"	6"	2"	12"
17102	7-1/2"	12"	6"	2"	14"
17103	7-1/2"	14"	6"	2"	16"
17120	8-3/4"	10"	8-7/8"	5-5/8"	12"
17121	10"	12"	10-1/4"	6"	14"
17122	10"	14"	10-1/4"	6"	16"
17123	11-1/4"	7"	10-1/2"	7"	9"
17124	6-1/4"	9"	Not to be used in rise position	8-3/4"	11"
17125	6-1/4"	8"	Not to be used in rise position	14-1/2"	10"
For 2-1/2" x 2-1/2" Receiver Tube Openings					
17131	7-1/2"	8"	6"	2"	12"
17132	12-1/2"	8"	Not to be used in rise position	7-1/2"	12"

2 INCH SWAY TAB BALL MOUNT

- Fits any 2" x 2" receiver tube opening
- Provides a mounting tab for a sway control trailer ball (ball sold separately)
- Anti-rattle kit can be used to help stop vibration, see page 123



45820



45820 shown with 40093 ball (not included)



Coupled sway control (17200)

Part#	GTW / TW	Drop	Rise	Length	Ball Hole Size
45820	7,500 / 750 lbs.	2"	3/4"	7-1/2"	1"

SWAY CONTROL KIT

Sway control reduces lateral movement while pulling a trailer. The diagrams below illustrate the effectiveness of using sway control units. Two sway control kits should be used for maximum control and stability.

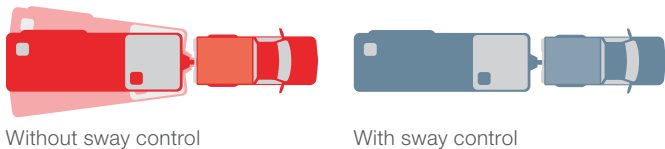

Pkg#	Includes
17200	Sway control unit
	Trailer attachment ball, plate and eight bolts
	Hitch-mounted attachment ball (40093)
	Weld-on tab (45822)
	Mount reinforcement plate
	Spring clips, qty 2

Replacement Parts

Part#	Description
17201	Trailer attachment ball with four self-tapping bolts and two spring clips
40093	Sway control attachment ball
45822	Weld-on sway tab

HOOKUP BRACKETS

- Allows for repositioning of spring bars around an LP tank or other obstruction
- Replaces factory spring bar brackets or hangers
- Durable carbide powder coat finish

Pkg#	Description
17003	Clamp-on chain hangers
17005	Bolt-on chain hangers



BETTERWEIGH™ MOBILE TOWING SCALE

- Streamlines WD setup and shows real-time vehicle-trailer weights
- No more complicated at-home measurements or trips to the scale
- Bluetooth connection provides active readouts on the driver's smartphone
- No-install, plug-and-play setup into vehicle diagnostic port (OBD-II) below the dash
- Accurate within + / - 5%
- Offers easy brake controller setup by measuring exact trailer brake gain needed
- See page 98 for more information



Scan to see it in action!

Download the app:
BetterWeigh Towing Scale



Pkg#	Description
51701	Mobile towing scale



5TH WHEEL HITCHES

TRUST THE TOWING EXPERTS

PowerRide™ 30K 5th wheel hitch on industry-exclusive 40K base rails



FEATURED PRODUCTS



PowerRide™ 5th wheel hitch

This new 30K 5th wheel hitch features a self-resetting handle, multi-directional head and strategic grip points for easier mobility.



S-Series™ sliders

These new 5th wheel sliders offer smooth rolling operation and quiet towing, providing extra turning clearance for short-bed trucks.



Puck system base rails

Equipped with industry-standard rails, this adapter easily drops into the puck system on the latest trucks from Chevrolet, Ford and GMC.

PRODUCT INDEX



186

How to Mount a 5th Wheel Hitch



188

PowerRide™ 5th Wheels



190

A-Series™ 5th Wheels



194

Q-Series™ 5th Wheels



198

E-Series™ 5th Wheels



202

Puck System Base Rails



202

Puck System Legs & Rollers



204

Sliders & Rollers



206

Brackets & Base Rails



209

X5™ Adapter Plates



210

5th Wheel Accessories



213

5th Wheel Electrical

5TH WHEEL HITCHES

CURT 5th wheel hitches are available in four distinct series. To determine the best configuration for the customer's vehicle, see 'Mounting a 5th wheel hitch' on page 186.



NEW

POWERRIDE™

- Rated for 30,000 lbs., page 188
- Tough, professional-grade, 30K capacity with enhanced ergonomics and functionality
- Multi-directional, cast yoke head for a smooth ride



A-SERIES™

- Options rated up to 30,000 lbs., page 190
- Cast yoke head with poly-torsion inserts for stable towing
- Self-resetting handle for fewer steps while coupling



Q-SERIES™

- Options rated up to 25,000 lbs., page 194
- Spherical axial bearing tilts head in any direction for a smooth, quiet ride
- Three easy-access grease fittings for lubrication



E-SERIES™

- Rated for 16,000 lbs., page 198
- Economic design for budget-conscious customers
- Dual-pivoting head with anti-rattle skid plate

Feature	PowerRide™	A-Series™	Q-Series™	E-Series™
Pivoting Mechanism	Cast yoke (two pivot points)	Cast yoke (two pivot points)	Spherical axial bearing	10° dual-pivoting head
Handle Operation	Single-throw, self-resetting handle	Single-throw, self-resetting handle	Short-throw, single handle	Single handle
Head Opening	Extra wide, self-aligning	Extra wide, self-aligning	Extra wide, self-aligning	Self-aligning
Jaw Type	Dual, interlocking	Dual, interlocking	Dual	Locking bar
Coupling Indicator	Yes	Yes	Yes	No
Head Removal	One-pin	One-pin	Two-pin	Two-pin
Sidewinder™ Compatible	Yes (wedge required)	Yes (wedge required)	No	Yes (wedge required)
GTW Options	30K	16K, 20K, 25K, 30K	20K, 24K, 25K	16K
Warranty	Limited lifetime	Limited lifetime	Limited lifetime	Limited lifetime

5TH WHEEL MOUNTING OPTIONS

OEM Puck System Products

Puck system legs and adapters use a simple quarter-turn anchor system to easily and securely drop into the truck bed pucks built into many pickups today.

- Options available for Ford, GM, Nissan and Ram
- Compatible with most CURT 5th wheel hitches
- **See page 202 for long- and short-bed options**

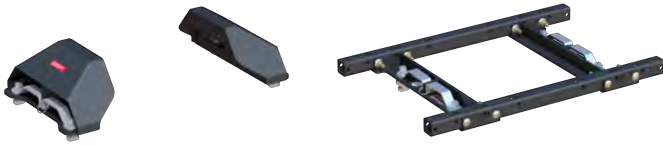

5th Wheel Sliders & Rollers

CURT sliders and rollers provide 12" of additional clearance between the truck cab and trailer, displacing the 5th wheel coupling point for making tight turns.

- Ideal for increasing clearance for short-bed trucks
- Available in 16K to 25K capacities
- **See page 204 for full features and benefits**



Custom Under-Bed Brackets

Each designed to fit a specific truck application, our custom brackets install in less time and provide a solid mount for our industry-standard base rails.

- Vehicle-specific fit reduces or eliminates drilling
- Protected by a rust-resistant liquid A-coat
- **See page 206 for application information**



Industry-Standard Base Rails

CURT industry-standard base rails accept any 5th wheel hitch with industry-standard mounting points. They are available in capacities of 25K and 40K.

- Durable powder coat finish in multiple color options
- Co-cured in a rust-resistant liquid A-coat
- **See page 206 for application information**



X5™ Adapter Plates

X5™ adapter plates allow a gooseneck hitch to become a 5th wheel mount. They drop into the gooseneck hole and provide a set of industry-standard base rails.

- Compatible with EZr™, Double Lock™ and select competitor models
- Compatible with CURT 5th wheels up to 20,000 lbs.
- **See page 209 for full features and benefits**



5th Wheel Accessories

We offer a number of accessories to help improve 5th wheel operation and safety while towing, including 5th wheel wedges, locks, noise dampeners and more.

- Lube plates and sound pads for smooth operation
- Safety chain loops and locks for improved safety
- **See pages 210 - 212 for 5th wheel accessories**



MOUNTING A 5TH WHEEL HITCH

There are several components that make up a 5th wheel hitch, and these components are determined by truck type and customer preferences. Answer the following questions to help choose the right hitch for your customer.

What size is the truck bed?

The length of the truck bed will determine which type of mounting platform the 5th wheel hitch requires: legs or a slider. **Note: A slider may be required for long-bed trucks. Review each configuration before purchase.**

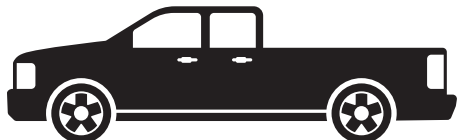

LONG-BED

5th wheel legs are the standard 5th wheel mounting method. A long-bed truck will provide the necessary room for this option.

For long-bed trucks, follow the orange path.



SHORT-BED

A 5th wheel slider is recommended on short-bed trucks. A slider adds clearance between the cab and the trailer when turning.

For short-bed trucks, follow the blue path.

Measuring for a 5th wheel slider

1. Trailer width \div by 2 = X
2. Distance from truck cab to coupling point = Y
3. Truck-trailer clearance: $Y - X = Z$

If Z is negative
you need a
5th wheel slider



Scan to
learn more

A | OEM PUCK SYSTEM OPTIONS

Many trucks today, specifically from Chevrolet, Ford, GMC, Nissan and Ram, come with a built-in mounting platform in the bed called a puck system. A puck system makes installing a CURT 5th wheel hitch very easy.

LONG-BED WITH OEM PUCK SYSTEM

If the long bed has a puck system, select a 5th wheel hitch with OEM puck system legs or rails.

See our complete kits starting on page 189.

SHORT-BED WITH OEM PUCK SYSTEM

If the short bed has a puck system, select an OEM puck system roller or rail option to mount the 5th wheel.

See our complete kits starting on page 192.



Ram OEM puck system

B | PERMANENT RAIL SYSTEMS

If your customer prefers fixed rails in the truck bed, select a vehicle-specific, under-bed bracket kit and corresponding base rails to mount the 5th wheel hitch.

LONG-BED

1. See page 207 for available bracket applications.
2. See page 206 for corresponding base rails.
3. Select a 5th wheel hitch from the 'Long-Bed Options' starting on page 189.

3. 5th wheel with legs



2. Above-bed base rails



1. Custom under-bed brackets



SHORT-BED

1. See page 206 for available bracket applications.
2. See page 206 for corresponding base rails.
3. Select a 5th wheel hitch from the 'Short-Bed Options' starting on page 192.

3. 5th wheel with roller



2. Above-bed base rails



1. Custom under-bed brackets



C | REMOVABLE RAIL SYSTEMS

If your customer prefers the option of easily removing the base rails for an unobstructed truck bed, select a gooseneck hitch kit and an X5™ adapter plate to mount the 5th wheel hitch.

LONG-BED

1. See page 226 for available gooseneck hitches.
2. See page 209 for a corresponding X5™ adapter.
3. Select a 5th wheel hitch from the 'Long-Bed Options' starting on page 189.

3. 5th wheel with legs



2. Above-bed X5™ adapter



1. Under-bed gooseneck hitch kit



SHORT-BED

1. See page 226 for available gooseneck hitches.
2. See page 209 for a corresponding X5™ adapter.
3. Select a 5th wheel hitch from the 'Short-Bed Options' starting on page 192.

3. 5th wheel with roller



2. Above-bed X5™ adapter



1. Under-bed gooseneck hitch kit



POWERRIDE™ HITCHES

NEW

30K
GTW

30K
HITCH

Product Details

- Tough, professional-grade capacity and enhanced functionality
- Constructed with a cast steel main body for dependable strength
- Tested and rated to 30,000 lbs. GTW / 7,500 lbs. vertical load per SAE J2638
- Patented interlocking jaws for full kingpin contact and coupling security
- Premium, textured, dark grey teridium finish for lasting rust resistance
- Compatible with kingpin extension boxes, including common pivoting pin boxes (wedge required)
- 6" height adjustment for greater versatility versus 3" options
- No welding or fabrication required for installation
- Replacement wear indicator plates available (#19269)
- Patent# 8,827,298



16320 - head with legs

Operational Features



Ergonomic, self-resetting handle for easier use from the side of the truck bed



Multi-directional, cast yoke head for a smooth ride and less strain on the truck



Three-position coupling indicator clearly shows coupling status

Design Features



Strategic grip points for ergonomic moving and handling



Integrated polyethylene plates for smooth operation, reduced wear and no grease



Fast, one-pin head removal makes moving easy with smaller, lighter pieces

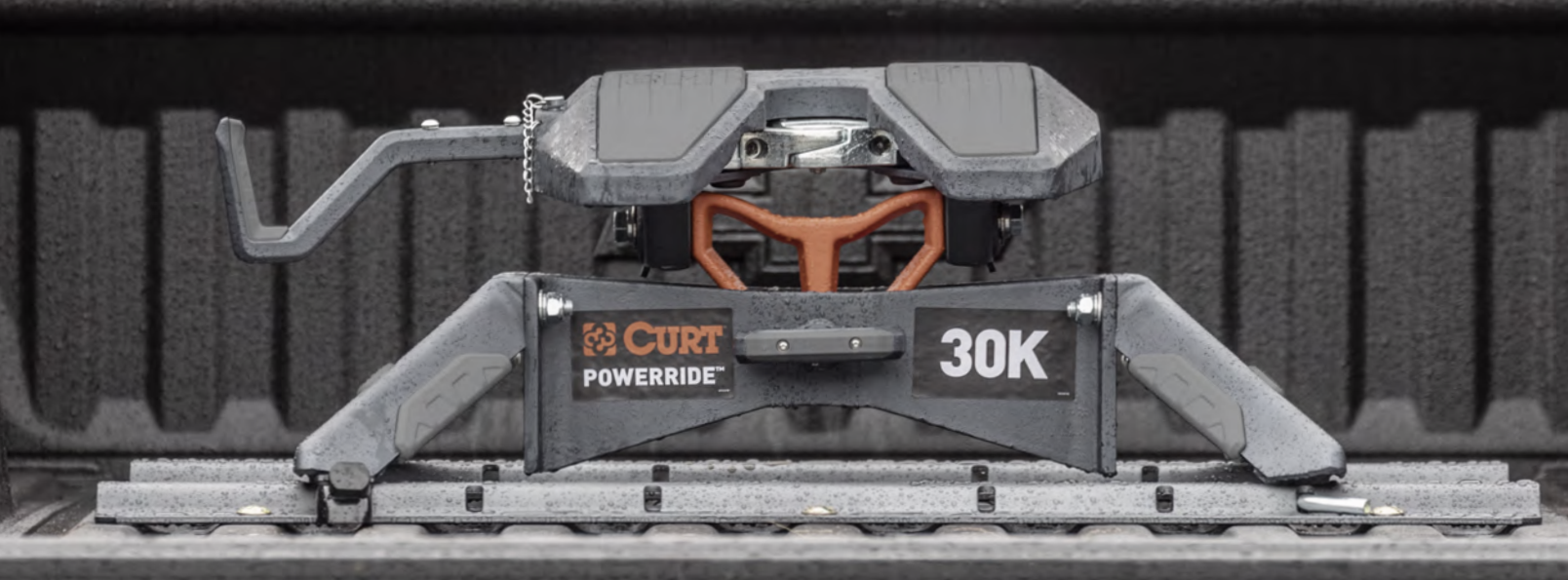

POWER MEETS PERFORMANCE

POWERRIDE™ 5TH WHEEL HITCH OPTIONS

NEW



16321 - head with legs and new 40K base rails



16080 - head with 2020 Chev / GMC puck legs



16315 - head only

Industry-Standard Rail Options

Part#	Description	GTW / Vertical Load	Height Range
Long-Bed Options			
16320 N	Head with standard legs	30,000 / 7,000 lbs.	13" - 17"
16321 N	Head with standard legs (16320) and 40K base rails (16205)	30,000 / 7,000 lbs.	14" - 18"
Replacement Parts			
16315 N	Head only	30,000 / 7,000 lbs.	--

For a guide in selecting the right 5th wheel for your customer's truck, see page 185

OEM Puck System Options

Make / Model	Style	Years	GTW / Vertical Load	Kit#	Head Only#	OEM Puck Leg#	Height Range
Chevrolet / GMC							
Silverado Sierra 2500 HD / 3500 HD	8' bed	20 - 20	30,000 / 7,000 lbs.	16080 N	16315	16030 N	13" - 17"
Ram							
2500 / 3500	8' bed	13 - 20	30,000 / 7,000 lbs.	16040 N	16315	16028 N	14" - 18"

All vehicles must come with a 5th wheel prep package to accept CURT puck system products

A-SERIES™ HITCHES

16K

GTW

A16™
HITCH

20K

GTW

A20™
HITCH

25K

GTW

A25™
HITCH

30K

GTW

A30™
HITCH

Product Details

- Extra wide head opening for easier coupling
- Cast yoke and poly-torsion inserts suppress shock loads and reduce noise
- Constructed with a cast steel main body for a more precise build (A25 and A30 only)
- Offers three height adjustment positions to adapt to each unique truck bed
- Compatible with kingpin extension boxes, including common pivoting pin boxes (wedge #16992 required)
- Includes a polyethylene lube plate to eliminate messy grease deposits
- Protected by a highly durable carbide black powder coat finish
- Tested for safety in accordance with SAE J2638
- Patent# 8,827,298



Operational Features



Lockable handle self-resets to the ready-to-couple position after the hitch is uncoupled



Fully articulating torsion head for controlled coupling and stable towing



Three-position coupling indicator clearly shows coupling status

Design Features



High-strength, interlocking jaws fully wrap the kingpin to minimize noise



Alignment pegs and accessible mounting bolts for simple leg-to-body attachment (excl A16)



Fast, one-pin head removal makes moving easy with smaller, lighter pieces

A-SERIES™ INDUSTRY-STANDARD BASE RAIL OPTIONS

See page 192 for puck system mounting options



16120 - A16 head with standard legs



16181 - A25 head with standard legs and base rails



16541 - A20 head with R20 roller



16631 - A16 head with S16 slider and base rails

Kit#	Head Series	GTW / Vertical Load	Kit Includes					Height Range
			Hitch with Standard Legs#	Head Only#	Slider Only#	Roller Only#	Base Rails#	
Long-Bed Options								
16120	A16™	16,000 / 4,000 lbs.	16120	--	--	--	--	13" - 17"
16121	A16™	16,000 / 4,000 lbs.	16120	--	--	--	16200	14" - 18"
16140	A20™	20,000 / 5,000 lbs.	16140	--	--	--	--	13" - 17"
16141	A20™	20,000 / 5,000 lbs.	16140	--	--	--	16200	14" - 18"
16180	A25™	25,000 / 6,250 lbs.	16180	--	--	--	--	13" - 17"
16181	A25™	25,000 / 6,250 lbs.	16180	--	--	--	16200	14" - 18"
16190	A30™	30,000 / 7,000 lbs.	16190	--	--	--	--	13" - 17"
16191	A30™	30,000 / 7,000 lbs.	16190	--	--	--	16205 N	14" - 18"
Short-Bed Options								
16531 N	A16™	16,000 / 4,000 lbs.	--	16520	16564 N	--	--	19" - 23"
16631 N	A16™	16,000 / 4,000 lbs.	--	16520	16564 N	--	16200	20" - 24"
16521	A16™	16,000 / 4,000 lbs.	--	16520	--	16560	--	17-1/2" - 21-1/2"
16621	A16™	16,000 / 4,000 lbs.	--	16520	--	16560	16200	18-1/2" - 22-1/2"
16541	A20™	20,000 / 5,000 lbs.	--	16540	--	16550	--	17-1/2" - 21-1/2"
16641	A20™	20,000 / 5,000 lbs.	--	16540	--	16550	16200	18-1/2" - 22-1/2"
16551 N	A25™	25,000 / 6,250 lbs.	--	16580	16574 N	--	--	18-1/2" - 22-1/2"
16651 N	A25™	25,000 / 6,250 lbs.	--	16580	16574 N	--	16200	19-1/2" - 23-1/2"

For a guide in selecting the mounting system for your customer's truck, see page 185

A-SERIES™ PUCK SYSTEM OPTIONS

To learn more about puck system options see page 202



16070 - 2020 Chev / GMC legs with A30 head



16034 - Ford legs with A20 head



16073 - Nissan legs with A16 head



NEW

16698 - Chev / GMC roller adapter with A16 head & S16 slider



16676 - Ford roller with A20 head



16685 - Ram roller adapter with A16 head and R16 roller

All puck system products require a vehicle with a 5th wheel prep package for installation

Make / Model	Style	Years	GTW / Vertical Load	Kit#	5th Wheel Heads		OEM Puck Products		Standard Slider / Roller Only#	Height Range
					Head Only#	Series	Part#	Description		
Chevrolet / GMC										
Silverado Sierra 2500 HD 3500 HD	6.75' bed	16-19	16,000 / 4,000 lbs.	16668	16520	A16™	16023	Roller adapter	16560 (R16)	19"-23"
			16,000 / 4,000 lbs.	16698 N	16520	A16™	16023	Roller adapter	16564 (S16)	21" - 25"
			20,000 / 5,000 lbs.	16669	16540	A20™	16023	Roller adapter	16550 (R20)	19"-23"
	8' bed	20-20	16,000 / 4,000 lbs.	16091	16520	A16™	16029	Legs	--	13"-17"
			20,000 / 5,000 lbs.	16092	16540	A20™	16029	Legs	--	13"-17"
			25,000 / 6,250 lbs.	16093	16580	A25™	16029	Legs	--	13"-17"
			30,000 / 7,000 lbs.	16070	16590	A30™	16024	Legs	--	13"-17"
	16-19	16,000 / 4,000 lbs.	16063	16520	A16™	16025	Legs	--	13"-17"	
		20,000 / 5,000 lbs.	16064	16540	A20™	16025	Legs	--	13"-17"	
25,000 / 6,250 lbs.		16066	16580	A25™	16025	Legs	--	13"-17"		
Ford										
F-250 F-350 Super Duty	6.75' bed	11-20	16,000 / 4,000 lbs.	16675	16520	A16™	16020	Roller system	--	17-1/2"-21-1/2"
			20,000 / 5,000 lbs.	16676	16540	A20™	16020	Roller system	--	17-1/2"-21-1/2"
	8' bed	11-20	16,000 / 4,000 lbs.	16033	16520	A16™	16017	Legs	--	13"-17"
			20,000 / 5,000 lbs.	16034	16540	A20™	16017	Legs	--	13"-17"
			25,000 / 6,250 lbs.	16036	16580	A25™	16017	Legs	--	13"-17"
Nissan										
Titan XD	8' bed	16-20	16,000 / 4,000 lbs.	16073	16520	A16™	16026	Legs	--	13"-17"
			20,000 / 5,000 lbs.	16074	16540	A20™	16026	Legs	--	13"-17"
Ram										
2500 3500	6.75' bed	13-20	16,000 / 4,000 lbs.	16685	16520	A16™	16022	Roller adapter	16560 (R16)	19"-23"
			16,000 / 4,000 lbs.	16695 N	16520	A16™	16022	Roller adapter	16564 (S16)	21" - 25"
			20,000 / 5,000 lbs.	16686	16540	A20™	16022	Roller adapter	16550 (R20)	19"-23"
	8' bed	13-20	16,000 / 4,000 lbs.	16043	16520	A16™	16021	Legs	--	14"-18"
			20,000 / 5,000 lbs.	16044	16540	A20™	16021	Legs	--	14"-18"
			25,000 / 6,250 lbs.	16046	16580	A25™	16021	Legs	--	14"-18"

LOCKABLE, SELF-RESETTING HANDLE

A-SERIES™ 5TH WHEEL REPLACEMENT PARTS

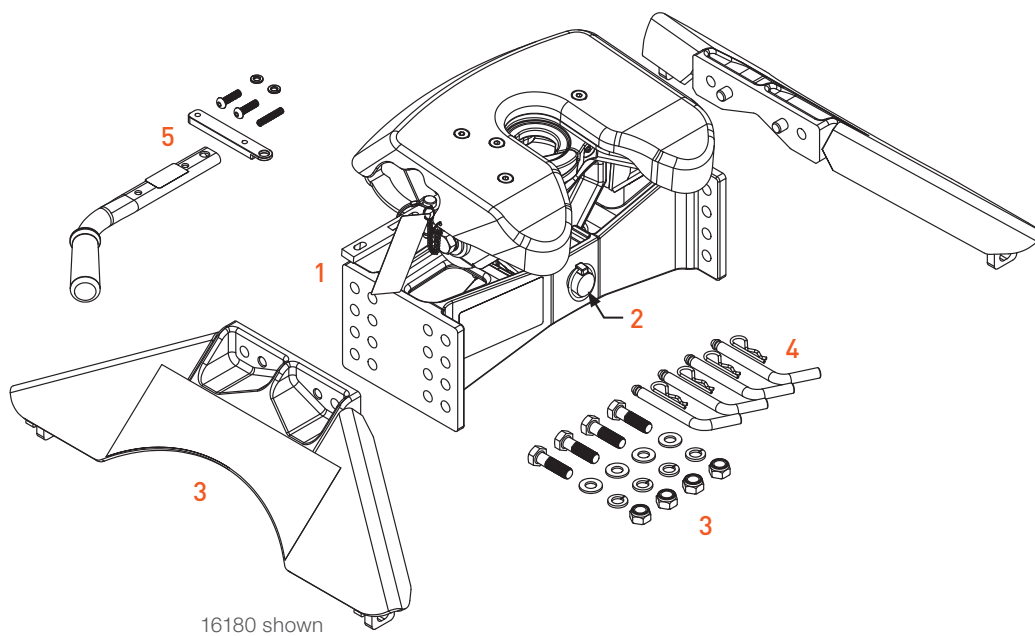

Fig#	Part#	Description	Fits
1	16520	A16 head only	16120
1	16540	A20 head only	16140
1	16580	A25 head only	16180
1	16590	A30 head only	16190
2	19211	A16 yoke support pin	16120
2	19213	A20 yoke support pin	16140
2	19214	A25 & A30 yoke support pin	16180, 16190
3	16920	A16 leg kit and hardware	16120
3	16906	A20 leg kit and hardware	16140

Fig#	Part#	Description	Fits
3	16907	A25 & A30 leg kit and hardware	16180, 16190
4	16902	Rail pins & clips, qty 4	All
5	19212	Handle assembly: - Release handle, qty 1 - Handle grip, qty 1 - Handle lock bar, qty 1 - M8 bolt head cap screw, qty 2 - Latch spring, qty 1 - M8 lock washer, qty 2	All

Q-SERIES™ HITCHES

20K

GTW

Q20™
HITCH

24K

GTW

Q24™
HITCH

25K

GTW

Q25™
HITCH

Product Details

- Three easy-access grease fittings for lubrication
- Offers three height adjustment positions to adapt to each unique truck bed
- Includes a polyethylene lube plate to eliminate messy grease deposits
- Not compatible with rotating pin boxes, such as Sidewinder™ (Trademark of Horizon Global™)
- Protected by a highly durable carbide black powder coat finish
- Tested for safety in accordance with SAE J2638



16265

Product Features



Spherical axial bearing tilts head in any direction for a smooth, quiet ride



Dual jaws fully wrap the kingpin to reduce chucking noises and increase towing security



Wide, self-aligning head provides easier coupling when backing up to the trailer



Lockable, short-throw handle automatically engages with the kingpin to simplify operation



Three-position coupling indicator clearly shows coupling status

Q-SERIES™ INDUSTRY-STANDARD BASE RAIL OPTIONS

See page 196 for puck system mounting options



16130 - Q20 head with standard legs



16266 - Q25 head with standard legs and base rails



16536 - Q20 head with R20 roller



16646 - Q24 head with R24 slider and base rails

Kit#	Head Series	GTW / Vertical Load	Kit Includes				Height Range
			Hitch with Standard Legs#	Head Only#	Roller Only#	Base Rails#	
Long-Bed Options							
16130	Q20™	20,000 / 5,000 lbs.	16130	--	--	--	13" - 17"
16131	Q20™	20,000 / 5,000 lbs.	16130	--	--	16200	14" - 18"
16245	Q24™	24,000 / 6,000 lbs.	16245	--	--	--	13" - 17"
16246	Q24™	24,000 / 6,000 lbs.	16245	--	--	16200	14" - 18"
16265	Q25™	25,000 / 6,250 lbs.	16265	--	--	--	13" - 17"
16266	Q25™	25,000 / 6,250 lbs.	16265	--	--	16200	14" - 18"
Short-Bed Options							
16536	Q20™	20,000 / 5,000 lbs.	--	16530	16550	--	17-1/2" - 21-1/2"
16636	Q20™	20,000 / 5,000 lbs.	--	16530	16550	16200	18-1/2" - 22-1/2"
16546	Q24™	24,000 / 6,000 lbs.	--	16545	16570	--	17-1/2" - 21-1/2"
16646	Q24™	24,000 / 6,000 lbs.	--	16545	16570	16200	18-1/2" - 22-1/2"
16565	Q25™	25,000 / 6,250 lbs.	--	16565	16570	--	17-1/2" - 21-1/2"
16566	Q25™	25,000 / 6,250 lbs.	--	16565	16570	16200	18-1/2" - 22-1/2"

For a guide in selecting the mounting system for your customer's truck, see page 185

Q-SERIES™ PUCK SYSTEM OPTIONS

To learn more about puck system options see page 202



16069 - 2019 Chev / GMC legs with Q25 head



16037 - Ford legs with Q24 head



16075 - Nissan legs with Q20 head



16671 - Chev / GMC roller adapter with Q20 head & R20 roller



16677 - Ford roller with Q20 head



16688 - Ram roller adapter with Q24 head and R24 roller

All puck system products require a vehicle with a 5th wheel prep package for installation

Make / Model	Style	Years	GTW / Vertical Load	Kit#	5th Wheel Heads		OEM Puck Products		Standard Roller Only#	Height
					Head Only#	Series	Part#	Description		
Chevrolet / GMC										
Silverado Sierra 2500 HD 3500 HD	6.75' bed	16-19	20,000 / 5,000 lbs.	16671	16530	Q20™	16023	Roller adapter	16550 (R20)	19"-23"
	8' bed	20-20	20,000 / 5,000 lbs.	16094	16530	Q20™	16029	Legs	--	13"-17"
			24,000 / 6,000 lbs.	16095	16545	Q24™	16029	Legs	--	13"-17"
			25,000 / 6,250 lbs.	16096	16565	Q25™	16029	Legs	--	13"-17"
	16-19	20,000 / 5,000 lbs.	16065	16530	Q20™	16025	Legs	--	13"-17"	
		24,000 / 6,000 lbs.	16067	16545	Q24™	16025	Legs	--	13"-17"	
25,000 / 6,250 lbs.	16069	16565	Q25™	16025	Legs	--	13"-17"			
Ford										
F-250 F-350 Super Duty	6.75' bed	11-20	20,000 / 5,000 lbs.	16677	16530	Q20™	16020	Roller system	--	17-1/2"-21-1/2"
			24,000 / 6,000 lbs.	16678	16545	Q24™	16020	Roller system	--	17-1/2"-21-1/2"
	8' bed	11-20	20,000 / 5,000 lbs.	16035	16530	Q20™	16017	Legs	--	13"-17"
			24,000 / 6,000 lbs.	16037	16545	Q24™	16017	Legs	--	13"-17"
			24,000 / 6,000 lbs.	16039	16565	Q25™	16017	Legs	--	13"-17"
Nissan										
Titan XD	8' bed	16-20	20,000 / 5,000 lbs.	16075	16530	Q20™	16026	Legs	--	13"-17"
Ram										
2500 3500	6.75' bed	13-20	20,000 / 5,000 lbs.	16687	16530	Q20™	16022	Roller adapter	16550 (R20)	19"-23"
			24,000 / 6,000 lbs.	16688	16545	Q24™	16022	Roller adapter	16570 (R24)	19"-23"
	8' bed	13-20	20,000 / 5,000 lbs.	16045	16530	Q20™	16021	Legs	--	14"-18"
			24,000 / 6,000 lbs.	16047	16545	Q24™	16021	Legs	--	14"-18"
			25,000 / 6,250 lbs.	16049	16565	Q25™	16021	Legs	--	14"-18"

Q-SERIES™ 5TH WHEEL REPLACEMENT PARTS

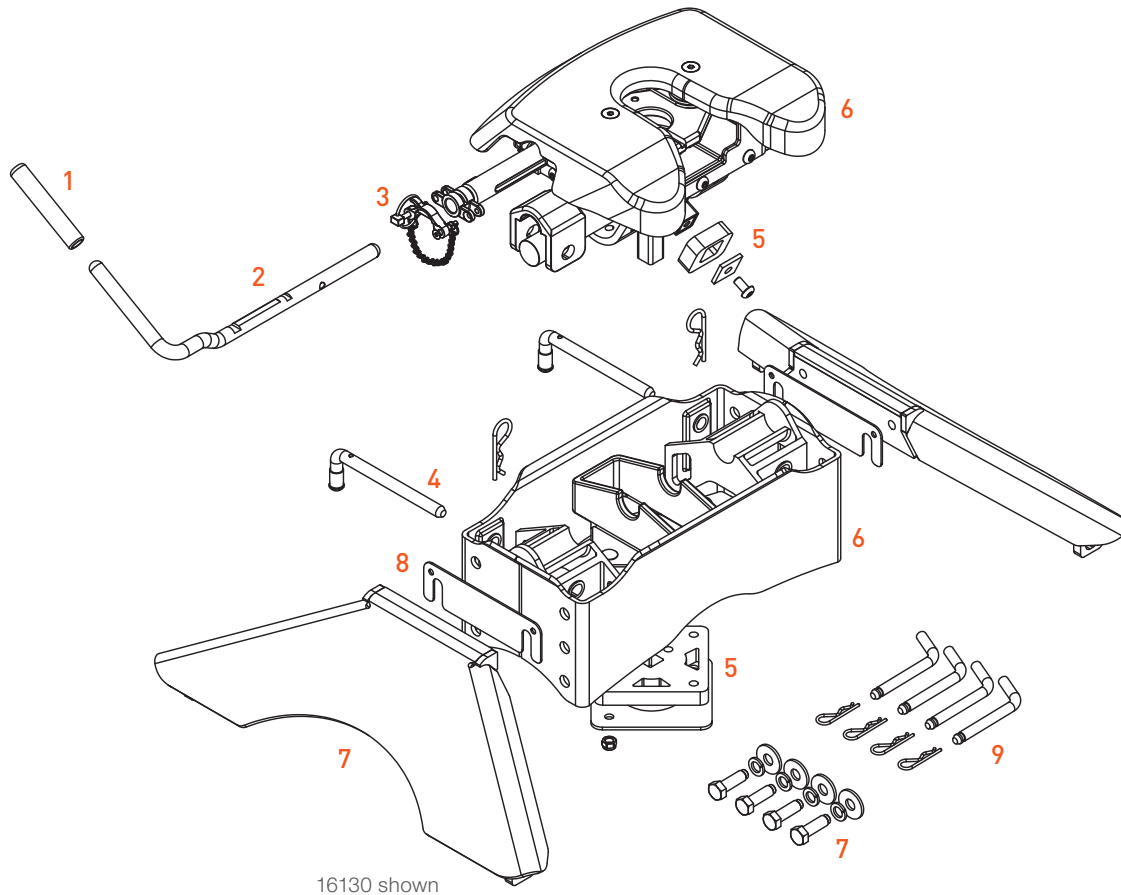

16130 shown

Fig#	Part#	Description	Fits
--	19223	Grease zerk, qty 3 (not pictured)	All
1	16215	Handle grip	All
2	16216	Handle with indicators	All
3	19224	Handle lock assembly: - 140mm chain, qty 1 - Lynch pin, qty 1 - Handle flip lock, qty 1 - M6 screw, qty 2 - M6 nylock nut, qty 1 - 16mm key ring, qty 2	All
4	19221	Head pinning kit: - Retainer cap pin, qty 2 - Pin grip, qty 2 - Pin clip, qty 2 - Grommet, thick, qty 4 - Grommet, thin, qty 2	All

Fig#	Part#	Description	Fits
5	19222	16125 service kit 9 & 10: - Anti-orbit pad, qty 1 - Molded anti-orbit pad, qty 2 - M10 carriage bolt, qty 2 - M10 nylock nut, qty 2 - M10 button head bolt, qty 2 - Square retaining washer, qty 2	All
6	16530	Q20 head only	16130
7	16904	Q20 leg kit and hardware	16130
8	19225	Q20 leg spacer plates, qty 4	16130
6	16545	Q24 head only	16245
7	16913	Q24 leg kit and hardware	16245
6	16565	Q25 head only	16265
7	16963	Q25 leg kit and hardware	16265
9	16902	Rail pins & clips, qty 4	All

E-SERIES™ HITCHES

16k
GTW

E16™ HITCH

Product Details

- Pivots on dual axes for 10° of lateral movement
- Automatically locks for easy, secure coupling
- Operates using a single handle
- Features an anti-rattle skid plate to help reduce noise
- Offers four height adjustment positions to adapt to each unique truck bed
- Compatible with kingpin extension boxes, including common pivoting pin boxes (wedge #16991 required)
- Protected by a highly durable carbide black powder coat finish
- Tested for safety in accordance with SAE J2638



16115

Product Features



Pivots on dual axes for 10° of lateral movement



Features an anti-rattle skid plate to help reduce noise



Single-handle operation with auto-lock for easy, secure coupling

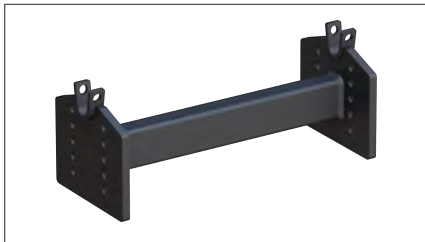

16505 head adapter allows CURT rollers to accept the 16515 E16 head (included in 16515, 16516 and 16616 kits)





BUDGET-FRIENDLY, SMOOTH TOWING

E-SERIES™ INDUSTRY-STANDARD BASE RAIL OPTIONS

See page 200 for puck system mounting options



16115 - E16 head with standard legs



16116 - E16 head with standard legs and base rails



16516 - E16 head with R16 roller



16611 - E16 head with S16 slider and base rails

Kit#	Head Series	GTW / Vertical Load	Kit Includes					Height Range
			Hitch with Standard Legs#	Head with Adapter Plate#	Slider Only#	Roller Only#	Base Rails#	
Long-Bed Options								
16115	E16™	16,000 / 4,000 lbs.	16115	--	--	--	--	13" - 17"
16116	E16™	16,000 / 4,000 lbs.	16115	--	--	--	16200	14" - 18"
Short-Bed Options								
16511	N E16™	16,000 / 4,000 lbs.	--	16515	16564 N	--	--	16-1/2" - 18-1/2"
16611	N E16™	16,000 / 4,000 lbs.	--	16515	16564 N	--	16200	
16516	E16™	16,000 / 4,000 lbs.	--	16515	--	16560	--	14" - 17"
16616	E16™	16,000 / 4,000 lbs.	--	16515	--	16560	16200	15" - 18"

For a guide in selecting the mounting system for your customer's truck, see page 185

E-SERIES™ PUCK SYSTEM OPTIONS

To learn more about puck systems see page 202



16061 - 2019 Chev / GMC legs with E16 head



16031 - Ford legs with E16 head



16071 - Nissan legs with E16 head



NEW

16697 - Chev / GMC roller adapter with E16 head & S16 slider



16674 - Ford roller with E16 head



16684 - Ram roller adapter with E16 head and R16 roller

All puck system products require a vehicle with a 5th wheel prep package for installation

Make / Model	Style	Years	GTW / Vertical Load	Kit#	5th Wheel Heads		OEM Puck Products		Standard Slider / Roller Only#	Height Range
					Head Only#	Series	Part#	Description		
Chevrolet / GMC										
Silverado Sierra 2500 HD 3500 HD	6.75' bed	16-19	16,000 / 4,000 lbs.	16667	16515	E16™	16023	Roller adapter	16560 (R16)	16"-19"
			16,000 / 4,000 lbs.	16697 N	16515	E16™	16023	Roller adapter	16564 (S16)	19"-21"
	8' bed	20-20	16,000 / 4,000 lbs.	16097	16515	E16™	16029	Legs	--	11-1/2"-13-1/2"
		16-19	16,000 / 4,000 lbs.	16061	16515	E16™	16025	Legs	--	11-1/2"-13-1/2"
Ford										
F-250 F-350 Super Duty	6.75' bed	11-20	16,000 / 4,000 lbs.	16674	16515	E16™	16020	Roller system	--	14"-18"
		8' bed	11-20	16,000 / 4,000 lbs.	16031	16515	E16™	16017	Legs	--
Nissan										
Titan XD	8' bed	16-20	16,000 / 4,000 lbs.	16071	16515	E16™	16026	Legs	--	11-1/2"-13-1/2"
Ram										
2500 3500	6.75' bed	13-20	16,000 / 4,000 lbs.	16684	16515	E16™	16022	Roller adapter	16560 (R16)	16"-19"
			16,000 / 4,000 lbs.	16694 N	16515	E16™	16022	Roller adapter	16564 (S16)	19"-21"
	8' bed	13-20	16,000 / 4,000 lbs.	16041	16515	E16™	16021	Legs	--	12-1/2"-15-1/2"



AUTO-LOCKING, SINGLE-HANDLE OPERATION

E-SERIES™ 5TH WHEEL REPLACEMENT PARTS

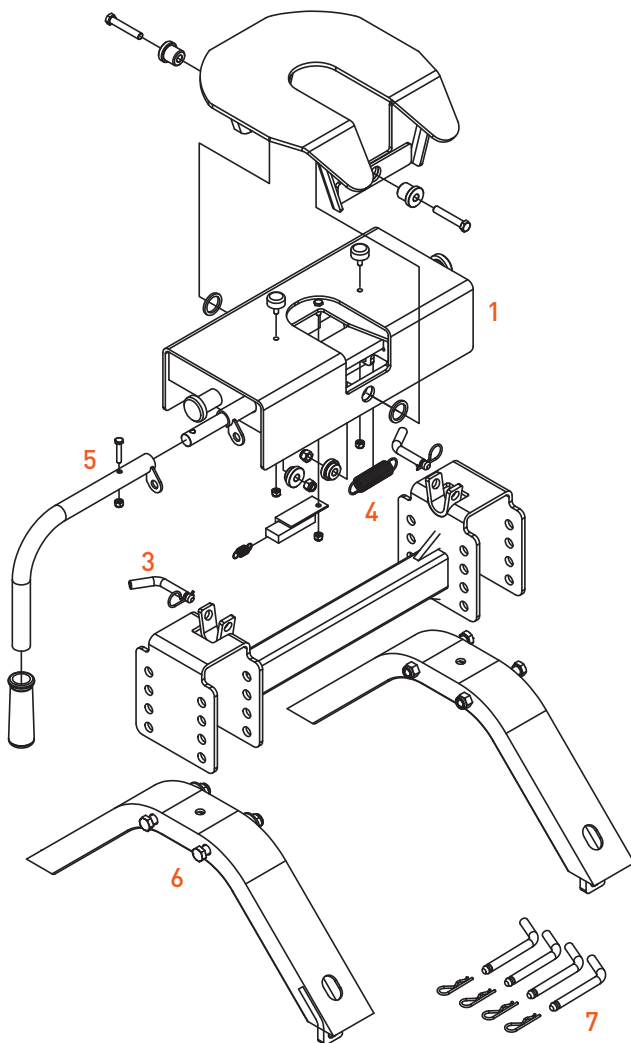

Fig#	Part#	Description	Fits
1	16515	E16 head with 16505 adapter	16115
2	16505	Head adapter	16115
3	19226	Head pinning kit: - Pin, qty 2 - Clip, qty 2	16115
4	19227	Head spring kit - Slide lock spring, qty 1 - Slide spring, qty 1	16115
5	19228	Handle assembly: - Handle, qty 1 - Handle grip, qty 1 - M6 hex head cap screw, qty 1 - M6 nylock nut, qty 1	16115
6	16903	E16 leg kit and hardware	16115
7	16902	Rail pins & clips, qty 4	16115

PUCK SYSTEM MOUNTING

STREAMLINED 5TH WHEEL INSTALLATION

- Allows CURT 5th wheel hitches to fit an OEM puck system
- Quarter-turn anchors allow for quick installation and removal
- Anchors can be adjusted to eliminate chocking between the legs or slider and the puck system
- Tested for safety in accordance with SAE J2638
- Highly durable carbide black or teridium grey powder coat finish
- Capacity limited to lowest-rated towing component

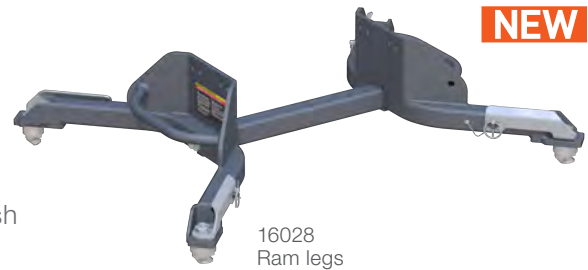

How to install OEM puck system products



Step 1 - Drop OEM-compatible product into the truck bed puck system



Step 2 - Close the anchor levers to lock the 5th wheel into place



Step 3 - Secure levers with attached safety pins and you're ready to hitch up your trailer

OEM PUCK SYSTEM BASE RAIL ADAPTER

- Convert the truck's puck system to industry-standard 5th wheel base rails
- No hitch leg reconfiguring or disassembly required



Easily transfer existing hitch from previous truck to new puck-equipped truck



Industry-standard rails accept most 5th wheel legs and rollers



16027 base rail adapter shown with A20 head and S16 slider (not included)

Make / Model	Style	Years	GTW	Part#
Chevrolet / GMC				
Silverado / Sierra 2500 HD / 3500 HD	With 5th wheel prep package	20 - 20	25,000 lbs.	16027
Ford				
F-250 / F-350 Super Duty	With 5th wheel prep package	11 - 20	25,000 lbs.	16027

OEM PUCK SYSTEM 5TH WHEEL HITCH LEGS & ROLLER PRODUCTS

NEW



16030 Chev / GMC legs



16020 Ford roller system



16023 Chev / GMC roller adapter

All puck system products require a vehicle with a 5th wheel prep package for installation

Make / Model	Style	Years	GTW	OEM Puck Products		
				Part#	Description	Finish
Chevrolet / GMC						
Silverado / Sierra 2500 HD / 3500 HD	6.75' bed with 5th wheel prep pkg	16 - 19	20,000 lbs.	16023	Roller adapter	Carbide black
	8' bed with 5th wheel prep pkg	20 - 20	30,000 lbs.	16024	Legs	Carbide black
			30,000 lbs.	16030 N	Legs	Teridium grey
			25,000 lbs.	16029	Legs	Carbide black
			25,000 lbs.	16025	Legs	Carbide black
Ford						
F-250 / F-350 Super Duty	6.75' bed with 5th wheel prep pkg	11 - 20	24,000 lbs.	16020	Roller system (built-in roller)	Carbide black
	8' bed with 5th wheel prep pkg	11 - 20	24,000 lbs.	16017	Legs	Carbide black
Nissan						
Titan XD	8' bed with 5th wheel prep pkg	16 - 20	20,000 lbs.	16026	Legs	Carbide black
Ram						
2500 / 3500	6.75' bed with 5th wheel prep pkg	13 - 20	24,000 lbs.	16022	Roller adapter	Carbide black
	8' bed with 5th wheel prep pkg	13 - 20	25,000 lbs.	16021	Legs	Carbide black
			30,000 lbs.	16028 N	Legs	Teridium grey

Replacement Parts

Part#	Description	Fits
19201	Handles, qty 4	16017, 16020
19202	Puck kit: - Locking T-bolts, qty 4 - Pucks, qty 4 - Castle nuts, qty 4 - Cotter pins, qty 4 - Washers, qty 4	16017, 16020
19203	Puck kit: - Locking T-bolts, qty 2 (large) - Pucks, qty 2 - Castle nuts, qty 2 - Cotter pins, qty 4	16021, 16022
19204	Puck kit: - Locking T-bolts, qty 2 (small) - Pucks, qty 2 - Castle nuts, qty 2 - Cotter pins, qty 4	16021, 16022

Part#	Description	Fits
19205	Handles, qty 4	16021
19206	Handles, qty 4	16022
19207	Handles, qty 4	16023
19208	Puck kit: - Locking T-bolts, qty 4 - Pucks, qty 4 - Castle nuts, qty 4 - Cotter pins, qty 4 - Washers, qty 4	16023
19209	Handles, qty 4	16025
19210	Puck kit: - Locking T-bolts, qty 4 - Pucks, qty 4 - Castle nuts, qty 4 - Cotter pins, qty 4 - Washers, qty 4	16025



QUIET, SOLID DESIGN ELIMINATES CHUCKING

S-SERIES™ SLIDERS

NEW

16K
GTW **S16™**
SLIDER

25K
GTW **S25™**
SLIDER

Product Details

- Eliminates chucking in the towing position
- Smooth sliding between positions with no binding
- Easy-to-reach lever arm for ergonomic operation
- Tested for safety in accordance with SAE J2638
- Mount to all industry-standard base rails
- Unit comes fully assembled for easy installation
- Compatible with CURT puck system adapters for Chevrolet, GMC and Ram



16564

Product Features

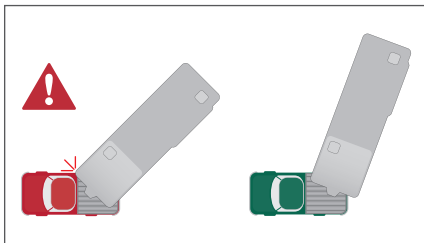

12" rearward movement provides extra turning clearance for short-bed trucks



Lever-lift motion for user-friendly functionality vs. traditional pull-out style

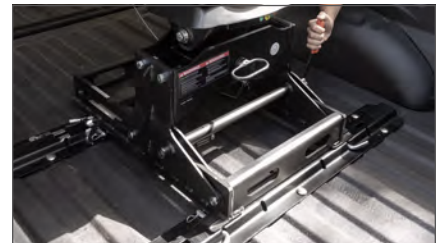

Automatically latches in both directions so you only have to exit the truck once

Pkg#	GTW	Slider Series	For Use With	Finish
16564 N	16,000 lbs.	S16™	A16 (16520) and E16 (16515)	Carbide black
16574 N	25,000 lbs.	S25™	A25 (16580) and Q25 (16565)	Carbide black

R-SERIES™ ROLLERS

See our kitted options on pages 191, 195 and 199

16k
GTW **R16™**
ROLLER

20k
GTW **R20™**
ROLLER

24k
GTW **R24™**
ROLLER

Product Details

- Provides 12" of travel while most competitive models only offer 10"
- Mounts to all industry-standard base rails
- Tested for safety in accordance with SAE J2638
- Durable carbide black powder coat finish



16550

Product Features

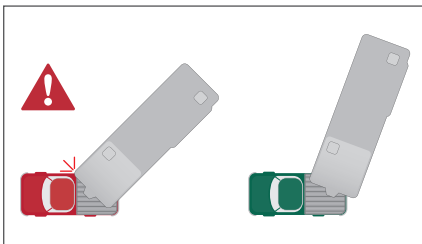

Allows for forward and rearward movement of 5th wheel hitch for added clearance



Constructed with solid, non-binding rods that lock the hitch into position



Uses wheels to bear the weight, instead of hollow rods like competition

Pkg#	GTW	Roller Series	For Use With	Finish
16560	16,000 lbs.	R16™	A16 (16520) and E16 (16515)	Carbide black
16550	20,000 lbs.	R20™	A20 (16540) and Q20 (16530)	Carbide black
16570	24,000 lbs.	R24™	Q24 (16545)	Carbide black

Roller Replacement Parts

Fig#	Part#	Description	Fits
1	19217	Roller wheel kit: - Roller wheel, qty 1 - M8 shoulder bolt, qty 1	All
2	19218	Head mounting hardware: - M14 hex bolt, qty 4 - M14 flat washer, qty 4 - M14 lock washer, qty 4 - M14 nylock nut, qty 4	All
3	19219	R16 handle assembly: - Handle, qty 1 - Handle grip, qty 1 - M6 hex bolt, qty 1 - M6 nylock nut, qty 1	16560
4	19220	R20 & R24 handle assembly: - Handle, qty 1 - Handle grip, qty 1 - M6 hex bolt, qty 1 - M6 nylock nut, qty 1	16550, 16570
5	16902	Rail pins & clips, qty 4	All

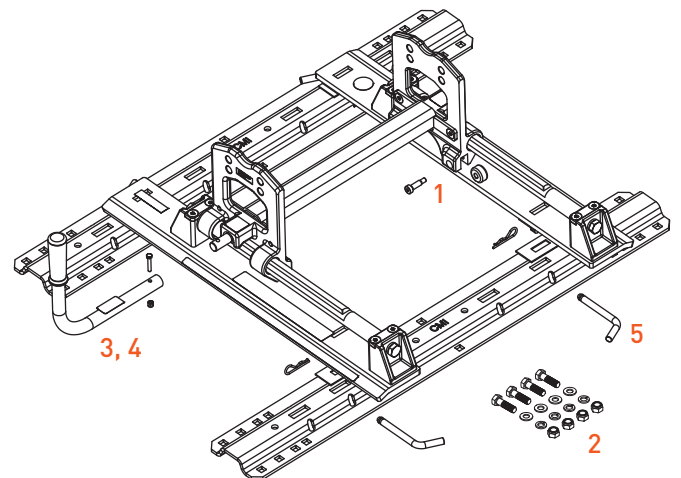

PERMANENT RAIL SYSTEMS

CUSTOM UNDER-BED BRACKETS & INDUSTRY-STANDARD BASE RAILS

Custom brackets provide a set of permanent 5th wheel base rails in the truck bed. If your customer prefers removable rails for no obstructions in the truck bed, [see page 209 for our gooseneck adapter options.](#)

Custom brackets

- Designed to be used in combination with CURT base rails (see application guide for part numbers)
- Vehicle-specific applications reduce or eliminate drilling, cutting installation time in half
- Protected by a rust-resistant liquid A-coat
- Includes mounting hardware

Semi-custom brackets

- Designed to be used in combination with CURT universal brackets and / or base rails (see application guide for part numbers)
- All semi-custom brackets require drilling to be installed



16400 brackets shown with 16204 base rails

Step 1 - Pick vehicle-specific brackets starting on page 207

Step 2 - Select the base rails by finish preference

Step 3 - Start on page 184 to select a 5th wheel hitch

UNIVERSAL UNDER-BED BRACKETS & INDUSTRY-STANDARD BASE RAILS

- **Now available in 40K option**
- Intended for vehicle applications not covered by CURT custom brackets
- Compatible with CURT and most competitive 5th wheel hitches, rollers and gooseneck adapters
- All universal brackets require drilling or welding to be installed
- Tested according to SAE J2638 specifications

Weight capacities limited to the lowest rated towing component

NEW



16205



16200



16150

Kit#	Base Rails Only#	Brackets & Hardware#	Capacity	Finish	Description
Base Rails & Brackets					
16150	--	--	25,000 lbs.	Gloss black	Two rails, 4-bolt
16100	16104	16101	25,000 lbs.	Gloss black	Two rails, 10-bolt
16200	16204	16101	25,000 lbs.	Carbide black	Two rails, 10-bolt
--	16205 N	--	40,000 lbs.	Teridium grey	Two rails, 10-bolt
Replacement Hardware					
16111	Installation hardware kit				
16103	Wheel bolts, qty 8 (for installing new brackets) Available in 10-pack #1610310 (10 sets of eight bolts)				



NEW 40K RAILS FULLY TESTED TO SAE J2638

APPLICATION GUIDE

Custom 5th Wheel Under-Bed Brackets & Base Rails

Make / Model	Style	Years	Bracket Type	Bracket#	Drilling	Base Rails		
						40K Teridium#	25K Carbide#	25K Gloss#
Chevrolet								
Silverado 1500	Excl. 5.5' bed	19 - 20	Custom	16469	No	--	16204	16104
	6.5' bed	19 - 20	Custom	16415*	No	--	16204	16104
	--	07 - 18	Custom	16400	No	--	16204	16104
	--	99 - 06	Custom	16418	Yes	--	16204	16104
Silverado 1500 Classic	--	07 - 07	Custom	16418	Yes	--	16204	16104
Silverado 1500 LD	--	19 - 19	Custom	16400	No	--	16204	16104
Silverado 2500	Excl. Cab & Chassis	99 - 04	Custom	16418	Yes	--	16204	16104
Silverado 2500 HD	Excl. Cab & Chassis	20 - 20	Custom	16429 ¹	No	16205	16204	16104
		11 - 19	Custom	16411	No	--	16204	16104
		01 - 10	Custom	16418	Yes	--	16204	16104
Silverado 2500 HD Classic	Excl. Cab & Chassis	07 - 07	Custom	16418	Yes	--	16204	16104
Silverado 3500	Excl. Cab & Chassis	01 - 06	Custom	16418	Yes	--	16204	16104
Silverado 3500 Classic	Excl. Cab & Chassis	07 - 07	Custom	16418	Yes	--	16204	16104
Silverado 3500 HD	Excl. Cab & Chassis	20 - 20	Custom	16429 ¹	No	16205	16204	16104
		11 - 19	Custom	16411	No	--	16204	16104
		07 - 10	Custom	16418	Yes	--	16204	16104
Dodge								
Ram 1500	Excl. crew cab	09 - 10	Custom	16422*	Yes	--	16204	16104
	--	09 - 10	Semi-Cust.	16306	Yes	--	16204	16104
	Extended crew cab	06 - 08	Custom	16420	No	--	16204	16104
	Excl. extended crew cab	02 - 08	Custom	16419	No	--	16204	16104
	--	02 - 08	Semi-Cust.	16303	Yes	--	16200	16100
Ram 2500 / 3500	Excl. Cab & Chassis	03 - 10	Custom	16420	No	--	16204	16104
		03 - 09	Semi-Cust.	16301	Yes	--	16200	16100

¹ Brackets rated up to 30,000 lbs. when used with #16205 (40K) base rails

* Continued while supplies last

Applications continued on the following page

Custom 5th Wheel Under-Bed Brackets & Base Rails

Make / Model	Style	Years	Bracket Type	Bracket#	Drilling	Base Rails		
						40K Teridium#	25K Carbide#	25K Gloss#
Ford								
F-150	Excl. Police Responder	15 - 20	Custom	16442	No	--	16204	16104
	Excl. 5.5' bed	04 - 14	Custom	16441	No	--	16204	16104
	--	04 - 11	Semi-Cust.	16300	Yes	--	16204	16104
		97 - 03	Custom	16437	No	--	16204	16104
F-150 Heritage	--	04 - 04	Custom	16437	No	--	16204	16104
F-250	--	97 - 99	Custom	16437	No	--	16204	16104
F-250 / F-350 Super Duty	--	17 - 20	Custom	16428	No	--	16204	16104
		11 - 16	Custom	16424	No	--	16204	16104
		05 - 10	Custom	16448	Yes	--	16204	16104
		99 - 04	Custom	16443	Yes	--	16204	16104
F-450 Super Duty	Excl. Cab & Chassis	17 - 20	Custom	16428	No	--	16204	16104
		11 - 16	Custom	16424	No	--	16204	16104
		08 - 10	Custom	16448	Yes	--	16204	16104
GMC								
Sierra 1500	Excl. 5.5' bed	19 - 20	Custom	16469	No	--	16204	16104
	6.5' Bed	19 - 20	Custom	16415*	No	--	16204	16104
	Excl. Denali	07 - 18	Custom	16400	No	--	16204	16104
	--	99 - 06	Custom	16418	Yes	--	16204	16104
Sierra 1500 Classic	--	07 - 07	Custom	16418	Yes	--	16204	16104
Sierra 1500 Limited	--	19 - 19	Custom	16400	No	--	16204	16104
Sierra 2500	Excl. Cab & Chassis	99 - 04	Custom	16418	Yes	--	16204	16104
Sierra 2500 HD	Excl. Cab & Chassis	20 - 20	Custom	16429 ¹	No	16205	16204	16104
		11 - 19	Custom	16411	No	--	16204	16104
		01 - 10	Custom	16418	Yes	--	16204	16104
Sierra 2500 HD Classic	Excl. Cab & Chassis	07 - 07	Custom	16418	Yes	--	16204	16104
Sierra 3500	Excl. Cab & Chassis	01 - 06	Custom	16418	Yes	--	16204	16104
Sierra 3500 Classic	Excl. Cab & Chassis	07 - 07	Custom	16418	Yes	--	16204	16104
Sierra 3500 HD	Excl. Cab & Chassis	20 - 20	Custom	16429 ¹	No	16205	16204	16104
		11 - 19	Custom	16411	No	--	16204	16104
		07 - 10	Custom	16418	Yes	--	16204	16104
Nissan								
Titan	--	04 - 20	Custom	16470	Yes	--	16204	16104
Ram								
1500	--	19 - 21	Custom	16307	No	--	16204	16104
	Coil springs, excl. Limited	11 - 18	Semi-Cust.	16306	Yes	--	16204	16104
	With factory air suspension	13 - 17	Custom	16444	Yes	--	16204	16104
1500 Classic	Coil springs	19 - 20	Semi-Cust.	16306	Yes	--	16204	16104
2500	Excl. 5th wheel prep pkg	14 - 20	Custom	16427	No	--	16204	16104
	--	13 - 13	Custom	16430 ¹	Yes	16205	16204	16104
			Custom	16426*	Yes	--	16204	16104
			Custom	16420	No	--	16204	16104
3500	Excl. 5th wheel prep pkg	13 - 20	Custom	16430 ¹	Yes	16205	16204	16104
	Excl. Cab & Chassis	13 - 18	Custom	16426*	Yes	--	16204	16104
		11 - 12	Custom	16420	No	--	16204	16104
Toyota								
Tundra	6.5' bed, excl ext. crew cab	07 - 20	Custom	16468	Yes	--	16204	16104
	Excl. extended crew cab	07 - 20	Semi-Cust.	16304	Yes	--	16200	16100
	Standard cab, 8' bed	00 - 06	Semi-Cust.	16302*	Yes	--	16200	16100

¹ Brackets rated up to 30,000 lbs. when used with #16205 (40K) base rails

* Continued while supplies last

REMOVABLE RAIL SYSTEMS

20k
GTW

X5™ GOOSENECK TO 5TH WHEEL ADAPTER PLATES

The X5™ adapter plate allows a gooseneck hitch to become a mounting platform for a 5th wheel hitch. The X5™ shank simply drops into the gooseneck ball hole and instantly provides a set of industry-standard 5th wheel base rails.

See the table below for gooseneck hitch compatibility.

Product Details

- Converts a gooseneck hitch into a set of standard 5th wheel base rails
- Simple, secure design allows for fast installation and removal as needed
- For use with CURT and competitive 5th wheels up to 20,000 lbs.
- Capacity limited to lowest-rated towing component
- Accepts any standard CURT 5th wheel legs or roller (excludes OEM puck system products)
- Durable carbide black powder coat finish
- Co-cured in a rust-resistant liquid A-coat
- **Not compatible with OEM puck systems, OEM-style gooseneck hitches or rotating pin boxes, such as Sidewinder™**
(Trademark of Horizon Global™)



Step 1 - Pick a gooseneck hitch. If your customer has a gooseneck hitch, see step 2

Step 2 - Select the corresponding X5™ adapter plate to match the gooseneck

Step 3 - See page 184 for our 5th wheel hitch selection guide



16210 - Fits CURT original Double Lock™



16220 - Fits CURT Double Lock EZr™



16310 - Fits B&W Turnoverball®

Part#	Fits	Capacity	Shank Style
16210	CURT Double Lock™ 60607, 60615, 60620, 60625	20,000 lbs.	Round shank
16220	CURT Double Lock EZr™ 60611 and 60619	20,000 lbs.	Round shank
16310	B&W Turnoverball® gooseneck hitch (does not work with shallow models)	20,000 lbs.	Square shank

See page 236 for original Double Lock™ gooseneck hitches. See page 234 for Double Lock EZr™ gooseneck hitches

5TH WHEEL ACCESSORIES

5TH WHEEL HITCH LOCK

- Extra-long 1/2" diameter pin fits all industry-standard base rails
- Rust-free aluminum housing with a durable black powder coat finish
- Weather-resistant dust cap helps prevent internal corrosion
- Easy-to-access, 1/8-turn lock activation
- Includes two keys for added convenience



23256



Key slot angled upward for easier ergonomic access



Locks a 5th wheel hitch into the rails, taking the place of a pin & clip



Installs tight against the lip of the base rail for enhanced security

Pkg#	Pin Diameter	Finish
23256	1/2"	Black powder-coated aluminum

KINGPIN LOCK

- Built with an aluminum body for corrosion resistance
- Two keys included for added convenience
- Space-saving, full-color retail packaging



Locks on to 5th wheel kingpin to deter theft of 5th wheel trailer



Universal design fits most 5th wheel trailer kingpins



23255

Pkg#	Description	Finish
23255	5th wheel trailer kingpin lock	Chrome-plated

5TH WHEEL LUBE PLATES

- Provides a buffer between 5th wheel head plate and kingpin box
- Reduces normal wear and tear when towing
- Eliminates messy grease deposits on hitch head plate
- 12" plate features self-cleaning grooves to maintain good lubrication
- Constructed from tough polyethylene



16722



16721



Adds a buffer between 5th wheel head plate and kingpin box



Fits any standard kingpin, simply snap it into place before coupling



16721025

Bulk#	25-Pack Tray#	Description
16721	16721025	10" 5th wheel lube plate
16722	--	12" 5th wheel lube plate



5TH WHEEL WEDGES

A rotating 5th wheel pin box creates an alternative pivot point for the 5th wheel connection, providing the 5th wheel trailer with a wider turn radius. However, because of this secondary pivot point, the primary pivot point must be fixed to keep the trailer from wandering. A 5th wheel wedge bolts onto the pin box, locks up the kingpin and keeps it from swiveling.

- Allows a CURT A-Series™ or E-Series™ hitch to be used with rotating pin boxes, such as Sidewinder™ (Trademark of Horizon Global™)
- Bolts on behind the kingpin of the pin box to restrict movement between 5th wheel hitch and pin box
- Durable carbide black powder coat finish
- Made in USA (may include imported hardware)



16991



16992

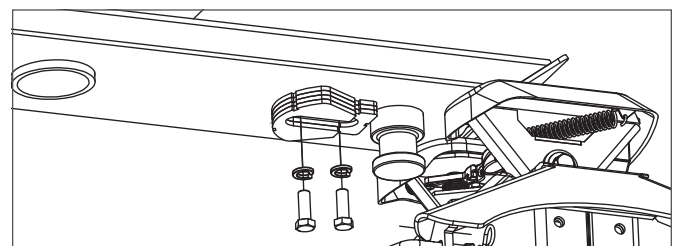

Restricts movement between E- and A-Series™ hitch and rotating pin box, such as Sidewinder™ (TM of Horizon Global™)

Part#	Fits
16991	E-Series™ 5th wheel hitch (page 198)
16992	A-Series™ 5th wheel hitches (page 190)

5TH WHEEL SAFETY CHAIN LOOPS

- Installs easily onto 5th wheel rails with pins & clips
- Wide openings accept heavy-duty hooks and chains
- Durable carbide black powder coat finish



16000

Provides a solid attachment point for 5th wheel safety chains in your truck bed

Universal design fits all industry-standard 5th wheel base rails

Pkg#	GTW	Description
16000	20,000 lbs.	5th wheel safety chain loops

5TH WHEEL RAIL SOUND-DAMPENING PADS

- Helps eliminate clanking and rattling
- Compatible with all CURT 5th wheel legs, sliders, rollers and base rails (excluding OEM puck system products)
- Tough neoprene rubber

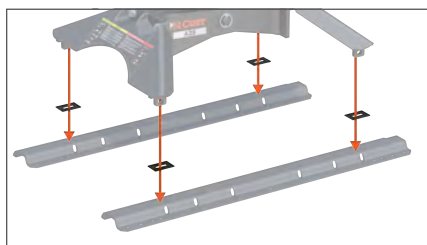

Place between a 5th wheel hitch and base rails to dampen sound



16901

16900

Bulk#	Pkg#	Quantity
16900	16901	4

BETTERWEIGH™ MOBILE TOWING SCALE

- Measures real-time vehicle-trailer weights, including pin weight, for safer towing
- No more complicated at-home measurements or trips to the scale
- Bluetooth connection provides active readouts on the driver's smartphone
- No-install, plug-and-play setup into vehicle diagnostic port (OBD-II) below the dash
- Accurate within + / - 5%
- Offers easy brake controller setup by measuring exact trailer brake gain needed
- **See page 98 for more information**



51701



Scan to see it in action!

Download the app:
BetterWeigh Towing Scale



Pkg#	Description
51701	Mobile towing scale

5TH WHEEL ELECTRICAL

CUSTOM WIRING EXTENSION HARNESSES

- Routes a 7-way RV blade socket into truck bed while retaining use of rear socket
- Simple plug-and-play design eliminates the need for cutting or splicing
- Neoprene well nuts isolate steel bolts from aluminum surfaces (#57007)
- **See page 154 for more information**

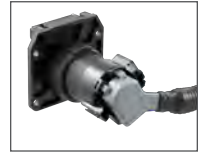

Right-angle plug for easy installation

7-WAY RV BLADE EXTENSION HARNESS

- Routes existing 7-way RV blade socket into full-size pickup truck bed (7' length)
- Universal size fits any 7-way RV blade socket
- Allows for easy connection of 5th wheel or gooseneck wiring
- **See page 155 for more information**



REPLACEMENT 7-WAY RV BLADE HARNESSES

- Replaces the trailer-end plug of any 7-way harness
- Wires protected by heavy-duty, weather-resistant cable
- Cold-weather harnesses feature soft thermoplastic elastomer casing to remain flexible in cold temperatures (temperature rating from -40°F up to 221°F)
- **See page 155 for more information**



BRAKE CONTROLLERS

- Easily calibrated for all towing needs
- Proportional and time-delay units available
- Compatible with anti-lock brakes and cruise control
- **See page 138 for our complete brake controller line**



Name	Pkg#	Six-Pack#	Repl. Bracket#	Axles	Brakes	Activation Method	Display	Vertical Mount Angle	Level Adjust	Warranty
Echo®	51180	--	--	1 - 2	2 - 4	Tri-axis inertia	Phone app	N/A	Auto	Limited lifetime
Spectrum™	51170	--	--	1 - 4	2 - 8	Tri-axis inertia	Tri-color LED	Any	Auto	Limited lifetime
Assure™ N	51160	--	--	1 - 4	2 - 8	Tri-axis inertia	OLED screen	Any	Auto	Limited lifetime
TriFlex™	51140	51142	51144	1 - 4	2 - 8	Tri-axis inertia	Digital	-20° to +70°	Auto	Limited lifetime
Discovery™	51120	51122	51124	1 - 4	2 - 8	Time-based	Digital	Any	Auto	Limited lifetime
Venturer™	51110	--	51114	1 - 3	2 - 6	Time-based	LED	Any	Auto	Limited lifetime



FLAT TOWING

TRUST THE TOWING EXPERTS

Rambler™ tow bar



FEATURED PRODUCTS



Rambler™ tow bar

This RV tow bar features non-binding latches for easy release on uneven ground. It weighs less than 40 lbs. and is rated to 7.5K.



Dinghy towing adapters

Specifically designed for flat towing applications, we've added several coiled adapters, providing a reliable connection to the RV.



Rambler™ lock set

Give your customers enhanced security for their vehicle and peace of mind out on the road with this keyed-alike Rambler™ lock set.

PRODUCT INDEX



217

Rambler™
Tow Bar



218

Tow Bar
Base Plates



219

Rambler™
Accessories



220

Universal
Tow Bars



221

Flat Towing
Accessories



222

Dinghy Towing
Adapters



223

RV
Harnesses



TRUST THE TOWING EXPERTS

CURT HAS YOU COVERED

Years of knowledge and experience have culminated to produce our line of tested, proven flat towing products, including RV tow bars, base plates, wiring and accessories. We test our products to rigorous standards because successful towing starts with safety.

RV trailer hitches available, see page 22

Why CURT Tow Bars

Design expertise



Years of engineering experience have been poured into the design of our tow bars, delivering superior features

Detailed craftsmanship



Down to the smallest detail CURT RV tow bars are crafted for real RVers and everyday road warriors

Uncompromised testing



Computer testing isn't enough on its own. CURT RV tow bars are rigorously tested in real-world, physical conditions

Why CURT Base Plates

Simplified design



Our simplified base plate designs provide improved fitment on each vehicle, requiring fewer front-end modifications and no extra trimming for RV harness installation

High-quality components



Large spacers inside the vehicle frame better distribute the load, while superior grade-8 hardware and fishwire eliminate the need for Loctite and wire nuts

Streamlined installation



Our comprehensive instruction manuals walk through the installation step-by-step, while fewer components and upgraded hardware speed up installation time



2
INCH

RAMBLER™ STEEL TOW BAR

Scan to
learn more



NEW

Upgrade Your Tow Bar

- Rigorous physical testing for proven safety and performance
- Polymer isolator washers reduce friction for smooth, anti-rattle operation
- Premium textured black finish for lasting corrosion and wear resistance
- Two hitch pin holes for adjustable length and added clearance as needed
- Compatible with CURT or Blue Ox® base plates (sold separately)

Pkg#	Shank Size	GTVW	Finish
70001 N	2"	7,500 lbs.	Textured black



Non-binding latches



Patent-pending, non-binding latches for easy release on uneven ground

Three stowing positions



Three stowing positions to avoid obstructions and maximize versatility

Only 40 lbs.



With a total weight of only 40 pounds, Rambler™ is easy to lift, carry and install



CUSTOM-FIT TOW BAR BASE PLATES

- Spreads towing forces equally for reduced stress on the vehicle frame
- Made with a vehicle-specific design for a custom fit
- Precisely welded for superior strength and fit
- Physically tested to gross vehicle weight rating (GVWR)
- Durable high-gloss black powder coat finish
- Co-cured in a rust-resistant liquid A-coat

For base plate application guide see page 218



NEW PRODUCT = **N**

877.287.8634 • CURTMFG.COM • **FLAT TOWING** • 217



TOW BAR BASE PLATES

Installation may be too difficult for some users. Visit curtmfg.com/storelocator to find an installer. Always consult your vehicle owner's manual for proper flat towing procedures and limitations. Never exceed the recommended gross vehicle weight rating (GVWR).

RV HARNESES

Add-Ons

#58918* - non-converter add-on compatible
 #58919* - non-powered converter add-on compatible
 #58920 - powered converter add-on compatible

Make / Model	Style / Notes	Years	Part#	Footnotes	PC	Tab Height	Tab Width	Ins Diff.	Years	Part#	Footnotes	PC	Ins Diff.	Add-On#
BUICK														
ENVISION	--	16 - 19	70117	A, C, D, E, G, I	103	17.25 IN	24 IN	3.0	16 - 20	58968	--	E26	EASY	--
CADILLAC														
ESCALADE	--	15 - 20	70111	A, C, D, E	98	17.5 IN	32.5 IN	3.0	15 - 20	58965	--	E29	EASY	--
SRX	--	10 - 16	70123	A, C, I	103	16.5 IN	18 IN	3.0	--	--	--	--	--	--
CHEVROLET														
COLORADO	--	15 - 20	70107	C, E, G, I	103	23 IN	28 IN	3.5	15 - 21	58910	--	E21	EASY	--
EQUINOX	--	18 - 20	70108	A, C, E, I	98	16 IN	23 IN	4.0	18 - 20	58974	WITH LED TAILLIGHTS	E19	EASY	--
		10 - 17	70109	A, C, D, E, G, I	103	15.5 IN	24 IN	3.0		58971	WITHOUT LED TAILLIGHTS	E30	EASY	--
SILVERADO 1500	--	16 - 18	70120	A, C, D, E, F	103	18 IN	32.5 IN	3.0	16 - 18	58967	--	E21	EASY	--
SILVERADO 1500 LD	--	19 - 19	70120	A, C, D, E, F	103	18 IN	32.5 IN	3.0	19 - 19	58967	--	E21	EASY	--
SONIC	--	12 - 19	70116	A, C, D, E, I	103	13.5 IN	18 IN	2.0	17 - 20	58969	SEDAN	E32	EASY	--
									12 - 16	58936	--	E19	EASY	--
SUBURBAN	EXCL. Z71 OR ADAPTIVE CRUISE Z71, EXCL. ADAPTIVE CRUISE	15 - 20	70111	A, C, D, E	98	17.5 IN	32.5 IN	3.0	15 - 20	58966	--	E23	EASY	--
		15 - 20	70120	A, C, D, E, F	103	18 IN	32.5 IN	3.0						
TAHOE	EXCL. Z71 OR ADAPTIVE CRUISE Z71, EXCL. ADAPTIVE CRUISE	15 - 20	70111	A, C, D, E	98	17.5 IN	32.5 IN	3.0	15 - 20	58966	--	E23	EASY	--
		15 - 20	70120	A, C, D, E, F	103	18 IN	32.5 IN	3.0						
DODGE														
DURANGO	--	11 - 13	70101	A, C, D, F, G	98	17.5 IN	34.75 IN	3.0	11 - 13	58959	--	E23	EASY	58920
FORD														
EXPEDITION	--	15 - 17	70106	A, C, F, G	103	17.5 IN	35 IN	3.0	--	--	--	--	--	--
EXPLORER	--	16 - 19	70114	A, C, D, E	103	16.5 IN	22 IN	3.0	16 - 19	58976	--	E19	MOD	--
F-150	--	09 - 20	70106	A, C, F, G	103	17.5 IN	35 IN	3.0	15 - 20	58970	--	E22	EASY	--
									09 - 14	58912	--	E30	EASY	--
FIESTA	--	14 - 19	70119	A, C, D, E, I	103	22 IN	24 IN	3.0	14 - 19	58977	SEDAN	E19	MOD	58919*
									14 - 19	58972	HATCHBACK	E24	MOD	58919*
FOCUS	EXCL. RS	16 - 18	70113	A, C, D, E	103	13.5 IN	21.5 IN	3.0	12 - 18	58944	SEDAN	E25	EASY	58918*
GMC														
ACADIA	--	17 - 19	70118	A, C, D, E	103	16 IN	20 IN	3.0	17 - 19	58973	--	E25	EASY	--
CANYON	--	15 - 20	70107	C, E, G, I	103	23 IN	28 IN	3.5	15 - 21	58910	--	E21	EASY	--
SIERRA 1500	--	16 - 18	70120	A, C, D, E, F	103	18 IN	32.5 IN	3.0	16 - 18	58967	--	E21	EASY	--
SIERRA 1500 LIMITED	--	19 - 19	70120	A, C, D, E, F	103	18 IN	32.5 IN	3.0	19 - 19	58967	--	E21	EASY	--
TERRAIN	--	10 - 17	70109	A, C, D, E, G, I	103	15.5 IN	24 IN	3.0	10 - 17	58900	--	E21	EASY	58918*
YUKON	EXCL. Z71 OR ADAPTIVE CRUISE	15 - 20	70111	A, C, D, E	98	17.5 IN	32.5 IN	3.0	15 - 20	58965	--	E29	EASY	--
YUKON XL	EXCL. Z71 OR ADAPTIVE CRUISE	15 - 20	70111	A, C, D, E	98	17.5 IN	32.5 IN	3.0	15 - 20	58965	--	E29	EASY	--
HONDA														
CR-V	--	12 - 14	70104	C, D, E, G, I	103	15.5 IN	24 IN	2.0	12 - 16	58904	--	E21	MOD	--
		07 - 11	70115	A, C, E, I	103	16 IN	19 IN	3.0	07 - 11	58901	--	E21	MOD	--
JEEP														
CHEROKEE	--	19 - 20	70103	C, F, G, H	103	20 IN	37.25 IN	3.0	19 - 20	58963	--	E23	EASY	--
GRAND CHEROKEE	--	11 - 16	70101	A, C, D, F, G	98	17.5 IN	34.75 IN	3.0	14 - 20	58907	EXCL. SRT	E21	MOD	--
									07 - 13	58940	--	E31	EASY	58918*
WRANGLER	JL	18 - 20	70105	A, B, E	103	18 IN	24 IN	2.0	18 - 21	58964	--	E29	EASY	--
	JK, EXCL. RUBICON, HARD ROCK, 75TH ANNIVERSARY, AND ARB BUMPER	07 - 18	70102	A, B, E	98	14.5 IN	24 IN	2.0	07 - 18	58903	EXCL. RIGHT HAND DRIVE	E27	EASY	58919*
	JK, EXCL. STANDARD BUMPER	07 - 18	70110	A, B, E	103	17 IN	24 IN	2.0						
	TJ	97 - 06	70112	A, B	103	17.75 IN	24 IN	2.0	97 - 06	58902	--	E26	EASY	58919*
LINCOLN														
NAVIGATOR	--	15 - 17	70106	A, C, F, G	103	17.5 IN	35 IN	3.0	--	--	--	--	--	--

TOW BAR BASE PLATE APPLICATION GUIDE FOOTNOTE KEY

For the most up-to-date application information, please visit curtmfg.com

A Frame drilling required	C Baseplate concealed	E Concealed trimming required	G Permanent part removal	I Vehicle component mods or relocation
B Baseplate exposed	D Visible trimming required	F Tow hook removal required	H Rivet removal and replacement required	* Continued while supplies last

TOW BAR & BASE PLATE REPLACEMENT PARTS

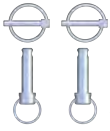

19261

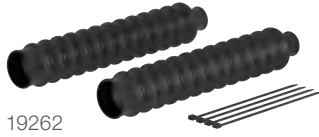

19262



70002



70006



70008

Part#	Description	Break Strength	Length	Cable Diameter	Hook Opening
19261	Tow bar pins and lynch pins, qty 2	--	--	--	--
19262	Tow bar rubber bellow, qty 2	--	--	--	--
70002	Tow bar attachment tab, qty 1	--	7-3/4"	--	--
70003	Tow bar attachment tab, qty 1	--	9-1/4"	--	--
70006	Tow bar base plate safety cable, qty 1	3,500 lbs.	36"	1/4"	--
70007	Tow bar base plate safety cable, qty 1	7,500 lbs.	36"	3/8"	--
70008	Tow bar safety cable, qty 1	7,500 lbs.	84"	3/8"	17/32"



Twist-lock tabs are easy to install and remove

RAMBLER™ TOW BAR LOCK SET

- Secures tow bar vehicle and RV attachment points
- Easy-to-operate, 1/4-turn lock activation
- Watertight dust cap prevents internal corrosion
- Includes six keys for added convenience



Locks keyed alike for convenient one-key operation



Helps protect dinghy setup when left unattended



70005

Pkg#	Fits Tube Size	Hitch Pin Diameter	Tow Bar Arm Lock Pin Diameter	Finish	Includes
70005 N	Up to 2-1/2"	5/8"	1/2"	Chrome-plated	Two tow bar arm locks and one hitch lock



2

INCH

RECEIVER HITCH ADAPTERS

- Fits industry-standard 2" hitch receiver tubes and accepts 2" shanks
- Ideal for leveling a tow bar with vehicle base plates



45797



45798



Part#	Shank Size	Accepts	GTVW	Drop	Rise	Length	Finish
45797 N	2"	2" shank	7,500 lbs.	2"	2"	8"	Gloss black
45798 N	2"	2" shank	7,500 lbs.	4"	4"	12-1/4"	Gloss black



READY FOR ANY ADVENTURE

UNIVERSAL TOW BARS

- Ideal for dinky towing a small vehicle behind an RV
- Features a 2" heavy-duty coupler
- Lightweight design for easy handling
- Universal brackets bolt to the frame of the vehicle (trimming may be required)
- Includes universal frame brackets and mounting hardware
- **New, compact, retail-friendly packaging (#19750)**



Adjustable arm width allows for fitment on a variety of vehicles



19750



19745

Pkg#	Capacity	Arm Structure	Adjustment Range	Ball Diameter	Finish
19750 N	5,000 lbs.	Two pieces, bolt together	26" to 40" in width	2"	Gloss black
19745	5,000 lbs.	One-piece	26" to 41" in width	2"	Gloss black

Replacement Parts

Part#	Description	Fits
19746	Replacement safety pin (new style)	19745
21500	Replacement pin & clip (old style)	19745
19748	Bumper brackets	19745



19746



21500



19748

EXTENDED VIEW TOW MIRROR

- Compatible with pickup or SUV left or right side mirror
- Fully adjustable design can be used in horizontal or vertical position
- Hinging arm and elastic straps provide easy and secure installation



Attaches to side mirror to expand view with a trailer



Articulating head allows precise angling



20002

Pkg#	Adds	Fits
20002	5" to 7-1/2" to existing mirror	Mirrors from 4" to 11" high

TOWING LIGHTS

- Non-scratch magnetic base protects vehicle finish
- Snap locks included for simple, secure splice-in connection
- Patent #D355,270



Easily adds tow lights to a vehicle being dinghy towed



Perfect for boats, RVs and flat towing applications



53204

53200

Bulk#	Case#	Length	Plug	Description
53200	53204	20'	4-way flat	Auxiliary towing lights

TOWING ACCESSORIES STORAGE BAG

- Durable fabric construction with heavy-duty zipper
- Comfort-grip handles for easy portability
- High-strength webbing straps full wrap the bag
- Metal lining along the opening keeps bag open and upright for easy access
- Reinforced bottom helps support heavy tools

Part#	Number of Interior Pockets
70004 N	12

NEW



70004

DINGHY TOWING ADAPTER HARNESES

- Plugs into CURT RV harness 4-flat to provide a standard connector under the dinghy vehicle's hood
- Allows for flexible mounting on the front of the dinghy vehicle versus welded connector bracket
- 6' length is ideal for equipping dinghy vehicle for flat towing behind RV
- Some manual wiring required



Pkg#	From Dinghy Vehicle	To RV	Length	Material
58980 N	4-way flat	7-way RV blade	6 feet	Plastic
58981 N	4-way flat	6-way round	6 feet	Plastic

DINGHY TOWING ADAPTERS

- Ideal for connecting motorhomes to dinghy vehicle for flat towing
- UV-resistant coiled cable extends without scraping the ground
- Simple plug-and-play design eliminates the need for cutting or splicing
- Constructed from die-cast or durable plastic
- Informative, full-color, retail packaging



Pkg#	From Dinghy Vehicle	To RV	Extends	Included Socket	Socket Housing
57271	4-way flat	7-way RV blade	5 feet	--	Plastic
57280 N	4-way flat	7-way RV blade	8 feet	--	Plastic
57281	5-way flat	7-way RV blade	5 feet	--	Plastic
57282 N	5-way flat	7-way RV blade	8 feet	--	Plastic
57283 N	6-way round	7-way RV blade	8 feet	One 6-way round	Plastic and die cast
57284 N	7-way RV blade	7-way RV blade	8 feet	One USCAR 7-way RV blade	Plastic
57285 N	4-way round	7-way RV blade	8 feet	One 4-way round	Plastic and die cast
57286 N	6-way round	6-way round	8 feet	Two 6-way round	Die cast

RV HARNESSES

- Integrated block diodes isolate sensitive vehicle electronics from RV signals
- Uses towed vehicle's existing taillights, brake lights and turn signals
- Optional harness add-on equips vehicle with standard 4-way flat for towing a trailer (not available for all RV harnesses; see table)

For RV harness application guide see page 224



Connects a towed vehicle to an RV using a standard 4-way flat trailer plug



Simple plug-and-play design eliminates the need for cutting or splicing



Includes harness, 4-flat extension, mounting bracket and hardware

SPLICE-IN RV HARNESS

- Connects a towed vehicle to an RV using a standard 4-way flat trailer plug
- Splices into vehicle's electrical system with included butt connectors
- Color-coded wires with wiring guide for easier installation
- Integrated block diodes isolate sensitive vehicle electronics from RV signals
- Uses towed vehicle's existing taillights, brake lights and turn signals
- Not compatible with PWM electrical systems



Part#	Description
58979 N	Splice-in RV harness

RV HARNESS DIODE KIT

- Allows RV to power lights only on the towed vehicle without power feeding back
- Requires trailer-side 4-way flat plug with 20' wires or similar



Pkg#	Amps / Block	Volts / Block	Includes
58999	3 amps	24 volts max	Four diode blocks / 12 spade terminals

RV HARNESS APPLICATION GUIDE

RV Harnesses				
Make / Model	Style	Years	Harness#	Add-On#
Acura				
MDX	--	16 - 18	58955	--
Buick				
Enclave	--	13 - 17	58908	58920
		08 - 12	58932	58918*
Envision	--	16 - 20	58968	--
Rainier	--	04 - 07	58925	--
Cadillac				
Escalade	--	15 - 20	58965	--
		07 - 12	58927	--
		02 - 06	58923*	58918*
Escalade ESV	--	03 - 06	58923*	58918*
SRX	--	10 - 16	58978	--
Chevrolet				
Avalanche	--	07 - 12	58924*	58918*
Avalanche 1500	--	02 - 06	58923*	58918*
Cobalt	Coupe, excl. SS	05 - 10	58929*	58918*
Colorado	4WD	15 - 21	58910	--
	--	04 - 12	58926	58919*
Cruze	--	11 - 15	58935	--
Cruze Limited	--	16 - 16	58935	--
Equinox	With LED taillights	18 - 20	58974	--
	Without LED taillights	18 - 20	58971	--
	--	10 - 17	58900	58918*
HHR	Excl. SS	06 - 11	58929*	58918*
Malibu	Excl. LTZ	13 - 15	58934	--
		08 - 12	58932	58918*
Malibu Limited	Excl. LTZ	16 - 16	58934	--
Silverado 1500	--	19 - 21	58984	--
		16 - 18	58967	--
		03 - 13	58923*	58918*
Silverado 1500 Classic	--	07 - 07	58923*	58918*
Silver. 1500 HD	--	02 - 06	58923*	58918*
Silverado 1500 HD Classic	--	07 - 07	58923*	58918*
Silver. 1500 LD	--	19 - 19	58967	--
Silverado 2500	--	02 - 04	58923*	58918*
Silverado 2500 HD	--	16 - 18	58967	--
		02 - 14	58923*	58918*
Silverado 2500 HD Classic	--	07 - 07	58923*	58918*
Silverado 3500 HD	--	16 - 18	58967	--
		07 - 14	58923*	58918*
Sonic	Sedan	17 - 20	58969	--
	--	12 - 16	58936	--
Suburban	--	15 - 20	58966	--

RV Harnesses				
Make / Model	Style	Years	Harness#	Add-On#
Chevrolet (continued)				
Suburban 1500	--	07 - 13	58927	--
Tahoe	--	15 - 20	58966	--
	Excl. hybrid	07 - 12	58927	--
Trailblazer	--	02 - 08	58925	--
Traverse	--	13 - 17	58922	58920
		09 - 12	58932	58918*
Dodge				
Caliber	--	08 - 12	58959	--
Durango	--	14 - 20	58957	--
		11 - 13	58959	--
Nitro	--	07 - 11	58937	58919*
Ram 1500	--	09 - 10	58916	--
Fiat				
500	--	12 - 18	58911	--
Ford				
Edge	With LED taillights	15 - 17	58953	58920
		11 - 14	58914	58920
		07 - 10	58952	58920
Escape	S or SE	20 - 20	58954	--
		17 - 19	58954	--
	--	13 - 16	58943	58920
		05 - 12	58952	58920
Explorer	--	16 - 19	58976	--
F-150	--	15 - 20	58970	--
		09 - 14	58912	--
Fiesta	Hatchback	14 - 19	58972	--
		11 - 13	58946	--
	Sedan	14 - 19	58977	--
Flex	--	09 - 19	58941	58918*
Focus	Hatchback	12 - 14	58905	--
	Sedan	12 - 18	58944	58920
Freestar	--	04 - 07	58952	58920
Fusion	--	13 - 20	58945	58920
GMC				
Acadia	--	17 - 19	58973	--
		13 - 16	58908	58920
Acadia Limited	--	17 - 17	58908	58920
Canyon	4WD	15 - 21	58910	--
	--	04 - 12	58926	58919*
Envoy	--	02 - 09	58925	--
Sierra 1500	--	19 - 21	58984	--
		16 - 18	58967	--
		03 - 13	58923*	58918*

* Continued while supplies last
 58918 - non-converter add-on compatible
 58919 - non-powered converter add-on compatible
 58920 - powered converter add-on compatible

RV Harnesses				
Make / Model	Style	Years	Harness#	Add-On#
GMC (continued)				
Sierra 1500 Classic	--	07 - 07	58923*	58918*
Sierra 1500 HD	--	02 - 06	58923*	58918*
Sierra 1500 HD Classic	--	07 - 07	58923*	58918*
Sierra 1500 Ltd	--	19 - 19	58967	--
Sierra 2500	--	02 - 04	58923*	58918*
Sierra 2500 HD	--	16 - 18	58967	--
		02 - 14	58923*	58918*
Sierra 2500 HD Classic	--	07 - 07	58923*	58918*
Sierra 3500 HD	--	16 - 18	58967	--
		07 - 14	58923*	58918*
Terrain	--	10 - 17	58900	58918*
Yukon	--	21 - 21	58985	--
		15 - 20	58965	--
		07 - 14	58927	--
Yukon XL	--	15 - 20	58965	--
Yukon XL 1500	--	07 - 14	58927	--
Honda				
CR-V	--	12 - 16	58904	--
		07 - 11	58901	--
		02 - 06	58949	--
Fit	--	07 - 13	58948	58919*
Isuzu				
i-280	--	06 - 06	58926	58919*
i-290	--	07 - 08	58926	58919*
i-350	--	06 - 06	58926	58919*
i-370	--	07 - 08	58926	58919*
Jeep				
Cherokee	--	19 - 20	58963	--
		14 - 18	58909	58920
Compass	--	17 - 21	58958	--
		11 - 16	58938	58920
Gladiator	--	20 - 21	58964	--
Grand Cherokee	Excl. SRT	14 - 20	58907	--
	--	07 - 13	58940	58918*
		99 - 04	58915	58919*
Liberty	--	08 - 12	58937	58919*
		02 - 07	58917	58919*
Patriot	--	08 - 17	58959	--
Wrangler	JK, excl. right hand drive	07 - 18	58903	58918*
	JL	18 - 21	58964	--
	TJ	98 - 06	58902	58918*

RV Harnesses				
Make / Model	Style	Years	Harness#	Add-On#
Lincoln				
Aviator	--	20 - 20	58983	--
MKT	--	10 - 19	58960	--
MKX	--	11 - 15	58930	58920
		07 - 10	58952	58920
Mazda				
Tribute	--	08 - 11	58952	58920
Mercury				
Mariner	--	05 - 11	58952	58920
Nissan				
Juke	--	11 - 17	58961	--
Oldsmobile				
Bravada	--	02 - 04	58925	--
Pontiac				
G5	Coupe	07 - 09	58929*	58918*
Pursuit	Coupe	05 - 06	58929*	58918*
Ram				
1500	--	19 - 20	58975	--
	4WD, excl. LED taillights	13 - 18	58916	--
	4WD, with LED taillights	13 - 18	58906	--
	--	11 - 12	58916	--
1500 Classic	4WD, excl. LED taillights	19 - 20	58916	--
	4WD, with LED taillights	19 - 20	58906	--
2500	4WD, excl. LED taillights	13 - 18	58916	--
	4WD, with LED taillights	13 - 18	58906	--
3500	4WD, excl. LED taillights	13 - 18	58916	--
	4WD, with LED taillights	13 - 18	58906	--
Saturn				
Vue	Excl. CVT trans.	02 - 07	58928	58919*
Subaru				
XV Crosstrek	--	13 - 15	58962	--
Toyota				
RAV4	Excl. AWD	13 - 18	58956	--
	--	06 - 12	58913	58920

* Continued while supplies last
58918 - non-converter add-on compatible
58919 - non-powered converter add-on compatible
58920 - powered converter add-on compatible



GOOSENECK HITCHES

TRUST THE TOWING EXPERTS

Ram OEM-style gooseneck hitch



FEATURED PRODUCTS



30K Spyder™ rail adapter

This new 30K gooseneck hitch easily drops into any industry-standard 5th wheel rails, providing a 2-5/16" diameter gooseneck ball.



OEM-style hitches

These OEM-style hitches are designed for a custom fit on the latest Chevrolet, Ford, GMC and Ram 2500 and 3500 pickup trucks.



Double Lock EZr™

With a one-person, no-measure install and easy operation, the EZr™ is the gooseneck hitch of choice. It has a 30K rating and 2-5/16" ball.

PRODUCT INDEX

A B C



228

Selecting a Gooseneck



232

OEM-Style Hitches



234

Double Lock EZr™ Hitches



236

Original Double Lock™ Hitches



237

X5™ 5th Wheel Adapter Plates



240

Over-Bed Hitches



240

Fixed Ball Hitches



242

5th Wheel Rail Hitches



243

Gooseneck Electrical

SELECTING A GOOSENECK HITCH

There are three basic methods for installing a gooseneck hitch:

A | OEM PUCK SYSTEM OPTIONS

Many pickups today are factory-equipped with a truck bed puck system. A puck system provides attachment points for both gooseneck and 5th wheel towing.

For trucks with a puck system, an OEM puck system gooseneck kit is the easiest way to tow a gooseneck trailer. The components can be installed or removed quickly, as necessary.

See page 230 to select one of these kits.

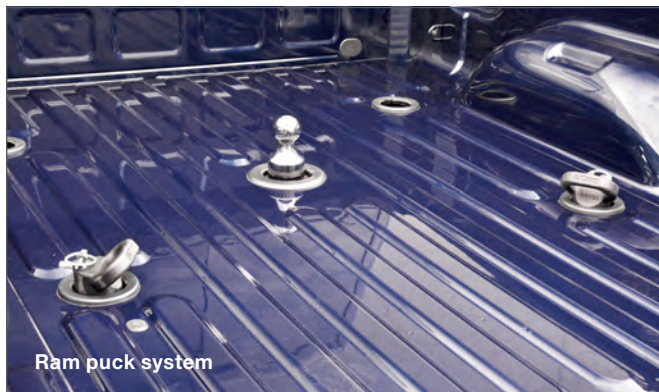

B | HITCH & BRACKET OPTIONS

The traditional method for installing a gooseneck hitch is vehicle-specific brackets. CURT OEM-style gooseneck hitches are a unique variant of the traditional method, featuring an all-in-one, custom-fit design that bolts to the truck frame like a factory hitch. No additional brackets required. See page 232 for our OEM-style hitches.

We also offer a variety of traditional gooseneck hitches that mount with vehicle-specific brackets. Options include our Double Lock EZr™, original Double Lock™ and more. Start on page 234 for our traditional gooseneck hitch line.

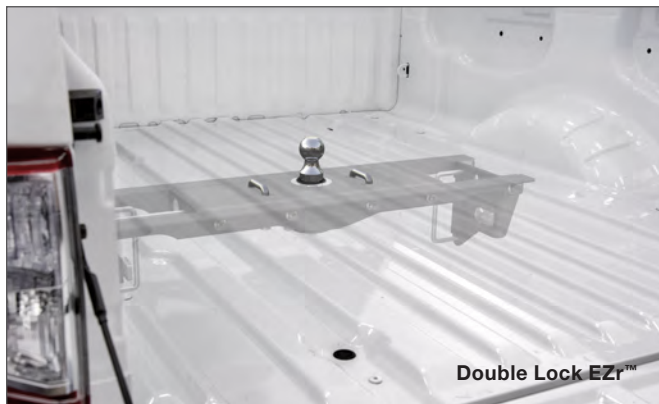

C | EXISTING 5TH WHEEL BASE RAIL OPTIONS

For trucks with 5th wheel rails already installed, CURT offers 5th wheel rail gooseneck hitches. These 5th-wheel-to-gooseneck adapters easily drop into any industry-standard base rails.

A 5th wheel rail hitch provides a ball ready for towing a gooseneck trailer, and the hitch can easily be removed from the rails whenever necessary to allow for 5th wheel towing or clearing the bed for cargo.

See page 242 for 5th wheel rail goosenecks.

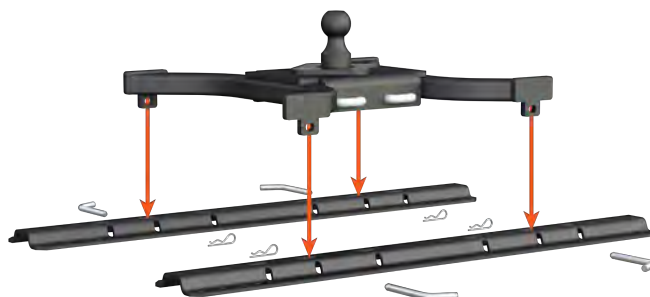



| OEM puck system anchor kit



| OEM-style hitch



| Bent plate hitch



OEM PUCK SYSTEMS

30K

GTW

38K

GTW

OEM PUCK SYSTEM GOOSENECK KITS

Available for Chevrolet, Ford, GMC, Nissan and Ram, these kits utilize the truck bed puck system built into select pickups with the towing prep package (see table below). The ball and anchors easily drop into the pucks, lock into place and are immediately ready to couple to a gooseneck trailer.

Each kit includes:

- 2-5/16" gooseneck ball
- Two safety chain anchors
- Rubber hole cover
- Durable storage case



60692

Quarter-turn anchoring system



Step 1 - Lift and twist latch to release the retention balls



Step 2 - Drop the ball into OEM puck system hole



Step 3 - Return latch to lock the ball in place for towing



Large safety chain openings accept heavy-duty hooks

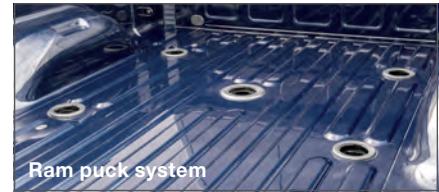

Installation of these products requires an OEM truck bed puck system (example above)

Product Details

Gooseneck ball

- Weight ratings are limited to vehicle manufacturer's stated capacities
- Installs easily with quarter-turn latch locking system
- Kits include 2-5/16" (3" ball sold separately)
- Stainless steel retention balls keep shank fully locked into the hitch
- Constructed from strong, machine-forged steel alloy
- Protected by a polished chrome-plated mirror finish
- Tested for safety to J2638 specifications (30K balls tested to U.S. VESC V-19)
- Patent #8,955,866

Safety chain anchors

- Provides a reliable connection for gooseneck trailer safety chains
- Simple, drop-in install eliminates the need for tools
- Wide openings accept large safety chain hooks
- Constructed from heavy-duty, forged steel
- Durable carbide black powder coat finish
- Patent #9,452,647

Make	Model	Style	Years
Kit Compatibility - See Adjacent Page for Part Numbers			
Chevrolet	Silverado 2500 HD / 3500 HD	With 5th wheel prep package	16 - 20
Ford	F-250 / F-350 Super Duty	With 5th wheel prep package	13 - 20
GMC	Sierra 2500 HD / 3500 HD	With 5th wheel prep package	16 - 20
Nissan	Titan XD	With 5th wheel prep package	16 - 20
Ram	2500 / 3500	With 5th wheel prep package	13 - 20



GM puck system

QUICK AND EASY DROP-IN INSTALLATION

OEM PUCK SYSTEM GOOSENECK KITS & COMPONENTS



60618
Ram



60638
Ram



60692 & 60639
Chevrolet, Ford, GMC, Nissan



60617 & 60698
Ram



60691
Chevrolet, Ford, GMC, Nissan



60601



60629
& 60627



60628
& 60634



66155



19250
& 19251

Make	GTW / Vertical Load	Ball Size	Rise	Kit#	Ball#	Anchors#	Cover#
30K Kits & Components							
Ram	30,000 / 7,500 lbs.	2-5/16"	1/2"	60618	60601	60617	66155
Chevrolet, Ford, GMC, Nissan	30,000 / 7,500 lbs.	2-5/16"	1-5/8"	60692	60629	60691	66155
Chevrolet, Ford, GMC, Nissan, Ram	30,000 / 7,500 lbs.	2-5/16"	1-5/8"	--	60629	--	--
Chevrolet, Ford, GMC, Nissan, Ram	30,000 / 7,500 lbs.	3"	1-5/8"	--	60628	--	--
38K Kits & Components							
Ram	38,000 / 9,500 lbs.	2-5/16"	1-5/8"	60638	60627	60698	66155
Chevrolet, Ford, GMC, Nissan	38,000 / 9,500 lbs.	2-5/16"	1-5/8"	60639	60627	60691	66155
Chevrolet, Ford, GMC, Nissan, Ram	38,000 / 9,500 lbs.	2-5/16"	1-5/8"	--	60627	--	--
Chevrolet, Ford, GMC, Nissan, Ram	38,000 / 9,500 lbs.	3"	1-5/8"	--	60634	--	--
Replacement Parts							
19250 - Anchor pin & lynch pin, qty 1	Fits Ram anchors (60617, 60698, 60618, 60638)						
19251 - Anchor pin & lynch pin, qty 1	Fits Chevrolet, Ford, GMC, Nissan anchors (60691, 60692, 60639)						

Chevrolet OEM-style hitch

NO ADDITIONAL HARDWARE OR BRACKETS REQUIRED

HITCHES & BRACKETS



OEM-STYLE GOOSENECK HITCHES

OEM-style gooseneck hitches are designed for a unique, vehicle-specific fit. They quickly and securely bolt onto the truck's frame like a factory trailer hitch, with no drilling or installation brackets required.

Streamlined installation



Requires no additional hardware or installation brackets



No drilling necessary except the truck bed holes



Requires no welding, bed flange trimming or bed removal



No lowering of exhaust or spare tire on #60700 and #60633

Product Details

- Center locator eliminates the need to measure where the ball hole should be (#60633, #60642)
- Easy, one-person installation (#60700, #60633)
- Quickly bolts on underneath the truck bed in 45 minutes or less (#60614, #60626)
- Places the ball in front of the rear axle on both short and long-bed models (#60642)
- U-edging provided for a clean finish on the hole cut for the ball (#60642)
- Included patented 2-5/16" ball operates with a simple, 1/4-turn latch-locking system to eliminate the need for a side handle
- Heavy-duty 5/8" safety chain loops for a reliable connection
- Tested for safety in accordance with SAE J2638
- Not compatible with X5 adapters
- Highly durable, rust-resistant, liquid A-coat
- **Not compatible with 5th wheel prep packages**



OEM-STYLE GOOSENECK HITCHES

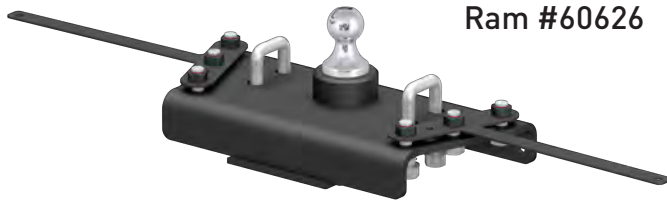

Ram #60626



Ram #60614



Ford #60700



Ram #60633

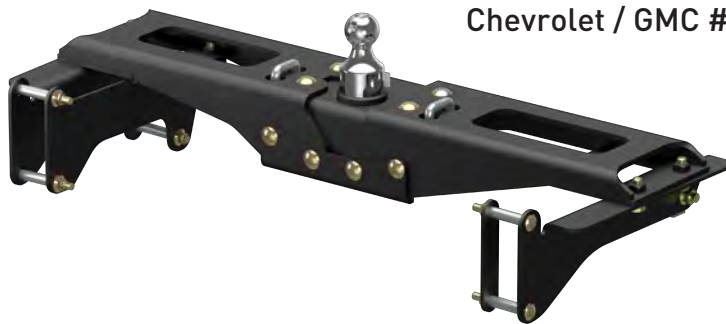

Chevrolet / GMC #60642

OEM-Style Gooseneck Hitches

Make / Model	Style	Years	Part#	GTW / Vertical Load
Chevrolet				
Silverado 2500 HD	--	20 - 21	60642	32,500 / 8,125 lbs.
Silverado 3500 HD	Excluding Cab & Chassis	20 - 21	60642	32,500 / 8,125 lbs.
Ford				
F-250 Super Duty	--	17 - 20	60700	30,000 / 7,500 lbs.
F-350 Super Duty	Excluding Cab & Chassis	17 - 20	60700	30,000 / 7,500 lbs.
F-450 Super Duty	Excluding Cab & Chassis	17 - 20	60700	30,000 / 7,500 lbs.
GMC				
Sierra 2500 HD	--	20 - 21	60642	32,500 / 8,125 lbs.
Sierra 3500 HD	Excluding Cab & Chassis	20 - 21	60642	32,500 / 8,125 lbs.
Ram				
2500	--	19 - 20	60633	35,000 / 8,750 lbs.
		14 - 18	60614	30,000 / 7,500 lbs.
3500	Excluding Cab & Chassis	19 - 20	60633	35,000 / 8,750 lbs.
		13 - 18	60626	30,000 / 7,500 lbs.

Replacement Parts

Replacement OEM-style ball	See page 231 for size options
Replacement rubber hole cover	66155

Not compatible with 5th wheel prep packages

Quarter-turn gooseneck ball

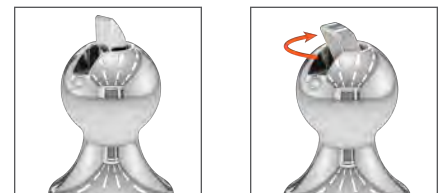

Factory-style gooseneck ball operates with a simple, 1/4-turn latch-locking system



Exclusive Center Locator eliminates measuring where the ball hole should be. Simply drill up from under the truck bed

30k
GTW

DOUBLE LOCK EZr™ GOOSENECK HITCH SYSTEM

Product Details & Operation

- Up to 30,000 lbs. GTW and 7,500 lbs. vertical load
- Weight ratings are limited to vehicle manufacturer's stated capacities
- Includes 2-5/16" ball, 5/8" safety chain loops and grade-8 hardware
- Durable carbide black powder coat finish
- Tested for safety in accordance with SAE J2638



Engage the double locking pins for superior pin strength



Retract the sturdy 3/8" handle and drop the ball into the hole



After towing, flip the ball over to eliminate obstructions



Install the hole cover to protect the ball from the elements

What makes the EZr™ different?

One-person installation



Easy-to-install clips eliminate the need for a second person to hold up the center section while installing the brackets



- Uses carriage bolts when possible for one-wrench tightening
- No need to lower exhaust on Chevrolet, Ford, GMC and most Dodge / Ram models
- No need to relocate cable hanger and ground wire on Dodge / Ram models

No measuring required



Exclusive Center Locator eliminates the need to measure where the ball hole should be. Simply drill up from under the truck bed



- Safety chain loop holes are drilled from the underside of the truck bed
- No welding or truck bed removal required
- Center Locator covered by patent #D685,299 S

How is the EZr™ installed without measuring?



Step 1 - Place Center Locator in the gooseneck hitch ball hole



Step 2 - Bolt the install brackets and hitch to the vehicle frame



Step 3 - Use Center Locator to drill pilot hole up from under bed



Step 4 - Use pilot hole to drill down, no measuring required

If a particular application is not listed below, see page 233 for OEM-style hitches

OR

If a particular application is not listed below, see page 236 for original Double Lock™ hitches

Double Lock EZr™ Gooseneck Hitches

Make / Model	Style	Years	Capacity	EZr™ Kit#	Footnotes	Hitch#	Bracket#
Chevrolet / GMC							
Silverado / Sierra 2500	Excl Cab & Chassis	01 - 04	30,000 lbs.	60681	●	60619	60648
Silverado / Sierra 2500 HD / 3500 HD	Crew cab, 8' bed	20 - 20	25,000 lbs	60687	●	60611	60696
	Excl. Cab & Chassis	11 - 19	30,000 lbs.	60680	●,1	60611	60624
		01 - 10	30,000 lbs.	60681	Z	60619	60648
Silverado / Sierra 2500 HD Classic	Excl Cab & Chassis	07 - 07	30,000 lbs.	60681	●	60619	60648
Silverado / Sierra 3500	Excl Cab & Chassis	01 - 06	30,000 lbs.	60681	●	60619	60648
Silverado / Sierra 3500 Classic	Excl Cab & Chassis	07 - 07	30,000 lbs.	60681	●	60619	60648
Dodge							
Ram 2500 / 3500	Excl Cab & Chassis	03 - 10	30,000 lbs.	60682	●, 1, 2, 3	60619	60660
Ford							
F-250	--	99 - 99	30,000 lbs.	60685	●	60619	60647
F-250 Super Duty	--	11 - 16	30,000 lbs.	60683	●	60619	60645
		99 - 10	30,000 lbs.	60685	●	60619	60647
F-350 Super Duty	Excl Cab & Chassis	11 - 16	30,000 lbs.	60683	●	60619	60645
		99 - 10	30,000 lbs.	60685	●	60619	60647
Ram							
2500	--	11 - 13	30,000 lbs.	60682	●, 1, 2, 3	60619	60660
3500	Excl Cab & Chassis	11 - 12	30,000 lbs.	60682	●, 1, 2, 3	60619	60660

1. Passenger-side wheel well flange must be bent for frame rail access
2. Check inverted ball clearance with heavy loads on two-wheel drive

3. Exhaust may have to be permanently lowered on power wagon and Mega cab applications
- = No frame drilling required

EZr™ & Original Double Lock™ Replacement Parts

Fig#	Part#	Description	Fits
1	19253	Center locator	EZr™
2	19254	Safety chain U-bolt spring kit - 5/8" U-bolts, qty 2 - U-bolt spring, qty 4 - 5/8" flat washers, qty 8 - 5/8" nylock nuts, qty 4	EZr™
3	19260	Safety chain U-bolt spring kit - 1/2" U-bolts, qty 2 - U-bolt spring, qty 4 - 1/2" flat washers, qty 8 - 1/2" nylock nuts, qty 4	Original
4	19255	Handle assembly - #10 hex flange screw, qty 1 - #10 nylock nut, qty 1 - Handle rod, qty 1 - Handle grip, qty 1	EZr™ & original
5	19256	Chrome trim ring with hardware	EZr™ & original
6	19257	Handle spring with two washers	EZr™ & original
7	19258	Locking pin with hardware	EZr™ & original

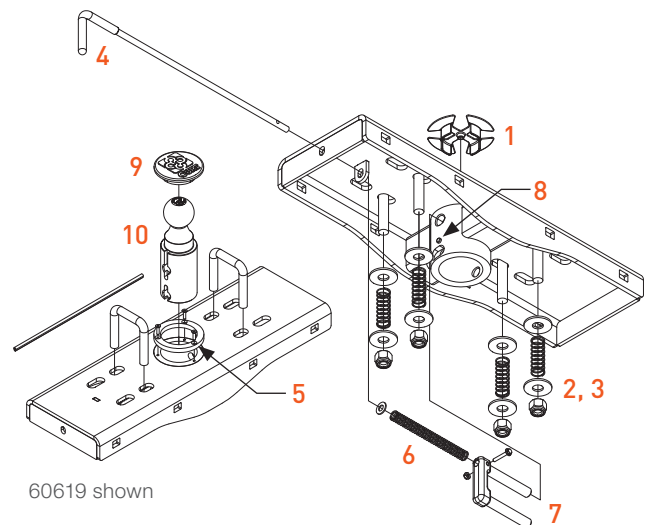

60619 shown

Fig#	Part#	Description	Fits
8	19259	5/16" cylinder guide pin	EZr™ & original
9	66165	Rubber hole cover	EZr™ & original
10	60616	Gooseneck ball, 2-5/16"	EZr™ & original

30K

GTW

ORIGINAL DOUBLE LOCK™ GOOSENECK HITCHES

See page 238 for original
Double Lock application guide

- Double locking pins for superior trailer and trailer ball security
- Flip-and-store ball keeps truck bed free of obstructions
- Installation requires no welding or truck bed removal
- Heavy-duty handle can be positioned on either side of the vehicle
- Rubber hole cover helps prevent corrosion in trailer ball hole
- Includes spring-loaded safety chain loops and grade-8 hardware
- Protected by a highly durable carbide black powder coat finish
- Branded, retail friendly brown box (#60607)



Engage the double locking pins for superior pin strength



Retract the sturdy 3/8" handle and drop the ball into the hole



Chrome trim ring for a clean, professional finish

Part#	Make / Model	Years	Ball Size	Finish	GTW / Vertical Load
60607	Multiple applications for Chevrolet, Ford, GMC, Nissan, Ram See page 238 for full application listing	--	2-5/16"	Carbide black	30,000 / 7,500 lbs.
60615	Chevrolet Silverado 1500 & GMC Sierra 1500	07 - 18	2-5/16"	Carbide black	30,000 / 7,500 lbs.
	Chevrolet Silverado 1500 Legacy & GMC Sierra 1500 Limited	19 - 19			

EZr™ & ORIGINAL DOUBLE LOCK™ GOOSENECK HITCH ACCESSORIES

- 2-5/16" gooseneck balls rated up to 30,000 lbs. GTW and 7,500 lbs. vertical load



60616



60602



60603



66165

Bulk#	Pkg#	Description	For Use With
60616	--	2-5/16" gooseneck replacement ball	EZr™ & original Double Lock™ goosenecks
--	60602	2-5/16" offset ball moves pivot point 4" rearward for added cab clearance	Original Double Lock™ goosenecks only
--	60603	2-5/16" riser ball adds 1" clearance for trucks with plastic or rubber bed liners	Original Double Lock™ goosenecks only
66165	--	Replacement rubber hole cover	EZr™ & original Double Lock™ goosenecks



20K
GTW

X5™ GOOSENECK TO 5TH WHEEL ADAPTER PLATES

The X5 adapter plate allows a gooseneck hitch to become a mounting platform for a 5th wheel hitch. The X5 shank simply drops into the gooseneck ball hole and instantly provides a set of industry-standard 5th wheel base rails. See the table below for gooseneck hitch compatibility.

For more information about mounting a 5th wheel hitch, see page 186.

Product Details

- Converts a gooseneck hitch into a set of standard 5th wheel base rails
- Simple, secure design allows for fast installation and removal as needed
- For use with CURT and competitive 5th wheels up to 20,000 lbs.
- Capacity limited to lowest-rated towing component
- Accepts any standard CURT 5th wheel legs or roller (excludes OEM puck system)
- Durable carbide black powder coat finish
- Co-cured in a rust-resistant liquid A-coat
- **Not compatible with OEM-style gooseneck hitches**
- **Not compatible with Sidewinder™ pin boxes**
(Trademark of Horizon Global™)

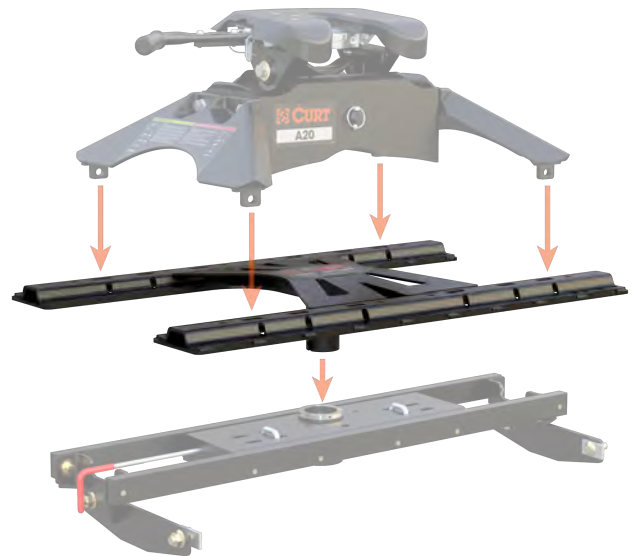

16210 - Fits CURT original Double Lock™



16220 - Fits CURT Double Lock EZr™



16310 - Fits B&W Turnoverball®

Part#	Fits	Capacity	Shank Style
16210	CURT Double Lock™ 60607 and 60615	20,000 lbs.	Round shank
16220	CURT Double Lock EZr™ 60611 and 60619	20,000 lbs.	Round shank
16310	B&W Turnoverball® gooseneck hitch (does not work with shallow models)	20,000 lbs.	Square shank



On two-wheel-drive trucks, a clearance check must be performed when truck is loaded and unloaded to verify the inverted ball will not interfere with the top of the differential. See footnote 6 for more details.

30k
GTW

ORIGINAL DOUBLE LOCK GOOSENECK HITCHES

Original Double Lock™ Gooseneck Hitches

Make / Model	Style	Years	Footnotes	Kit# (Hitch and Brackets)	Hitch#	Bracket#
Chevrolet						
C/K 1500	--	88 - 99	●	60713	60607	60631
C/K 2500 / C3500	Excluding Cab & Chassis	88 - 00	●	60713	60607	60631
Silverado 1500	--	07 - 18	●	60711	60615	60632
		99 - 06	●, 4	60712	60607	60652
Silverado 1500 Classic	--	07 - 07	●, 4	60712	60607	60652
Silverado 1500 HD	--	01 - 06	●, 4	60712	60607	60652
Silverado 1500 HD Classic	--	07 - 07	●, 4	60712	60607	60652
Silverado 1500 LD	--	19 - 19	●	60711	60615	60632
Silverado 2500	Excluding Cab & Chassis	99 - 04	●, 4	60712	60607	60652
Silverado 2500 HD	Excluding Cab & Chassis	11 - 19	●	60710	60607	60604
		01 - 10	●, 4	60712	60607	60652
Silverado 2500 HD Classic	Excluding Cab & Chassis	07 - 07	●, 4	60712	60607	60652
Silverado 3500	Excluding Cab & Chassis	01 - 06	●, 4	60712	60607	60652
Silverado 3500 Classic	Excluding Cab & Chassis	07 - 07	●, 4	60712	60607	60652
Silverado 3500 HD	Excluding Cab & Chassis	11 - 19	●	60710	60607	60604
		07 - 10	●, 4	60712	60607	60652
Dodge						
Ram 1500	--	09 - 10	●	60730	60607	60657
		02 - 08	●,1,2,6	60733	60607	60659
		94 - 01	●, 6	60734	60607	60635
Ram 2500	Excluding Cab & Chassis	03 - 10	●,1,2,6	60732	60607	60661
		94 - 02	●, 6	60734	60607	60635
Ram 3500	Excluding Cab & Chassis	03 - 10	●,1,2,6	60732	60607	60661
		94 - 02	●, 6	60734	60607	60635
Ford						
F-150	Excluding Police Responder	15 - 20	●	60724	60607	60649
	--	04 - 14	●	60721	60607	60641
		97 - 03	●	60722	60607	60637
		80 - 96	1	60723	60607	60636
F-150 Heritage	--	04 - 04	●	60722	60607	60637
F-250	--	97 - 99	●	60722	60607	60637
	Excluding Cab & Chassis	80 - 98	1	60723	60607	60636
F-250 Super Duty	--	99 - 16	●, 3	60720	60607	60644
F-350	Excluding Cab & Chassis	80 - 98	1	60723	60607	60636
F-350 Super Duty	Excluding Cab & Chassis	99 - 16	●, 3	60720	60607	60644
F-450 Super Duty	Excluding Cab & Chassis	08 - 12	●, 3	60720	60607	60644

All models: Brake, fuel and electrical lines may need to be loosened or repositioned. Heat shield requires modification or removal.

- | | |
|--|---|
| 1. Passenger-side wheel well must be notched for frame rail access | 4. Vacuum canister requires relocation (kit included) |
| 2. Parking brake cable bracket may require relocation | 5. Ball cannot be turned over. Brake lines must be cable-tied (ties included) |
| 3. Exhaust may have to be permanently lowered on 2005 and newer models | 6. Do not invert ball with heavy loads on two-wheel-drive models |
| | ● = No frame drilling required |



Original Double Lock™ Gooseneck Hitches

Make / Model	Style	Years	Footnotes	Kit# (Hitch and Brackets)	Hitch#	Bracket#
GMC						
C/K 1500	--	88 - 99	●	60713	60607	60631
C/K 2500 / C3500	Excluding Cab & Chassis	88 - 00	●	60713	60607	60631
Sierra 1500	--	07 - 18	●	60711	60615	60632
		99 - 06	●, 4	60712	60607	60652
Sierra 1500 Classic	--	07 - 07	●, 4	60712	60607	60652
Sierra 1500 HD	--	01 - 06	●, 4	60712	60607	60652
Sierra 1500 HD Classic	--	07 - 07	●, 4	60712	60607	60652
Sierra 1500 Limited	--	19 - 19	●	60711	60615	60632
Sierra 2500	Excluding Cab & Chassis	99 - 04	●, 4	60712	60607	60652
Sierra 2500 HD	Excluding Cab & Chassis	11 - 19	●	60710	60607	60604
		01 - 10	●, 4	60712	60607	60652
Sierra 2500 HD Classic	Excluding Cab & Chassis	07 - 07	●, 4	60712	60607	60652
Sierra 3500	Excluding Cab & Chassis	01 - 06	●, 4	60712	60607	60652
Sierra 3500 Classic	Excluding Cab & Chassis	07 - 07	●, 4	60712	60607	60652
Sierra 3500 HD	Excluding Cab & Chassis	11 - 19	●	60710	60607	60604
		07 - 10	●, 4	60712	60607	60652
Ram						
1500	Coil springs, excluding Limited	11 - 18	●	60730	60607	60657
1500 Classic	Coil springs	19 - 21	●	60730	60607	60657
2500	--	11 - 13	●,1,2,6	60732	60607	60661
3500	Excluding Cab & Chassis	11 - 12	●,1,2,6	60732	60607	60661
Toyota						
Tundra	6.5' bed	07 - 20	●, 5	60751	60607	60667

All models: Brake, fuel and electrical lines may need to be loosened or repositioned. Heat shield requires modification or removal.

- | | |
|---|--|
| <ul style="list-style-type: none"> 1. Passenger-side wheel well must be notched for frame rail access 2. Parking brake cable bracket may require relocation 3. Exhaust may have to be permanently lowered on 2005 and newer models | <ul style="list-style-type: none"> 4. Vacuum canister requires relocation (kit included) 5. Ball cannot be turned over. Brake lines must be cable-tied (ties included) 6. Do not invert ball with heavy loads on two-wheel-drive models ● = No frame drilling required |
|---|--|

30K

GTW

OVER-BED FOLDING BALL GOOSENECK HITCH

See adjacent page for folding ball application guide

- Folding ball design keeps truck bed free of obstructions
- Stainless steel safety pin and pivot spring prevent binding
- Permanently attached gooseneck ball
- Includes safety chain loops and grade-8 hardware
- Patents: #5,571,270; #5,755,452; #5,435,585



61052

How folding ball works

Open storage cover



Lift T-handle and drop ball



Close cover to store ball



Pkg#	Plate Size	Ball Size	Finish	GTW / Vertical Load
61052	12" x 14"	2-5/16"	Carbide black	30,000 / 7,500 lbs.

30K

GTW

OVER-BED FIXED BALL GOOSENECK HITCHES

See adjacent page for fixed ball application guide

- Reinforcement required to reach max gross trailer weight rating



65500



61100

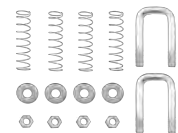

66113

Part#	Description	Plate Size	Ball Size	Finish	GTW / Vertical Load
65500	Flat plate with fixed trailer ball and two 1/2" forged D-rings	13" x 48"	2-5/16"	Carbide black	30,000 / 7,500 lbs.
61100	Flat plate with fixed trailer ball (safety chain hook-ups sold separately)	12" x 12"	2-5/16"	Carbide black	30,000 / 7,500 lbs.
66113	Safety chain U-bolt kit	--	--	--	--

30k
GTW

OVER-BED GOOSENECK APPLICATION GUIDE

- Up to 30,000 lbs. GTW (limited to vehicle capacities)
- Vehicle-specific design optimizes strength and installation time
- Constructed from high-strength, laser-cut steel for a precise fit
- Protected by a rust-resistant liquid A-coat
- Includes grade-8 mounting hardware

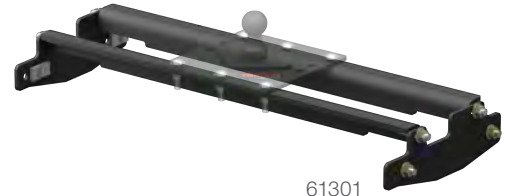

61301

Over-Bed Gooseneck Hitches

Make / Model	Style	Years	Footnotes	Folding Ball Hitch#	Fixed Ball Hitch#	Flat Plate Hitch#	Bracket#
Chevrolet / GMC							
Silverado / Sierra 1500	--	99 - 06	●	61052	61100	65500	61341
Silverado / Sierra 1500 Classic	--	07 - 07	●	61052	61100	65500	61341
Silverado / Sierra 2500	Excluding Cab & Chassis	99 - 04	●	61052	61100	65500	61341
Silverado / Sierra 2500 HD	Excluding Cab & Chassis	11 - 19	●	61052	61100	65500	61301
		01 - 10	●	61052	61100	65500	61341
Silverado / Sierra 2500 HD Classic	Excluding Cab & Chassis	07 - 07	●	61052	61100	65500	61341
Silverado / Sierra 3500	Excluding Cab & Chassis	01 - 06	●	61052	61100	65500	61341
Silverado / Sierra 3500 Classic	Excluding Cab & Chassis	07 - 07	●	61052	61100	65500	61341
Silverado / Sierra 3500 HD	Excluding Cab & Chassis	11 - 19	●	61052	61100	65500	61301
		07 - 10	●	61052	61100	65500	61341
Dodge							
Ram 1500	--	94 - 01	--	61052	61100	65500	61509
Ram 2500	Excluding Cab & Chassis	94 - 02	--	61052	61100	65500	61509
Ram 3500	Excluding Cab & Chassis	94 - 02	--	61052	61100	65500	61509
Ford							
F-250 Super Duty	--	99 - 15	●	61052	61100	65500	61332
F-350 Super Duty	Excluding Cab & Chassis	99 - 15	●	61052	61100	65500	61332
F-450 Super Duty	Excluding Cab & Chassis	08 - 11	●	61052	61100	65500	61332

● = No frame drilling required

UNIVERSAL OVER-BED GOOSENECK BRACKETS

- Universal design fits multiple vehicles and hitches
- High-strength, laser-cut steel
- Includes grade-8 mounting hardware



61502

Part#	GTW	Fit	Finish
61502*	30,000 lbs	Universal	Raw

* Continued while supplies last

WELD-ON GOOSENECK BALL

- High-strength, ready-to-weld steel alloy
- Heat-treated for optimum durability
- Tested to U.S. VESC V-5 specifications



40094

Part#	GTW	Ball Size	Finish
40094	30,000 lbs	2-5/16"	Raw

5TH WHEEL RAIL OPTIONS

5TH WHEEL RAIL GOOSENECK HITCHES

See page 207 to select custom 5th wheel brackets

- Allows pickup trucks equipped with 5th wheel rails to tow gooseneck trailers
- Mounts to all industry-standard 5th wheel rails
- Four-pin installation and removal for easy truck bed access
- #16055 can be positioned over the axle or flipped to provide a 3" rearward offset
- Includes safety chain hookups, pins & clips
- Durable carbide black powder coat finish
- Tested for safety in accordance with SAE J2638
- Branded, retail friendly brown box

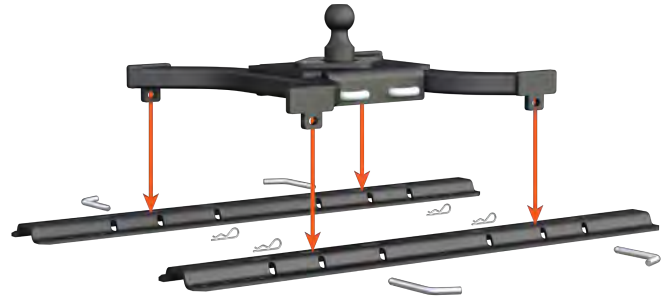

Pkg#	Description	GTW	Ball Size	Finish
16090 N	Spyder™ gooseneck hitch	30,000 lbs.	2-5/16"	Dark grey teridium
16085	Spyder™ gooseneck hitch	25,000 lbs.	2-5/16"	Carbide black
16055	Bent plate gooseneck hitch with 3" offset	25,000 lbs.	2-5/16"	Carbide black
16902	Replacement rail pins & clips	--	--	Yellow zinc



ACCESSORIES & ELECTRICAL

BETTERWEIGH™ MOBILE TOWING SCALE

- Measures real-time vehicle-trailer weights, including pin weight, for safer towing
- No more complicated at-home measurements or trips to the scale
- Bluetooth connection provides active readouts on the driver's smartphone
- No-install, plug-and-play setup into vehicle diagnostic port (OBD-II) below the dash
- Accurate within + / - 5%
- Offers easy brake controller setup by measuring exact trailer brake gain needed
- See page 98 for more information



Scan to see it in action!

Download the app:
BetterWeigh Towing Scale



Pkg#	Description
51701	Mobile towing scale

ACCESSORIES & ELECTRICAL

CUSTOM WIRING EXTENSION HARNESSES

- Routes a 7-way RV blade socket into truck bed while retaining use of rear socket
- Simple plug-and-play design eliminates the need for cutting or splicing
- Neoprene well nuts isolate steel bolts from aluminum surfaces (#57007)
- See page 154 for more information



Right-angle plug for easy installation

7-WAY RV BLADE EXTENSION HARNESS

- Routes existing 7-way RV blade socket into full-size pickup truck bed (7' length)
- Universal size fits any 7-way RV blade socket
- Allows for easy connection of 5th wheel or gooseneck wiring
- See page 155 for more information



REPLACEMENT 7-WAY RV BLADE HARNESSES

- Replaces the trailer-end plug of any 7-way harness
- Wires protected by heavy-duty, weather-resistant cable
- Cold-weather harnesses feature soft thermoplastic elastomer casing to remain flexible in cold temperatures (temperature rating from -40°F up to 221°F)
- See page 155 for more information



BRAKE CONTROLLERS

- Easily calibrated for all towing needs
- Proportional and time-delay units available
- Compatible with anti-lock brakes and cruise control
- See page 138 for our complete brake controller line

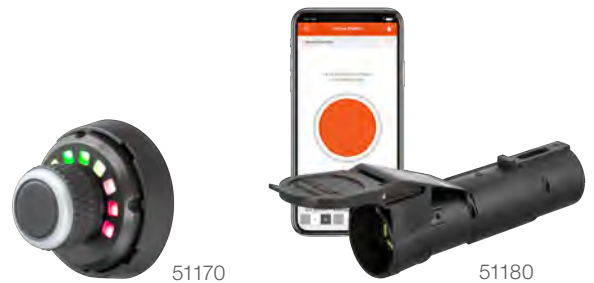

Name	Pkg#	Six-Pack#	Repl. Bracket#	Axles	Brakes	Activation Method	Display	Vertical Mount Angle	Level Adjust	Warranty
Echo®	51180	--	--	1 - 2	2 - 4	Tri-axis inertia	Phone app	N/A	Auto	Limited lifetime
Spectrum™	51170	--	--	1 - 4	2 - 8	Tri-axis inertia	Tri-color LED	Any	Auto	Limited lifetime
Assure™ N	51160	--	--	1 - 4	2 - 8	Tri-axis inertia	OLED screen	Any	Auto	Limited lifetime
TriFlex™	51140	51142	51144	1 - 4	2 - 8	Tri-axis inertia	Digital	-20° to +70°	Auto	Limited lifetime
Discovery™	51120	51122	51124	1 - 4	2 - 8	Time-based	Digital	Any	Auto	Limited lifetime
Venturer™	51110	--	51114	1 - 3	2 - 6	Time-based	LED	Any	Auto	Limited lifetime



TRAILER PARTS & ACCESSORIES

TRUST THE TOWING EXPERTS

QuickPin™ no-latch trailer couplers

FEATURED PRODUCTS



NEW

QuickPin™ no-latch couplers

Our revolutionary new trailer coupler offers stress-free coupling. Instead of a traditional latch, it uses a single pin for easy, secure hookup.



NEW

PowerForce™ tongue jack

This electronic trailer jack connects to the vehicle's power system to eliminate difficult hand cranking and RV battery drain.



NEW

EasyDrop™ tongue jack

This unique jack can be raised or lowered using a common power drill. It has an integrated 3/4" nut on top for fast, hassle-free operation.

PRODUCT INDEX



246
Couplers & Accessories



249
Channels & Lunette Rings



251
PowerForce™ & EasyDrop™



252
Jacks & Accessories



255
Hand Winches & Straps



256
Safety Chains & Cables



259
Hooks & Links



262
Wheel Bearing Components



263
Cargo Straps



Scan to learn more

NO-LATCH. HASSLE FREE. ONE-PIN COUPLING.

QUICKPIN™ NO-LATCH STRAIGHT-TONGUE COUPLERS

NEW

- Easier to use than traditional couplers
- Fastens securely with included 1/2" diameter pin and clip
- No adjustments or tightening needed
- Lasso lanyard secures pin to coupler to avoid missing pieces
- Passes SAE-684 performance testing as a class 2 coupler
- Compatible with most existing coupler mounting hole configurations
- Protected by a durable gloss black powder coat finish



25470



25471



25472



Fastens securely with included 1/2" diameter pin and clip (also accepts a 1/2" hitch lock)

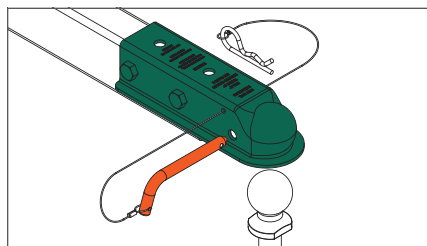

No latch, one-pin coupling is easier to use than traditional couplers

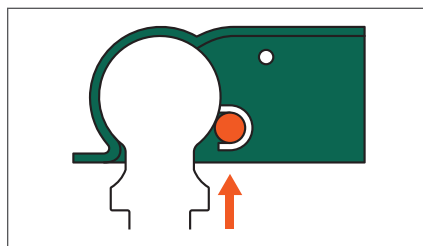

Innovative design allows fast, hassle-free trailer hookup with just one pin

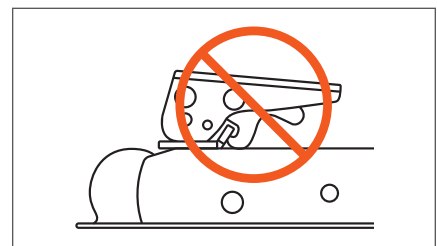

No jamming or complicated hinging components prone to wear

Part#	Class	GTW / TW	Ball Diameter	Channel Width	Finish
25470 N	2	3,500 / 350 lbs.	2"	2"	Gloss black
25471 N	2	3,500 / 350 lbs.	2"	2-1/2"	Gloss black
25472 N	2	3,500 / 350 lbs.	2"	3"	Gloss black

For a selection of coupler locks go to page 120

STRAIGHT-TONGUE & A-FRAME COUPLERS

For a selection of coupler locks go to page 120

- Sleeve-lock latch system for optimum security (#25217, #25227)
- Spring and nut posi-lock mechanism allows for easy adjustment (select models)
- Features holes to accept a safety pin or coupler lock
- Constructed from high-strength steel
- Protected by a durable zinc-plated or gloss black powder coat finish
- Tested for safety in accordance with SAE J684



Spring and nut posi-lock mechanism allows for easy adjustment (select models)



Part#	Class	GTW / TW	Ball Diameter	Latch Style	Channel Width	Finish
Straight-Tongue Couplers						
25105	1	2,000 / 200 lbs.	1-7/8"	Posi-lock	2-1/2"	Zinc-plated
25128	1	2,000 / 200 lbs.	1-7/8"	Posi-lock	2"	Zinc-plated
25131	1	2,000 / 200 lbs.	1-7/8"	Posi-lock	3"	Zinc-plated
25153	2	3,500 / 500 lbs.	2"	Posi-lock	2"	Zinc-plated
25135	2	3,500 / 500 lbs.	2"	Posi-lock	2-1/2"	Zinc-plated
25138	2	3,500 / 500 lbs.	2"	Posi-lock	3"	Zinc-plated
25100	3	5,000 / 700 lbs.	2"	Posi-lock	3"	Zinc-plated
A-Frame Couplers						
25101	3	5,000 / 700 lbs.	2"	Posi-lock	--	Zinc-plated
25210	3	5,000 / 700 lbs.	2"	Posi-lock	--	Gloss black
25217*	4	7,000 / 1,050 lbs.	2"	Sleeve-lock	--	Gloss black
25200	4	10,000 / 1,500 lbs.	2-5/16"	Easy-lock	--	Gloss black
25227*	4	12,500 / 1,875 lbs.	2-5/16"	Sleeve-lock	--	Gloss black
Replacement Part for #25101 and #25210 A-Frame Couplers						
25294	3	5,000 / 700 lbs.	2"	Posi-lock	--	Zinc-plated
Replacement Parts for Straight-Tongue Couplers						
25094	1	2,000 / 200 lbs.	1-7/8"	Posi-lock	--	Zinc-plated
25194	2	3,500 / 500 lbs.	2"	Posi-lock	--	Zinc-plated



* Solid neck for increased strength and greater corrosion resistance

CHANNEL-MOUNT COUPLERS

For a selection of coupler locks go to page 120

- Compatible with CURT channels #48610 and #48650, see page 250
- Secured by a dual-bolt mounting system
- Channel-mount allows for easy height adjustment
- Safety pin hole can also accept a coupler lock
- Constructed from heavy-duty cast steel
- Protected by a durable black powder coat finish



Bulk#	Pkg#	GTW / TW	Ball Diameter	Description
25319*	--	7,000 / 1,050 lbs.	2"	Sleeve-lock coupler
25329*	--	12,500 / 1,875 lbs.	2-5/16"	Sleeve-lock coupler
25330	--	14,000 / 2,100 lbs.	2-5/16"	Easy-lock coupler
25328	--	15,000 / 2,250 lbs.	2-5/16"	Easy-lock coupler
25388	25389	--	--	Bolt kit includes the following grade 8 hardware: two hex bolts (5/8" x 4-3/4"), two nylock nuts (5/8") and four flat washers (5/8")

*Solid neck for increased strength and greater corrosion resistance

SAFETY PINS

- Quickly secures coupler latches, pintle hooks, jack legs or caster wheels
- Square retainer wire clip provides added clearance
- Protected by a durable zinc-plated finish



Bulk#	Pkg#	Pin Diameter	Pin Length	Chain Length
25080	25081	1/4"	2-3/4"	--
25012	25013	1/4"	2-3/4"	12" chain
25010	25011	5/16"	3"	--
25034	25035	5/16"	3"	12" chain
28278	28279	3/8"	2-3/4"	--
28000	28001	3/8"	3"	12" chain



25034 securing a coupler latch



28278 securing a jack foot



SECURELATCH™ FLUSH-MOUNT LUNETTE RING

For pintles and mounts
go to page 125

- Vertically offset base allows ring to be flipped for maximum height adjustment
- Drop-in pin accepts lock to deter theft (turns 90 degrees while coupled)
- Cast iron construction is austempered for superior strength and wear resistance
- Battleship grey finish for excellent exterior durability
- Bright gold zinc-plated pin for long-lasting corrosion resistance



Drop-in pin accepts lock to deter theft (turns 90° while coupled)

Bulk#	Pkg#	Description	GTW	Rings Hole Size	Ring Thickness	Bolt Hole Spacing	Base Size	
--	48661	Lunette ring	60,000 lbs.	2-1/2" I.D.	1-1/2"	4-1/2" center to center	6-1/4" square	
48553	--	Replacement bolt kit includes the following: four hex bolts (3/4"), four nylock nuts (3/4") and four flat washers (3/4")						



SECURELATCH™ CHANNELS & LUNETTE RINGS

Scan to
learn more



- Vertically offset base allows ring to be flipped for maximum height adjustment
- Drop-in pin accepts lock to deter theft (turns 90 degrees while coupled)
- Strong 2-hole bolt pattern fits 3" channel only (#48625)
- Heavy-duty 3-hole bolt pattern fits 2-3/4" channel only (#48626)
- Cast iron construction is austempered for superior strength and wear resistance
- Hardware included with #48641 kit only
- Battleship grey finish for excellent exterior durability (lunette rings only)
- Raw finish for immediate welding (channels only)
- Bright gold zinc-plated pin for long-lasting corrosion resistance



Bulk#	Pkg#	GTW	Number of Positions	Ring Hole Size	Ring Thickness	Vertical Hole Spacing	Channel Width	Channel Height	Description
--	48625	25,000 lbs.	--	3" I.D.	1-1/2"	2" on center	3" I.D.	--	Lunette ring only
--	48626	40,000 lbs.	--	3" I.D.	1-1/2"	2" on center	2-3/4" I.D.	--	Lunette ring only
--	48641	40,000 lbs.	4-position	3" I.D.	1-1/2"	2" on center	2-3/4" I.D.	11-3/4"	Lunette ring and channel
48651	--	--	4-position	--	--	2" on center	2-3/4" I.D.	11-3/4"	Channel fits 48626 only
48610	--	--	3-position	--	--	2" on center	3" I.D.	7-1/2"	Channel only
48650	--	--	5-position	--	--	2" on center	3" I.D.	11-3/4"	Channel only
48552	--	Replacement bolt kit includes the following: three hex bolts (5/8"), three nylock nuts (5/8") and six flat washers (5/8")							

FORGED LUNETTE RINGS

- Single stud eliminates need for a swivel-type pintle hook (#48520, #48530)
- Threaded shank and castle nut for secure attachment to trailer (#48520, #48530)
- Flat design allows drawbar to bolt quickly and easily to a trailer tongue (#48510)
- Constructed from forged steel alloy for superior strength

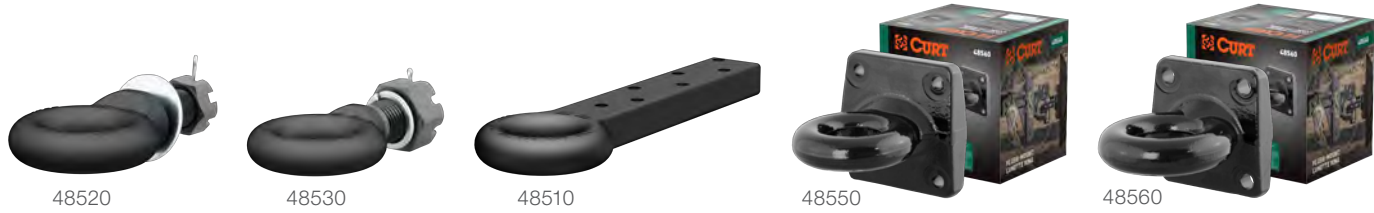

Bulk#	Pkg#	GTW	Mount-Style	Eye Hole Size	Ring Thickness	Finish
48520	--	15,000 lbs.	39mm stud with castle nut	2-1/2" I.D.	1-1/2"	Black
48530	--	45,000 lbs.	48mm stud with castle nut	3" I.D.	1-5/8"	Black
48510	--	22,000 lbs.	3" x 13" x 1-5/8" drawbar with seven-bolt holes	3" I.D.	1-5/8"	Black
--	48550	35,000 lbs.	6" x 6" flush plate with 4-1/2" center to center holes	2-1/2" I.D.	1-1/2"	Black
--	48560	60,000 lbs.	6" x 6" flush plate with 4-1/2" center to center holes	3" I.D.	1-1/2"	Black
48553	--	Replacement bolt kit for 48560 - Includes four 3/4" hex head bolts / four nylock nuts / four flat washers				
48332	--	Replacement bolt kit for 48550 - Includes four 5/8" socket head cap screw / four 5/8" hex nuts / four 5/8" lock washers				

CHANNELS & FORGED LUNETTE RINGS

- Height adjustment allows for precise trailer leveling
- Constructed from forged steel for superior strength (rings only)
- Constructed from one-piece, formed steel (channels only)



Bulk#	Pkg#	GTW	Number of Positions	Eye Hole Size	Bolt Hole Spacing	Channel Width	Channel Height	Description	Finish
48600	--	12,000 lbs.	--	3" I.D.	--	--	--	Forged ring	Raw
48601	--	12,000 lbs.	--	3" I.D.	--	--	--	Forged ring	Gloss black
48660	--	24,000 lbs.	--	3" I.D.	--	--	--	Forged ring	Raw
48631	48630	12,000 lbs.	3-position	3" I.D.	2" on center	3" I.D.	7-1/2"	Forged ring with formed channel	Raw
48610	--	--	3-position	--	2" on center	3" I.D.	7-1/2"	Formed channel	Raw
48650	--	--	5-position	--	2" on center	3" I.D.	11-3/4"	Formed channel	Raw
48640	--	12,000 lbs.	5-position	3" I.D.	2" on center	3" I.D.	11-3/4"	Forged ring with formed channel	Raw
48620	48621	Bolt kit includes the following grade 8 hardware: two hex bolts (5/8" x 5-1/2"), two hex bolts (1/2" x 1-1/2"), two nylock nuts (5/8"), two flat washers (1/2") and four flat washers (5/8")							

POWERFORCE™ ELECTRIC A-FRAME JACK

NEW

- Raises and lowers trailer tongue using vehicle or trailer battery power
- Can be hardwired into trailer or plugged into any vehicle 7-way RV blade
- Three LEDs illuminate the area for easier nighttime setup
- Helical-cut gears reduce noise and improve operating efficiencies
- Enhanced rocker switch for improved durability and ease of operation
- Removable jack foot for increased trailer stability
- Includes emergency hand crank for manual backup
- Patent-pending



28400 - Includes informative, full-color retail packaging



Optional vehicle power connection for no hand cranking or RV battery drain



7-way RV blade inlet underneath the jack hood for convenient harness storage



Integrated hanger bracket keeps safety chains out of the way when not in use

Pkg#	Lift Capacity	Travel	Bracket Ht.	Retracted Ht.	Extended Ht.	Main Body Material	Steel Finish
28400 N	3,500 lbs.	18"	9"	10-5/8"	28-5/8"	UV-resistant black plastic	Gloss black

EASYDROP™ DRILL-OPERATED A-FRAME JACK

NEW

- Fits most cargo, utility and travel trailers
- Includes manual hand crank for backup operation
- Do not use impact drill for operation
- Durable gloss black powder coat finish
- Removable jack foot for increased trailer stability
- Patent #10,463,161



Innovative 3/4" top nut allows jack to be raised or lowered with a power drill



Faster, easier operation with no hand cranking required



28230 - Includes informative, full-color retail packaging

Pkg#	Lift Capacity	Wind	Travel	Bracket Ht.	Handle Type	Retracted Ht.	Extended Ht.	Finish
28230 N	2,000 lbs.	Top	14"	8-1/2"	Straight	9-1/2"	23-1/2"	Gloss black

2

INCH

A-FRAME JACKS

- Top- and side-wind handles easily raise or lower trailer coupler



Designed to be mounted on an A-frame trailer tongue



Can be bolted or welded on (hardware not included)



28204 side-wind



28255 top-wind



28203 top-wind

Bulk#	Pkg#	Lift Capacity	Wind	Travel	Bracket Ht.	Handle Type	Retracted Ht.	Extended Ht.	Finish
28200	--	2,000 lbs.	Top	14-1/4"	8"	Straight	8-1/4"	22-1/2"	Gloss black
28202	28203	2,000 lbs.	Top	14-3/4"	9"	Straight	9-1/4"	24"	Gloss black
28204	--	2,000 lbs.	Side	15"	9"	Straight	9-1/4"	24-1/4"	Gloss black
28250	--	5,000 lbs.	Top	14-1/8"	10-1/2"	Straight	10-3/8"	24-1/2"	Gloss black
28255	--	5,000 lbs.	Top	15"	10-1/2"	Claw	10"	25"	Gloss black

2

INCH

SWIVEL JACKS

- Top- and side-wind handles easily raise or lower trailer coupler



Bracket-mount pull-pin keeps jack securely locked in place

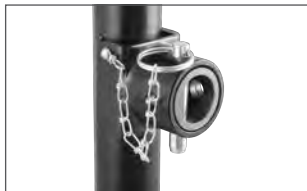

Swivel bracket allows jack to fully swing up and out of the way



28302 bracket-mount



28354 pipe-mount



28351 pipe-mount

Bulk#	Pkg#	Lift Capacity	Wind	Travel	Hole Size	Handle Type	Style	Retracted Ht.	Extended Ht.
28320	--	2,000 lbs.	Top	10-3/4"	9/16"	Claw	Pipe-mount	11"	21-3/4"
28350	28351	5,000 lbs.	Top	10-3/4"	9/16"	Claw	Pipe-mount	11-1/2"	21-1/2"
28356	--	5,000 lbs.	Top	15"	5/8"	Claw	Pipe-mount	16-1/2"	31-1/2"
28322	28323	2,000 lbs.	Top	15"	9/16"	Claw	Pipe-mount	16"	31"
28321	--	2,000 lbs.	Side	10"	9/16"	Straight	Pipe-mount	17-1/2"	28-1/2"
28354	--	5,000 lbs.	Side	10"	5/8"	Straight	Pipe-mount	10-1/4"	20-1/4"
28358	--	5,000 lbs.	Side	15-1/2"	5/8"	Straight	Pipe-mount	15-5/8"	31-1/4"
28324	--	2,000 lbs.	Side	15"	9/16"	Straight	Pipe-mount	15-1/4"	30-1/8"
28300	28301	2,000 lbs.	Top	10-1/2"	--	Claw	Bracket-mount	11-1/2"	21-1/2"
28302	--	2,000 lbs.	Side	10"	--	Straight	Bracket-mount	10"	20-1/2"
28304	--	2,000 lbs.	Top	15-1/4"	--	Claw	Bracket-mount	16"	31-1/4"
28306	--	2,000 lbs.	Side	14-1/2"	--	Straight	Bracket-mount	15-1/2"	30"

2 MARINE JACKS

INCH

- Caster wheel for trailer mobility and easier coupling
- Bolt-on hardware included for secure mounting



Swivel bracket allows jack to fully swing up during travel



Heavy-duty pull-pin locks jack securely in place



28100



28115



28156

Bulk#	Pkg#	Lift Capacity	Wind	Travel	Bracket Ht.	Wheel Size	Retracted Ht.	Extended Ht.	Finish
28100	28101	1,000 lbs.	Side	10-1/2"	12-11/16"	6"	12-5/8"	23-1/4"	Zinc-plated
28112	28113	1,200 lbs.	Side	11"	12-11/16"	6"	12-1/2"	23-1/2"	Zinc-plated
28115	28116	1,500 lbs.	Side	11"	12-11/16"	8"	13"	24"	Zinc-plated
28155	28156	1,500 lbs.	Side	10-3/8"	12-1/2"	Dual 6"	12-5/8"	23"	Zinc-plated

Marine Jack Replacement Parts

Part#	Description	Fits
28910	Bolt-through mounting bracket	All
28911	Bolt-through mounting bars (two) and bolts (four)	All
28912	Caster wheel with bolt and bushing	All
28913	Handle	All
28914	Gear kit with shear pins	All
28926	Handle grip with cap nut	All
28939	Snap ring, 2"	28100, 28101
28940	Mounting bracket pull-pin, 1/2"	All

A-Frame Jack Replacement Parts

Part#	Description	Fits
28921	Handle	28200, 28202, 28203, 28250
28925	Plastic top cap	28204
28926	Handle grip with cap nut	28200, 28202, 28203, 28204, 28250
28927	Top-wind handle knob with cap nut	28255
28937	Top-wind handle with hardware	28255

Swivel Jack Replacement Parts

Part#	Description	Fits
28922	Bearing for top-wind jacks	28320, 28350, 28351, 28356, 28322, 28323, 28300, 28301, 28304
28923	Side-wind handle	28321, 28354, 28358, 28324, 28302, 28306
28924	Gear kit with shear pins for side-wind jacks	28321, 28354, 28358, 28324, 28302, 28306
28930	Female pipe weld-on, 9/16" pin hole	28320, 28350, 28351, 28322, 28323, 28321, 28324
28931	Male pipe weld-on, 9/16" pin hole	28320, 28350, 28351, 28322, 28323, 28321, 28324
28932	Male pipe weld-on, 5/8" pin hole	28356, 28354, 28358
28934	9/16" pin with 3-1/2" long chain	28320, 28350, 28351, 28322, 28323, 28321, 28324
28935	5/8" pin with 3-1/2" long chain	28356, 28354, 28358
28938	Mounting bracket	28300, 28301, 28302, 28304, 28306
28926	Handle grip with cap nut	28321, 28354, 28358, 28324, 28302, 28306
28927	Top-wind handle knob with cap nut	28320, 28350, 28351, 28356, 28322, 28323, 28300, 28301, 28304
28937	Top-wind handle (hardware incl.)	28320, 28350, 28351, 28356, 28322, 28323, 28300, 28301, 28304
28939	Snap ring, 2"	28300, 28301, 28302, 28304
28940	Mounting bracket pull-pin, 1/2"	28300, 28302, 28304, 28306

DIRECT-WELD SQUARE JACKS

- Designed to weld directly to the trailer frame
- Drop leg with spring return for fast retraction (#28512)
- Pull-pin keeps jack leg securely locked in place



28512



28570



28575



28359

Part#	Lift Capacity	Support	Wind	Travel	Handle Type	Inner Tube	Retracted Ht.	Extended Ht.	Incl. Jack Foot
28512	10,000 lbs.	12,000 lbs.	Side	12-3/8"	Straight	3-1/2"	28"	40-1/4"	Yes
28570	7,000 lbs.	8,000 lbs.	Top	15-1/4"	Claw	2-1/4"	24-1/4"	39-1/2"	Yes
28575	7,000 lbs.	8,000 lbs.	Side	15"	Straight	2-1/4"	24-3/4"	40-1/8"	Yes
28359	3,000 lbs.	5,000 lbs.	Side	15-1/4"	Straight	2"	24-5/8"	39-7/8"	No

Direct-Weld Square Jack Replacement Parts

Part#	Description	Fits
28950	Gear kit with shear pins	28512
28951	Handle	28512
28952	Cap	28512
28953	Handle clip	28512
28954	Bearing	28512
28955	Pull-pin assembly (3/4" pull-pin, spring, washer and cotter pin)	28512
28956	Threaded lift nut with grease retaining structure	28512
28957	Inner pipes with drop leg, foot and pull-pin	28512
28958	Gear kit with shear pins	28575

Part#	Description	Fits
28959	Side-wind handle with pins and bushings	28575
28960	Side-wind handle with pins, bushings and gears	28575
28961	Cap and screws	28575
28926	Handle grip with cap nut	28575, 28359
28962	Drop leg with foot	28575, 28570
28963	Drop leg foot pin	28575, 28570
28964	Handle kit	28570
28965	Bearing	28570
28927	Top-wind handle knob with cap nut	28570
28937	Top-wind handle (hardware included)	28570

2 JACK ACCESSORIES

- Caster assemblies #28276 and #28277 are not designed as repair parts for marine jacks; use jack repair part number #28912



28270 28271



28273 28272



28275 28274



28277 28276



28278 28279

Bulk#	Pkg#	Description	Capacity	Fits Tube	Height	Wheel Size	Diameter
28270	28271	Jack foot, bolt-on	2,000 lbs.	2"	--	--	--
28272	28273	Jack foot	2,000 lbs.	2"	1-11/16"	--	--
28274	28275	Jack foot	2,000 lbs.	2"	8-1/2"	--	--
28276	28277	Caster assembly with poly wheel	1,200 lbs.	2"	--	6" x 2"	--
28278	28279	Safety pin	--	--	--	--	3/8"

HAND WINCHES

- Constructed from high-strength, cold-forged steel
- Equipped with a locking lever for increased safety
- Strong pinions eliminate gear-to-shaft bonding failures
- Base features slotted screw holes for flexible mounting
- Zinc-plated snap hook for easy, secure hookup



Crank-style winches for boat trailers or hoisting applications



Broached pinion shaft securely engages the pinion gear



Handle with plastic grip cover for easy, comfortable operation



Straps made from 2" wide, no-stretch nylon web



29423



29433



29424



29435



29425



29427



29428



29438



29429

Pkg#	Capacity	Gear Ratio	Hub Diameter	Handle Length	Strap Included
29423	900 lbs.	3.25:1	3/4"	6-1/2"	No
29433	900 lbs.	3.25:1	3/4"	6-1/2"	Yes, 15' (29450)
29424	1,200 lbs.	4.2:1	3/4"	7-1/2"	No
29425	1,400 lbs.	4.2:1	3/4"	7-1/2"	No
29435	1,400 lbs.	4.2:1	3/4"	7-1/2"	Yes, 20' (29451)
29427	1,700 lbs.	5.1:1	1"	8"	No
29428	1,900 lbs.	5.1:1	1"	8"	No
29438	1,900 lbs.	5.1:1	1"	8"	Yes, 20' (29451)
29429	2,100 lbs.	5.1:1	1"	9-3/4"	No

WINCH STRAPS

- Made from 2" wide, no-stretch nylon web
- Zinc-plated snap hook for easy, secure hookup



29007



29450 & 29451

Bulk#	Pkg#	Work Load	Break Strength	Strap Width	Strap Length
29007	--	1,333 lbs.	4,000 lbs.	2"	20'
--	29450	1,100 lbs.	3,300 lbs.	2"	15'
--	29451	1,100 lbs.	3,300 lbs.	2"	20'

BULK CHAIN

- High-test chain for wear and abrasion resistance
- Transport chain for binding applications
- Alloy chain for high work load limits
- All bulk chain is sold by the foot

Bulk#	Break Strength	Link Diameter	Grade	Finish
Proof Coil				
82116	3,200 lbs.	3/16"	30	Zinc-plated
82165	3,700 lbs.	5/0	30	Zinc-plated
82105	5,200 lbs.	1/4"	30	Zinc-plated
82170	7,600 lbs.	8/0	30	Zinc-plated
82110	7,600 lbs.	5/16"	30	Zinc-plated
82115	10,600 lbs.	3/8"	30	Zinc-plated
High-test				
82120	7,800 lbs.	1/4"	43	Zinc-plated
82125	11,700 lbs.	5/16"	43	Zinc-plated
82130	16,200 lbs.	3/8"	43	Zinc-plated
Transport				
82135	12,600 lbs.	1/4"	70	Yellow zinc-plated
82140	18,800 lbs.	5/16"	70	Yellow zinc-plated
82145	26,400 lbs.	3/8"	70	Yellow zinc-plated
82155	45,200 lbs.	1/2"	70	Yellow zinc-plated
Alloy				
82160	72,400 lbs.	5/8"	80	Yellow zinc-plated



PROPER SAFETY CHAIN USAGE

Safety chains are required by law and should be crossed under the tongue of the trailer so that the tongue will not drop to the road if it becomes separated from the hitch. Always leave enough slack so the vehicle can safely turn. Never allow the safety chains to drag on the ground and never attach the chains to the bumper. For chain assemblies built to your exact specifications, contact your CURT sales representative.

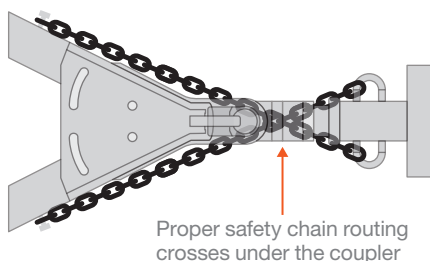

HOW TO ORDER CUSTOM SAFETY CHAIN

- Step 1** - Determine the gross weight of the trailer
Example: 7,000 lbs. GTW
- Step 2** - Select chain required
Example: #82120 zinc-plated (7,800 lbs.)
Note: By law each individual chain must meet or exceed the GTW
- Step 3** - Determine the required length of chain
Note: The chains must be long enough to cross one over the other under the coupling point (see illustration to the left)
- Step 4** - Select hook(s) according to capacity and design
Example: #81900 clevis hook (7,800 lbs.)
- Step 5** - Contact your CURT sales rep for a quote



Federal law requires safety chains or cables to be secured while towing. Each individual chain or cable must meet or exceed the trailer weight.

SAFETY CHAINS WITH S-HOOKS



S-hook



Helps resist total vehicle-trailer separation during a disconnect



Bulk#	Pkg#	Break Strength	Number of Chains	Total Length	Chain Length	Link Diameter	Hooks Per Chain	Hook Opening	Grade	Finish
80020	--	2,000 lbs.	1	27"	23"	3/16"	1 (81260)	3/8"	30	Zinc-plated
80010	80011	2,000 lbs.	1	48"	40"	3/16"	2 (81260)	3/8"	30	Zinc-plated
80040	--	5,000 lbs.	1	27"	23"	1/4"	1 (81270)	7/16"	30	Zinc-plated
80030	80031	5,000 lbs.	1	48"	40"	1/4"	2 (81270)	7/16"	30	Zinc-plated
80300	--	7,000 lbs.	1	27"	23"	8/0	1 (81620)	17/32"	30	Zinc-plated
80301	--	7,000 lbs.	1	48"	40"	8/0	2 (81620)	17/32"	30	Zinc-plated

SAFETY CHAINS WITH SNAP HOOKS

- Spring-loaded safety latch helps ensure secure attachment
- Protected by a durable zinc-plated finish
- Vinyl coating protects chains from rust and allows for easier handling (#19749)



Snap hook



Helps resist total vehicle-trailer separation during a disconnect

Bulk#	Pkg#	Break Strength	Number of Chains	Total Length	Chain Length	Link Diameter	Hooks Per Chain	Hook Opening	Grade	Finish
80312	--	2,000 lbs.	1	27"	24"	3/16"	1 (81266)	3/8"	30	Zinc-plated
80313	--	5,000 lbs.	1	27"	24"	1/4"	1 (81277)	7/16"	30	Zinc-plated
--	19749	5,000 lbs.	2	65"	60"	1/4"	2 (81260)	7/16"	30	Zinc-plated with rubber coating



Federal law requires safety chains or cables to be secured while towing. Each individual chain or cable must meet or exceed the trailer weight.

SAFETY CABLES WITH SAFETY LATCH HOOKS

- Coiled design keeps cables from dragging on the ground
- Nylon coating protects cables from rust and allows for easier handling
- Assembled with two safety latch hooks for secure attachment



Safety latch S-hook



Helps resist total vehicle-trailer separation during a disconnect



80136



80151



80176

Pkg#	Break Strength	Number of Cables	Total Length	Cable Length	Cable Diameter	Hooks Per Cable	Hook Opening	Cable Finish	Hook Finish
80136	3,500 lbs.	2	43-7/8"	40-1/2"	1/4"	2 (81810)	3/8"	Nylon-coated	Zinc-plated
80151	5,000 lbs.	2	44-1/2"	40-1/2"	5/16"	2 (81820)	7/16"	Nylon-coated	Zinc-plated
80176	7,500 lbs.	2	44"	39-3/4"	3/8"	2 (81830)	17/32"	Nylon-coated	Zinc-plated

SAFETY CHAINS WITH SAFETY LATCH CLEVIS HOOKS

- Exclusive clevis design and spring-loaded safety latch help ensure secure attachment
- Hooks constructed from high-strength, heat-treated, forged steel
- Protected by a durable zinc-plated finish



Zinc-plated



Yellow zinc-plated



Safety latch clevis hooks



Helps resist total vehicle-trailer separation during a disconnect

Part#	Break Strength	Number of Chains	Total Length	Chain Length	Link Diameter	Hooks Per Chain	Hook Opening	Grade	Chain Finish	Hook Finish
80302	7,800 lbs.	1	35"	32"	1/4"	1 (81900)	1/4"	43	Zinc-plated	Yellow zinc-plated
80314	11,700 lbs.	1	35"	32"	5/16"	1 (81550)	5/16"	43	Zinc-plated	Yellow zinc-plated
80303	12,600 lbs.	1	35"	32"	1/4"	1 (81940)	1/4"	70	Yellow zinc-plated	Yellow zinc-plated
80315	16,200 lbs.	1	35"	31"	3/8"	1 (81560)	3/8"	43	Zinc-plated	Yellow zinc-plated
80304	18,800 lbs.	1	35"	32"	5/16"	1 (81950)	5/16"	70	Yellow zinc-plated	Yellow zinc-plated
80316	24,000 lbs.	1	35"	31"	3/8"	1 (81960)	3/8"	70	Yellow zinc-plated	Yellow zinc-plated

TRAILER SAFETY CHAIN HOLDER BRACKET

- Requires 1-1/8" clearance on the shank between receiver collar and accessory
- Hooks maintain proper safety chain function for trailer disconnect

Pkg#	Clamps Onto	Includes	Finish
45806 N	2" shanks	Hardware	Zinc-plated



Provides intermediate hangers to keep safety chains off the ground

TRANSPORT BINDER SAFETY CHAINS

- Grade-70 rating for superior tensile strength and abrasion resistance
- Assembled with two clevis grab hooks for secure attachment
- Protected by a durable yellow zinc-plated finish
- Do not exceed work load limit



Designed for tying down and binding heavy-duty cargo

Part#	Work Load	Break Strength	Total Length	Chain Length	Link Diameter	Hooks Per Chain	Hook Opening	Grade	Finish
80305	4,700 lbs.	18,800 lbs.	14'	162"	5/16"	2 (81503)	5/16"	70	Yellow zinc
80306	4,700 lbs.	18,800 lbs.	16'	186"	5/16"	2 (81503)	5/16"	70	Yellow zinc
80307	4,700 lbs.	18,800 lbs.	20'	234"	5/16"	2 (81503)	5/16"	70	Yellow zinc
80308	4,700 lbs.	18,800 lbs.	25'	294"	5/16"	2 (81503)	5/16"	70	Yellow zinc
80309	6,600 lbs.	26,400 lbs.	14'	162"	3/8"	2 (81438)	3/8"	70	Yellow zinc
80310	6,600 lbs.	26,400 lbs.	16'	186"	3/8"	2 (81438)	3/8"	70	Yellow zinc
80311	6,600 lbs.	26,400 lbs.	20'	234"	3/8"	2 (81438)	3/8"	70	Yellow zinc

CLEVIS GRAB HOOKS

- Meets requirements for high-test chain
- Can also be used to connect safety chains from trailer to tow vehicle
- Constructed from high-strength, forged steel
- Protected by a durable zinc-plated finish



Part#	GTW	Hook Opening	Grade	Pin Diameter	Finish
81330	2,600 lbs.	1/4"	43	3/8"	Zinc-plated
81502	3,150 lbs.	1/4"	70	3/8"	Yellow zinc-plated
81340	3,900 lbs.	5/16"	43	7/16"	Zinc-plated
81503	4,700 lbs.	5/16"	70	7/16"	Yellow zinc-plated
81350	5,400 lbs.	3/8"	43	1/2"	Zinc-plated
81438	6,600 lbs.	3/8"	70	1/2"	Yellow zinc-plated

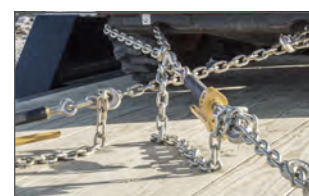

Used on transport binder safety chain to tie down heavy cargo



Federal law requires safety chains or cables to be secured while towing. Each individual chain or cable must meet or exceed the trailer weight.

SAFETY LATCH CLEVIS HOOKS

- Quickly and easily connects safety chains from trailer to tow vehicle
- Exclusive design and spring-loaded safety latch help ensure secure attachment
- Meets requirements for high-test, transport and alloy chain
- Hook pin and cotter pin provide an easy, secure attachment to safety chain
- Built from high-strength, heat-treated, forged steel
- Protected by a durable yellow zinc-plated finish

Part#	GTW	Hook Opening	Grade	Pin Diameter
Clevis Hooks				
81900	7,800 lbs.	1/2"	43	1/4"
81940	12,600 lbs.	1/2"	70	1/4"
81550	14,000 lbs.	3/4"	43	5/16"
81950	18,000 lbs.	3/4"	70	5/16"
81560	18,000 lbs.	1"	43	3/8"
81960	24,000 lbs.	1"	70	3/8"
81970	40,000 lbs.	1-1/3"	80	7/16"
81910	35,000 lbs.	1-1/4"	43	1/2"
81980	48,000 lbs.	1-1/4"	80	1/2"
81920	65,000 lbs.	1-1/4"	80	5/8"
Replacement Latch				
81999	Fits 81950 and 81960			



CERTIFIED S-HOOKS

- Quickly and easily connects safety chains from trailer to tow vehicle
- Tested for safety in accordance with SAE J684
- Wire safety latch helps ensure secure attachment
- Strong, heat-treated steel with a zinc-plated finish

Part#	GTW	Hook Opening	Safety Latch
81260	2,000 lbs.	3/8"	No
81810	2,000 lbs.	3/8"	Yes
81640	3,500 lbs.	13/32"	No
81840	3,500 lbs.	13/32"	Yes
81270	5,000 lbs.	7/16"	No
81820	5,000 lbs.	7/16"	Yes
81620	7,600 lbs.	17/32"	No
81830	7,600 lbs.	17/32"	Yes



TRAILER SAFETY CHAIN HOLDER BRACKET

- Quickly and easily connects safety chains from trailer to tow vehicle
- Spring-loaded safety latch helps ensure secure attachment
- Patent# 5,664,304

Bulk#	Pkg#	GTW	Diameter
81266	81261	2,000 lbs.	3/8"
81277	81271	5,000 lbs.	7/16"
81288	81281	5,000 lbs.	9/16"
81360	--	3,500 lbs.	5/8" eye



QUICK LINKS

- Provides a quick connection for chains, cables, ropes or straps
- Threaded link ensures secure attachment with the option to disconnect later
- Requires no tools for installation
- Do not exceed work load limit



Bulk#	Pkg#	Two-Pack#	Work Load	Diameter	Finish
82610	82611	--	880 lbs.	1/4"	Zinc
82900	82901	82903	1,760 lbs.	5/16"	Zinc
82930	82933	--	2,200 lbs.	3/8"	Zinc
82931	82934 N	--	2,640 lbs.	7/16"	Zinc
82932	82935 N	--	3,300 lbs.	1/2"	Zinc



JOINING LINKS

- Constructed from 1038 steel
- Do not use for lifting
- Welding required

Part#	Finish	Size
82940	Raw	9/0
82942	Raw	7/16"
82943	Zinc-plated	9/0
82944*	Zinc-plated	7/16"

* Continued while supplies last



WHEEL BEARING KITS

- Automatically maintains the correct internal pressure to avoid seal damage
- Includes two bearing cones, two bearing cups, a grease seal and cotter pin

Pkg#	Spindle O.D.	Kit Includes
23209	3/4"	(2) LM11910, (2) LM11949, seal, cotter pin
23210	1"	(2) L44643, (2) L44610, seal, cotter pin
23211	1-1/16"	(2) L44649, (2) L44610, seal, cotter pin



BEARING PROTECTORS & REPLACEMENT DUST COVERS

- Protects wheel bearings from dirt, water and road grime
- Maintains pressure and keeps bearing greased
- Features a small reservoir to keep bearings well-lubricated
- Covers prevent dust and debris from entering the bearing protector
- Includes two components each



Bearing Protector#	Replacement Cover Two-Pack#	Hub Bore Size
22178	23178	1.78" diameter
22198	23198	1.98" diameter
22232	23232	2.32" diameter
22244	23244	2.44" diameter

WHEEL CHOCK SET

- Raised tread offers a better grip on the wheel
- Saw-tooth edges on the base provide solid traction on the ground
- Always to be used with emergency brake
- Not for commercial use



Adds safety during vehicle maintenance or to parked trailers

Part#	Description
22800	For use with wheels up to 17" wide

CARGO STRAPS

- Cambuckle mechanism allows for quick, direct tension on lighter loads
- Ratchet mechanism allows for greater tension on heavy loads
- High-strength, woven nylon
- Cinching components protected by a durable yellow zinc-plated finish



Perfect for securing cargo in trailers, truck beds and more



Secures cargo better than bungee cords or rope



83036



83047



83048



83015



83016



83001



83002



83009



83010



83019



83020



83025



83026



83027



83028

Pkg#	Work Load	Break Strength	Quantity	Color	Length	Width	Hook Style	Hook Finish	Mechanism
83015	300 lbs.	900 lbs.	2	Dark green	15'	1"	S-hook	Rubber-coated	Cambuckle
83016	300 lbs.	900 lbs.	4	Dark green	16'	1"	S-hook	Rubber-coated	Cambuckle
83001	500 lbs.	1,500 lbs.	2	Red	10'	1"	S-hook	Rubber-coated	Ratchet
83002	500 lbs.	1,500 lbs.	4	Red	16'	1"	S-hook	Rubber-coated	Ratchet
83009	500 lbs.	1,500 lbs.	2	Black	10'	1"	S-hook	Rubber-coated	Ratchet
83010	500 lbs.	1,500 lbs.	4	Black	16'	1"	S-hook	Rubber-coated	Ratchet
83019	733 lbs.	2,200 lbs.	1	Blue	16'	1"	J-hook	Rubber-coated	Ratchet
83020	733 lbs.	2,200 lbs.	2	Blue	16'	1"	J-hook	Rubber-coated	Ratchet
83025	1,100 lbs.	3,300 lbs.	1	Orange	16'	1"	J-hook	Rubber-coated	Ratchet
83026	1,100 lbs.	3,300 lbs.	2	Orange	16'	1"	J-hook	Rubber-coated	Ratchet
83027	1,100 lbs.	3,300 lbs.	1	Lime green	16'	1"	S-hook	Rubber-coated	Ratchet
83028	1,100 lbs.	3,300 lbs.	2	Lime green	16'	1"	S-hook	Rubber-coated	Ratchet
83036	1,667 lbs.	5,000 lbs.	1	Yellow	14'	1-1/2"	J-hook	Yellow zinc-plated	Ratchet
83047	3,333 lbs.	10,000 lbs.	1	Yellow	27'	2"	J-hook	Yellow zinc-plated	Ratchet
83048	3,333 lbs.	10,000 lbs.	1	Yellow	27'	2"	Flat hook	Yellow zinc-plated	Ratchet



CARGO MANAGEMENT

TRUST THE TOWING EXPERTS

Aluminum tray-style bike rack

FEATURED PRODUCTS



Aluminum tray-style rack

Give your customers a dependable but easy-to-handle option for transporting their bikes. This 4-bike rack weighs only 45 lbs.



Seat Defender™

Don't just cover up damage; stop it before it happens! These removable seat covers install quickly, as-needed and are machine-washable.



Aluminum cargo carriers

Available with or without a ramp, CURT aluminum cargo carriers are lightweight and hitch-mounted for convenient use as needed.

PRODUCT INDEX



266
Tray-Style
Bike Racks



269
Hitch-Mounted
Bike Racks



270
Clamp-on
Bike Rack



270
Bike Rack
Accessories



272
Seat Defender™
Seat Covers



274
Hitch-Mounted
Cargo Carriers



278
Roof Rack
Accessories



280
Cargo
Bags & Nets



281
Cargo
Straps



282
Extenders
& Adapters



283
Specialty
Mounts



284
Rings & Tie-
Down Anchors

ALUMINUM TRAY-STYLE HITCH-MOUNTED BIKE RACK

NEW

- Padded arms and tray-style cradles keep bikes fully secure with 3 contact points
- Highly adjustable to fit various bike sizes and styles, including e-bikes
- Fits 20" to 29" diameter tires, including road tires and fat tires up to 4" wide
- Padded arms and wheel straps protect bikes from nicks and scratches
- Shank with integrated anti-rattle and lock provides a secure, quiet ride
- Safety trigger latch in handle eliminates unintended release
- Keyed-alike arm, safety cable and shank locks for convenient access
- Aluminum-steel construction only weighs only 45 lbs.
- Quick, easy 8-bolt assembly
- Tilts away for convenient rear vehicle access
- Durable anodized black powder coat finish
- **Do not install on a trailer or other towed vehicle**



18088



Ratcheting arms nest below tray for more compact storage



Integrated safety cable to secure bikes – keyed alike with anti-rattle



Molded cradles designed to accommodate different bike tire diameters

Pkg#	Number of Bikes	Max Load	Shank Size	Fits Wheel Diameter	Fits Tire Width
Bike Rack					
18088 N	Up to 2	130 lbs.	2" x 2"	20" to 29"	Up to 4"
Replacement Parts					
19264	Wheel cradle, qty 1				
19265	Tire strap, qty 1				
19266	Keys, qty 2				
19267	Tray end-caps, qty 4				



1 1/4
INCH & **2**
INCH

STEEL TRAY-STYLE HITCH-MOUNTED BIKE RACKS

- Tray-style cradles provide three points of contact to keep bikes fully secure
- Key-operated ratchets also deter theft while the vehicle is left unattended
- Tray-style design allows for easy loading and unloading of bikes
- Threaded anti-wobble shank helps prevent bikes from swaying
- Padded arms protect the bike frames from nicks and scratches
- Adapter sleeve allows mounting on 1-1/4" or 2" receiver tubes (18085 only)
- Removable extension allows for two- or four-bike capacity (18087 only)
- 4-7/8" (inside width) fat-tire cradles available (#18091)
- Protected by a durable black powder coat finish
- **Do not install on a trailer or other towed vehicle**



Ratcheting arms lock down onto the frames and will not loosen



Tilts away for convenient rear vehicle access



Folds up when not in use for compact storage



18091 fat tire cradles replace existing cradles on CURT racks



18085



18087

Part#	Number of Bikes	Max Load	Shank Size	Extendable
Tray-Style Bike Racks				
18085	Up to 2	90 lbs.	1-1/4" x 1-1/4" 2" x 2"	No
18087	Up to 4	180 lbs.	2" x 2"	Yes
Cradles for Fat Tire Bikes				
18091	Includes two cradles	90 lbs.	4-7/8" inside width	

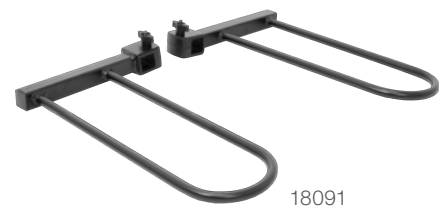

18091

Replacement Parts

Fig#	Part#	Description	Fits
1	19238	Short locking arm	18085, 18087
2	19239	Long locking arm	18085, 18087
3	19240	Right support arm	18085, 18087
4	19241	Left support arm	18085, 18087

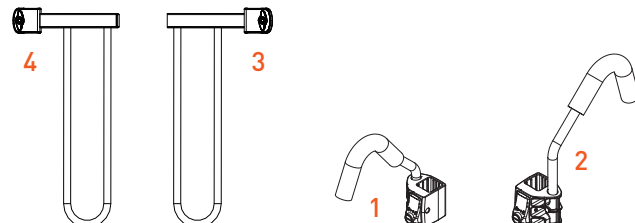

1 1/4
INCH

&

2
INCH

HITCH-MOUNTED BIKE RACKS

All bike racks

- Arms fold down when not in use for compact storage
- Threaded anti-wobble shank prevents bikes from swaying during travel
- Protected by a durable black powder coat finish
- **Do not install on a trailer or other towed vehicle**

Premium

- Available in 2" shank only
- Built-in reflectors for added safety
- Tapered arms accommodate multiple bike sizes

Standard

- Bolt-together post can be taken apart for compact storage
- Compact package makes part numbers retail-friendly
- Adapter sleeve allows mounting on 1-1/4" or 2" receiver tubes
- Support strap included



Adjustable rubber cradles will not scratch bike frames



Tilts away for convenient rear vehicle access

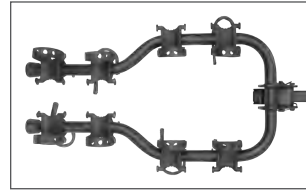

Tapered arms accommodate multiple bike sizes (premium only)



18030 only

Bolt-on extension arms allow for two- or four-bike capacity



18064



18065



18029



18030

Pkg#	Number of Bikes	Max Bike Capacity	Shank Size	Towable Shank	Extendable
Premium Hitch-Mounted Bike Racks					
18064	Up to 4	180 lbs.	2" x 2"	Compatible	No
18065	Up to 5	225 lbs.	2" x 2"	Not compatible	No
Hitch-Mounted Bike Racks					
18029	Up to 2	90 lbs.	1-1/4" x 1-1/4" 2" x 2"	Compatible	No
18030	Up to 4 (with extensions)	90 lbs. without extensions 180 lbs. with extensions	1-1/4" x 1-1/4" 2" x 2"	Compatible	Yes

Replacement Straps

Part#	Description	Fits
18007	Rubber cradle straps, qty 2	All premium and hitch-mounted bike racks

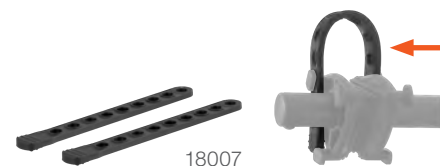

18007

2

INCH

CLAMP-ON BIKE RACK

- Clamps onto any 2" x 2" ball mount shank (ball mount not included)
- Adjustable rubber cradles will not scratch bike frames
- Easily accessible release handle allows for fast installation and removal
- Folding arms for compact storage
- Safety latch helps prevent pinching and collapse when removing from shank
- Protected by a durable black powder coat finish
- Includes support straps
- **Do not install on a trailer or other towed vehicle**



Clamps onto any 2" accessory shank (not included)



Adjustable rubber cradles will not scratch bike frames



Easily accessible release handle allows for fast install and removal



Built-in reflectors provide added visibility for safety

Pkg#	Clamp Size	Number of Bikes	Max Load
18013	2" x 2"	Up to 3	135 lbs.

BIKE BEAM

- Allows bike with angled frame to be used on bike rack
- Extends from 22-1/2" to 31" to accommodate multiple bike sizes
- Made with high-strength steel construction

Pkg#	Length	Finish
18016	Extends from 22-1/2" to 31"	Black



Allows bike with angled frame to be used on bike rack



BIKE RACK SUPPORT STRAP

- Vinyl-coated hook prevents scratches to paint
- Required for all 1-1/4" hitch-mounted bike racks (Recommended for all hitch-mounted bike racks)
- Failure to use a support strap with a 1-1/4" bike rack may void the warranty of the trailer hitch and bike rack

Pkg#	Dimensions
18050	1" wide by 61" long



Adds stability and support for a hitch-mounted bike rack



MULTI-USE CABLE LOCK

- Features versatile locking and cinching capabilities
- 6' length allows for great use as a bike lock
- Includes two keys for added convenience

Pkg#	Length	Cable	Finish
23666	6'	3/8" diameter	Vinyl-coated, braided steel



Secures bike racks and cargo to deter theft



23666

ANTI-RATTLE HITCH CLAMPS & PINS

Clamp-style

- Stops rattling and prevents shank movement
- Compatible with hollow and solid shank accessories
- No-tool installation and easy-to-adjust clamp lever
- Lightweight aluminum and high-strength steel
- Durable, clear finish for corrosion resistance

Pin-style

- Stops rattling and prevents shank movement
- Compatible with hollow shank accessories
- Protected by a durable yellow zinc-plated finish



22325



22320



22315



22321



22323



Stops rattling and prevents shank movement for hollow and solid shanks (clamp-style)



No-tool installation and easy-to-adjust clamp lever (clamp-style)

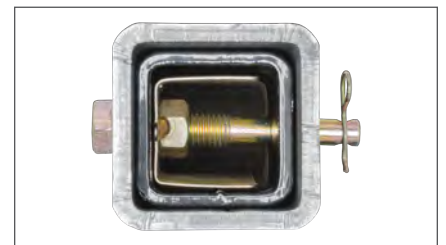

Insert into hollow-shanks (pin-style) to prevent sway and stop rattling (pin-style)

Pkg#	Fits Shank Type	Fits Tube Size	Pin Diameter	Clip Attachment	Finish
Clamps					
22325 N	Hollow or solid	2" x 2"	--	--	Clear
22320 N	Hollow or solid	2-1/2" x 2-1/2"	--	--	Clear
Pins					
22315	Hollow only	1-1/4" x 1-1/4"	1/2"	Hole	Yellow zinc-plated
22321	Hollow only	2" x 2"	1/2"	Hole	Yellow zinc-plated
22323 N	Hollow only	2" x 2"	5/8"	Groove	Yellow zinc-plated

SEAT DEFENDER™ REMOVABLE SEAT COVERS

NEW

- Use-as-needed, universal design with dual-sided, non-skid protection
- Fast and easy to install, remove, clean and store
- Thermoplastic rubber grips the seat, providing added comfort and safety
- Woven 600-denier terylene fabric blocks spills, dirt and more
- 100% waterproof and machine washable (air dry only)
- Allows for side airbag deployment
- Maintains seat belt access (bench seat units may interfere with center shoulder strap)
- XL bench seat model is designed to fit larger bench seats in full-size trucks and SUVs
- Cargo area blanket for picnics, sporting events, work under the car and more

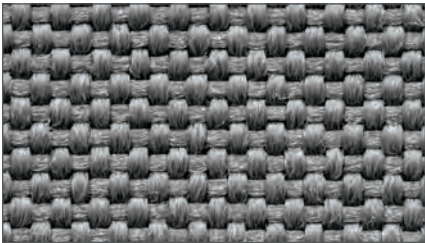

The top layer is a durable, woven 600-denier terylene fabric that keeps spills and dirt out and cleans up easily in the washing machine

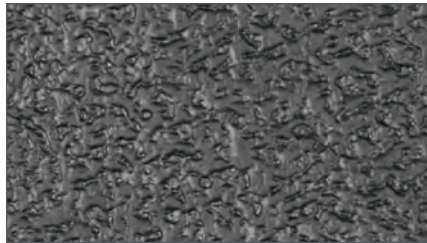

The underside is waterproof thermoplastic rubber that not only protects against spills but also grips the seat for added safety

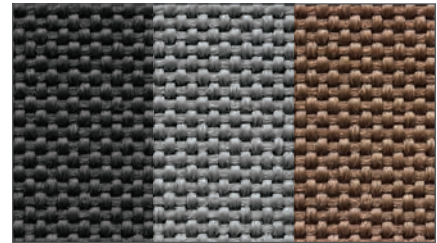

Available in three color options: black, grey and brown

Location	Width	Height	Black#	Grey#	Brown#
Bucket	23"	58"	18501 N	18500 N	18502 N
Bench	55"	58"	18511 N	18510 N	18512 N
XL bench	63"	58"	18521 N	18520 N	18522 N
Cargo area	60"	60"	18530 N	--	--





COMPACT, DOUBLE-FOLDING RAMP

ALUMINUM CARGO CARRIER WITH RAMP

- Three-position ramp can be extended, folded vertically or stowed in the carrier
- Double-folding ramp for ergonomic operation and less wind resistance
- Ramp folds flat into the carrier for compact storage and rear vehicle access
- Threaded anti-rattle shank to resist sway and suppress noise
- Non-skid ridges provide enhanced traction when moving up or down the ramp
- Built-in reflectors add visibility for increased safety
- 8-bolt assembly for fast, easy installation
- Fully welded aluminum construction with durable carbide black powder coat finish



18112



Built-in ramp for easy loading of scooters, push mowers, snow blowers and more



When not in use, carrier folds up for convenient parking and storage



Six integrated eye bolts for secure attachment of straps or other tiedowns

Pkg#	Capacity	Inside Dimensions	Shank Size	Shank	Finish	Material
Cargo Carrier						
18112	500 lbs.	50" (L) x 30-1/2" (W) x 4" (H)	2" x 2"	Folding	Carbide black	Aluminum
Replacement Parts						
19232	Replacement eye-bolt hardware - Includes: four U-clips / six M10 lock nuts / four M10 x 45mm eye-bolts / two M10 x 20mm eye-bolts / two M10 flat washers					
19263	Replacement anti-rattle hitch pin & clip					
19234	Replacement reflectors, qty 2					

ALUMINUM BASKET-STYLE CARGO CARRIER

- One-piece welded aluminum basket with durable carbide black powder coat finish
- Weighs only 25 lbs. for easy moving and handling
- Rated to carry loads up to 500 lbs.
- 4-bolt assembly for fast, easy installation
- Spacious design provides ample room for cargo
- Built-in reflectors add visibility for increased safety
- Mounts onto any 2" x 2" receiver tube opening



18113



4" tall sides help keep cargo more secure



Rated for 500 lbs. but only weighs 25 lbs.



Built-in reflectors for added safety

Pkg#	Capacity	Inside Dimensions	Shank Size	Shank	Finish	Material
Cargo Carrier						
18113	500 lbs.	49" (L) x 22-1/2" (W) x 4" (H)	2" x 2"	Fixed	Carbide black	Aluminum
Replacement Parts						
19233	Replacement eye-bolt hardware - Includes four U-clips / four M10 x 45mm eye-bolts / four M1- lock nuts					
19234	Replacement reflectors, qty 2					

UNIVERSAL ATV CARGO CARRIER

- Universal design fits most ATV cargo racks
- 6" tall sides keep items more secure during travel
- Lightweight for easy installation and use
- Mesh base for easy cleanup
- Heavy-duty, tubular steel with a highly durable E-coat and carbide black powder coat finish
- Includes universal mounting hardware



18101



Quickly and easily installs onto ATV racks



Adds extra space for securing cargo



6" tall sides keep items more secure

Pkg#	Capacity	Finish	Material	Inside Dimensions
18101	Limited to ATV	Carbide black	Steel	41" (L) x 26" (W) x 6-1/4" (H)

1 1/4
INCH

&

2
INCH

TRAY-STYLE CARGO CARRIERS

- Easily bolts together for quick assembly
- Mesh base for easy cleanup
- Features mounting holes for a cargo net or bungees
- #18100 is constructed from lightweight aluminum (shank made from powder-coated steel)
- Protected by a highly durable E-coat and carbide black powder coat finish



Folding design allows carrier to be tilted up when not in use (18100 and 18109 only)



Frees up space inside the vehicle for passengers and cargo

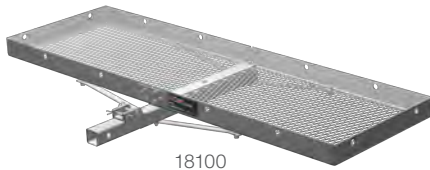

18100

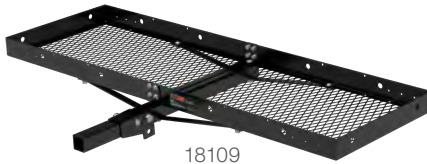

18109



18110

Pkg#	Capacity	Inside Dimensions	Shank	Shank	Finish and Material
18110	300 lbs.	47-3/4" (L) x 19-1/2" (W) x 2-1/2" (H)	1-1/4" x 1-1/4"	Fixed	Carbide black powder coat over steel
			2" x 2" adapter		
18100*	500 lbs.	60" (L) x 19" (W) x 2-3/4" (H)	2" x 2"	Folding	Raw aluminum basket with a powder-coated steel shank
18109*	500 lbs.	60" (L) x 19-1/4" (W) x 2-1/2" (H)	2" x 2"	Folding	Carbide black powder coat over steel

* Rear-mounted spare tire may interfere with the folding feature

AUXILIARY LED INDICATOR LIGHTS

- Auxiliary indicator lights for increased safety on cargo carriers or bike racks
- Double row of LEDs in each strip correspond with brake, turn and running lights
- Industry-standard 4-way flat connector for quick installation
- 3M adhesive backing for secure, convenient mounting
- Durable, waterproof construction for lasting weather resistance



53201



Increases safety on cargo carriers



Versatile, stick-on adhesive backing

Pkg#	Includes
53201	Two LED light strips, adhesive backing and wiring harnesses

1 1/4
INCH

&

2
INCH

BASKET-STYLE CARGO CARRIERS

- Constructed from heavy-duty, tubular steel
- Angled shank elevates carrier for more ground clearance (select models)
- Mesh base for easy cleanup
- Built-in reflectors add visibility for increased safety
- Easily accepts a cargo bag, cargo net or bungees
- Protected by a highly durable E-coat and carbide black powder coat finish



6" tall sides keep items more secure during travel



Frees up space inside the vehicle for passengers and cargo



Folding design allows carrier to be tilted up when not in use (select models)



18150



18151



18145



18152



18153

Pkg#	Capacity	Inside Dimensions	Shank Size	Shank	Finish	Material
18150	500 lbs.	59-1/2" (L) x 20-1/4" (W) x 5-12" (H)	2" x 2"	Fixed	Carbide black	Steel
18151*	500 lbs.	58" (L) x 20" (W) x 5-1/2" (H)	2" x 2"	Folding	Carbide black	Steel
18152	500 lbs.	60" (L) x 24" (W) x 6" (H)	2" x 2"	Fixed	Carbide black	Steel
18153*	500 lbs.	60" (L) x 23-3/4" (W) x 5-1/2" (H)	2" x 2"	Folding	Carbide black	Steel
18145	500 lbs.	46-1/2" (L) x 17-1/2" (W) x 5-1/2" (H)	1-1/4" x 1-1/4" 2" x 2" adapter	Fixed	Carbide black	Steel

* Rear-mounted spare tire may interfere with the folding feature

Replacement Basket Plates

Part#	Description	Fits
19236	Basket assembly plates, qty 2	18150, 18151, 18152, 18153

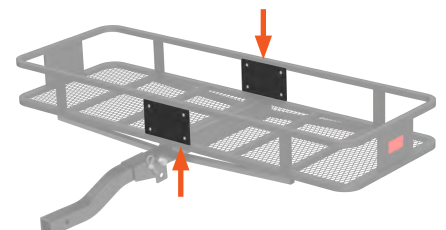

ROOF RACK CARGO CARRIER

- Frees up space inside the vehicle for passengers and cargo
- Mounts to most roof rack base rails
- Lightweight and easy to install with included mounting brackets
- Two-piece design easily bolts together for quick assembly



Mounts to most roof rack base rails and easily accepts a CURT cargo bag or net



Pkg#	Capacity	Inside Dimensions	Storage Area	Finish	Material	Description
Roof Rack Cargo Carrier & Extension						
18115	Limited to vehicle	41-1/2" (L) x 37" (W) x 4" (H)	10-5/8 sq-ft.	E-coat and carbide black	Steel	Roof basket
18117	Limited to vehicle	21" (L) x 37" (W) x 4" (H)	Adds 5-3/8 sq-ft.	E-coat and carbide black	Steel	Extension
Replacement Parts						
19231	Roof rail installation hardware - Includes: four bracket plates / four bracket saddles / nine knobs - four / M6 x 16mm bolts / one M6 x 25mm bolt / four U-bolts					
19242	Fairing installation hardware - Includes: three small clips / three large clips / four M6 x 25mm bolts / three plastic spacers / three M6 x 40mm bolts / six M6 lock nuts					

ROOF RACK CROSSBARS FOR JEEP WRANGLER JK

- Allows mounting of roof accessories for added storage and functionality on 2007 - 2018 Jeep Wrangler JK
- Full-width slotted channels for adjustable positioning of straps, hooks or bolts

NEW



Mounts to most roof rack base rails and easily accepts a CURT cargo bag or net

Part#	Capacity	Length	Width	Height	Fits	Material	Finish
18119 N	150 lbs.	53-3/8"	2-1/8"	7/8" (2" installed)	2007 - 2018 Wrangler JK	Welded steel	Carbide black

UNIVERSAL ROOF RACK CROSSBARS

- Lightweight, powder-coated aluminum
- Adjustable, universal design mounts to roof side rails with up to 50" span
- Integrated rubber strip on top of bars to protect and help secure cargo
- Compatible with CURT roof rack cargo carrier and kayak racks



Rubber-coated, key-operated twist knobs for enhanced security



Adjustable, universal design mounts to roof side rails with up to 50" span



Sleek, oval-shaped crossbars to match the OE style of modern vehicles

Pkg#	Capacity	Length	Width	Height	Includes
18118	150 lbs.	53-3/8"	2-1/8"	7/8" (2" installed)	Two crossbars and mounting hardware

ROOF RACK KAYAK HOLDERS

- Lightweight, powder-coated aluminum
- Notched pivot points for precise positioning and locking
- Universal brackets mount on any roof rack crossbars with no tools required
- Foam padding protects kayaks from scuffs and scratches
- Straps loop around the kayak for secure travel



Rotating arms pivot to fit virtually any size kayak or paddleboard



Foam padding protects kayaks from scuffs and scratches



Arms fold in seconds for convenient, compact storage

Pkg#	Capacity	Includes
Kayak Holders		
18320	75 lbs.	Two holders, straps and mounting hardware
Replacement Part		
19235	--	Replacement tie-down strap

CARGO BAGS

- Keeps cargo protected from water, dirt, wind damage and more
- Made from thick, 500 x 500 denier, UV-resistant vinyl
- Zippers feature large holes to accept a padlock
- Tie-down straps securely attach to cargo carrier frame
- Easily folds up for compact storage



Features welded seams to be highly weather-resistant, helping keep cargo dry



Lockable zipper enclosure with hook-and-loop flap helps keep the inside dry



Fits into CURT roof rack cargo carriers and most CURT hitch cargo carriers



18220



18221



18210 & 18211

Pkg#	Dimensions	Storage	Straps	Description	Yarn Count	Weight	Thickness
18210	56" x 18" x 21"	12.25 cubic feet	6	Cargo carrier bag	500 denier	600 grams per square meter	0.45mm - 0.55mm
18211	56" x 22" x 21"	15.00 cubic feet	6	Cargo carrier bag			
18220	38" x 34" x 18"	13.50 cubic feet	4	Roof rack cargo carrier cargo bag			
18221	59" x 34" x 18"	21 cubic feet	6	Roof rack cargo carrier cargo bag			

CARGO NETS



Elastic netting provides better cargo security compared to bungee cords



Attachment hooks feature holes for easy handling and installation

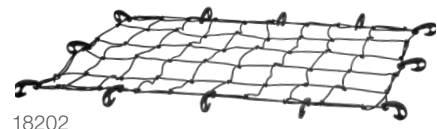

18202

Pkg#	Dimensions	Fits	Includes
18202	43" x 24"	60" wide carriers	Net and storage bag
18200	44" x 38"	Roof rack cargo carrier	Net and storage bag
18201	65" x 38"	Extended roof rack cargo carrier	Net and storage bag



Netted storage bag

CARGO STRAPS

- Cambuckle mechanism allows for quick, direct tension on lighter loads
- Ratchet mechanism allows for greater tension on heavy loads
- High-strength, woven nylon
- Cinching components protected by a durable yellow zinc-plated finish



Perfect for securing cargo in trailers, truck beds and more



Secures cargo better than bungee cords or rope



83036



83047



83048



83015



83016



83001



83002



83009



83010



83019



83020



83025



83026



83027



83028

Pkg#	Work Load	Break Strength	Quantity	Color	Length	Width	Hook Style	Hook Finish	Mechanism
83015	300 lbs.	900 lbs.	2	Dark green	15'	1"	S-hook	Rubber-coated	Cambuckle
83016	300 lbs.	900 lbs.	4	Dark green	16'	1"	S-hook	Rubber-coated	Cambuckle
83001	500 lbs.	1,500 lbs.	2	Red	10'	1"	S-hook	Rubber-coated	Ratchet
83002	500 lbs.	1,500 lbs.	4	Red	16'	1"	S-hook	Rubber-coated	Ratchet
83009	500 lbs.	1,500 lbs.	2	Black	10'	1"	S-hook	Rubber-coated	Ratchet
83010	500 lbs.	1,500 lbs.	4	Black	16'	1"	S-hook	Rubber-coated	Ratchet
83019	733 lbs.	2,200 lbs.	1	Blue	16'	1"	J-hook	Rubber-coated	Ratchet
83020	733 lbs.	2,200 lbs.	2	Blue	16'	1"	J-hook	Rubber-coated	Ratchet
83025	1,100 lbs.	3,300 lbs.	1	Orange	16'	1"	J-hook	Rubber-coated	Ratchet
83026	1,100 lbs.	3,300 lbs.	2	Orange	16'	1"	J-hook	Rubber-coated	Ratchet
83027	1,100 lbs.	3,300 lbs.	1	Lime green	16'	1"	S-hook	Rubber-coated	Ratchet
83028	1,100 lbs.	3,300 lbs.	2	Lime green	16'	1"	S-hook	Rubber-coated	Ratchet
83036	1,667 lbs.	5,000 lbs.	1	Yellow	14'	1-1/2"	J-hook	Yellow zinc-plated	Ratchet
83047	3,333 lbs.	10,000 lbs.	1	Yellow	27'	2"	J-hook	Yellow zinc-plated	Ratchet
83048	3,333 lbs.	10,000 lbs.	1	Yellow	27'	2"	Flat hook	Yellow zinc-plated	Ratchet

2
INCH

&

2½
INCH

&

3
INCH

TRAILER HITCH RECEIVER TUBE ADAPTERS & EXTENDERS

Adapters

- Adapts a receiver tube opening to a different size
- #45048 can be cut down from 34" to 24" and has integrated safety chain loops and electrical bracket
- Protected by a durable black powder coat finish



Extenders

- Solid steel shank for optimum strength
- Protected by a durable black powder coat finish



Adds clearance for a trailer or hitch-mounted accessory (45791)



Moves coupling point farther from the vehicle to avoid obstructions

Measuring adapters and extenders



Length is measured between pin-holes, from center to center

Part#	Adapts From	Adapts To	GTW / TW	Weight Dist. GTW / TW	Length	Finish
Adapters						
45785	1-1/4"	2"	Not for towing use / 350 lbs.	--	6-1/4"	Gloss black
45790	1-1/4"	2"	Not for towing use / 350 lbs.	--	10"	Gloss black
45770	2"	1-1/4"	3,500 / 350 lbs.	--	4"	Gloss black
45775	2"	1-1/4"	3,500 / 350 lbs.	--	9-1/2"	Gloss black
45013	Vertical 2"	Standard 2"	5,000 / 500 lbs.	--	4-1/4"	Gloss black
45048	2-1/2"	2"	4,500 / 450 lbs.	6,000 / 600 lbs.	34"	Gloss black
			6,000 / 600 lbs.	8,000 / 800 lbs.	24"	
Extenders						
45789	--	--	Not for towing use / 350 lbs.	--	7"	Gloss black
45791	--	--	3,500 / 350 lbs.	--	8"	Gloss black
45795	--	--	3,500 / 350 lbs.	--	14"	Gloss black
45796	--	--	3,500 / 350 lbs.	--	18"	Gloss black

2 INCH SPECIALIZED ADAPTERS

- Fits any 2" x 2" receiver tube opening
- Top receiver increases ground clearance for a cargo carrier or other hitch-mounted accessories
- Top receiver not for towing use
- Provides two receiver tubes for multiple accessories, such as a cargo carrier and a ball mount (#45792)
- Ideal for carrying a bike rack while towing a trailer (#45810)



45794



45792



45810



45794 provides added ground clearance



45792 provides two receiver tubes



45810 provides a ball mount and receiver tube to tow a trailer and an additional accessory



Part#	Description	GTW / TW	Drop	Rise	Length	Hole Size	Finish
45794	Raised receiver adapter (only for use in the rise position)	Not for towing use / 350 lbs.	--	4-1/4"	5-1/4"	--	Gloss black
45792	Dual receiver extender with pin & clip	3,500 / 350 lbs.	--	5-13/16"	8"	--	Gloss black
45810	Multi-use ball mount with pin & clip	7,500 / 750 lbs.	2"	5-13/16"	12-1/4"	1"	Gloss black

3 INCH → 2 1/2 INCH → 2 INCH REDUCER SLEEVES

- #45408 set reduces a 3" receiver tube opening to fit a 2" or 2-1/2" shank
- Limited to trailer hitch capacity



45405 - single



45408 - nested set

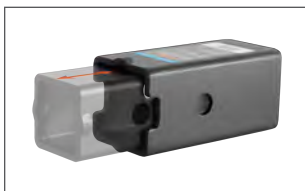

45408 set includes two reducers to fit multiple accessories



Reduces the receiver tube opening to fit smaller shank sizes

Part#	Reduces From	Reduces To	Length	Finish
45405	2-1/2"	2"	5-1/2"	Carbide black
45408	3"	2-1/2"	6-1/4"	Carbide black
	2-1/2"	2"		

How to use a reducer sleeve



RINGS & TIE-DOWN ANCHORS

See adjacent page
for part number table

Recessed rope rings

- Recessed design eliminates obstruction and provides a finished look
- Constructed from high-strength steel
- Mounting screws not included



83601



83710



83600



83740



83742



83732



83730



83731 two-pack

Backing plate

- Adds strength to tie-down anchors
- Constructed from high-strength steel
- Compatible with #83600, #83740 and #83742
- Mounting screws not included

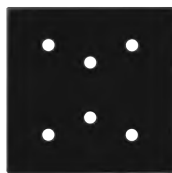

83607



83740 & #83607



83600 & #83607



83720



83710 in 83720

Trim ring

- Provides a clean, finished look for recessed plate #83710
- Helps protect plate edges from damage and corrosion

Lashing rings

- Heavy-duty design with large opening offers a reliable anchoring point
- Raw finish allows for ready welding of mounting bracket
- Constructed from high-strength, forged steel



83750



83760



83770



83780



Adds attachment point to a trailer

RINGS & TIE-DOWN ANCHORS

Part#	Capacity	Break Strength	Finish	Base Size	Mount Hole Size	Mounting Hole Pattern	Ring I.D.	Ring Thickness
Recessed Rope Rings								
83710	1,000 lbs.	1,000 lbs.	Zinc-plated	3-1/2" x 3-1/2"	1/4"	1-3/16"	1-1/8" x 1-5/8"	1/4"
83601	1,200 lbs.	1,200 lbs.	Zinc-plated	5" x 3-1/2"	1/4"	4-1/16" x 1/4"	1-3/8" x 1-7/8"	1/4"
83600	5,000 lbs.	5,000 lbs.	Zinc-plated	4-7/8" x 4-1/2"	3/8"	3-3/8" x 2-7/8"	1-1/2" x 1-1/2"	1/2"
D-Rings								
83730	1,200 lbs.	1,200 lbs.	Zinc-plated	2-1/4" x 13/16"	1/4"	1-1/2"	1" x 1-1/4"	1/4"
83731*	1,200 lbs.	1,200 lbs.	Zinc-plated	2-1/4" x 13/16"	1/4"	1-1/2"	1" x 1-1/4"	1/4"
83732	1,200 lbs.	1,200 lbs.	Stainless	2-1/4" x 13/16"	1/4"	1-1/2"	1" x 1-1/4"	1/4"
83740	3,600 lbs.	11,000 lbs.	Yellow zinc-plated	1-3/4" x 3-11/16" x 7/8"	7/16" square	2"	3" x 3"	1/2"
83742	3,600 lbs.	11,000 lbs.	Zinc-plated	1-3/4" x 3-11/16" x 7/8"	7/16" square	2"	3" x 3"	1/2"
Backing Plate and Trim Ring								
83720	--	--	Plastic	--	--	--	3" x 3"	3/8"
83607	--	--	Gloss black	6" x 6"	7/16"	3" x 3-1/4" (2" center)	--	--
Lashing Rings								
83750	6,100 lbs.	18,000 lbs.	Raw steel	2-1/4" x 1-5/8" x 1-1/4"	--	--	3" x 3"	5/8"
83760	8,833 lbs.	26,500 lbs.	Raw steel	2-1/4" x 1-5/8" x 1-1/4"	--	--	3" x 3"	3/4"
83770	15,587 lbs.	46,760 lbs.	Raw steel	2-1/4" x 2-1/8" x 1-3/4"	--	--	3" x 3"	1"
83780	15,587 lbs.	46,760 lbs.	Raw steel	2-1/4" x 2-1/8" x 1-3/4"	--	--	3" x 4"	1"

* Packaged two-pack

FOLD-AWAY ROPE HOOK

- Fold-away design eliminates obstruction and provides a finished look
- Includes mounting hardware



Folds out as needed and folds away to be unobtrusive



83060 83061

Bulk#	Pkg#	Capacity	Finish
83060	83061	1,200 lbs.	Chrome-plated

WELD-ON STAKE POCKET

- Perfectly sized to accept a 2x4 wood or metal stud
- Raw finish allows for ready welding
- Made in the USA

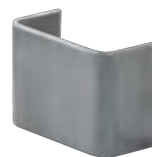

83072

Part#	Finish	Inside Width	Inside Depth
83072	Raw	3-1/2"	1-5/8"



CURTTM

The **FIRST** Name
in **Tr towing Products**TM

MARKETING SUPPORT

ADVANCE YOUR BUSINESS

Displays and point-of-purchase signage

CURT UNIVERSITY

CURT University is a self-service learning tool for CURT products and resources and provides easy access to nearly all of our marketing support materials. It is designed to educate our customers to enhance their sales and grow their business!



Scan or visit
curtmfg.com/university

POINT-OF-PURCHASE

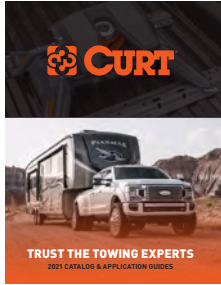

Catalog



Poster



Counter mat



Trailer hitch display stand

Literature & Catalog

- Tri-fold literature focuses on educating the consumer about the advantages of CURT product lines
- Tri-fold: 8-1/2" x 3-1/2" finished size

Banners & Posters

- Bold graphics and clear lifestyle messaging to draw attention to your store
- Various options designed to promote your CURT product offering while educating your customers

Retail Signage

- Window stickers, indoor / outdoor signage and counter mats to help promote CURT products
- Header cards also available

Displays & Signage

- We offer a number of custom-built displays to furnish your store and showcase our products
- Choose from floor and countertop options
- 48" x 8" Lozier-ready header cards also available

PLANOGRAM SUPPORT

In-Store Planograms

CURT offers custom planogram services tailored to your needs. Whether pre-designed or custom, we can help provide a convenient retail solution for your store.

Please contact your sales representative for more information about sizes and options or to discuss custom planogram options.



Contact your sales representative for a complete list of available items and to place your order.

TRAILER HITCHES LISTED NUMERICALLY

Part #	Years	Make	Model
11000	10-14	VOLKSWAGEN	GOLF
11000	10-14	VOLKSWAGEN	GTI
11001	10-16	MERCEDES-BENZ	E350
11002	10-11	HONDA	ACCORD CROSSTOUR
11002	12-15	HONDA	CROSSTOUR
11005	91-92	SATURN	SC
11005	93-02	SATURN	SC1
11005	93-02	SATURN	SC2
11005	91-02	SATURN	SL
11005	91-02	SATURN	SL1
11005	91-02	SATURN	SL2
11005	93-99	SATURN	SW1
11005	93-01	SATURN	SW2
11006	07-12	DODGE	CALIBER
11008	92-96	MITSUBISHI	DIAMANTE
11010	93-99	VOLKSWAGEN	JETTA
11011	97-99	VOLKSWAGEN	CABRIO
11011	93-99	VOLKSWAGEN	GOLF
11012	94-98	MITSUBISHI	GALANT
11013	11-14	CADILLAC	CTS
11014	97-01	HONDA	CR-V
11017	10-12	LEXUS	HS250H
11019	10-13	KIA	FORTE KOUP
11020	08-15	SMART	FORTWO
11022	10-12	SUZUKI	KIZASHI
11023	10-13	ACURA	ZDX
11024	99-04	CHEVROLET	TRACKER
11024	99-05	SUZUKI	GRAND VITARA
11024	96-98	SUZUKI	SIDEKICK
11025	11-14	HYUNDAI	SONATA
11025	11-15	KIA	OPTIMA
11027	95-00	CHRYSLER	CIRRUS
11027	95-06	DODGE	STRATUS
11027	96-00	PLYMOUTH	BREEZE
11028	06-15	MAZDA	MX-5 MIATA
11030	12-13	MERCEDES-BENZ	C250
11030	08-13	MERCEDES-BENZ	C300
11030	08-13	MERCEDES-BENZ	C350
11030	08-13	MERCEDES-BENZ	C63 AMG
11031	07-10	KIA	RONDO
11033	07-08	BMW	328XI
11033	07-08	BMW	335XI
11034	97-04	CHEVROLET	CORVETTE
11036	98-00	CHEVROLET	METRO
11036	95-97	GEO	METRO
11036	95-01	SUZUKI	SWIFT
11037	08-16	AUDI	A5 QUATTRO
11038	95-97	DODGE	NEON
11038	95-97	PLYMOUTH	NEON
11039	00-05	DODGE	NEON
11039	00-01	PLYMOUTH	NEON
11041	94-04	FORD	MUSTANG
11047	10-15	LEXUS	IS250
11048	10-11	FORD	MUSTANG
11051	10-14	HONDA	INSIGHT
11054	98-05	VOLKSWAGEN	PASSAT
11055	11-12	FORD	FIESTA
11057	87-95	JEEP	WRANGLER
11058	07-08	HONDA	FIT
11060	07-11	TOYOTA	YARIS
11061	11-11	FORD	MUSTANG
11064	09-13	HONDA	FIT
11065	11-13	VOLVO	C70
11066	98-10	VOLKSWAGEN	BETLE
11066	99-06	VOLKSWAGEN	GOLF
11066	07-09	VOLKSWAGEN	GOLF CITY
11067	11-19	FORD	FIESTA
11068	09-13	INFINITI	G37
11068	14-14	INFINITI	Q60
11070	99-05	VOLKSWAGEN	JETTA
11073	11-14	MAZDA	2

Part #	Years	Make	Model
11074	06-09	VOLKSWAGEN	GTI
11074	06-09	VOLKSWAGEN	RABBIT
11076	00-05	VOLKSWAGEN	PASSAT
11077	11-16	HONDA	CR-Z
11079	00-02	VOLKSWAGEN	CABRIO
11080	06-11	HYUNDAI	AZERA
11081	07-10	CHRYSLER	SEBRING
11081	08-10	DODGE	AVENGER
11083	01-05	VOLKSWAGEN	JETTA
11085	11-14	ACURA	TSX
11085	08-12	HONDA	ACCORD
11086	10-16	HYUNDAI	GENESIS COUPE
11087	11-13	SCION	TC
11088	11-17	NISSAN	JUKE
11090	07-16	VOLKSWAGEN	EOS
11091	09-17	VOLKSWAGEN	CC
11091	06-10	VOLKSWAGEN	PASSAT
11092	06-11	HYUNDAI	ACCENT
11092	06-11	KIA	RIO5
11094	06-11	HYUNDAI	ACCENT
11094	06-11	KIA	RIO
11096	07-10	VOLKSWAGEN	PASSAT
11103	07-10	JEEP	GRAND CHEROKEE
11105	91-02	FORD	ESCORT
11105	91-99	MERCURY	TRACER
11106	01-04	FORD	ESCAPE
11106	01-04	MAZDA	TRIBUTE
11108	91-94	CHEVROLET	CAVALIER
11109	95-05	CHEVROLET	CAVALIER
11109	95-05	PONTIAC	SUNFIRE
11110	10-13	KIA	SOUL
11111	11-13	INFINITI	M37
11111	11-13	INFINITI	M56
11111	14-19	INFINITI	Q70
11112	08-08	SATURN	ASTRA
11113	95-00	FORD	CONTOUR
11113	95-00	MERCURY	MYSTIQUE
11114	07-09	SATURN	SKY
11115	03-07	SATURN	ION
11117	82-02	CHEVROLET	CAMARO
11117	82-02	PONTIAC	FIREBIRD
11119	06-09	PONTIAC	SCALISTICE
11119	07-10	SATURN	SKY
11120	08-14	SUBARU	IMPREZA
11122	10-13	CHEVROLET	CAMARO
11124	11-13	KIA	FORTE
11126	02-08	MINI	COOPER
11127	12-15	MAZDA	5
11128	98-98	CHEVROLET	TRACKER
11128	89-97	GEO	TRACKER
11128	89-98	SUZUKI	SIDEKICK
11129	89-96	BUICK	CENTURY
11130	07-10	MINI	COOPER
11132	01-10	CHRYSLER	PT CRUISER
11133	11-14	CHRYSLER	200
11133	11-14	DODGE	AVENGER
11134	11-14	SCION	XD
11138	14-17	CHEVROLET	SS
11138	08-09	PONTIAC	G8
11140	06-11	SAAB	9-3
11141	96-05	TOYOTA	RAV4
11143	90-93	ACURA	INTEGRA
11145	92-93	ACURA	INTEGRA
11146	91-97	TOYOTA	PREVIA
11147	94-01	ACURA	INTEGRA
11148	96-00	HYUNDAI	ELANTRA
11150	89-95	MAZDA	MPV
11153	91-95	ACURA	LEGEND
11154	02-04	ACURA	RSX
11155	96-98	ACURA	TL
11158	12-18	FORD	FOCUS

Part #	Years	Make	Model
11159	96-04	ACURA	RL
11160	07-11	MINI	COOPER
11164	02-08	AUDI	A4
11164	02-08	AUDI	A4 QUATTRO
11164	04-08	AUDI	S4
11164	03-04	VOLKSWAGEN	PASSAT
11166	98-04	AUDI	A6
11166	98-04	AUDI	A6 QUATTRO
11166	01-05	AUDI	ALLROAD QUATTRO
11167	92-94	AUDI	100
11167	92-94	AUDI	100 QUATTRO
11167	95-97	AUDI	A6
11167	95-98	AUDI	A6 QUATTRO
11169	96-01	AUDI	A4
11169	96-01	AUDI	A4 QUATTRO
11169	00-02	AUDI	S4
11172	97-98	BMW	528I
11172	97-98	BMW	540I
11174	00-00	BMW	323CI
11174	99-00	BMW	323I
11174	99-99	BMW	323IS
11174	01-05	BMW	325CI
11174	01-05	BMW	325I
11174	01-05	BMW	325XI
11174	00-00	BMW	328CI
11174	99-00	BMW	328I
11174	99-99	BMW	328IS
11174	01-05	BMW	330CI
11174	01-05	BMW	330I
11174	01-05	BMW	330XI
11177	92-98	BMW	318I
11177	92-97	BMW	318IS
11177	98-99	BMW	323I
11177	98-99	BMW	323IS
11177	92-95	BMW	325I
11177	92-95	BMW	325IS
11177	96-99	BMW	328I
11177	96-99	BMW	328IS
11177	95-99	BMW	M3
11178	00-00	BMW	323CI
11178	01-04	BMW	325CI
11178	01-04	BMW	330CI
11179	01-03	BMW	525I
11179	99-00	BMW	528I
11179	91-03	BMW	530I
11179	99-03	BMW	540I
11180	07-08	AUDI	A4 QUATTRO
11181	98-02	CHEVROLET	PRIZM
11181	93-97	GEO	PRIZM
11181	93-02	TOYOTA	COROLLA
11184	11-11	BMW	1 SERIES M
11184	08-11	BMW	128I
11184	08-11	BMW	135I
11185	96-00	CHRYSLER	SEBRING
11186	09-16	AUDI	A4
11186	09-16	AUDI	A4 QUATTRO
11187	95-02	CHRYSLER	SEBRING
11187	95-00	DODGE	AVENGER
11187	01-02	DODGE	STRATUS
11188	10-16	AUDI	A5
11188	08-16	AUDI	A5 QUATTRO
11189	11-13	MERCEDES-BENZ	E350
11190	01-06	CHRYSLER	SEBRING
11191	90-94	EAGLE	TALON
11191	90-94	MITSUBISHI	ECLIPSE
11191	90-94	PLYMOUTH	LASER
11192	06-13	AUDI	A3
11193	95-98	EAGLE	TALON
11193	95-99	MITSUBISHI	ECLIPSE
11194	09-10	BMW	535I XDRIVE
11194	08-08	BMW	535XI

Part #	Years	Make	Model
11195	09-12	AUDI	A4 QUATTRO
11195	13-16	AUDI	ALLROAD
11196	11-15	CADILLAC	CTS
11197	12-16	AUDI	A7 QUATTRO
11198	04-09	HONDA	S2000
11199	04-09	AUDI	A8 QUATTRO
11200	11-17	LEXUS	CT200H
11201	90-93	HONDA	ACCORD
11202	09-14	NISSAN	CUBE
11203	94-97	HONDA	ACCORD
11204	01-05	HONDA	CIVIC
11205	94-97	HONDA	ACCORD
11206	02-04	HONDA	CIVIC
11207	97-00	ACURA	EL
11207	92-00	HONDA	CIVIC
11208	92-01	HONDA	PRELUDE
11209	92-00	HONDA	CIVIC
11210	11-14	FORD	MUSTANG
11211	95-98	HONDA	ODYSSEY
11211	96-99	ISUZU	OASIS
11212	00-03	HONDA	S2000
11214	95-05	HYUNDAI	ACCENT
11215	90-94	HYUNDAI	EXCEL
11215	91-95	HYUNDAI	SCOUPE
11215	90-93	MITSUBISHI	PRECIS
11216	99-01	HYUNDAI	SONATA
11216	01-05	KIA	OPTIMA
11217	89-94	HYUNDAI	SONATA
11218	97-01	HYUNDAI	TIBURON
11219	95-98	HYUNDAI	SONATA
11220	01-06	HYUNDAI	ELANTRA
11221	11-15	CHEVROLET	VOLT
11222	11-15	CHEVROLET	CAMARO
11223	90-91	LEXUS	ES250
11223	86-91	TOYOTA	CAMRY
11223	86-89	TOYOTA	CELICA
11223	89-92	TOYOTA	COROLLA
11223	90-92	TOYOTA	SUPRA
11224	99-02	INFINITI	G20
11225	92-96	LEXUS	ES300
11225	92-96	TOYOTA	CAMRY
11227	89-92	GEO	PRIZM
11227	90-94	LEXUS	LS400
11227	90-99	TOYOTA	CELICA
11227	87-92	TOYOTA	COROLLA
11227	87-90	TOYOTA	TERCEL
11228	01-01	HYUNDAI	XG300
11228	02-05	HYUNDAI	XG350
11232	12-15	VOLKSWAGEN	PASSAT
11233	92-00	LEXUS	SC300
11233	92-00	LEXUS	SC400
11234	12-20	VOLKSWAGEN	PASSAT
11235	91-94	MAZDA	PROTEGE
11237	95-98	MAZDA	PROTEGE
11238	98-05	LEXUS	GS300
11238	98-00	LEXUS	GS400
11238	01-05	LEXUS	GS430
11239	83-92	MAZDA	626
11239	88-92	MAZDA	MX-6
11240	12-20	CHEVROLET	SONIC
11241	93-02	MAZDA	626
11241	93-97	MAZDA	MX-6
11242	98-01	KIA	SEPHIA
11242	00-04	KIA	SPECTRA
11243	92-95	MAZDA	929
11244	97-02	MITSUBISHI	DIAMANTE
11245	92-96	EAGLE	SUMMIT
11245	92-95	MITSUBISHI	EXPO
11245	92-94	MITSUBISHI	EXPO LRV
11245	92-94	PLYMOUTH	COLT
11246	00-05	MITSUBISHI	ECLIPSE
11248	99-03	MITSUBISHI	GALANT
11249	02-03	MAZDA	PROTEGE5
11250	12-17	HYUNDAI	ACCENT
11250	12-17	KIA	RIO
11251	93-01	NISSAN	ALTIMA

Part #	Years	Make	Model
11253	89-94	NISSAN	MAXIMA
11254	12-16	HYUNDAI	VELOSTER
11255	95-96	NISSAN	MAXIMA
11256	12-19	NISSAN	VERSA
11257	91-94	NISSAN	SENTRA
11258	12-16	CHEVROLET	SONIC
11259	95-96	NISSAN	200SX
11259	95-96	NISSAN	SENTRA
11260	12-15	VOLKSWAGEN	BEETLE
11261	97-98	NISSAN	200SX
11261	97-99	NISSAN	SENTRA
11262	12-17	KIA	RIO
11263	00-06	NISSAN	SENTRA
11264	02-06	NISSAN	ALTIMA
11264	04-08	NISSAN	MAXIMA
11265	03-19	TOYOTA	COROLLA
11267	06-08	BMW	750I
11267	06-06	BMW	760I
11270	12-12	VOLKSWAGEN	BEETLE
11272	12-13	MINI	COOPER
11275	87-89	SUBARU	DL
11275	87-89	SUBARU	GL
11275	87-89	SUBARU	GL-10
11275	93-94	SUBARU	IMPREZA
11275	90-94	SUBARU	LEGACY
11275	90-94	SUBARU	LOYALE
11276	10-15	TOYOTA	PRIUS
11276	12-15	TOYOTA	PRIUS PLUG-IN
11276	12-17	TOYOTA	PRIUS V
11277	86-95	SUZUKI	SAMURAI
11278	12-14	CHEVROLET	ORLANDO
11280	03-06	SUBARU	BAJA
11281	13-16	DODGE	DART
11282	12-17	BUICK	VERANO
11282	11-15	CHEVROLET	CRUZE
11283	93-96	TOYOTA	COROLLA
11285	92-95	TOYOTA	PASEO
11286	12-16	SUBARU	IMPREZA
11286	13-15	SUBARU	XV CROSSTREK
11289	00-05	TOYOTA	CELICA
11289	00-05	TOYOTA	ECHO
11290	01-03	ACURA	CL
11290	99-03	ACURA	TL
11290	98-07	HONDA	ACCORD
11291	12-15	SCION	IQ
11292	01-05	KIA	RIO
11293	06-12	MITSUBISHI	ECLIPSE
11294	00-07	FORD	FOCUS
11296	01-07	FORD	FOCUS
11298	01-02	SATURN	L100
11298	01-03	SATURN	L200
11298	01-05	SATURN	L300
11298	00-00	SATURN	LW1
11298	00-00	SATURN	LW2
11298	01-03	SATURN	LW200
11298	01-03	SATURN	LW300
11300	03-03	MAZDA	PROTEGE
11301	04-06	CHEVROLET	AVEO
11302	11-17	NISSAN	JUKE
11303	11-16	HYUNDAI	ELANTRA
11303	13-14	HYUNDAI	ELANTRA COUPE
11304	12-17	HYUNDAI	AZERA
11306	07-11	CHEVROLET	AVEO5
11306	09-10	PONTIAC	G3
11307	03-13	CADILLAC	CTS
11307	05-11	CADILLAC	STS
11308	03-05	MAZDA	6
11310	02-05	HYUNDAI	SONATA
11311	13-19	CADILLAC	ATS
11312	05-08	FORD	MUSTANG
11315	08-11	SUBARU	IMPREZA
11316	13-15	CHEVROLET	SPARK
11317	08-14	SUBARU	IMPREZA
11318	05-06	SAAB	9-2X
11318	93-07	SUBARU	IMPREZA
11319	08-11	FORD	FOCUS

Part #	Years	Make	Model
11320	04-06	SUZUKI	VERONA
11321	04-08	ACURA	TL
11325	06-10	HYUNDAI	SONATA
11326	03-11	SAAB	9-3
11327	03-07	HONDA	ACCORD
11328	13-15	MITSUBISHI	LANCER
11329	06-09	FORD	FUSION
11329	07-09	LINCOLN	MKZ
11329	06-06	LINCOLN	ZEPHYR
11329	06-08	MAZDA	6
11329	06-09	MERCURY	MILAN
11330	05-10	SCION	TC
11331	07-11	CHEVROLET	AVEO
11333	11-16	MINI	COOPER COUNTRYMAN
11334	13-15	CHEVROLET	SPARK
11336	05-12	ACURA	RL
11337	11-13	VOLVO	C30
11338	06-10	MAZDA	5
11339	02-08	JAGUAR	X-TYPE
11340	11-15	MERCEDES-BENZ	E550
11344	06-11	AUDI	A6
11344	05-11	AUDI	A6 QUATTRO
11347	12-18	FIAT	500
11348	07-12	NISSAN	VERSA
11349	13-19	NISSAN	SENTRA
11351	06-08	KIA	MAGENTIS
11351	06-10	KIA	OPTIMA
11352	07-20	NISSAN	ALTIMA
11352	09-20	NISSAN	MAXIMA
11353	06-09	MERCEDES-BENZ	CLK350
11354	12-19	VOLKSWAGEN	BEETLE
11356	14-20	MAZDA	6
11357	08-13	NISSAN	ALTIMA
11359	09-13	MAZDA	6
11362	13-18	LEXUS	ES350
11363	12-19	FIAT	500
11364	14-17	FIAT	500L
11366	18-19	LEXUS	GS300
11366	13-20	LEXUS	GS350
11367	14-16	BMW	228I
11367	15-16	BMW	228I XDRIVE
11367	17-20	BMW	230I
11367	17-20	BMW	230I XDRIVE
11367	13-18	BMW	320I
11367	13-18	BMW	320I XDRIVE
11367	14-18	BMW	328D
11367	14-18	BMW	328D XDRIVE
11367	11-16	BMW	328I
11367	11-16	BMW	328I XDRIVE
11367	17-18	BMW	330I
11367	14-16	BMW	335I GT XDRIVE
11367	13-15	BMW	335I XDRIVE
11367	16-18	BMW	340I
11367	16-18	BMW	340I XDRIVE
11367	14-18	BMW	428I
11367	15-16	BMW	428I GRAN COUPE
11367	14-16	BMW	428I XDRIVE
11367	15-16	BMW	428I XDRIVE GRAN COUPE
11367	17-20	BMW	430I
11367	17-20	BMW	430I GRAN COUPE
11367	17-20	BMW	430I XDRIVE
11367	17-20	BMW	430I XDRIVE GRAN COUPE
11367	14-16	BMW	435I
11367	15-16	BMW	435I GRAN COUPE
11367	14-16	BMW	435I XDRIVE
11367	15-16	BMW	435I XDRIVE GRAN COUPE
11367	17-20	BMW	440I
11367	17-20	BMW	440I GRAN COUPE
11367	17-20	BMW	440I XDRIVE
11367	17-20	BMW	440I XDRIVE GRAN COUPE
11367	17-20	BMW	M240I
11367	17-20	BMW	M240I XDRIVE
11368	14-18	KIA	FORTE
11369	13-16	FORD	FIESTA
11370	07-12	NISSAN	SENTRA
11371	14-15	CHEVROLET	CRUZE

Part #	Years	Make	Model
11372	06-06	LEXUS	GS300
11372	07-11	LEXUS	GS350
11372	06-06	LEXUS	GS430
11372	06-13	LEXUS	IS250
11372	06-12	LEXUS	IS350
11373	14-15	CHEVROLET	CAMARO
11375	14-15	SCION	TC
11376	14-14	MERCEDES-BENZ	SLK250
11377	14-18	MAZDA	3
11378	14-19	NISSAN	VERSA NOTE
11379	13-16	SCION	FR-S
11379	13-20	SUBARU	BRZ
11379	17-20	TOYOTA	86
11380	05-13	CHEVROLET	CORVETTE
11381	11-16	BMW	535I
11381	11-16	BMW	535I XDRIVE
11381	11-16	BMW	550I
11381	11-14	BMW	550I XDRIVE
11382	14-15	CADILLAC	CTS
11383	10-13	MAZDA	3
11386	04-09	MAZDA	3
11387	08-14	MINI	COOPER
11389	16-16	LEXUS	IS200T
11389	14-15	LEXUS	IS250
11389	16-20	LEXUS	IS300
11389	14-20	LEXUS	IS350
11390	10-12	FORD	FUSION
11390	10-12	LINCOLN	MKZ
11390	10-11	MERCURY	MILAN
11391	06-11	ACURA	CSX
11391	13-20	ACURA	ILX
11391	06-15	HONDA	CIVIC
11392	14-16	KIA	FORTE KOUP
11393	10-13	MAZDA	3
11394	14-20	MITSUBISHI	MIRAGE
11395	14-18	KIA	FORTE5
11396	11-17	NISSAN	LEAF
11397	97-99	ACURA	CL
11398	13-16	CHEVROLET	SONIC
11399	15-20	AUDI	A3
11399	15-20	AUDI	A3 QUATTRO
11400	13-17	HYUNDAI	ELANTRA GT
11402	15-19	HYUNDAI	SONATA
11402	16-20	KIA	OPTIMA
11403	15-17	CHRYSLER	200
11404	14-16	MERCEDES-BENZ	E350
11405	15-20	FORD	MUSTANG
11406	15-20	HONDA	FIT
11407	14-20	INFINITI	Q50
11408	12-16	SUBARU	IMPREZA
11408	15-20	SUBARU	WRX
11408	15-20	SUBARU	WRX STI
11410	15-15	VOLKSWAGEN	JETTA
11411	15-15	VOLKSWAGEN	GOLF SPORTWAGEN
11412	15-20	VOLKSWAGEN	GOLF
11412	15-20	VOLKSWAGEN	GTI
11413	16-16	MERCEDES-BENZ	E350
11415	06-11	SAAB	9-3
11416	16-20	HONDA	HR-V
11417	14-15	MINI	COOPER
11418	16-20	MAZDA	CX-3
11419	14-19	KIA	SOUL
11420	16-16	SCION	IM
11420	17-18	TOYOTA	COROLLA IM
11421	16-16	SCION	IA
11421	17-18	TOYOTA	YARIS IA
11422	17-19	VOLKSWAGEN	GOLF ALLTRACK
11422	15-19	VOLKSWAGEN	GOLF SPORTWAGEN
11423	12-16	AUDI	A6
11423	12-16	AUDI	A6 QUATTRO
11424	17-18	HYUNDAI	ELANTRA
11425	15-15	CHEVROLET	CRUZE
11425	16-16	CHEVROLET	CRUZE LIMITED
11427	05-12	TOYOTA	AVALON
11429	07-08	KIA	SPECTRA5

Part #	Years	Make	Model
11430	05-10	CHEVROLET	COBALT
11430	05-06	PONTIAC	PURSUIT
11431	13-18	FORD	FOCUS
11433	16-21	CHEVROLET	SPARK
11434	10-13	KIA	FORTE
11435	16-20	MAZDA	MX-5 MIATA
11436	16-19	CHEVROLET	VOLT
11438	04-11	VOLVO	S40
11438	05-11	VOLVO	V50
11439	16-19	CHEVROLET	CRUZE
11440	02-06	SUZUKI	AERIO
11441	16-19	BUICK	CASCADA
11442	05-08	SUZUKI	RENO
11443	10-13	SUZUKI	SX4
11444	05-06	NISSAN	X-TRAIL
11445	16-17	HONDA	CIVIC
11446	08-13	SUZUKI	SX4
11447	05-10	CHEVROLET	COBALT
11447	06-11	CHEVROLET	HHR
11447	07-09	PONTIAC	G5
11447	05-06	PONTIAC	PURSUIT
11447	04-07	SATURN	ION
11448	17-20	AUDI	A4
11448	17-20	AUDI	A4 ALLROAD
11448	17-20	AUDI	A4 QUATTRO
11448	18-20	AUDI	A5 QUATTRO
11448	18-20	AUDI	A5 SPORTBACK
11448	18-20	AUDI	S5
11448	18-20	AUDI	S5 SPORTBACK
11449	17-20	MITSUBISHI	MIRAGE G4
11450	04-06	KIA	AMANTI
11452	87-96	CHEVROLET	BERETTA
11452	91-96	CHEVROLET	CORSICA
11453	15-17	NISSAN	MICRA
11454	17-19	MERCEDES-BENZ	E300
11454	20-20	MERCEDES-BENZ	E350
11454	17-19	MERCEDES-BENZ	E400
11454	20-20	MERCEDES-BENZ	E450
11455	04-08	ACURA	TSX
11457	17-20	CHEVROLET	BOLT EV
11458	17-19	CHEVROLET	CRUZE
11460	04-06	MITSUBISHI	GALANT
11462	07-12	MITSUBISHI	GALANT
11463	16-18	HONDA	CIVIC
11464	17-20	CHEVROLET	SONIC
11465	17-20	SUBARU	IMPREZA
11466	17-20	SUBARU	IMPREZA
11467	07-10	HYUNDAI	ELANTRA
11468	04-09	TOYOTA	PRIUS
11471	09-12	HYUNDAI	ELANTRA
11472	04-08	MAZDA	RX-8
11473	16-20	TOYOTA	PRIUS
11473	19-20	TOYOTA	PRIUS AWD-E
11473	17-20	TOYOTA	PRIUS PRIME
11474	10-14	VOLKSWAGEN	GOLF
11474	05-18	VOLKSWAGEN	JETTA
11475	17-17	VOLKSWAGEN	GOLF R
11476	02-06	MITSUBISHI	LANCER
11477	03-08	HYUNDAI	TIBURON
11478	17-20	BMW	530I
11478	17-20	BMW	530I XDRIVE
11478	17-20	BMW	540I
11478	17-20	BMW	540I XDRIVE
11479	08-17	MITSUBISHI	LANCER
11480	07-20	TOYOTA	YARIS
11481	04-05	CHEVROLET	OPTRA
11481	04-08	SUZUKI	FORENZA
11482	03-06	INFINITI	G35
11483	03-06	INFINITI	G35
11483	04-05	NISSAN	350Z
11484	12-17	TOYOTA	PRIUS C
11485	15-20	MERCEDES-BENZ	C300
11486	17-20	HYUNDAI	IONIQ
11487	04-06	SCION	XB
11488	05-06	SCION	XA

Part #	Years	Make	Model
11489	16-18	FORD	FOCUS
11490	18-21	TOYOTA	C-HR
11491	08-10	SCION	XD
11492	17-18	CHEVROLET	CRUZE
11493	08-13	INFINITI	G37
11493	14-14	INFINITI	Q60
11493	06-06	NISSAN	350Z
11496	09-14	ACURA	TL
11496	09-14	ACURA	TSX
11496	08-10	HONDA	ACCORD
11497	05-06	SAAB	9-2X
11497	93-07	SUBARU	IMPREZA
11498	04-07	BMW	525I
11498	06-07	BMW	525XI
11498	08-10	BMW	528I
11498	09-10	BMW	528I XDRIVE
11498	08-08	BMW	528XI
11498	04-07	BMW	530I
11498	06-07	BMW	530XI
11498	08-10	BMW	535I
11498	10-10	BMW	535I GT
11498	09-10	BMW	535I XDRIVE
11498	08-08	BMW	535XI
11498	04-05	BMW	545I
11498	06-10	BMW	550I
11498	10-10	BMW	550I GT
11498	10-10	BMW	550I GT XDRIVE
11499	11-12	INFINITI	G25
11499	07-08	INFINITI	G35
11499	09-13	INFINITI	G37
11501	86-88	ACURA	LEGEND
11502	89-90	ACURA	LEGEND
11503	86-89	ACURA	INTEGRA
11504	87-90	ACURA	LEGEND
11507	85-87	AUDI	4000 QUATTRO
11508	78-83	AUDI	5000
11509	18-20	HYUNDAI	ELANTRA GT
11510	08-12	INFINITI	EX35
11510	13-13	INFINITI	EX37
11510	14-17	INFINITI	QX50
11511	89-95	BMW	525I
11511	93-93	BMW	525IT
11511	94-95	BMW	530I
11511	89-93	BMW	535I
11511	94-95	BMW	540I
11512	77-83	BMW	320I
11513	04-05	BMW	645CI
11514	91-93	BMW	325I
11514	91-93	BMW	325IS
11514	91-91	BMW	325IX
11515	78-84	BMW	733I
11515	85-86	BMW	735I
11516	87-92	BMW	735I
11516	88-92	BMW	735IL
11516	93-94	BMW	740I
11516	88-94	BMW	750IL
11517	77-78	BMW	630CSI
11517	78-84	BMW	633CSI
11517	85-89	BMW	635CSI
11520	85-88	DODGE	COLT
11520	85-88	DODGE	COLT
11520	85-88	DODGE	COLT
11521	89-92	MITSUBISHI	MIRAGE
11521	89-92	DODGE	COLT
11521	89-92	MITSUBISHI	MIRAGE
11522	17-20	MINI	COOPER COUNTRYMAN
11523	18-20	TOYOTA	PRIUS C
11524	16-20	MINI	COOPER CLUBMAN
11525	18-20	HONDA	ACCORD
11526	86-88	DODGE	COLT
11526	86-88	DODGE	COLT
11526	86-88	MITSUBISHI	MIRAGE
11527	13-21	BUICK	ENCORE
11527	15-21	CHEVROLET	TRAX
11528	89-91	DODGE	COLT
11528	89-92	EAGLE	SUMMIT
11528	89-92	MITSUBISHI	MIRAGE
11528	89-91	PLYMOUTH	COLT

Part #	Years	Make	Model
11529	18-21	HYUNDAI	KONA
11530	18-20	BMW	X2
11531	90-91	GEO	STORM
11532	91-93	GEO	STORM
11534	85-88	NISSAN	MAXIMA
11534	87-89	NISSAN	STANZA
11535	15-20	ACURA	TLX
11536	85-88	NISSAN	MAXIMA
11537	84-86	NISSAN	200SX
11539	89-94	NISSAN	240SX
11540	19-20	VOLKSWAGEN	JETTA
11541	90-92	NISSAN	STANZA
11542	83-83	NISSAN	PULSAR
11542	83-86	NISSAN	PULSAR NX
11543	87-90	NISSAN	PULSAR NX
11544	91-93	NISSAN	NX
11546	86-88	NISSAN	STANZA
11548	18-20	HYUNDAI	ACCENT
11549	89-93	NISSAN	240SX
11550	19-20	HYUNDAI	VELOSTER
11551	82-86	NISSAN	SENTRA
11552	87-90	NISSAN	SENTRA
11553	82-86	NISSAN	SENTRA
11555	07-16	HONDA	CR-V
11557	79-83	NISSAN	280ZX
11558	84-86	NISSAN	300ZX
11559	87-89	NISSAN	300ZX
11560	82-88	VOLKSWAGEN	QUANTUM
11561	86-88	VOLKSWAGEN	QUANTUM
11562	90-92	DAIHATSU	ROCKY
11563	18-20	NISSAN	KICKS
11564	15-19	VOLKSWAGEN	GOLF R
11565	81-90	FORD	ESCORT
11565	87-94	FORD	TEMPO
11565	81-87	MERCURY	LYNX
11565	87-94	MERCURY	TOPAZ
11566	88-93	FORD	FESTIVA
11567	18-21	TOYOTA	C-HR
11567	19-20	TOYOTA	COROLLA
11568	88-89	MERCURY	TRACER
11570	84-87	PONTIAC	FIERO
11574	84-87	HONDA	CIVIC
11575	20-21	KIA	SOUL
11576	19-21	TOYOTA	AVALON
11576	18-20	TOYOTA	CAMRY
11577	84-85	HONDA	ACCORD
11578	21-21	KIA	SELTOS
11579	84-85	HONDA	ACCORD
11582	83-87	HONDA	PRELUDE
11583	85-87	HONDA	PRELUDE
11584	88-89	HONDA	PRELUDE
11585	84-86	HONDA	CIVIC
11586	87-87	HONDA	CIVIC
11587	88-91	HONDA	CIVIC
11588	84-87	HONDA	CIVIC
11589	84-87	HONDA	CIVIC
11590	88-91	HONDA	CIVIC
11592	88-91	HONDA	CIVIC
11595	91-93	ISUZU	STYLUS
11596	20-20	TOYOTA	COROLLA
11597	86-89	MAZDA	323
11598	90-94	MAZDA	323
11599	20-20	MAZDA	CX-30
11600	86-89	MAZDA	323
11602	81-85	MAZDA	RX-7
11604	16-18	HONDA	CIVIC
11605	90-90	MAZDA	PROTEGE
11609	20-20	HYUNDAI	VENUE
11610	89-90	MITSUBISHI	SIGMA
11611	87-90	MITSUBISHI	VAN
11613	75-76	MERCEDES-BENZ	230
11613	75-76	MERCEDES-BENZ	240D
11613	75-76	MERCEDES-BENZ	280
11613	75-76	MERCEDES-BENZ	280C
11613	75-76	MERCEDES-BENZ	300D

Part #	Years	Make	Model
11616	75-76	MERCEDES-BENZ	280S
11616	77-80	MERCEDES-BENZ	280SE
11616	78-80	MERCEDES-BENZ	300SD
11616	74-76	MERCEDES-BENZ	450SE
11616	74-80	MERCEDES-BENZ	450SEL
11617	81-85	MERCEDES-BENZ	380SL
11617	74-80	MERCEDES-BENZ	450SL
11617	86-89	MERCEDES-BENZ	560SL
11618	80-88	PEUGEOT	505
11624	87-88	STERLING	825
11624	89-91	STERLING	827
11628	87-88	SUBARU	JUSTY
11629	89-94	SUBARU	JUSTY
11631	85-86	SUBARU	DL
11631	85-86	SUBARU	GL
11631	85-86	SUBARU	GL-10
11631	85-86	SUBARU	RX
11632	87-89	SUBARU	DL
11632	87-89	SUBARU	GL
11632	87-89	SUBARU	GL-10
11632	93-93	SUBARU	IMPREZA
11632	90-93	SUBARU	LEGACY
11632	90-93	SUBARU	LOYALE
11632	87-89	SUBARU	RX
11634	85-86	SUBARU	DL
11634	85-86	SUBARU	GL
11634	85-86	SUBARU	GL-10
11635	87-89	SUBARU	DL
11635	87-89	SUBARU	GL
11635	87-89	SUBARU	GL-10
11635	90-94	SUBARU	LOYALE
11639	87-91	SUBARU	XT
11641	82-85	TOYOTA	CELICA
11642	81-84	TOYOTA	CRESSIDA
11643	84-89	TOYOTA	VAN
11643	88-88	TOYOTA	VAN WAGON
11645	87-92	TOYOTA	COROLLA
11646	87-91	TOYOTA	CAMRY
11646	86-89	TOYOTA	CELICA
11646	87-88	TOYOTA	CRESSIDA
11646	86-89	TOYOTA	SUPRA
11647	86-89	TOYOTA	CELICA
11649	79-83	TOYOTA	COROLLA
11649	79-82	TOYOTA	CORONA
11649	81-84	TOYOTA	STARLET
11649	83-86	TOYOTA	TERCEL
11651	82-85	TOYOTA	CELICA
11652	68-79	VOLKSWAGEN	BETLE
11652	71-79	VOLKSWAGEN	SUPER BEETLE
11653	75-84	VOLKSWAGEN	RABBIT
11653	80-84	VOLKSWAGEN	RABBIT CONVERTIBLE
11653	75-81	VOLKSWAGEN	SCIROCCO
11654	85-90	VOLKSWAGEN	GOLF
11655	73-79	VOLKSWAGEN	TRANSPORTER
11656	80-91	VOLKSWAGEN	VANAGON
11657	87-91	VOLKSWAGEN	VANAGON
11658	80-84	VOLKSWAGEN	JETTA
11659	85-90	VOLKSWAGEN	JETTA
11660	82-88	VOLKSWAGEN	SCIROCCO
11661	85-93	VOLKSWAGEN	CABRIOLET
11662	87-93	VOLKSWAGEN	FOX
11664	90-93	VOLVO	240
11664	86-89	VOLVO	244
11664	86-89	VOLVO	245
11666	84-87	MERCEDES-BENZ	190D
11666	84-87	MERCEDES-BENZ	190E
11668	94-97	FORD	ASPIRE
11674	95-98	PORSCHE	911
11679	05-09	KIA	SPECTRA
11681	13-17	HONDA	ACCORD
11699	07-10	HONDA	ELEMENT
11700	03-11	HONDA	ELEMENT
11701	03-09	MERCEDES-BENZ	E320
11701	06-09	MERCEDES-BENZ	E350
11701	03-06	MERCEDES-BENZ	E500

Part #	Years	Make	Model
11701	03-06	MERCEDES-BENZ	E55 AMG
11701	07-09	MERCEDES-BENZ	E550
11701	07-09	MERCEDES-BENZ	E63 AMG
11703	90-96	NISSAN	300ZX
11704	89-92	FORD	PROBE
11705	84-96	CHEVROLET	CORVETTE
11706	90-92	INFINITI	M30
11707	91-96	INFINITI	G20
11708	92-95	MAZDA	MX-3
11710	91-96	DODGE	STEALTH
11710	91-99	MITSUBISHI	3000GT
11711	81-85	MERCEDES-BENZ	300SD
11711	86-87	MERCEDES-BENZ	300SDL
11711	88-91	MERCEDES-BENZ	300SE
11711	88-91	MERCEDES-BENZ	300SEL
11711	91-91	MERCEDES-BENZ	350SD
11711	90-91	MERCEDES-BENZ	350SDL
11711	84-85	MERCEDES-BENZ	380SE
11711	82-83	MERCEDES-BENZ	380SEC
11711	81-83	MERCEDES-BENZ	380SEL
11711	86-91	MERCEDES-BENZ	420SEL
11711	84-85	MERCEDES-BENZ	500SEC
11711	84-85	MERCEDES-BENZ	500SEL
11711	86-91	MERCEDES-BENZ	560SEC
11711	86-91	MERCEDES-BENZ	560SEL
11712	77-88	PORSCHE	924
11712	83-91	PORSCHE	944
11713	91-95	TOYOTA	MR2
11714	90-92	VOLKSWAGEN	GOLF
11715	91-92	VOLKSWAGEN	JETTA
11716	90-94	VOLKSWAGEN	CORRADO
11717	90-94	VOLKSWAGEN	PASSAT
11718	90-94	VOLKSWAGEN	PASSAT
11720	93-97	FORD	PROBE
11721	88-89	MERCEDES-BENZ	190D
11721	88-93	MERCEDES-BENZ	190E
11722	85-90	VOLKSWAGEN	JETTA
11724	93-97	HONDA	CIVIC DEL SOL
11725	90-91	HONDA	PRELUDE
11726	86-89	HONDA	ACCORD
11727	93-97	INFINITI	J30
11728	93-95	MITSUBISHI	DIAMANTE
11729	90-97	MAZDA	MIATA
11730	94-98	SAAB	900
11731	95-98	NISSAN	240SX
11732	95-96	VOLKSWAGEN	CABRIO
11733	75-79	JAGUAR	XJ12
11733	75-87	JAGUAR	XJ6
11733	76-93	JAGUAR	XJS
11734	94-94	JAGUAR	XJ12
11734	88-94	JAGUAR	XJ6
11735	95-97	VOLKSWAGEN	PASSAT
11736	95-97	VOLKSWAGEN	PASSAT
11742	90-93	MERCEDES-BENZ	300SL
11742	94-97	MERCEDES-BENZ	SL320
11742	94-02	MERCEDES-BENZ	SL500
11742	94-02	MERCEDES-BENZ	SL600
11744	96-99	MERCEDES-BENZ	E300
11744	96-02	MERCEDES-BENZ	E320
11744	97-97	MERCEDES-BENZ	E420
11744	98-02	MERCEDES-BENZ	E430
11744	99-02	MERCEDES-BENZ	E55 AMG
11745	95-98	VOLKSWAGEN	GOLF
11746	90-97	MAZDA	MIATA
11747	95-01	BMW	740I
11747	95-01	BMW	740IL
11747	95-01	BMW	750IL
11748	96-02	BMW	Z3
11749	99-05	MAZDA	MIATA
11750	97-00	JAGUAR	XK8
11750	00-00	JAGUAR	XKR
11751	98-04	MERCEDES-BENZ	SLK230
11751	02-04	MERCEDES-BENZ	SLK32 AMG
11751	01-04	MERCEDES-BENZ	SLK320
11754	99-02	SAAB	9-3

Part #	Years	Make	Model
11755	99-05	MAZDA	MIATA
11756	07-10	BMW	335I
11756	07-08	BMW	335XI
11760	80-82	CHEVROLET	CORVETTE
11762	01-05	LEXUS	IS300
11764	00-02	DAEWOO	NUBIRA
11765	00-06	AUDI	TT QUATTRO
11767	93-94	DODGE	COLT
11767	93-96	EAGLE	SUMMIT
11767	93-02	MITSUBISHI	MIRAGE
11767	93-94	PLYMOUTH	COLT
11768	02-06	HONDA	CR-V
11771	06-06	BMW	325XI
11771	07-11	BMW	328I
11771	09-11	BMW	328I XDRIVE
11771	07-08	BMW	328XI
11772	96-99	INFINITI	I30
11772	97-99	NISSAN	MAXIMA
11773	01-03	ACURA	MDX
11773	03-03	HONDA	PILOT
11775	08-10	AUDI	TT QUATTRO
11800	91-93	HONDA	ACCORD
11801	90-96	INFINITI	Q45
11804	88-91	MAZDA	929
11805	79-85	MERCEDES-BENZ	300TD
11807	81-86	SAAB	900
11808	86-94	SAAB	900
11809	86-88	SAAB	9000
11810	89-92	SAAB	9000
11811	89-98	SAAB	9000
11812	81-90	TOYOTA	LAND CRUISER
11815	94-96	MERCEDES-BENZ	C220
11815	97-00	MERCEDES-BENZ	C230
11815	94-00	MERCEDES-BENZ	C280
11815	95-97	MERCEDES-BENZ	C36 AMG
11815	98-00	MERCEDES-BENZ	C43 AMG
11815	98-03	MERCEDES-BENZ	CLK320
11815	99-03	MERCEDES-BENZ	CLK430
11815	03-03	MERCEDES-BENZ	CLK500
11815	01-03	MERCEDES-BENZ	CLK55 AMG
11816	88-93	MERCEDES-BENZ	300CE
11816	87-93	MERCEDES-BENZ	300D
11816	86-93	MERCEDES-BENZ	300E
11816	92-93	MERCEDES-BENZ	400E
11821	99-08	SAAB	9-5
11822	00-04	VOLVO	S40
11822	00-04	VOLVO	V40
11823	06-06	MERCEDES-BENZ	S350
11823	00-06	MERCEDES-BENZ	S430
11823	00-06	MERCEDES-BENZ	S500
11823	01-06	MERCEDES-BENZ	S600
11824	03-07	MERCEDES-BENZ	C230
11824	01-05	MERCEDES-BENZ	C240
11824	06-07	MERCEDES-BENZ	C280
11824	02-04	MERCEDES-BENZ	C32 AMG
11824	01-05	MERCEDES-BENZ	C320
11824	06-07	MERCEDES-BENZ	C350
11824	05-06	MERCEDES-BENZ	C55 AMG
11824	06-06	MERCEDES-BENZ	CLS500
11824	06-06	MERCEDES-BENZ	CLS55 AMG
11824	07-07	MERCEDES-BENZ	CLS550
11824	07-07	MERCEDES-BENZ	CLS63 AMG
11828	07-11	MERCEDES-BENZ	S550
11829	08-10	VOLVO	C30
11830	98-03	MERCEDES-BENZ	E320
11831	99-09	SAAB	9-5
11900	14-19	CADILLAC	CTS
11900	16-21	CHEVROLET	CAMARO
11901	16-17	CADILLAC	CTS
12002	06-13	SUZUKI	GRAND VITARA
12003	96-98	MAZDA	MPV
12004	07-09	ACURA	RDX
12005	78-81	BUICK	CENTURY
12005	78-87	BUICK	REGAL
12005	78-87	CHEVROLET	EL CAMINO

Part #	Years	Make	Model
12005	77-88	CHEVROLET	MONTE CARLO
12005	82-83	OLDSMOBILE	CUTLASS CIERA
12005	78-88	OLDSMOBILE	CUTLASS SUPREME
12005	82-86	PONTIAC	BONNEVILLE
12005	78-87	PONTIAC	GRAND PRIX
12005	78-81	PONTIAC	LEMANS
12006	98-04	DODGE	INTREPID
12008	85-96	OLDSMOBILE	CUTLASS CIERA
12008	85-91	PONTIAC	6000
12009	71-73	BUICK	CENTURION
12009	77-84	BUICK	ELECTRA
12009	77-85	BUICK	LESABRE
12009	92-96	BUICK	ROADMASTER
12009	77-96	CHEVROLET	CAPRICE
12009	80-84	OLDSMOBILE	98
12009	80-80	OLDSMOBILE	DELTA 88
12009	83-86	PONTIAC	PARISIENNE
12010	10-16	LINCOLN	MKT
12011	83-04	CHEVROLET	S10
12011	83-90	GMC	S15
12011	91-04	GMC	SONOMA
12012	83-11	FORD	RANGER
12012	94-09	MAZDA	B2300
12012	94-07	MAZDA	B3000
12012	94-09	MAZDA	B4000
12013	03-08	TOYOTA	MATRIX
12021	94-97	HONDA	PASSPORT
12021	91-97	ISUZU	RODEO
12022	10-11	BUICK	LUCERNE
12025	90-93	CHRYSLER	IMPERIAL
12025	89-94	CHRYSLER	LEBARON
12025	86-93	CHRYSLER	NEW YORKER
12025	88-93	DODGE	DYNASTY
12025	89-95	DODGE	SPIRIT
12025	89-95	PLYMOUTH	ACCLAIM
12027	04-05	CHEVROLET	CLASSIC
12027	97-03	CHEVROLET	MALIBU
12027	97-99	OLDSMOBILE	CUTLASS
12028	00-07	CHEVROLET	MONTE CARLO
12030	10-15	HYUNDAI	TUCSON
12030	11-15	KIA	SPORTAGE
12031	99-17	HONDA	ODYSSEY
12032	98-01	CHRYSLER	CONCORDE
12034	99-04	CHRYSLER	300M
12035	02-04	CHRYSLER	CONCORDE
12035	99-01	CHRYSLER	LHS
12036	07-14	FORD	EDGE
12036	07-15	LINCOLN	MKX
12037	83-94	CHEVROLET	S10 BLAZER
12037	92-94	GMC	JIMMY
12037	83-91	GMC	S15 JIMMY
12037	91-94	OLDSMOBILE	BRAVADA
12038	98-08	SUBARU	FORESTER
12040	99-04	OLDSMOBILE	ALERO
12040	99-05	PONTIAC	GRAND AM
12041	77-83	BUICK	ESTATE WAGON
12041	85-90	BUICK	LESABRE
12041	91-96	BUICK	ROADMASTER
12041	77-96	CHEVROLET	CAPRICE
12041	77-92	OLDSMOBILE	CUSTOM CRUISER
12041	83-86	PONTIAC	PARISIENNE
12044	00-05	BUICK	LESABRE
12044	06-09	BUICK	LUCERNE
12044	01-03	OLDSMOBILE	AURORA
12044	00-05	PONTIAC	BONNEVILLE
12045	85-05	CHEVROLET	ASTRO
12045	85-05	GMC	SAFARI
12047	09-13	SUBARU	FORESTER
12048	11-20	MITSUBISHI	OUTLANDER SPORT
12048	11-20	MITSUBISHI	RVR
12049	91-96	BUICK	PARK AVENUE
12049	91-96	OLDSMOBILE	98
12049	97-97	OLDSMOBILE	REGENCY
12050	11-14	SUBARU	TRIBECA
12051	08-12	CHEVROLET	MALIBU

Part #	Years	Make	Model
12051	07-09	SATURN	AURA
12052	94-96	CADILLAC	DEVILLE
12053	89-97	FORD	THUNDERBIRD
12053	93-98	LINCOLN	MARK VIII
12053	89-97	MERCURY	COUGAR
12054	92-94	CADILLAC	ELDORADO
12054	92-97	CADILLAC	SEVILLE
12055	97-99	CADILLAC	DEVILLE
12056	06-10	MERCEDES-BENZ	R350
12056	06-07	MERCEDES-BENZ	R500
12057	11-17	JEEP	COMPASS
12057	11-17	JEEP	PATRIOT
12058	00-05	CADILLAC	DEVILLE
12058	06-11	CADILLAC	DTS
12060	05-12	FORD	ESCAPE
12060	05-11	MAZDA	TRIBUTE
12060	05-11	MERCURY	MARINER
12061	11-17	NISSAN	QUEST
12064	11-20	CHRYSLER	300
12064	11-20	DODGE	CHALLENGER
12064	11-15	DODGE	CHARGER
12065	04-20	TOYOTA	SIENNA
12066	11-18	VOLVO	S60
12066	15-18	VOLVO	V60
12066	15-18	VOLVO	V60 CROSS COUNTRY
12066	08-10	VOLVO	V70
12066	09-16	VOLVO	XC70
12068	95-02	CADILLAC	ELDORADO
12069	88-96	BUICK	REGAL
12069	90-94	CHEVROLET	LUMINA
12069	88-97	OLDSMOBILE	CUTLASS SUPREME
12069	88-96	PONTIAC	GRAND PRIX
12070	10-16	CADILLAC	SRX
12073	92-98	BUICK	SKYLARK
12073	92-98	OLDSMOBILE	ACHEVA
12073	92-98	PONTIAC	GRAND AM
12074	10-12	ACURA	RDX
12076	10-13	FORD	TRANSIT CONNECT
12083	13-18	ACURA	RDX
12086	09-16	HYUNDAI	GENESIS
12088	09-16	LINCOLN	MKS
12089	86-97	FORD	AEROSTAR
12091	13-20	FORD	FUSION
12091	13-20	LINCOLN	MKZ
12092	13-18	FORD	C-MAX
12093	07-12	MAZDA	CX-7
12094	96-07	CHRYSLER	TOWN & COUNTRY
12094	96-07	DODGE	CARAVAN
12094	96-00	PLYMOUTH	VOYAGER
12095	12-15	CHEVROLET	CAPTIVA SPORT
12095	08-10	SATURN	VUE
12096	15-19	LINCOLN	MKC
12097	09-17	VOLKSWAGEN	TIGUAN
12098	90-93	CHEVROLET	LUMINA APV
12098	90-96	OLDSMOBILE	SILHOUETTE
12098	90-93	PONTIAC	TRANS SPORT
12100	14-18	SUBARU	FORESTER
12101	93-97	CHRYSLER	CONCORDE
12101	94-97	CHRYSLER	LHS
12101	94-96	CHRYSLER	NEW YORKER
12101	93-97	DODGE	INTREPID
12101	93-97	EAGLE	VISION
12102	99-02	MERCURY	VILLAGER
12102	99-02	NISSAN	QUEST
12103	95-99	BUICK	RIVIERA
12103	95-99	OLDSMOBILE	AURORA
12105	95-98	MERCURY	VILLAGER
12105	93-98	NISSAN	QUEST
12106	04-09	CADILLAC	SRX
12107	13-18	TOYOTA	AVALON
12107	12-17	TOYOTA	CAMRY
12108	06-18	TOYOTA	RAV4
12110	04-08	TOYOTA	SOLARA
12111	13-19	FORD	ESCAPE
12112	07-15	MAZDA	CX-9

Part #	Years	Make	Model
12113	13-18	HYUNDAI	SANTA FE SPORT
12113	14-15	KIA	SORENTO
12114	12-17	LEXUS	LS460
12115	10-16	BUICK	LACROSSE
12115	11-17	BUICK	REGAL
12115	13-19	CADILLAC	XTS
12115	14-20	CHEVROLET	IMPALA
12115	13-15	CHEVROLET	MALIBU
12115	16-16	CHEVROLET	MALIBU LIMITED
12116	14-16	KIA	RONDO
12117	94-96	CHEVROLET	LUMINA APV
12117	94-96	PONTIAC	TRANS SPORT
12118	14-19	KIA	CADENZA
12120	14-20	ACURA	RLX
12121	95-03	FORD	WINDSTAR
12122	08-20	NISSAN	ROGUE
12122	14-15	NISSAN	ROGUE SELECT
12123	14-21	FORD	TRANSIT CONNECT
12125	95-00	CHEVROLET	LUMINA
12125	95-99	CHEVROLET	MONTE CARLO
12126	05-09	HYUNDAI	TUCSON
12126	05-10	KIA	SPORTAGE
12127	96-99	OLDSMOBILE	88
12127	96-99	PONTIAC	BONNEVILLE
12128	92-99	PONTIAC	BONNEVILLE
12130	87-91	FORD	COUNTRY SQUIRE
12130	92-11	FORD	CROWN VICTORIA
12130	80-83	LINCOLN	MARK VI
12130	81-11	LINCOLN	TOWN CAR
12130	87-91	MERCURY	COLONY PARK
12130	80-09	MERCURY	GRAND MARQUIS
12130	03-04	MERCURY	MARAUDER
12134	09-20	DODGE	JOURNEY
12136	14-19	SUBARU	OUTBACK
12137	84-01	JEEP	CHEROKEE
12138	15-15	JEEP	RENEGADE
12139	15-15	LEXUS	NX200T
12139	15-15	LEXUS	NX300H
12140	15-20	FORD	EDGE
12141	88-95	CHRYSLER	TOWN & COUNTRY
12141	88-95	DODGE	CARAVAN
12141	84-95	PLYMOUTH	VOYAGER
12142	15-20	JEEP	RENEGADE
12143	15-16	LEXUS	NX200T
12143	15-16	LEXUS	NX300H
12148	15-18	AUDI	Q3
12148	15-18	AUDI	Q3 QUATTRO
12154	18-20	MITSUBISHI	ECLIPSE CROSS
12156	16-20	MAZDA	CX-9
12157	97-05	BUICK	PARK AVENUE
12158	17-21	KIA	SPORTAGE
12159	17-19	CHRYSLER	PACIFICA
12160	16-20	CADILLAC	CT6
12163	16-18	MERCEDES-BENZ	CLA250
12164	17-19	FORD	FUSION
12164	17-17	LINCOLN	MKZ
12165	17-20	GENESIS	G80
12165	17-19	GENESIS	G90
12165	12-16	HYUNDAI	GENESIS
12166	17-19	BUICK	LACROSSE
12169	17-20	HONDA	CR-V
12170	13-20	MAZDA	CX-5
12171	17-20	KIA	NIRO
12172	17-17	LEXUS	NX200T
12172	18-20	LEXUS	NX300
12172	17-20	LEXUS	NX300H
12173	18-20	BUICK	REGAL TOURX
12174	17-21	JEEP	COMPASS
12175	18-21	HONDA	ODYSSEY
12177	18-20	VOLKSWAGEN	TIGUAN
12180	17-20	CHRYSLER	PACIFICA
12180	20-20	CHRYSLER	VOYAGER
12181	87-89	DODGE	RAIDER
12181	89-94	ISUZU	AMIGO
12181	88-91	ISUZU	TROOPER

Part #	Years	Make	Model
12181	83-00	MITSUBISHI	MONTERO
12181	91-97	TOYOTA	LAND CRUISER
12182	17-20	LINCOLN	CONTINENTAL
12184	18-20	SUBARU	CROSSTREK
12185	18-20	BUICK	REGAL SPORTBACK
12185	16-21	CHEVROLET	MALIBU
12186	01-06	CHRYSLER	SEBRING
12187	04-07	FORD	FREESTAR
12187	04-07	MERCURY	MONTEREY
12188	18-20	FORD	ECOSPORT
12189	07-10	CHRYSLER	SEBRING
12189	08-10	DODGE	AVENGER
12190	08-10	CHRYSLER	SEBRING
12198	19-20	SUBARU	FORESTER
12199	97-03	PONTIAC	GRAND PRIX
12200	19-21	TOYOTA	RAV4
12201	18-20	CHEVROLET	EQUINOX
12201	18-20	GMC	TERRAIN
12207	74-74	VOLVO	142
12207	74-74	VOLVO	144
12207	74-74	VOLVO	145
12207	74-75	VOLVO	164
12207	90-93	VOLVO	240
12207	75-84	VOLVO	242
12207	75-89	VOLVO	244
12207	75-89	VOLVO	245
12207	76-81	VOLVO	262
12207	76-82	VOLVO	264
12207	76-81	VOLVO	265
12209	85-92	VOLVO	740
12209	83-90	VOLVO	760
12209	88-90	VOLVO	780
12209	91-95	VOLVO	940
12209	92-94	VOLVO	960
12211	93-97	VOLVO	850
12211	98-02	VOLVO	C70
12211	98-00	VOLVO	S70
12211	98-00	VOLVO	V70
12213	95-97	VOLVO	960
12213	98-98	VOLVO	S90
12213	98-98	VOLVO	V90
12217	93-03	VOLKSWAGEN	EUROVAN
12217	93-94	VOLKSWAGEN	TRANSPORTER
12220	97-01	INFINITI	Q45
12221	03-10	PONTIAC	VIBE
12221	03-13	TOYOTA	MATRIX
12224	00-01	INFINITI	I30
12224	02-04	INFINITI	I35
12224	00-03	NISSAN	MAXIMA
12225	97-04	BUICK	REGAL
12225	97-08	PONTIAC	GRAND PRIX
12228	09-10	PONTIAC	VIBE
12228	09-13	TOYOTA	MATRIX
12230	95-00	LEXUS	LS400
12231	01-06	LEXUS	LS430
12232	86-07	FORD	TAURUS
12232	88-94	LINCOLN	CONTINENTAL
12232	86-05	MERCURY	SABLE
12233	92-99	BUICK	LESABRE
12233	92-95	OLDSMOBILE	88
12233	92-95	PONTIAC	BONNEVILLE
12234	03-08	PONTIAC	VIBE
12237	95-02	KIA	SPORTAGE
12239	05-09	BUICK	ALLURE
12239	97-05	BUICK	CENTURY
12239	05-09	BUICK	LACROSSE
12239	98-02	OLDSMOBILE	INTRIGUE
12240	05-10	CHRYSLER	300
12240	08-10	DODGE	CHALLENGER
12240	06-10	DODGE	CHARGER
12240	05-08	DODGE	MAGNUM
12241	16-21	HYUNDAI	TUCSON
12242	05-07	FORD	FIVE HUNDRED
12242	05-07	FORD	FREESTYLE
12242	08-09	FORD	TAURUS

Part #	Years	Make	Model
12242	08-08	FORD	TAURUS X
12242	05-07	MERCURY	MONTEGO
12242	08-08	MERCURY	SABLE
12243	95-02	LINCOLN	CONTINENTAL
12244	05-07	BUICK	TERRAZA
12244	05-09	CHEVROLET	UPLANDER
12244	97-05	CHEVROLET	VENTURE
12244	97-04	OLDSMOBILE	SILHOUETTE
12244	99-09	PONTIAC	MONTANA
12244	97-99	PONTIAC	TRANS SPORT
12245	08-12	JEEP	LIBERTY
12246	04-06	PONTIAC	GTO
12252	00-13	CHEVROLET	IMPALA
12252	14-16	CHEVROLET	IMPALA LIMITED
12253	00-06	LINCOLN	LS
12255	07-10	JEEP	COMPASS
12255	07-10	JEEP	PATRIOT
12259	07-09	KIA	AMANTI
12262	04-06	CHRYSLER	PACIFICA
12264	08-16	CHRYSLER	TOWN & COUNTRY
12264	08-20	DODGE	GRAND CARAVAN
12264	12-15	RAM	C/V
12264	09-14	VOLKSWAGEN	ROUTAN
12265	98-04	CADILLAC	SEVILLE
12270	90-04	SUBARU	LEGACY
12270	00-04	SUBARU	OUTBACK
12272	04-07	CHEVROLET	MALIBU
12280	04-07	CHEVROLET	MALIBU
12284	05-09	SUBARU	LEGACY
12284	05-09	SUBARU	OUTBACK
12285	99-06	VOLVO	S80
12287	07-14	VOLVO	S80
12288	00-06	MAZDA	MPV
12289	04-07	CHRYSLER	TOWN & COUNTRY
12289	04-07	DODGE	CARAVAN
12289	04-07	DODGE	GRAND CARAVAN
12290	15-19	SUBARU	LEGACY
12290	10-13	SUBARU	OUTBACK
12291	05-17	CHEVROLET	EQUINOX
12291	10-17	GMC	TERRAIN
12291	06-09	PONTIAC	TORRENT
12291	02-07	SATURN	VUE
12292	08-09	FORD	TAURUS X
12293	03-06	MITSUBISHI	OUTLANDER
12296	10-19	FORD	TAURUS
12298	10-14	SUBARU	LEGACY
12303	87-87	MAZDA	B2000
12303	87-93	MAZDA	B2200
12303	87-93	MAZDA	B2600
12304	91-97	TOYOTA	PREVIA
12312	98-99	NISSAN	FRONTIER
12314	00-04	JAGUAR	S-TYPE
12318	01-09	VOLVO	S60
12318	01-07	VOLVO	V70
12318	03-07	VOLVO	XC70
12333	05-10	PONTIAC	G6
12336	05-07	BUICK	TERRAZA
12336	05-09	CHEVROLET	UPLANDER
12336	05-09	PONTIAC	MONTANA
12336	05-07	SATURN	RELAY
12339	97-03	LEXUS	ES300
12339	04-06	LEXUS	ES330
12339	95-04	TOYOTA	AVALON
12339	97-06	TOYOTA	CAMRY
12339	99-03	TOYOTA	SOLARA
12341	09-15	TOYOTA	VENZA
12343	07-12	LEXUS	ES350
12343	07-11	TOYOTA	CAMRY
12362	96-07	CHRYSLER	TOWN & COUNTRY
12362	04-07	DODGE	CARAVAN
12362	96-00	PLYMOUTH	VOYAGER
12490	08-15	SCION	XB
12923	0-0	(BLANK)	(BLANK)
13000	10-16	LINCOLN	MKT
13001	06-13	SUZUKI	GRAND VITARA

Part #	Years	Make	Model
13002	10-16	CADILLAC	SRX
13005	09-10	KIA	BORREGO
13007	09-10	HUMMER	H3T
13008	01-06	CHEVROLET	SILVERADO 2500 HD
13008	07-07	CHEVROLET	SILVERADO 2500 HD CL
13008	01-06	CHEVROLET	SILVERADO 3500
13008	07-07	CHEVROLET	SILVERADO 3500 CL
13008	01-06	GMC	SIERRA 2500 HD
13008	07-07	GMC	SIERRA 2500 HD CLASSIC
13008	01-06	GMC	SIERRA 3500
13008	07-07	GMC	SIERRA 3500 CLASSIC
13010	10-11	MERCEDES-BENZ	G55 AMG
13010	10-15	MERCEDES-BENZ	G550
13011	84-90	FORD	BRONCO II
13013	95-04	TOYOTA	TACOMA
13014	99-16	FORD	F-250 SUPER DUTY
13014	99-16	FORD	F-350 SUPER DUTY
13015	99-03	DODGE	RAM 1500 VAN
13015	99-03	DODGE	RAM 2500 VAN
13015	99-03	DODGE	RAM 3500 VAN
13016	78-95	CHEVROLET	G10
13016	78-95	CHEVROLET	G20
13016	78-96	CHEVROLET	G30
13016	78-78	GMC	G15
13016	79-95	GMC	G1500
13016	78-78	GMC	G25
13016	79-95	GMC	G2500
13016	78-78	GMC	G35
13016	79-96	GMC	G3500
13017	73-86	CHEVROLET	C10 SUBURBAN
13017	73-86	CHEVROLET	C20 SUBURBAN
13017	88-91	CHEVROLET	C2500
13017	73-86	CHEVROLET	K20 SUBURBAN
13017	87-88	CHEVROLET	R10 SUBURBAN
13017	89-91	CHEVROLET	R1500 SUBURBAN
13017	87-88	CHEVROLET	R20 SUBURBAN
13017	89-91	CHEVROLET	R2500 SUBURBAN
13017	75-78	GMC	C15 SUBURBAN
13017	73-74	GMC	C15/C1500 SUBURBAN
13017	79-86	GMC	C1500 SUBURBAN
13017	75-78	GMC	C25 SUBURBAN
13017	73-74	GMC	C25/C2500 SUBURBAN
13017	79-91	GMC	C2500
13017	79-86	GMC	C2500 SUBURBAN
13017	75-78	GMC	K15 SUBURBAN
13017	79-86	GMC	K1500 SUBURBAN
13017	75-78	GMC	K25 SUBURBAN
13017	73-74	GMC	K25/K2500 SUBURBAN
13017	79-86	GMC	K2500 SUBURBAN
13017	87-91	GMC	R1500 SUBURBAN
13017	87-91	GMC	R2500 SUBURBAN
13018	98-02	MERCEDES-BENZ	ML320
13018	03-05	MERCEDES-BENZ	ML350
13018	99-01	MERCEDES-BENZ	ML430
13018	02-05	MERCEDES-BENZ	ML500
13019	83-11	FORD	RANGER
13019	94-09	MAZDA	B2300
13019	94-07	MAZDA	B3000
13019	94-09	MAZDA	B4000
13020	95-04	CHEVROLET	BLAZER
13020	95-01	GMC	JIMMY
13020	96-04	OLDSMOBILE	BRAVADA
13021	83-04	CHEVROLET	S10
13021	83-90	GMC	S15
13021	91-04	GMC	SONOMA
13021	96-00	ISUZU	HOMBRE
13024	87-91	TOYOTA	4RUNNER
13028	75-86	CHEVROLET	C10
13028	75-86	CHEVROLET	C20
13028	88-00	CHEVROLET	C2500
13028	75-86	CHEVROLET	C30
13028	88-00	CHEVROLET	C3500
13028	91-02	CHEVROLET	C3500HD
13028	75-86	CHEVROLET	K10
13028	75-86	CHEVROLET	K20

Part #	Years	Make	Model
13028	88-00	CHEVROLET	K2500
13028	75-86	CHEVROLET	K30
13028	88-00	CHEVROLET	K3500
13028	99-99	CHEVROLET	SILVERADO 2500
13028	01-06	CHEVROLET	SILVERADO 3500
13028	07-07	CHEVROLET	SILVERADO 3500 CL
13028	88-97	FORD	F SUPER DUTY
13028	75-79	FORD	F-250
13028	73-97	FORD	F-350
13028	75-78	GMC	C15
13028	79-86	GMC	C1500
13028	75-78	GMC	C25
13028	79-00	GMC	C2500
13028	75-78	GMC	C35
13028	79-00	GMC	C3500
13028	91-02	GMC	C3500HD
13028	75-78	GMC	K15
13028	79-86	GMC	K1500
13028	75-78	GMC	K25
13028	79-00	GMC	K2500
13028	75-78	GMC	K35
13028	79-00	GMC	K3500
13028	99-99	GMC	SIERRA 2500
13028	01-06	GMC	SIERRA 3500
13028	07-07	GMC	SIERRA 3500 CLASSIC
13029	99-00	CADILLAC	ESCALADE
13029	92-94	CHEVROLET	BLAZER
13029	92-99	CHEVROLET	C1500 SUBURBAN
13029	92-99	CHEVROLET	C2500 SUBURBAN
13029	92-99	CHEVROLET	K1500 SUBURBAN
13029	92-99	CHEVROLET	K2500 SUBURBAN
13029	00-00	CHEVROLET	SUBURBAN 1500
13029	00-00	CHEVROLET	SUBURBAN 2500
13029	95-00	CHEVROLET	TAHOE
13029	92-00	GMC	YUKON
13032	86-97	FORD	AEROSTAR
13033	91-01	FORD	EXPLORER
13033	01-03	FORD	EXPLORER SPORT
13033	91-94	MAZDA	NAVAJO
13033	97-01	MERCURY	MOUNTAINEER
13035	85-05	CHEVROLET	ASTRO
13035	85-05	GMC	SAFARI
13037	91-95	CHRYSLER	TOWN & COUNTRY
13037	91-95	DODGE	CARAVAN
13037	91-95	PLYMOUTH	VOYAGER
13038	97-04	FORD	F-150
13038	04-04	FORD	F-150 HERITAGE
13038	97-99	FORD	F-250
13040	96-14	CHEVROLET	EXPRESS 1500
13040	96-20	CHEVROLET	EXPRESS 2500
13040	96-20	CHEVROLET	EXPRESS 3500
13040	96-14	GMC	SAVANA 1500
13040	96-20	GMC	SAVANA 2500
13040	96-20	GMC	SAVANA 3500
13041	78-80	DODGE	B100
13041	81-94	DODGE	B150
13041	95-97	DODGE	B1500
13041	78-80	DODGE	B200
13041	81-94	DODGE	B250
13041	95-97	DODGE	B2500
13041	78-80	DODGE	B300
13041	81-94	DODGE	B350
13041	95-97	DODGE	B3500
13042	88-98	CHEVROLET	C1500
13042	88-00	CHEVROLET	C2500
13042	88-00	CHEVROLET	C3500
13042	91-00	CHEVROLET	C3500HD
13042	99-00	CHEVROLET	SILVERADO 2500
13042	88-98	GMC	C1500
13042	88-00	GMC	C2500
13042	88-00	GMC	C3500
13042	91-00	GMC	C3500HD
13042	99-00	GMC	SIERRA 2500
13043	10-20	LEXUS	GX460
13044	02-07	JEEP	LIBERTY

Part #	Years	Make	Model
13045	93-98	TOYOTA	T100
13046	06-07	SUBARU	B9 TRIBECA
13046	08-10	SUBARU	TRIBECA
13048	93-98	JEEP	GRAND CHEROKEE
13049	97-02	FORD	EXPEDITION
13049	98-02	LINCOLN	NAVIGATOR
13050	04-09	CADILLAC	SRX
13051	99-04	JEEP	GRAND CHEROKEE
13052	08-15	LAND ROVER	LR2
13053	03-06	FORD	E-150
13053	75-02	FORD	E-150 ECONLINE
13053	03-06	FORD	E-250
13053	75-02	FORD	E-250 ECONLINE
13053	75-98	FORD	E-350 ECONLINE
13053	99-06	FORD	E-350 SUPER DUTY
13055	03-14	FORD	E-150
13055	00-02	FORD	E-150 ECONLINE
13055	03-14	FORD	E-250
13055	00-02	FORD	E-250 ECONLINE
13055	00-14	FORD	E-350 SUPER DUTY
13056	98-03	DODGE	DURANGO
13061	11-14	CHEVROLET	SILVERADO 2500 HD
13061	11-14	CHEVROLET	SILVERADO 3500 HD
13061	11-14	GMC	SIERRA 2500 HD
13061	11-14	GMC	SIERRA 3500 HD
13062	11-14	CHEVROLET	SILVERADO 2500 HD
13062	11-14	CHEVROLET	SILVERADO 3500 HD
13062	11-14	GMC	SIERRA 2500 HD
13062	11-14	GMC	SIERRA 3500 HD
13063	11-14	CHEVROLET	SILVERADO 2500 HD
13063	11-14	CHEVROLET	SILVERADO 3500 HD
13063	11-14	GMC	SIERRA 2500 HD
13063	11-14	GMC	SIERRA 3500 HD
13064	98-99	NISSAN	FRONTIER
13065	11-17	JEEP	GRAND CHEROKEE
13066	10-15	HYUNDAI	TUCSON
13066	11-15	KIA	SPORTAGE
13067	07-14	FORD	EDGE
13067	07-15	LINCOLN	MKX
13068	99-17	HONDA	ODYSSEY
13069	11-14	SUBARU	TRIBECA
13071	11-14	CHEVROLET	SILVERADO 2500 HD
13071	11-14	CHEVROLET	SILVERADO 3500 HD
13071	11-14	GMC	SIERRA 2500 HD
13071	11-14	GMC	SIERRA 3500 HD
13072	07-09	CHRYSLER	ASPEN
13072	04-09	DODGE	DURANGO
13073	10-12	HYUNDAI	SANTA FE
13073	11-13	KIA	SORENTO
13076	10-13	FORD	TRANSIT CONNECT
13077	07-18	BMW	X5
13077	14-19	BMW	X6
13078	11-17	NISSAN	QUEST
13079	11-20	NISSAN	OUTLANDER SPORT
13079	11-20	NISSAN	RVR
13081	11-17	JEEP	COMPASS
13081	11-17	JEEP	PATRIOT
13082	88-99	CHEVROLET	C1500
13082	88-00	CHEVROLET	C2500
13082	88-00	CHEVROLET	C3500
13082	88-99	CHEVROLET	K1500
13082	88-00	CHEVROLET	K2500
13082	88-00	CHEVROLET	K3500
13082	88-99	GMC	C1500
13082	88-00	GMC	C2500
13082	88-00	GMC	C3500
13082	88-99	GMC	K1500
13082	88-00	GMC	K2500
13082	88-00	GMC	K3500
13083	83-94	CHEVROLET	S10 BLAZER
13083	92-94	GMC	JIMMY
13083	83-91	GMC	S15 JIMMY
13083	91-94	OLDSMOBILE	BRAVADA
13084	84-01	JEEP	CHEROKEE
13085	95-03	FORD	WINDSTAR

Part #	Years	Make	Model
13086	84-95	TOYOTA	PICKUP
13087	96-02	TOYOTA	4RUNNER
13088	97-03	INFINITI	QX4
13088	96-04	NISSAN	PATHFINDER
13089	96-97	LEXUS	LX450
13089	91-97	TOYOTA	LAND CRUISER
13091	92-00	MINISUBISHI	MONTERO
13092	86-94	NISSAN	D21
13093	11-20	CHRYSLER	300
13093	15-16	DODGE	CHALLENGER
13093	12-16	DODGE	CHARGER
13094	92-95	TOYOTA	4RUNNER
13095	87-95	NISSAN	PATHFINDER
13096	94-94	HONDA	PASSPORT
13096	91-97	ISUZU	RODEO
13097	98-03	DODGE	DURANGO
13098	96-99	ACURA	SLX
13098	92-02	ISUZU	TROOPER
13099	75-86	CHEVROLET	C10
13099	70-74	CHEVROLET	C10 PICKUP
13099	88-98	CHEVROLET	C1500
13099	75-86	CHEVROLET	C20
13099	70-74	CHEVROLET	C20 PICKUP
13099	88-00	CHEVROLET	C2500
13099	88-00	CHEVROLET	C3500
13099	91-00	CHEVROLET	C3500HD
13099	70-74	CHEVROLET	K10 PICKUP
13099	88-98	CHEVROLET	K1500
13099	88-00	CHEVROLET	K2500
13099	88-00	CHEVROLET	K3500
13099	88-96	FORD	F SUPER DUTY
13099	63-83	FORD	F-100
13099	75-96	FORD	F-150
13099	63-96	FORD	F-250
13099	63-96	FORD	F-350
13099	70-74	GMC	C15/C1500 PICKUP
13099	79-98	GMC	C1500
13099	75-78	GMC	C25
13099	70-74	GMC	C25/C2500 PICKUP
13099	79-00	GMC	C2500
13099	70-74	GMC	C35/C3500 PICKUP
13099	79-00	GMC	C3500
13099	91-00	GMC	C3500HD
13099	75-78	GMC	K15
13099	79-98	GMC	K1500
13099	79-00	GMC	K2500
13099	79-00	GMC	K3500
13102	10-13	MERCEDES-BENZ	GL350
13102	07-13	MERCEDES-BENZ	GL450
13102	08-13	MERCEDES-BENZ	GL550
13102	11-11	MERCEDES-BENZ	ML350
13103	07-09	MERCEDES-BENZ	R320
13103	06-12	MERCEDES-BENZ	R350
13103	06-07	MERCEDES-BENZ	R500
13105	04-20	TOYOTA	SIENNA
13106	91-03	FORD	EXPLORER
13106	97-01	MERCURY	MOUNTAINEER
13108	01-06	CHEVROLET	SILVERADO 2500 HD
13108	07-07	CHEVROLET	SILVERADO 2500 HD CL
13108	01-06	GMC	SIERRA 2500 HD
13108	07-07	GMC	SIERRA 2500 HD CLASSIC
13109	12-20	NISSAN	NV1500
13109	12-20	NISSAN	NV2500
13109	12-20	NISSAN	NV3500
13110	09-19	FORD	FLEX
13110	10-17	LINCOLN	MKT
13112	06-10	FORD	EXPLORER
13112	06-10	MERCURY	MOUNTAINEER
13113	06-11	MINISUBISHI	ENDEAVOR
13114	08-13	BMW	X6
13115	15-21	KIA	SEDONA
13116	11-18	PORSCHE	CAYENNE
13116	11-17	VOLKSWAGEN	TOUAREG
13118	15-20	FORD	F-150
13119	12-16	HONDA	CR-V

Part #	Years	Make	Model
13120	10-15	HYUNDAI	TUCSON
13120	10-16	KIA	SPORTAGE
13121	99-00	CADILLAC	ESCALADE
13121	92-96	CHEVROLET	BLAZER
13121	92-99	CHEVROLET	C1500 SUBURBAN
13121	92-99	CHEVROLET	C2500 SUBURBAN
13121	92-99	CHEVROLET	K1500 SUBURBAN
13121	92-99	CHEVROLET	K2500 SUBURBAN
13121	00-00	CHEVROLET	SUBURBAN 1500
13121	00-00	CHEVROLET	SUBURBAN 2500
13121	95-00	CHEVROLET	TAHOE
13121	92-99	GMC	C1500 SUBURBAN
13121	92-99	GMC	C2500 SUBURBAN
13121	92-99	GMC	K1500 SUBURBAN
13121	92-99	GMC	K2500 SUBURBAN
13121	92-00	GMC	YUKON
13122	14-18	MOBILITY VENTURES	MV-1
13122	11-12	VPG	MV-1
13125	97-02	FORD	EXPEDITION
13125	98-02	LINCOLN	NAVIGATOR
13126	14-20	INFINITI	QX60
13126	13-16	NISSAN	PATHFINDER
13128	12-19	LAND ROVER	RANGE ROVER EVOQUE
13130	13-18	ACURA	RDX
13131	13-19	FORD	ESCAPE
13132	83-04	CHEVROLET	S10
13132	83-90	GMC	S15
13132	91-04	GMC	SONOMA
13133	09-17	VOLKSWAGEN	TIGUAN
13135	16-17	SUBARU	CROSSTREK
13135	13-15	SUBARU	XV CROSSTREK
13136	09-17	AUDI	Q5
13136	15-18	PORSCHE	MACAN
13138	83-11	FORD	RANGER
13138	94-09	MAZDA	B2300
13138	94-07	MAZDA	B3000
13138	94-09	MAZDA	B4000
13140	13-15	BMW	X1
13142	10-12	MERCEDES-BENZ	GLK350
13143	10-15	LEXUS	RX350
13143	10-15	LEXUS	RX450H
13144	14-18	SUBARU	FORESTER
13145	87-04	DODGE	DAKOTA
13146	14-20	ACURA	MDX
13146	16-21	HONDA	PILOT
13147	09-13	SUBARU	FORESTER
13149	06-18	TOYOTA	RAV4
13151	93-98	JEEP	GRAND CHEROKEE
13152	13-18	HYUNDAI	SANTA FE SPORT
13152	14-15	KIA	SORENTO
13153	13-18	HYUNDAI	SANTA FE
13153	19-19	HYUNDAI	SANTA FE XL
13154	10-12	ACURA	RDX
13155	13-15	MERCEDES-BENZ	GLK250
13156	97-03	INFINITI	QX4
13156	96-04	NISSAN	PATHFINDER
13157	96-02	TOYOTA	4RUNNER
13158	10-14	SUBARU	LEGACY
13160	84-01	JEEP	CHEROKEE
13161	07-14	CHEVROLET	TAHOE
13162	00-06	BMW	X5
13163	14-20	MINISUBISHI	OUTLANDER
13165	15-18	CHEVROLET	CITY EXPRESS
13165	13-20	NISSAN	NV200
13167	14-21	FORD	TRANSIT CONNECT
13171	14-19	JEEP	CHEROKEE
13172	14-18	JEEP	CHEROKEE
13173	14-14	MERCEDES-BENZ	GL350
13175	14-18	CHEVROLET	SILVERADO 1500
13175	19-19	CHEVROLET	SILVERADO 1500 LD
13175	14-18	GMC	SIERRA 1500
13175	19-19	GMC	SIERRA 1500 LIMITED
13176	15-20	CHEVROLET	COLORADO
13176	15-20	GMC	CANYON
13177	13-14	MERCEDES-BENZ	GLK350

Part #	Years	Make	Model
13178	15-19	CHEVROLET	SILVERADO 2500 HD
13178	15-19	CHEVROLET	SILVERADO 3500 HD
13178	15-19	GMC	SIERRA 2500 HD
13178	15-19	GMC	SIERRA 3500 HD
13180	00-06	TOYOTA	TUNDRA
13182	11-20	DODGE	DURANGO
13182	12-21	JEEP	GRAND CHEROKEE
13183	00-04	NISSAN	XTERRA
13184	00-06	TOYOTA	TUNDRA
13186	13-19	FORD	ESCAPE
13187	15-19	CHEVROLET	SILVERADO 2500 HD
13187	15-19	CHEVROLET	SILVERADO 3500 HD
13187	15-19	GMC	SIERRA 2500 HD
13187	15-19	GMC	SIERRA 3500 HD
13188	04-10	INFINITI	QX56
13188	05-15	NISSAN	ARMADA
13188	04-04	NISSAN	PATHFINDER ARMADA
13190	14-16	MERCEDES-BENZ	GL450
13190	14-16	MERCEDES-BENZ	GL550
13190	17-19	MERCEDES-BENZ	GLS450
13190	17-19	MERCEDES-BENZ	GLS550
13193	15-20	FORD	TRANSIT-150
13193	15-20	FORD	TRANSIT-250
13193	15-20	FORD	TRANSIT-350
13194	15-19	LINCOLN	MKC
13195	19-20	HYUNDAI	SANTA FE
13195	16-20	KIA	SORENTO
13196	93-98	TOYOTA	T100
13197	17-19	INFINITI	QX30
13197	15-20	MERCEDES-BENZ	GLA250
13197	15-19	MERCEDES-BENZ	GLA45 AMG
13198	07-20	TOYOTA	TUNDRA
13199	04-15	NISSAN	TITAN
13200	14-19	TOYOTA	HIGHLANDER
13201	09-20	DODGE	JOURNEY
13203	15-20	CHEVROLET	COLORADO
13203	15-20	GMC	CANYON
13204	08-20	NISSAN	ROGUE
13204	14-15	NISSAN	ROGUE SELECT
13205	15-20	NISSAN	MURANO
13206	14-19	SUBARU	OUTBACK
13207	14-20	RAM	PROMASTER 1500
13207	14-20	RAM	PROMASTER 2500
13207	14-20	RAM	PROMASTER 3500
13208	01-10	CHEVROLET	SILVERADO 2500 HD
13208	07-07	CHEVROLET	SILVERADO 2500 HD CL
13208	01-06	CHEVROLET	SILVERADO 3500
13208	07-07	CHEVROLET	SILVERADO 3500 CL
13208	07-10	CHEVROLET	SILVERADO 3500 HD
13208	01-10	GMC	SIERRA 2500 HD
13208	07-07	GMC	SIERRA 2500 HD CLASSIC
13208	01-06	GMC	SIERRA 3500
13208	07-07	GMC	SIERRA 3500 CLASSIC
13208	07-10	GMC	SIERRA 3500 HD
13209	15-16	AUDI	Q3
13210	01-10	CHEVROLET	SILVERADO 2500 HD
13210	07-07	CHEVROLET	SILVERADO 2500 HD CL
13210	01-06	CHEVROLET	SILVERADO 3500
13210	07-07	CHEVROLET	SILVERADO 3500 CL
13210	07-10	CHEVROLET	SILVERADO 3500 HD
13210	01-10	GMC	SIERRA 2500 HD
13210	07-07	GMC	SIERRA 2500 HD CLASSIC
13210	01-06	GMC	SIERRA 3500
13210	07-07	GMC	SIERRA 3500 CLASSIC
13210	07-10	GMC	SIERRA 3500 HD
13211	01-10	CHEVROLET	SILVERADO 2500 HD
13211	07-07	CHEVROLET	SILVERADO 2500 HD CL
13211	01-06	CHEVROLET	SILVERADO 3500
13211	07-07	CHEVROLET	SILVERADO 3500 CL
13211	07-10	CHEVROLET	SILVERADO 3500 HD
13211	01-10	GMC	SIERRA 2500 HD
13211	07-07	GMC	SIERRA 2500 HD CLASSIC
13211	01-06	GMC	SIERRA 3500
13211	07-07	GMC	SIERRA 3500 CLASSIC
13211	07-10	GMC	SIERRA 3500 HD

Part #	Years	Make	Model
13212	01-10	CHEVROLET	SILVERADO 2500 HD
13212	07-07	CHEVROLET	SILVERADO 2500 HD CL
13212	01-10	GMC	SIERRA 2500 HD
13212	07-07	GMC	SIERRA 2500 HD CLASSIC
13213	01-10	CHEVROLET	SILVERADO 2500 HD
13213	07-07	CHEVROLET	SILVERADO 2500 HD CL
13213	01-06	CHEVROLET	SILVERADO 3500
13213	07-07	CHEVROLET	SILVERADO 3500 CL
13213	07-10	CHEVROLET	SILVERADO 3500 HD
13213	01-10	GMC	SIERRA 2500 HD
13213	07-07	GMC	SIERRA 2500 HD CLASSIC
13213	01-06	GMC	SIERRA 3500
13213	07-07	GMC	SIERRA 3500 CLASSIC
13213	07-10	GMC	SIERRA 3500 HD
13215	15-20	RAM	PROMASTER CITY
13217	93-03	VOLKSWAGEN	EUROVAN
13217	93-94	VOLKSWAGEN	TRANSPORTER
13219	15-15	JEEP	RENEGADE
13220	07-15	AUDI	Q7
13220	04-10	PORSCHE	CAYENNE
13220	04-10	VOLKSWAGEN	TOUAREG
13222	98-02	HONDA	PASSPORT
13222	02-03	ISUZU	AXIOM
13222	98-04	ISUZU	RODEO
13223	97-04	MINI	MONTERO SPORT
13229	05-10	DODGE	DAKOTA
13229	06-09	MINI	RAIDER
13230	05-10	DODGE	DAKOTA
13233	16-21	VOLVO	XC90
13234	15-20	FORD	EDGE
13235	98-02	HONDA	PASSPORT
13235	89-00	ISUZU	AMIGO
13235	98-04	ISUZU	RODEO
13236	15-20	CHRYSLER	300
13236	11-20	DODGE	CHALLENGER
13236	15-20	DODGE	CHARGER
13238	15-18	AUDI	Q3
13238	15-18	AUDI	Q3 QUATTRO
13240	16-21	HYUNDAI	TUCSON
13241	05-20	NISSAN	FRONTIER
13241	09-12	SUZUKI	EQUATOR
13243	14-20	LAND ROVER	RANGE ROVER SPORT
13244	02-07	JEEP	LIBERTY
13245	08-12	JEEP	LIBERTY
13250	03-06	DODGE	SPRINTER 2500
13250	03-06	DODGE	SPRINTER 3500
13251	05-10	JEEP	GRAND CHEROKEE
13252	04-12	CHEVROLET	COLORADO
13252	04-12	GMC	CANYON
13252	06-06	ISUZU	I-280
13252	07-08	ISUZU	I-290
13252	06-06	ISUZU	I-350
13252	07-08	ISUZU	I-370
13262	16-18	LINCOLN	MKX
13262	19-20	LINCOLN	NAUTILUS
13264	16-20	TOYOTA	TACOMA
13265	03-06	DODGE	SPRINTER 2500
13265	03-06	DODGE	SPRINTER 3500
13266	11-18	VOLVO	S60
13266	15-18	VOLVO	V60
13266	15-18	VOLVO	V60 CROSS COUNTRY
13266	08-10	VOLVO	V70
13266	09-16	VOLVO	XC70
13268	10-17	VOLVO	XC60
13269	15-20	JEEP	RENEGADE
13270	06-10	HUMMER	H3
13271	16-20	FIAT	500X
13272	16-19	LEXUS	RX350
13273	18-20	MINI	ECLIPSE CROSS
13275	07-09	DODGE	SPRINTER 2500
13275	07-09	DODGE	SPRINTER 3500
13275	07-16	FREIGHTLINER	SPRINTER 3500
13275	10-11	MERCEDES-BENZ	SPRINTER 3500
13276	16-20	MERCEDES-BENZ	METRIS
13277	17-20	AUDI	Q7

Part #	Years	Make	Model
13280	87-04	DODGE	DAKOTA
13281	17-21	KIA	SPORTAGE
13282	16-20	LEXUS	RX450H
13284	16-20	MAZDA	CX-9
13285	17-21	CADILLAC	XT5
13287	12-18	FORD	RANGER
13290	16-20	MERCEDES-BENZ	GLC300
13290	17-20	MERCEDES-BENZ	GLC43 AMG
13291	17-20	JAGUAR	F-PACE
13292	16-18	BUICK	ENVISION
13293	17-20	GMC	ACADIA
13294	16-18	MERCEDES-BENZ	GLE350
13294	17-19	MERCEDES-BENZ	GLE43 AMG
13295	14-20	RAM	PROMASTER 1500
13295	14-20	RAM	PROMASTER 2500
13295	14-20	RAM	PROMASTER 3500
13296	07-09	CHRYSLER	ASPEN
13296	07-09	DODGE	DURANGO
13297	04-06	DODGE	DURANGO
13300	95-04	CHEVROLET	BLAZER
13300	95-01	GMC	JIMMY
13300	96-04	OLDSMOBILE	BRAVADA
13301	07-18	CHEVROLET	SILVERADO 1500
13301	19-19	CHEVROLET	SILVERADO 1500 LD
13301	07-18	GMC	SIERRA 1500
13301	19-19	MINI	SIERRA 1500 LIMITED
13303	16-21	BMW	X1
13304	17-20	NISSAN	TITAN
13305	17-21	VOLVO	S90
13309	17-20	NISSAN	PATHFINDER
13310	68-74	DODGE	D100 PICKUP
13310	77-93	DODGE	D150
13310	68-74	DODGE	D200 PICKUP
13310	81-93	DODGE	D250
13310	68-74	DODGE	D300 PICKUP
13310	81-93	DODGE	D350
13310	80-96	FORD	BRONCO
13310	73-83	FORD	F-100
13310	75-97	FORD	F-150
13310	73-97	FORD	F-250
13310	73-97	FORD	F-350
13314	97-01	HONDA	CR-V
13315	13-20	MAZDA	CX-5
13316	11-17	BMW	X3
13316	15-18	BMW	X4
13317	16-20	NISSAN	TITAN XD
13318	02-08	MERCEDES-BENZ	G500
13320	02-02	DODGE	RAM 1500
13322	99-13	CHEVROLET	SILVERADO 1500
13322	07-07	CHEVROLET	SILVERADO 1500 CL
13322	01-06	CHEVROLET	SILVERADO 1500 HD
13322	07-07	CHEVROLET	SILVERADO 1500 HD CL
13322	99-04	CHEVROLET	SILVERADO 2500
13322	99-13	GMC	SIERRA 1500
13322	07-07	GMC	SIERRA 1500 CLASSIC
13322	01-06	GMC	SIERRA 1500 HD
13322	07-07	GMC	SIERRA 1500 HD CLASSIC
13322	99-04	GMC	SIERRA 2500
13323	05-15	TOYOTA	TACOMA
13326	02-02	DODGE	RAM 1500
13328	01-06	ACURA	MDX
13328	03-08	HONDA	PILOT
13329	17-20	KIA	NIRO
13331	18-20	AUDI	Q5
13332	99-06	CHEVROLET	SILVERADO 1500
13332	07-07	CHEVROLET	SILVERADO 1500 CL
13332	01-06	CHEVROLET	SILVERADO 1500 HD
13332	07-07	CHEVROLET	SILVERADO 1500 HD CL
13332	99-04	CHEVROLET	SILVERADO 2500
13332	99-06	GMC	SIERRA 1500
13332	07-07	GMC	SIERRA 1500 CLASSIC
13332	01-06	GMC	SIERRA 1500 HD
13332	07-07	GMC	SIERRA 1500 HD CLASSIC
13332	99-04	GMC	SIERRA 2500
13333	03-10	DODGE	RAM 1500

Part #	Years	Make	Model
13333	03-10	DODGE	RAM 2500
13333	03-10	DODGE	RAM 3500
13333	11-18	RAM	1500
13333	19-21	RAM	1500 CLASSIC
13333	11-13	RAM	2500
13333	11-13	RAM	3500
13334	07-11	DODGE	NITRO
13336	05-07	BUICK	TERRAZA
13336	05-09	CHEVROLET	UPLANDER
13336	05-09	PONTIAC	MONTANA
13336	05-07	SATURN	RELAY
13337	15-17	LEXUS	NX200T
13337	18-20	LEXUS	NX300
13337	15-20	LEXUS	NX300H
13339	99-12	CHEVROLET	SILVERADO 1500
13339	07-07	CHEVROLET	SILVERADO 1500 CL
13339	01-06	CHEVROLET	SILVERADO 1500 HD
13339	07-07	CHEVROLET	SILVERADO 1500 HD CL
13339	99-04	CHEVROLET	SILVERADO 2500
13339	99-12	GMC	SIERRA 1500
13339	07-07	GMC	SIERRA 1500 CLASSIC
13339	01-06	GMC	SIERRA 1500 HD
13339	07-07	GMC	SIERRA 1500 HD CLASSIC
13339	99-04	GMC	SIERRA 2500
13340	02-05	KIA	SEDONA
13342	07-08	MERCEDES-BENZ	ML320
13342	06-11	MERCEDES-BENZ	ML350
13342	06-07	MERCEDES-BENZ	ML500
13342	08-09	MERCEDES-BENZ	ML550
13343	11-20	TOYOTA	SIENNA
13344	05-07	BUICK	TERRAZA
13344	05-09	CHEVROLET	UPLANDER
13344	97-05	CHEVROLET	VENTURE
13344	97-04	OLDSMOBILE	SILHOUETTE
13344	99-09	PONTIAC	MONTANA
13344	97-98	PONTIAC	TRANS SPORT
13345	07-08	HYUNDAI	ENTOURAGE
13345	06-14	KIA	SEDONA
13349	07-10	KIA	SEDONA
13352	04-05	FORD	F-150
13354	07-13	ACURA	MDX
13355	97-03	FORD	F-150
13355	04-04	FORD	F-150 HERITAGE
13355	97-99	FORD	F-250
13355	99-15	FORD	F-250 SUPER DUTY
13355	99-15	FORD	F-350 SUPER DUTY
13355	08-15	FORD	F-450 SUPER DUTY
13356	09-16	TOYOTA	VENZA
13357	04-05	FORD	F-150
13358	07-09	DODGE	SPRINTER 2500
13358	07-09	DODGE	SPRINTER 3500
13358	07-20	FREIGHTLINER	SPRINTER 2500
13358	07-20	FREIGHTLINER	SPRINTER 3500
13358	10-20	MERCEDES-BENZ	SPRINTER 2500
13358	10-20	MERCEDES-BENZ	SPRINTER 3500
13359	97-03	FORD	F-150
13359	04-04	FORD	F-150 HERITAGE
13359	97-99	FORD	F-250
13359	99-15	FORD	F-250 SUPER DUTY
13359	99-15	FORD	F-350 SUPER DUTY
13359	08-15	FORD	F-450 SUPER DUTY
13360	06-08	FORD	F-150
13360	06-08	LINCOLN	MARK LT
13361	02-08	DODGE	RAM 1500
13361	03-10	DODGE	RAM 2500
13361	03-10	DODGE	RAM 3500
13361	11-20	RAM	2500
13361	11-20	RAM	3500
13362	96-07	CHRYSLER	TOWN & COUNTRY
13362	00-03	CHRYSLER	VOYAGER
13362	96-07	DODGE	CARAVAN
13362	96-07	DODGE	GRAND CARAVAN
13362	96-00	PLYMOUTH	VOYAGER
13363	17-21	JEEP	COMPASS
13364	08-16	CHRYSLER	TOWN & COUNTRY

Part #	Years	Make	Model
13364	08-20	DODGE	GRAND CARAVAN
13364	12-15	RAM	C/V
13364	09-14	VOLKSWAGEN	ROUTAN
13365	06-08	FORD	F-150
13365	06-08	LINCOLN	MARK LT
13366	18-21	VOLKSWAGEN	ATLAS
13367	07-14	TOYOTA	FJ CRUISER
13368	09-14	FORD	F-150
13369	06-08	FORD	F-150
13370	18-21	HONDA	ODYSSEY
13371	09-14	FORD	F-150
13372	06-08	FORD	F-150
13374	09-10	DODGE	RAM 1500
13374	11-18	RAM	1500
13374	19-21	RAM	1500 CLASSIC
13375	07-10	DODGE	SPRINTER 3500
13375	07-20	FREIGHTLINER	SPRINTER 3500
13375	10-19	MERCEDES-BENZ	SPRINTER 3500
13377	17-19	NISSAN	QASHQAI
13377	17-20	NISSAN	ROGUE SPORT
13379	10-19	FORD	TAURUS
13381	18-20	VOLKSWAGEN	TIGUAN
13382	18-20	SUBARU	CROSSTREK
13383	17-20	CHRYSLER	PACIFICA
13383	20-20	CHRYSLER	VOYAGER
13384	18-20	BUICK	ENCLAVE
13385	06-14	HONDA	RIDGELINE
13386	11-19	FORD	EXPLORER
13386	13-19	FORD	POLICE INTERCEPTOR
13387	18-20	BMW	X3
13388	07-09	DODGE	SPRINTER 2500
13388	07-09	DODGE	SPRINTER 3500
13388	07-20	FREIGHTLINER	SPRINTER 2500
13388	07-20	FREIGHTLINER	SPRINTER 3500
13388	10-20	MERCEDES-BENZ	SPRINTER 2500
13388	10-20	MERCEDES-BENZ	SPRINTER 3500
13389	04-07	CHRYSLER	TOWN & COUNTRY
13389	04-07	DODGE	CARAVAN
13389	04-07	DODGE	GRAND CARAVAN
13390	15-19	SUBARU	LEGACY
13390	10-13	SUBARU	OUTBACK
13391	18-20	ALFA ROMEO	STELVIO
13392	18-21	JEEP	WRANGLER
13393	19-20	CHEVROLET	SILVERADO 1500
13393	19-20	GMC	SIERRA 1500
13394	18-20	LEXUS	RX350L
13394	14-19	TOYOTA	HIGHLANDER
13395	19-21	JEEP	CHEROKEE
13396	15-19	LAND ROVER	DISCOVERY SPORT
13397	17-20	HONDA	CR-V
13398	18-20	MINISUBISHI	OUTLANDER PHEV
13399	14-16	SUBARU	FORESTER
13400	19-21	SUBARU	ASCENT
13401	73-91	CHEVROLET	BLAZER
13401	75-86	CHEVROLET	K5 BLAZER
13401	73-91	GMC	JIMMY
13402	02-02	CADILLAC	ESCALADE
13402	02-02	CHEVROLET	AVALANCHE 1500
13402	02-02	CHEVROLET	AVALANCHE 2500
13402	00-02	CHEVROLET	SUBURBAN 1500
13402	00-02	CHEVROLET	SUBURBAN 2500
13402	00-02	CHEVROLET	TAHOE
13402	00-02	GMC	YUKON
13405	19-20	BUICK	ENVISION
13406	13-18	TOYOTA	RAV4
13407	01-05	FORD	EXPLORER SPORT TRAC
13408	97-06	JEEP	WRANGLER
13409	19-20	SUBARU	FORESTER
13410	10-19	SUBARU	OUTBACK
13411	16-18	MERCEDES-BENZ	GLE350
13411	17-19	MERCEDES-BENZ	GLE43 AMG
13411	12-15	MERCEDES-BENZ	ML350
13412	78-83	JEEP	CJ5
13412	78-86	JEEP	CJ7
13414	06-10	JEEP	COMMANDER

Part #	Years	Make	Model
13415	19-21	CADILLAC	XT4
13416	19-21	TOYOTA	RAV4
13417	19-20	FORD	RANGER
13418	19-21	CHEVROLET	BLAZER
13419	19-21	RAM	1500
13420	20-21	KIA	TELLURIDE
13421	19-20	HONDA	PASSPORT
13422	03-06	CADILLAC	ESCALADE
13422	03-06	CADILLAC	ESCALADE ESV
13422	03-06	CADILLAC	ESCALADE EXT
13422	03-06	CHEVROLET	AVALANCHE 1500
13422	03-06	CHEVROLET	AVALANCHE 2500
13422	03-06	CHEVROLET	SUBURBAN 1500
13422	03-06	CHEVROLET	SUBURBAN 2500
13422	03-06	CHEVROLET	TAHOE
13422	03-06	GMC	YUKON
13423	19-21	ACURA	RDX
13424	08-17	BUICK	ENCLAVE
13424	09-17	CHEVROLET	TRAVERSE
13424	07-16	GMC	ACADIA
13424	17-17	GMC	ACADIA LIMITED
13424	07-10	SATURN	OUTLOOK
13427	20-21	HYUNDAI	PALISADE
13429	99-03	LEXUS	RX300
13429	01-03	TOYOTA	HIGHLANDER
13430	97-06	JEEP	WRANGLER
13432	07-18	JEEP	WRANGLER
13433	18-20	BUICK	ENCLAVE
13433	18-20	CHEVROLET	TRAVERSE
13434	20-20	JEEP	GLADIATOR
13435	14-18	SUBARU	FORESTER
13436	20-20	FORD	ESCAPE
13436	20-20	LINCOLN	CORSAIR
13437	20-20	SUBARU	LEGACY
13437	20-20	SUBARU	OUTBACK
13438	20-20	FORD	EXPLORER
13438	20-20	LINCOLN	AVIATOR
13439	18-20	CHEVROLET	EQUINOX
13439	18-20	GMC	TERRAIN
13440	01-07	TOYOTA	SEQUOIA
13442	08-11	TOYOTA	SEQUOIA
13443	98-07	LEXUS	LX470
13443	98-07	TOYOTA	LAND CRUISER
13445	03-09	LEXUS	GX470
13445	03-09	TOYOTA	4RUNNER
13447	20-20	CHEVROLET	SILVERADO 2500 HD
13447	20-20	CHEVROLET	SILVERADO 3500 HD
13447	20-20	GMC	SIERRA 2500 HD
13447	20-20	GMC	SIERRA 3500 HD
13448	19-21	SUBARU	ASCENT
13450	02-05	LAND ROVER	FREELANDER
13452	15-20	FORD	EDGE
13452	15-19	LINCOLN	MKX
13452	19-20	LINCOLN	NAUTILUS
13453	20-20	TOYOTA	HIGHLANDER
13454	20-20	FORD	ESCAPE
13454	20-20	LINCOLN	CORSAIR
13455	98-04	LAND ROVER	DISCOVERY
13456	05-09	LAND ROVER	LR3
13456	10-16	LAND ROVER	LR4
13456	06-13	LAND ROVER	RANGE ROVER SPORT
13458	20-20	VOLKSWAGEN	ATLAS CROSS SPORT
13460	20-20	TOYOTA	HIGHLANDER
13462	17-20	CHRYSLER	PACIFICA
13464	0-0	(BLANK)	(BLANK)
13465	05-10	CHRYSLER	300
13465	08-10	DODGE	CHALLENGER
13465	06-10	DODGE	CHARGER
13465	05-08	DODGE	MAGNUM
13469	02-07	BUICK	RENDEZVOUS
13469	01-05	PONTIAC	AZTEK
13505	01-06	HYUNDAI	SANTA FE
13506	01-04	FORD	ESCAPE
13506	01-04	MAZDA	TRIBUTE
13511	98-03	TOYOTA	SIENNA

Part #	Years	Make	Model
13513	03-09	KIA	SORENTO
13514	05-15	NISSAN	XTERRA
13517	99-04	CHEVROLET	TRACKER
13517	99-06	SUZUKI	GRAND VITARA
13517	99-04	SUZUKI	VITARA
13517	02-06	SUZUKI	XL-7
13518	07-09	SUZUKI	GRAND VITARA
13518	07-09	SUZUKI	XL-7
13524	96-05	TOYOTA	RAV4
13526	05-09	HYUNDAI	TUCSON
13526	05-10	KIA	SPORTAGE
13529	04-08	CHRYSLER	PACIFICA
13530	04-06	LEXUS	RX330
13530	07-09	LEXUS	RX350
13530	06-08	LEXUS	RX400H
13530	04-07	TOYOTA	HIGHLANDER
13534	08-13	TOYOTA	HIGHLANDER
13535	02-06	HONDA	CR-V
13536	07-09	ACURA	RDX
13537	95-02	KIA	SPORTAGE
13538	07-09	HYUNDAI	SANTA FE
13540	91-01	FORD	EXPLORER
13540	91-94	MAZDA	NAVAJO
13540	97-01	MERCURY	MOUNTAINEER
13542	05-07	FORD	FIVE HUNDRED
13542	05-07	FORD	FREETSTYLE
13542	08-09	FORD	TAURUS
13542	05-07	MERCURY	MONTEGO
13542	08-09	MERCURY	SABLE
13545	07-12	HYUNDAI	VERACRUZ
13548	07-10	JEEP	COMPASS
13548	07-10	JEEP	PATRIOT
13550	02-05	FORD	EXPLORER
13550	03-05	LINCOLN	AVIATOR
13550	02-05	MERCURY	MOUNTAINEER
13551	09-19	FORD	FLEX
13554	09-12	INFINITI	FX35
13554	13-13	INFINITI	FX37
13554	09-13	INFINITI	FX50
13554	14-17	INFINITI	QX70
13555	07-11	HONDA	CR-V
13556	99-01	ISUZU	VEHICROSS
13558	03-08	INFINITI	FX35
13558	03-08	INFINITI	FX45
13559	03-14	VOLVO	XC90
13563	04-09	NISSAN	QUEST
13569	04-05	MINISUBISHI	ENDEAVOR
13571	03-07	NISSAN	MURANO
13572	99-02	MERCURY	VILLAGER
13572	99-02	NISSAN	QUEST
13573	04-10	BMW	X3
13574	03-11	HONDA	ELEMENT
13575	07-15	MAZDA	CX-9
13577	09-14	NISSAN	MURANO
13580	71-80	INTERNATIONAL	SCOUT II
13581	07-13	MINISUBISHI	OUTLANDER
13587	04-07	FORD	FREESTAR
13587	04-07	MERCURY	MONTEREY
13590	99-03	DODGE	RAM 1500 VAN
13590	99-03	DODGE	RAM 2500 VAN
13590	99-03	DODGE	RAM 3500 VAN
13591	05-17	CHEVROLET	EQUINOX
13591	10-17	GMC	TERRAIN
13591	06-09	PONTIAC	TORRENT
13591	02-07	SATURN	VUE
13593	07-12	MAZDA	CX-7
13594	12-15	CHEVROLET	CAPTIVA SPORT
13594	08-10	SATURN	VUE
13650	05-12	FORD	ESCAPE
13650	05-11	MAZDA	TRIBUTE
13650	05-11	MERCURY	MARINER
13651	05-11	FORD	ESCAPE
13651	05-11	MAZDA	TRIBUTE
13651	05-11	MERCURY	MARINER
13657	87-95	JEEP	WRANGLER

Part #	Years	Make	Model
13701	0-0	(BLANK)	(BLANK)
13702	0-0	(BLANK)	(BLANK)
13703	0-0	(BLANK)	(BLANK)
13704	0-0	(BLANK)	(BLANK)
13707	87-91	FORD	COUNTRY SQUIRE
13707	92-11	FORD	CROWN VICTORIA
13707	80-83	LINCOLN	MARK VI
13707	81-11	LINCOLN	TOWN CAR
13707	79-09	MERCURY	GRAND MARQUIS
13707	03-04	MERCURY	MARAUDER
13800	01-06	MINI	MONTERO
13831	00-04	NISSAN	FRONTIER
13841	00-04	NISSAN	FRONTIER
13842	03-04	NISSAN	FRONTIER
13895	0-0	(BLANK)	(BLANK)
13900	0-0	(BLANK)	(BLANK)
13901	0-0	(BLANK)	(BLANK)
13902	0-0	(BLANK)	(BLANK)
13903	0-0	(BLANK)	(BLANK)
13920	82-04	CHEVROLET	S10
13920	82-90	GMC	S15
13920	91-04	GMC	SONOMA
13932	99-06	CHEVROLET	SILVERADO 1500
13932	07-07	CHEVROLET	SILVERADO 1500 CL
13932	99-06	GMC	SIERRA 1500
13932	07-07	GMC	SIERRA 1500 CLASSIC
13942	88-99	CHEVROLET	C1500
13942	88-99	CHEVROLET	K1500
13942	88-99	GMC	C1500
13942	88-99	GMC	K1500
14000	12-20	NISSAN	NV1500
14000	12-20	NISSAN	NV2500
14000	12-20	NISSAN	NV3500
14001	75-89	DODGE	D100
14001	68-74	DODGE	D100 PICKUP
14001	77-93	DODGE	D150
14001	68-74	DODGE	D200 PICKUP
14001	81-93	DODGE	D250
14001	68-74	DODGE	D300 PICKUP
14001	81-93	DODGE	D350
14001	94-02	DODGE	RAM 1500
14001	94-02	DODGE	RAM 2500
14001	94-02	DODGE	RAM 3500
14001	78-96	FORD	BRONCO
14001	73-83	FORD	F-100
14001	75-96	FORD	F-150
14001	73-97	FORD	F-250
14001	97-97	FORD	F-250 HD
14001	73-97	FORD	F-350
14002	09-14	FORD	F-150
14005	20-20	CHEVROLET	SILVERADO 2500 HD
14005	20-20	CHEVROLET	SILVERADO 3500 HD
14005	20-20	GMC	SIERRA 2500 HD
14005	20-20	GMC	SIERRA 3500 HD
14006	14-18	CHEVROLET	SILVERADO 1500
14006	19-19	CHEVROLET	SILVERADO 1500 LD
14006	14-18	GMC	SIERRA 1500
14006	19-19	GMC	SIERRA 1500 LIMITED
14008	01-06	CHEVROLET	SILVERADO 2500 HD
14008	07-07	CHEVROLET	SILVERADO 2500 HD CL
14008	01-06	CHEVROLET	SILVERADO 3500
14008	07-07	CHEVROLET	SILVERADO 3500 CL
14008	01-06	GMC	SIERRA 2500 HD
14008	07-07	GMC	SIERRA 2500 HD CLASSIC
14008	01-06	GMC	SIERRA 3500
14008	07-07	GMC	SIERRA 3500 CLASSIC
14009	15-19	CHEVROLET	SILVERADO 2500 HD
14009	15-19	CHEVROLET	SILVERADO 3500 HD
14009	15-19	GMC	SIERRA 2500 HD
14009	15-19	GMC	SIERRA 3500 HD
14010	15-19	CHEVROLET	SILVERADO 2500 HD
14010	15-19	CHEVROLET	SILVERADO 3500 HD
14010	15-19	GMC	SIERRA 2500 HD
14010	15-19	GMC	SIERRA 3500 HD
14011	00-05	FORD	EXCURSION

Part #	Years	Make	Model
14012	15-20	FORD	TRANSIT-150
14012	15-20	FORD	TRANSIT-250
14012	15-20	FORD	TRANSIT-350
14016	15-20	FORD	F-150
14017	15-20	FORD	F-150
14018	20-20	FORD	F-350 SUPER DUTY
14020	02-02	DODGE	RAM 1500
14029	99-00	CADILLAC	ESCALADE
14029	92-94	CHEVROLET	BLAZER
14029	92-99	CHEVROLET	C1500 SUBURBAN
14029	92-99	CHEVROLET	C2500 SUBURBAN
14029	92-99	CHEVROLET	K1500 SUBURBAN
14029	92-99	CHEVROLET	K2500 SUBURBAN
14029	95-00	CHEVROLET	TAHOE
14029	92-99	GMC	YUKON
14048	99-20	FORD	F-350 SUPER DUTY
14048	99-20	FORD	F-450 SUPER DUTY
14048	99-20	FORD	F-550 SUPER DUTY
14048	00-20	FORD	F650
14053	03-06	FORD	E-150
14053	75-02	FORD	E-150 ECONOLINE
14053	03-06	FORD	E-250
14053	75-02	FORD	E-250 ECONOLINE
14053	75-98	FORD	E-350 ECONOLINE
14053	99-06	FORD	E-350 SUPER DUTY
14055	03-14	FORD	SAVANA 1500
14055	00-02	FORD	E-150 ECONOLINE
14055	03-14	FORD	E-250
14055	00-02	FORD	E-250 ECONOLINE
14055	00-14	FORD	E-350 SUPER DUTY
14061	11-14	CHEVROLET	SILVERADO 2500 HD
14061	11-14	CHEVROLET	SILVERADO 3500 HD
14061	11-14	GMC	SIERRA 2500 HD
14061	11-14	GMC	SIERRA 3500 HD
14062	11-14	CHEVROLET	SILVERADO 2500 HD
14062	11-14	CHEVROLET	SILVERADO 3500 HD
14062	11-14	GMC	SIERRA 2500 HD
14062	11-14	GMC	SIERRA 3500 HD
14070	07-10	DODGE	RAM 3500
14070	08-10	DODGE	RAM 4500
14070	08-10	DODGE	RAM 5500
14070	11-20	RAM	3500
14070	11-20	RAM	4500
14070	11-20	RAM	5500
14080	02-02	CADILLAC	ESCALADE
14080	02-02	CHEVROLET	AVALANCHE 1500
14080	02-02	CHEVROLET	AVALANCHE 2500
14080	00-02	CHEVROLET	SUBURBAN 1500
14080	00-02	CHEVROLET	SUBURBAN 2500
14080	00-02	CHEVROLET	TAHOE
14080	00-02	GMC	YUKON
14081	88-99	CHEVROLET	C1500
14081	88-00	CHEVROLET	C2500
14081	88-00	CHEVROLET	C3500
14081	88-99	CHEVROLET	K1500
14081	88-00	CHEVROLET	K2500
14081	88-00	CHEVROLET	K3500
14081	88-99	GMC	C1500
14081	88-00	GMC	C2500
14081	88-00	GMC	C3500
14081	88-99	GMC	K1500
14081	88-00	GMC	K2500
14081	88-00	GMC	K3500
14082	75-86	CHEVROLET	C10
14082	75-86	CHEVROLET	C20
14082	88-00	CHEVROLET	C2500
14082	75-86	CHEVROLET	C30
14082	88-00	CHEVROLET	C3500
14082	91-02	CHEVROLET	C3500HD
14082	75-86	CHEVROLET	K10
14082	75-86	CHEVROLET	K20
14082	88-00	CHEVROLET	K2500
14082	75-86	CHEVROLET	K30
14082	88-00	CHEVROLET	K3500
14082	99-99	CHEVROLET	SILVERADO 2500

Part #	Years	Make	Model
14082	01-06	CHEVROLET	SILVERADO 3500
14082	07-07	CHEVROLET	SILVERADO 3500 CLASSIC
14082	88-97	FORD	F SUPER DUTY
14082	75-79	FORD	F-250
14082	75-97	FORD	F-350
14082	75-78	GMC	C15
14082	79-86	GMC	C1500
14082	75-78	GMC	C25
14082	79-00	GMC	C2500
14082	75-78	GMC	C35
14082	79-00	GMC	C3500
14082	91-02	GMC	C3500HD
14082	75-78	GMC	K15
14082	79-86	GMC	K1500
14082	75-78	GMC	K25
14082	79-00	GMC	K2500
14082	75-78	GMC	K35
14082	79-00	GMC	K3500
14082	99-99	GMC	SIERRA 2500
14082	01-06	GMC	SIERRA 3500
14082	07-07	GMC	SIERRA 3500 CLASSIC
14090	96-14	CHEVROLET	EXPRESS 1500
14090	96-20	CHEVROLET	EXPRESS 2500
14090	96-20	CHEVROLET	EXPRESS 3500
14090	96-14	GMC	SAVANA 1500
14090	96-20	GMC	SAVANA 2500
14090	96-20	GMC	SAVANA 3500
14108	01-06	CHEVROLET	SILVERADO 2500 HD
14108	07-07	CHEVROLET	SILVERADO 2500 HD CL
14108	01-06	GMC	SIERRA 2500 HD
14108	07-07	GMC	SIERRA 2500 HD CLASSIC
14211	01-10	CHEVROLET	SILVERADO 2500 HD
14211	07-07	CHEVROLET	SILVERADO 2500 HD CL
14211	01-06	CHEVROLET	SILVERADO 3500
14211	07-07	CHEVROLET	SILVERADO 3500 CL
14211	07-10	CHEVROLET	SILVERADO 3500 HD
14211	01-10	GMC	SIERRA 2500 HD
14211	07-07	GMC	SIERRA 2500 HD CLASSIC
14211	07-10	GMC	SIERRA 3500 HD
14211	01-10	GMC	SIERRA 3500
14211	07-07	GMC	SIERRA 3500 CLASSIC
14211	07-10	GMC	SIERRA 3500 HD
14250	03-06	DODGE	SPRINTER 2500
14250	03-06	DODGE	SPRINTER 3500
14258	16-20	RAM	2500
14258	16-20	RAM	3500
14301	07-18	CHEVROLET	SILVERADO 1500
14301	19-19	CHEVROLET	SILVERADO 1500 LD
14301	07-18	GMC	SIERRA 1500
14301	19-19	GMC	SIERRA 1500 LIMITED
14332	99-06	CHEVROLET	SILVERADO 1500
14332	07-07	CHEVROLET	SILVERADO 1500 CL
14332	01-06	CHEVROLET	SILVERADO 1500 HD
14332	07-07	CHEVROLET	SILVERADO 1500 HD CL
14332	99-04	CHEVROLET	SILVERADO 2500
14332	99-06	GMC	SIERRA 1500
14332	07-07	GMC	SIERRA 1500 CLASSIC
14332	01-06	GMC	SIERRA 1500 HD
14332	07-07	GMC	SIERRA 1500 HD CLASSIC
14332	99-04	GMC	SIERRA 2500
14355	97-03	FORD	F-150
14355	04-04	FORD	F-150 HERITAGE
14355	97-99	FORD	F-250
14355	99-15	FORD	F-250 SUPER DUTY
14355	99-16	FORD	F-350 SUPER DUTY
14355	08-16	FORD	F-450 SUPER DUTY
14357	04-05	FORD	F-150
14360	06-08	FORD	F-150
14360	06-08	LINCOLN	MARK LT
14361	02-08	DODGE	RAM 1500
14361	03-10	DODGE	RAM 2500
14361	03-10	DODGE	RAM 3500
14361	11-20	RAM	2500
14361	11-20	RAM	3500
14374	09-10	DODGE	RAM 1500
14374	11-18	RAM	1500

Part #	Years	Make	Model
14374	19-21	RAM	1500 CLASSIC
15005	19-21	RAM	1500
15007	20-20	CHEVROLET	SILVERADO 2500 HD
15007	20-20	CHEVROLET	SILVERADO 3500 HD
15007	20-20	GMC	SIERRA 2500 HD
15007	20-20	GMC	SIERRA 3500 HD
15010	20-20	CHEVROLET	SILVERADO 2500 HD
15010	20-20	CHEVROLET	SILVERADO 3500 HD
15010	20-20	GMC	SIERRA 2500 HD
15010	20-20	GMC	SIERRA 3500 HD
15300	75-89	DODGE	D100
15300	68-74	DODGE	D100 PICKUP
15300	77-93	DODGE	D150
15300	68-74	DODGE	D200 PICKUP
15300	81-93	DODGE	D250
15300	68-74	DODGE	D300 PICKUP
15300	81-93	DODGE	D350
15300	94-02	DODGE	RAM 1500
15300	94-02	DODGE	RAM 2500
15300	94-02	DODGE	RAM 3500
15300	78-96	FORD	BRONCO
15300	73-83	FORD	F-100
15300	75-96	FORD	F-150
15300	73-97	FORD	F-250
15300	73-97	FORD	F-350
15302	01-10	CHEVROLET	SILVERADO 2500 HD
15302	07-07	CHEVROLET	SILVERADO 2500 HD CL
15302	01-10	GMC	SIERRA 2500 HD
15302	07-07	GMC	SIERRA 2500 HD CLASSIC
15303	97-03	FORD	F-150
15303	97-99	FORD	F-250
15306	16-20	NISSAN	TITAN XD
15307	19-20	CHEVROLET	SILVERADO 1500
15307	19-20	GMC	SIERRA 1500
15312	01-10	CHEVROLET	SILVERADO 2500 HD
15312	07-07	CHEVROLET	SILVERADO 2500 HD CL
15312	01-06	CHEVROLET	SILVERADO 3500
15312	07-07	CHEVROLET	SILVERADO 3500 CL
15312	07-10	CHEVROLET	SILVERADO 3500 HD
15312	01-10	GMC	SIERRA 2500 HD
15312	07-07	GMC	SIERRA 2500 HD CLASSIC
15312	01-06	GMC	SIERRA 3500
15312	07-07	GMC	SIERRA 3500 CLASSIC
15312	07-10	GMC	SIERRA 3500 HD
15313	01-10	CHEVROLET	SILVERADO 2500 HD
15313	07-07	CHEVROLET	SILVERADO 2500 HD CL
15313	01-06	CHEVROLET	SILVERADO 3500
15313	07-07	CHEVROLET	SILVERADO 3500 CL
15313	07-10	CHEVROLET	SILVERADO 3500 HD
15313	01-10	GMC	SIERRA 2500 HD
15313	07-07	GMC	SIERRA 2500 HD CLASSIC
15313	01-06	GMC	SIERRA 3500
15313	07-07	GMC	SIERRA 3500 CLASSIC
15313	07-10	GMC	SIERRA 3500 HD
15316	99-03	FORD	F-250 SUPER DUTY
15316	99-03	FORD	F-350 SUPER DUTY
15317	88-00	CHEVROLET	C2500
15317	88-00	CHEVROLET	C3500
15317	91-00	CHEVROLET	C3500HD
15317	88-00	CHEVROLET	K2500
15317	88-00	CHEVROLET	K3500
15317	88-00	GMC	C2500
15317	88-00	GMC	C3500
15317	88-00	GMC	K2500
15317	88-00	GMC	K3500
15318	94-02	DODGE	RAM 2500
15318	94-98	DODGE	RAM 3500
15319	94-02	DODGE	RAM 2500
15319	94-02	DODGE	RAM 3500
15320	96-14	CHEVROLET	EXPRESS 1500
15320	96-20	CHEVROLET	EXPRESS 2500
15320	96-20	CHEVROLET	EXPRESS 3500
15320	96-14	GMC	SAVANA 1500
15320	96-20	GMC	SAVANA 2500
15320	96-20	GMC	SAVANA 3500

Part #	Years	Make	Model
15323	99-13	CHEVROLET	SILVERADO 1500
15323	07-07	CHEVROLET	SILVERADO 1500 CL
15323	01-06	CHEVROLET	SILVERADO 1500 HD
15323	07-07	CHEVROLET	SILVERADO 1500 HD CL
15323	99-04	CHEVROLET	SILVERADO 2500
15323	99-13	GMC	SIERRA 1500
15323	07-07	GMC	SIERRA 1500 CLASSIC
15323	01-06	GMC	SIERRA 1500 HD
15323	07-07	GMC	SIERRA 1500 HD CLASSIC
15323	99-04	GMC	SIERRA 2500
15324	03-06	CADILLAC	ESCALADE
15324	03-06	CADILLAC	ESCALADE ESV
15324	03-06	CADILLAC	ESCALADE EXT
15324	03-06	CHEVROLET	AVALANCHE 1500
15324	03-06	CHEVROLET	AVALANCHE 2500
15324	03-06	CHEVROLET	SUBURBAN 1500
15324	03-06	CHEVROLET	SUBURBAN 2500
15324	03-06	CHEVROLET	TAHOE
15324	03-06	GMC	YUKON
15325	88-99	CHEVROLET	C1500
15325	88-00	CHEVROLET	C2500
15325	88-00	CHEVROLET	C3500
15325	88-99	CHEVROLET	K1500
15325	88-00	CHEVROLET	K2500
15325	88-00	CHEVROLET	K3500
15325	88-99	GMC	C1500
15325	88-00	GMC	C2500
15325	88-00	GMC	C3500
15325	88-99	GMC	K1500
15325	88-00	GMC	K2500
15325	88-00	GMC	K3500
15363	11-12	CHEVROLET	SILVERADO 2500 HD
15363	11-12	CHEVROLET	SILVERADO 3500 HD
15363	11-12	GMC	SIERRA 2500 HD
15363	11-12	GMC	SIERRA 3500 HD
15398	07-20	TOYOTA	TUNDRA
15400	99-99	CHEVROLET	SILVERADO 2500
15400	01-06	CHEVROLET	SILVERADO 3500
15400	07-07	CHEVROLET	SILVERADO 3500 CL
15400	07-20	CHEVROLET	SILVERADO 3500 HD
15400	07-10	DODGE	RAM 3500
15400	08-10	DODGE	RAM 4500
15400	08-10	DODGE	RAM 5500
15400	99-99	GMC	SIERRA 2500
15400	01-06	GMC	SIERRA 3500
15400	07-07	GMC	SIERRA 3500 CLASSIC
15400	07-20	GMC	SIERRA 3500 HD
15400	11-20	RAM	3500
15400	11-20	RAM	4500
15400	11-20	RAM	5500
15401	16-20	RAM	2500
15401	16-20	RAM	3500
15402	20-20	FORD	F-350 SUPER DUTY
15409	03-08	DODGE	RAM 1500
15409	03-10	DODGE	RAM 2500
15409	03-10	DODGE	RAM 3500
15409	11-20	RAM	2500
15409	11-13	RAM	3500
15410	99-16	FORD	F-250 SUPER DUTY
15410	99-16	FORD	F-350 SUPER DUTY
15410	08-16	FORD	F-450 SUPER DUTY
15445	99-20	FORD	F-350 SUPER DUTY
15445	99-20	FORD	F-450 SUPER DUTY
15445	99-20	FORD	F-550 SUPER DUTY
15445	00-20	FORD	F650
15460	11-19	CHEVROLET	SILVERADO 2500 HD
15460	11-19	CHEVROLET	SILVERADO 3500 HD
15460	11-19	GMC	SIERRA 2500 HD
15460	11-19	GMC	SIERRA 3500 HD
15510	0-0	(BLANK)	(BLANK)
15511	0-0	(BLANK)	(BLANK)
15572	09-10	DODGE	RAM 1500
15572	11-18	RAM	1500
15572	19-21	RAM	1500 CLASSIC
15703	01-04	CHEVROLET	SILVERADO 2500

Part #	Years	Make	Model
15703	01-10	CHEVROLET	SILVERADO 2500 HD
15703	07-07	CHEVROLET	SILVERADO 2500 HD CL
15703	01-06	CHEVROLET	SILVERADO 3500
15703	07-07	CHEVROLET	SILVERADO 3500 CL
15703	07-10	CHEVROLET	SILVERADO 3500 HD
15703	01-04	GMC	SIERRA 2500
15703	01-10	GMC	SIERRA 2500 HD
15703	07-07	GMC	SIERRA 2500 HD CLASSIC
15703	01-06	GMC	SIERRA 3500
15703	07-07	GMC	SIERRA 3500 CLASSIC
15703	07-10	GMC	SIERRA 3500 HD
15704	03-08	DODGE	RAM 1500
15704	03-10	DODGE	RAM 2500
15704	03-10	DODGE	RAM 3500
15704	11-15	RAM	2500
15704	11-15	RAM	3500
15800	99-99	CHEVROLET	SILVERADO 2500
15800	01-06	CHEVROLET	SILVERADO 3500
15800	07-07	CHEVROLET	SILVERADO 3500 CL
15800	07-20	CHEVROLET	SILVERADO 3500 HD
15800	07-10	DODGE	RAM 3500
15800	08-10	DODGE	RAM 4500
15800	08-10	DODGE	RAM 5500
15800	99-99	GMC	SIERRA 2500
15800	01-06	GMC	SIERRA 3500
15800	07-07	GMC	SIERRA 3500 CLASSIC
15800	07-20	GMC	SIERRA 3500 HD
15800	11-20	RAM	3500
15800	11-20	RAM	4500
15800	11-20	RAM	5500
15801	16-20	RAM	2500
15801	16-20	RAM	3500
15802	17-20	FORD	F-250 SUPER DUTY
15802	17-20	FORD	F-350 SUPER DUTY
15802	17-20	FORD	F-450 SUPER DUTY
15803	14-17	RAM	3500
15804	20-20	FORD	F-350 SUPER DUTY
15808	14-16	RAM	3500
15809	03-08	DODGE	RAM 1500
15809	03-10	DODGE	RAM 2500
15809	03-10	DODGE	RAM 3500
15809	11-20	RAM	2500
15809	11-13	RAM	3500
15810	99-16	FORD	F-250 SUPER DUTY
15810	99-16	FORD	F-350 SUPER DUTY
15810	08-16	FORD	F-450 SUPER DUTY
15845	99-20	FORD	F-350 SUPER DUTY
15845	99-20	FORD	F-450 SUPER DUTY
15845	99-20	FORD	F-550 SUPER DUTY
15845	00-20	FORD	F650
15860	11-19	CHEVROLET	SILVERADO 2500 HD
15860	11-19	CHEVROLET	SILVERADO 3500 HD
15860	11-19	GMC	SIERRA 2500 HD
15860	11-19	GMC	SIERRA 3500 HD
31008	08-10	FORD	F-250 SUPER DUTY
31008	08-10	FORD	F-350 SUPER DUTY
31008	08-10	FORD	F-450 SUPER DUTY
31008	08-10	FORD	F-550 SUPER DUTY
31012	07-20	CADILLAC	ESCALADE
31012	07-13	CADILLAC	ESCALADE EXT
31012	07-13	CHEVROLET	AVALANCHE
31012	14-18	CHEVROLET	SILVERADO 1500
31012	19-19	CHEVROLET	SILVERADO 1500 LD
31012	07-14	CHEVROLET	SUBURBAN 1500
31012	07-14	CHEVROLET	TAHOE
31012	14-18	GMC	SIERRA 1500
31012	19-19	GMC	SIERRA 1500 LIMITED
31012	07-14	GMC	YUKON
31013	01-04	TOYOTA	TACOMA
31014	99-03	FORD	F-250 SUPER DUTY
31014	99-03	FORD	F-350 SUPER DUTY
31015	10-10	DODGE	RAM 2500
31015	11-18	RAM	2500
31016	96-03	CHEVROLET	EXPRESS 1500
31016	96-03	CHEVROLET	EXPRESS 2500

Part #	Years	Make	Model
31016	96-03	CHEVROLET	EXPRESS 3500
31016	96-03	GMC	SAVANA 1500
31016	96-03	GMC	SAVANA 2500
31016	96-03	GMC	SAVANA 3500
31017	06-08	DODGE	RAM 1500
31017	03-09	DODGE	RAM 2500
31017	03-09	DODGE	RAM 3500
31018	11-16	FORD	F-250 SUPER DUTY
31018	11-16	FORD	F-350 SUPER DUTY
31020	08-13	JEEP	LIBERTY
31021	96-04	CHEVROLET	BLAZER
31021	94-04	CHEVROLET	S10
31021	94-01	GMC	JIMMY
31021	94-04	GMC	SONOMA
31022	03-07	JEEP	LIBERTY
31023	11-14	CHEVROLET	SILVERADO 2500 HD
31023	11-14	CHEVROLET	SILVERADO 3500 HD
31023	11-14	GMC	SIERRA 2500 HD
31023	11-14	GMC	SIERRA 3500 HD
31024	09-11	HONDA	PILOT
31025	11-12	FORD	ESCAPE
31025	11-11	MERCURY	MARINER
31026	92-96	FORD	F-150
31028	97-06	JEEP	WRANGLER
31029	01-05	FORD	EXPLORER SPORT TRAC
31030	10-12	CHEVROLET	COLORADO
31030	10-12	GMC	CANYON
31032	10-13	CHEVROLET	EQUINOX
31032	10-13	GMC	TERRAIN
31033	11-20	DODGE	DURANGO
31033	11-17	JEEP	GRAND CHEROKEE
31034	10-11	HYUNDAI	SANTA FE
31038	99-02	FORD	EXPEDITION
31038	99-03	FORD	F-150
31038	04-04	FORD	F-150 HERITAGE
31038	99-99	FORD	F-250
31042	92-94	CHEVROLET	BLAZER
31042	88-99	CHEVROLET	C1500
31042	88-99	CHEVROLET	K1500
31042	92-99	CHEVROLET	K1500 SUBURBAN
31042	88-00	CHEVROLET	K2500
31042	92-99	CHEVROLET	K2500 SUBURBAN
31042	88-00	CHEVROLET	K3500
31042	95-99	CHEVROLET	TAHOE
31042	88-99	GMC	C1500
31042	88-99	GMC	K1500
31042	92-99	GMC	K1500 SUBURBAN
31042	88-00	GMC	K2500
31042	92-99	GMC	K2500 SUBURBAN
31042	88-00	GMC	K3500
31042	92-99	GMC	YUKON
31043	92-99	CHEVROLET	C1500 SUBURBAN
31043	88-00	CHEVROLET	C2500
31043	92-99	CHEVROLET	C2500 SUBURBAN
31043	88-00	CHEVROLET	C3500
31043	92-99	GMC	C1500 SUBURBAN
31043	88-00	GMC	C2500
31043	92-99	GMC	C2500 SUBURBAN
31043	88-00	GMC	C3500
31045	08-12	BUICK	ENCLAVE
31045	09-12	CHEVROLET	TRAVERSE
31045	09-11	GMC	ACADIA
31047	05-10	JEEP	GRAND CHEROKEE
31048	02-04	JEEP	GRAND CHEROKEE
31049	97-98	FORD	EXPEDITION
31049	97-98	FORD	F-150
31049	97-98	FORD	F-250
31050	11-13	FORD	EDGE
31051	97-01	FORD	EXPLORER
31052	11-16	FORD	EXPLORER
31053	08-14	FORD	E-150
31053	08-14	FORD	E-250
31053	08-14	FORD	E-350 SUPER DUTY
31054	10-20	TOYOTA	4RUNNER
31055	04-07	BUICK	RAINIER

Part #	Years	Make	Model
31055	02-09	CHEVROLET	TRAILBLAZER
31055	02-09	GMC	ENVOY
31056	06-10	JEEP	COMMANDER
31061	09-15	NISSAN	TITAN
31063	92-11	FORD	RANGER
31064	12-15	HONDA	PILOT
31065	10-10	DODGE	RAM 3500
31065	11-12	RAM	3500
31067	13-18	RAM	3500
31068	09-17	FORD	EXPEDITION
31068	09-14	FORD	F-150
31068	09-17	LINCOLN	NAVIGATOR
31069	14-18	CHEVROLET	SILVERADO 1500
31069	19-19	CHEVROLET	SILVERADO 1500 LD
31069	14-18	GMC	SIERRA 1500
31069	19-19	GMC	SIERRA 1500 LIMITED
31071	15-19	CHEVROLET	SILVERADO 2500 HD
31071	15-19	CHEVROLET	SILVERADO 3500 HD
31071	15-19	GMC	SIERRA 2500 HD
31071	15-19	GMC	SIERRA 3500 HD
31073	15-20	CHEVROLET	SUBURBAN
31073	15-20	CHEVROLET	TAHOE
31073	15-20	GMC	YUKON
31073	15-20	GMC	YUKON XL
31074	15-20	CHEVROLET	COLORADO
31074	15-20	GMC	CANYON
31075	16-20	TOYOTA	TACOMA
31076	14-21	TOYOTA	4RUNNER
31077	16-17	NISSAN	TITAN XD
31078	17-20	FORD	F-250 SUPER DUTY
31078	17-20	FORD	F-350 SUPER DUTY
31078	17-19	FORD	F-450 SUPER DUTY
31080	00-04	DODGE	DAKOTA
31080	00-03	DODGE	DURANGO
31081	17-20	NISSAN	ARMADA
31082	17-20	HONDA	RIDGELINE
31083	18-20	FORD	EXPEDITION
31083	15-20	FORD	F-150
31084	84-01	JEEP	CHEROKEE
31084	86-92	JEEP	COMANCHE
31084	84-90	JEEP	WAGONEER
31086	20-21	JEEP	GLADIATOR
31086	18-21	JEEP	WRANGLER
31087	19-21	RAM	1500
31088	19-20	CHEVROLET	SILVERADO 1500
31088	19-20	GMC	SIERRA 1500
31089	19-20	RAM	2500
31090	19-21	RAM	1500
31097	98-99	DODGE	DAKOTA
31097	98-99	DODGE	DURANGO
31108	01-06	CHEVROLET	SILVERADO 1500 HD
31108	07-07	CHEVROLET	SILVERADO 1500 HD CL
31108	99-04	CHEVROLET	SILVERADO 2500
31108	01-06	CHEVROLET	SILVERADO 2500 HD
31108	07-07	CHEVROLET	SILVERADO 2500 HD CL
31108	01-06	CHEVROLET	SILVERADO 3500
31108	07-07	CHEVROLET	SILVERADO 3500 CL
31108	01-06	CHEVROLET	SUBURBAN 2500
31108	01-06	GMC	SIERRA 1500 HD
31108	07-07	GMC	SIERRA 1500 HD CLASSIC
31108	99-04	GMC	SIERRA 2500
31108	01-06	GMC	SIERRA 2500 HD
31108	07-07	GMC	SIERRA 2500 HD CLASSIC
31108	01-06	GMC	SIERRA 3500
31108	07-07	GMC	SIERRA 3500 CLASSIC
31108	01-06	GMC	YUKON XL 2500
31109	07-10	CHEVROLET	SILVERADO 2500 HD
31109	07-10	CHEVROLET	SILVERADO 3500 HD
31109	07-10	GMC	SIERRA 2500 HD
31109	07-10	GMC	SIERRA 3500 HD
31114	00-05	FORD	EXCURSION
31114	99-07	FORD	F-250 SUPER DUTY
31114	99-07	FORD	F-350 SUPER DUTY
31114	99-07	FORD	F-450 SUPER DUTY
31114	99-07	FORD	F-550 SUPER DUTY

Part #	Years	Make	Model
31180	01-07	TOYOTA	SEQUOIA
31180	00-06	TOYOTA	TUNDRA
31198	08-18	TOYOTA	LAND CRUISER
31198	08-20	TOYOTA	SEQUOIA
31198	07-20	TOYOTA	TUNDRA
31199	04-08	NISSAN	TITAN
31221	04-12	CHEVROLET	COLORADO
31221	04-12	GMC	CANYON
31228	05-07	DODGE	DAKOTA
31230	08-10	DODGE	DAKOTA
31230	08-09	MITSUBISHI	RAIDER
31241	05-20	NISSAN	FRONTIER
31241	05-12	NISSAN	PATHFINDER
31241	09-12	SUZUKI	EQUATOR
31270	06-10	HUMMER	H3
31297	07-09	CHRYSLER	ASPEN
31297	04-09	DODGE	DURANGO
31302	00-06	CADILLAC	ESCALADE
31302	02-06	CHEVROLET	AVALANCHE 1500
31302	02-06	CHEVROLET	AVALANCHE 2500
31302	99-06	CHEVROLET	SILVERADO 1500
31302	07-07	CHEVROLET	SILVERADO 1500 CL
31302	00-06	CHEVROLET	SUBURBAN 1500
31302	00-06	CHEVROLET	TAHOE
31302	99-06	GMC	SIERRA 1500
31302	07-07	GMC	SIERRA 1500 CLASSIC
31302	00-06	GMC	YUKON
31302	00-06	GMC	YUKON XL 1500
31310	92-97	FORD	F-250
31310	92-97	FORD	F-350
31311	92-97	FORD	F-250
31311	92-97	FORD	F-350
31313	05-15	TOYOTA	TACOMA
31320	02-08	DODGE	RAM 1500
31321	06-07	DODGE	RAM 1500
31322	07-13	CHEVROLET	SILVERADO 1500
31322	07-13	GMC	SIERRA 1500
31352	03-06	FORD	EXPEDITION
31352	04-08	FORD	F-150
31352	06-08	LINCOLN	MARK LT
31367	07-13	TOYOTA	4RUNNER
31367	07-14	TOYOTA	FJ CRUISER
31368	07-08	FORD	EXPEDITION
31368	07-08	LINCOLN	NAVIGATOR
31374	09-10	DODGE	RAM 1500
31374	11-18	RAM	1500
31374	19-21	RAM	1500 CLASSIC
31407	01-05	FORD	EXPLORER SPORT TRAC
31408	87-06	JEEP	WRANGLER
31432	07-18	JEEP	WRANGLER
31433	07-18	JEEP	WRANGLER
31514	05-15	NISSAN	XTERRA
31540	02-06	FORD	EXPLORER
31545	07-10	FORD	EXPLORER
31545	07-10	FORD	EXPLORER SPORT TRAC
31545	07-10	MERCURY	MOUNTAINEER
31604	94-01	DODGE	RAM 1500
31604	94-02	DODGE	RAM 2500
31604	94-02	DODGE	RAM 3500
31650	05-10	FORD	ESCAPE
31650	05-11	MAZDA	TRIBUTE
31650	05-10	MERCURY	MARINER
33055	03-07	FORD	E-150
33055	91-02	FORD	E-150 ECONOLINE
33055	03-07	FORD	E-250
33055	91-02	FORD	E-250 ECONOLINE
33055	91-98	FORD	E-350 ECONOLINE
33055	99-07	FORD	E-350 SUPER DUTY
33328	03-08	HONDA	PILOT
33328	06-14	HONDA	RIDGELINE

ALL PRODUCTS LISTED NUMERICALLY

Part#	Description	Page#
16000	LOOP,SAFETY CHAIN,5TH WHEEL	212
16017	FORD OEM 5TH WHEEL LEGS	203
16020	ROLLER,FORD PUCK	203
16021	OEM 5TH WHEEL LEG KIT-CHRYSLER	203
16022	RAM OE ROLLER MOUNT	203
16023	GM OE ROLLER ADAPTER	203
16024	GM DIRECT MOUNT 5TH WHEEL LEGS	203
16025	GM OEM 5TH WHEEL LEGS	203
16026	NISSAN TITAN XD 5TH WHEEL	203
16027	ISR TO PUCK ADAPTER FORD_20GMC	202
16029	2020 GM HD 5TH WHEEL LEGS 25K	203
16031	KIT, 16017 & 16515	200
16033	KIT, 16017 & 16520	192
16034	KIT, 16017 & 16540	192
16035	KIT, 16017 & 16530	196
16036	KIT, 16017 & 16580	192
16037	KIT, 16017 & 16545	196
16039	KIT, 16017 & 16565	196
16041	KIT, 16021 & 16515	200
16043	KIT, 16021 & 16520	192
16044	KIT, 16021 & 16540	192
16045	KIT, 16021 & 16530	196
16046	KIT, 16021 & 16580	192
16047	KIT, 16021 & 16545	196
16049	KIT, 16021 & 16565	196
16055	RAIL MOUNTED GOOSENECK HITCH	242
16061	KIT, 16025 & 16515	200
16063	KIT, 16025 & 16520	192
16064	KIT, 16025 & 16540	192
16065	KIT, 16025 & 16530	196
16066	KIT, 16025 & 16580	192
16067	KIT, 16025 & 16545	196
16069	KIT, 16025 & 16565	196
16070	KIT, 16590 & 16024	192
16071	KIT, 16026 & 16515	200
16073	KIT, 16026 & 16520	192
16074	KIT, 16026 & 16540	192
16075	KIT, 16026 & 16530	196
16085	RAIL MOUNTED GOOSENECK HITCH	242
16091	KIT, 16520 & 16029	192
16092	KIT, 16540 & 16029	192
16093	KIT, 16580 & 16029	192
16094	KIT, 16530 & 16029	196
16095	KIT, 16545 & 16029	196
16096	KIT, 16565 & 16029	196
16097	KIT, 16515 & 16029	200
16100	5TH WHEEL MOUNTING RAIL KIT	206
16101	INSTALLATION HARDWARE KIT FOR	206
16103	BOLT KIT,FIFTH WHEEL, 8PC	206
16104	5TH WHEEL RAIL KIT,NO HARDWARE	206
16111	UNIVERSAL RAIL HARDWARE KIT	206
16115	16K 5TH WHEEL UNIT	199
16116	KIT, 16115 & 16200	199
16120	A16 5TH WHEEL	191
16121	A16 5TH WHEEL WITH BASE RAILS	191
16130	CURT Q20 20K 5TH WHEEL HITCH	195
16131	KIT, 16130 & 16200	195
16140	A20 5TH WHEEL HITCH	191
16141	A20 5TH WHEEL WITH BASE RAILS	191
16150	RAILS,5TH WHL,W/CNTR HOLES,CB	206
16180	A25 5TH WHEEL HITCH	191
16181	A25 5TH WHEEL WITH BASE RAILS*	191
16190	A30 5TH WHEEL HITCH	191
16191	A30 HITCH HITCH W/ BASE RAILS	191
16200	CARBIDE BLACK 5TH WHEEL RAIL K	206
16204	CARBIDE 5TH WHEEL RAILS	206
16210	X5 ADAPTER PLATE	209
16220	X5 ADAPTER PLATE	209
16245	FIFTH WHEEL, Q24	195
16246	KIT,16245 & 16200	195
16265	FIFTH WHEEL, Q25	195
16266	KIT,16265 & 16200	195
16300	CUSTOM 5TH WHEEL INSTALL KIT	207
16301	CUSTOM 5TH WHEEL INSTALL KIT	207
16302	CUSTOM 5TH WHEEL INSTALL KIT	207
16303	CUSTOM 5TH WHEEL INSTALL KIT	207

Part#	Description	Page#
16304	TUNDRA UNIVERSAL RAIL BOLT KIT	207
16306	DODGE 5TH WHEEL UNDERBED KIT	207
16307	RAM 5TH WHEEL UNDERBED KIT	207
16310	X5 B & W ADAPTER PLATE	209
16400	GM 5TH WHL UNDERBED KIT	207
16411	CHEVY/GMC UNDERBED 5TH WHL KIT	207
16415	GM 5TH WHEEL UNDER BED KIT	207
16418	CHEVY/GMC UNDERBED 5TH WHL KIT	207
16419	DODGE 5TH WHEEL UNDERBED KIT	207
16420	DODGE UNDERBED FIFTH WHEEL KIT	207
16422	DODGE UNDERBED FIFTH WHEEL KIT	207
16424	FORD 5TH WHEEL UNDERBED KIT	207
16426	RAM UNDERBED FIFTH WHEEL KIT	207
16427	RAM UNDERBED FIFTH WHEEL KIT	207
16428	FORD SUPER DTY FIFTH WHEEL KIT	207
16429	GM HD 5TH WHEEL UNDERBED KIT	207
16430	RAM UNDERBED 5TH WHEEL KIT	207
16437	FORD 5TH WHEEL UNDERBED KIT	207
16441	FORD F150 UNDERBED 5TH WHL KIT	207
16442	FORD F-150 5TH WHEEL KIT	207
16443	FORD UNDERBED 5TH WHEEL KIT	207
16444	RAM UNDERBED 5TH WHEEL KIT	207
16448	FORD SD UNDERBED 5TH WHEEL KIT	207
16465	TOYOTA TUNDRA UNDERBED 5TH WHL	207
16468	TOYOTA 5TH WHEEL UNDERBED KIT	207
16469	2019 CHEVY 1500 5TH WHEEL KIT	207
16470	NISSAN TITAN FIFTH WHEEL KIT	207
16505	16115 E5 ADAPTER KIT	201
16515	16515 E5 FIFTH WHEEL HEAD ONLY	199
16516	KIT, 16515 & 16560	199
16520	A16 5TH WHEEL HEAD UNIT	191
16521	A16 5TH WHEEL WITH R16 ROLLER	191
16530	HEAD, FIFTH WHEEL,Q20	195
16536	KIT,16530 & 16550	195
16540	A20 5TH WHEEL HEAD UNIT	191
16541	A20 5TH WHEEL WITH R20 ROLLER	191
16545	HEAD,FIFTH WHEEL,Q24	195
16546	KIT,16545 & 16570	195
16550	ROLLER,FIFTH WHEEL,R20	205
16560	ROLLER,FIFTH WHEEL, R16	205
16565	HEAD,FIFTH WHEEL,Q25	195
16566	KIT,16565 & 16570	195
16570	ROLLER, FIFTH WHEEL, R24	205
16580	A25 5TH WHEEL HEAD UNIT	191
16590	A30 5TH WHEEL HEAD	191
16616	KIT, 16515, 16560 & 16200	199
16621	A16 5TH WHEEL,R16 ROLLER/RAILS	191
16636	KIT,16530,16550 & 16200	195
16641	A20 5TH WHEEL,R20 ROLLER/RAILS	191
16646	KIT,16545,16570 & 16200	195
16667	KIT, 16023 & 16560 & 16515	200
16668	KIT, 16023 & 16560 & 16520	192
16669	KIT, 16023 & 16550 & 16540	192
16671	KIT, 16023 & 16550 & 16530	196
16674	KIT, 16515 & 16020	200
16675	KIT, 16520 & 16020	192
16676	KIT, 16540 & 16020	192
16677	KIT, 16530 & 16020	196
16678	KIT, 16545 & 16020	196
16684	KIT, 16022 & 16560 & 16515	200
16685	KIT, 16022 & 16560 & 16520	192
16686	KIT, 16022 & 16550 & 16540	192
16687	KIT, 16022 & 16550 & 16530	196
16688	KIT, 16022 & 16545 & 16570	196
16721	10 IN 5TH WHEEL LUBE PLATE	211
16722	LUBE PLATE,5TH WHEEL,12 INCH	211
16900	SPACER KIT,5TH WHL TAB MT	212
16901	SPACER KIT,5TH WHL TAB MT,CLAM	212
16902	5TH WHEEL REPL PINS AND CLIPS	193
16904	16130 SERVICE KIT,LEGS (PAIR)	197
16906	16140 A20 LEG KIT	193
16907	5TH WHEEL LEG KIT	193
16913	Q24 LEG KIT	197
16920	16120 - LEG KIT	193
16963	Q25 LEG KIT	197
16991	E16 WEDGE KIT	211

Part#	Description	Page#
16992	Q16 WEDGE KIT	211
17003	SNAP-UP BRACKET WD BARS CLAMP	181
17005	SNAP-UP BRACKET WD BAR BOLTON	181
17008	WD,HOOK-UP BRKT,SINGLE LP	178
17050	600 TW ROUND BAR WD	179
17051	800 TW ROUND BAR WD	179
17052	1000 TW ROUND BAR WD	179
17057	1400 TW ROUND BAR WD	179
17062	1000 TW ROUND BAR WD W/SWAY	179
17063	1400 TW ROUND BAR WD W/SWAY	179
17071	600 TW REPLACEMENT ROUND BAR	179
17072	800 TW REPLACEMENT ROUND BAR	179
17073	1000 TW REPLACEMENT ROUND BAR	179
17074	1400 TW REPLACEMENT ROUND BAR	179
17075	WD REPLACEMENT HEAD	179
17076	BOLT KIT	179
17100	ADJ HITCH BAR 12 IN LENGTH	180
17102	ADJ HITCH BAR 14 IN LENGTH	180
17103	ADJ HITCH BAR 16 IN LENGTH	180
17111	SPRING BAR CHAIN & U-BOLT KIT	179
17112	LIFT HANDLE	178
17120	ADJ HITCH BAR 12 IN X 5 625 IN	180
17121	ADJ HITCH BAR 14 IN X 6 IN WIT	180
17122	ADJ HITCH BAR 16 IN X 6 IN WIT	180
17123	ADJ HITCH BAR 9 IN X 7 IN WITH	180
17124	ADJ HITCH BAR 11 IN X 8 3/4 IN	180
17125	ADJ HITCH BAR 10 IN X 14 1/2 I	180
17131	2.5" FORGED WD SHANK, 7 HOLE	180
17132	2.5" FORGED WD SHANK, 11 HOLE	180
17200	SWAY CONTROL KIT	181
17201	SWAY CONTROL A-FRAME BALL	181
17208	(2)OPTIONAL SNAP UP BRACKETS	179
17300	WEIGHT DISTRIBUTION TRUNNION S	178
17301	WEIGHT DISTRIBUTION TRUNNION S	178
17302	WEIGHT DISTRIBUTION TRUNNION S	178
17303	WD,1000#LONG TBAR REPL W/CHAIN	178
17307	WEIGHT DISTRIBUTION HITCH HEAD	178
17308	WD,800#LONG TBAR REPL W/CHAIN	178
17309	WD,600#LONG TBAR REPL W/CHAIN	178
17312	WD ADJUSTMENT ROD KIT	178
17314	WD WASHER SERVICE KIT	178
17322	WD,TRUNNION,SHORT BAR,1K KIT	178
17330	WD,TRUNNION,SHORT BAR,600 LB	178
17331	WD,TRUNNION,SHORT BAR,800 LB	178
17332	WD,TRUNNION,SHORT BAR,1000 LB	178
17333	WD,TRUNNION,1500 LB	178
17334	WD,600#SHORT TBAR REPL W/CHAIN	178
17335	WD,800#SHORT TBAR REPL W/CHAIN	178
17336	WD,1000#SHORT TBAR REP W/CHAIN	178
17337	1500# SHORT SPRING BAR W/CHAIN	178
17350	BOLT KIT FOR TRUNNION BAR WEIG	178
17422	WD,TRUNNION,1500 LB KIT	178
17499	WD, 800# W/INTEGRATED SWAY	176
17500	WD,1000# W/INTEGRATED SWAY	176
17501	WD 1500# W/INTEGRATED SWAY	176
17506	WD REPLACEMENT HEAD, 17499	177
17507	WD REPLACEMENT HEAD, 17500	177
17508	REPLACEMENT INT-WD BRACKET	177
17509	1500# REPLACEMENT HEAD	177
17512	TRU-TRACK TENSION BAR	177
17513	REPLACEMENT L-PINS & CLIPS	177
17515	REPLACEMENT BRACKET KIT, 8"	177
17516	REPLACEMENT BRACKET KIT, 10"	177
17535	800# REPLACEMENT SPRING BAR	177
17536	1000# REPLACEMENT SPRING BAR	177
17537	1500# REPLACEMENT SPRING BAR	177
17550	BOLT KIT FOR INT-WD	177
17554	BOLT KIT FOR INT-WD, 17501	177
18007	STRAP,REPLACEMENT,QTY 2	269
18013	BIKE RACK,CLAMP-ON	270
18016	BIKE BEAM	270
18029	RACK,2-BIKE,DUAL ARM	269
18030	RACK,2-BIKE,DUAL ARM W/EXT	269
18050	STRAP, BIKE RACK	270
18064	RACK,4-BIKE,TAPERED DUAL ARM	269
18065	RACK,5-BIKE,TAPERED DUAL ARM	269

Part#	Description	Page#
18085	BIKE RACK, 2-BIKE, TRAY STYLE	268
18087	BIKE RACK, 4-BIKE, TRAY STYLE	268
18091	FAT TIRE BIKE RACK TRAYS	268
18100	CARRIER,CARGO,ALUMINUM	276
18101	CARRIER,CARGO,ATV	275
18109	CARGO CARRIER FOLDING 60X20	276
18110	CARGO CARRIER,48"X20" FIXED	276
18112	ALUMINUM CARGO CARRIER W/RAMP	274
18113	ALUMINUM CARGO CARRIER	275
18115	ROOF RACK,EXPANDABLE,43.5X37X4	278
18117	ROOF RACK,EXTENSION,43.5X20X4	278
18118	ALUMINUM CROSSBARS	279
18145	CARGO CARRIER,KNOCK DN,48X20X6	277
18150	CARGO CARRIER BASKET FIXED SHA	277
18151	CARGO CARRIER BASKET FOLDING S	277
18152	CARGO CARRIER,60X24 FIXED	277
18153	CARGO CARRIER,60X24 FOLDING	277
18200	CARGO NET,ROOF RACK	280
18201	CARGO NET,EXTENDED ROOF RACK	280
18202	CARGO NET	280
18210	CARGO CARRIER BAG 18"	280
18211	CARGO CARRIER BAG 22"	280
18220	ROOF RACK BAG 38"	280
18221	ROOF RACK BAG 59"	280
18320	ALUMINUM KAYAK RACK	279
19030	2 IN X 2 IN RECEIVER HITCH	14
19031	2 IN X 2 IN BUMPER HITCH	14
19745	ADJUSTABLE TOW BAR	220
19746	REPLACEMENT SAFETY PIN	220
19748	BUMPER BRACKET KIT	220
19749	TOW BAR BLACK VINYL COATED CHA	257
20001	WRENCH,BOX END,1.125/1.50,6 PT	96
20002	MIRROR	132
21100	REDUCER BUSHING 1 IN TO 3/4 IN	96
21101	REDUCER BUSHING 1 IN TO 3/4 IN	96
21200	REDUCER BUSHING 1 1/4 IN TO 1	96
21201	REDUCER BUSHING 1 1/4 IN TO 1	96
21300	REDUCER BUSHING 1 3/8 TO 1 1/4	96
21301	REDUCER BUSHING 1 3/8" - 1 1/4	96
21400	1/2 IN HITCH PIN WITH CLIP POL	116
21401	1/2 IN HITCH PIN WITH CLIP PAC	116
21403	1/2" GROOVED HITCH PIN & CLIP	116
21404	1/2" GROOVED PIN&CLIP PACKAGED	116
21410	1/2" PIN & CLIP, COATED GRIP	116
21411	1/2" PIN & CLIP, COATED GRIP	116
21500	5/8 IN HITCH PIN WITH CLIP POL	116
21501	5/8 IN HITCH PIN WITH CLIP PAC	116
21502	UNIVERSAL RECEIVER PIN & CLIP	116
21504	5/8" GROOVED HITCH PIN & CLIP	116
21505	5/8" GROOVED PIN&CLIP PACKAGED	116
21506	5/8" GROOVED PIN & CLIP; CARD	116
21507	5/8" GROOVED PIN & CLIP; BULK	116
21510	5/8" PIN & CLIP, COATED GRIP	116
21511	5/8" PIN & CLIP, COATED GRIP	116
21541	HITCH PIN,CHRM,1/2" PIVOT LK	117
21551	5/8 IN CHROME SWIVEL HITCH PIN	117
21561	1/2 IN SWIVL HITCH PIN W/SLEEV	117
21578	5/8 IN HITCH PIN & CLIP BLACK	116
21579	5/8 IN HITCH PIN WITH CLIP BLA	116
21580	5/8" HITCH PIN FOR SUPER DUTY	116
21581	5/8" HITCH PIN SUPER DUTY PKG	116
21582	5/8" CD GROOVED PIN & CLIP	116
21583	5/8" CD GROOVED PIN&CLIP PACK	116
21600	CLIP FOR HITCH PIN, BULK	116
21601	CLIP FOR HITCH PIN PKG	116
21602	HITCH PIN CLIP, 3 PACK	116
21728	PROTECTIVE RUBBER CAP 2 IN X 2	130
21800	PLASTIC HITCH BALL COVER	95
21801	PLASTIC HITCH BALL COVER/PKGD	95
21810	BALL COVER,2 5/16" BLACK,BULK	95
21811	BALL COVER,2 5/16" BLACK,PKG	95
21900	CHROME TUBE COVER	130
21901	CHROME TUBE COVER/PKGD	130
22100	2 IN X 2 IN TUBE COVER CHROME	130
22101	2 IN X 2 IN TUBE COVER CHROME	130
22110	2 IN X 2 IN TUBE COVER CHROME	130
22111	2 IN X 2 IN TUBE COVER CHROME	130
22170	2 IN X 2 IN TUBE COVER CHROME	130
22171	2 IN X 2 IN TUBE COVER CHROME	130
22178	BEARING PROTECTOR 2 QTY FITS 1	262

Part#	Description	Page#
22180	2 IN X 2 IN TUBE COVER PLASTIC	130
22181	2 IN X 2 IN TUBE COVER PLASTIC	130
22198	BEARING PROTECTOR 2 QTY FITS 1	262
22232	DUST COVER, BEARING 2.328	262
22244	BEARING PROT,2.44" 2 PAK W/COV	262
22271	1 1/4" RECVR TUBE COVER	130
22272	COVER,RCVR TUBE,2" CURT	130
22275	1 1/4" RECVR TUBE COVER PKG	130
22276	COVER,RCVR TUBE,2" CURT,PKG	130
22277	COVER RECVR TUBE, 2-1/2" BULK	130
22278	COVER,RCVR TUBE, 2-1/2" PKGD	130
22315	ANTI-RATTLE FOR 1 1/4 IN HOLLO	123
22320	2-1/2" ANTI RATTLE SOLID SHANK	123
22321	ANTI-RATTLE FOR 2 IN HOLLOW SH	123
22322	PROFINISHING PACK (BAGGED)	132
22325	2" ANTI-RATTLE CLAMP	123
22401	TOW HOOK W/HARDWARE CHROME 100	112
22411	TOW HOOK W/HARDWARE 10000 LB B	112
22420	TOW HOOK CHROME 10000 GTW BULK	112
22430	TOW HOOK BLACK 10000 QTW BULK	112
22750	TUBE COVER 2 IN X 2 IN BLACK B	130
22751	STEEL TUBE COVER/PKGD	130
22800	CHOCKS,WHEEL,PAIR	122
23020	1/2 IN HITCH LOCK 15000 LB PAC	118
23021	5/8 IN HITCH LOCK 30000 LB PAC	118
23022	COUPLER LOCK BRASS 2 KEYS INCL	120
23024	1/2" HITCH PIN LOCK W/SLEEVE	118
23025	3 IN HITCH LOCK 3000 LB PAC	118
23079	LOCK,COUPLER,ROLLED LIP	121
23081	LOCK,BLOCK HEAD	121
23082	CPLR LCK 1-7/8", 2", 2-5/16"	120
23086	KEYED ALIKE LOCK COMBINATION	119
23088	KEYED ALIKE LOCK COMBINATION	119
23175	WHEEL CHOCK LK	122
23178	DUST COVER,BEARING,1.78" 2 PAK	262
23179	TRAILER LOCK	121
23198	DUST COVER,BEARING,1.98" 2 PAK	262
23209	3/4" WHEEL BEARING KIT	262
23210	1" WHEEL BEARING KIT	262
23211	1-1/16" WHEEL BEARING KIT	262
23232	DUST COVER,BEARING,2.32" 2 PAK	262
23244	DUST COVER,BEARING,2.44" 2 PAK	262
23255	LOCK,KING PIN,DUMBBELL STYLE	210
23256	LOCK, FIFTH WHEEL	210
23501	1/2" DOGBONE LOCK, CHROME	118
23502	5/8 IN RIGHT ANGLE LOCK	118
23503	ADJUSTABLE LOCK COUPLER	120
23504	5/8 IN RIGHT ANGLE LOCK, 2-1/2	118
23505	LOCK SET, HITCH & COUPLER	119
23506	1/2" W/ 5/8" SLEEVE, BLUE ALUM	118
23510	5/8 IN PUSH BUTTON 90 DEG LOCK	118
23515	5/8 IN DOGBONE LOCK CHROME	118
23516	5/8 IN DOGBONE LOCK SS	118
23517	5/8" DOGBONE LOCK,SS**	118
23518	5/8 IN DOGBONE LOCK BLACK	118
23519	5/8 IN DOGBONE LOCK,SS**	118
23520	7/8IN SPAN COUPLER LOCK CHROME	120
23521	7/8 IN SPAN COUPLER LOCK BLACK	120
23522	2-1/2" SPAN COUPLER LOCK, CHRM	120
23523	3-3/8" SPAN COUPLER LOCK, CHRM	120
23526	5/8 DOGBONE WITH 7/8 SPAN LOCK	119
23527	5/8 IN DOGBONE LOCK WITH**	119
23528	5/8 IN DOGBONE LOCK CHROME**	118
23546	COUPLER LOCK, SOLID BRASS	120
23556	LOCK SET,KEYED ALIKE,ONE MOUNT	108
23562	SPARE TIRE LOCK PACKAGED	122
23580	SS SLEEVE ADAPTER RECEIVER LOC	117
23581	HITCH PIN,1/2" PIVOT LK,SS	117
23582	SS PIVOT LOCK HITCH PIN	117
23659	1 7/8 IN 2 IN AND 2 5/16 IN TR	121
23666	CABLE LOCK	122
25010	5/16 IN COUPLER SAFETY PIN	117
25011	5/16 IN COUPLER SAFETY PIN PAC	117
25012	K-8 1/4 IN COUPLER PIN WITH 12	117
25013	PIN,COUPLER,.25" W/12"CHAIN,PK	117
25034	5/16" SAFETY PIN W/CHAIN BULK	117
25035	5/16" SAFETY PIN W/CHAIN PACK	117
25080	COUPLER SAFETY PIN 1/4 IN DIA	117
25081	COUPLER SAFETY PIN 1/4 IN DIA	117
25094	REPAIR KIT, 1.875" COUPLER	247

Part#	Description	Page#
25100	COUPLER, 2 X 3" STRAIGHT 5000#	247
25101	COUPLER,2",A-FRAME,5000#	247
25105	COUPLER, 1.875 X 2.5" 2000#	247
25128	COUPLER, 1.875 X 2" 2000#	247
25131	COUPLER, 1.875 X 3" 2000#	247
25135	COUPLER, 2 X 2.5" 3500#	247
25138	COUPLER, 2 X 3" 3500#	247
25153	COUPLER, 2 X 2" 3500#	247
25194	REPAIR KIT, 2" COUPLER	247
25200	COUPLER,2 5/16",A-FRAME,10000#	247
25210	COUPLER,2",A-FRAME,5000#	247
25217	COUPLER,2",A-FRAME,7000#	247
25227	COUPLER,2 5/16",A-FRAME,12500#	247
25294	REPAIR KIT,2" COUPLER A-FRAME	247
25319	COUPLER,2",ADJUST,7000#, COLLAR	248
25328	COUPLER,2 5/16",AJUSTBL,15000#	248
25329	COUPLER,2 5/16",AJUSTBL,12500#	248
25330	COUPLER,2 5/16" ADJ LT,14000#	248
25388	BOLT KIT,ADJUST CPLR CHANNEL	248
25389	25388 PACKAGED BOLT KIT	248
28000	SAFETY PIN 3/8" W/ CHAIN, BULK	117
28001	SAFETY PIN 3/8" W/ CHAIN, PKGD	117
28100	JACK,BOLT ON SNAP RING 1000#	253
28101	JACK,BOLT SNAP RING 1000# PKGD	253
28112	JACK,BOLT ON SWIVEL 1200#	253
28113	JACK,BOLT ON SWIVEL 1200# PKGD	253
28115	JACK,BOLT ON SWIVEL 1500#	253
28116	JACK,BOLT ON SWIVEL 1500# PKGD	253
28155	JACK,BOLT,SWIVEL,2 WHEEL	253
28156	JACK,BOLT,SWIVEL,2 WHEEL PKGD	253
28200	JACK,A FRAME TOP WIND 2000#	252
28202	JACK,A FRAME TOP WIND 2K TL	252
28203	JACK,A FRAME TOPWIND 2K TL PKG	252
28204	JACK,A FRAME SIDE WIND 2000#	252
28250	JACK,A FRAME TOP WIND 5000#	252
28255	JACK,AFRAME TOPWIND 5K BLK HDL	252
28270	FOOT, JACK WITH HARDWARE	254
28271	FOOT, JACK WITH HARDWARE, PKGD	254
28272	FOOT, JACK 1.7", ZINC	254
28273	FOOT, JACK 1.7", ZINC, PKG	254
28274	FOOT, JACK 8.5", ZINC,	254
28275	FOOT, JACK 8.5", ZINC, PKG	254
28276	WHEEL, JACK CASTER, 1200#	254
28277	WHEEL, JACK CASTER, 1200#, PKG	254
28278	PIN, SAFETY FOR JACK FOOT	254
28279	PIN, SAFETY FOR JACK FOOT, PKG	254
28300	JACK,WELD, TOP WIND,2K,10"	252
28301	JACK,WELD, TOP WIND,2K,10" PKG	252
28302	JACK,WELD ON, SIDE WIND,2000#	252
28304	JACK,WELD, TOP WIND,2K, 15"	252
28306	JACK,WELD ON,2000 LB, SIDE WIND	252
28320	JACK,PIPE MNT, TOPWIND,2K 10"	252
28321	JACK,PIPE MNT, SIDEWIND,2000#,	252
28322	JACK,PIPE MNT, TOP WIND,2000#,	252
28323	JACK,PIPE MNT, TOPWIND,2000#,PK	252
28324	JACK,PIPE MNT, SIDE WIND,2000#	252
28350	JACK,PIPE MNT, TOPWIND,5K,10"	252
28351	JACK,PIPEMNT, TOPWIND,5K,10" PK	252
28354	JACK,PIPE MNT, SIDEWIND,5K, 10"	252
28356	JACK,PIPE MNT, TOPWIND,5K 15"	252
28358	JACK,PIPE MNT, SIDEWIND,5K,15"	252
28359	JACK, 5000 LB., SO., WELD ON	254
28512	JACK, HD SQUARE 10K/12K ASSY	254
28570	JACK,HD SQUARE TOP WIND 7K/8K	254
28575	JACK,HD SQUARE SIDE WIND 7K/8K	254
28910	PART, JACK MARINE MNT BRKT	253
28911	PART, JACK MNT BARS & BOLTS	253
28912	PART, JACK CASTER WHEEL & BOLT	253
28913	PART, JACK FULL MARINE TOP HNDL	253
28914	PART, JACK GEAR KIT, MARINE	253
28921	PART, JACK TOP WIND HANDLE	253
28922	PART, JACK BEARING 2K/5K TW	253
28923	PART, JACK SIDE WIND HANDLE	253
28924	PART, JACK GEAR KIT 2K/5K SW	253
28925	PART, JACK CAP 2K SIDE WIND	253
28926	PART, JACK BLACK HANDLE KNOB	254
28927	PART, JACK BLACK HANDLE KNOB	254
28930	PART, JACK FEMALE PIPE, WELD	253
28931	PART, JACK MALE PIPE, WELD	253
28932	PART, JACK MALE PIPE, PIN TYPE	253

Part#	Description	Page#
28934	PART,JACK 9/16" PIN W/ CHAIN	253
28935	PART,JACK 5/8" PIN W/ CHAIN	253
28937	PART,JACK 2K/5K FULL BLCK HNDL	254
28938	PART,JACK RND TB WELD MNT BRKT	253
28939	PART,JACK 2" SNAP RING	253
28940	PART,JACK 1/2" PLUNGER PIN	253
28950	PART,JACK GEAR KIT 12K	254
28951	PART,JACK FULL 12K HANDLE	254
28952	PART,JACK CAP 12K	254
28953	PART,JACK HANDLE CLIP	254
28954	PART,JACK 12K BEARING	254
28955	PART,JACK 12K PLUNGER PIN ASBL	254
28956	PART,JACK THREADED LIFTING NUT	254
28957	PART,JACK INNER PIPES W/ FOOT	254
28958	PART,JACK GEAR KIT 7K	254
28959	PART,JACK FULL 7K HANDLE SW	254
28960	PART,JACK 7K GEAR HNDL BUSHING	254
28961	PART,JACK CAP 7K	254
28962	PART,JACK 7K DROP LEG & FOOT	254
28963	PART,JACK 7K DROP LEG PIN	254
28964	PART,JACK FULL 7K BLCK HNDL TW	254
28965	PART,JACK 7K BEARING	254
29007	2 IN 20 FT NYLON WINCH STRAP *	255
29423	900 LB WINCH	255
29424	1200 LB WINCH	255
29425	1400 LB WINCH	255
29427	1700 LB WINCH	255
29428	1900 LB WINCH	255
29429	2100 LB WINCH	255
29433	900 LB WINCH W/15' STRAP	255
29435	1400 LB WINCH W/20' STRAP	255
29438	1900 LB WINCH W/20' STRAP	255
29450	15' WINCH STRAP	255
29451	20' WINCH STRAP	255
31001	STEP PAD	131
31002	LICENSE PLATE HOLDER	131
31005	WINCH MOUNT HANDLES	131
31006	SPARE TIRE MOUNT	131
31007	SKID SHIELD	131
31009	WINCH PLATE AND HANDLE ASSY	131
31010	WINCH MOUNT	131
32001	RECEIVER GRIP STEP KIT, STND	131
32002	RECEIVR GRIP STEP KIT, 6" DROP	131
40001	1 7/8 X 3/4 X 1 5/8 HITCH BALL	94
40002	1 7/8 X 1 X 2 1/8 HITCH BALL	94
40003	2 X 3/4 X 1 3/4 HITCH BALL	94
40004	2 X 1 X 2 1/8 HITCH BALL	94
40005	2 5/16 X 1 X 2 1/8 HITCH BALL	94
40006	2 5/16X1 1/4X2 5/8 HITCH BALL	94
40007	2-5/16 X 1 X 2-1/4 HITCH BALL	94
40008	BALL,HITC,2.31X1.25,2.75,20K	94
40009	2.31X1.25,2.75,20K HITCH BALL	94
40015	1 7/8 X 3/4 X 2 1/8 HITCH BALL	94
40016	1 7/8 X 3/4 X 3 HITCH BALL	94
40017	1 7/8 X 1 X 3 HITCH BALL	94
40018	2 X 3/4 X 2 1/8 HITCH BALL	94
40019	2 X 3/4 X 3 HITCH BALL	94
40020	2 X 1 X 3 HITCH BALL	94
40021	2 5/16 X 1 X 3 HITCH BALL	94
40022	2 5/16 X 1 1/4 X 3 HITCH BALL	94
40030	2-5/16 X 1-1/4 X 2-5/8 H. BALL	94
40031	1 7/8 X1X2 3/16 X1 HITCH BALL	94
40032	1 7/8X1X2 1/8X2 HITCH BALL	94
40033	2 X 1 X 2 1/8 X 1 HITCH BALL	94
40034	2X1X2 1/8X2 HITCH BALL	94
40035	2 5/16X1 1/4X2 5/8 HITCH BALL	94
40036	2 5/16X1 1/4X2 5/8 HITCH BALL	94
40037	2 X 1 X 2 1/8 HITCH BALL	94
40038	2 X 1 X 2 1/4 HITCH BALL	94
40039	2 5/16 X 1 X 2 1/4 HITCH BALL	94
40042	2 5/16X1X2 1/4 HITCH BALL	94
40047	2" X 1" ROCKER BALL	94
40050	1 7/8X3/4 X2 1/8 HITCH BALL	94
40051	1 7/8X1X2 1/8 HITCH BALL	94
40052	2X3/4X2 1/8 HITCH BALL	94
40053	2 X 1 X 2 1/8 HITCH BALL	94
40054	2 5/16X1X2 1/8 HITCH BALL	94
40055	2 5/16 X 1-1/4 HITCH BALL 15K	94
40056	2 X 1-1/4 HITCH BALL 10K	94
40061	1 7/8 X 3/4 X 1 5/8 HITCH BALL	94

Part#	Description	Page#
40062	1 7/8 X 1 X 2 1/8 HITCH BALL	94
40063	1 7/8X3/4X2 1/8 HITCH BALL	94
40064	2 X 3/4 X 1 3/4 HITCH BALL	94
40065	2 X 3/4 X 2 1/8 HITCH BALL	94
40066	2 X 1 X 2 1/8 HITCH BALL	94
40067	2 5/16 X 1 X 2 1/8 HITCH BALL	94
40068	2 5/16X1 1/4X2 5/8 HITCH BALL	94
40069	BALL,HITC 2X1.25X2.625,PKG	94
40070	2 X 1 X 2 1/8 HITCH BALL PKGD	94
40071	1 7/8 X 3/4 X 3 HITCH BALL	94
40072	1 7/8 X 1 X 3 HITCH BALL	94
40073	2 X 3/4 X 3 HITCH BALL	94
40074	2 X 1 X 3 HITCH BALL	94
40075	2 5/16 X 1 X 3 HITCH BALL	94
40076	2 5/16 X 1 1/4 X 3 HITCH BALL	94
40078	2-5/16 X 1-1/4 X 2-5/8 BALL	94
40080	1 7/8X3/4X2 1/8 HITCH BALL	94
40081	1 7/8X1X2 1/8 HITCH BALL	94
40082	2X3/4X2 1/8 HITCH BALL	94
40083	2X1X2 1/8 HITCH BALL	94
40084	2 5/16X1X2 1/8 HITCH BALL	94
40085	2-5/16 X 1-1/4 X 2-3/4 RAW BAL	94
40086	2-5/16 X 1"RISE X1-1/4 X 2-5/8	94
40087	2 5/16 X 1 1/4 RAW HITCH BALL	94
40088	2 5/16 X 2 X 3 1/2 HITCH BALL	94
40089	3 X 2 X 3 1/4 HITCH BALL	94
40090	2 X 1 1/4 X 2 5/8 HITCH BALL	94
40092	3 X 2 X 3 1/4 HITCH BALL	94
40093	SWAY CONTROL HITCH BALL	181
40094	2 5/16 GOOSE NECK WELD ON BALL	241
40095	1-7/8" ATV BALL, BULK	95
40096	1-7/8" ATV BALL, PACKAGED	95
40097	2" ATV BALL, BULK	95
40098	2" ATV BALL, PACKAGED	95
40099	50MM HITCH BALL, BULK	94
40103	PKG 3/4 IN REPLACEMENT NUT & W	95
40104	PKG 1 IN REPLACEMENT NUT & WAS	95
40105	PKG 1 1/4 IN REPLACEMENT NUT &	95
40246	2" ROCKER BALL 3.5K RETAIL PCK	93
40247	2" ROCKER BALL 7.5K RETAIL PCK	93
40248	2 5/16X1 RCKR BALL 7.5K RETAIL	93
40249	2 5/16" RCKR BALL 12K RETAIL	93
41341	3/4 IN REPLACEMENT SHANK LONG,	97
41352	SHANK COVER FOR 3/4 IN SHANK,B	97
41353	SHANK COVER FOR 3/4 IN SHANK,	97
41355	SHANK COVER FOR 1 IN SHANK, RE	97
41780	1 7/8 IN REPLACEMENT BALL	97
41782	SWITCH BALL SET 3/4 IN SHANK W	97
41783	3/4 IN LONG SHANK W/ 1 7/8 IN	97
42178	1 IN SHANK WITH 1 7/8 IN & 2 I	97
42200	2 IN REPALCEMENT BALL 8,000 LB	97
42203	2 5/16 IN REPLACEMENT BALL 8,0	97
42225	SWITCH BALL SET 1 IN SHANK WIT	97
42280	SWITCH BALL SET 1 IN SHANK WIT	97
42780	1 7/8 IN REPLACEMENT BALL	97
45000	BALL MOUNT,4"R X 13.50	100
45001	BALL MOUNT,TRIBALL,HOLLOW SH	111
45002	BALL MOUNT,DBL BALL,HOLLOW SH	111
45003	BALL MOUNT,VER SHANK,3.50"R	115
45005	BALL MOUNT,ATV,1.88" BALL W/T	113
45006	ADAPTER,ATV RECEIVER TUBE	113
45007	ADAPTER,BALL MNT TONGUE SLEEVE	96
45008	BALL MOUNT,ADJ DUAL BALL	110
45009	BALL MOUNT,ATV,2.00" BALL W/T	113
45010	STRAIGHT BALL MOUNT 8 1/4 IN B	101
45012	PACKAGED BALL MOUNT W/PIN AND	101
45013	ADAPTER,RECEIVER,VERTICAL	114
45014	BALL MOUNT 5 IN. RISE	100
45015	BALL MOUNT 5 IN. RISE	100
45016	BALL MOUNT 3.25 DROP 2.63 RISE	100
45017	BALL MOUNT 2 3/4 IN DROP 2 1/8	100
45018	BALL MOUNT, 1 1/4" D, 2000/200	100
45019	BALL MOUNT, 1 1/4" D,2000/200	100
45020	STRAIGHT BALL MOUNT 10 1/4 IN	101
45021	BALL MOUNT,3 1/8 R,2000/200	100
45022	BALL MOUNT,3 3/4D,2000/200	100
45023	BALL MOUNT, 4" R, 2000/200	100
45024	BALL MOUNT, 5" R, 2000/200	100
45025	BALL MOUNT, 5" R, 2000/200	100
45026	BALL MOUNT, 3.25" D, 2000/200	100

Part#	Description	Page#
45027	BALL MOUNT, 3.25" D, 2000/200	100
45028	BALL MOUNT 6 IN DROP 5 1/16 IN	100
45029	BALL MOUNT,KIT 45005 + 45006	113
45030	2 IN DROP BALL MOUNT W/ 8 1/4	101
45032	PACKAGED BALL MOUNT W/PIN AND	101
45033	D-3 W/ PIN, CLIP AND BAG	101
45034	2 IN DROP LOADED BALL MOUNT W/	103
45036	2 IN DROP LOADED BALL MOUNT W/	103
45037	2 IN DROP LOADED BALL MOUNT W/	103
45038	BALL MOUNT,KIT 45006 + 45009	113
45040	2 IN X 3/4 IN X 10 1/4 IN BALL	101
45041	BALL MOUNT,2"D,7500/750,LOADED	103
45042	BALL MOUNT,4"D,7500/750,LOADED	103
45048	RECEIVER EXTENSION 24"	114
45049	DUAL BALL & CLEVIS W/SHANK	110
45050	4X2X8 1/4 IN BALL MOUNT	101
45052	PACKAGED BALL MOUNT W/PIN AND	101
45055	4 IN DROP LOADED BALL MOUNT W/	103
45056	4 IN DROP LOADED BALL MOUNT W/	103
45057	MASTER PACK OF 3 D-554 BALLMOU	103
45059	SHANK,ADJ BALL & CLEVIS,45008	110
45060	4 IN X 2 IN X 12 1/4 IN BALL M	101
45064	6" DROP LOADED W/ 2" BALL	103
45065	6" DROP LOADED W/ 2-5/16" BALL	103
45070	6 IN X 4 IN X 8 1/4 IN BALL MO	101
45080	6 IN X 4 IN X 12 1/4 IN BALL M	101
45090	8 IN X 6 IN X 8 1/4 IN BALL MO	101
45100	BALL MOUNT	101
45110	BALL MOUNT	101
45112	BALL MOUNT	101
45131	2" DROP WELDED BM 5000	104
45134	2" DROP WELDED BM 7500	104
45141	2" X 2" STARTER KIT 2" DROP***	104
45142	2" X 2" STARTER KIT 4" DROP***	104
45143	ROCKER BALL STARTER KT 3" DROP	93
45144	ROCKER BALL STARTER KT 5" DROP	93
45147	1-1/4" X 1-1/4" STARTER KIT	103
45148	1 1/4" X 1 1/4" STARTER KIT***	103
45151	4" DROP WELDED BM 5000	104
45152	2" RISE WELDED BM 5000	104
45154	4" DROP WELDED BM 7500	104
45155	2" RISE WELDED BM 7500	104
45220	2 IN DROP W/8 1/4 IN & 10 1/4	105
45230	4 IN DROP W/8 1/4 IN & 10 1/4	105
45240	6 IN DROP W/8 1/4 IN & 10 1/4	105
45250	STRAIGHT BALL MOUNT 12 1/4 IN	101
45260	2 IN X 3/4 IN X 12 1/4 IN BALL	101
45270	4 IN X 2 IN X 12 1/4 IN BALL M	101
45280	BALL MOUNT,6"X4"X14.25"	101
45290	7500 GWT 2 IN DROP WITH 8 1/4	101
45293	2" DROP CHROME BALL MOUNT WITH	103
45295	2" DROP CHROME BALL MOUNT WITH	103
45296	7500 GWT - 4 IN DROP WITH 8 1/4	101
45297	7500 GWT 6 IN DROP WITH 8 1/4	101
45310	BALL MOUNT 2" DROP HOLLOW *	104
45311	BALL MOUNT 4" DROP HOLLOW *	104
45312	BALL MOUNT 2" DROP SOLID *	104
45313	BALL MOUNT 4" DROP SOLID *	104
45331	BALL MOUNT,FORGED,2"D,15K,LOAD	103
45332	BALL MOUNT,FORGED,4"D,15K,LOAD	103
45336	BALL MOUNT, 10000 LB, 6" DROP	104
45338	BALL MOUNT, 10000 LB, 8" DROP	104
45340	FORGED BALL MOUNT 17K, 2" DROP	105
45341	FORGED BALL MOUNT 17K, 4" DROP	105
45342	FORGED BALL MOUNT 17K, 6" DROP	105
45405	BALL MOUNT REDUCER 2 1/2	115
45408	REDUCER SLEEVE SET 3" TO 2"	115
45430	FORGED BALL MOUNT 21K, 4" DROP	105
45431	FORGED BALL MOUNT 21K, 6" DROP	105
45432	FORGED BALL MOUNT 21K, 8" DROP	105
45446	BALL MOUNT, 12000 LB, 6" DROP	104
45448	BALL MOUNT, 12000 LB, 8" DROP	104
45456	FORGED BALL MOUNT 20K, 2" DROP	105
45458	FORGED BALL MOUNT 20K, 4" DROP	105
45459	FORGED BALL MOUNT 20K 6" DROP	105
45460	FORGED BALL MOUNT 20K, 8" DROP	105
45500	HOOK,TOW,FORGED RCVR MNT,10K	112
45503	BALL MOUNT,1.0"D.,38R,3500	100
45507	VERTICAL MOUNT BALLMOUNT	115
45510	CLASS I BALLMOUNT	100

Part#	Description	Page#
45518	1 1/4 IN DROP W/ 6 3/4 IN CLAS	100
45519	1 1/4 IN DROP W/ 9 3/4 IN CLAS	100
45520	12 IN CLASS I & II BALL MOUNT	100
45521	3 1/4 DROP W/ 7 1/8 IN BAR CLA	100
45522	3 1/8 IN RISE X 14 IN CLASS I/	100
45534	TOWING STARTER KIT, 2" DROP	102
45551	BALL MOUNT,EURO,.75"R,2" B	99
45552	BALL MOUNT,EURO,.75"R,2" B	99
45554	TOWING STARTER KIT, 4" DROP	102
45561	BALL MOUNT,EURO,3.13"R,1.875" B	99
45562	BALL MOUNT,EURO,3.13"R,2" B	99
45571	BALL MOUNT,EURO,2.63"R,1.88" B	99
45572	BALL MOUNT,EURO,2.63"R,2" B	99
45581	BALL MOUNT,EURO,3.25" D,1.88" B	99
45582	BALL MOUNT,EURO,3.25" D,2" B	99
45591	BALL MOUNT,EURO,3.13"R,1.88" B	99
45592	BALL MOUNT,EURO,3.13"R,2" B	99
45650	TRIPLE TOW BAR 1 7/8 IN 2 IN 2	111
45651	TRIPLE TOW BAR 2.5" X 2.5"	111
45652	TRIPLE TOW BAR 1-7/8 X 2-5/16	111
45655	TRIPLE TOW BAR 1 7/8 X 2 X 2 5	111
45660	DOUBLE TOW BAR 2 IN X 2 5/16 I	111
45665	DOUBLE TOW BAR 2 IN X 2 5/16 I	111
45675	TRIBALL W/HOOK 1-7/8X2X2-5/16	111
45770	ADAPTABLE HITCH EXTENDER 2 IN	114
45775	ADAPTABLE HITCH EXTENDER 2 IN	114
45785	RECEIVER TUBE ADAPTER	114
45789	RECEIVER TUBE EXTENSION	114
45790	ADAPTABLE HITCH EXTENDER 1 1/4	114
45791	ADAPTABLE HITCH EXTENDER 2 IN	114
45792	MULTI-USE RECEIVER EXTENDER	113
45794	ADAPTER,RECEIVER TUBE,VERTICAL	113
45795	ADAPTABLE HITCH EXTENDER 2 IN	114
45796	ADAPTABLE HITCH EXTENDER 2 IN	114
45797	2" RISE/DROP RECEIVER 7.5K	219
45798	4" RISE/DROP RECEIVER 7.5K	219
45799	ADJUSTABLE MULTI-BALL MOUNT	110
45800	BALL MOUNT,MB,ADJ,REPL. MOUNT	110
45802	REPL ADJ TUBE MNT, FOR 45799	110
45803	1" CLEVIS PIN	111
45804	5/8" CLEVIS PIN	111
45805	1/2" CLEVIS PIN	111
45806	SAFETY CHAIN HOLDERS	123
45810	MULTI-USE BALLMOUNT	113
45812	ADJUSTABLE BALL MOUNT	110
45820	SWAY CONTROL BALLMOUNT	112
45821	CLEVIS PIN BALL MOUNT	111
45822	MOUNT,WELD ON SWAY CONTROL	181
45825	MOUNT,TOW HOOK,CHROME	112
45831	TOW HOOK MOUNT 2-1/2"	112
45832	TOW HOOK MOUNT 2"	112
45900	BALL MOUNT,FORGED,DUAL,2/2.313	109
45901	BALL MOUNT,FORGED,DUAL	109
45902	BALL MOUNT,FR,DL 2/2.313 X 2.5	109
45903	SLIM BM FORGED DUAL 2" SHANK	108
45907	13K CHANNEL MOUNT W/PINTLE	109
45908	20K CHANNEL MOUNT W/PINTLE	109
45909	CHANNEL MOUNT STEP	108
45910	SHANK,BM,FORGED,REPL 45900	109
45911	SHANK,BM,ADJ,REPL 45901	109
45912	BALL,ADJ DUAL,REPL 45900	109
45916	ANTI-RATTLE SET SCREW W/WRENCH	109
45917	SHANK,BM,FRG,REPL 45902 X 2.5	109
45919	PINTLE,COMBO,ADJUSTABLE,2.00	109
45920	PINTLE,COMBO,ADJUSTABLE,2.313	109
45921	ANTI-RATTLE RUBBER BUMPER *	109
45922	PINTLE,COMBO,ADJ,2.313, 20K	109
45923	BALL,ADJ DUAL,REPL 45902	109
45925	ONE MNT PIN&CLIP RPL. KIT, 20K	109
45926	2" DEEP DROP FORGED BM DUAL	109
45927	2.5" DEEP DROP FORGED BM DUAL	109
45928	3" DEEP DROP FORGED BM DUAL	109
45932	RXD KEVED ALIKE LOCK SET	107
45938	REB XD TONGUE LOCK ONLY	107
45940	RXD REPLACEMENT TONGUE	107
45949	REBELLION XD BALL MOUNT 2"	106
45950	RXD PINTLE MOUNT ACCESSORY	107
45952	REBELLION XD DUAL BALL 10K/15K	107
45955	REBELLION XD BALL MOUNT 2.5"	106
45959	REBELLION XD REPLACEMENT PINS*	107

Part#	Description	Page#
45960	REBELLION XD REPLACEMENT CLIP*	107
45980	KIT, 45949 & 40055	106
45981	KIT, 45949 & 40056	106
48004	PINTLE,RCVR MNT,10 TON	128
48005	PINTLE,RCVR MNT,5 TON	128
48006	PINTLE,COMB,RCVR MNT,2.31 BALL	128
48007	PINTLE,COMB,RCVR MNT,2.00 BALL	128
48010	2.5" REC MOUNT PINTLE 20K ****	128
48012	2.5" REC MNT PINTLE COMBO 20K*	128
48180	1 7/8 IN BALL & PINTLE COMBINA	128
48190	2 IN BALL & PINTLE COMBINATION	128
48200	8 TON COMBO BALL & PINTLE - 2	128
48205	5 TON GTW - REGULAR PINTLE FOR	128
48210	10 TON GTW - REGULAR PINTLE FO	128
48215	15 TON GTW - REGULAR PINTLE FO	128
48231	30 TON GTW - REGULAR PINTLE	128
48323	7 IN PLATE 8 1/2 IN SHANK PINT	129
48324	7 IN PLATE 10 1/2 IN SHANK PINT	129
48325	10 1/2" ADJUSTABLE PINTLE MT	129
48326	8 1/2" PINTLE MOUNT	129
48327	10 1/2" PINTLE MOUNT	129
48328	8 1/2" ADJUSTABLE PINTLE MOUNT	129
48329	2.5" ADJUSTABLE PINTLE MOUNT	129
48330	BOLT KIT FOR PINTLE MOUNT	129
48332	BOLT KIT FOR PINTLE MOUNT	128
48333	48330 PACKAGED BOLT KIT	129
48340	2.5" PINTLE MOUNT	129
48341	13 IN PLATE 12 1/2 IN SHANK	129
48342	13 IN PLATE 14 1/2 IN SHANK	129
48343	2" PINTLE MOUNT, 17K, 4 HOLE	129
48348	2.5" FORGED PINTLE MNT, 4 HOLE	129
48349	2.5" FORGED PINTLE MNT, 7 HOLE	129
48405	7 TON PINTLE HOOK W/ SHANK	125
48406	7 TON COMBO BALL 2-5/16" BALL	125
48407	7 TON COMBO BALL RING 2" BALL	125
48410	10 TON COMBO BALL 2-5/16" FLAT	125
48411	10 TON COMBO BALL 2" FLAT MNT	125
48420	2" REPL BALL RING COMBO	125
48430	2-5/16" REPL BALL RING COMBO	125
48505	15 TON PINTLE HOOK FLAT MOUNT	125
48510	22000 GTW - ALLOY STEEL DRAWBA	250
48520	15000 GTW - ALLOY STEEL DRAWBA	250
48530	45000 GTW - ALLOY STEEL DRAWBA	250
48543	12 TON ADJ SLIDE PINTL MOUNT	126
48548	15 TON ADJ SLIDE PINTL 2.5"	126
48549	ADJ SLIDE PINTLE REPL HARWARE	126
48550	35000 GTW - ALLOY STEEL DRAWBA	250
48551	REPL SAFTY CHAIN HOLDERS 2 QTY	125
48552	REPL HARWARE CHANNEL MOUNT	249
48553	60K HARDWARE 48560 & 48661	249
48560	60000 GTW - FORGED DRAWBAR WIT	250
48600	12000 GTW - 3 IN ADJUSTABLE EY	250
48601	12000 GTW - 3 IN ADJ EYE BLACK	250
48610	3 POSITION CHANNEL	250
48620	E-62 BOLT KIT,FOR E-63 & E-64	250
48621	48620 PACKAGED BOLT KIT	250
48625	12.5 TON LUNNETTE EYE 2 HOLE	249
48626	20 TON LUNNETTE EYE 3 HOLE	249
48630	3 IN ID EYE KIT W/3 POS CHANNE	250
48631	3 IN ID EYE KIT W/3 POS CHANNE	250
48640	3 IN ID EYE KIT W/5 POS CHANNE	250
48641	KIT 20T LUNNETTE W LOCK 3 HOLE	249
48650	5 POSITION CHANNEL	250
48651	SECURE LATCH CHANNEL MOUNT	249
48660	12 TON FORGED 3 IN ID EYE ADJU	250
48661	30 TON LUNNETTE 4 HOLE	249
48810	1 7/8 IN REPLACEMENT BALL FOR	128
48820	2 IN REPLACEMENT BALL	128
48830	2 5/16 IN REPLACEMENT BALL	128
49060	6 IN RECEIVER TUBE 2 IN X 2 IN	133
49090	9 IN RECEIVER TUBE 2 IN X 2 IN	133
49120	12 IN RECEIVER TUBE 2 IN X 2 I	133
49180	18 IN RECEIVER TUBE 2 IN X 2 I	133
49240	24 IN RECEIVER TUBE 2 IN X 2 I	133
49360	36 IN RECEIVER TUBE 2 IN X 2 I	133
49480	48 IN RECEIVER TUBE	133
49506	6 IN RECEIVER TUBE 1 1/4 IN X	133
49510	2.5" RECEIVER TUBE 10" LONG	133
49511	2.5" RECEIVER TUBE 18" LONG	133
49512	12 IN RECEIVER TUBE 1 1/4 IN X	133

Part#	Description	Page#
49513	3" RECEIVER TUBE 12" LONG	133
49515	3" RECEIVER TUBE 18" LONG	133
49516	2.5" RECEIVER TUBE 6" LONG	133
49524	24 IN RECEIVER TUBE 1 1/4 IN X	133
49529	10 IN SOLID STEEL HITCH BAR	133
49530	12 IN SOLID STEEL HITCH BAR	133
49531	14 IN SOLID STEEL HITCH BAR	133
49532	16 IN SOLID STEEL HITCH BAR	133
49533	18 IN SOLID STEEL HITCH BAR	133
49534	20 IN SOLID STEEL HITCH BAR	133
49535	22 IN SOLID STEEL HITCH BAR	133
49536	24 IN SOLID STEEL HITCH BAR	133
49537	8 IN SOLID STEEL HITCH BAR	133
49717	WELD ON HITCH BOX 5000 GTW RAW	133
49770	3 IN X 3 IN X 1 IN COLLAR	133
49950	10000 LB WELD-ON SAFETY CHAIN	133
51110	BRK CNTRLR,VENTURER,PKGD	138
51114	MOUNTING BRACKET, CURT LED	138
51120	BRK CNTRLR,DISCOVERY,PKGD	138
51122	BRK CNTRLR,DISCOVERY,BULK(6)	138
51124	KIT,REPLACE BRK HDWRE,DISCOVER	138
51140	BRK CNTRLR,TRIFLEX,PKGD	138
51142	BRK CNTRLR,TRIFLEX,BULK	138
51144	KIT,REPLACE BRK HDWRE, TRIFLEX	138
51170	BRAKE CONTROL - SPECTRUM	138
51180	BRAKE CONTROL ECHO MOBILE	138
51312	HARNESS WITH QUICK PLUG,BULK	143
51313	HARNESS WITH QUICK PLUG,PKGD	143
51322	HARNESS WITH QUICK PLUG,BULK	143
51323	HARNESS WITH QUICK PLUG,PKGD	143
51332	HARNESS WITH QUICK PLUG,BULK	143
51333	HARNESS WITH QUICK PLUG,PKGD	143
51342	HARNESS WITH QUICK PLUG,BULK	143
51343	HARNESS WITH QUICK PLUG,PKGD	143
51352	HARNESS WITH QUICK PLUG,BULK	143
51353	HARNESS WITH QUICK PLUG,PKGD	143
51362	HARNESS WITH QUICK PLUG,BULK	143
51363	HARNESS WITH QUICK PLUG,PKGD	143
51370	BRAKE CONTROL HARNESS,BULK	143
51372	HARNESS WITH QUICK PLUG,BULK	143
51373	HARNESS WITH QUICK PLUG,PKGD	143
51382	HARNESS WITH QUICK PLUG,BULK	143
51383	HARNESS WITH QUICK PLUG,PKGD	143
51390	BRAKE CONTROL HARNESS,BULK	143
51391	BRAKE CONTROL HARNESS,PKGD	143
51392	HARNESS WITH QUICK PLUG,BULK	143
51393	HARNESS WITH QUICK PLUG,PKGD	143
51420	BRAKE CONTROL HARNESS,BULK	143
51421	BRAKE CONTROL HARNESS,PKGD	143
51422	HARNESS WITH QUICK PLUG,BULK	143
51423	HARNESS WITH QUICK PLUG,PKGD	143
51430	BRAKE CONTROL HARNESS,BULK	143
51431	BRAKE CONTROL HARNESS, PKGD	143
51432	HARNESS WITH QUICK PLUG,BULK	143
51433	HARNESS WITH QUICK PLUG,PKGD	143
51435	HARN,BK CTRL,FORD F-150,PKGD	143
51436	HARN,BKCTRL,QP,FORD F-150,BULK	143
51437	HARN,BKCTRL,QP,FORD F-150,PKGD	143
51438	HARN,BKCTRL,QP,DODGE RAM,BULK	143
51439	HARN,BKCTRL,QP,DODGE RAM,PKGD	143
51440	HARN,BK CTRL,KIA BORREGO,BULK	143
51441	HARN,BK CTRL,KIA BORREGO,PKGD	143
51442	HARN,BK CTRL,KIA BORRE,QP,BULK	143
51443	HARN,BK CTRL,KIA BORREGO,QP,PK	143
51444	HARN,BK CTRL,JEEP GR CHER,BULK	143
51445	HARN,BK CTRL,JEEP GR CHER,PKGD	143
51446	HARN,BK CTRL,JEEP GR CHER,QP,B	143
51447	HARN,BK CTRL,JEEP GR CHER,QP,P	143
51448	HARN,BKCTRL,QP,DODGE RAM,PKGD	143
51451	HARN,BKCTRL,QP,SILVERADO 1500*	143
51452	HARN,BKCTRL,QP,SILVERADO,PKGD	143
51453	HARN,BKCTRL,QP,RAM,PKGD	143
51455	HARN,BKCTRL,QP,TUNDRA,BULK	143
51456	HARN,BKCTRL,QP,TUNDRA,PKGD	143
51457	HARN,BKCTRL,QP,DODGE RAM,BULK	143
51458	HARN,BKCTRL,QP,DODGE RAM,PKGD	143
51459	HARN,BKCTRL,QP,JEEP,BULK	143
51460	HARN,BKCTRL,QP,JEEP,PKGD	143
51498	TEST BOX, 7 WAY FUNCTION	171
51500	KIT,BRK CNTRL WIRING,UNIVERSAL	142

Part#	Description	Page#
51515	HARN,BK CTRL,QP W/PIGTAILS	142
51516	HARN,BK CTRL,QP W/PIGTAILS,PKG	142
51520	HARN,BK CTRL,D-TO CURT,PKG	142
51521	TEST BOX, BRAKE CONTROL	171
51522	HARN,BKCTRL,AUDI Q5,Q7,PKG	143
51523	HARN,BKCTRL,ACURA MDX,PKG	143
51524	HARN,BKCTRL,QP, FORD EXP, PKGD	143
51525	HARN, BKCTRL, CHEVY SILV.	143
51526	HARN,BKCTRL,QP,JEEP GLAD, PKGD	143
51527	HARN,BKCTRL,QP,JEEP,BULK	143
51701	BETTERWEIGH TOWING SCALE	98
52010	NYLON BREAKAWAY SWITCH WITH SW	147
52011	NYLON BREAKAWAY SWITCH PACKAGD	147
52020	REPLACEMENT LANYARD WITH PULL	147
52022	CURT BATTERY BOX	147
52023	CURT 12V 5.4 AMP RECHARGABLE B	147
52025	CURT 12V BATTERY CHARGER	147
52026	CURT SOFTTRAC II BREAKAWAY KIT	146
52027	CURT BATTERY CASE	147
52028	CURT SOFTTRAC II BREAKAWAY SYS	146
52029	CURT BATTERY BOX	147
52030	CURT BATTERY BOX	147
52040	CURT SOFTTRAC I BREAKAWAY KIT	146
52041	CURT SOFTTRAC I BREAKAWAY KIT	146
52042	BREAKAWAY KIT,PUSH TO TEST,S/L	146
52044	BREAKAWAY KIT,PUSH TO TEST,T/L	146
52090	CURT BATTERY BOX	147
53200	TOWING LIGHTS, 20", KIT	170
53201	LED CARGO LIGHTS	276
53204	4-WAY FLAT MAGNETIC TOW LIGHT	170
53440	RED COMBINATION LIGHT, W/OUT L	170
53441	RED COMBINATION LIGHT, W/OUT L	170
53445	RED REAR REPLACEMENT LENS COMB	170
53452	RED SUBMERSIBLE COMBO LIGHT,RI	170
53453	RED SUBMERSIBLE COMBO LIGHT, W	170
53515	RED SIDE REPLACEMENT LIGHT COM	170
53540	STOP TAIL AND SIDE LIGHTS W WI	170
55177	3 WIRE TO 2 WIRE CONVERTER	148
55178	3 TO 2 CONVERTER PACKAGED	148
55179	4 FLAT 3 TO 2 CONVERTER 12 IN	148
55417	2020 GM 7-WAY ADAPTER COVER	155
56080	EXTENSION,5TH WHEEL,7-WAY	155
56130	CONVERTER,BASIC,PACKAGED(SM)	148
56175	CONVERTER,CP,PACKAGED(SM)	148
56187	CONVERTER,BASIC,PWRD,PKG(SM)	148
56196	CONVERTER,2-WIRE TO 3-WIRE,PKG	149
56424	BOARD, CONVERTER 24 VOLT	149
56496	POTTED TAILLIGHT CONVERTER	148
56601	7 WAY MOLDED TRLR END 6' BULK	155
56602	7 WAY MOLDED TRLR END 8' BULK	155
56603	7 WAY MOLDED TRLR END 10' BULK	155
56611	7 WAY COLD WEATHER 6' BULK	155
56612	7 WAY COLD WEATHER 8' BULK	155
56613	7 WAY COLD WEATHER 10' BULK	155
56621	7 WAY MOLDED TRLR END 6' PKG	155
56622	7 WAY MOLDED TRLR END 8' PKG	155
56623	7 WAY MOLDED TRLR END 10' PKG	155
57001	WIRE, 16-4, WT/BN/YL/GN, 25 FT	171
57003	VW 7-WAY ADAPTOR	160
57004	ADAPTOR, 7 TO 4/5,LED	160
57005	ADAPTOR, 7 TO 6,LED	160
57007	KIT,7-WAY EXT, ISOLATION	155
55151	WIRING KIT, T-CONN, 10 AMP	149
55152	WIRING KIT, T-CONN, 15 AMP	149
57040	7-POLE ROUND TO 4 FLAT ADAPTER	161
57041	7-POLE ROUND TO 4 FLAT ADAPTER	161
57100	SOCKET,MFUNC,7WBLD,4W,BUA,DODG	151
57102	SOCKET,MFUNC,7WBLD,4W,BUA,UNIV	151
57183	4-WAY FLAT TO 6-WAY ROUND CAR	158
57184	4-WAY FLAT TO 7-WAY RV ROUND C	158
57185	4-WAY FLAT TO 7-WAY ROUND CAR	158
57186	4-FLAT TO 7-WAY W/BC WIRNG KIT	142
57187	5-WAY FLAT TO 4-WAY FLAT 75136	158
57201	BRKT,MNT,7WAY,UNV,LG, 12 PK	169
57202	MOUNTING BRKT, LONG W/CLAMP PKG	169
57203	BRKT,MNT,7WAY,UNV,SHORT,12 PK	169
57204	MOUNTING BRKT,SHORT W/CLAMP PK	169
57205	BRKT,MNT,7WAY,HD,12 PACK	169
57206	BRKT,MNT,7WAY,HD,PKG	169
57207	BRKT,MNT,456 WAY RND,12 PACK	169

Part#	Description	Page#
57208	BRKT,MNT,456 WAY RND,PKG	169
57220	I-420 4-FLAT 20' TRAILER END	162
57224	4 POLE ROUND TO 4 FLAT ADAPTER	159
57225	4 POLE ROUND TO 4 FLAT ADAPTER	159
57240	7-WAY RV ROUND TO 4-WAY FLAT,	161
57241	7-WAY RV ROUND TO 4-WAY FLAT,	161
57245	7 TO 4 W/LED DUST COVER	160
57250	7-WAY RV (FLAT CONNECTORS) TO	161
57251	7-WAY RV (FLAT CONNECTORS) TO	161
57255	7 TO 6 AUX W/LED DUST COVER	160
57260	7-WAY RV ROUND TO 6-WAY ROUND,	161
57261	7-WAY RV STYLE (FLAT CONNECTOR	161
57265	7 TO 6 BRAKE W/LED DUST COVER	160
57271	7-WAY TO 4-WAY 75065	162
57281	7-WAY ADAPTOR 75065	162
57404	4 FLAT TO 4 FLAT 1.25 IN DIAME	164
57405	4-FLAT TO 4-FLAT 1.25 DIAMETER	164
57406	4-FLAT TO 4-FLAT 1.25 IN DIAME	164
57444	4 WAY ROUND TO 4 WAY FLAT ADAP	159
57505	12 VOLT CIRCUIT TESTER 5 WAY F	171
57604	4-WAY FLAT TO BOTH 6-WAY ROUND	158
57620	6-WAY ROUND TO 4-WAY FLAT, BUL	159
57621	6-WAY ROUND TO 4-WAY FLAT, PKG	159
57624	4 WAY FLAT TO BOTH 6 WAY ROUND	158
57626	6 WAY ROUND TO 4 WAY FLAT WITH	158
57627	6 TO 4 W/LED DUST COVER	160
57660	7-WAY RV TO 6 ROUND ADAPTER	161
57661	7-WAY RV TO 6 ROUND ADAPTER PK	161
57667	6-WAY ROUND TO 7-WAY RV, PKG	159
57672	4 WAY FLAT TO BOTH 7 WAY ROUND	158
57674	4 WAY FLAT TO BOTH 7 WAY ROUND	158
57676	7 WAY ROUND TO 4 WAY FLAT WITH	158
57720	7 TO 6 ADPTR W/BKUP ALM(CPB)	161
57724	7 TO 4 ADPTR W/BKUP ALM	161
57725	7 TO 5 ADPTR W/BKUP ALM	161
57726	7 TO 6 ADPTR W/BKUP ALM(CPA)	161
57727	7 TO 7 ADPTR W/BKUP ALM	161
58000	BRACKET,ELEC,7WAY/4FLAT 2.00"	168
58001	BRACKET,ELEC,4FLAT 2.00"	168
58002	BRACKET,ELEC,4FLAT 1.25"	168
58003	BRACKET,ELEC,7WAY/4FLAT 2.50"	168
58020	2-FLAT LOOP 12 IN BULK	164
58021	2-FLAT LOOP 12 IN PACKAGED	164
58030	4 WAY FLAT 12 IN TRAILER BONDE	162
58031	4 WAY FLAT 12 IN TRAILER BONDE	162
58033	I-3 4-FLAT TRAILER END 12 IN K	162
58034	6 WAY SQUARE W/12" LOOP	166
58035	6 WAY SQUARE CAR END BULK PKGD	166
58040	4 WAY FLAT 60 IN CAR BONDED BU	162
58041	4 WAY FLAT 60 IN CAR BONDED PA	162
58044	I-4 4-FLAT CAR END 60 IN KIT P	162
58050	4 WAY BONDED 72 IN LOOP CAR &	162
58051	4-WAY BONDED 72 IN LOOP CAR &	162
58060	4 POLE DIE CAST CONNECTOR TRAI	165
58061	PKG-D 4-WAY DIE CAST	165
58070	4 POLE DIE CAST CONNECTOR CAR	165
58071	PKG-D 7-WAY DIE CAST	165
58080	6 POLE DIE CAST CONNECTOR, TRA	166
58081	6 POLE DIE CAST CONNECTOR, TRA	166
58082	6-POLE DIE CAST CONNECTOR WITH	166
58083	CONN,6-POLE DIECAST W/SPRG,PKG	166
58090	6 POLE DIE CAST CONNECTOR, CAR	166
58091	6 POLE DIE CAST CONNECTOR CAR	166
58092	I-8/I-9 6-POLE DIE CAST CONNEC	166
58093	I-8/I-9/I-21 6-POLE DIE CAST C	166
58120	6 POLE PL CONN, TRAILER END	166
58130	6-POLE CONNECTOR, CAR END	166
58140	7 POLE PLASTIC CONNECTOR, TRAI	167
58141	7 POLE PLASTIC CONNECTOR, TRAI	167
58145	HD 7-WAY TRAILER-SIDE 75040	167
58150	7-POLE PLASTIC CONNECTOR, CAR	167
58151	7-POLE PLASTIC CONNECTOR, CAR	167
58152	PKG I-14/I-15/I-51 7 POLE CONN	167
58155	HD 7-WAY RV-STYLE 75310	167
58160	7-POLE DIE-CAST CONNECTOR, TRA	167
58161	CONN,7-POLE DIECAST,PKG	167
58170	7-POLE DIE-CAST CONNECTOR, CAR	167
58180	7-POLE DIE CAST CONNECTOR TRAI	167
58181	CONN,7-POLE DIECAST W/SPRG,PKG	167
58190	7-POLE METAL CONNECTOR TRAILER	167

Part#	Description	Page#
58200	4-FLAT CAP,CAR SIDE	164
58201	4-FLAT CAP,CAR SIDE,PKG	164
58202	COVER, 5-FLAT, CAR SIDE	164
58203	COVER, 5-FLAT, CAR SIDE, PKGD	164
58210	BRACKET FOR CONNECTOR I-7 I-9	169
58220	7-POLE METAL CONNECTOR CAR END	167
58222	BRACKET FOR CONNECTOR I-17	169
58230	BRACKET FOR CONNECTOR I-15 & I	169
58231	BRACKET FOR CONNECTOR I-15 & I	169
58240	TAIL LIGHT CONVERTER 3 TO 2 WI	148
58260	LED 4-FLAT TESTER	171
58261	LED 4-FLAT TESTER,PKG	171
58270	12V 7-WAY RV ROUND CIRCUIT TES	171
58271	12V 7-WAY RV ROUND CIRCUIT TES	171
58280	14-18 GAUGE WIRE CONN- 100 PK	172
58290	BLACK BRACKET FOR CONNECTOR I-	169
58291	PKG BLACK ZINC CONN BRACKET FO	169
58300	BRACKET,4-FLAT,BULK	169
58301	BRACKET,4-FLAT,PKG	169
58303	BRACKET, 5-WAY FLAT	169
58304	12 CAR END/12 TRAILER END	162
58305	48 CAR END/12 TRAILER END KIT	162
58310	FLASHES 1-4 32 CP TURN SIGNAL	173
58312	2-FLAT POWER ADAPTER TO CIG. L	159
58320	FLASHES 2-3 32 CP TURN SIGNAL	173
58341	15 AMP CIRCUIT BREAKER BAG KIT	173
58344	12 CAR END/12 TRAILER END KIT	162
58345	4-FLAT CAR END 60", KIT W/BRKT	162
58348	48 TRAILER END	162
58349	48 TRAILER END KIT	162
58351	20 AMP CIRCUIT BREAKER BAG KIT	173
58355	48 CAR END/12 TRAILER END	162
58361	30 AMP CIRCUIT BREAKER BAG KIT	173
58371	40 AMP CIRCUIT BREAKER BAG KIT	173
58380	4-WAY BONDED 12 BONDED LOOP, C	162
58381	4-WAY BONDED 12 BONDED LOOP, C	162
58390	PULL WIRE 3/8 IN	22
58400	PULL WIRE 1/2 IN	22
58404	4 FLAT TO 4 FLAT 1.25 IN DIAME	164
58405	4-FLAT TO 4-FLAT 1.25 IN DIAME	164
58406	4-FLAT TO 4-FLAT 1.25 IN DIAME	164
58410	PULL WIRE 7/16 IN	22
58414	4 WAY ROUND TO 4 WAY FLAT ADAP	159
58417	7 WAY RV SOCKET WITH MOUNTING	167
58430	PULL WIRE 5/8 IN	22
58440	FUSE,10 AMP ATC,BULK 100 PACK	173
58450	FUSE,15 AMP ATC,BULK 100 PACK	173
58460	FUSE,20 AMP ATC,BULK 100 PACK	173
58470	HOLDER, IN-LINE FUSE, BULK 12	173
58510	BRACKET FOR I-15/I-20 14 (BLAC	169
58520	BRACKET,U.S. CAR 7 WAY RV PLUG	169
58530	5-FLAT CAR END 60 IN BULK	165
58531	5-FLAT CAR END 60 IN PACK	165
58540	5-FLAT TRAILER END 48 IN BULK	165
58541	5-FLAT TRAILER END 48 IN PACKA	165
58545	5-FLAT CAR END 60", KIT W/BRKT	165
58550	5-FLAT LOOP 72 IN BULK	165
58551	5-FLAT LOOP 72 IN PACKAGED	165
58650	12 VOLT CIRCUIT TESTER 6 WAY R	171
58671	I-6/I-7, 4 POLE DIE CAST CONNE	165
58677	I-6/I-7/I-21 PKG.	165
58750	DUST COVER TRAILER SIDE	164
58761	DUST COVER SET	164
58823	1/4 IN CONVOLUTED SLIT LOOM PE	173
58918	RV HARNESS, 4 FLAT ADD-ON	224
58919	RV HARNESS, NPWR CONVER ADD-ON	224
58920	RV HARNESS, PWR CONVER ADD-ON	224
58979	RV, SPLICE IN HARNESS	224
58999	BAG, KIT, RV HARNESS DIO	224
59187	CONVERTER,BASIC,PWRKIT,PKD(SM)	148
59190	CONVERTER,HD,PWRKIT,SMRT BRD	148
59421	22-18 G BUTT CONNECTORS 100 PE	172
59422	16-14 G BUTT CONNECTORS - 100	172
59423	12-10 G BUTT CONNECTORS - 100	172
59432	16-14 G MALE QUICK CONNECTOR -	172
59433	12-10 G MALE QUICK CONNECTOR -	172
59496	POTTED CONVERTER W/ WIRE KIT	148
59521	16-14 G 10 RING TERM - 100 PER	172
59522	16-14 G 1/4 IN RING TERM 100 P	172
59523	16-14 G 3/8 IN RING TERM 100 P	172

Part#	Description	Page#
59525	16-14 G 5/16 IN RING TERM 100	172
59531	12-10 G 10 RING TERM 100 PER B	172
59534	12-10 G 1/4 IN RING TERM 100 P	172
59538	12-10 G 3/8 IN RING TERM 100 P	172
59556	12-10 G 5/16 IN RING TERM 100	172
59592	16-14 G FEMALE QUICK CONNECTOR	172
59593	12-10 G FEMALE QUICK CONNECTOR	172
59611	22-18 G SPADE TERMINALS - 100	172
59621	16-14 G SPADE TERMINALS - 100	172
59631	12-10 G SPADE TERMINALS - 100	172
59728	7 1/4 IN NYLON WIRE TIES 100 P	173
59732	14 1/4 IN NYLON WIRE TIES 100	173
59740	3/4 IN X 60 FT 10 PACK ELECTRICAL	173
59824	3/8 IN CONVOLUTED SLIT LOOM PE	173
59825	3/8 X 25 FT SLIT LOOM PACKAGED	173
59826	1/2 IN BLACK CONVOLUTED SLIT L	173
59827	1/2 X 25 IN SLIT LOOM PACKAGED	173
59828	3/8 IN ID NYLON LOOM/PACKS 25	173
59901	WIRE NUTS - 100 PER BAG	172
59905	12-10 GAUGE QUICK SPLICES 100	172
59906	14-18 GAUGE QUICK SPLICES 100	172
59956	18-14 GAUGE TAP CONNECTOR 100	172
60601	60601 OE GOOSEBALL	231
60602	ROUND SHANK BALL EXTENSION	236
60603	ROUND SHANK HIGH RISE BALL	236
60604	CHEV/GMC 2500/3500 INSTALL KIT	238
60607	DOUBLE LOCK GOOSENECK W/NOTCH	236
60611	DOUBLE LOCK EZR GOOSENECK	235
60614	RAM 2500 GOOSENECK HITCH	233
60615	CHEVY 1500 GOOSENECK CENTER	236
60616	600 SERIES REPLACEMENT BALL	236
60617	60617 RAM SAFETY CHAIN LOOPS	231
60618	RAM SAFETY CHAIN KIT 30K	231
60619	DOUBLE LOCK EZR GOOSENECK	235
60624	GM GOOSENECK SUB KIT	235
60626	GOOSENECK CENTER	233
60627	2-5/16" OE GOOSEBALL 38K	231
60628	3" OE GOOSEBALL 30K	231
60629	2-5/16" OE GOOSEBALL 30K	231
60631	GOOSENECK INSTALL KIT 1988-200	238
60632	NEW BODY CHEVY SUBKIT	238
60633	RAM HD GOOSENECK HITCH 35K	233
60634	3" OE GOOSEBALL 38K	231
60635	GOOSENECK INSTALL KIT 1994-200	238
60636	GOOSENECK INSTALL KIT OLD BODY	238
60637	GOOSENECK INSTALL KIT 1997-200	238
60638	RAM PUCK SYSTEM KIT 38K	231
60639	GM PUCK SYSTEM KIT 38K	231
60641	GOOSENECK INSTALL KIT NEW BODY	238
60642	KIT, 60686 & 60697	233
60644	SUB-KIT,600 SERIES,FORD SD	238
60645	SUB-KIT, FORD SD	235
60647	SUB-KIT, EZR, FORD SD	235
60648	SUB-KIT, EZR, CHEV HD	235
60649	SUB-KIT, FORD F-150	238
60652	GOOSENECK INSTALL KIT, CHEVY	238
60657	DODGE RAM INSTALL KIT	238
60659	SUBKIT,C-600,30K	238
60660	DODGE 2500/3500 INSTALL KIT	235
60661	DODGE 2500/3500 INSTALL KIT	238
60667	07 TOYOTA TUNDRA SUB-KIT	238
60680	KIT, 60624 & 60611	235
60681	KIT, 60648 & 60619	235
60682	KIT, 60660 & 60619	235
60683	KIT, 60645 & 60619	235
60685	KIT, 60647 & 60619	235
60687	KIT, 60611 & 60696 (25K)	235
60691	GM SAFETY CHAIN LOOPS 30K	231
60692	GM SAFETY CHAIN KIT 30K	231
60696	SUB-KIT, EZR, GM HD	235
60698	RAM SAFETY CHAIN LOOPS 38K	231
60700	KIT, 60610 & 60651	233
60710	KIT, 60607 & 60604	238
60711	KIT, 60615 & 60632	238
60712	KIT, 60607 & 60652	238
60713	KIT, 60607 & 60631	238
60720	KIT, 60607 & 60644	238
60721	KIT, 60607 & 60641	238
60722	KIT, 60607 & 60637	238
60723	KIT, 60607 & 60636	238

Part#	Description	Page#
60724	KIT, 60607 & 60649	238
60730	KIT, 60607 & 60657	238
60732	KIT, 60607 & 60661	238
60733	KIT, 60607 & 60659	238
60734	KIT, 60607 & 60635	238
60751	KIT, 60607 & 60667	238
61052	FOLDING BALL GOOSENECK HITCH A	240
61100	HITCH PLATE WITH BALL	240
61301	30K CHEV/GMC HD INSTALL KIT	241
61332	30K SUPER DUTY INSTALL KIT	241
61341	FOLDING HITCH BALL ASSEMBLY KI	241
61502	C-52 INSTALL KIT UNIVERSAL 30K	241
61509	C-52 INSTALL KIT 30K GTW	241
65500	FLAT HITCH PLATE 13 IN X 48 IN	240
66113	SAFETY CHAIN U-BOLT KIT	240
66155	REPLACEMENT CAP FOR 60613	231
66165	REPLACEMENT CAP FOR 600 SERIES	235
70001	7500 LB STEEL TOW BAR	217
70002	BASE PLATE INSERT TAB - REG	219
70003	BASE PLATE INSERT TAB EXTENDED	219
70005	KEYED ALIKE LOCKS 5/8" & 2.5"	219
70006	TOW BAR SAFETY CABLES 250	219
70007	TOW BAR SAFETY CABLES .375	219
70008	TOW BAR SAFETY CABLE ASMBY 84"	219
70101	DURANGO JEEP BASEPLATE	218
70102	JEEP WRANGLER JK BASEPLATE	218
70103	19 JEEP CHEROKEE BASEPLATE	218
70104	HONDA CR-V BASEPLATE	218
70105	18-19 JEEP WRANGLER BASEPLATE	218
70106	09-20 FORD F-150 BASEPLATE	218
70107	15-20 CHEVY COLORADO BASEPLATE	218
70108	18-20 CHEVY EQUINOX BASEPLATE	218
70109	10-17 GMC TERRAIN BASEPLATE	218
70110	JEEP WRANGLER JK BASEPLATE	218
70111	16-19 TAHOE / SIERRA BASEPLATE	218
70112	97-06 JEEP WRANGLER BASEPLATE	218
70113	16-18 FORD FOCUS BASEPLATE	218
70114	16-19 FORD EXPLORER BASE PLATE	218
70115	07-11 HONDA CR-V BASEPLATE	218
70116	12-19 CHEVY SONIC BASEPLATE	218
70117	16-19 BUICK ENVISION BASEPLATE	218
70118	17-19 GMC ACADIA BASEPLATE	218
70119	14-19 FORD FIESTA BASEPLATE	218
70120	15-19 CHEVY SILVERADO BASEPLAT	218
70123	10-16 CADILLAC SRX BASEPLATE	218
80010	3/16 X 41 GRD 30 PLUS 2 J-26	257
80011	PKG 3/16 X 41 GRD30 PLUS2 J-26	257
80020	3/16 X 24 GRD 30 PLUS 1 J-26	257
80030	1/4 X 40 GRD 30 PLUS 2 J-27	257
80031	PKG 1/4 X 40 GRD30 PLUS 2 J-27	257
80040	1/4 X 23 GRD 30 PLUS 1 J-27	257
80136	CABLE, TRAILER SAFETY 3500LB	258
80151	CABLE, TRAILER SAFETY 5000LB	258
80176	CABLE, TRAILER SAFETY 7600LB	258
80300	8/0 X 23 GRD 30 PLUS 1 J-62	257
80301	8/0 X 40 GRD 30 PLUS 2 J-62	257
80302	1/4 X 33 GRD 43 PLUS 1 J-90	258
80303	1/4 X 32 GRD 70 PLUS 1 J-94	258
80304	5/16 X 32 GRD 70 PLUS 1 J-95	258
80305	5/16 X 162 GRD70 PLUS 2 J-370	259
80306	5/16 X 186 GRD 70 PLUS 2 J-370	259
80307	5/16 X 234 GRD 70 PLUS 2 J-370	259
80308	5/16 X 294 GRD 70 PLUS 2 J-370	259
80309	3/8 X 162 GRD 70 PLUS 2 J-380	259
80310	3/8 X 186 GRD 70 PLUS 2 J-380	259
80311	3/8 X 234 GRD 70 PLUS 2 J-380	259
80312	3/16 X 24 GRD30 PLUS 1 J-26SL	257
80313	1/4 X 24 GRD 30 PLUS 1 J-27SL	257
80314	5/16 X 32 GRD 43 PLUS 1 J-55	258
80315	3/8 X 31 GRD 43 PLUS 1 J-56	258
80316	3/8 X 31 GRD 70 PLUS 1 J-96	258
81260	3/8IN CERTIFIED S-HOOK 2000 GT	260
81261	3/8 IN HOOK WITH SAFETY LATCH	261
81266	3/8 IN S-HOOK WITH SAFETY LATCH	261
81270	7/16 IN CERTIFIED S-HOOK 5000	260
81271	CLASS 2 3500 GVWR WITH SAFETY	261
81277	7/16 IN S-HOOK WITH SAFETY LAT	261
81281	CLASS 3 5000 GVWR WITH SAFETY	261
81288	9/16 IN S-HOOK WITH SAFETY LAT	261
81330	1/4 IN CLEVIS GRAB HOOK GRADE	259

Part#	Description	Page#
81340	5/16 IN CLEVIS GRAB HOOK GRADE	259
81350	3/8 IN CLEVIS GRAB HOOK GRADE	259
81360	SNAP HOOK WITH 5/8 IN EYE	261
81438	3/8 IN CLEVIS GRAB HOOK GRADE	259
81502	1/4 IN CLEVIS GRAB HOOK GRADE	259
81503	5/16 IN CLEVIS GRAB HOOK GRADE	259
81550	5/16 IN CLEVIS SAFETY LATCH HO	260
81560	3/8 IN SAFETY HOOK WITH LATCH	260
81620	17/32 IN CERTIFIED S-HOOK 7600	260
81640	13/32 IN S-HOOK 3500 LB CAPACI	260
81810	3/8" S-HOOK W/WIRE LATCH GTW 2	260
81820	7/16" S-HOOK W/WIRE LATCH GTW	260
81830	17/32" S-HOOK W/WIRE LATCH GTW	260
81840	13/32" S HOOK WITH SAFETY LATCH	260
81900	1/4 IN CLEVIS SAFETY LATCH HOO	260
81910	1/2 IN SAFETY HOOK WITH LATCH	260
81920	5/8 IN SFTY HK W/LATCH G80	260
81940	1/4 IN CLEVIS SAFETY LATCH HOO	260
81950	5/16 IN SAFETY HOOK WITH LATCH	260
81960	3/8 IN SAFETY HOOK WITH LATCH	260
81970	7/16 IN CLEVIS SAFETY HOOK G80	260
81980	1/2 IN CLEVIS SAFETY HOOK G80	260
81999	YELLOW ZINC LATCH KIT IN P	260
82610	1/4 IN THREADED LINK 880 LB CA	261
82611	1/4 IN THREADED LINK 880LB CAP	261
82900	5/16 IN THREADED LINK 1760LB C	261
82901	5/16 IN THREADED LINK 1760LB C	261
82903	5/16" QUICK LINK 2 PACK	261
82930	3/8 IN THREADED LINK 2200LB CA	261
82931	7/16 IN THREADED LINK 2640LB C	261
82932	1/2 IN THREADED LINK 3300LB CA	261
82933	3/8 IN THD LINK 2200LB PKG	261
82940	9/0 JOINING LINK RAW FINISH 10	261
82942	7/16 IN JOINING LINK RAW FINIS	261
82943	9/0 JOINING LINK ZINC	261
82944	7/16 IN JOINING LINK ZINC	261
83001	RATCHET, 1" X 10', 1500#	281
83002	RATCHET, 1" X 16', 1500#	281
83009	RATCHET, 1" X 10', 1500#	281
83010	RATCHET, 1" X 16', 1500#	281
83015	CAM TIE DOWN, 1" X 15', 900#	281
83016	CAM TIE DOWN, 1" X 16', 900#	281
83019	RATCHET, 1" X 16', 2200#	281
83020	RATCHET, 1" X 16', 2200#	281
83025	RATCHET, 1-1/16" X 16', 3300#	281
83026	RATCHET, 1-1/16" X 16', 3300#	281
83027	RATCHET, 1-1/16" X 16', 3300#	281
83028	RATCHET, 1-1/16" X 16', 3300#	281
83036	RATCHET, 1-1/2" X 14', 5000#	281
83047	RATCHET, 2" X 27', 10000#	281
83048	RATCHET, 2" X 27', 10000#	281
83060	HIDE-A-TIE ROPE HOOK, BULK	285
83061	HIDE-A-TIE ROPE HOOK - PKG.	285
83066	2 IN X 30 FT VEHICLE RECOVERY	112
83072	WELD ON ANCHOR 1 5/8 IN X 3 1/	285
83600	5000 GTW RECESSED FLOOR/WALL T	285
83601	1200 GTW FOR USE WITH 3/8 IN P	285
83607	BACKING PLATE FOR J-600 AND J-	285
83710	1000 LB CAPACITY 1/4 IN DIAMET	285
83720	BLACK PLASTIC TRIM RING FOR J-	285
83730	1200 LB CAP 10 GA STL D-RING .	285
83731	1,200 LB CAP, 10 GA STL D-RING	285
83732	1200 LB CAP 10 GA STL DRING 22	285
83740	11000 LB CAPACITY 1/2 IN FORGE	285
83742	WHITE ZINC D-RING ASSEMBLY	285
83750	18800 LB CAP 5/8 IN FORGED D-R	285
83760	26500 LB CAP 3/4 IN FORGED D-R	285
83770	46760 LB CAP 1 IN FORGED D-RIN	285
83780	46760 LB CAP 1 IN X 5 IN X 6 I	285

CUSTOM WIRING PRODUCTS LISTED NUMERICALLY

Part #	Years	Make	Model	INS	
55028	97-03	FORD	F-150	30-60M	
	04-04	FORD	F-150 HERITAGE	30-60M	
	97-99	FORD	F-250	30-60M	
55029	99-01	FORD	F-250 SUPER DUTY	30-60M	
	99-01	FORD	F-350 SUPER DUTY	30-60M	
55050	07-07	DODGE	CALIBER	30-60M	
	07-10	JEEP	COMPASS	30-60M	
	07-07	JEEP	PATRIOT	30-60M	
55057	03-08	PONTIAC	VIBE	30-60M	
55106	07-11	HONDA	CR-V	30-60M	
55124	07-17	JEEP	WRANGLER	30-60M	
	18-18	JEEP	WRANGLER JK	30-60M	
	96-03	CHEVY	EXPRESS 1500	30-60M	
55240	96-03	CHEVY	EXPRESS 2500	30-60M	
	96-03	CHEVY	EXPRESS 3500	30-60M	
	96-03	GMC	SAVANA 1500	30-60M	
	96-03	GMC	SAVANA 2500	30-60M	
	96-03	GMC	SAVANA 3500	30-60M	
	55241	95-01	FORD	EXPLORER	30-60M
98-99		FORD	RANGER	30-60M	
98-01		MAZDA	B2500	30-60M	
98-01		MAZDA	B3000	30-60M	
98-01		MAZDA	B4000	30-60M	
97-01		MERCURY	MOUNTAINEER	30-60M	
55242		97-03	FORD	F-150	30-60M
		04-04	FORD	F-150 HERITAGE	30-60M
		97-99	FORD	F-250	30-60M
55243	99-01	FORD	F-250 SUPER DUTY	30-60M	
	99-01	FORD	F-350 SUPER DUTY	30-60M	
	99-01	FORD	F-450 SUPER DUTY	30-60M	
	99-01	FORD	F-550 SUPER DUTY	30-60M	
55244	00-04	NISSAN	XTERRA	30-60M	
55245	01-07	LEXUS	LX470	30-60M	
	08-11	LEXUS	LX570	30-60M	
	01-03	LEXUS	RX300	30-60M	
	01-02	TOYOTA	4RUNNER	30-60M	
	01-03	TOYOTA	HIGHLANDER	30-60M	
	01-02	TOYOTA	LAND CRUISER	30-60M	
	55246	01-02	TOYOTA	SEQUOIA	30-60M
	55247	99-01	FORD	F-250 SUPER DUTY	30-60M
99-01		FORD	F-350 SUPER DUTY	30-60M	
55249	97-99	FORD	EXPEDITION	30-60M	
	98-99	LINCOLN	NAVIGATOR	30-60M	
55250	00-02	FORD	EXPEDITION	30-60M	
	00-02	LINCOLN	NAVIGATOR	30-60M	
	55251	02-05	FORD	EXPLORER	30-60M
55251	03-05	LINCOLN	NAVIGATOR	30-60M	
	02-05	MERCURY	MOUNTAINEER	30-60M	
55255	01-04	FORD	ESCAPE	30-60M	
	01-04	MAZDA	TRIBUTE	30-60M	
55256	97-04	FORD	F-150	30-60M	
	97-99	FORD	F-250	30-60M	
55260	95-98	JEEP	GRAND CHEROKEE	30-60M	
55265	02-04	FORD	F-250 SUPER DUTY	30-60M	
	02-04	FORD	F-350 SUPER DUTY	30-60M	
55301	73-79	FORD	F-150	30-60M	
	73-79	FORD	F-250	30-60M	
	73-79	FORD	F-350	30-60M	
55302	87-88	FORD	BRONCO	30-60M	
55303	89-91	FORD	BRONCO	30-60M	
55304	86-87	MAZDA	B2000	30-60M	
	87-93	MAZDA	B2200	30-60M	
	87-93	MAZDA	B2600	30-60M	
55305	89-95	ISUZU	PICKUP	30-60M	
55307	01-05	TOYOTA	RAV4	30-60M	
55308	02-06	TOYOTA	CAMRY	30-60M	
55309	02-05	KIA	SEDONA	30-60M	
55310	09-12	HYUNDAI	ELANTRA	30-60M	
	01-06	HYUNDAI	SANTA FE	30-60M	
	06-11	KIA	RIOS	30-60M	
55311	73-74	CHEVY	BLAZER	30-60M	
	75-84	CHEVY	C10	30-60M	
	73-74	CHEVY	C10 PICKUP	30-60M	
	73-84	CHEVY	C10 SUBURBAN	30-60M	

Part #	Years	Make	Model	INS	
55311	75-84	CHEVY	C20	30-60M	
	73-74	CHEVY	C20 PICKUP	30-60M	
	73-84	CHEVY	C20 SUBURBAN	30-60M	
	75-84	CHEVY	C30	30-60M	
	73-74	CHEVY	C30 PICKUP	30-60M	
	75-84	CHEVY	K10	30-60M	
	73-74	CHEVY	K10 PICKUP	30-60M	
	73-84	CHEVY	K10 SUBURBAN	30-60M	
	75-84	CHEVY	K20	30-60M	
	73-74	CHEVY	K20 PICKUP	30-60M	
	73-84	CHEVY	K20 SUBURBAN	30-60M	
	77-84	CHEVY	K30	30-60M	
	73-74	CHEVY	K30 PICKUP	30-60M	
	75-84	CHEVY	K5 BLAZER	30-60M	
	75-78	GMC	C15	30-60M	
	75-78	GMC	C15 SUBURBAN	30-60M	
	73-74	GMC	C15/C1500 PICKUP	30-60M	
	73-74	GMC	C15/C1500 SUBURBAN	30-60M	
	79-84	GMC	C1500	30-60M	
	79-84	GMC	C1500 SUBURBAN	30-60M	
	75-78	GMC	C25	30-60M	
	75-78	GMC	C25 SUBURBAN	30-60M	
	73-74	GMC	C25/C2500 PICKUP	30-60M	
	73-74	GMC	C25/C2500 SUBURBAN	30-60M	
	79-84	GMC	C2500	30-60M	
	79-84	GMC	C2500 SUBURBAN	30-60M	
	75-78	GMC	C35	30-60M	
	73-74	GMC	C35/C3500 PICKUP	30-60M	
	79-84	GMC	C3500	30-60M	
	75-78	GMC	K15	30-60M	
	75-78	GMC	K15 SUBURBAN	30-60M	
	73-74	GMC	K15/K1500 PICKUP	30-60M	
	73-74	GMC	K15/K1500 SUBURBAN	30-60M	
	79-84	GMC	K1500	30-60M	
	79-84	GMC	K1500 SUBURBAN	30-60M	
	75-78	GMC	K25	30-60M	
	75-78	GMC	K25 SUBURBAN	30-60M	
	73-74	GMC	K25/K2500 PICKUP	30-60M	
	73-74	GMC	K25/K2500 SUBURBAN	30-60M	
	79-84	GMC	K2500	30-60M	
	79-84	GMC	K2500 SUBURBAN	30-60M	
	77-78	GMC	K35	30-60M	
	73-74	GMC	K35/K3500 PICKUP	30-60M	
	79-84	GMC	K3500	30-60M	
	55312	85-86	CHEVY	C10	30-60M
		85-86	CHEVY	C10 SUBURBAN	30-60M
		94-94	CHEVY	C1500	30-60M
		85-86	CHEVY	C20	30-60M
		85-86	CHEVY	C20 SUBURBAN	30-60M
85-86		CHEVY	C30	30-60M	
85-86		CHEVY	K10	30-60M	
85-86		CHEVY	K10 SUBURBAN	30-60M	
85-86		CHEVY	K20	30-60M	
85-86		CHEVY	K20 SUBURBAN	30-60M	
85-86		CHEVY	K30	30-60M	
85-97		CHEVY	S10	30-60M	
85-86		GMC	C1500	30-60M	
85-86		GMC	C1500 SUBURBAN	30-60M	
85-86		GMC	C2500	30-60M	
85-86		GMC	C2500 SUBURBAN	30-60M	
85-86		GMC	C3500	30-60M	
85-86		GMC	K1500	30-60M	
85-86		GMC	K1500 SUBURBAN	30-60M	
85-86		GMC	K2500	30-60M	
85-86		GMC	K2500 SUBURBAN	30-60M	
85-86	GMC	K3500	30-60M		
85-90	GMC	S15	30-60M		
91-97	GMC	SONOMA	30-60M		
91-91	GMC	SYCLONE	30-60M		
96-97	ISUZU	HOMBRE	30-60M		
55313	80-86	FORD	BRONCO	30-60M	
	80-83	FORD	F-100	30-60M	
	80-86	FORD	F-150	30-60M	
	80-86	FORD	F-250	30-60M	

Part #	Years	Make	Model	INS
55313	80-86	FORD	F-350	30-60M
55314	86-92	FORD	RANGER	30-60M
55315	88-99	GMC	C1500	30-60M
	88-00	GMC	C2500	30-60M
	88-00	GMC	C3500	30-60M
	88-99	GMC	K1500	30-60M
	88-00	GMC	K2500	30-60M
	88-00	GMC	K3500	30-60M
55316	87-96	FORD	F-150	30-60M
	87-96	FORD	F-250	30-60M
	97-97	FORD	F-250 HD	30-60M
	87-97	FORD	F-350	30-60M
	94-94	DODGE	B250	30-60M
	86-89	DODGE	D100	30-60M
86-93	DODGE	D150	30-60M	
86-93	DODGE	D250	30-60M	
86-93	DODGE	D350	30-60M	
87-94	DODGE	DAKOTA	30-60M	
94-94	DODGE	RAM 1500	30-60M	
94-94	DODGE	RAM 2500	30-60M	
94-94	DODGE	RAM 3500	30-60M	
86-93	DODGE	RAM 50	30-60M	
86-93	DODGE	RAMCHARGER	30-60M	
86-89	DODGE	W100	30-60M	
86-93	DODGE	W150	30-60M	
86-93	DODGE	W250	30-60M	
86-93	DODGE	W350	30-60M	
55318	84-91	CHEVY	S10 BLAZER	30-60M
	84-91	GMC	S15 JIMMY	30-60M
55319	99-00	CADILLAC	ESCALADE	30-60M
	92-94	CHEVY	BLAZER	30-60M
	92-99	CHEVY	C1500 SUBURBAN	30-60M
	92-99	CHEVY	C2500 SUBURBAN	30-60M
	92-99	CHEVY	K1500 SUBURBAN	30-60M
	92-99	CHEVY	K2500 SUBURBAN	30-60M
	95-00	CHEVY	TAHOE	30-60M
	92-99	GMC	C1500 SUBURBAN	30-60M
	92-99	GMC	C2500 SUBURBAN	30-60M
	92-99	GMC	K1500 SUBURBAN	30-60M
	92-99	GMC	K2500 SUBURBAN	30-60M
	00-00	GMC	YUKON XL 1500	30-60M
	00-00	GMC	YUKON XL 2500	30-60M
	55323	91-95	CHRYSLR	TOWN & COUNTRY
91-95		DODGE	CARAVAN	30-60M
04-10		DODGE	DAKOTA	30-60M
91-95		DODGE	GRAND CARAVAN	30-60M
06-09		MITSBUSHI	RAIDER	30-60M
91-95		PLYMOUTH	GRAND VOYAGER	30-60M
91-94		FORD	EXPLORER	30-60M
91-94		MAZDA	NAVAJO	30-60M
93-99		FORD	RANGER	30-60M
94-08		MAZDA	B2300	30-60M
98-01	MAZDA	B2500	30-60M	
94-07	MAZDA	B3000	30-60M	
94-08	MAZDA	B4000	30-60M	
55326	92-97	FORD	CROWN VICTORIA	30-60M
	94-04	FORD	MUSTANG	30-60M
92-97	MERCURY	GRAND MARQUIS	30-60M	
55327	92-95	FORD	TAURUS	30-60M
55328	93-94	DODGE	B150	30-60M
	95-98	DODGE	B1500	30-60M
	93-94	DODGE	B2500	30-60M
	95-98	DODGE	B2500	30-60M
	93-94	DODGE	B3500	30-60M
	95-98	DODGE	B3500	30-60M
55329	95-03	DODGE	DAKOTA	30-60M
	95-01	DODGE	RAM 1500	30-60M
	95-02	DODGE	RAM 2500	30-60M
	95-02	DODGE	RAM 3500	30-60M
	94-97	HONDA	PASSPORT	30-60M
92-97	ISUZU	RODEO	30-60M	
55333	96-99	FORD	TAURUS	30-60M
	96-99	MERCURY	SABLE	30-60M

Part #	Years	Make	Model	INS
55334	00-00	CHRYSLR	GRAND VOYAGER	30-60M
	96-00	CHRYSLR	TOWN & COUNTRY	30-60M
	00-00	CHRYSLR	VOYAGER	30-60M
	96-00	DODGE	CARAVAN	30-60M
	98-03	DODGE	DURANGO	30-60M
	96-00	DODGE	GRAND CARAVAN	30-60M
	96-00	PLYMOUTH	GRAND VOYAGER	30-60M
	96-00	PLYMOUTH	VOYAGER	30-60M
55335	96-99	CHEVY	EXPRESS 1500	30-60M
	96-99	CHEVY	EXPRESS 2500	30-60M
	96-99	CHEVY	EXPRESS 3500	30-60M
	96-99	GMC	SAVANA 1500	30-60M
	96-99	GMC	SAVANA 2500	30-60M
	96-99	GMC	SAVANA 3500	30-60M
55336	97-03	ACURA	CL	30-60M
	94-01	ACURA	INTEGRA	30-60M
	01-06	ACURA	MDX	30-60M
	96-01	ACURA	RL	30-60M
	96-03	ACURA	TL	30-60M
	94-02	HONDA	ACCORD	30-60M
	97-06	HONDA	CR-V	30-60M
	03-04	HONDA	ELEMENT	30-60M
	95-04	HONDA	ODYSSEY	30-60M
	03-08	HONDA	PILOT	30-60M
	01-01	HONDA	PRELUDE	30-60M
	96-99	ISUZU	OASIS	30-60M
55337	93-96	CHEVY	LUMINA APV	30-60M
	93-96	OLDSMBL	SILHOUETTE	30-60M
	93-96	PONTIAC	TRANS SPORT	30-60M
55338	87-95	CHEVY	G10	30-60M
	87-95	CHEVY	G20	30-60M
	87-95	CHEVY	G30	30-60M
	87-95	GMC	G1500	30-60M
	87-95	GMC	G2500	30-60M
	87-95	GMC	G3500	30-60M
55339	96-99	ACURA	SLX	30-60M
	92-02	ISUZU	TROOPER	30-60M
55341	96-02	TOYOTA	4RUNNER	30-60M
55343	92-94	FORD	E-150 ECONO	30-60M
	92-94	FORD	E-150 ECONO CL WGN	30-60M
	92-94	FORD	E-250 ECONO	30-60M
	92-94	FORD	E-350 ECONO	30-60M
	92-94	FORD	E-350 ECONO CL WGN	30-60M
	01-03	FORD	ESCAPE	30-60M
	01-03	MAZDA	TRIBUTE	30-60M
	96-05	MERCURY	SABLE	30-60M
55344	03-03	FORD	E-150	30-60M
	03-03	FORD	E-150 CLUB WAGON	30-60M
	95-02	FORD	E-150 ECONO	30-60M
	95-02	FORD	E-150 ECONO CL WGN	30-60M
	03-03	FORD	E-250	30-60M
	95-02	FORD	E-250 ECONO	30-60M
	03-03	FORD	E-350 CLUB WAGON	30-60M
	95-98	FORD	E-350 ECONO	30-60M
	95-02	FORD	E-350 ECONO CL WGN	30-60M
	99-03	FORD	E-350 SUPER DUTY	30-60M
	00-02	FORD	E-450 ECONO SUPR DTY	30-60M
	03-03	FORD	E-450 SUPER DUTY	30-60M
	02-02	FORD	E-550 ECONO SUPR DTY	30-60M
	03-03	FORD	E-550 SUPER DUTY	30-60M
	96-99	FORD	ECONO SUPR DTY	30-60M
	97-99	FORD	ESCORT	30-60M
	00-03	FORD	EXCURSION	30-60M
	97-03	FORD	EXPEDITION	30-60M
	01-03	FORD	EXPLORER	30-60M
	02-03	FORD	EXPLORER SPORT TRAC	30-60M
	97-03	FORD	F-150	30-60M
	04-04	FORD	F-150 HERITAGE	30-60M
	00-03	FORD	FOCUS	30-60M
	00-03	FORD	RANGER	30-60M
	03-04	LINCOLN	AVIATOR	30-60M
	98-03	LINCOLN	NAVIGATOR	30-60M
	02-03	MERCURY	MOUNTAINEER	30-60M
	97-99	MERCURY	TRACER	30-60M
55345	95-01	FORD	EXPLORER	30-60M
	97-01	MERCURY	MOUNTAINEER	30-60M
55346	95-98	FORD	WINDSTAR	30-60M
55347	91-96	BUICK	ROADMASTER	30-60M
	91-96	CHEVY	CAPRICE	30-60M

Part #	Years	Make	Model	INS
55347	94-96	CHEVY	IMPALA	30-60M
55349	94-98	JEEP	GRAND CHEROKEE	30-60M
55350	92-96	FORD	BRONCO	30-60M
55351	92-95	MERCURY	SABLE	30-60M
55352	91-96	BUICK	ROADMASTER	30-60M
	91-96	CHEVY	CAPRICE	30-60M
	91-92	OLDSMBL	CUSTOM CRUISER	30-60M
55353	87-95	NISSAN	PATHFINDER	30-60M
	95-97	NISSAN	PICKUP	30-60M
55354	97-01	JEEP	CHEROKEE	30-60M
55355	97-05	CHEVY	VENTURE	30-60M
	97-04	OLDSMBL	SILHOUETTE	30-60M
	99-09	PONTIAC	MONTANA	30-60M
	97-98	PONTIAC	TRANS SPORT	30-60M
55356	97-97	JEEP	TJ	30-60M
	91-97	JEEP	WRANGLER	30-60M
55358	97-01	TOYOTA	CAMRY	30-60M
55359	98-04	CHEVY	S10	30-60M
	98-04	GMC	SONOMA	30-60M
	98-00	ISUZU	HOMBRE	30-60M
55360	98-02	HONDA	PASSPORT	30-60M
	98-00	ISUZU	AMIGO	30-60M
	98-04	ISUZU	RODEO	30-60M
	01-03	ISUZU	RODEO SPORT	30-60M
55361	97-03	INFINITI	QX4	30-60M
	98-01	NISSAN	ALTIMA	30-60M
	96-04	NISSAN	PATHFINDER	30-60M
55362	98-98	MERCURY	VILLAGER	30-60M
	98-03	NISSAN	FRONTIER	30-60M
	98-98	NISSAN	QUEST	30-60M
55363	98-06	JEEP	TJ	30-60M
	98-06	JEEP	WRANGLER	30-60M
55364	99-04	CHRYSLR	300M	30-60M
	98-02	CHRYSLR	CONCORDE	30-60M
	99-99	CHRYSLR	LHS	30-60M
	98-04	DODGE	INTREPID	30-60M
55365	98-99	LEXUS	LX470	30-60M
	98-99	TOYOTA	LAND CRUISER	30-60M
55366	99-03	FORD	WINDSTAR	30-60M
55367	00-00	TOYOTA	TUNDRA	30-60M
55368	99-00	DODGE	RAM 1500 VAN	30-60M
	99-00	DODGE	RAM 2500 VAN	30-60M
	99-00	DODGE	RAM 3500 VAN	30-60M
55369	99-04	JEEP	GRAND CHEROKEE	30-60M
55370	06-07	SUBARU	B9 TRIBECA	30-60M
	98-08	SUBARU	FORESTER	30-60M
	04-04	SUBARU	IMPREZA	30-60M
	96-99	SUBARU	LEGACY	30-60M
	00-09	SUBARU	OUTBACK	30-60M
	08-14	SUBARU	TRIBECA	30-60M
55371	98-02	KIA	SPORTAGE	30-60M
55372	98-04	CHEVY	TRACKER	30-60M
	96-97	GE0	TRACKER	30-60M
	99-05	SUZUKI	GRAND VITARA	30-60M
	89-98	SUZUKI	SIDEKICK	30-60M
	99-04	SUZUKI	VITARA	30-60M
	02-06	SUZUKI	XL-7	30-60M
55373	00-06	LINCOLN	LS	30-60M
55375	00-03	FORD	TAURUS	30-60M
	00-03	MERCURY	SABLE	30-60M
55376	01-03	CHRYSLR	TOWN & COUNTRY	30-60M
	01-03	CHRYSLR	VOYAGER	30-60M
	01-03	DODGE	CARAVAN	30-60M
	01-03	DODGE	GRAND CARAVAN	30-60M
55377	00-02	CHEVY	EXPRESS 1500	30-60M
	00-02	CHEVY	EXPRESS 2500	30-60M
	00-02	CHEVY	EXPRESS 3500	30-60M
	00-02	GMC	SAVANA 1500	30-60M
	00-02	GMC	SAVANA 2500	30-60M
	00-02	GMC	SAVANA 3500	30-60M
55378	01-02	TOYOTA	TUNDRA	30-60M
55379	89-95	TOYOTA	PICKUP	30-60M
	95-04	TOYOTA	TACOMA	30-60M
55380	01-06	MITSBHSI	MONTERO	30-60M
55381	07-08	CHRYSLR	ASPEN	30-60M
	04-08	CHRYSLR	PACIFICA	30-60M
	00-09	DODGE	DAKOTA	30-60M
	00-08	DODGE	DURANGO	30-60M
	00-08	DODGE	RAM 1500	30-60M

Part #	Years	Make	Model	INS
55381	01-03	DODGE	RAM 1500 VAN	30-60M
	00-09	DODGE	RAM 2500	30-60M
	01-03	DODGE	RAM 2500 VAN	30-60M
	00-09	DODGE	RAM 3500	30-60M
	01-03	DODGE	RAM 3500 VAN	30-60M
	03-09	DODGE	SPRINTER 2500	30-60M
	03-09	DODGE	SPRINTER 3500	30-60M
	03-09	FRGHTLNR	SPRINTER 2500	30-60M
	03-09	FRGHTLNR	SPRINTER 3500	30-60M
	06-10	JEEP	COMMANDER	30-60M
	00-10	JEEP	GRAND CHEROKEE	30-60M
	05-08	JEEP	LIBERTY	30-60M
	06-09	MITSBHSI	RAIDER	30-60M
55382	02-07	JEEP	LIBERTY	30-60M
55383	02-07	BUICK	RENDEZVOUS	30-60M
	01-05	PONTIAC	AZTEK	30-60M
55400	06-11	HYUNDAI	AZERA	30-60M
	01-07	TOYOTA	HIGHLANDER	30-60M
55411	95-05	CHEVY	ASTRO	30-60M
	95-02	CHEVY	BLAZER	30-60M
	95-01	GMC	JIMMY	30-60M
	95-05	GMC	SAFARI	30-60M
	96-01	OLDSMBL	BRAVADA	30-60M
55413	92-94	CHEVY	S10 BLAZER	30-60M
55414	06-10	JEEP	COMMANDER	30-60M
55418	98-03	TOYOTA	SIENNA	30-60M
55432	05-10	CHEVY	COBALT	30-60M
	06-11	CHEVY	HRH	30-60M
	07-09	PONTIAC	G5	30-60M
	05-06	PONTIAC	PURSUIT	30-60M
55434	05-10	CHEVY	COBALT	30-60M
	07-10	PONTIAC	G5	30-60M
	05-06	PONTIAC	PURSUIT	30-60M
55441	05-20	NISSAN	FRONTIER	30-60M
	05-10	NISSAN	PATHFINDER	30-60M
	05-15	NISSAN	XTERRA	30-60M
	09-12	SUZUKI	EQUATOR	30-60M
55451	05-06	JEEP	GRAND CHEROKEE	30-60M
55486	96-00	TOYOTA	RAV4	30-60M
55493	90-90	CHRYSLR	TOWN & COUNTRY	30-60M
	89-90	DODGE	CARAVAN	30-60M
	89-90	DODGE	GRAND CARAVAN	30-60M
	89-90	PLYMOUTH	GRAND VOYAGER	30-60M
	89-90	PLYMOUTH	VOYAGER	30-60M
55495	76-82	JEEP	CHEROKEE	30-60M
	76-82	JEEP	WAGONEER	30-60M
55502	06-14	ACURA	TSX	30-60M
	03-12	HONDA	ACCORD	30-60M
55504	02-05	DODGE	RAM 1500	30-60M
	03-05	DODGE	RAM 2500	30-60M
	03-05	DODGE	RAM 3500	30-60M
55510	04-12	CHEVY	COLORADO	30-60M
	04-12	GMC	CANYON	30-60M
	06-06	ISUZU	I-280	30-60M
	07-08	ISUZU	I-290	30-60M
	06-06	ISUZU	I-350	30-60M
	07-08	ISUZU	I-370	30-60M
55513	08-12	TOYOTA	HILUX	30-60M
	93-98	TOYOTA	T100	30-60M
	05-15	TOYOTA	TACOMA	30-60M
55522	00-02	TOYOTA	ECHO	30-60M
	03-08	TOYOTA	MATRIX	30-60M
55525	03-03	FORD	WINDSTAR	30-60M
55528	05-09	HYUNDAI	TUCSON	30-60M
55529	05-10	KIA	SPORTAGE	30-60M
55530	04-08	CHRYSLR	PACIFICA	30-60M
55532	01-10	CHRYSLR	PT CRUISER	30-60M
55534	05-07	CHRYSLR	300	30-60M
	08-14	DODGE	CHALLENGER	30-60M
	06-10	DODGE	CHARGER	30-60M
55537	04-07	CHRYSLR	TOWN & COUNTRY	30-60M
	04-07	DODGE	CARAVAN	30-60M
	04-07	DODGE	GRAND CARAVAN	30-60M
55540	03-14	CHEVY	EXPRESS 1500	30-60M
	03-20	CHEVY	EXPRESS 2500	30-60M
	03-20	CHEVY	EXPRESS 3500	30-60M
	03-14	GMC	SAVANA 1500	30-60M
	03-20	GMC	SAVANA 2500	30-60M
	03-20	GMC	SAVANA 3500	30-60M

Part #	Years	Make	Model	INS
55542	03-13	TOYOTA	COROLLA	30-60M
55546	05-10	CHRYSLR	300	30-60M
55550	03-06	KIA	SORENTO	30-60M
55551	04-04	FORD	F-150	30-60M
	04-04	FORD	F-150 HERITAGE	30-60M
55560	05-06	CHEVY	EQUINOX	30-60M
	06-06	PONTIAC	TORRENT	30-60M
55562	05-08	DODGE	MAGNUM	30-60M
55563	04-06	LEXUS	RX330	30-60M
	07-12	LEXUS	RX350	30-60M
55565	03-06	MITSBASHI	OUTLANDER	30-60M
55567	14-18	MAZDA	3	30-60M
	03-08	MAZDA	6	30-60M
	07-12	MAZDA	CX-7	30-60M
	07-17	TOYOTA	CAMRY	30-60M
	14-19	TOYOTA	COROLLA	30-60M
	07-14	TOYOTA	FJ CRUISER	30-60M
55570	04-09	NISSAN	QUEST	30-60M
55571	03-14	NISSAN	MURANO	30-60M
55580	04-10	TOYOTA	SIENNA	30-60M
55585	06-14	HONDA	RIDGELINE	30-60M
55587	05-07	FORD	FIVE HUNDRED	30-60M
	05-07	FORD	FREESTYLE	30-60M
55593	07-12	MAZDA	CX-7	30-60M
55597	07-09	CHRYSLR	ASPEN	30-60M
	04-09	DODGE	DURANGO	30-60M
56002	06-12	SUZUKI	GRAND VITARA	30-60M
	07-11	SUZUKI	SX4	30-60M
56008	07-18	ACURA	RDX	30-60M
	10-11	HONDA	ACCORD CROSSTOUR	30-60M
56009	07-13	JEEP	GRAND CHEROKEE	30-60M
56010	00-06	MAZDA	MPV	30-60M
56011	11-15	HONDA	ACCORD	30-60M
	06-15	HONDA	CIVIC	30-60M
	07-13	HONDA	FIT	30-60M
	04-13	MAZDA	3	30-60M
	13-15	MAZDA	CX-5	30-60M
	09-12	MITSBASHI	GALANT	30-60M
56012	07-09	CHEVY	EQUINOX	30-60M
	07-09	PONTIAC	TORRENT	30-60M
	07-08	SUZUKI	XL-7	30-60M
56013	04-07	CHEVY	MALIBU	30-60M
	05-09	PONTIAC	G6	30-60M
56014	05-11	CHEVY	CORVETTE	30-60M
	07-11	FORD	FOCUS	30-60M
	11-11	FORD	RANGER	30-60M
56015	08-09	FORD	TAURUS	30-60M
	08-09	MERCURY	SABLE	30-60M
56016	11-14	MAZDA	2	30-60M
	06-15	MAZDA	5	30-60M
	07-15	MAZDA	CX-9	30-60M
56017	07-09	SATURN	AURA	30-60M
56018	02-07	SATURN	VUE	30-60M
56020	04-14	FORD	E-150	30-60M
	04-14	FORD	E-250	30-60M
	04-18	FORD	E-350 SUPER DUTY	30-60M
56021	07-12	NISSAN	VERSA	30-60M
56022	07-15	NISSAN	ALTIMA	30-60M
	04-14	NISSAN	MAXIMA	30-60M
	07-12	NISSAN	SENTRA	30-60M
56025	07-10	SATURN	OUTLOOK	30-60M
56026	12-12	CHEVY	CAPTIVA SPORT	30-60M
56026	08-10	SATURN	VUE	30-60M
56027	08-12	BUICK	ENCLAVE	30-60M
	08-12	CHEVY	MALIBU	30-60M
	09-12	CHEVY	TRAVERSE	30-60M
56028	08-10	DODGE	AVENGER	30-60M
56029	07-11	HONDA	ELEMENT	30-60M
56030	04-06	SCION	XB	30-60M
56031	97-07	FORD	F-150	30-60M
	04-04	FORD	F-150 HERITAGE	30-60M
56032	03-07	FORD	F-250 SUPER DUTY	30-60M
	03-07	FORD	F-350 SUPER DUTY	30-60M
56033	11-12	INFINITI	G25	30-60M
	07-08	INFINITI	G35	30-60M
	09-13	INFINITI	G37	30-60M
	14-15	INFINITI	Q60	30-60M
	08-20	NISSAN	ROGUE	30-60M
56035	09-10	PONTIAC	VIBE	30-60M

Part #	Years	Make	Model	INS
56035	11-15	SCION	XB	30-60M
	09-13	TOYOTA	MATRIX	30-60M
56036	03-07	SATURN	ION	30-60M
56037	09-09	DODGE	JOURNEY	30-60M
56038	07-13	ACURA	MDX	30-60M
56039	04-11	MITSBASHI	ENDEAVOR	30-60M
56040	19-21	SUBARU	ASCENT	30-60M
	16-21	SUBARU	CROSSTREK	30-60M
	09-21	SUBARU	FORESTER	30-60M
	10-20	SUBARU	OUTBACK	30-60M
	13-15	SUBARU	XV CROSSTREK	30-60M
56041	09-14	HYUNDAI	GENESIS	30-60M
56042	08-19	TOYOTA	HIGHLANDER	30-60M
56043	03-07	CADILLAC	CTS	30-60M
56044	08-15	CADILLAC	CTS	30-60M
56045	05-14	VOLVO	XC90	30-60M
56046	06-13	CHEVY	IMPALA	30-60M
	14-16	CHEVY	IMPALA LIMITED	30-60M
56047	06-11	BUICK	LUCERNE	30-60M
	14-19	FORD	FIESTA	30-60M
56048	06-12	FORD	FUSION	30-60M
56049	06-10	HYUNDAI	ELANTRA	30-60M
	06-14	HYUNDAI	SONATA	30-60M
	09-09	KIA	OPTIMA	30-60M
56050	06-07	HONDA	ACCORD	30-60M
56051	06-15	HONDA	CIVIC	30-60M
56053	03-05	HONDA	ACCORD	30-60M
56054	07-10	CHRYSLR	SEBRING	30-60M
56055	08-09	FORD	TAURUS X	30-60M
56056	07-12	GMC	ACADIA	30-60M
56057	07-08	KIA	OPTIMA	30-60M
56058	07-09	KIA	AMANTI	30-60M
56058	11-15	KIA	OPTIMA	30-60M
56059	07-16	VOLVO	S80	30-60M
56061	08-14	SUBARU	IMPREZA	30-60M
56062	08-10	SCION	XB	30-60M
56064	11-13	FORD	FIESTA	30-60M
	09-10	LINCOLN	MKS	30-60M
56066	08-09	SUZUKI	SX4	30-60M
56069	08-11	VOLVO	S40	30-60M
56073	04-07	FORD	FREESTAR	30-60M
	04-07	MERCURY	MONTEREY	30-60M
56074	09-12	INFINITI	FX35	30-60M
	13-13	INFINITI	FX37	30-60M
	09-13	INFINITI	FX50	30-60M
	14-17	INFINITI	QX70	30-60M
56076	04-08	PONTIAC	GRAND PRIX	30-60M
56077	05-07	BUICK	TERRAZA	30-60M
	05-08	CHEVY	UPLANDER	30-60M
	05-06	PONTIAC	MONTANA	30-60M
	05-07	SATURN	RELAY	30-60M
56078	07-12	HYUNDAI	SANTA FE	30-60M
	10-13	KIA	FORTE	30-60M
56079	11-12	TOYOTA	AVALON	30-60M
	07-11	TOYOTA	CAMRY	30-60M
	09-16	TOYOTA	VENZA	30-60M
56081	04-06	CHEVY	AVEO	30-60M
	07-11	CHEVY	AVEO5	30-60M
	09-09	PONTIAC	G3	30-60M
56082	06-15	MAZDA	MX-5 MIATA	30-60M
56083	10-18	LEXUS	RX350	30-60M
	10-18	LEXUS	RX450H	30-60M
56084	09-14	NISSAN	CUBE	30-60M
56085	10-16	HYUNDAI	GENESIS COUPE	30-60M
56087	09-11	SUZUKI	EQUATOR	30-60M
56088	10-20	FORD	MUSTANG	30-60M
56089	10-11	CHEVY	CAMARO	30-60M
56090	10-13	FORD	TRANSIT CONNECT	30-60M
56091	10-14	SUBARU	LEGACY	30-60M
56092	07-11	CHEVY	AVEO	30-60M
56093	11-20	FORD	EXPLORER	30-60M
	10-19	FORD	TAURUS	30-60M
	13-16	LINCOLN	MKS	30-60M
56094	10-17	CHEVY	EQUINOX	30-60M
	10-17	GMC	TERRAIN	30-60M
56095	10-19	LINCOLN	MKT	30-60M
56096	10-16	CADILLAC	SRX	30-60M
56098	10-16	BUICK	LACROSSE	30-60M
56099	11-16	LEXUS	CT200H	30-60M

Part #	Years	Make	Model	INS
56099	10-12	LEXUS	HS250H	30-60M
56102	07-13	MITSBASHI	OUTLANDER	30-60M
56103	10-11	SUZUKI	KIZASHI	30-60M
56104	09-09	KIA	BORREGO	30-60M
56106	11-20	TOYOTA	SIENNA	30-60M
56107	04-07	TOYOTA	HIGHLANDER	30-60M
56108	10-13	ACURA	ZDX	30-60M
56109	10-20	DODGE	JOURNEY	30-60M
56110	10-19	FORD	F-150	30-60M
56111	08-12	SUBARU	IMPREZA	30-60M
56113	11-13	BUICK	REGAL	30-60M
56114	11-13	FORD	FIESTA	30-60M
56116	00-05	CHEVY	IMPALA	30-60M
56117	10-10	INFINITI	G37	30-60M
56119	11-13	VOLVO	C70	30-60M
56120	11-14	FORD	EDGE	30-60M
56121	11-15	LINCOLN	MXK	30-60M
56123	11-16	HONDA	CR-Z	30-60M
56124	11-16	NISSAN	JUKE	30-60M
56126	11-16	HYUNDAI	ELANTRA	30-60M
56127	10-17	MITSBASHI	LANCER	30-60M
	11-19	MITSBASHI	OUTLANDER SPORT	30-60M
	11-12	MITSBASHI	RVR	30-60M
56131	11-13	KIA	FORTE	30-60M
56133	11-13	DODGE	DURANGO	30-60M
56135	11-14	DODGE	CHARGER	30-60M
56136	08-14	SCION	XD	30-60M
56138	12-18	FORD	FOCUS	30-60M
56139	09-13	MAZDA	6	30-60M
56140	12-14	FORD	FOCUS	30-60M
56141	11-11	NISSAN	PATHFINDER	30-60M
56142	09-14	LEXUS	IS F	30-60M
	16-16	LEXUS	IS200T	30-60M
	09-15	LEXUS	IS250	30-60M
	16-16	LEXUS	IS300	30-60M
	09-16	LEXUS	IS350	30-60M
56145	11-14	CHRYSLR	300	30-60M
56147	04-15	TOYOTA	PRIUS	30-60M
56148	12-20	NISSAN	NV1500	30-60M
	12-20	NISSAN	NV2500	30-60M
	12-20	NISSAN	NV3500	30-60M
56149	12-17	HYUNDAI	ACCENT	30-60M
56153	12-17	HYUNDAI	VELOSTER	30-60M
56156	12-17	TOYOTA	PRIUS V	30-60M
56157	12-17	KIA	RIO	30-60M
56158	12-16	HONDA	CR-V	30-60M
56159	12-14	LAND RVR	RANGE ROVER EVOQUE	30-60M
56161	05-10	HONDA	ODYSSEY	30-60M
56165	06-12	TOYOTA	RAV4	30-60M
56170	12-15	HONDA	PILOT	30-60M
56171	12-17	HYUNDAI	AZERA	30-60M
56172	11-19	FORD	EXPLORER	30-60M
	13-18	FORD	POLICE INTERCEPTOR	30-60M
56173	13-17	HONDA	ACCORD	30-60M
56174	12-18	FIAT	500	30-60M
56176	13-15	CHEVY	MALIBU	30-60M
	16-16	CHEVY	MALIBU LIMITED	30-60M
56177	13-15	CHEVY	MALIBU	30-60M
	16-16	CHEVY	MALIBU LIMITED	30-60M
56179	13-16	DODGE	DART	30-60M
56180	13-19	CADILLAC	ATS	30-60M
56181	13-17	CHEVY	TRAVERSE	30-60M
56182	12-13	LEXUS	LS460	30-60M
56184	13-18	HYUNDAI	SANTA FE	30-60M
	13-18	HYUNDAI	SANTA FE SPORT	30-60M
	09-09	KIA	BORREGO	30-60M
56185	14-18	NISSAN	VERSA	30-60M
56186	14-18	KIA	FORTE	30-60M
	14-16	KIA	FORTE KOUP	30-60M
56188	18-20	CHEVY	IMPALA	30-60M
56189	14-20	MITSBASHI	OUTLANDER	30-60M
56191	14-19	FORD	FIESTA	30-60M
56192	14-20	ACURA	MDX	30-60M
56193	14-17	FIAT	500L	30-60M
56197	14-15	CHEVY	CAMARO	30-60M
56199	14-16	KIA	CADENZA	30-60M
56205	13-17	NISSAN	SENTRA	30-60M
56206	14-18	NISSAN	VERSA NOTE	30-60M
56207	14-19	CADILLAC	CTS	30-60M

Part #	Years	Make	Model	INS
56208	14-18	JEEP	CHEROKEE	30-60M
56209	14-20	RAM	PROMASTER 1500	30-60M
	14-20	RAM	PROMASTER 2500	30-60M
	14-20	RAM	PROMASTER 3500	30-60M
56210	10-17	CHEVY	EQUINOX	30-60M
	10-17	GMC	TERRAIN	30-60M
56211	11-14	CHRYSLR	200	30-60M
	11-14	DODGE	AVENGER	30-60M
56212	13-16	SCION	FR-S	30-60M
	13-20	SUBARU	BRZ	30-60M
	17-20	SUBARU	IMPREZA	30-60M
56213	14-17	ACURA	RLX	30-60M
56214	11-15	CHEVY	CRUZE	30-60M
	16-16	CHEVY	CRUZE LIMITED	30-60M
56215	13-15	HONDA	CROSSTOUR	30-60M
56216	13-16	BUICK	ENCORE	30-60M
56217	08-19	TOYOTA	HIGHLANDER	30-60M
56218	14-20	FORD	TRANSIT CONNECT	30-60M
56219	13-15	HONDA	CIVIC	30-60M
56220	07-12	KIA	RONDO	30-60M
	10-19	KIA	SOUL	30-60M
56222	07-12	KIA	RONDO	30-60M
	10-18	KIA	SOUL	30-60M
56223	14-20	MITSBSHI	MIRAGE	30-60M
	17-20	MITSBSHI	MIRAGE G4	30-60M
56224	11-20	VOLVO	S60	30-60M
	16-18	VOLVO	S60 CROSS COUNTRY	30-60M
56225	05-20	NISSAN	FRONTIER	30-60M
	05-12	NISSAN	PATHFINDER	30-60M
	05-15	NISSAN	XTERRA	30-60M
	09-12	SUZUKI	EQUATOR	30-60M
56226	05-20	NISSAN	FRONTIER	30-60M
	05-12	NISSAN	PATHFINDER	30-60M
	05-15	NISSAN	XTERRA	30-60M
	09-12	SUZUKI	EQUATOR	30-60M
56230	15-20	DODGE	CHALLENGER	30-60M
56231	04-08	ACURA	TL	30-60M
56233	17-20	HYUNDAI	ELANTRA	30-60M
	14-18	HYUNDAI	ELANTRA GT	30-60M
	17-20	HYUNDAI	IONIQ	30-60M
56234	15-20	DODGE	CHARGER	30-60M
56235	15-20	CHRYSLR	300	30-60M
56236	09-12	AUDI	A4	60-90M
	02-12	AUDI	A4 QUATTRO	60-90M
	10-16	AUDI	A5	60-90M
	09-19	AUDI	Q5	60-90M
	17-19	AUDI	Q7	60-90M
	09-09	AUDI	TT	60-90M
	08-08	BMW	335i	60-90M
	18-18	BMW	X2	60-90M
	18-19	BMW	X3	60-90M
	18-19	CADILLAC	XTS	60-90M
	13-20	CHEVY	SPARK	60-90M
	14-16	CHEVY	SPARK EV	60-90M
	10-18	FRGHTLNR	SPRINTER 2500	60-90M
	10-18	FRGHTLNR	SPRINTER 3500	60-90M
	17-18	HONDA	CIVIC	60-90M
	19-19	KIA	FORTE	60-90M
	18-18	KIA	RIO	60-90M
	20-20	LINCOLN	CORSAIR	60-90M
	08-10	MERCEDES	C300	60-90M
	11-11	MERCEDES	C350	60-90M
	17-17	MERCEDES	E300	60-90M
	11-14	MERCEDES	E350	60-90M
	14-14	MERCEDES	GL450	60-90M
	18-18	MERCEDES	GLE43 AMG	60-90M
	10-15	MERCEDES	GLK350	60-90M
	07-07	MERCEDES	R350	60-90M
	09-09	MERCEDES	S550	60-90M
	10-18	MERCEDES	SPRINTER 2500	60-90M
	10-18	MERCEDES	SPRINTER 3500	60-90M
	02-15	MINI	COOPER	60-90M
	13-13	MINI	COOPER COUNTRYMAN	60-90M
	08-09	SATURN	ASTRA	60-90M
	09-09	VOLKSWGN	CC	60-90M
	12-12	VOLKSWGN	EOS	60-90M
	10-13	VOLKSWGN	GOLF	60-90M
	18-18	VOLKSWGN	GOLF ALLTRACK	60-90M
	15-17	VOLKSWGN	GOLF SPORTWAGEN	60-90M

Part #	Years	Make	Model	INS
56236	09-15	VOLKSWGN	GTI	60-90M
	08-19	VOLKSWGN	JETTA	60-90M
	06-09	VOLKSWGN	PASSAT	60-90M
	08-08	VOLKSWGN	RABBIT	60-90M
	09-11	VOLKSWGN	TIGUAN	60-90M
	11-17	VOLKSWGN	TOUAREG	60-90M
56241	11-15	HYUNDAI	SONATA	30-60M
56242	15-17	CHRYSLR	200	30-60M
56243	16-16	SUBARU	CROSSTREK	30-60M
	14-15	SUBARU	XV CROSSTREK	30-60M
56245	13-17	BUICK	ENCLAVE	30-60M
	13-17	CHEVY	TRAVERSE	30-60M
	13-16	GMC	ACADIA	30-60M
	17-17	GMC	ACADIA LIMITED	30-60M
56246	15-19	SUBARU	LEGACY	30-60M
56247	15-17	HYUNDAI	SONATA	30-60M
56248	14-20	INFINITI	Q50	30-60M
56250	12-15	BUICK	VERANO	30-60M
56251	11-16	KIA	SPORTAGE	30-60M
56252	18-20	HYUNDAI	ACCENT	30-60M
	13-14	HYUNDAI	ELANTRA COUPE	30-60M
56254	13-17	HYUNDAI	ACCENT	30-60M
56255	14-17	BUICK	REGAL	30-60M
56256	14-18	KIA	SORENTO	30-60M
56257	12-15	CHEVY	CAPTIVA SPORT	30-60M
56258	13-20	LINCOLN	MKZ	30-60M
56259	12-16	SUBARU	IMPREZA	30-60M
	15-20	SUBARU	WRX	30-60M
	15-20	SUBARU	WRX STI	30-60M
56261	15-20	TOYOTA	SIENNA	30-60M
56262	15-19	LINCOLN	MKC	30-60M
56263	16-16	LEXUS	GS200T	30-60M
	18-18	LEXUS	GS300	30-60M
	13-18	LEXUS	GS350	30-60M
	13-18	LEXUS	GS450H	30-60M
56264	17-17	GENESIS	G80	30-60M
	15-16	HYUNDAI	GENESIS	30-60M
56267	15-20	NISSAN	MURANO	30-60M
56268	15-17	LEXUS	NX200T	30-60M
	15-17	LEXUS	NX300H	30-60M
56269	13-18	ACURA	ILX	30-60M
56270	15-20	RAM	PROMASTER CITY	30-60M
56272	15-18	FORD	EDGE	30-60M
56273	15-18	FORD	FOCUS	30-60M
56274	15-20	JEEP	RENEGADE	30-60M
56275	12-19	TOYOTA	PRIUS C	30-60M
56278	11-15	FORD	EXPLORER	30-60M
56279	15-18	CHEVY	CITY EXPRESS	30-60M
	13-19	NISSAN	NV200	30-60M
56280	14-17	MAZDA	6	30-60M
56281	14-20	INFINITI	QX60	30-60M
	13-20	NISSAN	PATHFINDER	30-60M
56282	16-18	TOYOTA	TACOMA	30-60M
56283	16-16	HYUNDAI	ELANTRA	30-60M
56284	16-20	HONDA	HR-V	30-60M
56285	17-18	VOLVO	S90	30-60M
	16-20	VOLVO	XC90	30-60M
56287	15-18	VOLVO	V60	30-60M
	15-18	VOLVO	V60 CROSS COUNTRY	30-60M
56288	12-17	BUICK	VERANO	30-60M
56291	19-21	HONDA	PASSPORT	30-60M
	16-21	HONDA	PILOT	30-60M
56292	15-18	FORD	EDGE	30-60M
56293	15-17	LAND RVR	RANGE ROVER SPORT	30-60M
56294	16-21	NISSAN	MAXIMA	30-60M
56295	12-16	KIA	RIO	30-60M
56296	18-20	MITSBSHI	ECLIPSE CROSS	30-60M
	14-18	MITSBSHI	OUTLANDER	30-60M
56297	15-19	LAND RVR	DISCOVERY SPORT	30-60M
56298	16-18	LINCOLN	MKX	30-60M
56299	16-17	HONDA	ACCORD	30-60M
56300	18-20	MAZDA	6	30-60M
	16-20	MAZDA	CX-3	30-60M
	16-20	MAZDA	MX-5 MIATA	30-60M
56301	16-17	HONDA	ACCORD	30-60M
56303	12-16	CHEVY	SONIC	30-60M
56306	11-19	FORD	EXPLORER	30-60M
	13-18	FORD	POLICE INTERCEPTOR	30-60M
56308	16-18	FIAT	500X	30-60M

Part #	Years	Make	Model	INS
56309	16-16	SCION	IM	30-60M
	19-19	TOYOTA	COROLLA	30-60M
	17-18	TOYOTA	COROLLA IM	30-60M
56310	16-16	MAZDA	CX-5	30-60M
56311	16-16	SCION	IA	30-60M
	17-18	TOYOTA	YARIS IA	30-60M
56313	16-20	CHEVY	MALIBU	30-60M
56314	11-20	KIA	OPTIMA	30-60M
56315	16-19	CHEVY	VOLT	30-60M
56316	17-18	HYUNDAI	ELANTRA	30-60M
56317	16-16	TOYOTA	PRIUS	30-60M
56318	16-18	CHEVY	CAMARO	30-60M
56319	16-19	CHEVY	CRUZE	30-60M
56320	17-18	FORD	ESCAPE	60-90M
56321	17-21	KIA	SPORTAGE	60-90M
56322	17-20	CHRYSLR	PACIFICA	30-60M
56323	16-18	CADILLAC	CT6	30-60M
56324	16-19	HONDA	CIVIC	30-60M
56325	17-20	CADILLAC	XT5	30-60M
	20-20	CADILLAC	XT6	30-60M
	19-21	CHEVY	BLAZER	30-60M
	17-20	GMC	ACADIA	30-60M
56326	17-20	CADILLAC	XT5	30-60M
	20-20	CADILLAC	XT6	30-60M
	19-21	CHEVY	BLAZER	30-60M
	17-20	GMC	ACADIA	30-60M
56327	15-20	FORD	TRANSIT-150	30-60M
	15-20	FORD	TRANSIT-250	30-60M
	15-20	FORD	TRANSIT-350	30-60M
	15-20	FORD	TRANSIT-350 HD	30-60M
56328	11-13	KIA	SORENTO	30-60M
56329	07-10	FORD	EDGE	30-60M
	08-12	FORD	ESCAPE	30-60M
	04-07	FORD	FREETSTAR	30-60M
	07-10	LINCOLN	MKX	30-60M
	08-11	MAZDA	TRIBUTE	30-60M
	05-11	MERCURY	MARINER	30-60M
56330	11-20	DODGE	JOURNEY	30-60M
56331	11-16	CHRYSLR	TOWN & COUNTRY	30-60M
	11-20	DODGE	GRAND CARAVAN	30-60M
56332	13-18	HYUNDAI	SANTA FE	30-60M
	19-19	HYUNDAI	SANTA FE XL	30-60M
	07-12	HYUNDAI	VERACRUZ	30-60M
	15-21	KIA	SEDONA	30-60M
	07-20	KIA	SORENTO	30-60M
56333	08-10	CHRYSLR	TOWN & COUNTRY	30-60M
	08-12	DODGE	CALIBER	30-60M
	11-13	DODGE	DURANGO	30-60M
	08-10	DODGE	GRAND CARAVAN	30-60M
	08-17	JEEP	PATRIOT	30-60M
56334	07-12	DODGE	NITRO	30-60M
	08-12	JEEP	LIBERTY	30-60M
56335	13-16	FORD	ESCAPE	30-60M
56336	14-20	DODGE	DURANGO	30-60M
56338	16-20	MAZDA	CX-9	30-60M
56339	16-20	NISSAN	ALTIMA	30-60M
56340	05-09	BUICK	LACROSSE	30-60M
56341	01-05	HONDA	CIVIC	30-60M
56342	11-17	NISSAN	QUEST	30-60M
56343	09-19	FORD	FLEX	30-60M
56344	11-17	JEEP	COMPASS	30-60M
56345	05-07	FORD	ESCAPE	30-60M
	05-06	MAZDA	TRIBUTE	30-60M
56346	07-12	HYUNDAI	SANTA FE	30-60M
56347	07-09	HYUNDAI	ENTOURAGE	30-60M
	06-14	KIA	SEDONA	30-60M
56348	10-18	HYUNDAI	TUCSON	30-60M
56349	16-20	TOYOTA	TACOMA	30-60M
56350	13-18	TOYOTA	AVALON	30-60M
	13-18	TOYOTA	RAV4	30-60M
56351	13-20	FORD	FUSION	30-60M
56352	16-18	FIAT	500X	30-60M
56353	16-19	TOYOTA	PRIUS	30-60M
56354	17-19	CHEVY	CRUZE	30-60M
56355	10-17	VOLVO	XC60	30-60M
56356	17-19	BUICK	LACROSSE	30-60M
56357	13-13	INFINITI	JX35	30-60M
	14-20	INFINITI	QX60	30-60M
	13-17	NISSAN	PATHFINDER	30-60M

Part #	Years	Make	Model	INS
56359	17-20	LINCOLN	CONTINENTAL	30-60M
56360	17-17	VOLKSWGN	GOLF ALLTRACK	30-60M
56361	16-18	BUICK	ENVISION	30-60M
56362	16-17	HYUNDAI	SONATA	30-60M
56363	17-20	BUICK	ENCORE	30-60M
56364	16-20	BUICK	ENVISION	30-60M
56365	09-11	HONDA	PILOT	30-60M
	17-20	HONDA	RIDGELINE	30-60M
56366	09-11	HONDA	PILOT	30-60M
	17-20	HONDA	RIDGELINE	30-60M
56367	17-20	SUBARU	IMPREZA	30-60M
56368	12-16	SUBARU	IMPREZA	30-60M
56369	17-21	JEEP	COMPASS	30-60M
56370	17-20	HONDA	CR-V	30-60M
56371	17-20	TOYOTA	PRIUS PRIME	30-60M
56372	17-20	CHEVY	SONIC	30-60M
56374	17-17	VOLKSWGN	GOLF R	30-60M
56374	12-15	VOLKSWGN	PASSAT	30-60M
56375	18-18	CHEVY	EQUINOX	30-60M
	18-18	GMC	TERRAIN	30-60M
56376	17-20	KIA	NIRO	30-60M
56377	17-20	MAZDA	CX-5	30-60M
56378	11-17	HONDA	ODYSSEY	30-60M
56379	17-19	INFINITI	QX30	30-60M
56380	12-19	VOLKSWGN	BETLE	30-60M
56381	17-20	HYUNDAI	IONIQ	30-60M
56382	18-20	HONDA	ODYSSEY	30-60M
56383	18-20	VOLKSWGN	ATLAS	30-60M
56384	18-20	TOYOTA	C-HR	30-60M
56385	15-20	TOYOTA	YARIS	30-60M
56386	08-16	VOLVO	XC70	30-60M
56387	16-20	CHEVY	MALIBU	30-60M
56388	16-18	VOLKSWGN	PASSAT	30-60M
56389	18-20	BUICK	REGAL SPORTBACK	30-60M
	18-20	BUICK	REGAL TOURX	30-60M
56390	18-20	HYUNDAI	SONATA	30-60M
56391	17-17	VOLKSWGN	GOLF ALLTRACK	30-60M
56393	18-20	BUICK	ENCLAVE	30-60M
	18-20	CHEVY	TRAVERSE	30-60M
56394	18-20	BUICK	ENCLAVE	30-60M
	18-20	CHEVY	TRAVERSE	30-60M
56395	15-20	HONDA	FIT	30-60M
56396	16-20	HONDA	CIVIC	30-60M
56397	17-19	NISSAN	ROGUE SPORT	30-60M
56398	08-10	VOLVO	V70	30-60M
56399	17-20	CHRYSLR	PACIFICA	30-60M
	20-20	CHRYSLR	VOYAGER	30-60M
56400	14-20	NISSAN	VERSA	30-60M
56401	18-20	NISSAN	PATHFINDER	30-60M
56402	18-20	HONDA	ACCORD	30-60M
56403	18-20	VOLKSWGN	TIGUAN	30-60M
56404	13-17	AUDI	Q5	30-60M
	14-17	AUDI	SQ5	30-60M
56405	18-20	VOLKSWGN	GTI	30-60M
56406	19-20	JEEP	CHEROKEE	30-60M
56407	20-21	JEEP	GLADIATOR	30-60M
	18-21	JEEP	WRANGLER	30-60M
56408	14-18	KIA	FORTE5	--
56409	18-20	HYUNDAI	KONA	30-60M
56410	14-18	KIA	FORTE	30-60M
	14-16	KIA	FORTE KOUP	30-60M
56412	18-20	MITSBHSI	OUTLANDER PHEV	30-60M
56413	15-20	FORD	F-150	30-60M
56416	19-20	TOYOTA	AVALON	30-60M
56417	18-20	TOYOTA	CAMRY	30-60M
56418	18-20	NISSAN	KICKS	--
56419	19-20	CHEVY	TRAX	30-60M
56420	20-20	HYUNDAI	PALISADE	30-60M
	19-20	HYUNDAI	SANTA FE	30-60M
	20-20	KIA	TELLURIDE	30-60M
56421	19-21	HONDA	PASSPORT	30-60M
	16-21	HONDA	PILOT	30-60M
56422	12-17	VOLKSWGN	TIGUAN	30-60M
56423	98-98	MERCURY	VILLAGER	30-60M
	98-03	NISSAN	FRONTIER	30-60M
	98-02	NISSAN	QUEST	30-60M
56425	06-07	NISSAN	MURANO	30-60M
56426	14-20	JEEP	GRAND CHEROKEE	30-60M
56427	19-20	CADILLAC	XT4	30-60M

Part #	Years	Make	Model	INS
56429	18-20	CHEVY	EQUINOX	30-60M
	18-20	GMC	TERRAIN	30-60M
56430	13-19	LEXUS	ES350	30-60M
56431	19-20	FORD	RANGER	30-60M
56432	19-19	FORD	ESCAPE	60-90M
56434	19-20	TOYOTA	RAV4	60-90M
56435	19-20	MAZDA	3	30-60M
56436	19-20	FORD	EDGE	30-60M
56437	19-20	FORD	EDGE	30-60M
56438	01-02	TOYOTA	TUNDRA	30-60M
56439	19-20	TOYOTA	PRIUS AWD-E	30-60M
56440	16-20	VOLKSWGN	PASSAT	30-60M
56442	07-08	HYUNDAI	ENTOURAGE	30-60M
	19-20	HYUNDAI	TUCSON	30-60M
	19-19	HYUNDAI	VELOSTER	30-60M
	06-14	KIA	SEDONA	30-60M
	21-21	KIA	SELTO	30-60M
	10-20	KIA	SOUL	30-60M
56443	20-20	FORD	F-250 SUPER DUTY	30-60M
	20-20	FORD	F-350 SUPER DUTY	30-60M
	20-20	FORD	F-450 SUPER DUTY	30-60M
56444	20-20	SUBARU	LEGACY	30-60M
56446	19-20	LINCOLN	NAUTILUS	30-60M
56448	20-20	FORD	ESCAPE	30-60M
56450	20-20	MAZDA	CX-30	30-60M
56451	20-20	HYUNDAI	VENUE	60-90M
56452	20-20	TOYOTA	HIGHLANDER	60-90M
56453	20-20	LINCOLN	AVIATOR	30-60M
56454	20-20	TOYOTA	COROLLA	30-60M
56510	04-12	CHEVY	COLORADO	30-60M
	04-12	GMC	CANYON	30-60M
	06-06	ISUZU	I-280	30-60M
	07-08	ISUZU	I-290	30-60M
	06-06	ISUZU	I-350	30-60M
	07-08	ISUZU	I-370	30-60M
56513	08-12	TOYOTA	HILUX	30-60M
	93-98	TOYOTA	T100	30-60M
	05-15	TOYOTA	TACOMA	30-60M
56594	10-17	CHEVY	EQUINOX	30-60M
	10-17	GMC	TERRAIN	30-60M
56673	04-07	FORD	FREESTAR	30-60M
56673	04-07	MERCURY	MONTEREY	30-60M
57000	05-12	NISSAN	ARMADA	30-60M
	04-15	NISSAN	TITAN	30-60M
57300	07-08	CHRYSLR	ASPEN	30-60M
	04-08	CHRYSLR	PACIFICA	30-60M
	00-09	DODGE	DAKOTA	30-60M
	00-08	DODGE	DURANGO	30-60M
	00-08	DODGE	RAM 1500	30-60M
	01-03	DODGE	RAM 1500 VAN	30-60M
	00-09	DODGE	RAM 2500	30-60M
	01-03	DODGE	RAM 2500 VAN	30-60M
	00-09	DODGE	RAM 3500	30-60M
	01-03	DODGE	RAM 3500 VAN	30-60M
	03-09	DODGE	SPRINTER 2500	30-60M
	03-09	DODGE	SPRINTER 3500	30-60M
	03-09	FRGHTLNR	SPRINTER 2500	30-60M
	03-09	FRGHTLNR	SPRINTER 3500	30-60M
	06-10	JEEP	COMMANDER	30-60M
	00-10	JEEP	GRAND CHEROKEE	30-60M
	05-08	JEEP	LIBERTY	30-60M
	06-09	MITSBHSI	RAIDER	30-60M



LIMITED LIFETIME WARRANTY

CURT MANUFACTURING, LLC ("CURT") provides limited lifetime warranty coverage against defects in factory workmanship and materials for CURT® products ("Products") sold by authorized CURT dealers for use by retail (end use) consumers. This Limited Warranty is provided only to the original Product consumer, and applies only to the original installation. This Limited Warranty is not transferable and does not extend or apply to anyone else. For consumers in the U.S.: this Limited Warranty gives you specific legal rights; you also may have other rights, which vary from state to state.

This Limited Warranty is the sole and exclusive warranty provided by CURT, and all other warranties and conditions are excluded and disclaimed. **UNDER THE LAW OF CERTAIN STATES, THERE MAY BE NO IMPLIED CONDITIONS OR WARRANTIES FROM CURT APPLICABLE TO YOUR PRODUCT, AND ALL IMPLIED CONDITIONS OR WARRANTIES (INCLUDING ANY WARRANTY OF MERCHANTABILITY OR FITNESS FOR A PARTICULAR PURPOSE) ARE EXCLUDED AND DISCLAIMED WHERE ALLOWED BY LAW.** If implied warranties are imposed under any applicable state law, all such implied warranties are limited to the duration of the applicable provisions of this Limited Warranty. Some states do not allow limitations on how long an implied warranty lasts, so the above limitation may not apply to you.

COVERED PRODUCTS AND LIMITATIONS

CURT provides the following Limited Warranty coverage:

Product	Workmanship & Materials	Components & Parts	Finishings & Coatings
Hitches	Lifetime	One-year	One-year
Brake controllers	Lifetime	One-year	One-year
Electrical and wiring	One-year	One-year	One-year
Other accessories	Lifetime	One-year	One-year

Each of the warranty coverage periods runs from the date of purchase of the Product (proof of purchase is required) and applies only to warranted defects that first occur and are reported to CURT within the applicable warranty period. CURT retains the right to determine to its reasonable satisfaction whether any claimed defect is covered by this Limited Warranty.

Certain items are excluded from Limited Warranty coverage by CURT, and this **Limited Warranty coverage does not apply to:**

- Wear and tear from normal use, including damage from road debris
- Improper product selection, application, installation or maintenance

- Modifications, including the attachment of other hardware or components
- Misuse, abuse, overloading, improper trailering or hauling, accident
- Corrosion or damage due to environmental conditions

REMEDIES UNDER THIS LIMITED WARRANTY

If a defect covered by this warranty occurs, CURT will repair or replace the Product, or refund the purchase price, in its sole discretion. This "repair, replacement or refund" remedy is the **sole and exclusive remedy** under this Limited Warranty. CURT has **no responsibility or liability for any incidental or consequential damages**, such as loss of use of vehicles or trailers, towing charges, storage charges, tire damage, labor and service charges for removing or reinstalling products, loss of or damage to personal property, or interest or finance charges, all of which are specifically **excluded and disclaimed** from this Limited Warranty. Some states do not allow the exclusion or limitation of incidental or consequential damages, so the above limitation or exclusion may not apply to you.

RESPONSIBILITY OF PURCHASER

The Purchaser must have proof of purchase to obtain service under this Limited Warranty. Contact CURT for a Returned Goods Authorization (RGA) and return instructions; CURT will not accept Products unless an RGA has been issued. The Purchaser must deliver the Product to CURT or an authorized CURT dealer along with the RGA number and proof of purchase.

The CURT Limited Warranty policy in effect on the date you purchased your Product determines the applicable warranty coverage, and subsequent or prior CURT warranties are not applicable to your Product. The terms of this Limited Warranty cannot be changed or modified, except by a written agreement signed by an officer of CURT. CURT reserves the right to improve its products through changes in design or materials without being obligated to the owners of the Products of the same or similar models.

Contact information:
CURT Headquarters
6208 Industrial Drive
Eau Claire, WI 54701
877.287.8634



**TESTED.
PROVEN.
SAFE.**

CURT products are thoroughly tested and proven safe to give your customers confidence for the road ahead. That is why we continue to manufacture our custom-fit trailer hitches in America and why we maintain dedicated testing and engineering teams for continuous improvement.

Our goal isn't just to produce a stronger hitch or a more dependable wiring harness. We want to give our consumers the means to enjoy their lifestyle. We want to give hardworking contractors a solid foundation to grow their business, diehard sportsmen a shot at that next big adventure and ordinary families an unforgettable vacation.

Whether they're towing 30,000 pounds or packing up for a weekend getaway, CURT offers your customers the freedom to pursue their passion and the peace of mind to enjoy every mile of it.



**TO SEE OUR WARRANTY,
VISIT CURTMFG.COM**



CONNECT WITH US



PHONE
877.287.8634



WEB
CURTMFG.COM

LOCATIONS

HEADQUARTERS

6208 INDUSTRIAL DRIVE
EAU CLAIRE, WI 54701

ATLANTA

110 NORTHPOINT PARKWAY
SUITE 200
ACWORTH, GA 30102

DALLAS

2611 REGENT BOULEVARD
SUITE 300
IRVING, TX 75261

DETROIT

30779 OAK CREEK DRIVE
WIXOM, MI 48393

EDMONTON

#27, 12632 184TH STREET N.W.
EDMONTON, ALBERTA T5V 1T4

HOUSTON

4921 TIMBER LANE
ROSENBERG, TX 77471

PHOENIX

405 NORTH 75TH AVENUE
SUITE 190, BUILDING #3
PHOENIX, AZ 85043

SEATTLE

14512 32ND STREET EAST
SUITE 300
SUMNER, WA 98390

TORONTO

317 RUTHERFORD ROAD SOUTH
UNIT A
BRAMPTON, ON L6W 3R5

FOLLOW US ON SOCIAL MEDIA

