

Auwe-co®

PRODUCTS

Over 23,000 Items Available

DUKES A&W ENTERPRISES
800-344-8243 dukesaw.com



**The Encyclopedia of the
Automotive Body Hardware Industry**

Discover Auveco



My Account | Contact Us | Español | Français

Advanced Search

- HOME
- OEM MFG
- PRODUCTS
- ORDER EXPRESS
- OEM/COMPETITIVE INTERCHANGE
- TECHNICAL INFORMATION
- MORE

Body Hardware Master Program
"The Complete Body Shop Set-up"

[Learn More](#)

The **Auveco** Virtual Catalog

[CLICK TO VIEW](#)

FasTrack Web
A comprehensive cost recovery system for your Body Shop Customers
Two month free trial offer!

[LEARN MORE](#)

STAY UP TO DATE WITH AUVECO'S **HOT** NEW ITEMS BULLETINS

[CLICK HERE](#)

Auveco has recently revamped their entire website. They've made a user friendly experience for you to easily navigate their over 22,000 parts. The ordering platform has been hugely improved to ensure accuracy and a quick order turn around.

Ordering made easy

Online
DUKESAW.com

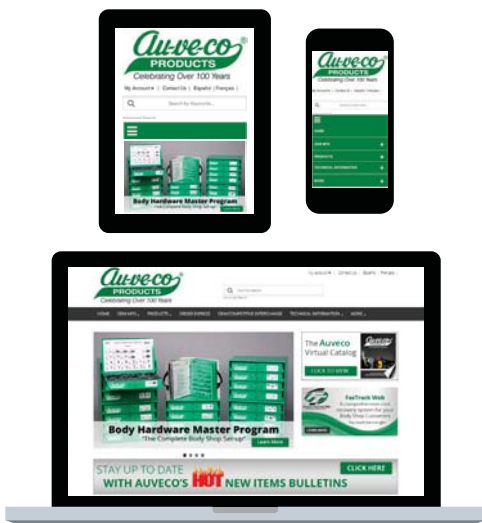

By Phone
800-344-8243



By Email
esales@dukesaw.com

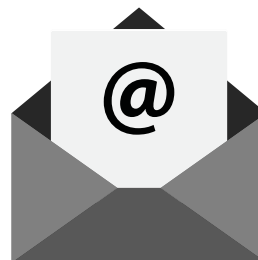

“Then, Now, and Serving you into the Future”

For over a 100 years, Auto-Vehicle Parts LLC (Auveco) has been manufacturing and distributing specialty automotive and industrial fasteners.

Originally, Auveco manufactured trim parts and accessories for horse drawn carriages. After four generations, Auveco is still family owned.

We are the **World's Leader** in servicing customers' needs for Automotive Body Hardware and Specialty Fasteners through our worldwide distributors.

We market our products through traditional channels of distribution, selling only to authorized Distributors and O.E. Manufacturers. We provide three types of packaging: small Unit Package quantities, a One-Price Package retail program for PBE Jobber stores and Bulk quantities for the Expediter/Distributor and O.E. Manufacturer.

With over 22,000 items our catalog is regarded as the *Encyclopedia of the Automotive Body Hardware Industry*.

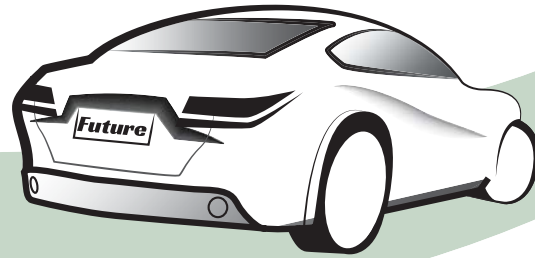

Technology

We are continually upgrading to the latest technology including our warehouse fulfillment system to achieve accuracy and order turn around. Most orders are shipped within 2 hours with a 98.6% fill rate.

New e-commerce site:

- Multi-device user experience, as well as, multiple language options
- Improved category search with new drill down search capability
- New OEM and competitive item search capabilities
- Updated and thorough product information and images
- Revitalized features for tracking and placing orders and requesting quotes
- Up to date stock availability

EDI capabilities:

- Trading Purchase Order, PO Acknowledgment, Advanced Shipping Notices (ASN) and Invoice documents with a growing group of trading partners

FasTrack Web: *Internet based Cost Recovery Software that allows collision centers to efficiently invoice all clips and fasteners used during a repair.*

- Recently updated interface with new modern look
- CCC® Estimating integration allowing users to import FasTrack invoices to their system
- New tutorial videos demonstrating how to effectively use particular sections of FasTrack
- OEM Crossover updated daily with newest Auveco items
- Capability to enter OEM numbers directly to an invoice
- Ability to add Kits such as core support, truck bed side, front bumper, door side, etc.

Complete Customer Satisfaction with our Products and Services

To maintain a level of excellence we go beyond a dedication to product availability. We continually add to our product line on a biweekly basis and insist upon a dedication to quality of services at all levels throughout the company.

Our customer service and technical staff is fully trained to make sure that we can answer all your questions regarding product availability, pricing, delivery and technical information. We can even supply detailed, custom sales analysis to guide customers in the selection of new products that ensures their sales growth.

Into the Future

Our goal of further enhancing customer satisfaction is limited only by our imagination and your needs. Let us know what we can do to better serve you. As we continually strive to service our customers across the country and beyond, it's no wonder that when people around the world think of Automotive Body Hardware & Specialty Fasteners, they think of Auveco.

World's Largest Body Hardware and Specialty Fastener Selection

From Manufacturing to Distributing



Shipping





Unit Packaging



Bulk Packaging



AuvecoPak Retail Package Program

One Price Per Pak



448

of the
fastest moving,
most popular
automotive
body hardware
and
specialty fasteners



The AP448S (Starter Merchandiser) consists of one package each of the 448 part numbers.

The AP448L (Large Assortment) includes two packages each of the 224 most popular items and one package each of the other 224 part numbers for a total of 672 packages.

AuvecoPak packages feature, contemporary graphics with all the necessary application and descriptive information in trilingual verbiage (English, Spanish and French-Canadian).

Re-ordering is a breeze, the AuvecoPak part number and UPC-A bar code are on the panel back-up boards beneath each hook. Restocking the merchandiser is also quick and easy with the AuvecoPak packages' locator codes identifying their specific location on the panels.

*For more detailed information about the AuvecoPak Retail Package Program,
refer to pages 317 to 323*



FasTrack Web

A Body Shop Cost Recovery System

FasTrack is an easy-to-use, web base application designed to assist body shops and dealerships in recovering the cost of the body repair clips and fasteners used in daily collision repairs.

The cost of fasteners used in collision damage repair is often an expense that is not recovered by shops. Insurance companies consider these items “a cost of doing business” and are either reluctant or refuse to pay claims for these items unless they are presented with an itemized invoice detailing the cost of these items.

FasTrack Web makes it fast and easy to manage these parts and turn them into a source of additional income for your shop.

Features:

- Integration with CCC® Estimating
 - CCC ONE is the largest estimating service in the U.S.
 - Enables end users to send invoices seamlessly and easily to CCC's estimating system
- The ONLY supplemental invoicing system on the market using the OEM pricing structure that is widely accepted and requested by insurance companies across the country
- Extensive data base of over 10,000 collision repair fasteners by Auveco
- Distributors can add multiple items. As well as, their own unique part numbering system.
- Shop Items give the body shop the ability to also add their own items
- Kit Management allows the distributor or the shop to build their own specific repair kits, as well as, pre-designed kits
- Labeling functions allow for printing individual bar code labels and new drawer lid labels
- Barcode scanning can be done with our app using any smart phone or with our wedge scanner
- Reporting and Inventory Management allows the distributor to gather information on product usage at the shop level for all supported shops
- Body Shops can now sign up directly by filling out order form and adding an authorized Auveco distributor name
- No annual updates, as all data resides on our Internet server and is always up to date
- Can be accessed from any computer with Internet access
- Site protected by Verisign Internet Security.

Auveco's FasTrack Web is only offered through authorized Auto-Vehicle Parts LLC distributors.
For a distributor in your area call customer service at 1-800-354-9816.

For more information or to start your FREE two month trial visit www.auveco.com or call 1-800-354-9816 x103



Over **500**
Pre-packaged
Assortments

Custom Packaging
Capabilities



“428” Display Boards



Over 428 of the most popular body hardware and fastener items are shrink-wrapped onto seven different boards. Each board contains product groups, body shops are familiar with and use often.

We recommend every distributor sell these convenient display boards to body shops.

The back of each board contains each part number, unit package quantity, OEM number and size specification. The backs are protected by a clear plastic liner.

Binder with Display Boards, DB-428-9



Product Numbers and Descriptions

DB-420-0

Display Board Binder:
Holds up to 8 boards

DB-428-1

Retainers and
Push-type Retainers

DB-428-2

Push-type Retainers

DB-428-3

Tapping Screws

DB-428-4

Body Bolts and Nuts

DB-428-5

Speed, Nylon & Thread Cutting
Nuts. Push-on &
Pushnut Bolt Retainers

DB-428-6

Specialty Rivets, Door Hinge Pins &
Bushings, Trim Clips and Fasteners

DB-428-7

Moulding & Wire Loom Clips,
Vacuum Caps, Shims, Plastic Plugs
and Cable Straps

DB-428-8

Assortment of boards
DB-428-1 through DB-428-7

DB-428-9

Binder and boards DB-428-1
through DB-428-7

Auveco Green Catalog

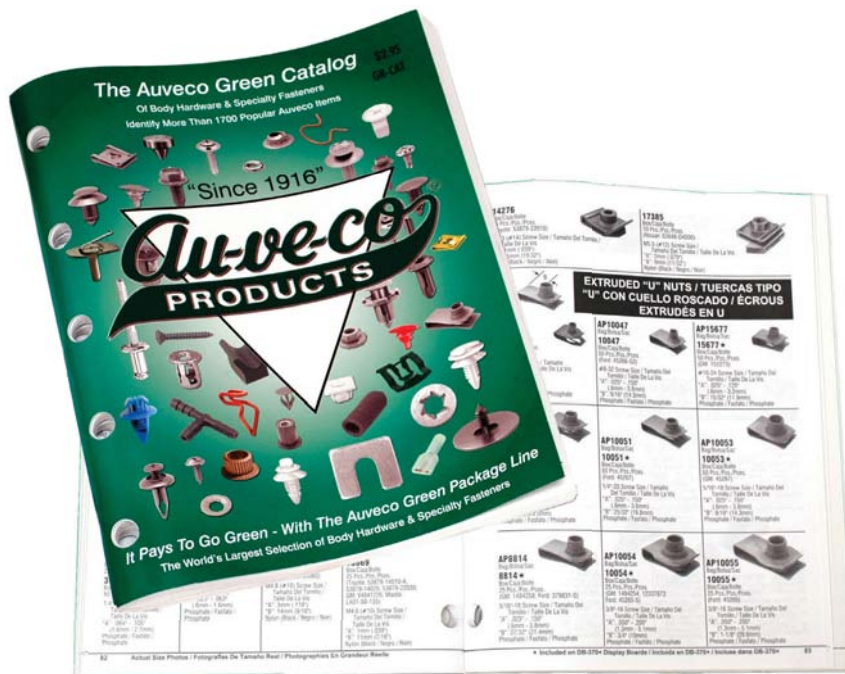

1700
of the most
popular
part numbers
a must have for all body shops

For your convenience we've created a condensed version of our catalog. The Auveco Green Catalog contains over 1,700 of the most popular Auveco part numbers. Parts are divided by product group into 45 different sections. The clean, concise format makes it quick and easy to find the right part.

Features:

- Trilingual verbiage: English, Spanish and French-Canadian
- Actual size images of products
- O.E.M. numbers
- Part specifications, dimensions, colors and plating information
- Includes AuvecoPak part numbers for customers that have the AuvecoPak Retail Merchandiser
- Auveco Display Boards items are identified with a ★ symbol.

NAVIGATING THE CATALOG

Quick Index: *A pictorial index*

- Picture examples to help you locate the pages of similar parts
- Section numbers correspond to the section numbers printed in the upper outside corner of each catalog page.

Alphabetical Index

- Allows you to check if we carry a specific product line.
- Popular categories are in bold type.

Numerical Index

- Gives you the capability to look up a part based on the Auveco part number

Helpful Tips

- All parts are displayed as actual size, unless labeled “not actual size” or is a picture accompanying a chart. As actual size you will be able to set a part on top of the picture to positively identify it.

- We have included Specification Charts to assist you in the identification of various types of fasteners.

Charts can be found on the following pages:

- Body Bolts- Pages: 88 & 121-122
- Special Tapping Screws- Pages: 91-94 & 128-130
- License Plate Screws- Pages: 105-106
- Retainers- Pages: 475-489
- Push-Type Retainers- Pages: 534-545

Charts list the pertinent dimensions, plating and color information, as well as, the page number on which the actual size picture and application information is shown for each item.

- At the back of the catalog are two O.E.M. part number to Auveco part number Cross References.

One of these interchanges is broken down by O.E. manufacturer i.e., General Motors, Ford, etc.

The other interchange combines all O.E.M. numbers together and is sequenced strictly in alphanumeric order regardless of the manufacturer.

New Items Pages 44-68

Screws Pages 69-115

Metric Items Pages 116-151

Nuts Pages 152-179

Washers, Shims & Retaining Rings Pages 180-190

Springs, Pins, Clips, Plug Buttons, Caps & Connectors Pages 190-201

Air Line Couplings & Accessories, Tubing and Hose Pages 202-203

Electrical Accessories Pages 204-270

Wire Loom & Clips and Cable & Harness Straps Pages 270-274

Oil & Transmission Drain Plugs & Gaskets and Grease Fittings & Accessories and Brass Fittings Pages 275-295

Rivets & Accessories and Drills & Sets Pages 293-316

Assortments, Cabinets, Bins & Racks Pages 317-385

O-Rings, Grommeting, Tire Valves, Weatherstrip, Rubber Bumpers & Grommets, Caps and Seals & Channels Pages 386-399

Glass Shop Supplies and Horns Pages 400-408

Trimming Sundries & Fasteners and Push-Type Retainers Pages 409-546

Domestic Car Clips & Fasteners Pages 547-634

Key Blanks & Accessories Pages 634-641

Import Car Clips & Fasteners Pages 642-823

Universal Type Moulding Fasteners Pages 824-825

Ball Joint Assemblies, Yoke Ends and Clamps & Accessories Pages 826-835

Engine Manifold Repair Kit, Body Sealer and Epoxy Repair Kits Pages 836-838

Miscellaneous Items Pages 839-846

Tools Pages 847-856

QUICK INDEX

Photos not actual size

Section 1 Pages 69-76

Tapping & Wood Screws



Section 5 Pages 105-113

License Plate Screws & Fasteners



Section 2 Pages 77-85

Cap, Machine & Set Screws, Carriage, Frame & Stove Bolts and Stainless Steel Fasteners



Section 6 Pages 114-115

Cylinder Head & Manifold Studs



Section 3 Pages 86-90

Bumper & Body Bolts



Section 7 Pages 116-151

Metric Items



Section 4 Pages 91-104

Special Tapping Screws



Section 8 Pages 152-158

Standard, Special and Thread Cutting Nuts and Wheel Studs, Bolts & Nuts



QUICK INDEX

Photos not actual size

Section 9 Pages 159-179

Nutsert® & Thread Repair Inserts. Teenut®, Jack Nut® & Well Nut®. Tubular, Flat, U, & J-Nuts



Section 12 Pages 204-274

Electrical Accessories, Wire Loom & Clips, Cable Ties and Bulbs



Section 10 Pages 180-196

Washers, Shims, Retaining Rings, Springs, Pins, Yoke Ends, Spring Pins, Plugs and Straight & Woodruff Keys



Section 13 Pages 275-292

Oil Drain Plugs & Gaskets, Grease Fittings & Accessories and Brass Fittings



Section 11 Pages 197-203

Caps, Connectors, Airline Couplings & Accessories and Tubing & Hose

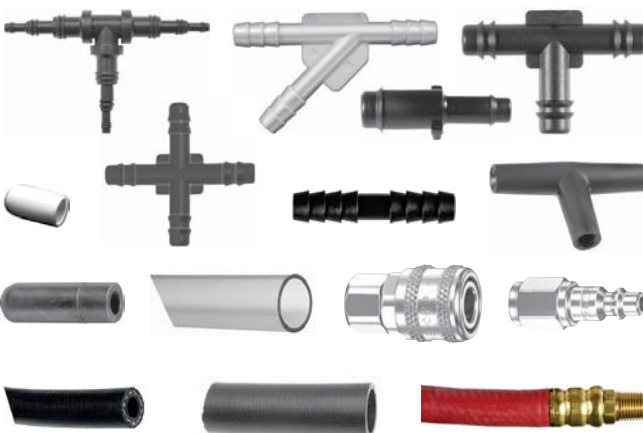

Section 14 Pages 293-316

Rivets & Tools and Drill Bits

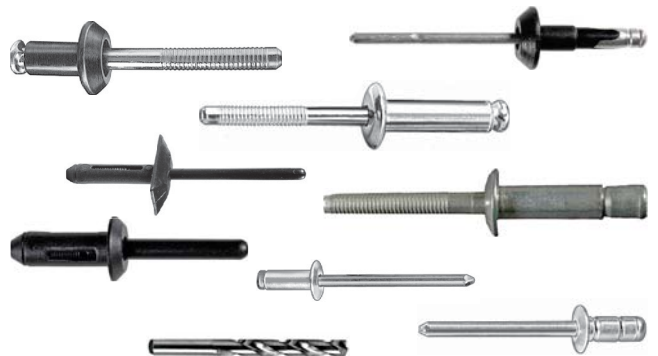

QUICK INDEX

Photos not actual size

Section 15 Pages 317-385

AuvecoPaks, Assortments, Cabinets, Drawers and Special Racks



Section 16 Pages 386-399

O-Rings, Grommets, Tire Valves, Weatherstrip, Rubber Bumpers & Caps, Hold Down Straps and Glass Setting Channels

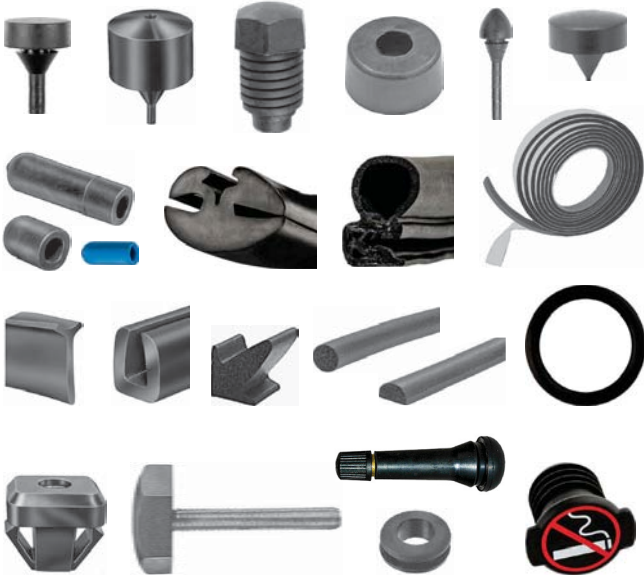

Section 17 Pages 400-405

Glass Shop Supplies



Section 18 Pages 406-408

Window Lift Motor Gears, Air Conditioning Motors and Horns



Section 19 Pages 409-546

Trimming Sundries & Fasteners, Snap & Curtain Fasteners, Push-Type Retainers and Truck Seat Springs



QUICK INDEX

Photos not actual size

Section 20 Pages 547-634

GM, Ford, Chrysler & AMC Clips and Fasteners



Section 22 Pages 642-823

Import Clips and Fasteners



Section 21 Pages 635-641

Key Blanks, Locks and Locks Hardware & Accessories



Section 23 Pages 824-825

Universal Moulding Fasteners



Section 24 Pages 826-830

Ball Joint Assemblies

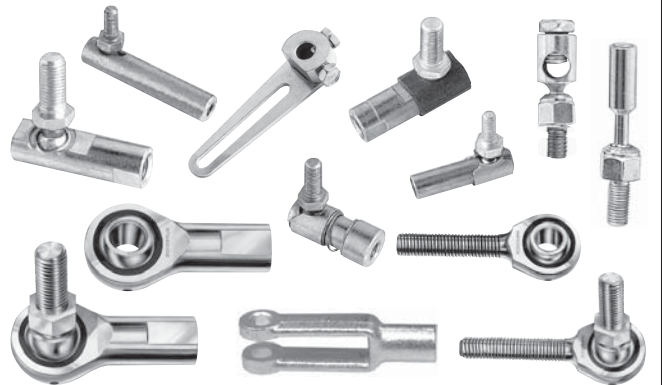

QUICK INDEX

Photos not actual size

Section 25 Pages 831-835

Hose & Tubing Clamps



Section 26 Pages 836-838

Manifold Repair Kit and Body, Seam-n-Joint & Epoxy Sealer. FixitQuik Epoxy Putty



Section 27 Pages 839-846

Miscellaneous Items



Section 28 Pages 847-856

Tools, Plain White Boxes and Lubrication Items



ALPHABETICAL INDEX

A

Abrasives	67-68
Acorn Nuts	85, 140, 154
Acura Clips & Fasteners	642-649
Adhesive Weatherstrip	390-392
Aerosol Can Caddy	336
Air Conditioning O-Rings	388-389
Air Hose	203
Air Line Couplings & Accs.	201-202
Alignment Shims	184
Anchor Shackles	843
Anchors	842-843
Anti-Corrosion Protectant	230
Assortments (Green Pages)	317-385
Audi Clips & Fasteners	808-821
Auto Bulbs	258-267
Auveco Body Sealer	837
Auveco "Fix-Kits"	343-363
Auveco Flex & Rigid Sealer	837
AuvecoPak	317-323
Avex® Blind Rivets	299

B

Ball Joint Assemblies	826-830
Barrel Nuts	143, 169-170
Battery:	
Cable	227
Hold Down Bolts	846
Terminals & Bolts	224-229
Tools	229-230
Belt Weatherstrips	397
Bin Labels	337
Bins	335-336
Bits:	
Drill	316
Torx® (Drivers & Inserts)	70, 131, 850
Blades, Razor	848
Blind Rivets	293-294, 297-300
Blow Gun Accs.	202
BMW Clips & Fasteners	650-657
Body Bolts:	
Metric	120-128
U.S.	88-90
Body Hardware Master Asst.	324-331
Body Sealer	837
Body Shop Bin Assortments	338
Bolt Extractor Kit	852
Bolt Retainers:	
Metric	141
U.S.	154
Bolts:	
Battery	227-229
Battery Hold Down	846
Body:	
Metric	120-128
U.S.	88-90
Bumper	86-87, 137
Carriage	79
Grade 5	81
Grade 8	82
Hex Flange Frame	80
Hex Flange Serrated (Metric)	120
Hex Head Sems Split	
Wave Washer (Metric)	120
License Plate	105-111

Bolts continued:

Spin Lock	77
Stainless Steel	84
Stove	77
Boxes, Plain White	852
Brackets, Rear View Mirror	404
Brass Fittings	287-292
Brass Grommets	411
Brass Nuts	152
Brushes	
(Acid, Chip, Dope & Scratch)	841-842
Bulbs, Light	258-267, 841
Bulbs, Miniature	258-259
Bumper Bolts	86-87, 137
Bumpers, Rubber	394-396
Buttons:	
Plug	195-196
Trim	410
Bushings:	
All-Fit Adjustable	843
Door Hinge	592-593, 615, 632
Nylon Spacer (Stand-Offs)	843
Standard Insulating	843

C

Cabinets & Accessories	331-336, 352
Cable:	
Battery	227
Tailgate	588
Tie Mounts	274
Tie Tool	274
Ties	272-274
Cage Nuts	142, 154, 174
Can Caddy	336
Canvas & Curtain Fasteners	414-415
Cap Screws:	
Metric	117-119
Socket Head, Metric	119
Stainless Steel	84
U.S. (Gr. 5 & Gr. 8)	81-82
Caps, Rubber & Vinyl Vacuum	197, 399
Carriage Bolts	79
Caulking Guns	856
"Christmas Tree" Retainers	415-489
Chrysler Clips & Fasteners	616-633
Circuit Breakers	230
Circuit Tester	224-225
Clevis Ends	194, 830
Clevis Pins	193
Clamps:	
Hose	831-834
Tubing	270, 834-835
Clip Removal Tool	848
Clips:	
Acura	642-649
AMC	634
Audi	808-821
BMW	650-657
Chrysler	616-633
Fiat	657-658
Ford	594-616
General Motors	547-593
Honda	658-681
Hyundai	682-688
Infiniti	689-693

Clips continued:

Isuzu	694
Jaguar	695
Kia	694-700
Land Rover	700-702
Lexus	703-715
Mazda	715-725
Mercedes-Benz	726-733
Mini-Cooper	733-734
Mitsubishi	735-739
Nissan	739-757
Opel	757
Peugeot & Citroen	758-763
Renault & Dacia	764-770
Saab	770
SEAT & Skoda	808-821
Subaru	770-776
Suzuki	777
Toyota	778-808
Volkswagen	808-821
Volvo	822-823
Universal	823
Window Reveal Moulding	401-403
Wire Loom	270-271
Closed-End Connectors & Terminals	211
Co-ax Cable Clips	270
Compression Battery Terminals	228
Compression Springs	191
Conditioning Disc	68
Connectors:	
Air Line	201-202
Electrical	204-213, 224, 236-257
Nylon Vacuum	197-201
Polyethylene	201
Rubber	201
Trailer	257
Twist-Type Wire	224
Copper Washers:	
Metric	146
U.S.	181
Cord, Sponge Rubber	394
Cotter Pins:	
Metric	149
Stainless Steel	84
U.S.	193
Covers & Bases, Screw	70, 412
Crimping Tools (Electrical)	222-223
Curtain Fasteners	414-415
Cutoff Wheels & Mandrels	854
Cylinder Head Studs:	
Metric	115, 138
U.S.	150
D	
Damper Control (Arm)	828
Dampening Pads	
(Trunk/Vibration/Sound)	840
Defroster Repair Products	44-45
Disc:	
Mini Grinding	68
Surface Conditioning	68
Strip-Brite	68
Twist-to-lock Holders	68
Display Boards	8
Door Handle Clips	400-401

ALPHABETICAL INDEX

Door Hinge:		Fuel Line Clips	610-611	Hog Rings	410
Bushings	592-593, 615, 632	Fuel Line Hose	203	Hold Down Straps	399
Hinge Pins	591-592, 615, 633	Fuse Tap	208, 234	Hole Punch	856
Hinge Pin &		Fuses, Fuseholders & Accs.	232-235	Hollow Wall Anchors	842
Bushing Repair Kit	588-591, 633	Fusible Link Wire	226-227	Honda Clips & Fasteners	658-681
Door Lock Striker				Hood Bumpers	394-396
Bolt Assemblies	587, 615	G		Hood Prop	850
Door Locks	640	Gas Pump Nozzles & Accs.	845	Hook, "S"	399
Door Seals	397	Gaskets, Oil Drain Plug	275-282	Horns & Horn Relay	406-408
Double End Threaded Studs:		Gauges	835	Hose:	
Metric	115, 138	General Motors Clips & Fasteners	547-593	Air	203
U.S.	150	Glass Setting Blocks	400	Electronic Fuel Injection	203
Drain Cocks & Valves	291-292	Glass Setting Channel	398	Fuel Line	203
Drain Plugs & Gaskets	275-282	Glass Shop Supplies	400-405	Heater	203
Drill Bits	316	Gloves	840-841	Vacuum & Windshield	
Drill-Out® Bolt Extractor Kit	852	Grease Fittings:		Washer Tubing	203
		Metric	148, 285	Hose Clamps	831-834
		U.S.	283-284	Hose Clamp Pliers	831, 849
E		Grease Guns & Accs.	286	Hose Clamp Rack	335
E Type Retaining Rings	147, 186, 189	Green Catalog	9	Hose, Tubing & Wire Dispenser	333
Electrical Connectors	204-213, 224, 236-257	Grinding Disc	68	Hyundai Clips & Fasteners	682-688
Electrical Pigtails & Sockets	236-257	Grommets:			
Electrical Section (Brown Pages)	204-274	Brass	411	I	
Electrical Tape	230	Rubber & Vinyl	389-390, 394-396	Ignition Locks	640
Electrical Terminals	204-222	Grooveless Retaining Rings	190	Import Vehicle Section	642-823
Electrical Crimping Tools	222-223	Ground Strap, Engine	228	Indicator Lamps (Toggle Switch)	270
Electronic Fuel Injection Hose	203			Infiniti Clips & Fasteners	689-693
Engine Manifold Repair Kit	836	H		Interior Trim Buttons	409-410
Epoxy, Flexible & Rigid	837	Hair Pin Cotter	192-193	Isuzu Clips & Fasteners	694
Epoxy Putty	838	Halogen Headlight Bulbs	260, 263-265, 267		
Expansion Plugs:		Hammer Drive Anchors	842	J	
Metric	149	Hand Sanding Pads	67	J Nuts	142-144, 172-173
U.S.	846	Handles, Window Crank & Door:		J Type Cage Nuts	174
Extension Springs	190, 380	Ford	616	Jack Nuts®	167
Extruded U-Nuts	145, 176-179	General Motors	593	Jaguar Clips & Fasteners	695
		VW	821	J.I.S. Cap Screws	118
F		Hanger Strap	845	J.I.S. Flange Bolts	120
Fastener Assortments	339-342	Harness Connectors	236-257	J.I.S. Hex Nuts	138
Fasteners, Universal Moulding	824-825	Headlight Adjusting Assy.:			
FasTrack	6	AMC	634	K	
Fender Shims	184	Chrysler	616	Key Blanks & Accs.	635-641
Fender Welt	410	Ford	594	Keys:	
Fiat Clips & Fasteners	657-658	General Motors	547-549	Hex	119, 857
Fittings:		Toyota	778	Straight	196
Brass	287-292	VW	808	Woodruff	196
Grease (Metric)	148, 285	Headlight Adjusting Springs:		Kia Clips & Fasteners	695-700
Grease (U.S.)	283-284	General Motors	549	Kits (Green Pages)	317-385
"Fix-Kit" Labels	333	Headlight Resurfacer	840		
"Fix-Kits"	343-363	Headliner Tools	847-848	L	
Flange Bolts	80	Heat Shrink Tubing	231	Labels, Bin & Lid	33, 337
Flange Lock Nuts:		Heater Hose	203	Land Rover Clips & Fasteners	700-702
Metric	139	Helical Threaded Inserts	166	Lexus Clips & Fasteners	703-715
U.S.	80	Hex Key Sets	851	License Plate Nuts & Screws	105-113
Flashlights	854	Hex Keys:		Light Bulbs	258-267, 841
Flat Nuts	170-171	Metric	119, 851	Lock & Accs.	640
Flex-Fit Rubber Moulding	398	Torx®	851	Locking Hole Plugs	196
Flexible Setting Epoxy	837	U.S.	851	Loom, Wire	225
Fluorescent Work Light	855	Hex Lock Nuts (Pal Nuts)	154	Lubrication Fittings	148, 283-285
Foldover Nuts	145, 176-179	Hex Nuts:		Lynch Pins	193
Footman Loops	410	Metric	138		
Ford Clips & Fasteners	594-616	U.S.	152-153	M	
"FP" Kits	382-384	Hinge Bushings (Door)	592-593, 615, 632	Machine Screws:	
Frame Bolts	80	Hinge Pins (Door)	591-592, 615, 633	Metric	116
Free Spinning Washer Nuts:		Hog Ring Pliers	850	Stainless Steel	83
Metric	139			U.S.	77-78
U.S.	155				

ALPHABETICAL INDEX

Magnetic Chucks	851	Nuts <i>continued:</i>		Nylon Connectors	197-200
Manifold Repair Kit	836	Cage	142	Nylon Insert Lock Nuts:	
Manifold Studs:		Collared (Battery)	229	Metric	138
Metric	138	Extruded U	145, 179-179	U.S.	85, 152
U.S.	114-115	Flat	170-171	O	
Marine Fasteners	414-415	Free Spinning Washer	139, 155	O- Ring Assortments	385
Marker Light Assemblies	243	Hex:		O-Rings:	
Maxi-Fuses	235	Brass	152	Air Conditioning	388-389
Mazda Clips & Fasteners	715-725	Flange	140	Metric	387
Mega Fuses	235	Flange Lock	80, 139	Rubber (U.S.)	386
Mercedes-Benz		Frame (Flange Lock)	80	O.E.M. Electrical Terminals	214-221
Clips & Fasteners	726-733	Free Spinning Washer	139, 155	Oil Cans	856
Mechanics Wire	845	Grade 5 & Grade 8	153	Oil Drain Plugs & Gaskets	275-282
Metric Items (Blue Pages)	116-151	Keps Lock Washer	153	Opel Clips & Fasteners	757
Micro Fuses	235	Machine Screw	85, 152		
Mini-Cooper Clips & Fasteners	735-734	Metric	138	P	
Mini Fuses	235	Nylon Insert	85, 138, 152	PAL Fuses	233
Mini Grinding Disc	68	Prevailing Torque	152	Pal Nuts:	
Miniature Bulb Cabinet	33	Reversible Lock	152	Metric	140
Miniature Bulbs	258-259	SAE (Fine)	152-153	U.S.	154
Mitsubishi Clips & Fasteners	735-739	Slotted	152	Peel-Bak Weatherstrip	391
Monobolts® & Tools (Rivets)	301	Spin Lock	140, 154	Peugeot & Citroen	
Moulding Clips:		USS (Coarse)	152-153	Clips & Fasteners	758-763
Acura	642-649	J Type Nuts	142-144, 172-173	Piano Wire	405
AMC	634	Jack Nuts®	167	Pigtail Connectors	236-257
Audi	808-821	J.I.S.	138	Pins:	
BMW	650-657	License Plate	109-113	Clevis	193
Chrysler	616-633	Lock	139-140, 152-154	Cotter:	
Fiat	657-658	Metric	138-145	Hammerlock, U.S.	193
Ford	594-616	Nylon	85, 109-112, 138, 152	Metric	149
General Motors	547-593	Pal Nuts:		Stainless Steel	84
Honda	658-681	Metric	140	Hair Pin	192-193
Hyundai	682-688	U.S.	154	Lynch	193
Infiniti	689-693	Pushnuts, Bolt Retainers:		Retainer	191
Isuzu	694	Metric	141	Spring/Roll	194
Jaguar	695	U.S.	154	Weld	839
Kia	694-700	Self-Threading:		Pipe Fittings	286, 289-291
Land Rover	700-702	Metric	141	Plain White Boxes	852
Lexus	703-715	U.S.	155	Plastic & Headlight	
Mazda	715-725	Specials	175	Resurfacers/Protector	840
Mercedes-Benz	726-733	Speed (Extruded U, Flat, J, U & Tubular)		Plastic Plug Buttons	195-196
Mini-Cooper	733-734		169-179, 141-145	Plastic Wrap	839
Mitsubishi	735-739	Spin Lock:		Pliers, Retaining Ring	190, 850
Nissan	739-757	Metric	140	Plug Buttons, Steel,	
Opel	757	U.S.	154	Nylon & Plastic	195-196
Peugeot & Citroen	758-763	Spring	174	Plugs:	
Renault & Dacia	764-770	Square	153	Drain	276-282
Saab	770	Stainless Steel	85	Expansion:	
SEAT & Skoda	808-821	Teenuts	159	Metric	149
Subaru	770-776	Thread Cutting:		U.S.	846
Suzuki	777	Metric	140-141	Locking Hole	196
Toyota	778-808	U.S.	155	Pipe	286, 289-291
Volkswagen	808-821	Tubular	141, 169-170	Polyethylene	195
Volvo	822-823	U-Nuts	142-145, 172-179	Polyethylene Hose Connectors	201
Universal	823	Washer Lock Nuts:		Pop-On Screw Covers & Bases	70, 412
Window Reveal Moulding	401-403	Metric	140	Power Window Lift Motor Gear Kits	405
Moulding Cutting Tool	853	U.S.	154	Power Window Regulator Gears	405
Moulding Tape	839	Well Nuts®	168	Prep Pen	849
N		Wheel	156-157	Prevailing Torque Locknuts	152
“Nipper” Wire Rope Clips	844	Wing:		Primary Wire	226
Nissan Clips & Fasteners	739-757	Metric	140	Push-On Retainers:	
Nuts:		U.S.	84, 153-154	Metric	141
Acorn	85, 140, 154	Nutserts® & Tool	160-163	U.S.	154
Brass	152	Nylon Anchors	842		
		Nylon Cable Ties	272-274		

ALPHABETICAL INDEX

Pushnut Bolt Retainers:	
Metric	141
U.S.	154
Pushnut Fasteners	141, 154, 844
Push-Pull Controls	845
Push-Type Retainers	490-533
Specification Chart	534-545

Q	
Quik-Select Assortments	370-380
Quik-Select Boxes	370
Quik-Select II Assortments	364-369
Quik-Select II Boxes	364

R	
Racks:	
Hose Clamp	335
Threaded Rod	334
Wire Spool	334
Razor Blades & Scraper	848
Rear View Mirror Brackets	464
Renault & Dacia	
Clips & Fasteners	764-770
Retainers:	
Bolt:	
Metric	141
U.S.	154
Pins	191
Push-On:	
Metric	141
U.S.	154
Push-Type	490-533
Push-Type	
Specification Chart	534-545
"Xmas Tree"	415-474
"Xmas Tree"	
Specification Chart	475-489
Retaining Rings & Pliers	185-190, 850
Rigid Setting Epoxy	837
Rivet Guns & Nosepieces	295-296
Rivet Washers	295
Rivets:	
Avex®	299
Blind	293-294, 297-300
Closed-End	302
Klamp-tite	300
Large Secondary Head	300
Monobolt®	301
Multi-Grip	298
Nylon	297-298
Pan'l (Pop®)	293-294, 298
"Peel-Type"	302-306
Plywood	299
Solid Aluminum	293
Specialty	307-315
Stavex® Large Flange	299
Tacking	300
Ultragrip	302
Rod End Ball Joints	826-827
Roll/Spring Pins	194
Rough Service Light Bulbs	841
Routing Clips	270-271
Rubber:	
Bumpers	394-396
Caps	197, 399

Rubber continued:	
Connectors	201
Grommets	389, 394
Hold Down Straps	399
O-Rings	386
Tape	230
Weatherstrip	391-394, 397

S	
"S" Hooks	
Saab Clips & Fasteners	770
SEAT & Skoda	
Clips & Fasteners	808-821
Screw Anchors	842
Screw Covers & Bases	70, 412
Screw Pin Anchor Shackles	843
Screws:	
Cap:	
Grade 5	81
Grade 8	82
Metric	117-119
Stainless Steel	84
Drill Point	73
Hex:	
Lag	75
Regular	74
Sems®	72, 75, 88-104
Washer Head:	
Acorn	73
Regular	74
Slotted	72-73
Teks®	74
Type F	73
License Plate	105-111
Machine:	
Metric	116
U.S.	77-78, 83
Phillips:	
Hex Washer Head Tapping	73
Flat Head Tapping	70
Flat Head Wood	76
Flat Top Washer Head Tapping	72
Oval Head Machine	77, 116
Oval Head Sems® Tapping	72
Oval Head Sems® Teks®	72
Oval Head Tapping	69, 83
Oval Head Teks® Tapping	69, 72
Pan Head Machine	78, 116
Pan Head Sems® Tapping	72
Pan Head Tapping	71, 83
Pan Head Teks®	74
Round Head Machine	78, 83
Self-Piercing	73
Set	79, 120
Slotted:	
Fillister Head Metric	116
Flat Head Machine	116
Hex Head Self-Piercing	73
Hex Washer Head Tapping	75
Oval Head Tapping	69
Pan Head Machine	116
Pan Head Tapping	71
Pan Head Type F	72
Round Head Machine	78, 83
Socket Head Cap (Metric)	119

Screws continued:	
Socket Head Set:	
Metric	120
U.S.	79
Specialty	91-104, 128-137
Stainless Steel	83-84
Stove Bolts	77
Tapping	69-76, 83, 128-137
Teks®	29, 72, 74, 76, 91-104, 128-137
Torx®:	
Drive Floor	76
Pan Head Tapping	70, 130
Metric	70, 130
U.S.	76
Trim	69-75
Wood, Flat Head	76
Sealer, Automotive	837
Self-Threading Nuts:	
Metric	141
U.S.	155
Seam-N-Joint Sealer	837
Set Screws	79, 120
Shackles	843
Sheet Metal Plugs	195
Shims	184
Snaps	414-415
Socket Wrenches	851
Sockets, Electrical	236-257
Solder Paste	839
Solderless Terminals	204-213
Sound Dampening Pads	840
Speed Nuts®	169-179, 141-145
Split Flexible Tubing	225
Sponge Rubber	
Weatherstrip	391-394, 397
Spring Nuts	174
Spring Pins	194
Springs:	
Extension & Compression	190-191, 380
Truck Seat	546
Stainless Steel Fasteners	83-85
Stainless Steel Grease Fittings	283-284
Stand-Offs, Nylon	843
Stove Bolts	77
Straight Keys	196
Strain Relief Cable Connector	271
Strap, Engine Ground	228
Strap, Perforated Hanger	845
Straps, Rubber Tie Down	399
Strip-Brite Disc	68
Studs, Manifold:	
Metric	138
U.S.	114-115
Subaru Clips & Fasteners	770-776
Suction Gun	856
Surface Conditioning Disc	68
Suzuki Clips & Fasteners	777
Switches:	
Horn Button	268
Push-Pull	268
Toggle	268-270

ALPHABETICAL INDEX

T

Tape:	
Electrical	230
Moulding	839
Rubber	230
Tapping Screws	69-70, 83, 128-137
Tee Rubber	398
Teenuts®	159
Test Clips	227
Terminals:	
Battery	227-229
Electrical	204-222
Thread Cutting Nuts:	
Metric	140-141
U.S.	155
Thread Cutting Screws	73
Threaded Inserts:	
Helical	166
Nutserts®	160-163
Thread Repair	164-165
Throttle Rod Clips	191
Ties, Cable (& Mounts)	272-274
Tire Valves	390
Toggle Bolts	842
Toggle Switches	268-270
Tools:	
Awls	849
Battery Tools	229-230
Bolt Extractor Kit	852
Cable Tie Tool	274
Caulking Guns	856
Circuit Tester	224-225
Clip Removal Tool	848
Cut-Off Wheel & Mandrels	854
Drill-Out® Bolt Extractor	852
Door Handle Clip Tool	400-401
Electrical Connector Separator	222
Electrical Crimping Tools	222-223
Flashlights	854
Gauges	835
Glass Shop	847-849
Grease Guns	286
Headliner Tools	847-848
Hex Key Sets	851
Hog Ring Pliers	850
Hole Punch	856
Hood Prop	850
Hose Clamp Pliers	831, 849
Hose Cutter	853
Jack Nut Installation Tool	164
Knife (Carpet)	848
Magnetic Chucks	851
Moulding Cutting Tool	853
Nutsert® Installation Tool	163
Pick (O-Ring & Seal)	849
Prep Pen	849
Razor Blade Scraper	848
Retaining Ring Pliers	190, 850
Revolving Punch	856
Rivet Guns & Nosepieces	295-296
Seat Spring Wire Bender	546
Suction Gun	856
Terminal Extractor Picks	222
Test Clips	227
Torx® Bits & Drivers	70, 131, 850
Trim Pad Removal Tool	847

Tools continued:

Truck Seat Spring	
Bending Tool	546, 855
Windshield Moulding Tools	847
Windshield Wiper Arm Remover	847
Toughcoat Light Bulbs	841
Torx® Bits & Drivers	70, 131, 850
Toyota Clips & Fasteners	778-808
Trailer Connectors	257
Trim Clips	409-410
Trimming Sundries & Fasteners	409-546
Truck Seat Spring Wire Bender	546, 855
Truck Seat Springs	546
Truck Wheel Hardware	156-158
Tubeless Tire Valves	390
Tubing:	
Clamps	270, 834-835
Clear Vinyl (PVC)	202, 844
Connectors:	
Brass	292
Nylon	197-200
Heat Shrink	231
Vacuum & Windshield Washer	203
Tubular Nuts	141, 169-170
Tumblers (Lock)	640
Twist-to-lock Holders	68

U

U-Nuts	142-145-, 172-179
Universal Moulding Clips	823
Universal Springs	191

V

Vacuum:	
Rubber & Vinyl Caps	197, 399
Tubing	203
Tubing Connectors	197-201
Vacuum & Windshield Washer Tubing	203
Valves, Tubeless Tire	390
Vent Window Seals	397
Vibration Dampening Pads	840
Vinyl Caps	197, 399
Vinyl Gloves	840-841
Vinyl Grommets	384, 389
Vinyl Tubing	202, 844
Volkswagen Clips & Fasteners	808-821
Volvo Clips & Fasteners	822-823

W

Washer Cap Type Pushnut Fasteners	844
Washer Lock Nuts:	
Metric	140
U.S.	154
Washer Type Self-Threading Nuts:	
Metric	141
U.S.	155
Washers:	
Belleville	181
Bowed Spring	181
Copper:	
Metric	146
U.S.	181
Countersunk	180, 411
Countersunk Lock	182
Fender	182
Flanged	180, 411

Washers continued:

Flat:	
Metric	146
U.S.	85, 180-183
Flush	180, 411
High Strength, U.S.S. & S.A.E.	181
Internal & External Combo Lock	183
Lock	146, 181-183
Metric	146
Nylon Finishing	180, 412
Nylon Flat	183
Rivet	295
S.A.E.	180-181
Split Lock, Regular & High Alloy	181
Spring Wave, Metric	146
Stainless Steel	85
Tooth (Internal, External & Countersunk)	182-183
Vibration Proof	182
Wave, Metric	146
Wrought (USS)	180
X	183
Weather-Seal Wrap	839
Weatherpack Terminals	215-216
Weatherstrip	390-391, 397
Weatherstrip for Glass	397-399
Weld Pins	839
Well Nuts®	168
Welt, Fender	410
Wheel Studs & Nuts	156-158
Windlace Cord	394
Window Channels	397-399
Window Crank Handle Clips	400-401
Window Crank Handles:	
Ford	616
General Motors	593
VW	821
Window Guides	403-404
Window Lift Motor Gear Kit	405
Window Regulator Drive Block	404
Window Regulator Gear	405
Window Reveal Moulding Clips	401-403
Window Rubber Moulding	398
Windshield Moulding Clip Tool	847
Windshield Washer & Vacuum Tubing	203
Wire:	
Bending Tool	
(Truck Seat Spring)	546, 855
Fusible Link Wire	226-227
Loom	225
Loom Clips & Straps	270
Mechanics Wire	845
Piano Wire	405
Primary Wire	226
Rope Clips (Nipper)	844
Wire Nuts	224
Wire Spool Racks	334
Woodruff Keys	196
Work Light	855
X	
X-Washers	183
"Xmas Tree" Retainers	415-489
Y	
Yoke Ends	194, 830

NUMERICAL INDEX

Auveco No.	Page No.	Auveco No.	Page No.	Auveco No.	Page No.	Auveco No.	Page No.	Auveco No.	Page No.	Auveco No.	Page No.	Auveco No.	Page No.
AP448L	317	B6461	262	FP-210	384	39	287	194	288	347	290	1007	838
AP448S	317	B7225	262	FP-224	382	45	287	198	288	348	290	1008	838
AuvecoPaks	317	B7440	262	FP-232	383	46	287	200	288	349	290	1020	340
B-1	336	B7440A	262	FP-233	383	47	287	201	288	350	291	1021	340
B-2	336	B7443	262	FP-243	383	49	287	211	289	351	291	1030	340
B-3	352	B7443A	262	FP-247	384	50	287	221	289	352	291	1031	340
B24	262	B7505	262	MB-36	336	51	287	223	289	353	291	1040	340
B24A	262	B7506	262	P40-S	335	52	287	224	289	355	291	1041	340
B53	262	B7507	262	P277	335	53	287	230	289	356	291	1042	340
B57	262	B7515	262	V-875	410	68-6	370	231	289	359	291	1043	340
B67	262	B7528	262	0-Boxes	852	68-12	370	232	289	360	291	1052	338
B67A	262	B9004	264	1-900	332, 352	68-18	370	233	289	370	291	1053	338
B68	262	B9005	264	1-900L	333	68-112	370	245	289	371	291	1054	338
B89	262	B9006	264	1-901	332, 352	68-118	370	246	289	372	291	1055	338
B97	262	B9007	264	1-901 DIVIDERS		68-RACK	370	247	289	374	291	1092	71
B168	262	B64113	265		332	69	287	262	289	385	291	1137	69
B194	262	B64132	265	1-902	332, 352	69-12	364	263	289	399	292	1146	71
B194-100	262	B64150ULT	264	1-912	332, 352	69-18	364	264	289	401	292	1149	69
B194A	262	B64193	265	1-912L	333	69-24	364	265	289	404	292	1183	182
B880	263	B64193ULT	265	1-916	332, 352	69-112	364	266	289	405	291	1202	410
B881	263	B64210ULT	265	1-916INSERT		69-118	364	268	289	406	291	1256	409
B884	263	BD1S	264		332, 352	69-124	364	269	289	413	292	1263	71
B885	263	BD2C	264	1-916L	333	69-RACK	364	287	289	415	292	1265	71
B886	263	BD2R	264	1-920	332, 352	70	287	288	289	416	292	1266	71
B889	263	BD2S	264	1-920INSERT		72	287	289	289	417	292	1267	400
B890	263	BH1	264		332, 352	72B-9	335	291	289	418	292	1294	182
B891	263	BH3	265	1-920L	333	73	287	292	289	419	292	1313	105, 109
B893	263	BH7	265	1-924	332, 352	75	287	293	289	420	292	1340	270
B894	263	BH9	265	1-924INSERT		76	287	294	289	421	292	1341	270
B896	263	BH10	265		332, 352	77	287	295	289	422	292	1344	71
B899	263	BH11	265	1-924L	333	78	287	296	289	423	292	1346	71
B906	262	BH13	265	1-932	332, 352	91	287	297	289	424	292	1347	71
B906A	262	DB-420-0	8	1-ACC	336	96	287	298	289	425	292	1376	182
B912	262	DB-428-1	8	1-Boxes	852	101	288	299	289	426	292	1381	71
B916	262	DB-428-2	8	1-HTWD	333	102	288	300	289	427	292	1382	71
B916A	262	DB-428-3	8	1-MBC	333	103	288	301	289	428	292	1413	77
B921	262	DB-428-4	8	1-TR	334	105	288	302	289	429	292	1421	69
B921A	262	DB-428-5	8	1-WSR	334	107	288	303	289	430	292	1423	69
B1141	262	DB-428-6	8	2-96	332, 352	110	288	304	289	431	292	1424	69
B1156	262	DB-428-7	8	2-600L	333	111	288	305	290	432	292	1432	69
B1156A	262	DB-428-8	8	2-608	331	112	288	306	290	433	292	1452	71
B1157	262	DB-428-9	8	2-612	331	113	288	307	290	434	292	1453	71
B1157A	262	DB-428L	337	2-612L	333	114	288	308	290	435	292	1454	71
B1893	262	DFC-1	45	2-616	331	119	288	309	290	437	292	1455	71
B1895	262	DFK-1	44	2-616L	333	120	288	310	290	438	292	1456	71
B2057	262	DFK-2	45	2-620	331	121	288	311	290	439	292	1457	71
B2057A	262	DFK-3	45	2-620L	333	122	288	313	290	440	292	1458	71
B2357	262	DFT-1	45	2-621	331	123	288	314	290	442	292	1459	71
B2357A	262	DFT-2	45	2-624	331	124	288	315	290	443	292	1460	71
B2721	262	DFT-3	45	2-624L	333	125	288	316	290	455	292	1479	70
B2722	262	DFT-4	45	2-Boxes	852	126	288	317	290	456	292	1483	69
B2821	262	DFT-5	45	2-WSR	334	127	288	318	290	457	292	1700	182
B2825	262	DFT-6	45	3-60	331	128	288	319	290	464	292	1712	70
B2827	262	Dividers	336	3-96	332, 352	134	288	320	290	465	292	1717	69
B3057	262	FP-100	382	3-Boxes	852	135	288	321	290	602	180, 411	1720	409
B3057A	262	FP-102	382	4-60	331	137	288	322	290	604	180, 411	1780	74
B3156	262	FP-104	382	4-96	332, 352	150	288	325	290	612	180, 411	1781	74
B3156A	262	FP-108	382	4-Boxes	852	151	288	326	290	614	180, 411	1787	71
B3157	262	FP-123	382	5-HCR	335	152	288	327	290	616	180, 411	1793	69
B3157A	262	FP-131	383	6-60	331	153	288	328	290	618	180, 411	1794	69
B3357	262	FP-132	383	7-SBoxes	852	154	288	329	290	619	180, 411	1796	69
B3357A	262	FP-159	383	9-D	336	155	288	330	290	727	152	1797	69
B3457	262	FP-160	383	10-HCR	335	158	288	331	290	728	152	1798	69
B3457A	262	FP-163	383	11	401	159	288	332	290	729	152	1799	69
B3893	262	FP-164	384	18-CB	335	161	288	333	290	730	152	1800	69
B4114K	262	FP-168	383	18-D	336	162	288	334	290	731	152	1801	69
B4157	262	FP-169	383	30	287	163	288	335	290	733	152	1802	69
B4157K	262	FP-171	384	31	287	164	288	336	290	768	182	1803	69
B5007	262	FP-178	384	32	287	168	288	337	290	807	409	1804	69
B5008	262	FP-179	384	33	287	186	288	339	290	808	409	1826	91, 95
B6411	262	FP-183	384	35	287	187	288	341	290	1001	837	1863	77
B6413	262	FP-188	384	36	287	189	288	342	290	1002	837	1877	77
B6418	262	FP-193	384	37	287	192	288	343	290	1005	837	1896	170
B6438	262	FP-194	384	38	287	193	288	344	290	1006	837	1898	170

NUMERICAL INDEX

Auveco No.	Page No.	Auveco No.	Page No.	Auveco No.	Page No.	Auveco No.	Page No.	Auveco No.	Page No.	Auveco No.	Page No.	Auveco No.	Page No.
1899	170	2452	184	2712	69	3078	71	3414	86	3713	77	3963	846
1900	170	2453	184	2713	69	3079	71	3415	86	3715	77	3964	846
1903	171	2472	106, 110	2716	69	3080	71	3432	86	3716	77	3965	846
1905	171	2485	74	2717	69	3081	71	3433	86	3717	77	3966	846
1906	171	2487	74	2718	69	3082	71	3434	86	3718	77	3967	846
1907	173	2515	180, 411	2720	69	3083	71	3435	86	3719	77	3968	846
1912	170	2530	78	2722	69	3084	71	3438	86	3720	77	3969	846
1913	173	2531	78	2724	69	3085	71	3465	72	3722	77	3971	846
1932	69	2532	78	2726	69	3086	71	3466	72	3724	77	3975	154
1933	69	2533	78	2727	69	3087	71	3467	72	3741	154	3984	180
1934	77	2534	78	2728	69	3088	71	3468	72	3743	154	3985	180
1935	71	2535	78	2729	69	3089	71	3469	180, 411	3750	195	3986	180
1936	71	2536	78	2730	69	3090	71	3470	180, 411	3751	195	3987	180
1937	71	2537	78	2731	69	3091	71	3471	180, 411	3752	195	3988	180
1939	71	2538	78	2734	69	3092	71	3472	180, 411	3753	195	3989	180
1940	71	2539	78	2735	69	3093	71	3484	69	3754	195	3990	180
1942	71	2540	78	2736	70	3099	86	3492	153	3755	195	3991	180
1943	71	2541	78	2744	824	3100	86	3493	153	3756	195	3992	180
1946	70	2542	78	2751	72	3102	86	3494	153	3758	270	3993	180
2007	182	2543	78	2752	824	3135	400	3495	153	3770	173	4155	395
2008	182	2544	78	2753	77, 88	3137	169	3496	153	3776	169	4188	394
2012	74	2545	78	2769	154	3138	171	3497	153	3777	169	4204	396
2024	69	2546	78	2771	72	3144	154	3498	153	3793	170	4233	395
2027	69	2548	78	2772	72	3155	184	3499	153	3796	172	4235	394
2028	92, 99	2550	78	2773	72	3156	184	3500	153	3797	173	4236	396
2046	69	2554	154	2774	72	3165	189	3502	193	3798	154	4237	394
2057	173	2555	154	2775	72	3166	189	3503	193	3824	189	4240	396
2089	170	2556	154	2789	824	3167	189	3504	193	3854	77	4242	394
2091	170	2557	154	2802	69	3168	193	3505	193	3859	77	4243	394
2092	170	2558	154	2804	70	3178	548	3506	193	3868	152	4244	395
2098	171	2560	154	2805	91, 95	3182	105, 109	3508	193	3877	196	4246	394
2099	171	2561	154	2806	91, 96	3183	105, 109	3509	193	3878	196	4248	394
2100	171	2562	154	2807	70	3184	105, 109	3511	193	3879	196	4249	395
2102	171	2571	69	2808	71	3186	229	3512	193	3880	196	4250	395
2103	171	2572	69	2809	75	3205	69	3513	193	3881	196	4258	395
2105	171	2574	69	2810	70	3207	69	3515	193	3882	196	4260	394
2107	74	2575	69	2818	824	3209	548	3519	193	3883	196	4264	395
2109	74	2578	69	2850	411	3211	71	3520	193	3884	196	4265	394
2110	74	2579	69	2895	155	3212	74	3521	193	3885	196	4273	395
2178	92, 99	2580	69	2896	155	3214	74	3522	193	3886	196	4280	394
2209	88	2581	69	2897	155	3215	74	3524	193	3887	196	4281	396
2227	182	2582	69	2943	567, 824	3216	74	3526	193	3888	196	4305	386
2262	159	2583	69	2967	75	3217	74	3537	72	3889	196	4306	386
2266	74	2585	69	2968	75	3219	74	3538	72	3890	196	4307	386
2267	74	2586	69	2969	75	3220	74	3539	72	3891	196	4308	386
2268	74	2595	169	2973	75	3249	153	3541	152	3892	196	4309	386
2269	74	2597	180, 411	2974	75	3250	153	3542	152	3893	196	4310	386
2272	409, 634	2598	193, 400	2976	75	3367	75	3543	152	3894	196	4311	386
2288	400	2604	75	2978	75	3368	75	3544	152	3895	196	4312	386
2293	173	2605	75	2979	75	3369	75	3545	152	3896	196	4313	386
2299	77	2611	169	2980	75	3373	75	3546	152	3929	180	4314	386
2303	173	2619	824	2981	75	3374	73, 75	3547	152	3930	180	4315	386
2309	409	2625	111	2988	75	3375	75	3548	152	3931	180	4316	386
2310	409	2628	402	2989	75	3376	73, 75	3549	152	3932	180	4317	386
2330	75	2632	69	2991	75	3378	75	3550	152	3933	180	4318	386
2333	182	2633	69	2994	75	3379	75	3553	182	3935	180	4319	386
2346	172	2656	69	2996	75	3380	75	3554	182	3937	846	4320	386
2354	77	2657	69	2999	184	3381	75	3556	182	3938	846	4321	386
2358	69	2661	69	3000	184	3382	75	3609	191	3939	846	4322	386
2359	69	2665	69	3020	71	3383	75	3610	191	3941	846	4323	386
2360	69	2666	69	3022	71	3385	75	3611	191	3942	846	4324	386
2361	69	2672	189, 411	3028	71	3386	75	3612	191	3944	846	4347	386
2362	69	2688	77, 88	3032	71	3387	75	3613	191	3945	846	4348	386
2364	71	2698	69	3062	69	3388	75	3614	191	3946	846	4349	386
2365	71	2699	69	3063	69	3389	75	3615	77, 88	3949	846	4350	386
2366	71	2700	69	3068	69	3390	75	3616	174	3950	846	4351	386
2367	71	2702	69	3069	69	3392	75	3617	413	3952	846	4352	386
2369	75	2704	69	3071	71	3393	75	3620	442, 475	3953	846	4353	386
2370	75	2705	69	3072	71	3394	75	3628	189	3956	846	4354	386
2385	409	2706	69	3073	71	3400	155	3639	442, 475	3957	846	4355	386
2389	74	2707	69	3074	71	3401	155	3682	112	3958	846	4356	386
2420	173	2709	69	3075	71	3403	155	3690	272	3960	846	4357	395
2422	173	2710	69	3076	71	3404	155	3711	77	3961	846	4369	395
2426	171	2711	69	3077	71	3405	155	3712	77	3962	846	4408	389

NUMERICAL INDEX

Auveco No.	Page No.	Auveco No.	Page No.	Auveco No.	Page No.	Auveco No.	Page No.	Auveco No.	Page No.	Auveco No.	Page No.	Auveco No.	Page No.
4410	389	4747	392	5077	184	5376	79	5472	81	5648	70	6062	343, 351
4411	389	4749	393	5096	184	5377	79	5473	81	5649	70	6065	343, 350
4413	389	4750	393	5097	184	5378	79	5474	81	5650	70	6070	343, 346
4414	389	4800	391	5167	154	5379	79	5475	81	5651	70	6073	343, 345
4415	389	4801	391	5170	174	5380	79	5476	81	5653	70	6085	343, 348
4417	389	4802	391	5195	169	5381	79	5477	81	5654	70	6086	343, 347
4418	389	4803	391	5196	170	5382	79	5478	81	5655	70	6112	343, 347
4419	389	4804	391	5197	173	5383	79	5479	81	5656	70	6116	343, 348
4420	389	4805	391	5219	255	5384	79	5480	81	5660	70	6123	343, 347
4421	389	4806	391	5220	255	5385	79	5481	81	5661	70	6124	343, 350
4422	389	4807	391	5221	255	5386	79	5482	81	5672	70	6125	343, 350
4423	389	4808	391	5225	256	5387	79	5483	81	5697	77	6128	343, 349
4425	389	4809	391	5226	256	5388	79	5484	81	5700	78	6133	343, 351
4426	389	4810	391	5228	112	5389	79	5485	81	5702	78	6144	343, 345
4428	389	4811	391	5238	86	5390	79	5486	81	5704	78	6158	343, 348
4429	389	4812	391	5239	86	5391	79	5487	81	5711	77, 88	6160	343, 345
4430	389	4813	391	5242	86	5392	79	5488	81	5713	77, 88	6162	343, 350
4431	389	4850	391	5243	86	5393	79	5489	81	5714	86	6164	343, 346
4432	389	4851	391	5246	86	5394	79	5490	81	5717	181	6166	343, 350
4433	389	4852	391	5249	182	5395	79	5491	81	5718	181	6167	343, 351
4434	389	4853	391	5250	182	5396	79	5492	81	5719	181	6168	343, 351
4435	389	4854	391	5251	182	5398	79	5493	81	5720	181	6172	343, 347
4436	389	4855	391	5252	182	5399	79	5494	81	5721	181	6173	343, 349
4439	197, 399	4856	391	5253	182	5400	79	5495	81	5722	181	6175	343, 349
4440	197, 399	4857	391	5254	182	5401	79	5497	81	5723	181	6176	343, 351
4441	395	4858	391	5255	182	5402	79	5499	81	5724	181	6178	343, 349
4446	395	4859	391	5256	182	5403	79	5500	81	5748	293	6182	343, 344
4447	395	4860	391	5257	182	5404	79	5501	81	5749	293	6186	343, 346
4448	399	4861	391	5258	182	5405	79	5505	81	5750	293	6187	343, 349
4449	399	5000	211	5259	182	5406	79	5510	81	5751	293	6501	353, 354
4450	399	5002	211	5260	182	5407	79	5512	81	5752	293	6502	353, 357
4451	399	5003	211	5261	182	5408	79	5513	81	5753	293	6503	353, 355
4453	203	5005	211	5262	182	5409	79	5514	81	5754	294	6504	353, 358
4454	203	5006	211	5263	182	5410	79	5516	81	5755	294	6505	353, 361
4456	203	5007	212	5264	182	5411	79	5524	81	5759	73	6506	353, 358
4457	203	5008	212	5265	182	5412	79	5526	81	5764	73	6507	353, 357
4459	203	5009	212	5266	182	5413	79	5527	81	5766	73	6508	353, 358
4460	203	5010	212	5267	182	5414	79, 851	5528	81	5767	73	6509	353, 359
4462	203	5014	211	5268	182	5415	79, 851	5530	81	5768	73	6510	353, 359
4463	203	5015	211	5270	182	5434	81	5533	81	5769	73	6511	353, 360
4464	203	5021	205	5271	182	5435	81	5537	81	5773	73	6513	353, 356
4465	203	5023	205	5272	182	5436	81	5538	81	5774	73	6514	353, 355
4466	203	5024	205	5274	182	5438	81	5539	81	5775	73	6517	353, 362
4467	203	5026	205	5278	106, 107	5439	81	5542	81	5776	73	6519	353, 361
4468	203	5027	205	5290	72	5440	81	5547	81	5778	73	6520	353, 361
4473	396	5028	205	5291	72	5441	81	5550	81	5781	73	6522	353, 361
4474	396	5029	205	5292	72	5442	81	5551	81	5782	73	6523	353, 359
4511	398	5030	205	5298	72	5443	81	5553	81	5783	73	6524	353, 357
4512	398	5031	205	5301	72	5444	81	5563	170	5784	73	6525	353, 361
4513	398	5032	205	5307	72	5445	81	5571	172	5786	73	6530	353, 354
4515	398	5033	205	5329	74	5446	81	5576	173	5787	73	6532	353, 356
4530	398	5034	205	5330	74	5447	81	5586	174	5788	548	6533	353, 354
4531	398	5035	205	5331	74	5448	81	5589	174	5789	548	6534	353, 360
4581	398	5036	205	5332	74	5449	81	5592	442, 475	5791	204	6535	353, 358
4588	398	5037	206	5347	833	5450	81	5596	154	5792	204	6536	353, 355
4654	394	5038	205	5348	833	5451	81	5600	189	5793	204	6537	353, 362
4655	394	5040	205	5349	833	5452	81	5601	189	5794	229	6538	353, 357
4656	394	5041	206	5350	833	5453	81	5602	189	5796	229	6539	353, 354
4670	398	5044	211	5351	833	5454	81	5603	189	5836	172	6540	353, 356
4671	398	5045	211	5352	833	5455	81	5616	69	5854	169	6541	353, 355
4675	392	5046	212	5354	832	5456	81	5617	69	5879	272	6542	353, 362
4688	398	5047	205	5357	832	5457	81	5618	69	5885	105, 109	6543	353, 360
4703	392	5048	205	5358	832	5459	81	5619	71	5889	825	6544	353, 359
4707	392	5049	206	5365	79	5461	81	5621	71	5908	105, 107	6545	353, 362
4731	392	5056	206	5366	79	5462	81	5623	71	5909	105, 107	6546	353, 362
4736	394	5062	208	5367	79	5463	81	5625	71	5910	106, 108	6547	353, 363
4737	394	5063	208	5368	79	5464	81	5626	71	5961	410	6548	353, 362
4738	394	5066	211	5369	79	5465	81	5629	71	6003	343, 344	6549	353, 362
4740	393	5067	207	5370	79	5466	81	5630	71	6004	343, 344	6550	353, 363
4742	393	5068	207	5371	79	5467	81	5632	71	6007	343, 346	6551	353, 363
4743	393	5072	205	5372	79	5468	81	5633	71	6011	343, 345	6552	353, 363
4744	393	5074	184	5373	79	5469	81	5634	71	6038	343, 344	6553	353, 360
4745	392	5075	184	5374	79	5470	81	5646	70	6043	343, 346	6554	353, 356
4746	393	5076	184	5375	79	5471	81	5647	70	6051	343, 348	6555	353, 363

NUMERICAL INDEX

Auveco No.	Page No.	Auveco No.	Page No.	Auveco No.	Page No.	Auveco No.	Page No.	Auveco No.	Page No.	Auveco No.	Page No.	Auveco No.	Page No.
6556	353, 362	6822	370, 378	6941	364, 369	8083	69	8456	81	8678	187	8862	154
6557	353, 361	6825	370, 376	6942	364, 367	8096	81	8477	193	8680	187	8863	154
6558	353, 360	6826	370, 375	7137	180, 411	8097	81	8478	193	8682	187	8864	154
6600BHM	324	6827	370, 377	7138	180, 411	8104	81	8479	193	8683	187	8865	154
6601BHM	324	6829	370, 379	7143	180, 411	8105	81	8480	193	8688	187	8867	154
6602BHM	324	6830	370, 375	7145	180, 411	8107	81	8481	193	8689	187	8868	154
6603BHM	324	6831	370, 375	7147	180, 411	8206	409	8482	193	8690	187	8869	154
6604BHM	324	6834	370, 380	7148	180, 411	8242	112	8483	193	8691	187	8871	293
6605BHM	325	6835	370, 378	7342	411	8249	106, 107	8484	193	8692	187	8872	293
6606BHM	325	6836	370, 376	7343	411	8250	106, 109	8485	193	8693	187	8873	293
6607BHM	325	6837	370, 379	7344	411	8272	272	8486	193	8694	187	8874	293
6608BHM	325	6838	370, 380	7347	411	8273	272	8487	193	8695	187	8875	293
6609BHM	325	6839	370, 380	7348	411	8277	275	8488	193	8696	187	8877	293
6610BHM	325	6840	370, 377	7349	411	8278	275	8489	193	8697	187	8879	293
6611BHM	325	6841	370, 377	7350	411	8279	275	8490	193	8698	187	8880	293
6612BHM	325	6842	370, 377	7409	415	8281	275	8491	193	8699	187	8881	293
6613BHM	325	6843	370, 376	7417	415	8285	282	8492	193	8700	187	8882	293
6614BHM	326	6845	370, 378	7419	415	8286	282	8493	193	8701	187	8883	293
6615BHM	326	6846	370, 378	7432	415	8288	282	8494	193	8702	187	8884	293
6616BHM	326	6847	370, 378	7578	410	8289	282	8495	193	8703	187	8886	293
6617BHM	326	6848	370, 371	7595	410	8290	293	8496	193	8704	187	8887	293
6618BHM	326	6850	370, 371	7613	180, 411	8291	293	8497	193	8705	187	8888	293
6619BHM	326	6851	370, 371	7615	180, 411	8292	293	8498	193	8706	187	8889	293
6620BHM	326	6852	370, 372	7616	180, 411	8293	293	8499	193	8707	187	8892	293
6621BHM	330	6853	370, 373	7618	180, 411	8294	294	8500	193	8708	187	8893	293
6622BHM	329	6854	370, 373	7624	180, 411	8295	294	8501	193	8709	187	8894	293
6623BHM	329	6856	370, 374	7625	180, 411	8296	294	8502	193	8710	187	8895	293
6624BHM	329	6857	370, 374	7644	410	8297	294	8503	193	8711	187	8896	293
6625BHM	330	6858	370, 373	7657	850	8298	294	8506	193	8712	187	8897	293
6626BHM	330	6859	370, 376	7658	850	8299	294	8507	193	8715	187	8898	293
6627BHM	330	6861	370, 375	7672	847	8300	294	8508	193	8719	411, 877	8899	293
6628BHM	328	6862	370, 375	7677	414	8301	294	8509	193	8742	156	8900	293
6629BHM	327	6863	370, 375	7678	414	8302	293	8511	193	8744	156	8901	293
6630BHM	327	6864	370, 379	7679	414	8303	293	8516	193	8746	156	8902	293
6631BHM	327	6865	370, 379	7680	414	8304	293	8518	193	8750	237	8903	293
6632BHM	329	6866	370, 378	7682	414	8305	293	8521	193	8754	237	8905	294
6633BHM	329	6867	370, 376	7688	414	8306	294	8530	193	8755	236	8906	294
6634BHM	326	6868	370, 374	7690	414	8307	294	8545	169	8756	237	8908	294
6635BHM	327	6869	370, 374	7691	414	8308	294	8546	169	8759	236	8909	294
6637BHM	328	6870	370, 379	7692	414	8309	294	8550	272	8761	244	8911	294
6638BHM	329	6871	370, 379	7707	411	8310	294	8552	86	8763	255	8912	294
6639BHM	329	6901	364, 367	7711	223	8311	294	8557	86	8764	256	8913	294
6640BHM	330	6902	364, 367	7767	851	8312	294	8562	86	8768	256	8914	294
6641BHM	328	6903	364, 367	7771	410	8313	294	8578	170	8769	257	8915	294
6642BHM	327	6904	364, 367	7772	410	8337	172	8581	825	8770	256	8917	294
6643BHM	328	6905	364, 367	7773	410	8341	173	8583	401	8772	227	8918	294
6644BHM	328	6906	364, 367	7778	847	8359	176	8588	78	8773	227	8919	294
6645BHM	328	6907	364, 367	7909	190, 850	8372	176	8589	78	8774	216	8920	294
6646BHM	330	6908	364, 368	7910	190, 850	8375	176	8590	78	8775	216	8922	294
6647BHM	331	6910	364, 369	7914	847	8377	176	8594	78	8776	216	8923	294
6648BHM	331	6911	364, 368	7915	295	8385	825	8605	180	8777	217	8924	294
6649BHM	326	6912	364, 369	7965	119, 851	8386	825	8606	180	8781	207	8925	294
6650BHM	324	6913	364, 369	7976	851	8398	825	8607	180	8788	208	8926	294
6699BHM	327	6914	364, 367	7977	79, 851	8399	825	8608	180	8814	177	8927	294
6801	370, 378	6915	364, 369	7978	79, 851	8400	825	8609	180	8824	189	8928	294
6802	370, 378	6916	364, 369	7981	295, 305	8418	112	8610	180	8825	189	8929	294
6803	370, 378	6917	364, 368	7983	295	8419	616	8611	180	8826	189	8930	294
6804	370, 379	6918	364, 369	7984	295	8427	105, 110	8612	180	8827	189	8931	294
6805	370, 379	6919	364, 367	7985	295	8435	112	8613	180	8828	189	8932	294
6806	370, 377	6920	364, 365	7996	230	8437	73	8621	180	8829	189	8933	294
6807	370, 379	6921	364, 365	7999	847	8438	73	8623	87	8830	189	8934	294
6808	370, 372	6923	364, 365	8003	229	8439	73	8624	87	8831	189	8935	294
6809	370, 378	6924	364, 366	8009	208	8441	73	8625	87	8832	189	8936	294
6810	370, 372	6929	364, 365	8029	78	8442	73	8626	86	8833	189	8937	294
6811	370, 372	6930	364, 366	8030	78	8443	73	8627	86	8834	189	8938	294
6812	370, 371	6931	364, 366	8031	78	8444	73	8649	181	8835	189	8939	294
6813	370, 372	6933	364, 366	8033	78	8445	184	8650	181	8836	189	8940	294
6814	370, 372	6934	364, 367	8035	78	8447	825	8659	152	8837	189	8941	403
6815	370, 374	6935	364, 368	8036	78	8448	825	8660	152	8843	810, 825	8942	549
6816	370, 374	6936	364, 368	8044	69	8449	81	8661	152	8847	88, 90	8944	91, 94
6817	370, 373	6937	364, 368	8050	69	8450	81	8662	152	8853	437, 475	8954	112
6818	370, 375	6938	364, 369	8056	69	8453	81	8663	152	8855	155	8963	846
6820	370, 376	6939	364, 369	8062	69	8454	81	8665	411, 877	8858	154	8971	846
6821	370, 377	6940	364, 369	8068	69	8455	81	8677	187	8861	154	8981	194

NUMERICAL INDEX

Auveco No.	Page No.	Auveco No.	Page No.	Auveco No.	Page No.	Auveco No.	Page No.	Auveco No.	Page No.	Auveco No.	Page No.	Auveco No.	Page No.
8983	194	9112	191	9247	834	9407	83	9572	76	9705	114	10058	270
8985	194	9114	191	9248	834	9408	83	9575	76	9709	114	10059	270
8987	194	9115	272	9249	834	9409	83	9576	76	9711	114	10064	174
8988	194	9118	82	9250	834	9410	83	9577	76	9712	114	10065	174
8989	194	9119	82	9251	834	9411	83	9578	76	9715	114	10066	174
8991	194	9120	82	9252	834	9412	83	9581	76	9727	114	10067	174
8992	194	9121	82	9257	283	9416	410	9582	76	9728	114	10068	87
8993	194	9122	82	9258	283	9417	410	9584	832	9729	114	10073	169
8994	194	9124	82	9259	283	9433	193	9585	832	9731	114	10080	631
8995	194	9125	82	9260	283	9435	193	9586	832	9732	114	10084	88, 89
8996	194	9126	82	9261	283	9436	193	9587	832	9739	114	10085	154
8997	194	9127	82	9262	283	9438	193	9588	832	9744	114	10086	154
8998	194	9128	82	9264	284	9440	193	9589	832	9745	114	10087	154
8999	194	9129	82	9265	284	9441	193	9590	832	9749	401	10090	549
9000	194	9130	82	9266	284	9443	193	9591	832	9756	88, 90	10101	200
9001	194	9131	82	9267	284	9444	193	9592	832	9757	88, 89	10102	200
9002	194	9132	82	9275	401	9446	193	9593	832	9759	196	10103	200
9003	194	9133	82	9278	287	9447	193	9594	832	9794	196	10104	200
9004	194	9134	82	9279	287	9477	566	9595	832	9795	196	10105	200
9005	194	9135	82	9282	287	9480	88, 89	9596	832	9796	196	10106	200
9006	194	9136	82	9283	287	9481	213	9597	832	9800	196	10107	200
9007	194	9137	82	9284	287	9482	79	9598	832	9801	196	10108	200
9008	194	9138	82	9285	287	9483	79	9599	833	9802	196	10109	200
9009	194	9139	82	9288	195	9484	79	9600	833	9814	414	10110	200
9010	194	9140	82	9289	195	9485	79	9601	833	9825	75	10116	187
9011	194	9141	82	9290	195	9486	79	9603	106, 108	9829	549	10117	187
9012	194	9142	82	9291	195	9487	79	9604	74	9846	154	10118	187
9013	194	9143	82	9292	195	9489	79	9605	74	9850	412, 555	10120	187
9015	194	9144	82	9293	195	9490	79	9606	74	9851	548	10121	187
9016	194	9145	82	9297	154	9491	79	9607	74	9853	86	10122	187
9017	194	9146	82	9298	154	9492	79	9608	74	9854	86	10123	187
9018	194	9147	82	9299	154	9493	79	9609	74	9855	86	10124	187
9019	194	9148	82	9300	153	9494	79	9610	74	9862	595	10125	187
9021	194	9149	82	9301	153	9498	79	9611	74	9863	91, 94	10126	187
9022	194	9150	82	9302	153	9499	79	9612	74	9864	270	10127	187
9023	194	9151	82	9303	153	9500	79	9613	74	9869	830	10128	187
9024	194	9152	82	9304	153	9501	79	9614	74	9877	91, 94, 412	10129	187
9025	194	9153	82	9305	153	9502	79	9615	74	9879	174	10130	189
9026	194	9154	82	9306	153	9507	79	9616	74	9880	174	10131	189
9027	194	9155	82	9307	153	9509	79	9617	74	9881	174	10132	189
9028	194	9156	82	9308	153	9510	79	9620	74	9882	402	10133	189
9029	194	9157	82	9309	153	9520	81	9625	172	9883	236, 244	10134	189
9030	194	9158	82	9310	153	9521	81	9630	181	9884	243	10135	189
9031	194	9159	82	9311	153	9522	81	9633	401	9885	243	10162	69
9033	194	9160	82	9312	153	9523	81	9637	274	9886	401	10163	69
9034	194	9161	82	9324	832	9524	81	9639	401	9890	193	10164	69
9035	194	9162	82	9342	413	9525	81	9643	293	9892	193	10165	69
9036	194	9163	82	9353	402	9526	81	9644	293	9894	191	10166	69
9037	194	9164	82	9354	87	9528	81	9647	293	9900	256	10167	69
9038	194	9165	82	9355	87	9529	81	9648	293	9901	256	10168	69
9039	194	9167	82	9356	87	9535	152	9667	114	9905	236, 253	10169	69
9040	194	9169	82	9357	833	9536	152	9668	114	9916	243	10170	69
9042	194	9170	82	9358	833	9537	152	9669	114	9948	227	10171	69
9043	194	9171	82	9361	409	9538	152	9670	114	9965	567, 824	10172	70
9044	194	9172	82	9367	586	9539	152	9673	114	9994	842	10173	70
9045	194	9174	82	9377	616, 764	9540	152	9674	114	10005	842	10174	70
9046	194	9177	82	9381	835	9541	152	9675	114	10006	842	10175	70
9048	194	9184	82	9382	835	9542	152	9676	114	10008	842	10176	70
9049	194	9186	82	9383	835	9543	152	9677	114	10009	842	10177	70
9050	194	9188	82	9384	835	9544	152	9679	114	10010	842	10178	70
9051	194	9191	82	9385	835	9545	152	9680	114	10011	842	10179	70
9052	204	9192	82	9386	835	9546	152	9681	114	10012	842	10180	71
9055	204	9193	82	9387	835	9547	152	9683	114	10013	842	10181	71
9056	204	9194	82	9388	835	9548	152	9684	114	10014	842	10182	71
9057	204	9199	82	9389	835	9555	76	9686	114	10018	842	10183	71
9058	204	9201	82	9391	835	9556	76	9687	114	10036	153	10184	390
9059	204	9203	82	9399	83	9557	76	9688	114	10048	176	10191	390
9060	204	9208	82	9400	83	9564	76	9689	114	10050	176	10192	390
9064	204	9210	82	9401	83	9565	76	9690	114	10051	176	10217	274
9065	205	9212	82	9402	83	9566	76	9695	114	10052	177	10218	274
9069	550	9219	82	9403	83	9568	76	9696	114	10053	176	10220	554
9091	75	9224	82	9404	83	9569	76	9699	114	10054	177	10221	832
9100	75	9229	91, 95	9405	83	9570	76	9701	114	10055	177	10222	257
9110	191	9246	834	9406	83	9571	76	9702	114	10057	270	10223	257

NUMERICAL INDEX

Auveco No.	Page No.	Auveco No.	Page No.	Auveco No.	Page No.	Auveco No.	Page No.	Auveco No.	Page No.	Auveco No.	Page No.	Auveco No.	Page No.
10231	195	10438	116	10575	138	10744	437, 475	11105	294, 305	11321	200	11502	147, 186
10232	195	10439	116	10576	138	10759	547	11106	294, 305	11324	159	11503	147, 186
10242	401	10440	116	10577	146	10760	616	11109	88, 90	11325	159	11505	147, 186
10243	401	10441	116	10578	146	10764	154	11110	88, 90	11326	159	11506	147, 186
10262	587, 614, 630, 634	10459	116	10579	146	10773	154	11118	566, 413	11327	159	11507	147, 186
10264	162	10460	116	10580	146	10780	409	11119	566, 413	11328	159	11513	147, 186
10265	162	10464	116	10581	146	10782	257	11120	416, 475	11331	159	11514	147, 186
10266	162	10478	116	10582	146	10783	257	11129	416, 475	11332	159	11515	147, 186
10267	162	10488	116	10583	146	10788	194, 830	11130	434, 475	11345	402	11516	147, 186
10268	162	10501	117	10584	146	10789	194, 830	11136	441, 475	11347	421, 475	11517	147, 186
10269	162	10502	117	10585	146	10790	194, 830	11138	554	11349	471, 475	11518	147, 186
10270	162	10504	117	10586	146	10791	194, 830	11146	425, 475	11350	433, 475	11519	147, 186
10271	162	10505	117	10587	146	10792	194, 830	11152	401, 402	11351	429, 475	11520	147, 186
10272	162	10506	117	10588	146	10793	194, 830	11154	237	11352	583	11521	147, 186
10273	162	10507	117	10589	146	10808	228	11156	237	11354	620	11523	147, 186
10274	162	10508	117	10590	146	10823	88, 89	11157	237, 253	11360	227	11527	147, 186
10275	162	10509	117	10591	146	10830	176	11166	236, 244	11361	227	11602	208
10276	162	10510	117	10592	146	10831	425, 475	11179	154	11362	227	11604	208
10277	162	10511	117	10593	146	10832	425, 475	11180	154	11363	227	11605	207
10278	162	10512	117	10595	146	10837	611	11181	154	11364	227	11606	207
10279	162	10513	117	10596	146	10843	400	11182	154	11365	227	11612	418, 475
10280	162	10514	117	10598	835	10845	119	11183	154	11366	227	11614	86
10282	162	10515	117	10599	835	10846	119	11184	154	11367	227	11615	86
10283	162	10516	117	10600	835	10848	119	11187	184	11368	112	11618	232
10284	162	10517	117	10601	835	10851	119	11220	201	11369	106, 109	11620	302
10285	162	10519	117	10602	835	10853	119	11224	201	11370	106, 110	11621	304
10286	162	10520	117	10603	835	10854	119	11226	201	11371	616	11625	145, 177
10288	162	10521	117	10604	835	10855	119	11228	200	11392	227	11626	145, 178
10289	162	10522	117	10605	835	10858	119	11229	200	11404	115,	11627	145, 179
10290	162	10523	117	10606	835	10859	119	11243	547		137, 821	11628	145, 179
10305	550,	10524	117	10607	835	10861	119	11244	547	11405	208	11629	145, 179
	595, 616	10525	117	10608	834	10863	119	11245	547	11406	409	11630	145, 179
10318	556	10526	117	10609	834	10864	119	11246	547	11419	199	11631	145, 179
10319	208, 213	10527	117	10610	834	10865	119	11255	119	11424	550	11633	122, 126
10322	808	10528	117	10611	834	10866	119	11257	119	11425	555	11638	122, 126
10330	549	10529	117	10612	834	10868	119	11259	119	11429	173	11639	122, 126
10332	428, 475	10530	117	10613	834	10870	119	11262	119	11434	257	11640	122, 127
10336	299	10532	117	10614	834	10872	119	11263	119	11435	257	11641	122, 127
10337	299	10534	117	10615	834	10873	119	11264	119	11436	243	11644	140
10345	299	10535	117	10617	555	10875	119	11265	119	11437	252, 254	11645	140
10346	299	10536	117	10621	471, 475	10878	119	11266	119	11438	254	11653	616
10351	299	10537	117	10622	402	10885	119	11267	119	11439	256	11654	616
10352	299	10538	117	10630	402	10898	119	11268	119	11440	242, 254	11655	548
10357	299	10539	117	10631	402	10960	119	11269	119	11441	236, 244	11656	548
10358	299	10540	117	10632	412	10961	119	11270	119	11442	243	11657	547
10359	299	10541	118	10642	91, 94	10970	119	11271	119	11443	243	11660	594
10362	88, 89	10542	118	10643	846	10972	119	11273	119	11444	242	11661	594
10364	94, 104	10543	118	10644	846	11006	120	11274	119	11445	252	11665	547
10365	552	10544	118	10649	273	11024	120	11275	119	11446	237	11667	548
10368	201	10545	118	10652	72	11032	120	11276	119	11448	72	11671	456, 475
10374	154	10546	118	10653	72	11049	138	11277	138	11449	72	11672	471, 475
10375	154	10547	118	10654	72	11051	138	11278	138	11450	72	11673	429, 475
10378	224	10548	118	10655	87	11053	138	11279	138	11451	72	11675	420, 475
10379	224	10549	118	10656	87	11055	138	11280	138	11452	72	11677	472, 475
10380	224	10550	118	10657	87	11057	138	11288	554	11453	72	11678	471, 475
10381	224	10551	118	10658	304	11059	138	11292	172	11454	72	11679	421, 475
10382	224	10553	149	10666	172	11061	88, 90	11293	169	11455	72	11680	418, 475
10384	224	10554	149	10697	198	11066	401	11294	73	11456	72	11691	550
10385	213	10556	149	10701	401	11067	401	11295	73	11457	72	11697	634
10386	213	10557	149	10714	94, 104	11083	229	11296	73	11467	229	11699	571, 506, 624, 534
10390	191	10558	149	10719	208	11084	69	11297	73	11470	547, 634	11702	491,
10391	192	10559	149	10720	208	11086	69	11298	399	11475	237		534, 606
10392	192	10560	149	10724	211	11087	69	11299	399	11476	237	11704	505,
10393	192	10562	149	10729	159	11088	69	11310	160	11485	412, 554		534, 624
10394	192	10564	149	10730	159	11089	69	11311	160	11486	147, 185	11705	500,
10395	192	10566	149	10731	159	11090	69	11312	160	11488	147, 185		534, 606
10396	192	10567	149	10732	159	11091	69	11313	160	11489	147, 185	11706	514,
10397	192	10568	149	10733	155	11092	69	11314	160	11490	147, 185		534, 606
10398	192	10569	138	10737	194, 830	11097	148, 285	11315	160	11491	147, 185	11708	139
10427	116	10570	138	10738	194, 830	11098	148, 285	11316	160	11492	147, 185	11709	139
10431	116	10571	138	10739	194, 830	11099	148, 285	11317	160	11494	147, 185	11717	555
10436	116	10572	138	10740	194, 830	11100	148, 285	11318	160	11495	147, 185	11718	547
10437	116	10573	138	10741	194, 830	11101	148, 285	11319	160	11500	147, 186	11719	112
		10574	138	10742	194, 830	11104	294, 305	11320	88, 90	11501	147, 186		

NUMERICAL INDEX

Auveco No.	Page No.	Auveco No.	Page No.	Auveco No.	Page No.	Auveco No.	Page No.	Auveco No.	Page No.	Auveco No.	Page No.	Auveco No.	Page No.
11721	417, 475	11877	149	12028	826	12144	205	12316	593	12442	226	12617	156
11729	229	11878	149	12029	826	12146	208	12322	121, 124	12443	226	12621	555
11733	193	11879	149	12030	827	12147	204	12323	121, 125	12444	226	12622	610
11736	193	11881	149	12031	827	12148	204	12324	121, 123	12445	226	12627	227
11738	198	11884	149	12032	827	12149	204	12327	122, 127	12447	226	12628	227
11740	152	11886	149	12034	827	12150	204	12335	121, 125	12448	226	12629	227
11741	152	11888	149	12035	827	12151	204	12336	122, 126	12470	616	12630	212
11742	152	11895	149	12036	827	12152	204	12339	94, 103, 130, 136	12472	70, 131, 850, 851	12631	212
11743	152	11896	149	12037	827	12153	204	12343	122, 127	12474	850	12635	808
11744	152	11899	149	12038	827	12154	207	12348	122, 127	12475	850	12637	822
11746	195	11904	74	12039	829	12155	207	12350	94, 104, 130, 137	12477	850	12642	757
11747	195	11905	74	12040	829	12156	207	12351	93, 102, 130, 136	12485	826	12652	315
11748	195	11906	74	12041	829	12157	207	12354	94, 103, 130, 136	12486	826	12653	303
11749	195	11908	74	12042	829	12158	208	12359	232	12487	826	12654	314
11761	851	11909	74	12044	829	12159	207	12361	274	12488	826	12655	303
11762	851	11910	74	12045	829	12160	121, 124	12363	232	12491	827	12656	306
11768	172	11911	74	12047	828	12161	207, 213	12366	73	12492	827	12657	312
11770	87	11912	74	12049	828	12162	204	12368	73	12517	80	12658	304
11771	87	11913	74	12050	828	12163	204	12369	73	12518	80	12666	145, 178
11774	471, 475	11914	74	12057	93, 102, 130, 135	12164	204	12376	73	12519	80	12667	145, 179
11775	148, 285	11915	74	12059	91, 96, 128, 131	12165	207	12377	164	12520	156, 157	12669	145, 178
11776	148, 285	11916	74	12060	92, 97, 128, 132	12171	844	12378	164	12521	156, 157	12671	410
11777	148, 285	11917	71	12061	91, 96, 128, 131	12172	844	12379	164	12522	156, 157	12675	156
11778	148, 285	11918	71	12062	91, 95, 128, 131	12173	844	12380	164	12523	156, 157	12676	316
11779	148, 285	11919	71	12064	121, 123	12177	844	12381	164	12524	156, 157	12682	831
11780	148, 285	11920	71	12065	121, 124	12184	843	12382	164	12525	156, 157	12683	831
11782	282	11921	71	12066	121, 125	12209	197, 399	12383	164	12528	293	12684	831
11783	282	11922	71	12067	121, 124	12210	197, 399	12384	164	12529	293	12685	831
11784	72	11923	71	12068	94, 103, 130, 136	12213	72, 91, 95	12385	164	12532	235	12686	831
11785	72	11924	71	12069	410	12214	72	12386	164	12533	235	12688	831
11786	72	11925	181	12076	269	12215	72	12387	165	12535	235	12689	831
11787	72	11926	181	12077	268	12216	72	12388	164	12536	235	12693	121, 124
11788	72	11927	181	12078	268	12217	72	12389	165	12537	235	12695	156
11789	72	11928	181	12079	232	12218	72	12390	165	12538	235	12697	152
11790	72	11929	181	12080	301	12228	594	12391	165	12539	235	12698	152
11791	72	11931	181	12081	301	12232	121, 123	12392	165	12540	235	12699	152
11792	72	11933	181	12084	301	12233	269	12394	163	12541	235	12700	152
11795	411	11935	122, 126	12085	301	12234	269	12395	163	12542	235	12701	152
11796	472, 475	11936	620	12086	301	12235	270	12396	163	12543	235	12703	152
11797	457, 475	11948	217	12088	301	12236	269	12397	163	12544	235	12704	152
11805	163	11949	70, 131, 850, 851	12089	301	12237	236, 244, 253	12399	163	12545	235	12705	152
11806	163	11950	70, 131, 850, 851	12092	301	12253	141	12400	163	12546	235	12707	152
11807	163	11953	274	12093	301	12254	140	12406	165	12547	235	12708	152
11808	163	11954	274	12098	301	12255	141	12407	165	12548	235	12709	152
11809	163	11955	274	12099	301	12259	141	12420	226	12549	235	12710	152
11810	163	11956	274	12103	70, 131, 850, 851	12260	141	12422	226	12550	235	12711	152
11811	163	11957	274	12104	70, 131, 850, 851	12265	176	12423	226	12551	235	12713	552, 618, 765
11812	163	11958	274	12105	70, 131, 850, 851	12266	826	12426	226	12552	235	12715	156
11813	163	11959	274	12115	141	12268	826	12427	226	12553	235	12717	152
11814	163	11961	274	12116	141	12269	826	12428	226	12554	235	12723	152
11815	163	11963	274	12117	141	12270	826	12429	226	12555	235	12729	582
11817	295	11973	115, 138	12118	141	12271	826	12430	226	12556	235	12731	429, 475
11826	547	11974	115, 138	12119	141	12272	826	12431	226	12563	555	12735	550, 616, 811
11827	207	11977	115, 138	12122	141	12273	826	12432	226	12565	455, 475	12737	472, 475
11828	207	11980	115, 138	12123	141	12274	826	12433	226	12566	553, 618	12738	92, 98, 128, 132
11829	207	11981	115, 138	12124	141	12276	826	12434	226	12567	571, 505, 625, 534	12739	91, 95, 128, 131
11830	207	11982	115, 138	12125	141	12277	826	12435	226	12569	595, 617	12740	91, 96, 128, 131
11831	582	11983	115, 138	12126	141	12278	826	12436	226	12571	429, 475	12741	91, 97, 128, 132
11838	549	11984	115, 138	12127	141	12279	826	12437	226	12575	145, 178	12742	92, 98, 128, 132
11841	596	11987	115, 138	12128	141	12280	826	12438	226	12576	658	12744	92, 98, 128, 132
11842	433, 475	11989	115, 138	12129	114	12281	826	12439	226	12577	741	12745	92, 98, 128, 132
11852	303	11990	115, 138	12130	114	12283	827	12440	226	12578	741	12746	92, 98, 128, 132
11853	295	11991	115, 138	12131	410	12284	827	12441	226	12579	741	12747	92, 98, 128, 132
11854	570, 492, 534	11993	115, 138	12132	410	12285	827	12442	226	12583	741	12748	92, 98, 128, 132
11855	550, 764	11995	115, 138	12133	410	12286	827	12443	226	12585	741	12749	92, 98, 128, 132
11863	409	11998	115, 138	12134	410	12288	827	12444	226	12587	741	12750	92, 98, 128, 132
11864	145, 178	12009	88, 90	12135	402	12290	827	12445	226	12589	741	12751	92, 98, 128, 132
11866	552, 595	12021	826	12136	402	12292	827	12446	226	12591	716	12752	92, 98, 128, 132
11865	552, 595	12022	826	12137	430, 475	12293	827	12447	226	12592	232	12753	92, 98, 128, 132
11871	548	12023	826	12138	430, 475	12295	827	12448	226	12594	555	12754	92, 98, 128, 132
11872	192	12024	826	12139	430, 475	12303	828	12449	226	12595	139, 821	12755	92, 98, 128, 132
11873	192	12025	826	12140	430, 475	12305	828	12450	226	12596	139	12756	92, 98, 128, 132
11874	192	12026	826	12141	430, 475	12303	828	12451	226	12598	253	12757	92, 98, 128, 132
11876	149	12027	826	12142	430, 475	12305	828	12452	226	12599	253	12758	92, 98, 128, 132
				12143	430, 475	12314	593	12453	226	12600	238, 253	12759	92, 98, 128, 132
				12144	205	12315	593	12454	226	12602	555	12760	92, 98, 128, 132
				12145	205			12455	226	12605	548	12766	430, 475
				12146	208			12456	226	12606	612	12771	181
				12147	204			12457	226			12772	181
				12148	204			12458	226			12773	181
				12149	204			12459	226				
				12150	204			12460	226				
				12151	204			12461	226				
				12152	204			12462	226				
				12153	204			12463	226				
				12154	207			12464	226				
				12155	207			12465	226				
				12156	207			12466	226				
				12157	207			12467	226				
				12158	208			12468	226				
				12159	207			12469	226				
				12160	121, 124			12470	226				

NUMERICAL INDEX

Auveco No.	Page No.	Auveco No.	Page No.	Auveco No.	Page No.	Auveco No.	Page No.	Auveco No.	Page No.	Auveco No.	Page No.	Auveco No.	Page No.
12774	181	12932	199	13031	821	13232	88,	13328	83	13445	234	13614	122, 127
12775	181	12933	199	13039	316		89, 167	13329	83	13446	234	13616	620
12776	181	12934	197	13040	316	13233	253	13330	83	13447	234	13617	121, 124
12777	181	12935	197	13041	316	13234	85	13331	83	13449	234	13618	122, 126
12778	181	12936	197	13042	316	13235	85	13332	83	13450	549	13619	122, 127
12779	181	12937	197	13043	316	13236	85	13333	83	13453	471, 475	13620	128
12781	181	12938	197	13044	316	13237	85	13334	83	13454	421, 475	13625	848
12782	181	12939	199	13045	316	13239	85	13335	83	13456	580	13626	848
12783	181	12940	199	13046	316	13240	85	13336	83	13457	568,	13629	269
12784	181	12943	199	13047	316	13241	85	13337	83		505, 534	13630	268
12785	181	12944	199	13048	316	13242	85	13338	83	13458	556	13631	268
12786	181	12946	197	13049	316	13243	85	13339	83	13461	471, 475	13632	268
12787	181	12947	199	13050	316	13244	85	13340	83	13464	765	13634	257
12788	181	12948	199	13051	316	13245	85	13341	83	13466	112, 616	13636	257
12789	181	12949	199	13052	316	13246	85	13342	83	13467	435, 475	13639	257
12790	181	12950	72	13053	316	13248	85	13343	83	13469	513,	13643	257
12791	207, 213	12951	72	13054	316	13249	85	13344	83		534, 606	13644	252
12792	207, 213	12952	72	13055	316	13251	85	13345	83	13470	455, 476	13647	617
12794	620	12953	72	13056	316	13252	85	13346	84	13472	613, 634	13656	209
12795	69	12954	72	13057	316	13253	85	13347	84	13475	471, 476,	13657	209
12796	69	12955	72	13058	316	13256	84	13348	84		768, 815	13658	209
12797	69	12956	72	13059	316	13258	84	13349	84	13476	160	13659	209
12798	69	12957	72	13060	316	13260	85	13350	84	13477	160	13660	209
12799	71	12958	824	13061	316	13261	85	13352	84	13480	160	13661	209
12800	71	12959	824	13062	316	13262	85	13353	84	13481	160	13662	209
12801	70	12960	824	13063	316	13263	85	13354	84	13494	160	13663	209
12802	70	12961	824	13064	316	13264	85	13355	84	13495	160	13664	209
12803	70	12962	824	13065	316	13265	83	13356	84	13514	269	13665	209
12806	70	12966	567, 824	13065	316	13266	83	13357	84	13520	270	13666	209
12807	70	12971	567, 824	13095	316	13267	83	13359	84	13521	270	13669	209
12809	70	12975	228	13120	316	13268	83	13360	84	13522	270	13670	209
12811	70	12977	232	13121	316	13269	83	13361	84	13523	269	13671	209
12818	72	12978	160	13124	316	13270	83	13362	84	13524	269	13672	209
12820	72	12979	160	13128	316	13271	83	13363	84	13528	269	13673	209
12824	555	12980	160	13132	316	13272	83	13364	84	13529	269	13674	209
12832	842	12981	160	13133	316	13273	83	13365	84	13530	269	13675	209
12833	842	12982	160	13134	316	13274	83	13366	84	13531	269	13676	209
12851	842	12983	160	13136	316	13275	83	13367	84	13533	244	13677	209
12852	842	12984	160	13141	727	13276	83	13368	84	13535	244	13678	209
12858	842	12985	160	13144	728	13277	83	13370	84	13537	244	13679	209
12859	842	12986	160	13157	728	13278	83	13373	84	13540	236	13680	209
12860	842	12987	160	13158	650	13279	83	13374	84	13541	253	13681	209
12861	842	12988	163	13162	143, 657	13280	83	13375	84	13542	253	13682	209
12870	842	12989	163	13167	652	13281	83	13377	84	13543	238	13683	211
12890	842	12990	163	13170	651	13282	83	13391	84	13544	237	13684	211
12893	69	12991	163	13173	810, 822	13283	83	13392	85	13545	238	13685	211
12894	69	12992	472, 475	13174	808	13284	83	13393	85	13546	238	13686	233
12895	69	12993	418,	13179	470, 475,	13286	83	13394	85	13547	243	13687	91, 97
12896	69		475, 766		653, 816	13288	83	13395	85	13548	243	13691	183
12897	69	12995	167	13189	808	13289	83	13396	85	13549	236	13692	183
12899	70	12996	167	13191	822	13290	83	13397	85	13552	268	13693	183
12900	70	12997	167	13198	421,	13291	83	13398	85	13554	256	13694	183
12902	71	12999	167		475, 657	13292	83	13401	85	13555	268	13695	183
12903	71	13002	168	13206	812	13293	83	13402	85	13556	269	13696	183
12904	71	13003	168	13215	142,	13294	83	13403	85	13558	236	13697	183
12905	71	13004	168		656, 733	13298	83	13404	85	13559	256	13698	183
12907	197, 399	13005	168	13216	142, 656,	13299	83	13405	85	13564	403	13699	183
12908	197, 399	13006	168		733, 757,	13300	83	13406	85	13572	849	13701	183
12909	431, 475	13007	168		770, 820	13301	83	13409	84	13574	847	13704	122, 126
12916	198	13008	168	13218	142,	13302	83	13410	84	13575	848	13705	122, 127
12917	198	13009	168		656, 733	13304	83	13411	84	13577	856	13707	91, 94
12918	198	13010	168	13220	144, 733,	13306	83	13412	84	13578	848	13708	91, 95
12919	198	13011	168		757, 823	13308	83	13413	84	13579	849	13709	93, 100
12920	198	13012	167	13221	142, 656	13310	83	13414	84	13580	829	13711	91, 97
12921	198	13014	167	13223	142,	13311	83	13415	84	13581	830	13712	91, 96,
12922	198	13016	167		656, 732	13312	83	13417	84	13582	830		128, 131
12923	198	13017	167	13224	142, 732	13314	83	13420	84	13584	830	13715	121, 124
12924	198	13019	93, 102,	13225	142, 681,	13316	83	13421	84	13587	830	13717	180, 412
12925	198		130, 135		739, 757, 808	13322	83	13422	84	13590	829	13718	180, 412
12926	198	13021	93, 102	13227	141, 812	13323	83	13424	84	13599	829	13719	180, 412
12927	199	13025	91, 95	13230	490, 534,	13324	83	13426	84	13600	829	13720	180, 412
12929	197	13026	92, 97		730, 823	13325	83	13429	84	13601	829	13721	180, 412
12930	197	13027	92, 99	13231	88,	13326	83	13430	84	13610	829	13723	180, 412
12931	197	13030	616		89, 167	13327	83	13434	84	13613	122, 126	13724	180, 412

NUMERICAL INDEX

Auveco No.	Page No.	Auveco No.	Page No.	Auveco No.	Page No.	Auveco No.	Page No.	Auveco No.	Page No.	Auveco No.	Page No.	Auveco No.	Page No.
13725	180, 412	13896	183	14019	529, 535,	14205	845	14337	755	14435	117	14583	117
13727	73	13897	183		609, 628	14206	845	14345	755	14436	117	14584	117
13728	73	13898	183	14020	577, 529,	14207	845	14347	447, 476,	14437	118	14585	117
13746	297	13899	183		609, 535	14208	845		748, 792	14438	118	14586	117
13747	297	13900	183	14021	416, 476	14209	822	14348	444,	14439	118	14587	117
13748	297	13902	183	14023	297	14210	822		476, 748	14440	118	14588	117
13749	297	13903	183	14030	550, 811	14211	822	14349	442, 476,	14441	118	14589	117
13750	298	13904	183	14031	550	14212	822		719, 747	14442	118	14590	118
13751	298	13905	183	14032	424, 476	14217	582,	14352	443,	14443	118	14591	118
13752	298	13906	183	14033	556		610, 634		476, 747	14444	118	14592	118
13753	298	13907	183	14035	424, 476	14218	618	14353	447,	14445	118	14595	118
13754	297	13908	183	14036	424, 476	14220	552		476, 748	14446	118	14598	118
13755	297	13909	183	14037	552, 618	14225	156	14355	442,	14447	118	14602	118
13756	296	13910	183	14053	70,	14227	156		476, 747	14448	138	14604	119
13757	435, 476	13911	183		129, 130	14228	156	14356	448,	14449	138	14605	119
13766	300	13912	183	14055	232	14231	156		476, 748	14450	138	14606	119
13767	300	13913	183	14059	190	14235	156	14357	717	14451	138	14607	119
13768	300	13914	183	14060	190	14237	156	14359	724	14452	138	14608	119
13769	300	13916	183	14063	190	14241	156	14363	470,	14453	138	14610	119
13770	300	13918	183	14064	190	14244	156		476, 721	14454	138	14611	119
13773	301	13919	183	14065	190	14253	156	14364	717	14455	138	14612	119
13774	301	13920	183	14066	190	14255	665,	14365	724	14456	138	14613	119
13796	300	13921	183	14067	190		717, 735	14366	717, 743	14457	138	14616	119
13805	299	13922	105, 110	14068	190	14256	785	14367	415,	14458	138	14617	119
13807	299	13925	554	14070	190	14258	785		476, 719	14459	138	14625	138
13808	296	13927	620	14072	190	14260	568, 498,	14369	515,	14461	846	14626	138
13810	229	13930	717, 742	14074	190		535, 722, 801		535, 723	14462	215	14629	138
13811	229	13931	742	14089	191	14263	786	14376	272, 725	14473	105, 108	14632	146
13814	229	13932	736, 785	14094	191	14264	781	14378	724	14474	208, 234	14633	146
13816	229	13933	550	14095	191	14265	786	14380	448,	14486	303	14634	146
13828	556	13934	105, 111	14096	191	14266	788		476, 720	14487	80	14636	146
13831	70, 412	13937	270	14097	191	14267	706, 789	14388	270	14489	80	14637	146
13832	70, 412	13939	270	14098	191	14268	667, 787	14389	230	14490	80	14642	555
13833	70, 412	13944	270	14099	191	14269	464, 476,	14391	116	14491	80	14677	278
13834	70, 412	13945	471,	14100	191		694, 721, 799	14392	116	14493	80	14678	280
13835	70, 412		476, 751	14101	191	14270	465,	14393	116	14494	80	14685	663
13836	70, 412	13946	472, 476	14102	191		476, 799	14394	116	14495	80	14687	680
13837	70, 412	13960	550	14103	191	14271	785	14395	116	14496	80	14688	680
13838	70, 412	13964	169	14104	191	14273	706, 789	14396	116	14497	80	14690	666, 745
13839	70, 412	13965	169	14113	190	14274	666, 717,	14398	116	14498	80	14695	667, 717,
13840	70, 412	13966	170, 765	14127	311		742, 785	14400	117	14499	80		736, 743, 787
13841	70, 412	13967	395	14128	244	14275	736,	14401	117	14500	80	14696	498, 535,
13842	70, 412	13992	472, 476	14130	245		744, 787	14402	117	14501	80		678, 694, 752
13843	620	13993	573, 506,	14131	244	14276	144, 808	14403	117	14521	139	14697	568, 496,
13847	620		607, 626, 534	14132	244	14277	786	14404	117	14522	139		535, 678, 722
13850	227	13994	577, 529,	14133	244	14281	667, 787	14405	117	14523	139	14698	508,
13851	227		609, 534	14135	244	14282	443,	14406	117	14524	472, 476		535, 678
13856	580	13996	574,	14144	465,		476, 668	14407	117	14526	175	14700	664
13858	582		506, 534		476, 799	14284	272,	14408	117	14527	175	14701	663
13860	580	13999	572,	14145	550		680, 806	14409	117	14529	271	14703	664
13863	195		490, 534	14147	577,	14287	665	14410	117	14530	271	14705	664
13864	195	14001	568,		529, 535	14288	665	14411	117	14531	271	14709	420,
13865	195		504, 534	14150	215	14289	418,	14412	117	14532	271		476, 720
13866	195	14002	549	14151	215		476, 669	14413	117	14533	271	14719	716
13867	195	14004	297	14152	215	14291	442,	14414	117	14541	845	14720	448,
13869	195	14005	297	14153	216		476, 668	14415	117	14543	848		476, 737
13871	195	14006	417, 476	14154	216	14294	665	14417	117	14544	581, 271	14723	447,
13872	195	14007	571, 505,	14163	434, 476	14298	272,	14418	117	14545	581, 271		476, 748
13873	195		625, 534	14170	844		680, 725	14419	117	14546	581, 271	14724	743
13875	195	14008	567,	14171	844	14299	436,	14420	117	14547	581, 271	14725	532,
13876	195		533, 534	14172	844		476, 673	14421	117	14548	592		535, 755
13877	195	14009	552	14173	844	14306	659	14422	117	14549	592	14726	505,
13879	195	14010	571, 528,	14174	844	14308	659	14423	117	14550	592, 615		535, 752
13880	195		625, 534	14178	844	14313	666,	14424	117	14551	615	14727	567, 532,
13881	195	14011	571,	14194	821		717, 742	14425	117	14552	632		535, 694, 755
13883	195		504, 534	14196	276	14317	665	14426	117	14553	593	14728	464,
13885	195	14012	297	14197	225	14319	448,	14427	117	14559	591		476, 797
13887	195		550, 811	14198	225		476, 671	14428	117	14561	633	14732	805
13888	183	14014	572, 490,	14199	225	14323	447,	14429	117	14568	274	14736	444,
13891	183		625, 534	14200	225		476, 671	14430	117	14575	848		476, 792
13892	183	14016	418, 476	14201	225	14328	436,	14431	117	14576	848	14737	443, 476,
13893	183		512,	14202	225		476, 673	14432	117	14580	241		748, 791
13894	183	14018	534, 608	14203	225	14334	742	14433	117	14581	117	14738	446,
13895	183			14204	225	14335	736, 743	14434	117	14582	117		476, 794

NUMERICAL INDEX

Auveco No.	Page No.	Auveco No.	Page No.	Auveco No.	Page No.	Auveco No.	Page No.	Auveco No.	Page No.	Auveco No.	Page No.	Auveco No.	Page No.
14739	694, 785	14866	146	14991	570, 506,	15100	283	15200	274	15403	78	15586	153
14745	784	14867	146		605, 535	15101	283	15202	274	15404	78	15587	153
14746	784	14868	146	14992	500, 535,	15102	283	15203	274	15413	105, 110	15588	153
14747	784	14869	146		604, 624	15103	283	15204	224	15414	425, 477	15589	153
14749	784	14870	146	14993	506,	15104	283	15205	224	15415	283	15590	153
14750	143,	14871	146		535, 570	15106	283	15206	224	15416	283	15591	153
	725, 807	14873	154	14994	529,	15107	283	15207	224	15417	283	15592	153
14751	784	14874	154		535, 606	15108	283	15208	224	15418	283	15594	153
14753	570, 506,	14875	154	14995	569, 495,	15109	283	15209	224	15420	283	15595	153
	605, 624, 535	14876	154		604, 623, 535	15110	283	15212	846	15422	284	15596	153
14754	595	14877	154	14997	569,	15111	283	15239	226	15423	284	15597	153
14755	595	14878	154		500, 535	15114	284	15240	226	15424	284	15598	153
14756	595, 617	14879	181	14998	570,	15115	284	15256	226	15426	148, 285	15599	153
14757	422, 476	14880	218		524, 535	15116	284	15257	226	15431	148, 285	15601	153
14758	473, 476	14881	218	15000	283	15117	284	15258	226	15434	148, 285	15603	228
14765	390	14883	217	15004	157	15118	284	15259	226	15439	283	15605	228
14769	853	14884	222	15009	157	15119	284	15260	226	15440	283	15606	228
14770	853	14885	222	15010	157	15120	284	15263	226	15444	284	15607	228
14774	337	14887	220	15011	157	15121	284	15301	546, 848	15446	284	15608	228
14775	337	14888	220	15015	157	15122	148, 285	15316	139	15450	283	15609	228
14777	118	14889	220	15017	158	15123	148, 285	15318	139	15453	396	15610	228
14778	118	14892	221	15018	158	15124	148, 285	15325	139	15456	433, 477	15611	228
14779	118	14895	613	15035	222	15125	148, 285	15326	139	15457	433, 477	15618	228
14780	118	14896	213	15037	91, 95	15126	148, 285	15327	139	15459	586	15619	228
14781	118	14897	213	15039	230	15127	148, 285	15328	139	15461	471, 477	15620	228
14782	118	14898	207, 213	15040	423, 476	15128	148, 285	15329	139	15462	403	15621	228
14784	118	14901	193	15042	578,	15129	148, 285	15330	139	15463	403	15622	228
14787	118	14903	193		530, 535	15130	148, 285	15331	139	15466	403	15625	228
14788	118	14904	193	15043	577,	15131	148, 285	15332	139	15467	404	15628	228
14789	118	14905	193		526, 535	15132	148, 285	15333	139	15468	741	15632	228
14790	118	14906	193	15044	578,	15133	148, 285	15334	139	15470	742	15640	153
14791	118	14907	193		530, 536	15134	148, 285	15335	139	15472	664	15641	153
14792	118	14908	193	15045	578,	15135	148, 285	15337	139	15478	430, 477	15642	153
14793	118	14909	193		530, 536	15136	148, 285	15345	155	15479	431, 477	15643	153
14794	118	14910	193	15046	230	15137	148, 285	15347	155	15480	429, 477	15644	153
14796	138	14911	193	15048	230	15138	148, 285	15350	155	15481	428, 477	15645	153
14797	138	14912	193	15049	230	15139	148, 285	15351	155	15488	297	15646	153
14799	295	14913	70, 131,	15050	420, 477	15140	148, 285	15355	73	15490	298	15649	153
14801	202, 844		850, 851	15054	283	15141	148, 285	15356	73	15491	298	15650	153
14802	202, 844	14916	70, 131,	15055	283	15142	148, 285	15357	73	15497	217	15651	153
14803	202, 844		850, 851	15056	283	15143	148, 285	15358	73	15498	217	15652	153
14804	202, 844	14918	238,	15057	284	15144	274	15366	603, 724	15499	217	15653	153
14805	202, 844		245, 255	15058	284	15145	274	15367	420, 477	15504	221	15654	153
14807	202, 844	14920	213	15059	284	15146	274	15372	226	15505	235	15664	425, 477
14808	202, 844	14921	416, 476	15060	284	15147	274	15373	92, 98,	15506	235	15666	634, 808
14813	200	14923	195	15061	284	15148	274		128, 132,	15507	235	15668	434, 477
14814	172	14926	845	15062	284	15150	274	15374	78	15508	235	15669	471, 477
14820	584, 612	14927	845	15065	283	15151	274	15375	78	15509	235	15670	472, 477
14822	172	14946	554	15066	284	15158	212	15376	78	15512	117	15672	505,
14824	114	14947	121,	15067	148, 285	15159	212	15377	78	15514	117		536, 624
14827	114		125, 167	15068	283	15160	212	15378	78	15515	118	15673	587, 630
14830	414	14953	567, 532,	15069	283	15161	212	15379	78	15516	118	15674	587, 630
14833	414		603, 535	15072	283	15162	212	15380	78	15517	118	15675	614
14834	414	14967	587, 614,	15073	283	15163	212	15381	78	15518	588	15676	549
14835	414		630, 634	15074	283	15164	212	15382	78	15522	503,	15677	176
14836	274	14968	582	15075	283	15165	212	15383	78		536, 607	15684	303
14837	274	14970	72	15076	283	15166	212	15385	78	15523	428, 477	15687	414
14838	274	14972	72	15077	283	15167	212	15386	78	15525	834	15688	286
14839	274	14973	72	15078	284	15168	212	15387	78	15526	834	15689	286
14840	274	14974	229	15079	284	15170	106, 109	15388	78	15527	277	15691	286, 855
14847	181	14975	229	15080	284	15171	91, 96	15389	78	15528	281	15692	286, 855
14848	181	14976	88,	15082	284	15172	91, 95	15390	78	15529	281	15694	286
14850	181		89, 167	15083	284	15180	80	15391	78	15530	281	15695	558, 779
14851	181	14977	88,	15084	284	15187	297, 309	15392	78	15531	337	15701	528,
14852	181		89, 167	15085	284	15188	274	15393	78	15532	337		536, 609
14854	181	14980	141	15086	284	15189	274	15394	78	15533	337	15702	577,
14855	140	14985	436,	15087	284	15190	274	15395	78	15538	203		529, 536
14856	140		476, 629	15088	284	15191	274	15396	78	15539	203	15705	224
14857	418, 476	14987	569, 493,	15089	284	15192	274	15397	78	15540	203	15706	224
14858	630		623, 535	15094	283	15194	274	15398	78	15541	203	15707	465,
14859	72	14988	493,	15096	284	15196	274	15399	78	15542	203		477, 799
14860	72		535, 604	15097	284	15197	274	15400	78	15543	426, 477	15709	464,
14861	72	14990	569,	15098	148, 285	15198	274	15401	78	15544	163		477, 799
14862	72		492, 535	15099	148, 285	15199	274	15402	78	15545	86	15711	141

NUMERICAL INDEX

Auveco No.	Page No.	Auveco No.	Page No.	Auveco No.	Page No.	Auveco No.	Page No.	Auveco No.	Page No.	Auveco No.	Page No.	Auveco No.	Page No.
15721	91, 96, 128, 131	15898	79	16032	294	16204	843	16369	77	16617	138	16720	91, 97, 128, 132
15748	853	15903	79	16033	74	16205	843	16370	77	16622	575, 512, 536	16721	180
15752	174	15905	79	16034	74	16207	843	16371	77	16624	573, 505, 536	16725	532, 536, 755
15753	274	15910	79	16035	74	16213	546	16372	77	16625	576, 522, 536	16726	510, 536, 608
15754	274	15911	181	16036	74	16236	168	16375	77	16626	387	16727	192
15755	274	15912	181	16037	74	16237	168	16376	77	16629	387	16736	69, 74
15758	106, 107	15913	181	16038	74	16240	168	16377	77	16631	387	16743	187
15759	588	15914	181	16039	74	16242	168	16378	77	16632	387	16744	187
15764	387	15915	181	16040	74	16244	168	16380	77	16633	387	16745	187
15765	387	15916	181	16041	74	16248	168	16381	77	16634	387	16746	187
15766	387	15917	181	16042	74	16251	168	16382	77	16635	387	16747	187
15767	387	15918	181, 275	16043	74	16252	168	16383	77	16636	387	16748	187
15768	387	15919	181, 275	16044	74	16253	168	16384	77	16638	387	16751	120
15769	387	15921	216	16045	201	16255	168	16385	77	16640	387	16754	120, 122
15770	387	15922	216	16046	201	16256	168	16386	77	16642	387	16755	120, 122
15771	387	15924	217	16049	201	16259	425, 477	16387	77	16643	387	16761	120, 122
15772	387	15926	233	16051	201	16260	471, 477	16389	77	16644	387	16762	120, 122
15773	387	15927	233	16052	201	16261	472, 477	16390	392	16645	387	16763	146
15774	91, 96	15928	233	16066	201	16262	430, 477	16391	393	16646	387	16764	146
15775	92, 98, 129, 133	15929	233	16067	201	16263	430, 477	16392	392	16647	387	16766	834
15776	93, 102, 130, 135	15930	233	16070	201	16264	197, 399	16393	393	16648	387	16767	834
15778	121, 124	15931	233	16071	201	16265	572, 528, 536	16394	393	16649	387	16769	140
15779	121, 125	15932	233	16072	201	16267	174	16395	392	16650	387	16770	155
15780	122, 127	15933	233	16087	843	16268	139, 821	16399	594	16654	201	16771	155
15783	88, 90	15935	217	16088	843	16269	140	16407	78	16665	231	16774	139
15788	121, 124	15937	215	16089	843	16275	286, 855	16411	78	16666	856	16775	426, 477, 670, 749
15790	122, 126	15938	219	16090	843	16276	286, 855	16412	78	16669	111	16776	422, 477, 670, 749
15791	121, 123	15939	219	16091	843	16277	286, 855	16413	78	16670	111	16777	447, 477, 720, 792
15792	88, 90	15940	594	16092	843	16279	286, 855	16414	78	16671	806	16778	470, 477, 721, 795
15793	841	15941	91, 95, 128, 131	16093	843	16280	286, 855	16419	414	16675	182	16779	448, 477, 671, 793
15794	841	15944	219	16094	843	16286	856	16420	225	16676	182	16780	755, 805
15795	841	15945	220	16095	843	16288	856	16421	106, 107	16677	182	16781	444, 477, 669, 792
15796	841	15946	218	16096	843	16293	856	16422	106, 107	16678	182	16782	520, 536, 677, 753
15798	841	15947	218	16097	843	16294	845	16454	389	16681	275	16783	493, 536, 751
15799	842	15948	215	16108	843	16296	845	16455	389	16682	275	16784	508, 536, 752, 802
15800	841	15949	214	16115	532, 536, 655	16299	845	16456	389	16683	275	16785	160
15801	841	15950	214	16124	141, 728	16303	845	16457	389	16684	275	16788	161
15803	842	15951	214	16132	426, 477, 823	16306	806	16458	389	16685	275	16789	161
15805	842	15952	214	16134	141, 823	16308	279	16470	140, 681	16686	275	16791	295
15807	120, 121	15953	214	16322	145, 178	16322	145, 178	16478	91, 96	16687	308	16793	295
15813	401, 634	15954	214	16136	139	16323	106, 108	16484	205	16688	307	16793	120
15818	122, 125	15955	216	16142	142	16324	388	16485	205	16689	308	16794	120
15827	92, 99	15956	216	16149	75	16325	388	16486	206	16690	111	16795	120
15851	271	15957	216	16152	75	16326	388	16487	204	16691	778	16799	120
15854	270	15960	217	16159	165	16327	388	16488	204	16693	240	16800	111, 783
15858	227	15962	93, 102, 130, 135	16161	165	16328	388	16489	204	16694	239	16801	221
15860	834	15966	594	16162	165	16328	388	16489	204	16695	458, 477	16804	221
15861	834	15968	594	16163	163	16330	388	16506	840	16697	117	16806	218
15862	834	15968	594	16164	163	16331	388	16514	240	16698	117	16816	572, 497, 536
15863	152	15970	472, 477	16165	163	16332	388	16525	393	16699	117	16818	423, 477
15864	152	15973	295	16166	854	16333	388	16527	230	16700	117	16821	784
15865	152	15977	659	16169	854	16335	388	16534	92, 97	16701	117	16822	665
15867	116	15997	659	16174	238, 245, 254, 255	16336	388	16564	843	16702	117	16826	105, 108, 121, 124
15868	116	15998	432, 477, 670	16175	239, 245, 254, 255	16340	401, 756	16565	843	16703	117	16828	93, 103, 130, 136
15869	116	16000	516, 536, 679, 723, 753	16177	161	16341	163	16567	843	16704	117	16829	141
15870	116	16001	274	16178	161	16342	220	16568	843	16705	117	16830	140
15871	116	16004	223	16178	161	16344	220	16571	841	16706	117	16832	396
15872	116	16009	180, 411	16179	161	16348	220	16575	230	16707	117	16833	783
15873	116	16011	180, 411	16180	161	16349	221	16578	230	16708	117	16834	307
15874	116	16012	180, 411	16180	161	16351	235	16585	238	16709	117		
15875	116	16012	180, 411	16182	161	16352	235	16586	238	16710	117		
15876	116	16012	180, 411	16183	161	16353	235	16589	93, 100, 129, 134	16711	117		
15877	116	16013	180, 411	16184	161	16354	235	16593	180, 411	16712	117		
15878	116	16015	180, 411	16187	161	16355	235	16596	91, 95, 128, 131	16713	117		
15879	116	16016	180, 411	16188	161	16356	235	16603	832	16714	118		
15880	116	16017	471, 477	16189	161	16357	235	16604	832	16715	118		
15881	116	16018	182	16190	161	16358	235	16609	118	16716	118		
15882	116	16019	182	16192	161	16359	235	16610	118	16717	118		
15883	116	16020	182	16193	161	16360	235	16611	118	16718	118		
15884	116	16021	182	16194	161	16362	77	16612	118				
15889	116	16022	182	16195	161	16363	77	16613	118				
15893	116	16023	182	16198	843	16364	77	16614	118				
15895	116	16026	275	16200	843	16365	77						
15896	116	16031	294	16202	843	16368	77						

NUMERICAL INDEX

Auveco No.	Page No.	Auveco No.	Page No.	Auveco No.	Page No.	Auveco No.	Page No.	Auveco No.	Page No.	Auveco No.	Page No.	Auveco No.	Page No.
16835	570, 524, 624, 536	16937	593	17049	206	17175	237	17341	404	17442	661	17555	148, 285
16837	302	16938	457, 477	17052	206	17176	404	17342	743	17443	659	17558	106, 107
16838	304	16939	314	17057	512,	17188	120	17347	518,	17450	603, 724	17559	115, 137
16842	145, 178	16940	312		536, 678	17189	120		537, 754	17451	599, 718	17560	115, 137
16843	533, 536, 724, 755	16941	581, 271	17058	665	17190	120	17348	741	17452	443,	17561	80
16846	145, 178	16942	784	17060	603, 724	17191	120	17349	741		478, 747	17562	80
16849	396	16949	680	17064	620	17192	509,	17350	520, 537,	17453	419,	17563	80
16850	396	16950	680	17069	587		537, 675		679, 754		478, 719	17564	80
16851	154	16951	778	17072	436, 477	17193	143, 756	17351	504,	17455	404	17565	80
16852	154	16953	580	17073	405	17194	778		537, 738	17459	92, 100,	17566	80
16858	522, 536, 606, 699, 723, 753	16954	611	17075	457, 477	17195	597, 620,	17353	156		129, 133	17567	80
16859	569, 497, 536, 751	16955	275	17076	427,		658, 694, 735	17354	618	17460	92, 97	17568	80
16860	739	16956	275		477, 694	17196	745	17355	402, 694	17461	93, 101,	17569	80
16863	434, 477	16959	405	17080	531,	17198	241	17356	583		130, 135	17570	80
16864	309	16960	106, 109		536, 625	17199	241	17358	381	17462	207	17571	80
16865	566, 413	16961	200	17081	508,	17205	447,	17359	381	17463	242	17573	80
16868	833	16962	241		536, 678		477, 671	17360	213	17464	227	17574	80
16869	833	16964	241	17084	154	17206	499,	17361	834	17465	227	17575	80
16870	833	16965	241	17085	203		537, 801	17362	834	17466	312	17576	80
16871	833	16966	256	17086	832	17207	195	17363	834	17467	305	17577	80
16872	833	16967	239	17087	835	17208	195	17364	834	17468	298, 308	17578	80
16873	833	16968	242, 250,	17088	849	17214	569, 493,	17365	834	17469	305	17579	80
16874	833		254, 255, 256	17091	110		623, 537	17366	834	17470	305	17580	80
16875	833	16969	227	17092	472, 477	17215	434, 477	17367	834	17471	300	17582	80
16876	833	16970	227	17093	852	17216	576, 522,	17368	834	17472	522, 537,	17584	80
16877	833	16971	227	17094	182		608, 627, 537	17378	525,		739, 754	17586	168
16878	833	16972	227	17095	182	17218	455, 477		537, 754	17478	497, 537,	17588	835
16879	833	16973	227	17096	662	17219	556	17379	516,		607, 722	17589	835
16880	140	16974	227	17098	106, 107	17220	297		537, 679	17481	780	17596	115, 137
16883	139	16975	227	17101	298	17222	572, 500,	17381	433, 478	17490	211	17597	258
16889	71	16976	227	17102	455, 477		607, 537	17382	585	17491	211	17598	249
16890	393	16977	227	17103	573, 500,	17224	785	17383	570, 492,	17492	211	17599	474, 478
16891	393	16978	161		607, 536	17226	573,		537, 777, 800	17493	208	17602	602
16892	393	16980	141	17104	533,		501, 537	17385	143, 757	17494	208	17604	388
16893	125	16981	153		536, 624	17227	570,	17387	120	17495	140	17605	388
16894	546, 855	16983	153	17106	572,		490, 537	17388	120	17496	297	17606	388
16896	260	16985	86		495, 536	17228	110	17389	120	17499	82	17607	388
16897	260	16986	87, 137	17107	241	17230	551	17390	120	17508	585	17608	644
16898	260	16988	299	17108	236	17233	567	17391	138	17509	399	17609	666
16899	258	16989	299	17109	240	17237	435,	17392	138	17510	399	17611	805
16901	258	16996	275	17110	240		477, 749	17393	146	17513	399	17612	426, 478
16902	258	16997	91, 94	17111	240	17238	165	17394	146	17514	399	17615	306
16904	258	17000	547	17112	239	17239	165	17395	146	17515	164	17616	531,
16905	258	17002	216	17113	240	17241	165	17396	146	17516	164		537, 578
16906	258	17003	612, 725	17114	239	17242	165	17397	146	17517	164	17617	249
16907	258	17004	435, 477	17115	221	17243	165	17398	146	17518	164	17618	249
16908	258	17006	309	17118	614	17244	165	17399	117	17519	164	17619	249
16909	258	17010	140	17119	614	17245	165	17400	117	17520	164	17620	248
16910	258	17013	159	17121	310	17246	165	17401	117	17521	164	17621	250
16911	258	17017	183	17122	614	17248	165	17403	118	17522	164	17622	250
16912	258	17018	183	17123	856	17249	165	17404	118	17523	164	17623	247
16913	258	17019	183	17124	455, 477	17261	276	17405	118	17524	164	17624	246
16914	258	17020	183	17128	553	17262	276	17408	302, 305	17525	164	17625	235
16915	258	17021	183	17143	524,	17263	276	17410	302, 310	17526	164	17626	235
16916	258	17022	183		536, 679	17264	276	17411	302	17527	164	17627	235
16917	258	17023	183	17144	523,	17265	276	17415	302	17528	164	17629	198
16918	258	17024	183		536, 679	17267	521,	17416	302	17529	164	17631	805
16919	258	17028	82	17145	282		537, 649	17419	302	17530	164	17632	508, 537,
16920	258	17031	82	17146	282	17271	551	17420	302	17531	164		605, 688, 722
16921	258	17034	88, 89	17147	282	17280	643, 664	17421	302	17532	164	17633	746
16922	258	17035	88, 90	17148	282	17281	664	17422	302	17533	165	17634	417,
16923	258	17036	213	17151	402, 620	17287	495,	17423	302	17535	165		478, 747
16924	258	17037	206	17152	105, 108		537, 678	17424	302	17536	165	17636	111, 783
16925	258	17038	206	17156	148, 285	17289	681	17425	302	17537	165	17639	315
16926	258	17039	206	17159	404	17298	784	17427	302	17538	165	17641	311
16927	258	17040	205	17162	571, 499,	17315	105,	17428	302	17539	165	17642	611
16930	72	17041	204		536, 801		107, 120	17429	302	17540	165	17643	611
16931	122, 127	17042	206	17164	610	17316	105,	17433	299	17541	165	17649	472, 478
16934	192	17043	206	17167	632		108, 120	17434	632	17542	165	17650	92, 97
16936	593	17044	206	17169	111	17317	597	17437	592	17545	554	17654	299
		17045	206	17171	110	17320	662	17438	779	17551	598, 718	17655	299
		17046	206	17172	238	17323	643	17439	501,	17552	598, 718	17659	252
		17047	206	17173	238	17334	783		537, 712	17553	598, 719	17661	248
		17048	206	17174	238	17339	440, 478	17440	642	17554	598, 719	17662	250

NUMERICAL INDEX

Auveco No.	Page No.	Auveco No.	Page No.	Auveco No.	Page No.	Auveco No.	Page No.	Auveco No.	Page No.	Auveco No.	Page No.	Auveco No.	Page No.
17664	425, 478	18108	297	18244	311	18383	595	18503	529,	18698	231	18842	446,
17666	566, 413	18109	286	18245	855	18386	610		538, 609	18699	231		479, 793
17667	598	18110	286	18246	855	18387	612	18504	611	18700	231	18843	786
17669	467, 478	18111	286	18248	442, 478	18389	416, 478	18508	441, 478	18701	231	18844	463,
17683	250	18113	404, 742	18249	630	18390	558	18509	437, 478	18702	231		479, 797
17684	247	18114	446, 478,	18251	139	18391	456, 478	18510	436, 478	18703	231	18846	786
17685	469, 478		645, 670	18253	140	18392	587	18512	679	18705	231	18848	455, 479
17686	208, 234	18115	668	18261	91, 97,	18393	587	18515	121, 123	18706	231	18849	275
17690	242	18118	555		28, 132	18394	530,	18518	230	18707	231	18853	220
17691	243	18119	523,	18262	584		538, 628	18519	230	18708	231	18855	222
17974	405		537, 679	18263	594	18395	582, 409	18520	230	18716	211	18856	222
17975	434, 478	18121	282	18265	503,	18396	304	18521	230	18726	275	18857	222
17976	592	18122	282		537, 752	18398	566, 413	18522	230	18727	294	18858	222
17977	312	18127	832	18268	578,	18401	145, 179	18524	239	18728	294	18859	423, 479
17978	848	18128	832		530, 537	18402	582, 409	18525	242	18729	294	18861	450,
17979	556	18129	832	18269	526,	18404	664	18527	241	18730	294		479, 795
17980	106, 108	18132	832		537, 628	18405	662	18530	243	18731	294	18862	468, 479
17981	661	18134	388	18270	504,	18415	668	18531	140, 153	18732	294	18864	663
17983	82	18135	388		537, 712	18416	122, 126	18533	389	18733	231	18865	662
17988	514,	18136	388	18271	444,	18417	556	18534	389	18734	231	18866	663
	537, 712	18137	388		478, 719	18418	557	18536	389	18735	231	18867	239
17989	703	18138	388	18277	432, 478	18423	557	18537	389	18736	231	18868	239
17990	444,	18139	388	18294	467,	18428	557	18539	389	18737	231	18870	239
	478, 709	18140	388		478, 673	18436	831	18540	389	18738	231	18871	243
17991	441,	18141	388	18296	92, 98	18437	831	18543	389	18743	298	18873	513,
	478, 710	18142	388	18297	443, 478,	18438	831	18547	166	18744	298		538, 803
17992	518,	18143	388		708, 791	18439	831	18548	166	18746	435, 478,	18874	466,
	537, 712	18144	388	18298	417, 478	18440	831	18554	166		646, 670		479, 799
17993	143, 714	18145	214	18299	275	18441	831	18557	166	18747	778	18875	452,
17994	258	18146	214	18301	423, 478	18442	831	18563	166	18748	584		479, 796
17995	258	18147	214	18302	416, 478	18443	831	18568	166	18749	311	18876	465,
17996	258	18148	214	18303	305	18444	831	18569	166	18750	195		479, 798
17997	258	18149	214	18304	306	18445	831	18576	166	18754	643	18877	440, 479,
17998	258	18150	214	18308	575,	18446	831	18586	166	18756	643		645, 674
17999	258	18151	214		514, 537	18447	831	18595	166	18760	643	18878	446,
18000	258	18152	215	18310	577,	18448	831	18597	166	18764	643		479, 793
18001	258	18153	584		529, 538	18449	145, 178	18607	166	18767	644	18882	603, 715
18002	258	18155	595	18312	224	18454	680	18613	166	18769	105, 108	18885	385
18003	258	18156	106, 107	18318	239	18456	644	18619	166	18770	416, 478	18887	231
18004	258	18157	444,	18320	239	18457	658	18624	166	18771	430, 479	18888	515,
18005	258		478, 668	18324	215	18458	446,	18626	166	18779	105, 107		538, 803
18006	258	18163	156	18325	215		478, 719	18630	166	18781	91, 96,	18889	313
18007	258	18165	504,	18326	216	18460	72,	18646	388		128, 131	18890	615
18008	258		537, 675	18327	506,		92, 99	18647	388	18798	195	18891	615
18010	258	18166	441,		538, 625	18461	308	18650	217	18799	195	18892	615
18011	258		478, 751	18329	310	18463	246	18651	218	18800	195	18893	505,
18012	258	18167	304	18330	441, 478	18464	246	18653	217	18801	195		538, 604
18013	258	18168	312	18331	315	18465	258	18654	217	18802	195	18894	506,
18014	258	18169	309	18334	578,	18466	258	18658	218	18803	195		538, 605
18015	258	18170	315		530, 538	18467	258	18659	218	18804	195	18895	506,
18016	258	18174	423, 478	18335	849	18468	258	18661	260	18806	195		538, 605
18017	258	18175	456, 478	18336	92, 99,	18469	258	18662	260	18807	120	18896	524,
18018	258	18177	120, 121		129, 133	18470	258	18665	275	18808	120		538, 576
18019	275	18187	120, 122	18337	145, 177	18472	259	18668	252	18809	120	18897	417, 479
18020	275	18194	225	18338	145, 177	18473	259	18671	250	18810	314	18898	176
18021	275	18202	197, 399	18339	145, 179	18474	259	18673	246	18811	293	18899	594
18022	277	18203	197, 399	18340	92, 99,	18475	259	18674	241	18812	293	18900	196
18023	277	18204	197, 399		129, 130	18476	259	18676	247	18814	293	18901	196
18024	279	18205	197, 399	18341	159	18477	259	18679	430, 478	18815	419, 479	18902	196
18025	279	18206	508, 537,	18342	110	18478	259	18680	430, 478	18816	598	18903	196
18026	281		608, 723	18343	111	18479	259	18682	419, 478	18817	91, 97,	18904	196
18027	281	18208	172	18344	110	18482	833	18683	415, 478		128, 132	18905	196
18028	297	18214	247	18346	110	18483	832	18684	415, 478	18818	441,	18906	196
18029	533,	18215	250	18347	111	18484	106, 110	18685	427, 478		479, 674	18907	196
	537, 623	18216	250	18348	110, 111	18485	110	18688	431, 478	18819	248	18908	196
18030	573, 506,	18217	248	18353	579,	18486	110	18690	218	18820	421, 479	18909	196
	626, 537	18218	252		497, 538	18487	110	18691	580	18824	458,	18910	196
18031	297	18236	644	18354	106, 109	18488	110	18692	439, 478,		479, 721	18911	554
18032	493,	18237	629	18371	424, 478	18489	294		720, 794	18825	618	18912	310
	537, 623	18238	111	18373	276	18498	602	18693	231	18827	434, 479	18913	297
18033	440, 478	18239	105, 111	18374	278	18499	304	18694	231	18829	275	18914	615
18034	617	18240	111	18375	280	18500	305	18695	231	18830	275	18915	467, 479
18102	612, 631	18241	105, 111	18377	599	18501	297	18696	231	18835	197	18916	239
18103	232	18242	297	18379	423, 478	18502	297	18697	231	18836	199	18917	240

NUMERICAL INDEX

Auveco No.	Page No.	Auveco No.	Page No.	Auveco No.	Page No.	Auveco No.	Page No.	Auveco No.	Page No.	Auveco No.	Page No.	Auveco No.	Page No.
18918	242	19051	294	19149	417, 479	19248	503,	19334	453,	19449	437, 480	19554	242
18920	253	19053	294	19152	631		539, 823		480, 737	19450	715	19555	243
18921	253	19055	294	19153	757	19250	425, 479	19337	497,	19453	510,	19556	242
18923	238	19056	294	19154	599	19251	129, 134		539, 609		539, 676	19558	831
18924	236	19057	294	19155	435, 479	19252	833	19338	433, 480	19454	668	19559	831
18925	240	19058	294	19156	250	19253	833	19339	631	19455	125	19560	831
18926	588	19060	294	19157	251	19254	833	19341	393	19456	304	19561	831
18927	310	19061	294	19162	175	19257	466, 479,	19343	735	19458	304	19562	831
18930	469, 479	19062	300	19163	175		711, 798	19345	603	19459	310	19564	831
18931	275	19065	302	19164	175	19258	209	19352	425, 480	19460	312	19566	831
18932	275	19066	296	19165	175	19259	209	19354	425, 480	19461	303	19568	831
18934	94, 103	19076	251	19166	175	19260	209	19355	572,	19464	452,	19569	831
18935	312	19095	839	19170	93, 102,	19261	209		496, 539		480, 646	19570	831
18936	473, 479	19096	839		130, 135	19262	209	19356	457, 480	19465	644	19571	831
18938	313	19097	839	19171	439,	19263	315	19357	557	19466	460,	19572	831
18939	512,	19098	839		479, 674	19270	457, 479	19358	556		480, 647	19575	831
	538, 712	19099	839	19176	283	19271	203	19359	662	19467	443,	19576	202
18947	405	19100	839	19177	283	19272	203	19361	554		480, 646	19577	202
18948	417,	19102	231	19178	283	19273	203	19365	282	19468	432,	19578	202
	479, 749	19103	231	19183	592	19274	516,	19368	438, 480		480, 691	19579	202
18950	463,	19104	231	19186	492, 538,		539, 754	19370	557	19470	422,	19581	247
	479, 797	19105	231		647, 675	19275	457, 479	19371	426, 480		480, 669	19582	248
18951	523,	19106	231	19187	787	19277	596	19373	426, 480	19472	580, 610	19587	282
	538, 739	19107	231	19191	631	19278	92, 98,	19374	426, 480	19476	643, 662	19588	277
18952	212	19108	466,	19194	551, 788		129, 132	19376	309	19477	643, 662	19589	277
18979	400		479, 799	19195	502,	19279	280	19378	825	19479	644	19590	275
18980	120	19109	460,		538, 818	19281	405	19379	563	19480	145, 179	19591	275
18981	235		479, 797	19197	429, 479	19282	182	19380	781	19481	438,	19592	275
18982	235	19110	303	19199	229	19283	182	19381	563		480, 721	19593	275
18983	235	19111	312	19202	306	19284	182	19385	445,	19482	705	19594	615
18986	235	19112	446,	19203	461,	19285	182		480, 737	19483	441, 480,	19595	114
18987	235		479, 793		479, 797	19286	182	19386	466, 480		646, 675	19597	114
18988	235	19113	445, 479,	19204	783	19287	182	19387	579	19484	784	19601	275
18989	235		709, 793	19205	140	19288	182	19390	557	19485	112,	19602	567
18990	235	19114	446, 479,	19206	259	19289	182	19393	404		617, 736	19603	275
19000	197, 399		646, 670	19207	259	19290	182	19394	404	19486	549	19604	275
19001	197, 399	19115	664	19208	259	19291	182	19397	403	19487	735	19605	275
19002	197, 399	19116	440,	19209	260	19292	182	19401	410	19490	507,	19607	502,
19003	197, 399		479, 674	19210	467,	19294	233	19404	410		539, 802		539, 607
19004	251	19117	666		479, 800	19295	233	19406	306	19492	703	19613	553
19006	92, 99,	19118	517,	19213	455, 479	19296	233	19407	524,	19498	404	19614	553
	129, 133		538, 676	19215	295	19297	571,		539, 679	19499	228	19615	576,
19007	276	19120	705	19216	139		502, 539	19408	523,		523,	19501	431, 480
19013	498,	19121	426,	19219	501, 538,	19298	207		539, 679	19505	787	19618	282
	538, 801		479, 791		712, 805	19299	207	19410	554	19506	420, 480,	19619	282
19014	442,	19123	444,	19220	585	19306	502,	19411	557		646, 669	19620	282
	479, 790		479, 794	19225	642		539, 722	19413	412, 603	19511	501,	19621	275
19016	466,	19124	447,	19228	715	19307	666	19414	302		539, 610	19623	248
	479, 800		479, 792	19231	510,	19308	140	19415	662	19514	309	19626	824
19017	406	19125	245		538, 648	19309	140	19416	510, 539,	19515	310	19627	824
19018	406	19126	246	19232	504,	19310	631		677, 723, 802	19516	315	19628	467, 480
19019	406	19127	427, 479		538, 648	19311	499,	19417	94, 104,	19519	583, 631	19630	275
19020	406	19128	516,	19233	519, 538,		539, 678		130, 137,	19522	572,	19638	531, 539,
19021	406		538, 803		648, 676	19312	419,	19418	579, 629		494, 539		607, 629
19022	406	19129	468,	19235	388		480, 790	19419	437, 480	19524	474, 480	19639	573, 505,
19023	407		479, 800	19237	93,	19314	735	19420	307	19526	598		626, 539
19024	407	19130	276		100, 598	19315	516,	19421	304	19527	457, 480	19640	617
19025	298	19131	623	19238	598		539, 723	19422	612	19529	805	19643	421,
19026	298	19132	295	19239	575, 518,	19317	585, 113		513,	19533	668		480, 790
19027	298	19133	295		538, 648,	19318	277	19424	539, 627	19534	707, 789	19644	145, 179
19028	298	19134	295		676, 738	19320	449,	19425	592	19535	707, 789	19645	568,
19029	298	19136	808	19240	93, 100		480, 737	19428	437, 480	19536	611		496, 539
19030	298	19138	598, 718	19242	568,	19322	736	19429	469, 480	19537	170	19646	667
19031	298	19139	276		492, 538	19323	445,	19430	552	19538	275	19647	780
19033	298	19140	568, 522,	19243	568,		480, 737	19435	779	19539	275	19648	716
19034	298		624, 538,		501, 538	19324	736	19436	552	19541	428, 480	19650	667
19036	298		649, 739, 804	19244	528,	19325	438,	19439	613	19545	276	19653	92, 99,
19037	298	19141	280		538, 609	19326	480, 738	19440	580, 271	19546	505,		129, 133
19045	293	19142	499,	19245	514,	19328	596	19441	602		539, 678	19655	434, 480
19046	293		538, 678		538, 627	19330	735	19442	380	19547	504,	19657	306
19047	293	19143	667	19246	510,	19331	444,	19443	381		539, 675	19658	588
19048	293	19145	461, 479,		539, 752		480, 737	19444	381	19548	141	19661	249
19049	294		647, 671	19247	551	19331	444,	19445	380	19552	501,	19666	389
19050	294	19147	756				480, 737		380		539, 801	19667	421, 480

NUMERICAL INDEX

Auveco No.	Page No.	Auveco No.	Page No.	Auveco No.	Page No.	Auveco No.	Page No.	Auveco No.	Page No.	Auveco No.	Page No.	Auveco No.	Page No.
19668	643	19747	507,	19851	581, 271	20139	635	20234	500, 540,	20322	184	20401	613
19669	143, 175,		539, 722	19853	582	20143	640		654, 730	20324	638	20402	303
	725, 807	19748	718	19854	572,	20146	638	20243	845	20325	639	20404	728
19673	417,	19749	439,		490, 539	20147	638	20244	579,	20326	559	20405	822
	480, 673		481, 794	19855	425, 481	20149	637		515, 540	20327	512,	20407	532,
19676	551	19752	599	19880	251	20150	639	20245	595		540, 753		540, 823
19678	437, 480	19753	718	19881	247	20153	614, 724	20246	246	20328	561	20408	558
19680	662	19756	788	19882	241	20155	635	20247	509, 540,	20331	658	20409	839
19682	446,	19757	559	19883	248	20157	638		675, 738	20334	422,	20410	839
	480, 670	19758	470, 481	19885	251	20158	638	20248	521,		481, 669	20411	461, 482,
19683	441,	19760	428, 481	19887	248	20163	579,		540, 655	20335	507,		647, 672
	480, 674	19764	196	19889	250		495, 540	20250	812		540, 802	20412	788
19684	440,	19765	196	19890	245	20164	434, 481	20252	470,	20338	458, 481	20415	585, 613
	480, 751	19766	196	19891	240	20165	416, 481		481, 816	20339	145, 177	20416	145, 178
19686	415,	19767	196	19892	571,	20169	499,	20253	471,	20341	473,	20417	561
	480, 790	19769	196		530, 539		540, 609		481, 653		481, 816	20421	613
19687	854	19770	196	19893	422, 481	20171	598	20254	652	20342	398	20422	586
19688	854	19771	196	19894	621	20172	247	20256	419,	20344	416, 482	20423	586
19689	854	19772	196	19898	465,	20173	632		481, 749	20345	431, 482	20424	403
19690	854	19773	280		481, 799	20175	824	20259	93, 100,	20346	615	20425	596
19691	854	19774	423, 481	19899	703	20176	121, 123		129, 134	20347	278	20426	279
19692	854	19775	469, 481	19900	704	20177	423, 481	20261	122, 125	20348	523,	20427	469, 482
19693	854	19776	705	19904	503,	20179	617		430, 481		540, 753	20428	468, 482
19694	854	19777	106, 108		539, 823	20180	437, 481	20262	402, 556	20349	508, 540,	20429	780
19695	854	19778	92, 99	19905	515,	20181	438, 481	20263	402, 556		713, 752, 802	20431	785
19696	854	19779	632		540, 753	20182	436, 481	20264	597	20350	665	20432	679
19697	854	19781	591	19907	515,	20184	421,		529, 540	20351	665	20434	120, 121
19698	854	19782	591		540, 803		481, 790	20266	743	20352	504,	20435	120, 121
19701	854	19783	598,	19908	515,	20186	651	20267	617		540, 678	20437	463,
			706, 786		540, 803	20187	491, 540,	20268	583	20353	563		482, 798
19702	854	19786	405	19910	465,		730, 817	20270	516,	20355	602	20440	788
19705	854	19787	569,		481, 798	20188	470,		540, 655	20356	619	20443	439,
19706	854		494, 539	19926	636		481, 729	20271	92, 98,	20358	601		482, 795
19711	854	19788	569,	19927	381	20189	427, 481		129, 132	20359	575,	20444	468, 482
19712	854		493, 539	19928	637	20190	468, 481	20272	661		513, 540	20446	106, 108
19713	854	19790	425, 481	19929	637	20191	604	20273	514, 540,	20360	427, 482	20448	184
19714	854	19793	618	19930	636	20192	424, 481		606, 625	20362	430, 482	20449	184
19715	854	19795	580, 271	19931	640	20193	603	20274	455, 481	20363	499,	20450	140
19716	854	19797	780	19932	640	20194	603	20275	618		540, 610	20452	552
19719	450,	19798	72	19933	640	20195	614, 724	20276	402	20364	92, 100	20453	275
	480, 796	19800	559	19939	640	20196	496,	20277	249	20365	574,	20454	275
19720	441,	19801	573, 500,	19941	640		540, 800	20279	472, 481		509, 540	20455	93, 101,
	480, 795		607, 626, 539	19944	637	20199	727	20280	557	20366	424, 482		129, 135
19721	788	19802	455, 481	19945	637	20201	726	20281	429, 481	20367	511,	20457	524,
19722	783	19804	470, 481	19947	635	20202	726	20282	259		540, 605		540, 628
19723	644	19807	824	19952	635	20203	532,	20283	259	20373	69	20458	521,
19724	441,	19810	455, 481	19954	637		540, 731	20284	259	20374	69		540, 627
	480, 751	19812	639	19955	637	20205	727	20285	259	20375	91, 95	20462	275
19725	591	19813	251	19957	637	20206	233	20286	259	20376	92, 99	20464	565
19726	568,	19816	400	19958	637	20207	233	20287	259	20377	561	20465	507,
	496, 539	19817	400	19966	639	20209	220	20289	259	20378	549		540, 722
19728	441,	19819	404	19970	635	20210	220	20291	259	20380	273, 649,	20466	552, 597
	480, 795	19820	560	19972	636	20211	220	20292	259		680, 714, 725,	20468	618
19729	445, 480,	19821	565	19973	636	20212	217	20294	259		739, 756, 806	20469	714, 805
	709, 793	19822	561	19975	640	20213	217	20295	259	20381	444, 482,	20470	714, 805
19730	680	19823	612	19976	639	20214	218	20296	259		669, 737, 748	20471	581, 271
19731	461,	19826	172	19977	640	20215	218	20298	259	20382	92, 99,	20472	141,
	480, 750	19831	717	19985	636	20216	218	20299	259		129, 133		645, 668
19732	553	19834	427, 481	20008	637	20217	219	20300	259	20383	308	20473	452, 482,
19734	644, 668	19836	418, 481	20030	635	20218	219	20301	106, 109	20386	663		710, 796
19735	143, 757	19837	427, 481	20034	637	20219	219	20303	667	20387	663	20474	294
19736	746	19838	612	20038	640	20220	218	20308	630	20388	521,	20475	220
19737	661	19840	786	20089	638	20221	219	20309	405		540, 655	20476	92, 98,
19739	523,	19842	423,	20090	635	20222	219	20310	502,	20389	253		129, 132
	539, 804		481, 793	20092	636	20223	219		540, 606	20390	780	20477	270
19740	643, 662	19843	781	20110	635	20224	219	20311	417, 481	20391	780	20478	227
19741	667	19844	639	20111	640	20225	219	20313	639	20392	602	20479	316
19742	706, 787	19845	432, 481	20112	640	20226	218	20314	496,	20393	596	20480	316
19743	718	19846	432, 481	20114	640	20227	219		540, 730	20394	639	20481	563
19744	422,	19847	571,	20115	640	20230	219	20315	728	20395	585	20482	611
	481, 670		525, 539	20116	640	20231	220	20316	430, 481	20396	585, 613	20483	610
19745	735	19849	511,	20118	640	20232	402, 556	20318	557	20397	581, 271	20484	226
19746	415,		539, 606	20122	636	20233	527,	20319	427, 481	20399	421, 482	20485	588
	481, 646	19850	438, 481	20123	636		540, 606	20320	233	20400	599	20486	226

NUMERICAL INDEX

Auveco No.	Page No.	Auveco No.	Page No.	Auveco No.	Page No.	Auveco No.	Page No.	Auveco No.	Page No.	Auveco No.	Page No.	Auveco No.	Page No.
20487	226	20559	459, 482,	20629	308	20721	267	20803	397	20884	564	20956	143, 175,
20488	226		711, 797	20630	614	20722	267	20804	397	20885	561		715, 807
20489	226	20560	233	20631	575,	20728	267	20807	277	20886	689	20957	716
20490	226	20561	251		512, 541	20729	267	20808	560	20887	623	20958	716
20491	226	20562	587	20632	576, 523,	20730	267	20809	560	20888	574, 512,	20959	462, 483,
20492	226	20563	469, 482		608, 541	20734	520,	20810	559		627, 541		647, 672
20493	226	20564	522, 540,	20633	464,		541, 655	20811	560	20889	576, 523,	20960	716
20494	226		649, 677		482, 798	20735	470,	20813	746		608, 541	20961	689, 741
20495	226	20565	736	20634	456, 482		482, 729	20814	458, 482	20890	533,	20962	619
20496	226	20566	684	20635	553	20736	691, 745	20815	221		541, 629	20963	531,
20497	226	20567	682, 697	20636	493,	20737	661	20816	221	20891	566		541, 629
20498	226	20568	683		541, 731	20738	705, 778	20817	600	20892	567,	20964	620
20499	226	20570	140,	20637	516,	20739	524,	20818	224		532, 541	20965	602
20500	226		681, 734		541, 731		541, 625	20819	225	20893	417, 483	20966	511,
20501	226	20571	449,	20638	520, 541,	20740	311	20823	848	20895	785		541, 626
20502	834		482, 738		654, 731	20741	311	20825	563	20896	275	20967	525,
20503	834	20572	735	20639	494,	20742	585	20826	575,	20897	726		541, 628
20504	834	20573	736		541, 730	20743	777		514, 541	20898	230	20968	601
20505	834	20574	836	20640	494,	20744	777	20827	622	20899	229	20970	94, 130,
20506	834	20575	463, 482,		541, 730	20746	280	20828	621	20900	203, 853		137, 579,
20507	834		711, 798	20641	731	20747	215	20829	454, 482	20901	222		104, 610, 629
20508	834	20576	449,	20642	449,	20748	215	20830	309	20902	849	20971	308
20509	834		482, 795		482, 729	20749	215	20831	439, 482	20903	849	20972	560
20510	834	20577	568, 515,	20645	732	20750	223	20834	311	20905	850	20973	560
20511	834		541, 712, 803	20647	728	20751	223	20836	400	20906	847	20974	560
20512	834	20578	556, 781	20649	142, 732	20752	223	20837	245	20907	847	20976	560
20514	582	20579	718	20650	142, 733	20753	526,	20838	252	20908	517, 541,	20977	602
20515	466, 482	20580	499, 541,	20651	142, 733		541, 754	20839	248		777, 804	20979	600
20516	519,		626, 738	20653	656, 732	20754	297	20840	251	20909	503,	20981	601
	540, 607	20581	619, 736	20654	272, 732	20755	515,	20841	247		541, 731	20982	622
20518	527,	20582	174	20655	273, 732		541, 723	20842	250	20910	504,	20983	460,
	540, 609	20583	222	20656	727	20756	562	20843	249		541, 677		483, 720
20521	563	20585	259	20657	726	20757	708, 789	20844	247	20912	392	20984	716
20523	621	20587	259	20659	727	20758	707, 789	20845	251	20914	392	20986	519,
20524	618	20588	259	20660	707	20759	282	20846	251	20915	392		541, 676
20525	619	20589	259	20661	703	20760	438, 482	20848	245	20916	392	20988	574, 510,
20526	631	20590	259	20663	602	20761	424, 482	20849	248	20917	392		626, 541
20527	553	20591	259	20665	581, 271	20763	621	20850	252	20918	392	20989	574, 512,
20528	416, 482	20593	259	20666	571,	20764	690, 742	20851	252	20919	392		608, 541
20529	553	20595	260		494, 541	20765	468, 482	20852	249	20920	392	20990	575, 514,
20530	597	20596	260	20667	618	20766	521,	20853	247	20922	390		627, 542
20531	423, 482	20598	260	20668	463, 482,		541, 627	20854	267	20923	532, 541,	20991	576,
20532	596	20599	260		692, 750	20767	526,	20855	267		604, 722		522, 542
20534	714, 806	20600	260	20669	465, 482,		541, 628	20856	267	20924	811	20992	576,
20535	714, 806	20601	260		692, 750	20768	513,	20857	267	20925	811		523, 542
20536	225	20602	660	20670	459,		541, 627	20859	259	20926	424, 483	20993	577, 528,
20537	852	20603	658		482, 751	20769	619	20860	583	20927	112, 595		608, 542
20538	852	20604	690, 744	20671	445,	20770	446, 482	20862	599	20928	393	20994	577,
20539	852	20605	703		482, 748	20771	623	20863	577,	20931	513,		528, 542
20540	852	20606	140	20672	452,	20773	727		525, 541		541, 803	20995	456, 483
20541	433, 482	20607	561		482, 749	20774	562	20864	549	20932	452,	20996	456, 483
20542	504,	20608	520,	20675	587, 614,	20775	560	20865	560		483, 720	20998	457, 483
	540, 573		541, 676		630, 634	20776	614	20866	474, 483	20933	812	20999	457, 483
20543	448, 482,	20609	435, 482,	20677	658	20782	662	20868	564	20934	562	21000	601
	686, 698		646, 670	20678	585, 613	20783	660	20869	574, 507,	20935	563	21001	139
20544	633	20610	466,	20680	105, 108	20784	660		541, 713, 802	20936	603, 715	21002	210
20545	510,		482, 673	20681	259	20785	660	20870	622	20937	113	21003	210
	540, 605	20611	449,	20683	260	20786	745	20872	588	20938	551	21004	210
20546	612		482, 671	20687	780	20787	306	20873	740	20942	400	21005	211
20547	246	20612	666	20688	780	20788	305	20874	431,	20943	569,	21006	237
20548	246	20613	511,	20689	841	20789	232		483, 708		497, 541	21007	172
20549	249		541, 753	20690	841	20790	746	20875	704	20944	456, 483	21010	516,
20550	246	20614	741	20691	841	20791	840	20876	704	20945	638		542, 804
20551	233	20615	433, 482	20694	840	20792	397	20877	704	20948	525,	21011	500,
20552	233	20616	468, 482	20695	840	20793	397	20878	426, 483,		541, 625		542, 801
20553	233	20618	216	20698	396	20794	397		708, 790	20949	468, 483	21012	452, 483,
20554	233	20620	259	20700	622	20795	397	20879	463,	20950	565		710, 796
20555	233	20621	259	20702	267	20796	397		483, 729	20951	564	21013	564
20556	93, 102,	20623	630	20705	267	20797	397	20880	574,	20952	561	21015	707, 786
	130, 135	20624	423, 482	20706	267	20798	397		511, 541	20953	519, 541,	21016	782
20557	93, 103,	20625	431, 482	20712	267	20799	397	20881	450, 483		693, 754	21017	142,
	130, 136	20626	311	20715	267	20800	397	20882	445,	20954	644, 667		693, 756
20558	459, 482,	20627	306	20717	267	20801	397		483, 669	20955	713, 804	21019	632
	711, 797	20628	306	20720	267	20802	397	20883	583				

NUMERICAL INDEX

Auveco No.	Page No.	Auveco No.	Page No.	Auveco No.	Page No.	Auveco No.	Page No.	Auveco No.	Page No.	Auveco No.	Page No.	Auveco No.	Page No.
21021	524, 542, 625	21103	491, 542, 800	21160	689	21226	452, 484, 795	21291	740	21354	278	21415	473, 484, 817
21022	403	21104	497, 542, 801	21161	565	21227	434, 484	21292	685	21355	273, 688	21416	808
21023	474, 483	21105	448, 483, 729	21162	783	21228	432, 484	21293	277	21356	684	21417	646, 671
21024	507, 542, 608, 722	21106	233	21163	580	21229	439, 484, 691, 747	21294	516, 542, 803	21357	708	21418	305
21025	619, 737	21107	451, 483, 646, 671	21164	580	21230	601	21295	442, 484, 747	21358	708	21419	661
21026	426, 483	21108	233	21165	597	21231	619	21360	715, 807	21359	143, 715, 807	21420	524, 543, 776
21027	584	21109	660	21166	235	21232	685	21296	443, 484, 791	21361	578, 528, 543, 754	21421	432, 484, 772
21028	297	21110	509, 542, 723	21167	638	21233	491, 542, 688	21297	518, 542, 676	21362	596	21422	516, 543, 775
21033	242	21111	690, 744	21168	638	21234	782	21300	597	21363	696	21423	400, 650
21036	564	21112	569, 499, 542	21169	469, 483	21235	782	21301	428, 484	21364	453, 484	21424	223
21037	491, 542, 730	21113	308	21170	649, 680	21236	617	21302	580	21365	450, 484	21425	690
21038	682	21114	306	21171	716	21237	789	21303	419, 484, 669	21366	525, 543, 804	21426	138
21040	145, 177	21115	276	21172	496, 542, 604	21238	530, 542, 571	21304	597	21367	743	21427	524, 543, 625
21041	281	21116	465, 483, 738	21173	521, 542, 648, 676	21239	596	21305	272, 656, 725, 732, 734, 820	21368	595	21428	552
21044	502, 542, 730	21117	522, 542, 724	21174	601	21240	460, 484	21306	599	21369	778	21429	650
21046	311	21118	499, 542	21175	621	21241	431, 484	21307	446, 484, 719	21370	564	21430	650
21047	278	21119	499, 542, 801	21176	579, 527, 542	21242	562	21308	642, 660	21371	697	21431	656, 732
21048	120	21120	739	21177	565	21243	683	21309	755	21372	699	21432	650
21049	120	21121	91, 96, 128, 131	21178	275	21244	683	21310	273, 630	21373	562, 622	21433	726
21050	120	21122	511, 542, 802	21179	275	21245	315	21311	508, 542, 752	21374	562, 622	21434	726
21051	120	21123	313	21180	275	21246	570, 494, 542	21312	682	21375	566	21435	235
21052	120	21124	437, 483	21181	105, 110	21247	466, 484	21313	433, 484	21376	527, 543, 628	21436	235
21053	120	21125	611	21182	110	21248	428, 484	21314	704	21377	580	21437	235
21054	120	21126	611	21183	110	21249	492, 542, 800	21315	313	21378	144, 688, 700	21438	235
21055	120	21127	561	21184	310	21250	468, 484	21316	558	21379	469, 484	21439	310
21056	120	21128	562	21185	594	21251	526, 542, 819	21317	209	21380	432, 484	21440	315
21059	467, 483, 647, 673	21129	468, 483, 647	21186	659	21252	422, 484, 790	21318	746	21381	437, 484, 685, 697	21441	726
21064	682	21130	783	21187	583	21253	448, 484, 793	21319	602	21382	436, 484, 685, 697	21442	629
21066	685, 697	21131	782	21188	459, 483, 687, 698	21254	448, 484, 793	21320	307	21383	456, 484	21443	432, 485
21067	688	21132	782	21189	469, 483	21255	705	21321	683	21384	553	21444	590
21068	684	21133	782	21190	503, 542, 677	21256	834	21322	772	21385	433, 484	21445	611
21069	106, 684, 696	21134	520, 542, 753	21191	787	21257	426, 484	21323	690, 743	21386	433, 484	21446	297
21070	460, 483, 687, 698	21135	279	21192	518, 542, 693, 723, 754	21258	276	21324	503, 542, 802	21387	583	21447	810
21071	781	21136	683	21193	779	21259	273, 756	21325	281	21388	649, 680	21448	809
21072	589	21137	458, 483, 734	21194	779	21260	210	21326	297	21389	809	21449	809
21074	839	21138	464, 483, 734	21195	400	21261	210	21327	498, 543, 688	21390	493, 543, 818	21450	451, 485, 815
21075	839	21139	460, 483, 734	21196	587	21262	210	21328	464, 484	21391	473, 484, 814	21451	496, 543, 818
21076	839	21140	498, 542, 738	21197	588	21263	210	21329	689	21392	426, 484, 814	21452	526, 543, 819
21077	839	21141	509, 542, 673	21198	600	21264	210	21330	787	21393	473, 484, 817	21453	779
21078	839	21142	437, 483, 734	21199	420, 483	21265	210	21331	422, 484, 791	21394	810	21454	520, 543, 677
21080	154	21143	473, 483, 816	21200	564	21266	210	21332	467, 484	21395	810	21455	821
21081	106, 109	21144	817	21201	513, 542, 713	21267	210	21333	438, 484	21396	810	21456	696
21082	307	21145	508, 542, 699	21202	600	21268	210	21334	566	21397	813	21457	415, 485, 673
21084	707	21146	473, 483, 816	21203	582, 272	21269	210	21335	714, 805	21398	473, 484, 816	21458	144, 693, 757
21085	740	21147	689	21204	642	21270	210	21336	807	21399	811	21459	726
21086	517, 542, 627, 731	21148	601	21205	667	21271	210	21337	428, 484	21400	579, 527, 543	21460	726
21087	465, 483, 673	21149	459, 483, 672	21206	463, 483, 673	21272	210	21338	226	21401	221	21461	726
21088	452, 483	21150	684	21207	659	21273	210	21339	226	21402	293	21462	726
21089	510, 542, 605	21151	706, 786	21208	461, 483, 647, 672	21274	211	21340	226	21403	589	21463	726
21090	428, 483	21152	853	21209	645	21275	210	21341	226	21404	590	21464	726
21091	455, 483	21153	622	21210	245, 255	21276	210	21342	226	21405	590	21465	726
21092	588	21154	621	21211	434, 484, 793	21277	211	21343	226	21406	590	21466	727
21093	278	21155	623	21212	240	21278	210	21344	226	21407	633	21467	727
21094	664	21156	562	21213	619	21279	210	21345	226	21408	633	21468	726
21095	663	21157	565	21214	611	21280	210	21346	456, 484	21409	633	21469	726
21096	663	21158	558	21215	613	21281	210	21347	551	21410	459, 484, 797	21470	659
21097	742	21159	751	21216	661	21282	211	21348	531, 543, 629	21411	788	21471	381
21098	510, 542, 605, 624			21217	783	21283	211	21349	420, 484, 697	21412	454, 484, 721	21472	233
21099	622			21218	492, 542, 800	21284	582	21350	420, 484, 697	21413	717	21473	233
21101	639			21219	602	21285	740	21351	586	21414	463, 484, 692, 750	21474	233
21102	463, 483, 711, 798			21220	240, 255	21286	314	21352	278	21415	473, 484, 817	21475	233
				21221	783	21287	432, 484	21353	278	21416	808	21476	233
				21222	622	21288	432, 484, 749			21417	646, 671	21477	503, 543, 677
				21223	622	21289	464, 484, 750			21418	305	21478	810
				21224	597	21290	586			21419	661	21479	513, 543, 818
				21225	509, 542, 803					21420	524, 543, 776	21480	811
				21226	689					21421	432, 484, 772	21481	809

NUMERICAL INDEX

Auveco No.	Page No.	Auveco No.	Page No.	Auveco No.	Page No.	Auveco No.	Page No.	Auveco No.	Page No.	Auveco No.	Page No.	Auveco No.	Page No.
21856	518, 544, 713, 804	21900	427, 487, 767	21946	67	21996	454, 488, 816	22050	771	22098	820	22153	449, 488, 701
21857	705, 782	21901	65	21947	422, 487, 760	21997	473, 488, 817	22051	707, 785	22099	600	22154	700
21858	543, 544, 722	21902	66	21948	66	21998	461, 488, 750	22052	521, 545, 655	22100	519, 545, 575	22155	702, 545, 495
21859	502, 544, 730, 757, 823	21903	65	21949	440, 487, 759	21999	755	22053	431, 488	22101	525, 545, 818	22156	462, 488, 702
21860	525, 544, 713, 804	21904	65	21950	67	22000	739	22054	445, 488, 669	22102	707, 778	22157	464, 488, 695
21861	657	21905	427, 487, 766	21951	67	22001	444, 488, 792	22055	740	22103	435, 488, 710, 793	22158	782
21862	725	21906	427, 487, 767	21952	67	22002	65	22056	452, 488, 710, 795	22104	92, 98, 129, 133	22159	782
21863	682, 695, 735	21907	429, 487, 767	21953	67	22003	462, 488, 686, 698	22057	450, 488, 653	22105	145, 681, 178	22160	498, 545, 774
21864	308	21908	447, 487, 765	21954	67	22004	464, 488, 687	22058	496, 545, 604	22106	93, 102, 130, 136	22161	558
21865	93, 100, 129, 134	21909	447, 487, 765	21955	66	22005	462, 488, 687, 699	22059	745	22107	436, 488, 751	22162	438, 488
21866	65	21910	419, 487, 766	21956	66	22006	467, 488, 686	22060	439, 488, 691, 747	22108	810	22163	779
21867	65	21911	420, 487, 766	21957	66	22007	682, 695	22061	689, 740	22109	656	22164	121, 123
21868	427, 487, 760, 766	21912	420, 487, 766	21958	758, 764	22008	458, 488, 687, 698	22062	633	22110	92, 133, 100, 129	22165	665
21869	65	21913	420, 487, 766	21959	758, 764	22009	464, 488, 686, 698	22063	452, 488, 692, 749	22111	93, 101, 129, 134	22166	790
21870	447, 487, 765	21914	429, 487, 767	21960	758, 764	22010	682	22064	718	22112	519, 544, 648, 677	22167	559
21871	449, 487, 761, 767	21915	765	21961	759, 764	22011	685	22065	582	22113	145, 177, 657, 820	22168	435, 488
21872	56, 64, 66	21916	462, 487, 761, 768	21962	758	22012	469, 488, 688	22066	314	22114	142, 656	22169	275
21873	466, 487, 653, 768	21917	462, 487, 768	21963	758	22013	683	22067	313	22115	732	22170	834
21874	758, 764	21918	442, 487, 759, 765	21964	758	22014	696	22068	519, 545, 648, 677	22116	820	22171	834
21875	494, 544, 762, 769	21919	441, 487, 759, 765	21965	758	22015	683, 696	22069	519, 545, 648, 677	22117	585	22172	307
21876	511, 544, 752, 769	21920	442, 487, 759, 765	21966	763	22016	685	22070	92, 98, 129, 133	22118	235	22173	591
21877	419, 487, 760	21921	442, 487, 759, 765	21967	490, 544, 762	22017	685, 697	22071	448, 488	22119	235	22174	591
21878	419, 487, 760	21922	769	21968	490, 544, 762, 768	22018	683	22072	531, 545, 714, 805	22120	235	22175	776
21879	446, 487, 759	21923	769	21969	501, 544, 763	22019	683	22073	448, 488, 708, 790	22121	586	22176	745
21880	446, 487, 759	21924	769	21970	495, 544, 762	22020	683	22074	145, 177	22122	313	22177	502, 545, 628
21881	491, 544, 762	21925	66, 67	21971	503, 544, 763	22021	558	22075	422, 488, 691, 749	22123	744	22178	495, 545, 604
21882	494, 544, 762, 769	21926	770	21972	492, 544, 762	22022	559	22076	689, 740	22124	600	22179	451, 488
21883	520, 544, 763	21927	770	21973	517, 544, 763	22023	314	22077	507, 545, 738	22125	491, 545, 712, 800	22180	424, 488
21884	467, 487, 762	21928	65, 66	21974	462, 487, 761	22024	559	22078	777	22126	514, 545, 803	22181	507, 545, 775
21885	814	21929	758, 764	21975	449, 487, 761, 768	22025	583	22079	777	22127	703	22182	246
21886	819	21930	742, 764	21976	464, 487, 762	22026	551	22080	559	22128	746	22183	249
21887	819	21931	758, 764	21977	450, 487, 761, 767	22027	563	22081	92, 99, 129, 133	22129	621	22184	840
21888	819	21932	764	21978	462, 487, 761	22028	619	22082	445, 488, 737	22130	660	22185	840
21889	819	21933	63, 65	21979	759	22029	563	22083	501, 545, 777	22131	657	22186	840
21890	812	21934	763, 770	21980	439, 487, 813	22030	92, 133, 100, 129	22084	651	22132	454, 488, 711, 796	22187	840
21891	434, 487, 817	21935	493, 487, 769	21981	436, 487, 813	22031	468, 488	22085	700	22133	451, 488	22188	840
21892	817	21936	416, 487, 760	21982	436, 488, 813	22032	741	22086	474, 488, 653	22134	275	22189	840
21893	454, 487, 815	21937	421, 487, 760	21983	415, 488, 814	22033	601	22087	656	22135	684	22190	840
21894	473, 487, 817	21938	420, 487, 760	21984	415, 488, 814	22034	469, 488	22088	308	22136	675	22191	840
21895	462, 487, 761, 768	21939	421, 487, 760	21985	811	22035	586	22089	307	22137	822	22192	840
21896	450, 487, 767	21940	420, 487, 760	21986	811	22036	562	22090	469, 488, 654	22138	822	22193	841
21897	765	21941	421, 487, 761	21987	812	22037	565	22091	473, 488, 652	22139	298	22194	841
21898	505, 544, 769	21942	442, 487, 759	21988	812	22038	600	22092	474, 488, 653	22140	650	22195	841
21899	65	21943	442, 487, 759	21989	492, 545, 818	22039	518, 545, 693, 752	22093	454, 488, 701	22141	650	22196	279
		21944	462, 487, 761, 768	21990	497, 545, 818	22040	584	22094	812	22142	651	22197	789
		21945	66	21991	449, 488, 815	22041	567, 532, 545	22095	525, 545, 818	22143	277	22198	756
				21992	816	22042	770	22096	707, 789	22144	657	22199	498, 545, 647, 675
				21993	810	22043	772	22097	714, 806	22145	700	22201	494, 545, 654
				21994	810	22044	771			22146	657	22202	651
				21995	454, 488, 816	22045	140			22147	657	22203	93, 101, 129, 134
						22046	447, 488, 772			22148	701	22204	817
						22047	527, 545, 776			22149	468, 488, 702	22205	280
						22048	459, 488, 774			22150	701	22206	467, 488, 773
						22049	511, 545, 723			22151	700	22207	451, 488, 773
										22152	459, 488, 702	22208	814
												22209	448, 489
												22210	776
												22211	432, 489, 772
												22212	444, 489, 709, 791

NUMERICAL INDEX

Auveco No.	Page No.	Auveco No.	Page No.	Auveco No.	Page No.	Auveco No.	Page No.	Auveco No.	Page No.	Auveco No.	Page No.	Auveco No.	Page No.
22213	788	22263	445,	22314	683	22374	68	22446	52	22518	51	71000	339
22214	443,		489, 669	22315	466, 489,	22375	68	22447	63	22519	55	71101	339
	489, 791	22264	312		687, 699	22376	68	22448	46	22520	55	71102	339
22215	781	22265	314	22316	682, 695	22377	68	22449	64	22521	50	71103	339
22216	813	22266	313	22317	682, 695	22378	68	22450	47	22522	57	71104	339
22217	780	22267	465, 489	22318	686	22379	67	22451	47	22523	58	71105	339
22218	746	22268	559	22319	686, 698	22380	67	22452	58	22524	50	71106	339
22219	512,	22269	460, 489	22320	436,	22381	68	22453	48	22525	59	71107	339
	545, 575	22270	517,		489, 686	22382	68	22454	60	22526	54	71108	339
22220	467, 489		545, 775	22321	436, 489,	22383	68	22455	61	22527	47	71109	339
22221	445,	22271	121, 123		685, 697	22384	68	22456	59	70000	339	71110	339
	489, 792	22272	612	22322	684, 696	22385	68	22457	61	70100	339	71111	339
22222	558	22273	664	22323	684, 696	22386	68	22458	46	70101	339	71112	339
22223	276	22274	690, 743	22324	684	22387	68	22459	49	70102	339	71113	339
22224	558	22275	755	22325	439, 489,	22388	68	22460	61	70103	339	71114	339
22225	564	22276	559		686, 697	22389	68	22461	49	70104	339	71115	339
22226	565	22277	585	22326	696	22390	68	22462	57	70105	339	71116	339
22227	511,	22278	453, 489	22327	53	22391	68	22463	51	70106	339	71117	339
	545, 608	22279	454, 489	22328	53	22394	53	22464	51	70107	339	71118	339
22228	555	22280	498,	22329	682, 696	22395	60	22465	51	70108	339	71119	339
22229	466,		545, 818	22330	53	22396	59	22466	51	70109	339	71120	339
	489, 654	22281	741	22331	54	22397	64	22467	51	70110	339	71121	339
22230	490,	22282	526,	22332	307	22398	59	22468	52	70111	339	71122	339
	545, 774		545, 724	22333	489, 309	22399	64	22469	52	70112	339	71123	339
22231	458,	22283	661	22334	710	22400	62	22470	54	70113	339	71124	339
	489, 816	22284	528,	22335	710	22401	50	22471	61	70114	339	71125	339
22232	122, 125		545, 609	22336	458, 489	22402	44, 167	22472	60	70115	339	71126	339
22233	433, 489	22285	462,	22337	446,	22403	44, 167	22473	61	70116	339	71127	339
22234	502,		489, 734		489, 686	22404	44, 167	22474	49	70117	339	71128	339
	545, 610	22286	445, 489,	22338	431,	22405	44, 167	22475	49	70118	339	71129	339
22235	813		691, 748		489, 814	22406	44, 167	22476	58	70119	339	71130	339
22236	451,	22287	691, 746	22339	531,	22407	44, 167	22477	48	70120	339	71131	339
	489, 729	22288	467,		545, 731	22408	44, 167	22478	61	70121	339	71132	339
22237	463,		489, 692	22340	822	22409	46, 295	22479	61	70122	339	71133	339
	489, 750	22289	584,	22341	44, 212	22410	47	22481	46	70123	339	71134	339
22238	491,		612, 631	22342	167	22411	63	22482	52	70124	339	71135	339
	545, 818	22290	773	22343	459,	22412	60	22483	55, 56	70125	339	71136	339
22239	744	22291	820		489, 773	22413	59	22484	49,	70126	339	71137	339
22240	450, 489	22292	93, 101,	22344	281	22414	63		56, 57	70127	339	71138	339
22241	659		130, 135	22345	741	22415	52	22485	55	70128	339	71139	339
22242	659	22293	121, 123	22346	703, 779	22416	57	22486	61	70129	339	71140	339
22243	450,	22294	93, 101,	22347	500,	22417	64	22487	60	70130	339	71141	339
	489, 671		129, 134		545, 573	22418	63	22488	59	70131	339	71142	339
22244	454,	22295	94, 103,	22348	44	22419	53	22489	60	70132	339	71143	339
	489, 701		130, 136	22349	497,	22420	64	22490	59	70133	339	71144	339
22245	474,	22296	94, 103,		545, 607	22421	64	22491	47	70134	339	71145	339
	489, 701		130, 136	22350	705, 781	22422	48	22492	48	70135	339	71146	339
22246	695	22297	685	22351	703, 779	22423	48	22493	49	70136	339	71147	339
22247	695	22298	652	22352	688	22424	56, 62	22494	57	70137	339	71148	339
22248	513,	22299	523,	22353	708	22425	46	22495	60	70138	339	71149	339
	545, 702		545, 699	22354	510,	22426	63	22497	60	70139	339	71150	339
22249	700	22300	684		545, 626	22427	59	22498	56	70140	339	71151	339
22250	470,	22301	689, 740	22355	438, 489	22428	44	22499	52	70141	339	71152	339
	489, 695	22302	439, 489	22356	438, 489	22429	58	22500	54	70142	339	71153	339
22251	453,	22303	494, 545,	22357	794	22430	48	22501	46	70143	339	71154	339
	489, 702		654, 734	22358	693, 756	22431	49	22502	62	70144	339	71155	339
22252	451,	22304	611	22359	599	22432	49,	22503	58	70145	339	71156	339
	489, 729	22305	460,	22360	46		50, 67	22504	56	70146	339	71157	339
22253	509, 545,		489, 729	22361	57	22433	51	22505	53	70147	339	71158	339
	688, 699	22306	517,	22362	755	22434	52	22506	54	70148	339	71159	339
22254	448,		545, 731	22363	50	22435	53	22507	54	70149	339	71160	339
	489, 728	22307	727	22364	58	22436	47	22508	54	70150	339		
22255	691, 746	22308	813	22365	51	22437	46	22509	50	70151	339		
22256	526,	22309	461,	22366	54	22438	53	22510	55	70152	339		
	545, 695		489, 729	22367	52	22439	62	22511	56	70153	339		
22257	745	22310	437,	22368	58	22440	57	22512	55	70154	339		
22258	561		489, 728	22369	61	22441	63	22513	57	70155	339		
22259	455, 489	22311	744	22370	54	22442	63	22514	52	70156	339		
22260	820	22312	460,	22371	47	22443	51	22515	56	70157	339		
22261	689, 745		489, 698	22372	47	22444	64	22516	55	70158	339		
22262	659	22313	459, 489,	22373	48	22445	63	22517	55	70159	339		
			687, 699										

FASTENER TERMINOLOGY

Bolt: Externally threaded, headed fastener. Difference between a bolt and a screw: a bolt is generally used through a hole with a mating nut. A screw is used in a threaded hole without a nut.

Class of Thread: A system to distinguish thread tolerance differences. Classes 1A, 2A, and 3A apply to external threads. 1B, 2B, and 3B apply to internal threads. Classes 2 and 3 apply to both external and internal threads.

Crest: Outermost tip of male thread from the fastener cylinder, or innermost tip of female thread.

Driving Recess: Recess in the fastener head designed to accept a driving tool.

External Thread: Male thread. Thread outside of the cylinder surface.

Internal Thread: Female thread. Thread on the inside surface of a cylinder or cone.

Left-Hand Thread: Thread that winds counter-clockwise from the starting end of a fastener.

Right-Hand Thread: Thread that winds clockwise from the starting end of a fastener (viewed from starting end).

Major Diameter: Largest diameter of a screw thread on a straight thread. It is the diameter of an imaginary cylinder which would pass through the crest of an external thread or the root of an internal thread.

Minor Diameter: On a straight thread it is the diameter of an imaginary cylinder bounding the root of an external thread or the crest of an internal thread.

Nominal Diameter: Basic diameter that determines the size and dimensional limits of fasteners.

Pitch: Distance from a point of a screw thread to a corresponding point on the next thread measured parallel to the axis.

Screw: Headed fastener which is externally threaded.

Sems®: Pre-assembled screw and washer assemblies. Washers are placed on screws before roll threading. Threads of larger diameter than the washer hole thus prevent the washer from slipping off the screw.

Stud: Threaded rod at both ends or for entire length.

Tapping Screw: Hardened thread screw made to cut or form its own mating thread in an untapped hole.





















Teks®: Screw which drills its own hole and then threads in.

Thread Pitch: Distance from the crest of one thread to the crest of another.









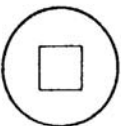

PLATINGS AND FINISHES

Finish	Color	Anti-Corrosion Properties	Characteristics and Uses	
Black Oxide	Black	Good (Interior Only): 8 Hour Salt Spray	Most Metals	Decorative finish. Used only on interior applications.
Black Zinc	Black	Excellent: 48 Hour Salt Spray	All Metals	Rich and lustrous. With or without lacquering.
Cadmium	Bright Silver- Gray Dull or Burnished	Very Good: 24 Hour Salt Spray	Most Metals	Non-porous metallic plating. Rich appearance, good rust resistance, low cost, good electrical conductivity. Bright silver-gray dull gray or black electroplated finish.
Chromium (Chrome)	Bright Blue-White	Excellent: 24 Hour Salt Spray	All Metals	Used when a beautiful finish is desired. Bright blue-white lustrous appearance. Electroplated.
Dichromate Dip	Rainbow	Excellent	All Metals	A yellow, brown, green or iridescent colored coating. Increases rust resistance. Add to Zinc or Cadmium plating.
E-Coat	Black	Excellent: 168 Hour Salt Spray	All Metals	Added protection containing corrosion inhibitors. Excellent for exterior applications.
Iridite	Green, Blue, Olive drab, Red, Bronze or Black	Excellent	All Metals	Coloring dip which adds rust resistance. Usually applied on Zinc or Cadmium.
JS-500	Chrome like luster	Excellent: 500 Hour Salt Spray	All Metals	Outstanding corrosion resistant finish that provides economical corrosion protection without adversely affecting dimensions.
Mechanical Zinc	Gray	Very Good: 48 Hour Salt Spray	All Metals	A chemical process of rust-proofing steel.
Nickel	Silver	Very Good: 24 Hour Salt Spray	All Metals	A hard, stable, dull white or bright burnished finish. Used for appliances and hardware.
Parkerized	Black	Excellent: 72 Hour Salt Spray	Ferrous Metals	Added protection when oiled with non-drying petroleum oil containing corrosion inhibitors. Good lubricity.
Phosphating	Dull, Gray, Black, or Blue	Excellent: 24 Hour Salt Spray	Ferrous Metals	A chemical process of rust-proofing steel.
Passivating		Excellent	Stainless Steels	For stainless steels. A nitric acid dip to remove foreign material and brighten finish.
Zinc Electrogalvanized	Gray	Very Good: 24 Hour Salt Spray	All Metals	Good rust resistance, appearance & low cost.
Zinc Electroplated	Blue to Blue-White-Gray	Very Good: 24 Hour Salt Spray	All Metals	Commonly used finish.



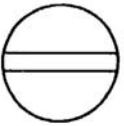







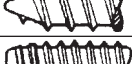
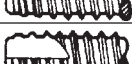
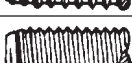

HEAD STYLES

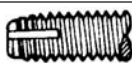
				
Binding: undercut unless otherwise specified. Not recommended for phillips recess	Fillister: deep slot used for counter bored holes	Flat Fillister: same as standard fillister without oval top	Flat 82+: used where flush surface is desired	Flat 100+: larger head than 82° used for thin metal soft plastic
				
Flat Trim: same as 82+ except diameter and countersink depth reduced	Flat Undercut: standard 82+ with lower 1/3 countersink removed for short screws	Hexagon: manufactured as trim hex or indented hex	Hex Washer: same as hexagon with washer section	Oval: same as flat head with rounded surface for appearance
				
Oval Undercut: similar to flat undercut with rounded surface	Oval Trim: same as oval, smaller diameter and countersink	Pan: recommended to replace round, truss binder	Round: general purpose (see pan head)	Round Countersunk: bolts only. Similar to flat head with no driving recess
				
Round Washer: same as round head with integral washer for bearing surface.	Square: bolts only. Large bearing surface for wrench tightening	Square Countersunk: for use on plow bolts	Square (Set Screw): recommended for high torque assembly	Truss: similar to round head with larger diameter (see pan head)

HEAD STYLES

Cross-Recessed (Phillips)		Square Socket	
Pozi Drive		Slot & Square Socket	
Frearson		Indent Hex Washer	
Phillips & Slot		Indent Slotted Hex Washer	
Slot		Phillips Pyramid	
Cross-Slot		Clutch	
	Torx®		

POINT STYLES

Type AB	
Type 17	
Type BP	
Type A	
Type B	
Type BT(25)	
Type C	
Type T(23)	
Type D(1)	
Type F	
Type G	
Type BF	
Type U	
Type TT	
Type CA	
Dog Point	

TAPPING SCREWS

Diameter, Head Size & Length Identification

Oval Head Tapping Screws

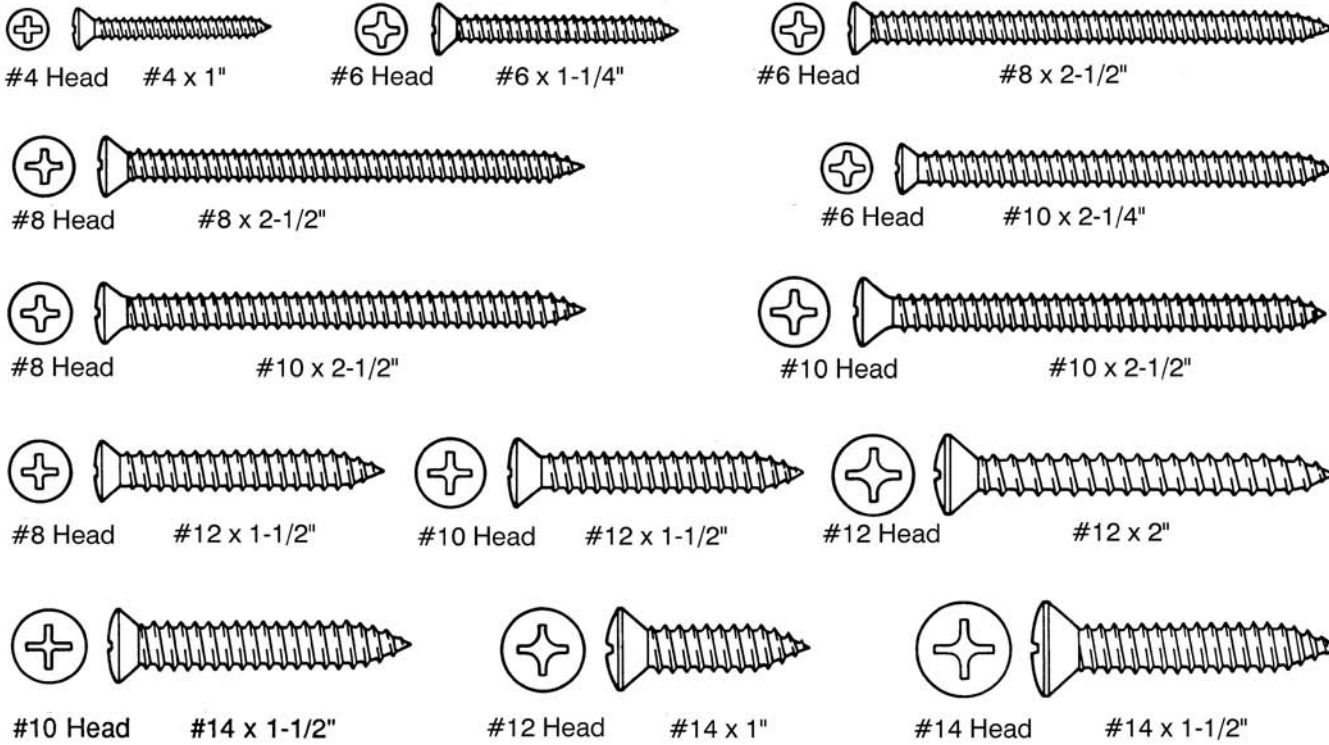

Pan Head Tapping Screws

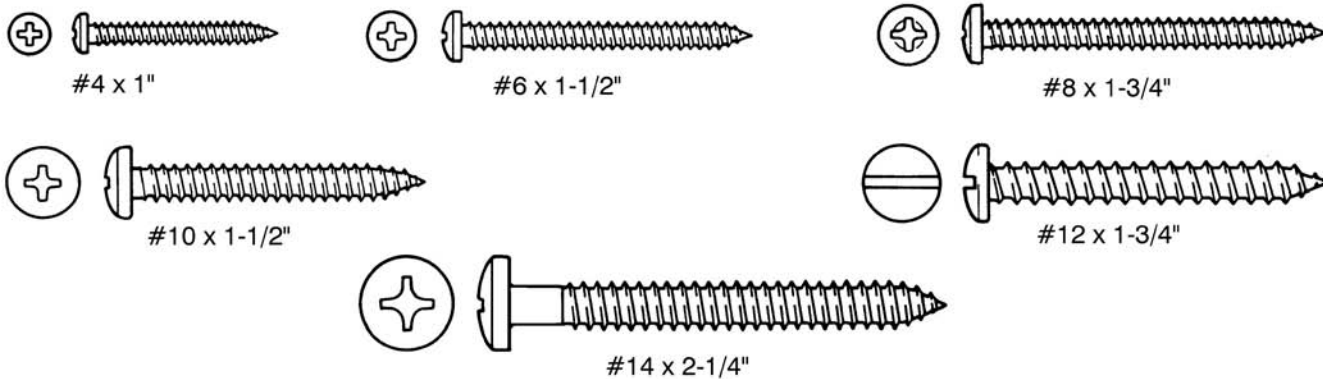

How to Measure Tapping Screws

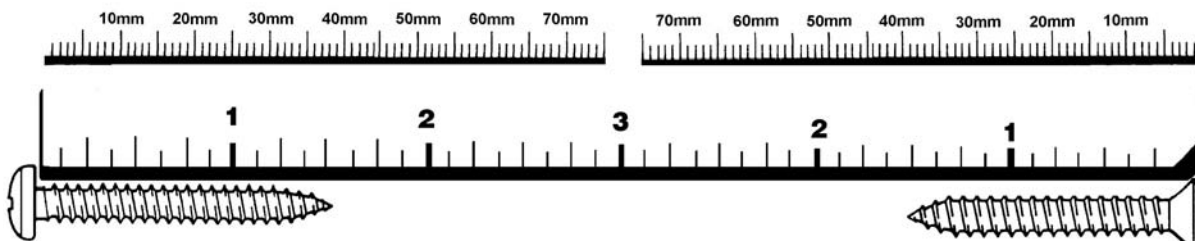

Place Pan Head, Hex Head or Hex Washer Head Screws at this end to measure the length (under the head)

Place Oval Head or Flat Head Screws in the blackened area to measure the length

TAPPING SCREWS



22348

(Ford: W702413-S450B)
Black Finish



M5-2.2 x 20mm
Torx® Pan Head Sems®
T30 Torx® Drive
Washer Diameter: 20mm
Ford Edge & Lincoln MKX 2015 - On

UNIT PACKAGE: 15

BODY BOLTS



22428

(Ford: W708464-S450B)
Black Zinc



M6-1.0 x 22mm (Includes Dog Point)
Torx® Pan Head Body Bolt with Dog Point
Type "F" Thread Cutting Feature
T30 Torx® Drive
Head Diameter: 17.5mm
Class 8.8
Ford F-150 &
Super Duty Trucks 2015 - On

UNIT PACKAGE: 15

JACK NUTS®

22402

Professional Jack Nut® Installation Tool
Tool comes with 22403 (6 - 32 thread) installation rod
Photo not actual size



An economical tool for rapidly installing Jack Nuts in any material. Takes interchangeable screw rods. Just screw rod in to Jack Nut, push into hole, squeeze to set and remove. Sets all size Jack Nut Threaded Inserts.

UNIT PACKAGE: 1

Jack Nut Installation Rods Use with 22402 Installation Tool



Auveco Part No.	Unit Pkg.	Thread
22403	1	6-32
22404	1	10-24
22405	1	1/4"-20
22406	1	4mm
22407	1	5mm
22408	1	6mm

SPLICE CLIP



22341

(GM: 1839906)

Splice Clip
Solderless & Non-Insulated
Wire Range: Max. of 3 #12 Ga.

UNIT PACKAGE: 25

DEFROSTER REPAIR

DFK-1

Rear Window Defroster
Pro Plus Repair Kit



Professional's choice for the best all-in-one defroster repair kit. The Pro Plus Kit includes everything needed to troubleshoot and repair the easiest to the most challenging rear window defroster damage.

Contents:

- 1 DFK-2 Tab Bonding Kit (7g total net weight)
- 5 each of Replacement tabs: DFT-1, DFT-3, DFT-4 & DFT-5
- 5 DFC-1 Replacement Connectors
- 1 Test Lamp
- Detailed Instructions

UNIT PACKAGE: 1

DEFROSTER REPAIR



DFK-2

Defroster Tab Bonding Kit



DeFroster Pro's Tab Bonding adhesive contains over 80% silver. High silver content is needed to produce a highly conductive bond which is required in defroster tab repair. Two part adhesive cures quickly, bonds aggressively and makes the electrical and structural connection to the defroster one simple operation.

Contents:

- 2 part adhesive (7g total net weight)
- Sandpaper
- Stir sticks
- Detailed Instructions

UNIT PACKAGE: 1

DFK-3

Defroster Tab Pack Plus Kit



Twenty of the most common factory defroster replacement tabs in a convenient kit. Compatible with vehicle defrosters including Ford, Honda, Toyota, Nissan, Subaru, GM, Chrysler & others.

Contents:

- 5 each of Replacement Tabs DFT-1, DFT-3, DFT-4 & DFT-5
- 5 Replacement Connectors DFC-1
- Detailed Instructions

UNIT PACKAGE: 1

DEFROSTER REPAIR TABS

DFT-1



Tab featured on Ford and Chrysler vehicles, but compatible with all defrosters and connectors

UNIT PACKAGE: 1*

DFT-2



Tab featured on GMC vehicles GMC Yukon, Suburban, Chevrolet Tahoe SUV, but compatible with all defrosters and connectors

UNIT PACKAGE: 1*

DFT-3



Tab featured on GM and Chrysler vehicles, but compatible with all defrosters and connectors

UNIT PACKAGE: 1*

DFT-4



Tab featured on Toyota, Honda and Nissan vehicles, but compatible with all defrosters and connectors

UNIT PACKAGE: 1*

DFT-5



Tab featured on Toyota, Honda and Subaru vehicles, but compatible with all defrosters and connectors

UNIT PACKAGE: 1*

DFT-6



Tab featured on Jeep vehicles. NOT compatible with all defrosters and connectors

UNIT PACKAGE: 1*

*5 Replacement Tabs Per Unit Package

DFC-1



Easy to attach connectors crimp on the vehicles existing defroster wire and mate with all the defroster tabs.

Contains 5 each: Connectors and Connector Covers

UNIT PACKAGE: 1

HARNES CONNECTOR



22425

(Ford: 3U2Z-14S411-FKAA, 3U2Z-14S411-FKAB, 5U2Z-14S411-XA, WPT-793, WPT-859, WPT943)

Headlight
Harness Connector
Three 16 ga. TXL 8" Wire Leads
For 9008/H13 Halogen Bulb
Replaces Auveco 20847
Ford 2004 - On

UNIT PACKAGE: 1

DRAIN PLUGS

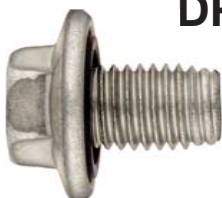

22360

(GM: 55577568)
Zinc

Oil Drain Plug with Rubber Gasket
Thread: M12-1.75
Hex: 15mm with T45 Internal Drive
Length Under Head: 17mm
Washer Head O.D.: 26.5mm
Chevrolet Sonic 2013 - On



UNIT PACKAGE: 1

RIVETS

22409

Economy Rivet Gun
Photo not actual size



With 3/32", 1/8", 5/32" and 3/16" nose pieces
Overall Length: 10"
Replacement accessories are not available

UNIT PACKAGE: 1



22458

Replacement Jaws for
Auveco Rivet Gun 19066
One Set of Jaws (2 Pieces)

UNIT PACKAGE: 1

RIVETS

22437

(Hyundai: 14160-03103)



Front & Rear Bumper
Specialty Rivet
Diameter: 3.2mm (1/8")
Flange Diameter: 6.3mm (1/4")
Grip Range: 0.8mm - 4.8mm (.032" - .189")
Black Aluminum Rivet & Steel Mandrel
Hyundai Accent, Genesis, Santa Fe,
Sonata & Veloster and Kia Borrego,
K900, Rio, Sorento & Sportage 2006 - On

UNIT PACKAGE: 25

22481

(Hyundai: 14160-03133)



Front & Rear Bumper Specialty Rivet
Diameter: 3.2mm (1/8")
Flange Diameter: 6.3mm (1/4")
Grip Range: 4.0mm - 7.9mm (.158" - .311")
Black Aluminum Rivet & Steel Mandrel
Hyundai Accent, Azera, Elantra, Equus, Santa Fe,
Santa Fe Sport, Tucson & Veracruz and Kia Optima,
Rondo, Sorento & Soul 2007 - On

UNIT PACKAGE: 25

22501

(Mazda: BN8F-50-355)



Front Bumper & Grille Specialty Rivet
Diameter: 4mm (5/32")
Flange Diameter: 8mm (5/16")
Grip Range: 1mm - 13mm (3/64" - 33/64")
Aluminum Rivet & Mandrel
Mazda 3, 5, CX-3, CX-9, Miata & MX-5 2006 - On

UNIT PACKAGE: 15

22448

(Mazda: GHP9-50-355)



Bumper, Grill & Upper Bracket Specialty Rivet
Diameter: 4mm (5/32")
Flange Diameter: 8mm (5/16")
Grip Range: 5.6mm - 9.6mm (.220" - .378")
Black Aluminum Rivet & Mandrel
Mazda 6 2014 - On

UNIT PACKAGE: 25

New

RIVETS, HOG RINGS AND GENERAL MOTORS CLIPS & FASTENERS

22436

(Hyundai: 14160-05130)



Windshield Moulding Specialty Rivet
Diameter: 4.8mm (3/16")
Flange Diameter: 10mm (3/8")
Grip Range: 1.6mm - 6.3mm (.063" - .250")
Aluminum Rivet & Steel Mandrel
Hyundai Azera, Equus, Genesis, Santa Fe
& Sonata and Kia Amanti & Forte 2004 - On

UNIT PACKAGE: 25

22371

(Chrysler: 6036679AA)



Bumper Cover Specialty Rivet
Diameter: 1/4"
Grip Range: 0.080" - 0.375"
Flange Diameter: 3/4"
Aluminum Rivet & Steel Mandrel
Dodge Nitro & Jeep Liberty 2011 - 2007

UNIT PACKAGE: 25

22451

(GM: 11546343)



Front & Rear Bumper Cover Specialty Rivet
Diameter: 4mm (5/32")
Grip Range: 5mm - 12mm (.197" - .472")
Flange Diameter: 8mm (5/16")
Aluminum Rivet & Mandrel
Cadillac CT6 2016 - On
Chevrolet Camaro 2012 - On

UNIT PACKAGE: 25

HOG RING

22450

Galvanized Steel



Small Hog Ring
Inside Diameter: .740"
Outside Diameter: .870"
Wire Diameter: .073"

UNIT PACKAGE: 500

GENERAL MOTORS CLIPS & FASTENERS



22410

(GM: 11610544)
Zinc Organic

Front Fender Panel Nut
Screw Size: M6-1.0
Overall Height: 12mm
Buick Allure, LaCrosse &
Regal 2012 - On

UNIT PACKAGE: 10



22491

(GM: 11547582)
Zinc Organic

Air Duct &
Rear Bumper Bracket Nut
Thread Size: M6-1.0
Head Size: 8mm x 18mm
Overall Height: 11mm
Cadillac CT6, Chevrolet Silverado and
GMC Acadia & Sierra 2016 - On

UNIT PACKAGE: 25



22527

(GM: 90230846; 94515248)
Natural Nylon

Lower Door &
Handle Interior Trim Grommet
Screw Size: M4.8 (#10)
Head Size: 9.5mm x 9.5mm
Stem Length: 11mm
Buick Regal 2014 - On
Chevrolet Aveo 2011 - 2009

UNIT PACKAGE: 25



22372

(GM: 25832258)
Black Nylon

Bumper, License Plate & Tail Light
Screw Grommet with Sealer
Screw Size: #14 (1/4")
Head Size: 16mm x 16mm
Stem Length: 8mm
Fits into 10mm Square Hole
Buick Enclave, Cadillac CT6,
Chevrolet Traverse, GMC Acadia
& Saturn Outlook 2007 - On

UNIT PACKAGE: 10



22430

(GM: 22884291)
White Nylon

Tail Light Grommet with Sealer
Head Diameter: 18mm
(Including Sealer)
Stem Length: 15mm
Overall Length: 18mm
Fits into 10mm Hole
Cadillac Escalade &
GMC Yukon 2015 - On

UNIT PACKAGE: 10



22373

(Not Available From O.E.M.)
Black Nylon

Rocker Panel
Moulding Clip
Top Head Size: 12mm x 20mm
Bottom Head Size: 12mm x 24mm
Stem Length: 15mm
Fits into 9mm Hole
GMC 2016 - On
Saturn Aura 2007 - On

UNIT PACKAGE: 15



22492

(GM: 11547581)
White Nylon

Body Side & Exterior Trim
Moulding Clip with Sealer
Top Head Size: 12mm x 20mm
Bottom Head Diameter: 19mm
(Including Sealer)
Stem Length: 11mm
Fits into 9mm Hole
Cadillac XT5, Chevrolet Cruze
& Impala 2014 - On

UNIT PACKAGE: 25



22477

(Not Available from O.E.M.)
Zinc

Interior Panel Fastener
Width: 10mm
Height: 12mm
GM Silverado 2014 - On

UNIT PACKAGE: 15



22453

(GM: 12375975)
Pink Nylon

Rear Cargo Door Latch Rod Clip
Rod Size: 4mm
Fits into 6mm Hole
Cadillac Escalade, Chevrolet Astro,
Express Van, Suburban & Tahoe and
GMC Safari, Savana, & Yukon 1996 - On

UNIT PACKAGE: 15

22422

(Not Available From O.E.M.)
Photo not actual size

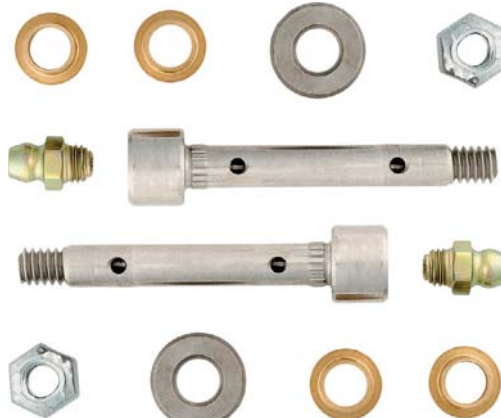

Greaseable Stainless Steel Door
Hinge Pin & Bushing Kit
Repairs Two Front Door Hinges
Cadillac ATS, CTS & STS 2005 - On
Chevrolet Cruze & Camaro 2015 - 2009

UNIT PACKAGE: 1 Kit

22423

(GM: 19355537)
Photo not actual size

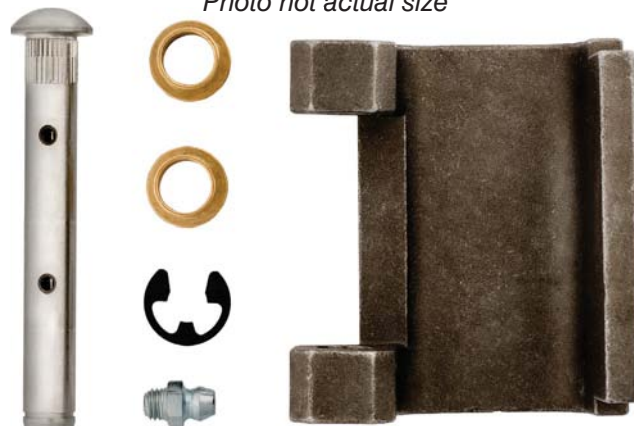

Greaseable Stainless Steel Door
Hinge Pin, Bushing & Hinge Kit
Repairs One Side Door Hinge
GM Full Size Vans 1996 - On

UNIT PACKAGE: 1 Kit

New

FORD AND CHRYSLER CLIPS & FASTENERS

FORD CLIPS & FASTENERS



22475
(Ford: W718369-S300)
Black Nylon

Rear Lamp Grommet with Sealer
Head Diameter: 18mm
Stem Length: 13mm
Overall Length: 15.6mm
Ford F-150 2015 - On

UNIT PACKAGE: 10



22474
(Ford: W717970-S300)
Black Nylon

Rear Lamp Grommet
Head Diameter: 18mm
Stem Length: 16mm
Overall Length: 18mm
Ford F-150 2015 - On

UNIT PACKAGE: 10



22493
(Ford: W719084-S300)
Black Nylon

Trim Panel Retainer
Head Diameter: 18mm
Stem Diameter: 7.5mm
Stem Length: 45mm
Ford Mustang 2016 - On

UNIT PACKAGE: 25



22484
(Mazda & Ford: E120-68-AB1;
Mitsubishi: MR975267)
Yellow Nylon

Pillar, Scuff Plate &
Trim Panel Retainer
Top Head Diameter: 13mm
Middle Head Diameter: 16.5mm
Bottom Head Diameter: 18mm
Stem Diameter: 9.3mm
Stem Length: 13mm
Overall Length: 20mm
Mazda 2 & 3 2015 - 2013
Mitsubishi Montero 1999 - On
Ford Escape (European Version)
2006 - 2000

UNIT PACKAGE: 25

FORD CLIPS & FASTENERS



22431
(Ford: W716783-S300)
Black Nylon

Hood Insulation Retainer
Head Size: 25mm x 30mm
Stem Length: 15mm
Overall Height: 17mm
Ford C-Max & Escape 2013 - On
Lincoln MKC 2016 - On

UNIT PACKAGE: 25

CHRYSLER CLIPS & FASTENERS



22432
(Chrysler: 68093998-AA; Fiat: 71728806;
Citroen & Peugeot: 856543)
White Nylon

Body Side Moulding Clip with Sealer
Top Head Size: 11mm x 12mm
Bottom Head Size: 15mm x 19mm
(Including the Sealer)
Stem Diameter: 10.3mm
Stem Length: 13mm
Fiat, Citroen, Peugeot,
Chrysler Postal Minivan Vehicles &
Dodge Ram Promaster 2014 - On

UNIT PACKAGE: 25



22461
(Chrysler: 55116997AB,
55116997AA)
White Nylon

Door Trim Panel Retainer
Top Head Diameter: 16mm
Middle Head Diameter: 18mm
Bottom Head Diameter: 22mm
Stem Diameter: 12mm
Stem Length: 19mm
Dodge Ram 2011
Jeep Liberty 2006

UNIT PACKAGE: 25



22459
(Chrysler: 6509761-AA)
Black Nylon

Front Bumper
Push-Type Retainer
Head Diameter: 20mm
Stem Length: 13.5mm
Fits into 10mm Hole
Dodge Ram &
Jeep Cherokee 2010 - On

UNIT PACKAGE: 15

CHRYSLER, BMW AND FIAT CLIPS & FASTENERS

New

CHRYSLER CLIPS & FASTENERS



22363
(Chrysler: 6510734-AA)
Black Nylon

Front Bumper
Push-Type Retainer
Head Diameter: 21.5mm
Stem Length: 14mm
Fits into 12.5mm Hole
Jeep Wrangler 2007 - On

UNIT PACKAGE: 15

BMW CLIPS & FASTENERS



22401
(BMW: 51-11-1-964-186)
Black Nylon

Bumper Cover
Push-Type Retainer
Head Diameter: 15mm
Stem Length: 20mm
Fits into 6mm Hole
BMW 3, 5, 7, X
Z Series 2010 - 1983

UNIT PACKAGE: 25

BMW CLIPS & FASTENERS

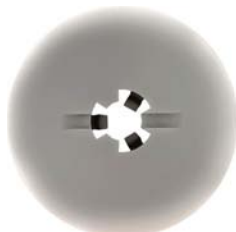

22524
(BMW: 51-48-8-126-849)
Gray Nylon

Sound Insulation Grommet
Diameter: 30mm
Stem Diameter: 9.5mm
Overall Height: 9mm
BMW 8 Series 1997 - 1994
Mini-Copper 2014 - On

UNIT PACKAGE: 25

FIAT CLIPS & FASTENERS



22432
(Chrysler: 68093998-AA; Fiat: 71728806;
Citroen & Peugeot: 856543)
White Nylon

Body Side Moulding Clip with Sealer
Top Head Size: 11mm x 12mm
Bottom Head Size: 15mm x 19mm
(Including the Sealer)
Stem Diameter: 10.3mm
Stem Length: 13mm
Fiat, Citroen, Peugeot,
Chrysler Postal Minivan Vehicles &
Dodge Ram Promaster 2014 - On

UNIT PACKAGE: 25



22521
(BMW: 52-20-1-964-201)
Black Nylon

Seat Back Panel Clip
Head Diameter: 14mm
Stem Diameter: 8mm
Stem Length: 25mm
BMW 3, 5, 7 Series, X5
& Z4 2016 - 1989

UNIT PACKAGE: 25



22509
(BMW: 07-14-7-296-886)
Black Nylon

Side Shield & Trim Retainer
Head Diameter: 24mm
Stem Diameter: 4mm
Stem Length: 23mm
T27 Drive
BMW 3 Series 2012 - On

UNIT PACKAGE: 25

STAY UP TO DATE WITH AUECO'S NEW ITEMS

Auveco releases a set of our
Hot New Items every other week.

To receive these bulletins please
contact customer service:
mail@auveco.com or 1-800-354-9816

We also have all previous and current
bulletins posted on www.auveco.com.



22365

(Honda: 90650-S5A-003)
Clear Nylon

Rear Tail Light Grommet
Head Diameter: 18.5mm
Stem Length: 24mm
Overall Length: 25mm

Acura MDX, RSX, TL, TSX 2016 - 2002
Honda Civic & Fit 2007 - 2001

UNIT PACKAGE: 25



22463

(Honda: 91513-T0A-A01)
Black Nylon

Wheel Well Arch Protective Liner
Moulding Clip with Sealer
Top Head Size: 10mm x 10mm
Bottom Head Size: 10mm x 19mm
Stem Length: 11.5mm
Honda CR-V 2012 - On

UNIT PACKAGE: 25



22464

(Honda: 75316-TP6-A01)
White Nylon

Lower Door Garnish
Moulding Clip with Sealer
Top Head Size: 10mm x 12mm
Bottom Head Size: 16mm x 21mm
Stem Length: 9mm
Fits into 10mm Hole
Honda Crosstour, Pilot &
Ridgeline 2013 - On

UNIT PACKAGE: 25



22465

(Honda: 75315-TP6-A01)
White Nylon

Lower Door Garnish
Moulding Clip with Sealer
Top Head Size: 12mm x 15mm
Bottom Head Size: 14mm x 30mm
Stem Length: 9mm
Acura & Honda Crosstour, Pilot &
Ridgeline 2013 - On

UNIT PACKAGE: 25



22466

(Honda: 91503-SWA-A01)
White Nylon

Door Belt Moulding Clip
Width: 20mm
Length: 38mm
Acura MDX 2014 - On
Honda CR-V, Pilot &
Ridgeline 2007 - On

UNIT PACKAGE: 25



22443

(Honda: 91513-TK8-A01)
White Nylon

Rocker, Pillars,
Floor & Exterior Trim
Moulding Clip with Sealer
Top Head Size: 12mm x 11mm
Bottom Head Size: 13mm x 13mm
Stem Length: 16mm
Honda Odyssey &
Ridgeline 2011 - On

UNIT PACKAGE: 25



22433

(Honda: 91514-SMG-E01)
Gray Nylon

Trunk Garnish & Spoiler
Moulding Clip with Sealer
Top Head Size: 12mm x 17mm
Bottom Head Size: 16mm x 17mm
Stem Length: 21mm
Acura RDX & Honda Accord,
Accord Crosstour, Civic,
CR-V & Pilot 2010 - On

UNIT PACKAGE: 15



22518

(Honda: 91504-SDA-003)
Black Nylon

Hood Release Cable Clip
Holds 5mm Diameter Cable
Stem Length: 6.5mm
Fits into 7mm Hole
Honda Accord, Civic &
Clarity 2003 - On

UNIT PACKAGE: 25



22467

(Honda: 91213-SZA-A01)
Gray Nylon

Pillar Garnish Clip
Top Head Size: 7mm x 7mm
Bottom Head Size: 10mm x 19mm
Stem Length: 6mm
Honda Civic, Odyssey
& Pilot 2009 - On

UNIT PACKAGE: 25



22468
 (Honda: 91514-SYP-003)
 White Nylon

Upper Side Sill
 Garnish Clip with Sealer
 Top Head Size: 18mm x 16mm
 Bottom Head Size: 22mm x 20mm
 Stem Length: 7mm
 Honda Fit & Fit EV 2014 - 2009

UNIT PACKAGE: 25



22514
 (Honda: 91512-SED-003)
 Black Nylon

Inner Fender Wheel Well Retainer
 Head Diameter: 18mm
 Stem Diameter: 4.1mm
 Stem Length: 16mm
 Honda Civic, Odyssey & Pilot 2005 - On

UNIT PACKAGE: 25



22499
 (Honda: 91560-TX4-A01)
 Yellow Nylon

Garnish Retainer with Sealer
 Top Head Diameter: 13mm
 Middle Head Diameter: 16.3mm
 Bottom Head Diameter: 18mm
 Stem Diameter: 9.5mm
 Stem Length: 13mm
 Acura ILX, MDX, RDX, RLX & TLX and
 Honda Civic, Clarity, CR-V, Fit, HR-V,
 Odyssey, Pilot & Ridgeline 2013 - On

UNIT PACKAGE: 25



22469
 (Honda: 90651-T3L-003)
 Black Nylon

Rear Bumper Garnish Retainer
 Top Head Diameter: 13mm
 Middle Head Diameter: 16.5mm
 Bottom Head Diameter: 18mm
 Stem Diameter: 9.3mm
 Stem Length: 14mm
 Acura NSX & RDX 2016 - On
 and Honda Accord & Civic 2017 - 2013

UNIT PACKAGE: 25



22482
 (Honda: 91514-TF0-003)
 Black Nylon

Rocker Moulding
 Push-Type Retainer
 Head Diameter: 18mm
 Stem Length: 13mm
 Fits into 9mm x 9mm Square Hole
 Honda Accord, Fit & Fit EV 2009 - On

UNIT PACKAGE: 25



22446
 (Honda: 91503-T1W-003)
 Gray Nylon

Bumper
 Push-Type Retainer
 Head Diameter: 20mm
 Stem Length: 13mm
 Fits into 10mm Hole
 Honda CR-V 2015 - On

UNIT PACKAGE: 15



22367
 (Honda: 91514-TR3-A01)
 Black Nylon

Fender Liner Push-Type Retainer with
 Phillips Truss Head Stainless Steel Screw
 Screw Head Diameter: 15.5mm
 Nylon Grommet
 Head Diameter: 15mm
 Stem Length: 10mm
 Fits into 9mm Square Hole
 Honda Civic 2015 - 2014

UNIT PACKAGE: 5



22434
 (Honda: 91514-SLN-A01)
 Black Metal & Nylon

Front Fender Liner &
 Engine Cover Push-Type Retainer
 Phillips Truss Head Stainless Steel Screw
 Head Diameter: 15.5mm
 Grommet Head Size: 19.3mm x 19.3mm
 Stem Length: 10mm
 Fits into 10mm Hole
 Honda Fit & Insight 2014 - 2007

UNIT PACKAGE: 5



22415
 (Honda: 90667-TC0-U01-ZA)
 Black Nylon

Trunk Interior & Side Trim
 Push-Type Retainer
 Top Head Diameter: 15.5mm
 Bottom Head Diameter: 16mm
 Stem Length: 15mm
 Fits into 7mm Hole
 Acura ILX, TLX & TSX and Honda Accord,
 HR-V & Insight 2012 - On

UNIT PACKAGE: 25

New

HONDA, ACURA, HYUNDAI AND KIA CLIPS & FASTENERS



22394

(Honda: 91561-TA0-A11,
91561-TA5-A11)
Metal & Green Nylon

Interior Trim, Pillars, Rocker
Panel, Quarter Panel &
Windshield Push-Type Retainer
Head Diameter: 18mm
Stem Length: 13mm
Overall Length: 38mm
Fits into 9mm Hole

Acura TL and Honda Accord, Civic, CR-Z,
Fit, Odyssey, Pilot & Ridgeline 2008 - On

UNIT PACKAGE: 5



22419

(Honda: 90501-SDR-003)
Black Nylon

Rocker Moulding & Mud Guard
Push-Type Retainer
Head Diameter: 20mm
Stem Length: 21mm
Fits into 10mm Hole
Acura RDX, RL & RLX and
Honda CR-V & Accord 2009 - On

UNIT PACKAGE: 25

HYUNDAI AND KIA CLIPS & FASTENERS



22505

(Hyundai: 86825-26000)
Black Nylon

Rear Fender Liner Plug
Head Diameter: 30mm
Overall Height: 16.5mm
Black Nylon
Hyundai Accent, Equus,
Genesis, Santa Fe,
Tucson & Veracruz 2011 - On
Kia Sorento 2016 - 2011

UNIT PACKAGE: 15

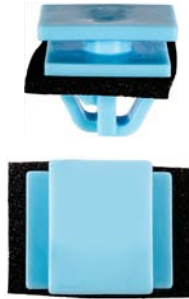

22327

(Hyundai: 87756-D3000)
Blue Nylon

Door Moulding Clip with Sealer
Top Head Size: 14mm x 18mm
Bottom Head Size: 16mm x 20mm
Stem Length: 10mm
Hyundai Tucson 2016 - On

UNIT PACKAGE: 25



22435

(Hyundai: 84219-3L000)
Black Nylon

Engine Under Cover &
Rear Bumper Moulding Grommet
Screw Size: M6-1.0
Head Diameter: 20mm
Stem Diameter: 14mm
Stem Length: 7mm
Overall Length: 9.5mm

Hyundai Azera, Equus, Genesis, Santa Fe & Sonata
and Kia Forte, Optima & Rio 2010 - On

UNIT PACKAGE: 25



22328

(Hyundai: 87758-2S000)
White Nylon

Rocker Moulding Clip
with Sealer
Head Size: 17mm x 25mm
Stem Length: 14mm
Hyundai Tucson 2016 - On

UNIT PACKAGE: 25



22438

(Hyundai: 87715-3K000)
White Nylon

Door Trim, Roof & Spoiler
Moulding Clip with Sealer
Head Size: 9mm x 18.3mm
Stem Length: 10mm
Hyundai Azera, Equus, Genesis, Sonata,
Tucson & Veloster and Kia Soul 2006 - On

UNIT PACKAGE: 25



22330

(Hyundai: 87759-2M000)
Red Nylon

Rocker Panel Moulding Clip
with Sealer
Head Size: 17mm x 25mm
Stem Length: 13mm
Hyundai Genesis 2008 - On

UNIT PACKAGE: 50



22331
 (Hyundai: 87759-3V000)
 Yellow Nylon

Rocker Panel Moulding Clip with Sealer
 Top Head Size: 12mm x 12mm
 Bottom Head Size: 14mm x 20mm
 Stem Length: 17mm
 Hyundai Azera 2012 - On
 Kia K900 2015 - On

UNIT PACKAGE: 25



22470
 (Hyundai: 87716-2W000)
 White Nylon

Fender, Body Side & Rocker
 Moulding Clip with Sealer
 Top Head Size: 10mm x 12mm
 Bottom Head Size: 14mm x 20mm
 Stem Length: 11mm
 Hyundai Santa Fe 2012 - On
 Kia Borrego 2011 - 2007 &
 Kia Niro 2017 - On

UNIT PACKAGE: 50



22508
 (Hyundai: 87756-2J000)
 Pink Nylon

Side Garnish Moulding Clip with Sealer
 Head Size: 13mm x 16mm
 Stem Diameter: 11.5mm
 Stem Length: 9mm
 Hyundai Santa Fe & Tucson 2013 - On

UNIT PACKAGE: 15



22500
 (Hyundai: 87756-3N100)
 Yellow Nylon

Trunk Side Trim Moulding Clip with Sealer
 Top Head Size: 12mm x 12mm
 Bottom Head Size: 14mm x 18mm
 Stem Diameter: 14.5mm
 Stem Length: 16mm
 Hyundai Equus 2015 - 2010

UNIT PACKAGE: 15



22366
 (Kia: 87382-2W000)
 Gray Nylon

Liftgate Moulding Clip with Sealer
 Top Head Size: 10mm x 12mm
 Bottom Head Size: 14mm x 20mm
 Stem Length: 12mm
 Overall Length: 16mm
 Kia Cadenza, Optima &
 Sorento 2013 - On

UNIT PACKAGE: 25



22506
 (Hyundai: 81174-2L000)
 Black Nylon

Hood Prop Rod Clip
 Width: 20mm
 Length: 24mm
 Holds 8mm Rod
 Hyundai Accent & Elantra 2008 - On
 Kia Forte & Soul 2013 - 2009

UNIT PACKAGE: 15



22507
 (Hyundai: 81174-21000,
 81174-11011 & 81174-21010)
 Black Nylon

Hood Prop Rod Clip
 Holds 8mm Rod
 Bottom Base Size: 20mm x 20mm
 Stem Length: 9mm
 Overall Length: 25mm
 Hyundai Elantra, Sonata,
 Tucson & Veloster 1997 - On

UNIT PACKAGE: 15



22526
 (Hyundai: 82133-37000)
 Red Nylon

Weatherstrip Retainer
 Head Size: 5mm x 13mm
 Stem Diameter: 5.5mm
 Stem Length: 6mm
 Hyundai Accent, Elantra,
 Santa Fe & Sonata 2006 - 1993

UNIT PACKAGE: 50



22370
 (Hyundai: 92485-2H000)
 White Nylon

Rear Lamp Moulding
 Retainer with Sealer
 Top Head Diameter: 17mm
 Bottom Head Diameter: 15mm
 Stem Length: 11mm
 Fits into 6mm Hole
 Hyundai Accent, Elantra, Equus,
 Genesis, Genesis Coupe, Santa Fe,
 Sonata, Veloster & Veracruz
 and Kia Forte, Optima, Rio
 & Sportage 2007 - On

UNIT PACKAGE: 15

New

LAND ROVER AND MAZDA CLIPS & FASTENERS

LAND ROVER CLIPS & FASTENERS



22485

(Land Rover: DCE100560)
Black Nylon

Tailgate Moulding Retainer
Base Size: 17.3mm x 16.3mm
Stem Diameter: 11mm
Stem Length: 15mm
Overall Height: 18.5mm

Land Rover Freelander 2006 - 1996

UNIT PACKAGE: 15



MAZDA CLIPS & FASTENERS



22483

(Mazda: S47P-64-345;
Mitsubishi: MQ907568)
White Nylon

Instrument & Side Panel Clip
Width (Ear to Ear): 10.3mm
Overall Height: 18.6mm
Mazda 2, 3, 5, 6, CX-5, CX-7, CX-9,
Miata, MPV, Protégé & RX-8
and Mitsubishi 2000 - On

UNIT PACKAGE: 25



MAZDA CLIPS & FASTENERS

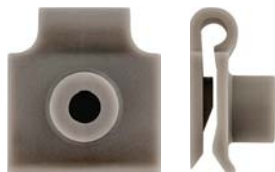

22519

(Mazda: C274-50-133)
Gray Nylon

Front Bumper Retainer Nut
Screw Size: M4.8 (#10)
Center of Hole to Edge: 11mm
Panel Range: Up to 1mm
Mazda 2, 5, 6, CX-5, CX-7 &
CX-9 2014 - 2010

UNIT PACKAGE: 25



22520

(Mazda: KD53-51-SJ3A)
Gray Nylon

Stone Guard
Moulding Clip with Sealer
Top Head Size: 10mm x 15mm
Bottom Head Diameter: 18mm
Stem Diameter: 12mm
Stem Length: 9mm
Mazda CX-5 2016 - On

UNIT PACKAGE: 25



22517

(Mazda: G46L-50-EB1)
Black Nylon

Grille Emblem Clip
Head Size: 9mm x 22mm
Stem Width: 9mm
Stem Length: 13mm
Mazda 3, CX-3, CX-5
& CX-9 2016 - On

UNIT PACKAGE: 25



22512

(Mazda: KD53-51-W24)
Gray Nylon

Wheel Arch Moulding Retainer
Top Head Diameter: 14mm
Bottom Head Diameter: 18.5mm
Stem Diameter: 11mm
Stem Length: 14mm
Mazda CX-3, CX-5
& CX-9 2013 - On

UNIT PACKAGE: 25



22516

(Mazda: D001-56-731)
Black Nylon

Hood Release Cable Clip
Holds 5mm Diameter Cable
Stem Length: 9mm
Fits into 6mm Hole
Mazda 2, 3, 5, 6, 323, 626, CX-5, CX-7,
CX-9, Miata, Millenia, MPV, MX-3, MX-6,
Protégé, RX-7 & RX-8 2013 - 1989

UNIT PACKAGE: 25



22510

(Mazda: KD51-51-W24)
White Nylon

Wheel Opening Moulding
Retainer with Sealer
Top Head Diameter: 15mm
Bottom Head Diameter: 18.5mm
Stem Diameter: 10.8mm
Stem Length: 14mm
Mazda CX-5 2014 - 2013

UNIT PACKAGE: 15

MAZDA, MERCEDES-BENZ AND MITSUBISHI CLIPS & FASTENERS

New

MAZDA CLIPS & FASTENERS



22511

(Mazda: D10E-51-SJ3)
Green Nylon

Rocker Panel Moulding Retainer with Sealer
Top Head Size: 13mm x 17mm
Bottom Head Diameter: 18.5mm
Stem Diameter: 11.7mm
Stem Length: 12mm
Mazda 3, 5, CX-3, CX-9, Miata & MX-5 2016 - On

UNIT PACKAGE: 15



22484

(Mazda & Ford: E120-68-AB1;
Mitsubishi: MR975267)
Yellow Nylon

Pillar, Scuff Plate & Trim Panel Retainer
Top Head Diameter: 13mm
Middle Head Diameter: 16.5mm
Bottom Head Diameter: 18mm
Stem Diameter: 9.3mm
Stem Length: 13mm
Overall Length: 20mm
Mazda 2 & 3 2015 - 2013
Mitsubishi Montero 1999 - On
Ford Escape (European Version) 2006 - 2000

UNIT PACKAGE: 25



22424

(Mazda: B45A-56-146A;
Toyota: 90118-WB048)
Black Nylon

Bumper, Engine Cover, Fender & Quarter Panel Push-Type Retainer
Head Diameter: 20mm
Stem Length: 13mm
Fits into 8mm Hole
Mazda 3, 5, 6, CX-3, CX-5, CX-9 & MX-5 Miata 2012 - On
Scion iA 2016 - On

UNIT PACKAGE: 25



22515

(Mazda: BGV4-56-145)
Black Nylon

Bumper Cover & Fender Liner Push-Type Retainer
Head Diameter: 20mm
Stem Length: 14mm
Fits into 8mm Hole
Mazda 2, 3, 6, CX-9 & Miata 2010 - On

UNIT PACKAGE: 25

MERCEDES-BENZ CLIP & FASTENERS



22504

(Mercedes: 009-988-03-78)
White Nylon

Lower Weatherstrip Retaining Clip
Top Head Size: 12mm x 15mm
Grommet Head Diameter: 11.3mm
Grommet Stem Length: 13mm
Overall Length: 21mm
Mercedes-Benz SLK 230 & SLK 320 2004 - 2001

UNIT PACKAGE: 25



21872

(VW: 6E0-837-732)
Turquoise Nylon

Trim Panel Retainer with Sealer
Top Head Diameter: 13mm
Middle Head Diameter: 13mm
Bottom Head Diameter: 18mm
Stem Diameter: 9mm
Stem Length: 12mm
Renault, Dacia, Mercedes, VW, Audi, SEAT & Skoda

UNIT PACKAGE: 25



22498

(Mercedes: 008-988-09-78)
Grey Nylon

Headliner Retainer
Top Head Diameter: 13.5mm
Middle Head Diameter: 13.5mm
Bottom Head Diameter: 20mm
Stem Diameter: 9.5mm
Stem Length: 13mm
Mercedes-Benz Metris & Sprinter 2010 - On

UNIT PACKAGE: 15

MITSUBISHI CLIPS & FASTENERS



22483

(Mazda: S47P-64-345;
Mitsubishi: MQ907568)
White Nylon

Instrument & Side Panel Clip
Width (Ear to Ear): 10.3mm
Overall Height: 18.6mm
Mazda 2, 3, 5, 6, CX-5, CX-7, CX-9, Miata, MPV, Protégé & RX-8 and Mitsubishi 2000 - On

UNIT PACKAGE: 25

New

MITSUBISHI, NISSAN AND INFINITI CLIPS & FASTENERS



22361

(Mitsubishi: MR489986)
Pale Yellow Nylon

Wheel Arch Cover Retainer with Sealer
Top Head Diameter: 12mm
Bottom Head Diameter: 16mm
Stem Diameter: 8mm
Stem Length: 8mm
Mitsubishi Montero 2001 - On
Outlander 2015 - On

UNIT PACKAGE: 15



22462

(Mitsubishi: MU000977)
Blue Nylon

Rocker Moulding Retainer
Top Head Diameter: 13mm
Bottom Head Diameter: 18mm
Stem Diameter: 9.8mm
Stem Length: 9mm
Mitsubishi Mirage 2014 - On

UNIT PACKAGE: 25



22513

(Mitsubishi: MU000573)
White Nylon

Interior Speaker Grille &
Rocker Moulding Retainer
Top Head Diameter: 12mm
Bottom Head Diameter: 16mm
Stem Diameter: 8mm
Stem Length: 10mm
Mitsubishi Galant 2012 - On
Lancer 2016 - 2008

UNIT PACKAGE: 25



22484

(Mazda & Ford: E120-68-AB1;
Mitsubishi: MR975267)
Yellow Nylon

Pillar, Scuff Plate & Trim Panel Retainer
Top Head Diameter: 13mm
Middle Head Diameter: 16.5mm
Bottom Head Diameter: 18mm
Stem Diameter: 9.3mm
Stem Length: 13mm
Overall Length: 20mm
Mazda 2 & 3 2015 - 2013
Mitsubishi Montero 1999 - On
Ford Escape (European Version)
2006 - 2000

UNIT PACKAGE: 25

NISSAN AND INFINITI CLIPS & FASTENERS



22522

(Nissan: 85099-1MA0A)
Yellow Nylon

Front & Rear Bumper
Screw Grommet
Screw Size: M5.5 (#12)
Top Head Size: 10mm x 10mm
Bottom Head Size: 15mm x 16mm
Stem Length: 9mm
Nissan Pathfinder, Sentra,
Versa & Versa Note 2012 - On

UNIT PACKAGE: 25



22416

(Nissan: 01281-00111)
Natural Nylon

Screw Grommet
Screw Size: M5.5 (#12)
Head Diameter: 16mm
Stem Length: 11mm
Infiniti FX35, FX45, G20, G25, G35, G37, I30,
J30, Q40, Q45, Q60, QX4 & QX56 1997 - On
Nissan 200SX, 240SX, 300ZX, Altima, Armada, Cube,
Frontier, GT-R, Juke, Leaf, Maxima, Murano, Pathfinder,
Quest, Rogue & Sentra 1987 - On

UNIT PACKAGE: 25



22494

(Nissan: 01281-01431)
Natural Nylon

Front Bumper Screw Grommet
Screw Size: M5.5 (#12)
Head Diameter: 14mm
Stem Length: 17mm
Overall Length: 20mm
Infiniti Q30 2017 - On
Nissan Altima, Cube, Maxima,
Murano, NV, Quest, Sentra,
Titan & Versa 2009 - On

UNIT PACKAGE: 25



22440

(Nissan: 26557-2U000)
Gray Nylon

Quarter Panel, Rear Light &
Spoiler Grommet with Sealer
Screw Size: M6.3-1.81 (#14)
Head Size: 15mm x 19mm
Stem Length: 16mm
Overall Length: 17.5mm
Infiniti FX35, FX50, G37, JX35, M35, M45, Q50, Q60,
QX50, QX60, QX70 & QX80 and Nissan 350Z, Altima,
Armada, Maxima, Murano, Pathfinder, Quest,
Rogue, Sentra & Versa 2003 - On

UNIT PACKAGE: 25

NISSAN, INFINITI AND SUBARU CLIPS & FASTENERS

New



22523

(Nissan: 76882-1KA1A)
Green Nylon

Rocker Panel
Moulding Clip with Sealer
Top Head Size: 10mm x 17mm
Bottom Head Diameter: 18mm
Stem Length: 12mm
Fits into 8mm Hole
Nissan Juke 2016 - On

UNIT PACKAGE: 25



22503

(Nissan: 01553-0170U)
Black Nylon

Front Bumper Cover Retainer
Head Diameter: 18mm
Stem Diameter: 8.5mm
Stem Length: 19mm
Nissan Altima 2015 - On

UNIT PACKAGE: 25



22452

(Nissan: 85284-AL510)
Gray Nylon

Rear Bumper Cover
Moulding Clip
Width: 20mm
Length: 32mm
Overall Height: 20.5mm
Infiniti G35, FX35 &
FX45 2008 - 2003
Nissan Pathfinder 2012 - 2005

UNIT PACKAGE: 5



22368

(Nissan: 84937-6P000)
Black Nylon

Trunk Knit Hook
Push-Type Retainer
Top Head Diameter: 24mm
Bottom Head Diameter: 27mm
Stem Length: 10mm
Overall Length: 25mm
Fits into 8mm Hole
Infiniti Q45 2000 - 1997
Nissan 350Z, Altima & GT-R
2003 - On

UNIT PACKAGE: 15



22476

(Nissan: 66820-4BA5A)
Black Nylon

Cowl Grille Clip
Width: 13mm x 20mm
Overall Height: 20mm
Nissan Rogue 2014 - On

UNIT PACKAGE: 25

SUBARU CLIPS & FASTENERS



22429

(Subaru: 99045SG000)
Green Nylon

Front Fender
Moulding Clip with Sealer
Top Head Size: 8mm x 12mm
Bottom Head Diameter: 14mm
Stem Diameter: 11.3mm
Stem Length: 16mm
Subaru Forester 2014 - On

UNIT PACKAGE: 15



22364

(Subaru: 94044TA040)
Gray Nylon

Door Panel Retainer
Top Head Diameter: 13mm
Middle Head Diameter: 16mm
Bottom Head Diameter: 18mm
Stem Diameter: 9mm
Stem Length: 13mm
Overall Length: 20mm
Subaru Impreza, Legacy,
Outback & STI 2016 - 2007

UNIT PACKAGE: 25



22490

(Toyota: 90541-09124)
Rubber & Nylon

Rear Door Rubber Bumper
Rubber Diameter Top: 14mm
Rubber Diameter Bottom: 17mm
Overall Height: 16.5mm
Lexus CT 200h, HS 250h, IS 250 & IS 350
and Toyota Avalon, Camry, C-HR,
Corolla, Highlander Matrix, Prius,
Prius Prime & Yaris 2009 - On
Scion iQ & tC 2016 - 2009

UNIT PACKAGE: 25



22413

(Toyota: 90541-09069)
Rubber & Nylon

Front Door Rubber Bumper
Rubber Diameter Top: 15mm
Rubber Diameter Bottom: 17mm
Overall Height: 19.5mm
Toyota 4Runner, Corolla, Highlander,
Land Cruiser, Matrix, RAV4 &
Tercel 1999 - On

UNIT PACKAGE: 25



22488

(Toyota: 81496-52020, 81496-0E020)
Natural Nylon

Rear Combination Tail Light
Guide Grommet with Sealer
Head Diameter: 16mm
Stem Length: 14mm
Overall Length: 15mm
Lexus CT 200h, ES 300h, ES 350, GX 460,
IS 200t, IS 250, IS 300, IS 350, LC 500h,
LX 570, NX 200t, NX 300h, RC F, RC 200h,
RC 300, RC 350, RX 350 & RX 450h
and Toyota 4Runner, C-HR, Corolla,
Corolla iM, Highlander, Land Cruiser,
Mirai, Prius, Prius Prime, Prius V, RAV4,
Sequoia, Venza & Yaris 2006 - On
Scion iM & xD 2016 - 2008

UNIT PACKAGE: 25



22525

(Toyota: 75494-42010,
75395-42020)
Yellow Nylon

Rocker Moulding Clip with Sealer
Top Head Size: 10.3mm x 16.5mm
Bottom Head Size: 13.5mm x 17.5mm
Stem Length: 19mm
Toyota FJ Cruiser &
RAV4 2014 - 2001

UNIT PACKAGE: 25



22456

(Toyota: 62955-50010)
Yellow Nylon

Rocker & Quarter Vent
Moulding Clip with Sealer
Top Head Size: 8mm x 8mm
Bottom Head Diameter: 15mm
Stem Diameter: 8mm x 8mm
Stem Length: 11mm
Lexus ES 250, HS 250h, LS 460, LS
600h L, RX 350 & RX 450h and Toyota
Highlander, RAV4 & Yaris 2013 - On

UNIT PACKAGE: 25



22396

(Lexus: 90467-08224)
White Nylon

Body Side & Wheel Opening
Moulding Clip
Top Head Size: 10mm x 10.5mm
Bottom Head Diameter: 15mm
Stem Diameter: 8mm x 8mm
Stem Length: 8mm
Lexus NX 200t, NX 300h, RX 350
& RX 450h 2015 - On

UNIT PACKAGE: 25



22398

(Toyota: 81496-60010)
White Nylon

Rear Combination Lamp Guide
Moulding Clip with Sealer
Top Head Diameter: 13mm
Bottom Head Diameter: 20mm
Stem Length: 10.5mm
Lexus CT 200h, ES 300h, ES 350,
GX 470, IS F, IS 250, NX 200t, NX 300h,
RC F, RC 350, RX 330, RX 350, RX 400h
& RX 450h and Toyota 4Runner, Avalon, Camry,
Camry Hybrid, Corolla, Matrix, Prius, Prius C, RAV4,
Sienna, Venza & Yaris 2006 - On
Scion iQ & iQ EV 2014 - 2011

UNIT PACKAGE: 25



22427

(Toyota: 75548-60021)
White Nylon

Rocker, Pillar, Exterior Trim &
Windshield Moulding Clip
Width: 15.5mm
Length: 52mm
Lexus LX 570 & Toyota Land Cruiser 2008 - On

UNIT PACKAGE: 10



22472

(Toyota: 90467-06005)
Black Nylon

Hood Release Cable Clamp Clip
Head Size: 16mm x 21mm
Holds 5mm Diameter Rod
Stem Diameter: 12mm
Stem Length: 9mm

Lexus CT 200h, GX 470, HS 250h,
LX 570, NX 200t, NX 300h, RX 350
& RX 450h 2003 - On

Toyota 4Runner, Avalon, Camry, Celica,
C-HR, Corolla, Land Cruiser, Matrix, Mirai,
Prius, RAV4, Tacoma & Yaris 1994 - On

UNIT PACKAGE: 25



22497

(Toyota: 65487-60010)
Black Nylon

Hood Seal Retaining Clip
Head Size: 5mm x 13mm
Stem Diameter: 7mm
Stem Length: 8mm

Lexus CT 200h, ES 300h, ES 350, GS F, GS 200t,
GS 350, GS 450h, LC 500h & LX 570 and
Toyota Land Cruiser & Mirai 2008 - On

UNIT PACKAGE: 25



22487

(Toyota: 90467-06192)
Black Nylon

Fender Liner Retaining Clip
Head Size: 14.5mm x 16mm
Stem Diameter: 10.5mm
Stem Length: 10mm
Fits into 8mm Hole

Lexus ES 300h; ES 350; GS 200h;
GS 350; GS F, GS 450h; IS 200t; IS 300,
IS 350, LS 460, LS 600h L & RC F and
Toyota Camry & RAV4 2006 - On

UNIT PACKAGE: 25



22395

(Toyota: 90467-09169-C0)
Black Nylon

Lower Fender Shield & Front Floor
Carpet Shield Retaining Clip
Head Diameter: 18mm
Stem Length: 12mm
Fits into 7mm Hole

Lexus GX 470, RX 330
& RX 400h 2009 - 2003
Toyota 4Runner, MR2 Spyder
Paseo & Tercel 2009 - 1995

UNIT PACKAGE: 15



22495

(Toyota: 90467-06205-C0)
Black Nylon

Front Fender Retaining Clip with Sealer
Head Diameter: 20mm
Stem Diameter: 8mm
Stem Length: 9mm

Lexus GS F, GS 350, GS 450h,
GX 460, HS 250h, IS 200t, IS 250, IS 300,
IS 350, LC 500h, RC F, RC 200t, RC 300,
RC350, RX 350 & RX 450h 2010 - On
Scion iQ & xD and Toyota 4Runner
& Highlander 2015 - 2008

UNIT PACKAGE: 25



22454

(Toyota: 76817-68010)
Yellow Nylon

Door Garnish Clip with Sealer
Top Head Size: 10mm x 10mm
Bottom Head Diameter: 16mm
Stem Diameter: 9.5mm x 9.5mm
Stem Length: 15mm

Lexus LX 570 and Toyota
Land Cruiser & RAV4 2013 - On

UNIT PACKAGE: 25



22412

(Toyota: 53879-0R010;
53879-28010)
Black Nylon

Front Fender Liner Clip
Slotted Head Dia.: 15.3mm
Body Width: 35mm
Toyota Highlander,
RAV4 & Tacoma and
Scion iQ & xD 2008 - On

UNIT PACKAGE: 25



22489

(Toyota: 53879-30050)
Black Nylon

Fender Liner Retaining Clip
Width: 42mm
Length: 29.5mm
Lexus GS F, GS 200t,
GS 350, GS 450h, IS 200t,
IS 250, IS 300, IS 350,
RC F, RC 200t, RC 300 &
RC 350 2013 - On

Toyota C-HR, Prius, Prius
Prime & Prius V 2016 - On

UNIT PACKAGE: 15



22457

(Toyota: 76924-13020)
Black Nylon

Rocker Moulding Retainer
Head Diameter: 25mm
Stem Length: 11mm
Fits into 14mm Hole
Toyota 4Runner &
Land Cruiser 2008 - On



UNIT PACKAGE: 25



22369

(Toyota: 90467-08188)
Black Nylon

Luggage Compartment Trim Retainer
Head Diameter: 16mm
Stem Diameter: 8mm
Stem Length: 12mm
Lexus ES 300, LS 430 &
SC 430 2010 - 1996
Toyota Prius & Sienna 2003 - 1998
Scion iQ 2015 - 2012



UNIT PACKAGE: 25



22473

(Toyota: 90467-A0002-C0)
Black Nylon

Trunk Side Trim Retainer
Head Diameter: 16mm
Stem Diameter: 8mm
Stem Length: 16mm
Lexus RX 330, RX 350 &
RX 450h 2011 - 2004
Toyota Matrix, Sienna &
Venza 2014 - 2009



UNIT PACKAGE: 25



22455

(Toyota: 90467-A0032)
White Nylon

Lower Door Moulding
Retainer with Sealer
Top Head Diameter: 10mm
Bottom Head Diameter: 15mm
Stem Diameter: 8.3mm x 8.3mm
Stem Length: 10mm
Toyota RAV4 2014 - On



UNIT PACKAGE: 25



22478

(Toyota: 75867-52020)
Blue Nylon

Rocker Panel Retainer
Top Head Diameter: 13mm
Bottom Head Diameter: 18mm
Stem Diameter: 9.5mm
Stem Length: 13mm
Overall Length: 19mm
Toyota Prius, Prius C, Prius Prime
& Yaris 2012 - On



UNIT PACKAGE: 25



22471

(Toyota: 90467-A0007)
White Nylon

Scuff Plate Retainer
Top Head Diameter: 13mm
Bottom Head Diameter: 18mm
Stem Diameter: 9.3mm
Stem Length: 11mm
Lexus RX 330, RX 350 and RX 450h
and Toyota Avalon, Camry, Matrix,
Sequoia, Sienna & Tundra 2004 - On



UNIT PACKAGE: 25



22486

(Toyota: 67771-26240)
Blue Nylon

Door Trim Retainer with Sealer
Top Head Diameter: 13mm
Middle Head Diameter: 16mm
Bottom Head Diameter: 18mm
Stem Diameter: 9.6mm
Stem Length: 10mm
Overall Length: 16.5mm
Lexus CT 200h, ES 300h, ES 350, GS
200t, GS 350, IS 200t, IS 250, IS 300, LC
500h, LS 460, NX 200t, NX 300h, RC 200t,
RC 300, RC 350, RX 350 & RX 450h
and Toyota FJ Cruiser, Prius C
& Prius V 2006 - On



UNIT PACKAGE: 25



22460

(Toyota: 62489-0E010)
White Nylon

Door Sill, Headliner, Liftgate Trim Cover,
Pillars, Scuff Plate & Window Trim Retainer
Top Head Diameter: 13mm
Middle Head Diameter: 16mm
Bottom Head Diameter: 18mm
Stem Diameter: 11mm
Stem Length: 14mm
Overall Length: 20mm
Lexus RX 350 & RX 450h 2015 - 2010
Toyota Avalon, Corolla, Highlander,
RAV4, Sienna & Venza 2013 - On



UNIT PACKAGE: 25



22479

(Lexus: 51787-60070)
White Nylon

Door Scuff Plate Retainer
Top Head Size: 12mm x 17mm
Middle Head Diameter: 15mm
Bottom Head Diameter: 18mm
Stem Diameter: 8.5mm
Stem Length: 9mm
Lexus GX 460 & LX 570 2003 - On

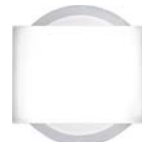

UNIT PACKAGE: 25



22400

(Toyota: 90467-07217)
Black Nylon

Radiator Support Access Cover,
Air Deflector & Side Shield
Push-Type Retainer
Head Diameter: 19mm
Stem Length: 9mm
Fits into 7mm Hole
Lexus LX, IS, GS, RX 350 &
RX 450h and Toyota Camry, Corolla,
Land Cruiser Prius, RAV4
& Yaris 2010 - On

UNIT PACKAGE: 25



22439

(Toyota: 90467-07215)
Black Nylon

Fender Liner Push-Type Retainer
Head Diameter: 20mm
Stem Length: 10mm
Fits into 7mm Hole
Scion tC and Toyota 4Runner,
Avalon, Camry, Corolla,
Highlander, Land Cruiser, Prius,
RAV4, Tacoma & Tundra 2010 - On

UNIT PACKAGE: 25



22424

(Mazda: B45A-56-146A;
Toyota: 90118-WB048)
Black Nylon

Bumper, Engine Cover, Fender &
Quarter Panel Push-Type Retainer
Head Diameter: 20mm
Stem Length: 13mm
Fits into 8mm Hole
Mazda 3, 5, 6, CX-3, CX-5, CX-9 &
MX-5 Miata 2012 - On
Scion iA 2016 - On

UNIT PACKAGE: 25



22502

(Toyota: 76923-52021)
Black Nylon

Side Mud Guard
Push-Type Retainer
Head Diameter: 29mm
Stem Length: 10mm
Fits into 22mm Hole
Lexus GS F, GS 200t, GS 350,
GS 450h, IS 200t, IS 250, IS 300,
IS 350, RC F, RC 200t, RC 300
& RC 350 2013 - On
Toyota Yaris 2011 - 2007
Scion xD 2014 - 2008

UNIT PACKAGE: 15

**GET AUVECO'S NEWEST ITEMS
AS SOON AS THEY ARE RELEASED!**



NEW ITEMS BULLETINS

Auveco releases a set of our Hot New Items every other week.

To receive these bulletins please contact customer service:

mail@auveco.com or 1-800-354-9816

We also have all previous and current bulletins posted on www.auveco.com.

New

VOLKSWAGEN AND AUDI CLIPS & FASTENERS

(Includes SEAT & Skoda)



21933

(VW: 8D0-807-192)
Green Nylon

Nylon U-Nut
Screw Size: M4.8 (#10)
Panel Range: Up to 3mm
Center of Hole to Edge: 11mm
Overall Height: 16mm
Renault, Dacia, VW, Audi, SEAT & Skoda

UNIT PACKAGE: 10



22418

(VW: N90-757-901, N903-521-01)
Black Nylon



Fender Liner Nylon Nut
Screw Size: M4.8 (#10)
Hex Size: 10mm
Flange Diameter: 22mm
Overall Height: 11mm
Audi A7, A8, Q3, RS7, S7 & S8 and
Volkswagen Beetle, Golf, GTI, Passat,
Tiguan & Touareg 2010 - On

UNIT PACKAGE: 25



22414

(VW: 8R0-853-909)
White Nylon



Door Moulding Clip with
Blue Rubber Grommet
Top Head Size: 12mm x 12mm
Stem Length: 13mm
Overall Length: 18.5mm
Audi Q3, Q3 Quattro & Q5 and
Volkswagen 2009 - On

UNIT PACKAGE: 25



22445

(VW: 3C0-853-586)
Black Nylon

Wheel Well Opening Grommet
Head Diameter: 16mm
Stem Length: 15mm
Overall Length: 16.5mm
Audi Q5 & RS5 2015 - 2009
Volkswagen Beetle, Passat,
Tiguan & Touareg 2006 - On

UNIT PACKAGE: 25



22426

(Audi: 8T0-853-909-A)
Black Nylon

Rocker Moulding Clip
Width: 16mm
Length: 40mm
Audi A4, A4 allroad,
A5, S4 & S5 2008 - On

UNIT PACKAGE: 15



22442

(Audi: 8V0-868-243)
Black Nylon

Door Trim Panel Retaining Clip
Size: 25mm x 26mm
Overall Height: 12.5mm
Audi A3, S3, Q7 & TT 2015 - On

UNIT PACKAGE: 25



22411

(VW: 3D0-864-851-B41)
Black Nylon

Floor Mat Retaining Clip
Top Head Size: 12mm x 20mm
Bottom Head Diameter: 35mm
Stem Length: 14mm
Volkswagen Golf, R32,
GTI, Rabbit, Jetta &
Passat 2016 - 2005

UNIT PACKAGE: 25



22441

(VW: 3D0-864-812-A-B41)
Black Nylon

Floor Mat Stay Retainer
Head Diameter: 30mm
Stem Diameter: 9mm
Stem Length: 14mm
Overall Length: 24.5mm
Audi & Volkswagen Beetle,
Golf & Passat 2007 - 1999

UNIT PACKAGE: 25



22447

(VW: 6Q0-853-147)
Black Nylon

Carpet, Door Sill Plate, Floor Mat,
Quarter Panel Trim, Scuff Plate &
Wheel House Retainer
Top Head Size: 12mm x 14mm
Overall Length: 21mm
Audi A3 & A4 2013 - 2005
Volkswagen Golf Alltrack, Golf, Jetta,
Passat & Rabbit 2005 - On

UNIT PACKAGE: 25



VOLKSWAGEN AND AUDI CLIPS & FASTENERS

(Includes SEAT & Skoda)

New



22399

(VW: 6Q0-807-643)
Black Nylon

Rear Bumper Trim Pin Retainer
Head Diameter: 17.5mm
Stem Length: 25mm
Overall Length: 34.3mm
Audi A1, A3, Q5, Q7 & TT and
Volkswagen CC, Eos, Golf,
Jetta, Passat, Polo, Tiguan,
Touran & Transporter 2004 - On

UNIT PACKAGE: 25



22449

(VW: N90-911-301)
Black Nylon

Interior Trim Panel &
Cowl Cover Retainer
Head Diameter: 20mm
Stem Diameter: 8mm
Stem Length: 16mm
Audi A3 & S3 2015 - On
Volkswagen Golf, Jetta &
Passat 2012 - On

UNIT PACKAGE: 25



22417

(Audi: 8U0-853-909)
Blue Nylon

Wheel Arch Opening
Moulding Retainer with Sealer
Top Head Diameter: 13.3mm
Bottom Head Diameter: 17mm
Stem Diameter: 9.3mm
Stem Length: 10mm
Audi RS & Q3 and Volkswagen Golf,
R32, GTI & Rabbit, 2015 - On

UNIT PACKAGE: 25



21872

(VW: 6E0-837-732)
Turquoise Nylon

Trim Panel Retainer with Sealer
Top Head Diameter: 13mm
Middle Head Diameter: 13mm
Bottom Head Diameter: 18mm
Stem Diameter: 9mm
Stem Length: 12mm
Renault, Dacia, Mercedes, VW,
Audi, SEAT & Skoda

UNIT PACKAGE: 25



22397

(VW: 1K0-837-199B; 8L3837199B;
811807447; 8L4833052;
8L4833051 8L837199)
Black Nylon

Front Door Push-Type Retainer
Top Head Diameter: 10mm
Bottom Head Size: 10mm x 22mm
Stem Length: 12mm
Fits into 7mm Hole
Audi A3, A4, A6, A7, A8, RS 4,
RS 6 & TT and Volkswagen Golf &
Jetta 2011 - 1996

UNIT PACKAGE: 15



22421

(VW: N10-700-901)
Black Nylon

Front Suspension Shield
Push-Type Retainer
Head Diameter: 15mm
Stem Length: 11mm
Fits into 5mm Hole
Audi A3 & Q7 and Porsche 911 &
Cayenne and Volkswagen Golf, Jetta,
Passat, Eos & Phaeton 2009 - On

UNIT PACKAGE: 25



22420

(Audi: 8K0-868-307)
Black Nylon

Fender End Plate
Push-Type Retainer
Head Diameter: 16mm
Stem Length: 12mm
Fits into 10.5mm Hole
Audi A4 allroad, A5, A7, Q7, RS5,
RS7, S5 & S7 2009 - On

UNIT PACKAGE: 25



22444

(VW: 8E0-864-229-9B9)
Black Nylon

Carpet Retaining Cap
Diameter: 30mm
Height: 15mm
Audi & Volkswagen Tiguan
2012 - On

UNIT PACKAGE: 25

Clips & Fasteners for Vehicles with European Applications



22002
(Renault & Dacia: 77-03-088-105)
Black Rubber

Rubber Bumper
Head Diameter: 15mm
Fits into 6mm Hole
Renault & Dacia

UNIT PACKAGE: 15



21901
Black Nylon

Trim Panel Retainer
Head Diameter: 14.5mm
Stem Diameter: 7.5mm
Stem Length: 13mm
Renault & Dacia

UNIT PACKAGE: 25



21928
(Renault & Dacia: 77-01-397-183)
White Nylon

Nylon Nut
Screw Size: M4.2 (#8)
Head Size: 9.5mm x 9.5mm
Stem Length: 7mm
Peugeot, Citroen,
Renault & Dacia

UNIT PACKAGE: 50



21904
(Renault & Dacia: 80-00-609-205)
Tan Nylon

Trim Panel Retainer
Head Diameter: 21mm
Stem Diameter: 7.5mm
Stem Length: 19mm
Renault & Dacia

UNIT PACKAGE: 25



21933
(VW: 8D0-807-192)
Green Nylon

Nylon U-Nut
Screw Size: M4.8 (#10)
Panel Range: Up to 3mm
Center of Hole to Edge: 11mm
Overall Height: 16mm
Renault, Dacia, VW, Audi, SEAT & Skoda

UNIT PACKAGE: 10



21903
(Renault & Dacia: 82-00-939-873)
Black Nylon

Trim Panel Retainer
Head Diameter: 21mm
Stem Diameter: 7.5mm
Stem Length: 19mm
Renault & Dacia

UNIT PACKAGE: 25



21866
(Renault & Dacia: 77-03-077-421)
Red Nylon

Moulding Clip
Head Diameter: 19mm
Stem Diameter: 9mm
Stem Length: 8mm
Overall Length: 17mm
Renault & Dacia

UNIT PACKAGE: 25



21869
(Renault & Dacia: 77-03-077-117)
Black Nylon

Trim Panel Retainer
Head Diameter: 20.5mm
Stem Diameter: 7mm
Stem Length: 14mm
Renault & Dacia

UNIT PACKAGE: 25



21867
(Renault & Dacia: 77-03-077-422)
Gray Nylon

Moulding Clip
Head Diameter: 19mm
Stem Diameter: 9mm
Stem Length: 8mm
Overall Length: 17mm
Renault & Dacia

UNIT PACKAGE: 25



21899
(Renault & Dacia: 77-03-077-444)
Black Nylon

Trim Panel Retainer
Head Diameter: 20mm
Stem Diameter 7mm
Stem Length: 16mm
Renault & Dacia

UNIT PACKAGE: 25

Clips & Fasteners for Vehicles with European Applications



21902
(Renault & Dacia: 82-00-151-367)
Gray Nylon

Trim Panel Retainer
Head Diameter: 20mm
Stem Diameter: 7.5mm
Stem Length: 14mm
Renault & Dacia

UNIT PACKAGE: 25



21872
(VW: 6E0-837-732)
Turquoise Nylon

Trim Panel Retainer with Sealer
Top Head Diameter: 13mm
Middle Head Diameter: 13mm
Bottom Head Diameter: 18mm
Stem Diameter: 9mm
Stem Length: 12mm

Renault, Dacia, Mercedes, VW, Audi, SEAT & Skoda

UNIT PACKAGE: 25



21925
Blue Nylon

Door Lock Rod Clip
Rod Size: 3mm
Peugeot, Citroen, Renault & Dacia

UNIT PACKAGE: 15

PEUGEOT AND CITROEN



21955
(Peugeot & Citroen: 6992.G2)
Natural Nylon

Nylon Nut
Screw Size: M2.9 (#4)
Head Diameter: 13mm
Stem Length: 8mm
Peugeot & Citroen

UNIT PACKAGE: 50



21957
(Peugeot & Citroen: 6991.G1)
White Nylon

Nylon Nut with Sealer
Screw Size: M4.2 (#8)
Head Size: 9.5mm x 9.5mm
Stem Length: 11mm
Peugeot & Citroen

UNIT PACKAGE: 10



21956
(Peugeot & Citroen: 9227.35)
Natural Nylon



Nylon Nut
Screw Size: M3.5 (#6)
Head Diameter: 10mm
Stem Length: 6mm
Peugeot & Citroen

UNIT PACKAGE: 25



21948
(Peugeot & Citroen: 6984.03)
Zinc Plated

Cage Screw
M6-1.0 x 20mm
Overall Length: 24mm
Peugeot & Citroen

UNIT PACKAGE: 10



21928
(Renault & Dacia: 77-01-397-183)
White Nylon

Nylon Nut
Screw Size: M4.2 (#8)
Head Size: 9.5mm x 9.5mm
Stem Length: 7mm
Peugeot, Citroen, Renault & Dacia

UNIT PACKAGE: 50



21945
(Peugeot & Citroen: 7030.16,
7030.18, 7030.17)

Cowl Fastener Set
Slotted Head Diameter: 16mm
Stem Length: 20mm
Cowl Nut Width: 23mm
Cowl Nut Height: 10mm
Nylon Washer Outside Diameter: 17mm
Zinc Plated Steel Fastener & Nut
Peugeot & Citroen

UNIT PACKAGE: 5 Sets

New

PEUGEOT & CITROEN AND HAND SANDING PADS

Clips & Fasteners for Vehicles with European Applications



21946

Cowl Fastener Set
Zinc Plated Steel Fastener
Slotted Head Diameter: 16mm
Stem Length: 21mm
Cowl Nut Width: 23mm
Cowl Nut Height: 14mm

UNIT PACKAGE: 5 Sets



21952

Natural Nylon

Door Lock Rod Clip
Used on Left-Hand Side
Rod Size: 3mm
Peugeot & Citroen

UNIT PACKAGE: 25



22432

(Chrysler: 68093998-AA; Fiat: 71728806;
Citroen & Peugeot: 856543)
White Nylon

Body Side Moulding Clip with Sealer
Top Head Size: 11mm x 12mm
Bottom Head Size: 15mm x 19mm
(Including the Sealer)
Stem Diameter: 10.3mm
Stem Length: 13mm
Fiat, Citroen, Peugeot,
Chrysler Postal Minivan Vehicles &
Dodge Ram Promaster 2014 - On

UNIT PACKAGE: 25



21953

(Peugeot & Citroen: 9147.15)
Black Nylon

Door Lock Rod Clip
Used on Left-Hand Side
Rod Size: 4mm
Peugeot & Citroen

UNIT PACKAGE: 25



21950

Black Nylon

Weatherstrip Retainer
Head Size: 5mm x 15mm
Stem Diameter: 7.3mm
Stem Length: 11mm
Peugeot & Citroen

UNIT PACKAGE: 25



21925

Blue Nylon

Door Lock Rod Clip
Rod Size: 3mm
Peugeot, Citroen,
Renault & Dacia

UNIT PACKAGE: 15



21951

(Peugeot & Citroen: 9147.14)
Black Nylon

Door Lock Rod Clip
Rod Size: 3mm
Used on Left-Hand Side
Peugeot & Citroen

UNIT PACKAGE: 25



21954

(Peugeot & Citroen: 9147.21)
White Nylon

Door Lock Rod Clip
Rod Size: 3mm
Peugeot & Citroen

UNIT PACKAGE: 25

HAND SANDING PADS

- Non-woven pads impregnated with resin and grain for a variety of applications
- Best for hand sanding parts, removing rust & cleaning/prepping surfaces



22379

Gray

Width: 6"
Length: 9"
Grit: Ultra Fine

UNIT PACKAGE:
1 (set of 10)



22380

Maroon

Width: 6"
Length: 9"
Grit: Medium

UNIT PACKAGE:
1 (set of 10)

ABRASIVES & ACCESSORIES

Photos not actual size

New

Surface Conditioning Discs



- Non-woven nylon fiber embedded with aluminum oxide abrasive grain
- For general grinding, blending, rust removal, clean-up and paint removal
 - Thicker, longer lasting material
- Fast & easy to change twist-to-lock mounting

Auveco Part No.	Size	Grade	Color	RPM	Unit Pkg.
22374	2"	Coarse	Brown	25,000	25
22375	2"	Medium	Maroon	25,000	25
22376	2"	Fine	Blue	25,000	25
22377	3"	Coarse	Brown	20,000	25
22378	3"	Medium	Maroon	20,000	25

Mini Grinding Discs



- Premium blue Zirconia grain bonded onto a tough resin backing
- Long-life on regular steels & stainless steels
 - Best for weld grinding and finishing
- Fast & easy to change twist-to-lock mounting

Auveco Part No.	Size	Grit	RPM	Unit Pkg.
22381	2"	24	25,000	25
22382	2"	36	25,000	25
22383	2"	50	25,000	25
22384	2"	80	25,000	25
22385	3"	24	20,000	25
22386	3"	36	20,000	25
22387	3"	50	20,000	25
22388	3"	80	20,000	25

Strip-Brite Disc



- Typically used for paint and coating removal
 - Quick & easy twist-to-lock mounting
 - Open-web construction impregnated with silicon carbide, provides aggressive and long-lasting performance
- Durable, three-dimensional web has a soft edge to remove paint and other coatings without damaging the metal, especially on aluminum

Auveco Part No.	Size	Color	Unit Pkg.
22391	3"	Purple	1

Twist-to-Lock Holders

- For use with mini grinding, surface conditioning & strip-brite discs
 - 1/4" Shank



22389

For 2" Discs

UNIT PACKAGE: 1



22390

For 3" Discs

UNIT PACKAGE: 1

Sec. 1

TAPPING SCREWS

Listed According to Size



Phillips Oval Head Tapping Screws



Size	Zinc Part No.	Chrome Part No.	Bk. Oxide Part No.	Unit Pkg.
4 x 3/8"	3062		12893	100
4 x 1/2"	3063	3068	12894	100
4 x 5/8"			12895	100
4 x 3/4"		3069	12896	100
4 x 1"			12897	100
6 x 3/8" 4 Hd		2802		100
6 x 1/2"	2571	2698	12795	100
6 x 5/8"	2699	1793		100
6 x 3/4"	2700	1794	12796	100
6 x 7/8"	2572			100
6 x 1"	2702	1796	12797	100
6 x 1-1/4"	2704	1797	12798	100
8 x 3/8" 6 Hd	2705	2024		100
8 x 3/8"	3484			100
8 x 1/2" 6 Hd	2706	2027	10162	100
8 x 1/2"	2358	2707	10163	100
8 x 5/8" 6 Hd		1421		100
8 x 5/8"	2574	2709		100
8 x 3/4" 6 Hd	1798	1799	10164	100
8 x 3/4"	2359	2710	10165	100
8 x 3/4" 10 Hd		20373		100
8 x 7/8" 6 Hd	1800	2711		100
8 x 7/8"	2575	2712		100
8 x 1" 6 Hd	1801	1483	10166	100
8 x 1"	2360	2713	10167	100
8 x 1-1/8" 6 Hd		1802		100
8 x 1-1/4" 6 Hd	1803	1423	10168	100
8 x 1-1/4"	2361	2716	10169	100
8 x 1-1/2" 6 Hd	2717	1932	10170	100
8 x 1-1/2" 6 Hd		1424		100
(Special Long Shank)				
8 x 1-1/2"	2362	2718	10171	100
8 x 1-3/4" 6 Hd		1933		100
8 x 2" 6 Hd	2632			100

Size	Zinc Part No.	Chrome Part No.	Bk. Oxide Part No.	Unit Pkg.
8 x 2"	2633			100
8 x 2-1/2"	3205			100
10 x 1/2" 6 Hd	2720	2656		100
10 x 1/2" 8 Hd		2657		100
10 x 1/2"	2579	2722	11084	100
10 x 5/8" 8 Hd		2724		100
10 x 5/8"	2580			100
10 x 3/4" 6 Hd	2726			100
10 x 3/4" 8 Hd	2727	1717	11087	100
10 x 3/4"	2581	2728	11086	100
10 x 1" 6 Hd	2729	1804		100
10 x 1" 8 Hd	2578	2730	11089	100
10 x 1"	2582	2731	11088	100
10 x 1-1/4" 8 Hd	2661	2734	11091	100
10 x 1-1/4"	2583	2735	11090	100
10 x 1-1/2" 6 Hd		2046		100
10 x 1-1/2" 8 Hd		20374		100
10 x 1-1/2"	2585		11092	100
10 x 1-3/4"	2586			100
10 x 2" 8 Hd	2665			100
10 x 2"	2666			100
10 x 2-1/2"	3207			100
12 x 1/2"	8044			100
12 x 3/4"	8050			100
12 x 1"	8056			100
12 x 1-1/2"	8062			100
12 x 2"	8068			100
14 x 1"	8083			100

For assortments of Phillips Oval Head Tapping Screws, refer to Fix-Kits 6003 and 6501 in the green pages.



Phillips Oval Head Tek[®] Tapping Screws Phosphate

Auveco Part No.	Size	Unit Pkg.
16736	8 x 1" 6 Hd	50



Slotted Oval Head Tapping Screws Bright Zinc Chromate

Auveco Part No.	Size	Unit Pkg.
1432	6 x 1/2"	100
1149	8 x 3/4"	100
1137	8 x 1"	100
5616	12 x 5/8"	100
5617	14 x 5/8"	100
5618	14 x 2-1/4"	100

TAPPING SCREWS

Listed According to Size

Sec. 1



Pop On Polypropylene Screw Covers & Bases

They're simple to use:

1. Place washer over pilot or starting hole for screw, nail or rivet.
2. Install fastener.
3. Place Snap Cap over washer at slight angle.
4. Simply push Snap Cap down firmly.

Covers



Auveco Part No.	Screw Size	Color	O.D.	Unit Pkg.
13831	#4	Black	1/2"	50
13832	#4	White	1/2"	50
13833	#6	Black	1/2"	50
13834	#6	White	1/2"	50
13835	#8	Black	5/8"	50
13836	#8	White	5/8"	50
13837	#10	Black	5/8"	50
13838	#10	White	5/8"	50

Bases



Auveco Part No.	Size	Use with Cover	Unit Pkg.
13839	#4	13831 & 13832	50
13840	#6	13833 & 13834	50
13841	#8	13835 & 13836	50
13842	#10	13837 & 13838	50

Metric Torx® Head Tapping Screws 300 Series Stainless Steel



Auveco Part No.	Size	Head Style	Finish	Unit Pkg.
14053	4.2 x 25mm	M7 Oval	Black Ox	50



Phillips Flat Head Tapping Screws

Size	Zinc Part No.	Unit Pkg.	Bk. Oxide Part No.	Unit Pkg.
4 x 1/4"	5646	100		
4 x 3/8"	5647	100	12899	100
4 x 1/2"	5648	100	12900	100
4 x 5/8"	5649	100		
4 x 3/4"	5650	100		
6 x 5/16"	4 Hd 2736	100		
6 x 1/2"	4 Hd 5651	100		
6 x 1/2"	1946	100	12801	100
6 x 5/8"	5653	100		
6 x 3/4"			12802	100
6 x 1"			12803	100
8 x 3/8"	6 Hd 5654	100		
8 x 7/16"	6 Hd 1479	100		
8 x 1/2"	6 Hd 2804	100	10173	100
8 x 1/2"	5655	100	10172	100
8 x 5/8"	6 Hd 5656	100		
8 x 3/4"	6 Hd 1712	100	10174	100
8 x 3/4"	2807	100	10175	100
8 x 1"	6 Hd 5660	100	10176	100
8 x 1"	5661	100	10177	100
8 x 1-1/4"	6 Hd		10178	100
8 x 1-1/4"			10179	100
8 x 1-1/2"			12806	50
10 x 1/2"			12807	100
10 x 3/4"	2810	100	12809	100
10 x 1"	5672	100	12811	50



Torx® Insert Bits for Torx Screws 1" Shank

Auveco Part No.	Bit Size	For Screw Size	Unit Pkg.
12472	T-10	No. 4	1
11949	T-15	No. 6, 8, M4.2	1
11950	T-20	No. 8, M4.2	1
12103	T-25	No. 10	1
14913	T-27	No. 12, 1/4"	1
12104	T-30	1/4"	1
12105	T-40	5/16"	1
14916*	T-55	1/2", 9/16", 5/8"	1

*1-1/4 Shank

Torx Tools

Torx Short Arm Key, Power Drive Bits and Hand Drivers are available for installing Torx Screws. Refer to the "Tools" listing in the Alphabetical Index.



Slotted Pan Head Tapping Screws
Bright Zinc Chromate

Auveco Part No.	Size	Unit Pkg.
3020	4 x 1/4"	100
3022	4 x 1/2"	100
1263	6 x 3/8"	100
1452	6 x 1/2"	100
1453	6 x 5/8"	100
1454	6 x 3/4"	100
1455	6 x 1"	100
1456	8 x 3/8"	100
1146	8 x 1/2"	100
1092	8 x 5/8"	100
1457	8 x 1"	100
3028	8 x 1-1/2"	100
1458	10 x 1/2"	100
1787	10 x 5/8"	100
1265	10 x 3/4"	100
1459	10 x 1"	100
1460	10 x 1-1/2"	100
1266	10 x 1-3/4"	100
1344	12 x 3/4"	100
1346	12 x 1"	100
3032	12 x 1-1/2"	100
1347	14 x 1/2"	100
1381	14 x 3/4"	100
1382	14 x 1"	100



Phillips Pan Head Tapping Screws

Size	Zinc Part No.	Unit Pkg.	Bk. Oxide Part No.	Unit Pkg.
4 x 1/4"	3071	100	12902	100
4 x 3/8"	3072	100	12903	100
4 x 1/2"	3073	100	12904	100
4 x 5/8"	5619	100		
4 x 3/4"	3074	100	12905	100
4 x 1"	3075	100		
6 x 1/4"	1935	100		
6 x 3/8"	1936	100	16889	100
6 x 1/2"	1937	100	11917	100
6 x 5/8"	5621	100		
6 x 3/4"	2364	100	11918	100
6 x 1"	3076	100	11919	100
6 x 1-1/8"	5623	100		
6 x 1-1/4"	3077	100	11920	100
6 x 1-1/2"	3078	100		
8 x 3/8"	1939	100		
8 x 1/2"	1940	100	10180	100
8 x 5/8"	5625	100		
8 x 3/4"	2365	100	10181	100
8 x 7/8"	5626	100		
8 x 1"	3079	100	10182	100
8 x 1-1/4"	3080	100	10183	100
8 x 1-1/2"	3081	100	12799	50
10 x 3/8"	1942	100		
10 x 1/2"	1943	100	11921	100
10 x 5/8"	2808	100		
10 x 3/4"	2366	100	11922	100
10 x 7/8"	5629	100		
10 x 1"	3082	100	11923	50
10 x 1-1/4"	3083	100	11924	50
10 x 1-1/2"	3084	100	12800	50
12 x 1/2"	3085	100		
12 x 5/8"	5630	100		
12 x 3/4"	2367	100		
12 x 1"	3086	100		
12 x 1-1/4"	3087	100		
12 x 1-1/2"	3088	100		
14 x 1/2"	3089	100		
14 x 5/8"	5632	100		
14 x 3/4"	3090	100		
14 x 7/8"	5633	100		
14 x 1"	3091	100		
14 x 1-1/4"	3092	100		
14 x 1-1/2"	3093	100		
14 x 1-3/4"	3211	100		
14 x 2"	5634	100		

GET THE KIT THAT FITS

We have several assortments in the green section.

Find the kit that holds the screws you use the most.

For assortments of Phillips Pan Head Tapping Screws refer to Fix Kits 6004 and 6038 in the green pages.

TAPPING SCREWS

Listed According to Size

Sec. 1



Phillips Oval Head Sems® Countersunk Washer Tapping Screws

Size	Chrome Part No.	Unit Pkg.	Bk. Phos. Part No.	Unit Pkg.
6 x 5/8"	3537	100	11784	100
6 x 3/4"	3538	100	11785	100
6 x 1"	3539	100	11786	100
8 x 1/2"	6 Hd		*16930	100
8 x 5/8"	6 Hd	100	11787	100
8 x 3/4"	6 Hd	100	11788	100
8 x 1"	6 Hd	100	11789	100
8 x 1-1/4"	6 Hd	100	11790	100
8 x 1-1/2"	6 Hd	50		
10 x 5/8"	8 Hd	100	14972	100
10 x 3/4"	8 Hd	100	11791	50
10 x 1"	8 Hd	100	11792	50
10 x 1-1/4"	8 Hd	100	14973	50

*Black Oxide Finish



Phillips Oval Head Sems® Flush Washer Tapping Screws

Size	Chrome Part No.	Bk. Oxide Part No.	Unit Pkg.
8 x 1/2"	6 Hd	12956	100
8 x 5/8"	6 Hd	2774	100
8 x 11/16"	6 Hd	10653	100
8 x 7/8"	6 Hd	2775	100
8 x 1"	6 Hd	12957	100
8 x 1-1/4"	6 Hd	10654	100



Countersunk



Flush

Phillips Oval Head Sems® Tek® Finishing Screws with No. 6 Head & No. 2 Drill Point

Size	Washer Type	Chrome Part No.	Phos. Part No.	Unit Pkg.
8 x 5/8"	Flush	11448	11453	100
8 x 5/8"	Ctrsnk	11449	11454	100
8 x 3/4"	Ctrsnk	11450	11455	100
8 x 1"	Ctrsnk	11451	11456	50
8 x 1-1/4"	Ctrsnk	11452	11457	50
8 x 1-1/4"	Flush		18460	50



Phillips Flat Top Washer Head Tapping Screws Black E-Coat or Zinc

Size	Washer Head O.D.	Zinc Part No.	Black E-Coat Part No.	Unit Pkg.
6 x 1/2"	3/8"		12950	100
6 x 3/4"	3/8"		*12951	100
6 x 1"	3/8"		*12952	100
8 x 1/2"	13/32"	14859	12213	100
8 x 5/8"	13/32"	14860	12214	100
8 x 3/4"	13/32"	14861	12215	100
8 x 1"	13/32"	14862	12216	100
8 x 1-1/4"	13/32"		12217	50
8 x 1-1/2"	13/32"		12218	50
8 x 2"	13/32"		19798	50
10 x 3/4"	15/32"		12953	50
10 x 1"	15/32"		12954	50
10 x 1-1/4"	15/32"		12955	50

*Black Oxide Finish



Phillips Pan Head Sems® Tapping Screws Black Phosphate

Auveco Part No.	Size	Washer O.D.	Unit Pkg.
12818	8 x 1/2"	1/2"	50
12820	8 x 3/4"	1/2"	50



Slotted Pan Head Type F Thread Cutting Screws Bright Zinc Chromate

Auveco Part No.	Size	Unit Pkg.
5290	8-32 x 1/4"	100
5291	8-32 x 3/8"	100
5292	8-32 x 1/2"	100
5298	10-24 x 3/8"	100
5301	10-24 x 3/4"	100
5307	1/4"-20 x 5/8"	100

TAPPING SCREWS

Listed According to Size



**Acorn Indented Hex Washer Head
Tapping Screws with Phillips Recess**

Auveco Part No.	Size	Hex Size	Washer O.D.	Finish	Unit Pkg.
13727	6 x 3/4"	1/4"	5/16"	Zinc	100
13728	6 x 1"	1/4"	5/16"	Zinc	100



Drill Screws
Bright Zinc Chromate
Pinch Point

Slotted Hex Washer Head Tapping Screws

Auveco Part No.	Size	Hex Size	Unit Pkg.
3367	6 x 3/8"	1/4"	100
3374	8 x 1/2"	1/4"	100
3376	8 x 3/4"	1/4"	100

Use Auveco Magnetic Socket Tool No. 7767



Self-Piercing Screws

Zinc

For material thickness up to .060
Use with magnetic chuck 7767

Auveco Part No.	Size	Hex Size	Unit Pkg.
12367	8 x 5/8"	1/4"	100
12368	8 x 3/4"	1/4"	50
12369	10 x 1/2"	1/4"	50
12370	10 x 3/4"	1/4"	50

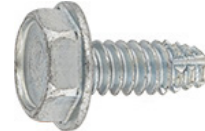

**Hexagon Washer Head
Type F Thread Cutting Screws**
Bright Zinc Chromate

Auveco Part No.	Size	Hex Size	Unit Pkg.
5759	6-32 x 3/8"	1/4"	100
5764	6-32 x 1"	1/4"	100
5766	8-32 x 3/8"	1/4"	100
5767	8-32 x 1/2"	1/4"	100
5768	8-32 x 5/8"	1/4"	100
5769	8-32 x 3/4"	1/4"	100
5773	10-24 x 3/8"	5/16"	100
5774	10-24 x 1/2"	5/16"	100
5775	10-24 x 5/8"	5/16"	100
5776	10-24 x 3/4"	5/16"	100
5778	10-24 x 1"	5/16"	100
8437	12-24 x 1/2"	5/16"	100
8438	12-24 x 3/4"	5/16"	100
8439	12-24 x 1"	5/16"	100
5781	1/4"-20 x 3/8"	3/8"	100
5782	1/4"-20 x 1/2"	3/8"	100
5783	1/4"-20 x 5/8"	3/8"	100
5784	1/4"-20 x 3/4"	3/8"	100
5786	1/4"-20 x 1"	3/8"	100
5787	1/4"-20 x 1-1/4"	3/8"	100
8441	5/16"-18 x 1/2"	1/2"	100
8442	5/16"-18 x 3/4"	1/2"	100
8443	5/16"-18 x 1"	1/2"	100
8444	5/16"-18 x 1-1/4"	1/2"	100
15355	5/16"-18 x 1-1/2"	1/2"	50
15356	5/16"-18 x 1-3/4"	1/2"	50
11294	3/8"-16 x 3/4"	9/16"	50
11295	3/8"-16 x 1"	9/16"	50
11296	3/8"-16 x 1-1/4"	9/16"	25
11297	3/8"-16 x 1-1/2"	9/16"	25
15357	3/8"-16 x 1-3/4"	9/16"	25
15358	3/8"-16 x 2"	9/16"	25

Need help identifying your screw? Please see pages 41-43.

You will find charts of screw head styles, driving recesses and point styles.

There is also brief descriptions of some common fastener terminology, as well as, plating and finish types with descriptions for each. You will also find a tapping screw diameter, head size and identification chart with an accurate to size ruler to measure your screw.

TAPPING SCREWS

Listed According to Size

Sec. 1



Teks® Self-Drilling Self-Tapping Screws

Size	Hex Size	Zinc Part No.	Unit Pkg.	Bk. Oxide Part No.	Unit Pkg.
Phillips Pan Head					
#2 Teks Point					
8 x 7/16"		9604	100		
8 x 1/2"		9605	100	16033	100
8 x 3/4"		9606	100	16034	100
8 x 1"		11904	100	16035	50
10 x 1/2"		9607	100	16036	50
10 x 3/4"		9608	100	16037	50
10 x 1"		9609	100	16038	50
12 x 1"		11905	50		

Hex Washer Head					
#2 Teks Point					
8 x 7/16"	1/4"	9610	100		
8 x 1/2"	1/4"	9611	100	16039	100
8 x 3/4"	1/4"	9612	100	16040	100
8 x 1"	1/4"	11906	100	16041	50
8 x 1-1/2"	1/4"	11908	50		
10 x 1/2"	5/16"	9613	100	16042	50
10 x 5/8"	5/16"	9614	100		
10 x 3/4"	5/16"	9615	100	16043	50
10 x 1"	5/16"	9616	100	16044	50

Super Teks® Hex Washer Head					
#3 Teks Point					
10 x 1-1/4"	5/16"	11909	50		
10 x 1-1/2"	5/16"	11910	50		
12 x 3/4"	5/16"	9617	100		
12 x 1"	5/16"	11911	25		
12 x 1-1/4"	5/16"	11912	25		
12 x 1-1/2"	5/16"	11913	25		
14 x 3/4"	3/8"	9620	100		
14 x 1"	3/8"	11914	25		
14 x 1-1/4"	3/8"	11915	25		
14 x 1-1/2"	3/8"	11916	25		

Screw Size	#2 Point	#3 Point
#8	.035" - .100"	.100" - .140"
#10	.035" - .110"	.110" - .175"
#12	.035" - .140"	.110" - .210"
#14	.035" - .175"	.110" - .210"

For an assortment of Teks Tapping Screws, see Fix-Kit No. 6144 in the green pages.

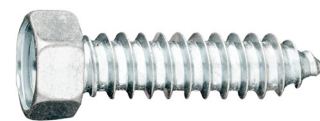

Indented Hex Head Tapping Screws

Bright Zinc Chromate

Auveco Part No.	Size	Hex Size	Unit Pkg.
2389	8 x 1/2"	1/4"	100
2485	8 x 3/4"	1/4"	100
3212	8 x 1-1/4"	1/4"	100
2487	10 x 3/4"	5/16"	100
3214	10 x 1-1/4"	5/16"	100
3215	10 x 1-1/2"	5/16"	100
1780	12 x 1/2"	5/16"	100
2107	12 x 3/4"	5/16"	100
3216	12 x 1"	5/16"	100
3217	12 x 1-1/4"	5/16"	100
2012	14 x 1/2"	3/8"	100
1781	14 x 3/4"	3/8"	100
2109	14 x 3/4"	7/16"	100
2266	14 x 1"	7/16"	100
2267	14 x 1-1/4"	7/16"	100
3219	14 x 1-1/2"	7/16"	100
2110	5/16" x 3/4"	1/2"	100
2268	5/16" x 1"	1/2"	100
2269	5/16" x 1-1/4"	1/2"	100
3220	5/16" x 1-1/2"	1/2"	100
5329	3/8" x 3/4"	9/16"	50
5330	3/8" x 1"	9/16"	50
5331	3/8" x 1-1/4"	9/16"	50
5332	3/8" x 1-1/2"	9/16"	50



Phillips Oval Head Teks® Tapping Screws

Phosphate

Auveco Part No.	Size	Hex Size	Unit Pkg.
16736	8 x 1"	6 Hd	50

Listed According to Size



**Hexagon Washer Head
Tapping Screws**

Washer attached solid to Head

Size	Hex Size	Zinc Part No.	Unit Pkg.	Bk. Oxide Part No.	Unit Pkg.
10 x 1/2"	5/16"	2369	100	16149	100
10 x 5/8"	5/16"	2809	100		
12 x 5/8"	5/16"	2967	100		
12 x 3/4"	5/16"	2968	100		
12 x 1"	5/16"	2969	100		
14 x 1/2"	3/8"	9825	100		
14 x 5/8"	3/8"	2370	100		
14 x 3/4"	3/8"	2330	100	16152	100
14 x 3/4"	7/16"	2973	100		
14 x 1"	3/8"	2974	100		
14 x 1-1/2"	3/8"	2976	100		
5/16" x 3/4"	7/16"	2978	100		
5/16" x 1"	7/16"	2979	100		
5/16" x 1-1/4"	7/16"	2980	100		
5/16" x 1-1/2"	7/16"	2981	100		



**Hexagon Head Sems®
Tapping Screws**

Bright Zinc Chromate
Washer loose from Head

Auveco Part No.	Size	Hex Size	Washer O.D.	Unit Pkg.
2604	14 x 3/4"	3/8"	5/8"	100
2988	14 x 3/4"	7/16"	21/32"	100
2605	14 x 1"	3/8"	21/32"	100
2989	14 x 1"	7/16"	21/32"	100
2991	14 x 1-1/2"	7/16"	21/32"	100
2994	5/16" x 1"	7/16"	11/16"	100
2996	5/16" x 1-1/2"	7/16"	11/16"	100



**Slotted Hexagon Washer Head
Tapping Screws**

Bright Zinc Chromate

Auveco Part No.	Size	Hex Size	Unit Pkg.
3367	6 x 3/8"	1/4"	100
3368	6 x 1/2"	1/4"	100
3369	6 x 5/8"	1/4"	100
3373	8 x 3/8"	1/4"	100
3374	8 x 1/2"	1/4"	100
3375	8 x 5/8"	1/4"	100
3376	8 x 3/4"	1/4"	100
3378	8 x 1"	1/4"	100
3379	8 x 1-1/4"	1/4"	100
3380	10 x 3/8"	5/16"	100
3381	10 x 1/2"	5/16"	100
3382	10 x 5/8"	5/16"	100
3383	10 x 3/4"	5/16"	100
3385	10 x 1"	5/16"	100
3386	10 x 1-1/4"	5/16"	100
3387	10 x 1-1/2"	5/16"	100
3388	12 x 1/2"	5/16"	100
3389	12 x 5/8"	5/16"	100
3390	12 x 3/4"	5/16"	100
3392	12 x 1"	5/16"	100
3393	12 x 1-1/4"	5/16"	100
3394	12 x 1-1/2"	5/16"	100



Hex Head Lag Screws
Zinc Plated

Auveco Part No.	Size	Hex Size	Unit Pkg.
9091	5/16" x 2-1/2"	1/2"	50
9100	3/8" x 4"	9/16"	25

TAPPING SCREWS

Listed According to Size

Sec. 1



Phillips Square Combo Drive Teks® Liner Screws with Locking Wedges under Head
Zinc & Yellow

Auveco Part No.	Size	Head Dia.	Unit Pkg.
21731	10 x 3/4"	5/8"	50
21732	10 x 1"	5/8"	50
21733	10 x 1-1/4"	5/8"	50



Torx® Wafer Head Teks® Liner Screws
Zinc

Auveco Part No.	Size	Head Dia.	Drive Size	Unit Pkg.
21734	10 x 3/4"	15/32"	T-25	50
21735	10 x 1"	15/32"	T-25	50
21736	10 x 1-1/4"	15/32"	T-25	50
21737	10 x 1-1/2"	15/32"	T-25	50



Flat Head Torx® Drive Floor Screws
Type F Thread Cutting Point
Phosphate & Oil

Auveco Part No.	Size	Drive Size	Unit Pkg.
21717	1/4"-20 x 2"	T-30	50
21718	1/4"-20 x 2-1/2"	T-30	50
21719	1/4"-20 x 3"	T-30	25
21720	1/4"-20 x 3-1/2"	T-30	25
21721	1/4"-20 x 4"	T-30	15
21722	1/4"-20 x 5"	T-30	15
21723	1/4"-20 x 6"	T-30	15

Auveco Part No.	Size	Drive Size	Unit Pkg.
21725	5/16"-18 x 2-1/4"	T-40	25
21726	5/16"-18 x 2-1/2"	T-40	25
21727	5/16"-18 x 3"	T-40	15
21728	5/16"-18 x 3-1/2"	T-40	15
21729	5/16"-18 x 4"	T-40	10
21730	5/16"-18 x 5"	T-40	10



Phillips Flat Head Wood Screws
Steel • Zinc Plated

Auveco Part No.	Size	Unit Pkg.
9555	6 x 1/2"	100
9556	6 x 3/4"	100
9557	6 x 1"	100
9564	8 x 3/4"	100
9565	8 x 1"	100
9566	8 x 1-1/4"	100
9568	8 x 1-3/4"	100
9569	10 x 3/4"	100
9570	10 x 1"	100

Auveco Part No.	Size	Unit Pkg.
9571	10 x 1-1/4"	100
9572	10 x 1-1/2"	100
9575	12 x 1"	100
9576	12 x 1-1/4"	100
9577	12 x 1-1/2"	100
9578	12 x 2"	100
9581	14 x 1-1/2"	100
9582	14 x 2"	100



Hex Washer Head Spin Lock Bolts

Grade 2 • Phosphate

Auveco Part No.	Size	Hex	Washer Head O.D.	Unit Pkg.
2753*	1/4"-20 x 5/8"	3/8"	5/8"	100
3615	5/16"-18 x 3/4"	1/2"	13/16"	100
5711	5/16"-18 x 1"	1/2"	13/16"	50
5713	5/16"-18 x 1-1/4"	1/2"	13/16"	50
2688	5/16"-24 x 1"	1/2"	13/16"	50

*Not Dog Point



Slotted Oval Head Machine Screws

Zinc Plated

Auveco Part No.	Size	Unit Pkg.
2354	10-24 x 1-1/2"	100



Phillips Oval Head Machine Screws

Steel • Zinc Plated

Size	Chrome Part No.	Zinc Part No.	Unit Pkg.
6-32 x 3/8"		16362	100
6-32 x 1/2"		16363	100
6-32 x 3/4"		16364	100
6-32 x 1-1/4"		16365	100
8-32 x 1/2"	2299	16368	100
8-32 x 3/4"		16369	100
8-32 x 3/4"	6 Hd	1863	100
8-32 x 1"		16370	100
8-32 x 1-1/4"		16371	100
8-32 x 1-1/2"		16372	50
10-24 x 1/2"		1877	100
10-24 x 3/4"	1934	16375	100
10-24 x 1"		16376	100
10-24 x 1-1/4"		16377	100
10-24 x 1-1/2"		16378	100
10-32 x 1/2"		16380	100
10-32 x 3/4"		16381	100
10-32 x 1"	8 Hd	1413	100
10-32 x 1"		16382	100
10-32 x 1-1/4"		16383	50
10-32 x 1-1/2"		16384	50
1/4"-20 x 1/2"		16385	50
1/4"-20 x 3/4"		16386	50
1/4"-20 x 1"		16387	50
1/4"-20 x 1-1/2"		16389	50

For the most up to date information on all Auveco items, including new items, inventory and online ordering please visit www.auveco.com



Slotted Round Head Machine Screws

Plain Brass

Auveco Part No.	Size	Unit Pkg.
3854	10-24 x 1"	100
3859	10-32 x 5/8"	100



Round Head Stove Bolts & Hex Nuts

Bright Zinc Chromate
U.S.S. Coarse Thread

Auveco Part No.	Size	Unit Pkg.
5697	1/8" x 1"	100
3711	3/16" x 1/2"	100
3712	3/16" x 3/4"	100
3713	3/16" x 1"	100
3715	3/16" x 1-1/2"	100
3716	3/16" x 1-3/4"	100
3717	3/16" x 2"	100
3718	1/4" x 1/2"	100
3719	1/4" x 3/4"	100
3720	1/4" x 1"	100
3722	1/4" x 1-1/2"	100
3724	1/4" x 2"	100



Phillips Pan Head Machine Screws Zinc Plated

Auveco Part No.	Size	Unit Pkg.
15374	6-32 x 3/8"	100
15375	6-32 x 1/2"	100
15376	6-32 x 3/4"	100
15377	6-32 x 1"	100
15378	6-32 x 1-1/4"	100
15379	6-32 x 1-1/2"	100
15380	8-32 x 3/8"	100
15381	8-32 x 1/2"	100
15382	8-32 x 3/4"	100
15383	8-32 x 1"	100
15385	8-32 x 1-1/2"	100
15386	10-24 x 3/8"	100
15387	10-24 x 1/2"	100
15388	10-24 x 3/4"	100
15389	10-24 x 1"	100
15390	10-24 x 1-1/4"	100
15391	10-24 x 1-1/2"	50
15392	10-32 x 3/8"	100
15393	10-32 x 1/2"	100
15394	10-32 x 3/4"	100
15395	10-32 x 1"	100
15396	10-32 x 1-1/4"	100
15397	10-32 x 1-1/2"	50
15398	1/4"-20 x 1/2"	100
15399	1/4"-20 x 3/4"	100
15400	1/4"-20 x 1"	50
15401	1/4"-20 x 1-1/4"	50
15402	1/4"-20 x 1-1/2"	50
15403	1/4"-20 x 1-3/4"	50
15404	1/4"-20 x 2"	50



Slotted Round Head Machine Screws Bright Zinc Chromate

Auveco Part No.	Size	Unit Pkg.
5700	6-32 x 3/8"	100
2530	6-32 x 1/2"	100
2531	6-32 x 3/4"	100
2532	6-32 x 1"	100
8588	6-32 x 1-1/2"	100
5702	8-32 x 3/8"	100
2533	8-32 x 1/2"	100
2534	8-32 x 3/4"	100
2535	8-32 x 1"	100
8589	8-32 x 1-1/2"	100
8590	10-32 x 3/8"	100
2536	10-32 x 1/2"	100
2537	10-32 x 3/4"	100
2538	10-32 x 1"	100
2539	10-32 x 1-1/4"	100
2540	10-32 x 1-1/2"	100
2541	10-24 x 1/2"	100
2542	10-24 x 3/4"	100
2543	10-24 x 1"	100
2544	10-24 x 1-1/4"	100
2545	10-24 x 1-1/2"	100
8594	10-24 x 2"	100
2546	12-24 x 1/2"	100
5704	12-24 x 3/4"	100
2548	12-24 x 1"	100
2550	12-24 x 1-1/2"	100
8029	1/4"-20 x 1/2"	100
8030	1/4"-20 x 3/4"	100
8031	1/4"-20 x 1"	100
8033	1/4"-20 x 1-1/2"	100
8035	1/4"-20 x 2"	100
8036	1/4"-20 x 2-1/2"	100

For assortments of Slotted Round Head Machine Screws refer to Fix Kits 6011 and 6503 in the green pages.

Visit
www.auveco.com
for easy quick online ordering



Phillips Round Head Machine Screws Zinc Plated

Auveco Part No.	Size	Unit Pkg.
16407	6-32 x 1/2"	100
16411	8-32 x 1"	100
16412	10-32 x 1/2"	100
16413	10-32 x 3/4"	100
16416	10-24 x 3/4"	100



Carriage Bolts with Hex Nuts

U.S.S. Coarse Thread • Grade 2 • Zinc Plated

Auveco Part No.	Size	Unit Pkg.
9482	1/4" x 1"	50
9483	1/4" x 1-1/2"	50
9484	1/4" x 2"	50
9485	1/4" x 2-1/2"	50
9486	1/4" x 3"	50
9487	1/4" x 4"	25
9489	1/4" x 6"	25
9490	5/16" x 1"	50
9491	5/16" x 1-1/2"	50
9492	5/16" x 2"	25

Auveco Part No.	Size	Unit Pkg.
9493	5/16" x 3"	25
9494	5/16" x 4"	25
9498	3/8" x 1"	25
9499	3/8" x 1-1/2"	25
9500	3/8" x 2"	25
9501	3/8" x 3"	25
9502	3/8" x 4"	25
9507	1/2" x 2"	10
9509	1/2" x 4"	10
9510	1/2" x 6"	10

Socket Head Set Screws
Cup Point



Auveco Part No.	Size	Unit Pkg.	Use Tool No.
5365	6-32 x 3/16"	50	5414
5366	6-32 x 1/4"	50	5414
5367	6-32 x 5/16"	50	5414
5368	6-32 x 3/8"	50	5414
5369	8-32 x 3/16"	50	5415
5370	8-32 x 1/4"	50	5415
5371	8-32 x 5/16"	50	5415
5372	8-32 x 3/8"	50	5415
5373	8-32 x 1/2"	50	5415

Part No. U.S.S.	Part No. S.A.E.	Size	Unit Pkg.	Use Tool No.
#10 U.S.S. (Coarse) Threads Per Inch: 24 S.A.E. (Fine) Threads Per Inch: 32				
5374	5394	10 x 3/16"	50	
5375	5395	10 x 1/4"	50	
5376	5396	10 x 5/16"	50	
5377		10 x 3/8"	50	
5378	5398	10 x 1/2"	50	

Part No. U.S.S.	Part No. S.A.E.	Size	Unit Pkg.	Use Tool No.
1/4" U.S.S. (Coarse) Threads Per Inch: 20 S.A.E. (Fine) Threads Per Inch: 28				
5379	5399	1/4 x 1/4"	50	
5380	5400	1/4 x 5/16"	50	
5381	5401	1/4 x 3/8"	50	
5382	5402	1/4 x 7/16"	50	
5383	5403	1/4 x 1/2"	50	

Part No. U.S.S.	Part No. S.A.E.	Size	Unit Pkg.	Use Tool No.
5/16" U.S.S. (Coarse) Threads Per Inch: 18 S.A.E. (Fine) Threads Per Inch: 24				
5384	5404	5/16 x 1/4"	50	7977*
5385	5405	5/16 x 5/16"	50	7977*
5386	5406	5/16 x 3/8"	50	7977*
5387	5407	5/16 x 7/16"	50	7977*
5388	5408	5/16 x 1/2"	50	7977*

Part No. U.S.S.	Part No. S.A.E.	Size	Unit Pkg.	Use Tool No.
3/8" U.S.S. (Coarse) Threads Per Inch: 16 S.A.E. (Fine) Threads Per Inch: 24				
5389	5409	3/8 x 5/16"	25	7978*
5390	5410	3/8 x 3/8"	25	7978*
5391	5411	3/8 x 7/16"	25	7978*
5392	5412	3/8 x 1/2"	25	7978*
5393	5413	3/8 x 5/8"	25	7978*

Part No. U.S.S.	Part No. S.A.E.	Size	Unit Pkg.	Use Tool No.
7/16" U.S.S. (Coarse) Threads Per Inch: 14 S.A.E. (Fine) Threads Per Inch: 20				
15898	15905	7/16 x 3/8"	25	7978*

Part No. U.S.S.	Part No. S.A.E.	Size	Unit Pkg.	Use Tool No.
1/2" U.S.S. (Coarse) Threads Per Inch: 13 S.A.E. (Fine) Threads Per Inch: 20				
15903		1/2 x 1/2"	25	7978*
	15910	1/2 x 5/8"	25	7978*

*Fold-up Key Set

Note: All Socket Wrenches packed 10 per Unit Package except Key Sets 7977 & 7978 which are packed 1 per Unit Package

For an assortment of Socket Head Set Screws, see Fix-Kit No. 6073 in the green pages.

All Items Phosphate & Oil

Auveco flange bolts and locknuts form a strong and dependable fastening system that substantially cuts truck assembly, maintenance and repair costs. The flange bolts are made to IFI 111 industry standard specifications. When flange bolts are used in conjunction with the flange locknuts they form a 150,000 P.S.I. tensile strength fastening system equivalent to SAE J429, Grade 8 industry standard specification. Flat washers and lock washers are not needed with the flange bolts. Our flange fastening system also reduces the need for costly hole preparations such as deburring and countersinking.



Product Specifications

Product Diameter	Flange & Nut Diameter	Screw & Nut Across Flats	Screw Head Height	Nut Height	Minimum Screw Thread Length
3/8"	.780"/.810"	.551"/.562"	.370"/.390"	.415"/.425"	1"
1/2"	1.031"/1.070"	.736"/.750"	.490"/.510"	.545"/.555"	1-1/4"
5/8"	1.300"/1.330"	.922"/.937"	.600"/.620"	.680"/.690"	1-1/2"
3/4"	1.510"/1.565"	1.110"/1.125"	.710"/.730"	.740"/.750"	1-3/4"

Grade 8 Hex Flange Bolts

Size	Auveco Part No. U.S.S.	U.S.S. Unit Pkg.	Auveco Part No. S.A.E.	S.A.E. Unit Pkg.	Size	Auveco Part No. U.S.S.	U.S.S. Unit Pkg.	Auveco Part No. S.A.E.	S.A.E. Unit Pkg.
3/8"	U.S.S. (Coarse) Threads Per Inch: 16				5/8"	U.S.S. (Coarse) Threads Per Inch: 11 S.A.E. (Fine) Threads Per Inch: 18			
3/8 x 1"	17561*	25			5/8 x 1-1/2"	17576*	10	14493*	10
3/8 x 1-1/4"	17562*	25			5/8 x 1-3/4"	17577*	10	14494*	10
3/8 x 1-1/2"	17563	25			5/8 x 2"	17578*	10	14495*	10
3/8 x 1-3/4"	17564	25			5/8 x 2-1/4"	17579*	10	14496*	10
1/2"	U.S.S. (Coarse) Threads Per Inch: 13 S.A.E. (Fine) Threads Per Inch: 20				5/8 x 2-1/2"	17580	10	14497	10
1/2 x 1"	17565*	25	14487*	10	5/8 x 2-3/4"			14498	10
1/2 x 1-1/4"	17566*	25			5/8 x 3"	17582	10	14499	10
1/2 x 1-1/2"	17567*	25	14489*	10	5/8 x 3-1/2"	17584	10		
1/2 x 1-3/4"	17568*	25	14490*	10					
1/2 x 2"	17569	15	14491	10					
1/2 x 2-1/4"	17570	15							
1/2 x 2-1/2"	17571	15							
1/2 x 3"	17573	15							
1/2 x 3-1/4"	17574	15							
1/2 x 3-1/2"	17575	15							

*Items threaded to the head

Hex Flange Locknuts

Auveco Part No.	Size	Unit Pkg.	Auveco Part No.	Size	Unit Pkg.
12517	3/8"-16 (Coarse)	50	12519	5/8"-11 (Coarse)	25
12518	1/2"-13 (Coarse)	25	14501	5/8"-18 (Fine)	25
14500	1/2"-20 (Fine)	25	15180	3/4"-10 (Coarse)	10

Sec. 2

CAP SCREWS



Grade 5



Bright Zinc Chromate
Medium Carbon Heat Treated Steel

120,000 P.S.I. Minimum Tensile Strength, Head is identified with 3 Radial Lines

Size	Part No. U.S.S.	Part No. S.A.E.	Unit Pkg.
1/4"	U.S.S. (Coarse) Threads Per Inch: 20 S.A.E. (Fine) Threads Per Inch: 28		
1/4 x 1/2"	*5434	*5495	100
1/4 x 5/8"	*5435		100
1/4 x 3/4"	*5436	*5497	100
1/4 x 1"	*5438	*5499	100
1/4 x 1-1/4"	5439	5500	100
1/4 x 1-1/2"	5440	5501	100
1/4 x 1-3/4"	5441		100
1/4 x 2"	5442		100
1/4 x 2-1/4"	5443		100
1/4 x 2-1/2"	5444	5505	100
1/4 x 2-3/4"	5445		100
1/4 x 3"	5446		100
1/4 x 3-1/2"	8449		100

Size	Part No. U.S.S.	Part No. S.A.E.	Unit Pkg.
5/16"	U.S.S. (Coarse) Threads Per Inch: 18 S.A.E. (Fine) Threads Per Inch: 24		
5/16 x 1/2"	*5447		100
5/16 x 5/8"	*5448		100
5/16 x 3/4"	*5449	*5510	100
5/16 x 7/8"	*5450		100
5/16 x 1"	*5451	*5512	100
5/16 x 1-1/4"	*5452	*5513	100
5/16 x 1-1/2"	5453	5514	100
5/16 x 1-3/4"	5454		100
5/16 x 2"	5455	5516	50
5/16 x 2-1/4"	5456		50
5/16 x 2-1/2"	5457		50
5/16 x 3"	5459		50
5/16 x 3-1/2"	5461		50
5/16 x 4"	8450		50

Size	Part No. U.S.S.	Part No. S.A.E.	Unit Pkg.
3/8"	U.S.S. (Coarse) Threads Per Inch: 16 S.A.E. (Fine) Threads Per Inch: 24		
3/8 x 5/8"	*5462		50
3/8 x 3/4"	*5463	*5524	50
3/8 x 7/8"	*5464		50
3/8 x 1"	*5465	*5526	50
3/8 x 1-1/4"	*5466	*5527	50
3/8 x 1-1/2"	5467	5528	50
3/8 x 1-3/4"	5468		50
3/8 x 2"	5469	5530	50
3/8 x 2-1/4"	5470		50
3/8 x 2-1/2"	5471		50
3/8 x 3"	5472	5533	50
3/8 x 3-1/2"	5473		50
3/8 x 4"	5474		50
3/8 x 4-1/2"	8096		25
3/8 x 5"	8097		25

*Items threaded to head

Size	Part No. U.S.S.	Part No. S.A.E.	Unit Pkg.
7/16"	U.S.S. (Coarse) Threads Per Inch: 14 S.A.E. (Fine) Threads Per Inch: 20		
7/16 x 3/4"	*5475		50
7/16 x 1"	*5476	*5537	50
7/16 x 1-1/4"	*5477	*5538	50
7/16 x 1-1/2"	*5478	*5539	50
7/16 x 1-3/4"	5479		50
7/16 x 2"	5480		25
7/16 x 2-1/2"	5481	5542	25
7/16 x 3"	5482		25
7/16 x 3-1/2"	5483		25
7/16 x 4"	5484		25

Size	Part No. U.S.S.	Part No. S.A.E.	Unit Pkg.
1/2"	U.S.S. (Coarse) Threads Per Inch: 13 S.A.E. (Fine) Threads Per Inch: 20		
1/2 x 3/4"	*5485		50
1/2 x 1"	*5486	*5547	50
1/2 x 1-1/4"	*5487		50
1/2 x 1-1/2"	*5488		25
1/2 x 1-3/4"	*5489	*5550	25
1/2 x 2"	5490	5551	25
1/2 x 2-1/2"	5491		25
1/2 x 3"	5492	5553	25
1/2 x 3-1/2"	5493		25
1/2 x 4"	5494		25
1/2 x 4-1/2"	8104		25
1/2 x 5"	8105		25
1/2 x 6"	8107		25

Size	Part No. U.S.S.	Part No. S.A.E.	Unit Pkg.
5/8"	U.S.S. (Coarse) Threads Per Inch: 11 S.A.E. (Fine) Threads Per Inch: 18		
5/8 x 1"	*9520		25
5/8 x 1-1/2"	*9521	*9528	25
5/8 x 2"	*9522	*9529	25
5/8 x 2-1/2"	9523		25
5/8 x 3"	9524		25
5/8 x 3-1/2"	9525		25
5/8 x 4"	9526		25

Size	Part No. U.S.S.	Part No. S.A.E.	Unit Pkg.
3/4"	U.S.S. (Coarse) Threads Per Inch: 10		
3/4 x 2"	*8453		10
3/4 x 2-1/2"	*8454		10
3/4 x 3"	8455		10
3/4 x 3-1/2"	8456		10

*Items threaded to head

Refer to assortment 1020 in the green pages

CAP SCREWS

Sec. 2



Grade 8

Zinc & Yellow Dichromate
Medium Carbon Alloy Steel



150,000 P.S.I. Minimum Tensile Strength, Head is identified with 6 Radial Lines

Size	Part No. U.S.S.	Part No. S.A.E.	Unit Pkg.
1/4"	U.S.S. (Coarse) Threads Per Inch: 20 S.A.E. (Fine) Threads Per Inch: 28		
1/4 x 1/2"	*9118		50
1/4 x 3/4"	*9119	*9174	50
1/4 x 1"	*9120		50
1/4 x 1-1/4"	9121		50
1/4 x 1-1/2"	9122	9177	50
1/4 x 2"	9124		50
1/4 x 2-1/4"	9125		25
1/4 x 2-1/2"	9126		25

Size	Part No. U.S.S.	Part No. S.A.E.	Unit Pkg.
5/16"	U.S.S. (Coarse) Threads Per Inch: 18 S.A.E. (Fine) Threads Per Inch: 24		
5/16 x 1/2"	*9127		50
5/16 x 3/4"	*9128		50
5/16 x 1"	*9129	*9184	50
5/16 x 1-1/4"	*9130		50
5/16 x 1-1/2"	9131	9186	50
5/16 x 1-3/4"	9132		50
5/16 x 2"	9133	9188	50
5/16 x 2-1/2"	9134		25
5/16 x 3"	9135		25

Size	Part No. U.S.S.	Part No. S.A.E.	Unit Pkg.
3/8"	U.S.S. (Coarse) Threads Per Inch: 16 S.A.E. (Fine) Threads Per Inch: 24		
3/8 x 3/4"	*9136	*9191	50
3/8 x 1"	*9137	*9192	50
3/8 x 1-1/4"	*9138	*9193	50
3/8 x 1-1/2"	9139	9194	50
3/8 x 2"	9140		25
3/8 x 2-1/2"	9141		25
3/8 x 3"	9142		25
3/8 x 3-1/2"	17028		15
3/8 x 4"	9143		25

*Items threaded to head

Size	Part No. U.S.S.	Part No. S.A.E.	Unit Pkg.
7/16"	U.S.S. (Coarse) Threads Per Inch: 14 S.A.E. (Fine) Threads Per Inch: 20		
7/16 x 1"	*9144	*9199	25
7/16 x 1-1/4"	*9145		25
7/16 x 1-1/2"	*9146	*9201	25
7/16 x 2"	9147		25
7/16 x 2-1/2"	9148	9203	25
7/16 x 3"	9149		25
7/16 x 4"	9150		25
7/16 x 5-1/2"	17031		10

Size	Part No. U.S.S.	Part No. S.A.E.	Unit Pkg.
1/2"	U.S.S. (Coarse) Threads Per Inch: 13 S.A.E. (Fine) Threads Per Inch: 20		
1/2 x 1"	*9151		25
1/2 x 1-1/4"	*9152		25
1/2 x 1-1/2"	*9153	*9208	25
1/2 x 1-3/4"	*9154		25
1/2 x 2"	9155	9210	25
1/2 x 2-1/2"	9156		25
1/2 x 2-3/4"		17983	10
1/2 x 3"	9157	9212	10
1/2 x 4"	9158		10
1/2 x 5"	9159		10

Size	Part No. U.S.S.	Part No. S.A.E.	Unit Pkg.
5/8"	U.S.S. (Coarse) Threads Per Inch: 11 S.A.E. (Fine) Threads Per Inch: 18		
5/8 x 1-1/2"	*9160		10
5/8 x 2"	*9161		10
5/8 x 2-1/2"	9162		10
5/8 x 3"	9163		10
5/8 x 3-1/2"	17499		10
5/8 x 4"	9164	9219	10
5/8 x 5"	9165		10

Size	Part No. U.S.S.	Part No. S.A.E.	Unit Pkg.
3/4"	U.S.S. (Coarse) Threads Per Inch: 10 S.A.E. (Fine) Threads Per Inch: 16		
3/4 x 2"	*9167		10
3/4 x 3"	9169	9224	10
3/4 x 3-1/2"	9170		10
3/4 x 4"	9171		10
3/4 x 5"	9172		10

*Items threaded to head

Refer to assortment 1030 in the green pages



**Stainless Steel Phillips
Pan Head Tapping Screws**

Auveco Part No.	Size	Unit Pkg.
13265	6 x 1/2"	100
13266	6 x 3/4"	100
13267	6 x 1"	100
13268	6 x 1-1/4"	100
13269	8 x 1/2"	100
13270	8 x 3/4"	50
13271	8 x 1"	50
13272	8 x 1-1/4"	50
13273	8 x 1-1/2"	25
13274	10 x 1/2"	100
13275	10 x 3/4"	50
13276	10 x 1"	50
13277	10 x 1-1/4"	50
13278	10 x 1-1/2"	25
13279	10 x 1-3/4"	25
13280	12 x 1/2"	50
13281	12 x 3/4"	50
13282	12 x 1"	50
13283	12 x 1-1/4"	25
13284	12 x 1-1/2"	25
21609	14 x 3/4"	100



**Stainless Steel Slotted
Round Head Machine Screws**

Auveco Part No.	Size	Unit Pkg.
13293	6-32 x 1/4"	100
13294	6-32 x 1/2"	100
13298	8-32 x 1/4"	100
13299	8-32 x 1/2"	100
13300	8-32 x 3/4"	100
13301	8-32 x 1"	100
13302	8-32 x 1-1/4"	50
13304	10-24 x 1/2"	100
13306	10-24 x 1"	50
13308	10-24 x 1-1/2"	50
13310	10-32 x 1/2"	100
13311	10-32 x 3/4"	100
13312	10-32 x 1"	50
13314	10-32 x 1-1/2"	50
13316	1/4"-20 x 3/4"	50



**Stainless Steel Phillips
Oval Head Tapping Screws**

Auveco Part No.	Size	Unit Pkg.
9399	6 x 1/2"	100
9400	6 x 3/4"	100
9401	6 x 1"	100
9402	6 x 1-1/4"	100
9403	8 x 1/2"	100
9404	8 x 3/4"	100
9405	8 x 1"	100
9406	8 x 1-1/4"	100
9407	8 x 1-1/2"	100
9408	10 x 1/2"	100
9409	10 x 3/4"	100
9410	10 x 1"	100
9411	10 x 1-1/4"	100
9412	10 x 1-1/2"	100
13286	10 x 1-3/4"	25
13288	12 x 3/4"	50
13289	12 x 1"	50
13290	12 x 1-1/4"	25
13291	12 x 1-1/2"	25
13292	12 x 1-3/4"	25



**Stainless Steel Phillips Oval Head
Machine Screws**

Auveco Part No.	Size	Unit Pkg.
13322	6-32 x 1/2"	100
13323	6-32 x 3/4"	100
13324	6-32 x 1"	100
13325	6-32 x 1-1/4"	100
13326	8-32 x 1/4"	100
13327	8-32 x 1/2"	100
13328	8-32 x 3/4"	100
13329	8-32 x 1"	100
13330	8-32 x 1-1/4"	50
13331	10-24 x 1/2"	100
13332	10-24 x 3/4"	50
13333	10-24 x 1"	50
13334	10-24 x 1-1/4"	50
13335	10-24 x 1-1/2"	50
13336	10-32 x 1/2"	100
13337	10-32 x 3/4"	50
13338	10-32 x 1"	50
13339	10-32 x 1-1/4"	50
13340	10-32 x 1-1/2"	50
13341	1/4"-20 x 1/2"	50
13342	1/4"-20 x 3/4"	50
13343	1/4"-20 x 1"	25
13344	1/4"-20 x 1-1/4"	25
13345	1/4"-20 x 1-1/2"	25

STAINLESS STEEL

18-8 (300 SERIES)

Sec. 2



U.S.S. Coarse Thread Stainless Steel Hex Head Cap Screws

Auveco Part No.	Bolt Size	Unit Pkg.	Auveco Part No.	Bolt Size	Unit Pkg.
13346*	1/4"-20 x 1/2"	50	13362*	3/8"-16 x 1/2"	50
13347*	1/4"-20 x 3/4"	50	13363*	3/8"-16 x 3/4"	50
13348	1/4"-20 x 1"	50	13364*	3/8"-16 x 1"	50
13349	1/4"-20 x 1-1/4"	50	13365	3/8"-16 x 1-1/4"	25
13350	1/4"-20 x 1-1/2"	50	13366	3/8"-16 x 1-1/2"	25
13352	1/4"-20 x 2"	25	13367	3/8"-16 x 1-3/4"	25
			13368	3/8"-16 x 2"	25
13353*	5/16"-18 x 1/2"	50	13370	3/8"-16 x 2-1/2"	25
13354*	5/16"-18 x 3/4"	25	13391	3/8"-16 x 3"	25
13355	5/16"-18 x 1"	25			
13356	5/16"-18 x 1-1/4"	25	13373*	1/2"-13 x 1"	10
13357	5/16"-18 x 1-1/2"	25	13374*	1/2"-13 x 1-1/4"	10
13359	5/16"-18 x 2"	25	13375	1/2"-13 x 1-1/2"	10
13360	5/16"-18 x 2-1/4"	25	13377	1/2"-13 x 2"	10
13361	5/16"-18 x 2-1/2"	25			

*Items threaded to head

Stainless Steel Cotter Pins Extended Prong Type



Auveco Part No.	Size	Rec. Hole Size	Unit Pkg.	Auveco Part No.	Size	Rec. Hole Size	Unit Pkg.
13409	1/16" x 3/4"	.078	100	13420	1/8" x 1"	.141	50
13410	1/16" x 1"	.078	100	13421	1/8" x 1-1/4"	.141	50
				13422	1/8" x 1-1/2"	.141	50
13411	3/32" x 1/2"	.109	100	13424	1/8" x 2"	.141	25
13412	3/32" x 3/4"	.109	100	13426	1/8" x 2-1/2"	.141	25
13413	3/32" x 1"	.109	100				
13414	3/32" x 1-1/4"	.109	50	13429	5/32" x 1-1/4"	.172	25
13415	3/32" x 1-1/2"	.109	50	13430	5/32" x 1-1/2"	.172	25
13417	3/32" x 2"	.109	50	13434	5/32" x 2-1/2"	.172	25



Stainless Steel Wing Nuts

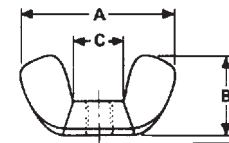

Auveco Part No.	Size	Wing Spread (A)		Overall Height (B)		Between Wing (C)		Unit Pkg.
		Max.	Min.	Max.	Min.	Max.	Min.	
13256	10-24	.91	.78	.47	.34	.27	.22	25
13258	1/4"-20	1.10	.97	.57	.43	.39	.26	25



**Stainless Steel
Hex Machine Screw Nuts**

Auveco Part No.	Size	Hex Width	Unit Pkg.
13260	6-32	5/16"	100
13261	8-32	11/32"	100
13262	10-24	3/8"	100
13263	10-32	3/8"	100
13264	1/4"-20	7/16"	100



Stainless Steel Acorn Nuts

Auveco Part No.	Size	Hex Width	Unit Pkg.
13248	6-32	5/16"	25
13249	8-32	5/16"	25
13251	10-32	3/8"	25
13252	1/4"-20	7/16"	25
13253	5/16"-18	9/16"	10



Stainless Steel Hex Nuts

Auveco Part No.	Size	Hex Width	Thick-ness	Unit Pkg.
13234	1/4"-20	7/16"	7/32"	100
13235	5/16"-18	1/2"	17/64"	50
13236	3/8"-16	9/16"	21/64"	50
13237	1/2"-13	3/4"	7/16"	25



Stainless Steel Nylon Insert Lock Nuts

Auveco Part No.	Size	Hex Width	Unit Pkg.
13239	6-32	5/16"	50
13240	8-32	11/32"	50
13241	10-24	3/8"	50
13242	10-32	3/8"	50
13243	1/4"-20	7/16"	50
13244	5/16"-18	1/2"	25
13245	3/8"-16	9/16"	25
13246	1/2"-13	3/4"	10



Stainless Steel Medium Split Washers

Auveco Part No.	Size	O.D.	Thick-ness	Unit Pkg.
13401	#8	19/64"	.040	100
13402	#10 (3/16")	21/64"	.047	100
13403	1/4"	31/64"	.062	100
13404	5/16"	19/32"	.078	100
13405	3/8"	11/16"	.094	100
13406	1/2"	7/8"	.125	50



Stainless Steel Flat Washers

Auveco Part No.	Bolt Size	I.D.	O.D.	Thick-ness	Unit Pkg.
13392	#6 (1/8")	9/64"	3/8"	.030	100
13393	#8	5/32"	3/8"	.030	100
13394	#10 (3/16")	7/32"	7/16"	.030	100
13395	1/4"	9/32"	5/8"	.043	100
13396	5/16"	11/32"	3/4"	.050	100
13397	3/8"	13/32"	7/8"	.060	50
13398	1/2"	33/64"	1-1/4"	.060	50

WE WELCOME INQUIRES

If you have item suggestions please send them to mail@auveco.com

BUMPER BOLTS

Listed According to Size

Round Polished Stainless Steel Capped Heads
Zinc Plated



With Lock Nuts



With Hex Nuts

Sec. 3

Auveco Part No.	Size	Head Style	Head Diameter		Unit Pkg.
5714*	5/16"-18 x 7/8"	Round	11/16"	without Nuts	25
5238	3/8"-16 x 7/8"	Round	27/32"	without Nuts	25
3414	3/8"-16 x 7/8"	Round	27/32"	with Hex Nuts	25
3432	3/8"-16 x 7/8"	Round	27/32"	with Lock Nuts	25
5239	3/8"-16 x 1"	Round	27/32"	without Nuts	25
3415	3/8"-16 x 1"	Round	27/32"	with Hex Nuts	25
3433	3/8"-16 x 1"	Round	27/32"	with Lock Nuts	25
8626	7/16"-14 x 7/8"	Round	31/32"	without Nuts	25
8627	7/16"-14 x 7/8"	Round	31/32"	with Hex Nuts	25
8552	7/16"-14 x 1"	Round	31/32"	without Nuts	25
8557	7/16"-14 x 1"	Round	31/32"	with Hex Nuts	25
8562	7/16"-14 x 1"	Round	31/32"	with Lock Nuts	25
5242	7/16"-14 x 1-1/4"	Round	31/32"	without Nuts	25
3099	7/16"-14 x 1-1/4"	Round	31/32"	with Hex Nuts	10
3434	7/16"-14 x 1-1/4"	Round	31/32"	with Lock Nuts	25
5243	7/16"-14 x 1-1/2"	Round	31/32"	without Nuts	25
3100	7/16"-14 x 1-1/2"	Round	31/32"	with Hex Nuts	10
3435	7/16"-14 x 1-1/2"	Round	31/32"	with Lock Nuts	25
5246	1/2"-13 x 1-1/2"	Round	1-3/32"	without Nuts	25
3102	1/2"-13 x 1-1/2"	Round	1-3/32"	with Hex Nuts	10
3438	1/2"-13 x 1-1/2"	Round	1-3/32"	with Lock Nuts	25

* Not Stainless Steel Cap - Chrome Plated

BUMPER BOLTS



15545
Zinc

1/4"-20 x 3/4"
Stainless Steel Cap without Nuts
Head Diameter: 5/8"
Shoulder Length: 9/64"

UNIT PACKAGE: 25



16985
Zinc

5/16"-18 x 1"
Stainless Steel Cap without Nuts
Head Diameter: 3/4"
Shoulder Length: 3/16"

UNIT PACKAGE: 25



9853
(376337-S100)
Zinc

5/16"-18 x 3/4"
Stainless Steel Cap without Nuts
Head Diameter: 3/4"
Shoulder Length: 3/16"
Ford

UNIT PACKAGE: 25



11614
(9433489)
Zinc

3/8"-16 x 1"
Stainless Steel Capped Pan Head w/o Nuts
Head Diameter: 7/8"
Shoulder Length: 3/32"
GM

UNIT PACKAGE: 25

9854
Same as 9853 except
with Hex Nuts
UNIT PACKAGE: 25

9855
Same as 9853 except
with Lock Nuts
UNIT PACKAGE: 25

11615
Same as 11614 except with Hex Nuts
UNIT PACKAGE: 25



10655

(6026723)
Zinc

3/8"-16 x 1"

Stainless Steel Capped Pan Head without Nuts
Head Diameter: 7/8"
Shoulder Length: 3/32"
Chrysler

UNIT PACKAGE: 25

10656

Same as 10655 except
with Hex Nuts
UNIT PACKAGE: 25

10657

Same as 10655 except
with Lock Nuts
UNIT PACKAGE: 25



8623

Zinc

7/16"-14 x 1"

Stainless Steel Capped
Pan Head without Nuts
Head Diameter: 29/32"
Shoulder Length: 5/32"
GM

UNIT PACKAGE: 25

8624

Same as 8623 except
with Hex Nuts
UNIT PACKAGE: 25

8625

Same as 8623 except
with Lock Nuts
UNIT PACKAGE: 25



9354

(9786454)
Zinc

7/16"-14 x 1-3/8"

Stainless Steel Capped
Pan Head without Nuts
Head Diameter: 29/32"
Shoulder Length: 5/32"
GM

UNIT PACKAGE: 25

9355

Same as 9354 except
with Hex Nuts
UNIT PACKAGE: 25

9356

Same as 9354 except
with Lock Nuts
UNIT PACKAGE: 25



10068

(9795883)
Zinc

7/16"-14 x 1-1/4"

Uncapped Round Head without Nuts
Head Diameter: 15/16"
Shoulder Length: 7/32"
GM

UNIT PACKAGE: 25



11770

(490067)
Zinc

7/16"-14 x 1-1/2"

Uncapped Round Head without Nuts
Head Diameter: 15/16"
Shoulder Length: 3/16"
GM

UNIT PACKAGE: 25

11771

Same as 11770 except with Hex Nuts

UNIT PACKAGE: 25



16986

(14003784)
Zinc

M8-1.25 x 25mm

Stainless Steel Capped Pan Head without Nuts
Head Diameter: 19mm
Shoulder Length: 3mm
GM

UNIT PACKAGE: 25

"428" DISPLAY BOARDS

428 of the most popular body hardware and fastener items are shrink-wrapped onto seven different boards. Each board contains product groups, body shops are familiar with and use often.

The back of each board contains each part number, unit package quantity, OEM number and size specification. The backs are protected by a clear plastic liner.

Learn more about the display boards at the front of the catalog, online at www.auveco.com or contact customer service at 1-800-354-9816 or mail@auveco.com



Specification Chart



Auveco Part No.	Size	Length	Hex Size	Washer Head O.D.	Type	Point Type	Finish	Unit Pkg.	Page No.
2209	#8-32	5/16"		11/32"	Phillips Truss Head	C	Chrome	100	89
2753	1/4"-20	5/8"	3/8"	5/8"	Hex Washer Head Spin Lock	C	Blk Phos	100	77
10823	1/4"-20	7/8"	7/16"	3/4"	Hex Head Sems®	Dog Pt	Blk Phos	50	89
13231	1/4"-20	7/8"	3/8"	5/8"	Hex Washer Head with Sems Nylon Washer	CA	Phosphate Organic	25	89
13232	1/4"-20	7/8"	3/8"	5/8"	Hex Washer Head with Sems Nylon Washer & Jack Nut®	CA	Phosphate Organic	25 Sets	89
17034	1/4"-20	7/8"	7/16"	3/4"	Hex Head Sems	Dog Point	Zinc & Yellow Dichromate	50	89
9757	1/4"-20	1"	3/8"	1"	Hex Head Sems	C	Phosphate	100	89
9480	1/4"-20	1"	7/16"	5/8"	Hex Head Sems	Dog Pt	Phosphate	50	89
14976	1/4"-20	1-1/4"	3/8"	5/8"	Hex Washer Head with Nylon Washer	CA	Stainless Steel Bright Plated	25	89
14977	1/4"-20	1-1/4"	3/8"	5/8"	Hex Washer Head with Nylon Washer & Jack Nut	CA	Stainless Steel Bright Plated	10 Sets	89
2688	5/16"-24	1"	1/2"	13/16"	Hex Washer Head Spin Lock	Dog Pt	Black Phos.	50	77
10084	5/16"-18	3/4"	1/2"	21/32"	Hex Washer Head	CA	Blk Phos	100	89
3615	5/16"-18	3/4"	1/2"	13/16"	Hex Washer Head Spin Lock	Dog Pt	Blk Phos	100	77
10362	5/16"-18	13/16"	1/2"	41/64"	Hex Washer Head	CA	Blk Phos	50	89
15792	5/16"-18	7/8"	1/2"	3/4"	Hex Head Sems	CA	Phos. Organic	50	90
15783	5/16"-18	7/8"	1/2"	3/4"	Hex Head Sems	CA	Phosphate	50	90
5711	5/16"-18	1"	1/2"	13/16"	Hex Washer Head Spin Lock	Dog Pt.	Blk Phos	50	77
9756	5/16"-18	1"	1/2"	7/8"	Hex Head Sems	C	Phosphate	100	90
11320	5/16"-18	1"	1/2"	7/8"	Hex Head Sems	CA	Phosphate	25	90
17035	5/16"-18	1-1/16"	1/2"	7/8"	Hex Head Sems	Dog Pt	Zinc & Yellow Dichromate	25	90
5713	5/16"-18	1-1/4"	1/2"	13/16"	Hex Washer Head Spin Lock	Dog Pt	Blk Phos	50	77
8847	5/16"-18	1-1/4"	1/2"	7/8"	Hex Head Sems	Dog Pt	Blk Phos	50	90
11061	5/16"-18	1-1/4"	1/2"	21/32"	Hex Washer Head	Pinch	Plain	50	90
12009	5/16"-18	1-1/2"	1/2"	21/32"	Hex Washer Head	CA	Phos & Oil	50	90
11109	3/8"-16	1"	9/16"	1"	Hex Head Sems	CA	Phosphate	25	90
11110	3/8"-16	1-3/8"	9/16"	1-1/8"	Hex Head Sems	CA	Phosphate	25	90

METRIC BODY BOLT CHART APPEARS ON PAGES 121-122



2209

Chrome

#8-32 x 5/16"
Phillips Truss Head

UNIT PACKAGE: 100



10823

Black
Phosphate

1/4"-20 x 7/8"
Hex Head Sems® with Dog Point
Washer O.D.: 3/4"
Hex: 7/16"

UNIT PACKAGE: 50



17034

(57030-S36)

Zinc & Yellow Dichromate

1/4"-20 x 7/8"
Hex Head Sems® with Dog Point
Washer O.D.: 3/4"
Hex: 7/16"
Ford

UNIT PACKAGE: 50



13231

(14007510)

Phos. Organic

1/4"-20 x 7/8"
Hex Washer Head with Sems® Nylon Washer
Washer O.D.: 5/8"
Hex: 3/8"

Truck Mirror Mounting Screw
GM

UNIT PACKAGE: 25



13232

(14007510, 367292)

Phosphate Organic Screw
Zinc with Sealer Jack Nut

1/4"-20 x 7/8"
Hex Washer Head with Sems® Nylon Washer
Washer O.D.: 5/8"
Hex: 3/8"

Truck Mirror Mounting Screw & Jack Nut
GM, Chrysler

UNIT PACKAGE: 25 Sets

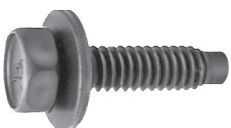

9480

(6025329)
Phosphate

1/4"-20 x 1"
Hex Head Sems® with Dog Point
Washer O.D.: 5/8"
Hex: 7/16"
Chrysler

UNIT PACKAGE: 50



9757

Phosphate

1/4"-20 x 1"
Hex Head Sems®
Washer O.D.: 1"
Hex: 3/8"
GM, Ford

UNIT PACKAGE: 100



14976

(367291, 474821, 14007511)
400 Series Stainless Steel
Bright Plated

1/4"-20 x 1-1/4"
Hex Washer Head with Nylon Washer
Washer O.D.: 5/8"
Hex: 3/8"
Truck Mirror Mounting Screw
GM, Chrysler

UNIT PACKAGE: 25



14977

(367291, 367292,
474821, 14007511)
400 Series Stainless

Steel - Bright Plated Zinc with Sealer Jack Nut

1/4"-20 x 1-1/4"
Hex Washer Head with Nylon Washer
Washer O.D.: 5/8"
Hex: 3/8"
Truck Mirror Mounting Screw & Jack Nut
GM, Chrysler

UNIT PACKAGE: 10 Sets



10084

Black Phosphate

5/16"-18 x 3/4"
Hex Washer Head
Washer Head O.D.: 21/32"
Hex: 1/2"
GM

UNIT PACKAGE: 100



10362

Black Phosphate

5/16"-18 x 13/16"
Hex Washer Head
Washer Head O.D.: 41/64"
Hex: 1/2"
GM

UNIT PACKAGE: 50



15792
(1598757, 15686047)
Phosphate Organic

5/16"-18 x 7/8"
Indented Hex Head Sems®
Washer O.D.: 3/4"
Hex: 1/2"
GM

UNIT PACKAGE: 50

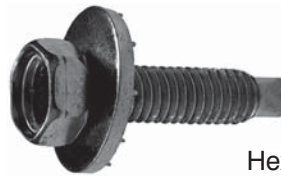

8847
(380575-S2)
Black Phosphate

5/16"-18 x 1-1/4"
Hex Head Sems® with Dog Point
Washer O.D.: 7/8"
Hex: 1/2"
Ford

UNIT PACKAGE: 50



15783
(3846202)
Phosphate

5/16"-18 x 7/8"
Indented Hex Head Sems®
Washer O.D.: 3/4"
Hex: 1/2"
GM

UNIT PACKAGE: 50



11061
Plain

5/16"-18 x 1-1/4"
Hex Washer Head
with Pinch Point
Washer Head O.D.: 21/32"
Hex: 1/2"
Grade 5

UNIT PACKAGE: 50

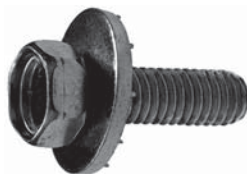

9756
Phosphate

5/16"-18 x 1"
Hex Head Sems®
Washer O.D.: 7/8"
Hex: 1/2"
GM, Ford

UNIT PACKAGE: 100



12009
Phosphate & Oil

5/16"-18 x 1-1/2"
Hex Washer Head
Washer Head O.D.: 21/32"
Hex: 1/2"
GM

UNIT PACKAGE: 50



11320
Phosphate

5/16"-18 x 1"
Hex Head Sems®
Washer O.D.: 7/8"
Hex: 1/2"
GM, Ford

UNIT PACKAGE: 25



11109
(3986997, 14011722)
Phosphate

3/8"-16 x 1"
Hex Head Sems®
Washer O.D.: 1"
Hex: 9/16"
GM

UNIT PACKAGE: 25

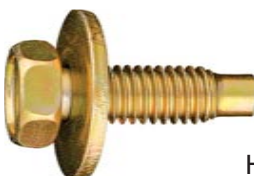

17035
(384931-S36)
Zinc & Yellow Dichromate

5/16"-18 x 1-1/16"
Hex Head Sems® with Dog Point
Washer O.D.: 7/8"
Hex: 1/2"
Ford

UNIT PACKAGE: 25



11110
(407217, 1564180)
Phosphate

3/8"-16 x 1-3/8"
Hex Head Sems®
Washer O.D.: 1-1/8"
Hex: 9/16"
Hood Hinge to Sheet Metal Bolt
GM

UNIT PACKAGE: 25

Sec. 4

Special Tapping Screw Specification Chart



Auveco Part No.	Size	Length	Hex Size	Washer/ Head O.D.	Type	Point Type	Finish	Unit Pkg.	Page No.
9877	#4-24	3/8"		7/32"	Phillips Flat Head	AB	Zinc	100	94
10642	#8	3/8"		3/8"	Phillips Oval Washer Head	AB	Zinc	100	94
16997	#8	3/8"		3/8"	Phillips Oval Washer Head	AB	Black E-Coat	100	94
9863	#8	3/8"		9/32"	Phillips Round Washer Head	AB	Zinc	100	94
13707	#8	3/8"		13/32"	Phillips Flat Top Washer Head	AB	Zinc	100	94
8944	#8	3/8"		7/16"	Phillips Washer Head	AB	Chrome	100	94
12062	M4.2 (#8)	10mm (13/32")		11mm (7/16")	Phillips Washer Head, Pozi-Drive	AB	Black Oxide	100	95
2805	#8	7/16"		3/8"	Phillips Washer Head	AB	Zinc	100	95
15037	#8	7/16"		5/16"	Phillips Washer Head	AB	Chrome	100	95
9229	#8	7/16"		9/32"	Phillips Washer Head, Pozi-Drive	AB	Zinc	100	95
1826	#8	7/16"		13/32"	Phillips Truss Head	AB	Chrome	100	95
15941	M4.2 (#8)	12mm (15/32")		9.5mm (3/8")	Phillips Truss Head	AB	Black Oxide	10	95
16596	M4.2 (#8)	12mm (15/32")		9.5mm (3/8")	Phillips Truss Head	AB	Black Oxide	100	95
12739	M4.2 (#8)	12mm (15/32")		10mm (25/64")	Phillips Washer Head, Pozi-Drive	AB	Chrome	100	95
13708	#8	1/2"		13/32"	Phillips Flat Top Washer Head	AB	Zinc	100	95
12213	#8	1/2"		13/32"	Phillips Flat Top Washer Head	AB	Black E-Coat	100	95
13025	#8	1/2"		31/64"	Phillips Washer Head	AB	Phosphate	100	95
20375	#8	1/2"		1/2"	Phillips Round Washer Head	AB	Black Phos.	100	95
15172	#8	1/2"		13/32"	Phillips Washer Head	Teks®	Zinc	100	95
15171	#8	1/2"		23/64"	Phillips Low Profile Round Wash Head	Teks	Zinc	100	96
12095	#8	1/2"		7/16"	Phillips Washer Head	Teks	Zinc	50	96
15774	#8	1/2"		7/16"	Phillips Washer Head	Teks	Black Phos.	50	96
16478	#8	1/2"		13/32"	Phillips Flat Top Round Washer Head	Teks	Black Zinc	100	96
12059	M4.2 (#8)	13mm (33/64")		11mm (7/16")	Phillips Washer Head	AB	Zinc	100	96
12061	M4.2 (#8)	13mm (33/64")		8.5mm (11/32")	Phillips Round Washer Head, Pozi-Drive	AB	Black Oxide	100	96
13712	M4.2 (#8)	13mm (33/64")		11mm (7/16")	Phillips Washer Head	AB	Black Zinc	50	96
12740	M4.2 (#8)	13mm (33/64")	7mm	12mm (15/32")	Hex Head Sems®	AB	Phosphate	100	96
15721	M4.2 (#8)	13mm (33/64")	7mm	16mm (5/8")	Hex Head Sems	AB	Phosphate	50	96
18781	M4.2 (#8)	14mm (9/16")	7mm	8mm (5/16")	Hex Head Sems	AB	Phosphate	50	96
21122	M4.2 (#8)	14mm (9/16")		11mm (7/16")	Phillips Washer Head, Pozi-Drive	Teks	Chrome	50	96
2806	#8	5/8"		13/32"	Phillips Round Washer Head	AB	Chrome	100	96
13711	#8	5/8"		31/64"	Phillips Washer Head	AB	Phosphate	100	97
18817	M4.2 (#8)	16mm (5/8")		11mm (7/16")	Phillips Round Washer Head, Pozi-Drive	Teks	Black Zinc	100	97
16720	M4.2 (#8)	16mm (5/8")		9.5mm (3/8")	Phillips Truss Head	AB	Black Oxide	100	97
12741	M4.2 (#8)	16mm (5/8")	7mm	12mm (15/32")	Hex Head Sems	AB	Phosphate	100	97
18261	M4.2 (#8)	16mm (5/8")	7mm	12mm (15/32")	Hex Washer Head Sems	Teks	Phosphate	50	97
13687	#8	3/4"		9/32"	Phillips Washer Head	AB	Zinc	100	97

(Continued on next page)

Special Tapping Screw Specification Chart

Sec. 4



Auveco Part No.	Size	Length	Hex Size	Washer/ Head O.D.	Type	Point Type	Finish	Unit Pkg.	Page No.
13026	#8	3/4"		31/64"	Phillips Washer Head	AB	Phosphate	100	97
17460	#8	3/4"		7/16"	Phillips Round Washer Head	Teks®	Zinc	50	97
17650	#8	3/4"		7/16"	Phillips Round Washer Head	Teks	Phosphate	50	97
16534	#8	3/4"		5/16"	Phillips Pan Head, with Sealer	Teks	Black Zinc	50	97
12060	M4.2 (#8)	20mm (25/32")		11mm (7/16")	Phillips Washer Head	AB	Black Oxide	100	97
12097	M4.2 (#8)	20mm (25/32")		12mm (15/32")	Phillips Pan Head Sems®	AB	Chrome	50	98
12738	M4.2 (#8)	20mm (25/32")	7mm	12mm (15/32")	Hex Washer Head Sems	AB	Phosphate	50	98
12742	M4.2 (#8)	20mm (25/32")	7mm	12mm (15/32")	Hex Head Sems	AB	Phosphate	100	98
15373	M4.2 (#8)	20mm (25/32")	7mm	16mm (5/8")	Hex Head Sems	AB	Phosphate	50	98
20271	M4.2 (#8)	20mm (25/32")		16mm (5/8")	Phillips Pan Head Sems	AB	Phosphate	50	98
20476	M4.2 (#8)	20mm (25/32")	7mm	17mm (11/16")	Hex Washer Head Sems	Teks	Phosphate	50	98
19278	M4.2 (#8)	20mm (25/32")	7mm	20mm (25/32")	Hex Head Sems	AB	Black Phos.	50	98
15775	M4.2 (#8)	20mm (25/32")	7mm	12mm (15/32")	Hex Head Sems	Teks	Phosphate	50	98
22070	M4.2 (#8)	20mm (25/32")		17mm (11/16")	Torx® Pan Head Sems	Dog Pnt	Black Zinc	50	98
22104	M4.2	22mm	5.5mm	16mm	Hex Head Sems	AB	Black Zinc	50	98
18296	#8	1"		7/16"	Phillips Round Washer Head	Teks	Zinc	50	98
19006	M4.2 (#8)	25mm (1")		11mm (7/16")	Pozi-Drive Round Washer Head	Teks	Phosphate	100	99
20382	M4.2 (#8)	25mm (1")	T-15 Drive	12mm (15/32")	Torx® Pan Head Sems	AB	Black Zinc	50	99
22081	M4.2	25mm		17mm	Pozi-Drive Round Washer Head Sems	AB	Black Zinc	50	99
20376	#8	1"		1/2"	Phillips Round Washer Head	AB	Black Phos.	100	99
18336	M4.2 (#8)	25mm (1")	7mm	12mm (15/32")	Hex Head Sems	AB	Black Phos.	100	99
19653	M4.2 (#8)	30mm (1-3/16")	7mm	17mm (11/16")	Hex Head Sems	AB	Black Phos.	15	99
18460	#8	1-1/4"		3/8"	Phillips Oval Head Sems Flush Washer	Teks	Phosphate	50	99
19778	#8	1-1/4"		7/16"	Phillips Round Washer Head	Teks	Zinc	50	99
2178	#10	3/8"		31/64"	Phillips Round Washer Head	AB	Zinc	100	99
2028	#10	1/2"		11/32"	Phillips Round Head	AB	Zinc	100	99
13027	#10	1/2"		15/32"	Phillips Flat Washer Head	AB	Zinc	100	99
15827	#10	1/2"		15/32"	Phillips Flat Washer Head	AB	Phosphate	100	99
18340	M4.8 (#10)	15mm (19/32")		14mm (9/16")	Phillips Truss Head	AB	Black Phos.	50	99
20364	#10	5/8"		7/16"	Phillips Washer Head	Teks	Zinc	100	100
17459	M4.8 (#10)	16mm (5/8")		11mm (7/16")	Phillips Truss Head	AB	Black Oxide	100	100
22030	M4.8 (#10)	16mm (5/8")	8mm	18mm	Hex Head Sems	AB	Black Zinc	50	100
22110	M4.8	18mm	T-25 Drive	15mm	Torx Truss Head	AB	Black Zinc	25	100

(Continued on next page)

Sec. 4

Special Tapping Screw Specification Chart



Auveco Part No.	Size	Length	Hex Size	Washer/ Head O.D.	Type	Point Type	Finish	Unit Pkg.	Page No.
20259	M4.8 (#10)	19mm (3/4")		16mm (5/8")	Phillips Truss Head Sems®	AB	Black E Coat	25	100
13709	#10	3/4"		15/32"	Phillips Flat Top Washer Head	AB	Zinc	50	100
19240	#10	3/4"		1/2"	Phillips Flat Top Round Washer Head	AB	Black E-Coat	100	100
16589	M4.8 (#10)	19mm (3/4")	8mm	15mm (19/32")	Hex Head Sems	AB	Zinc & Yellow Dichromate	50	100
21774	M4.8 (#10)	20mm (25/32")	8mm	26mm	Hex Head Sems	AB	Black E-Coat	25	100
21865	M4.8 (#10)	32mm (1-1/4")	8mm	19mm (3/4")	Hex Head Sems	AB	Phosphate	50	100
19237	#10	1-1/32"		9/16"	Nylon Phillips Pan Head	AB	Black Nylon	50	100
21746	M5	11mm		11mm	Phillips Truss Head	AB	Black Oxide	50	101
21747	M5	11mm		12mm	Phillips Round Washer Head	AB	Black Oxide	50	101
22294	M5-1.81	16mm	8mm	16mm	Phillips Hex Head Sems		Black Phos.	25	101
22203	M5-1.81	20mm		13mm	Phillips Flat Head		Black Phos.	100	101
22111	M5-2.12 (#12)	19mm (3/4")	T-25 Drive	14mm (9/16")	Torx® Truss Head	AB	Black Zinc	25	101
20455	M5-2.12 (#12)	20mm (25/32")		14mm (9/16")	Phillips Truss Head	AB	Black Phos.	50	101
21841	M5.2 (#12)	20mm (25/32")	8mm	12mm (1/2")	Phillips Hex Head Sems	AB	Black E-Coat	25	101
21839	M5.2 (#12)	21mm (13/16")	10mm	14mm (9/16")	Phillips Hex Head Sems	AB	Zinc	25	101
21541	M5.5 (#12)	20mm (25/32")	T-20 Drive	15mm (19/32")	Torx Truss Head	AB	Black Zinc	25	101
22292	M5.5-1.81 (#12)	16mm (5/8")		13mm	Phillips Truss Head		Black Phos.	25	101
17461	M5.5-1.81 (#12)	18mm (45/64")	8mm	15mm (19/32")	Hex Head Sems	AB	Zinc & Yellow Dichromate	50	101
21744	M6-1.81	20mm	10mm	13mm	Phillips Hex Head Sems	AB	Black E-Coat	25	102
19170	M6.3 (#14)	16mm (5/8")		15mm (19/32")	Phillips Truss Head	AB	Black Phos.	50	102
15776	M6.3 (#14)	16mm (5/8")	8mm	16mm (5/8")	Hex Head Sems	AB	Phosphate	50	102
12057	M6.3 (#14)	16mm (5/8")	10mm	17mm (11/16")	Hex Head Sems	AB	Phosphate	50	102
22106	M6.3	18mm	10mm	14mm	Phillips Hex Head Sems	AB	Zinc	25	102
15962	M6.3 (#14)	18mm (23/32")	10mm	22mm (7/8")	Hex Head Sems	AB	Zinc & Yellow Dichromate	25	102
13021	#14	3/4"	3/8"	1/2"	Hex Washer Head	AB	Phosphate	50	102
13019	M6.3 (#14)	19mm (3/4")	8mm	11.5mm (29/64")	Hex Washer Head	AB	Phosphate	50	102
20556	M6.3 (#14)	20mm (25/32")	10mm	16mm (5/8")	Phillips Hex Head Sems	AB	Black Zinc	50	102
12351	M6.3 (#14)	20mm (25/32")	10mm	17mm (11/16")	Hex Washer Head Sems	AB	Black Phosphate	50	102
16828	M6.3 (#14)	20mm (25/32")	10mm	18mm (45/64")	Hex Head Sems	AB	Zinc & Yellow Dichromate	25	103
20557	M6.3 (#14)	20mm (25/32")	10mm	20mm (25/32")	Phillips Hex Head Sems	AB	Black Zinc	50	103

(Continued on next page)

Special Tapping Screw Specification Chart

Sec. 4



Auveco Part No.	Size	Length	Hex Size	Washer/ Head O.D.	Type	Point Type	Finish	Unit Pkg.	Page No.
18934	#14	7/8"	3/8"	13/16"	Hex Washer Head	AB	Zinc Organic	25	103
21838	M6.3 (#14)	24mm (15/16")	10mm	16mm (5/8")	Phillips Hex Head Sems®	AB	Zinc	25	103
12339	M6.3 (#14)	25mm (1")	10mm	17mm (11/16")	Hex Head Sems	AB	Phosphate	50	103
12354	M6.3 (#14)	30mm (1-3/16")	10mm	17mm (11/16")	Hex Head Sems	AB	Phosphate	50	103
12068	M6.3 (#14)	30mm (1-3/16")	10mm	24mm (15/16")	Hex Head Sems	AB	Phosphate	50	103
22295	M6.5-1.81	18mm		16mm	Phillips Truss Head		Black Phos.	25	103
22296	M6.5-1.81	25mm		16mm	Phillips Truss Head		Black Phos.	25	103
21837	M6.5	19mm	10mm	20mm	Phillips Hex Head Sems	AB	Black E-Coat	25	104
19417	M7.5	35mm (1-3/8")	#3 Sq. Drive	22mm (7/8")	Nylon Square Drive Truss Head	AB	Black Nylon	15	104
12350	M8 (5/16"-12)	20mm (25/32")	13mm	16mm (5/8")	Hex Washer Head	AB	Phosphate	25	104
10364	5/16"-12	7/8"	1/2"	21/32"	Hex Washer Head	AB	Black Oxide	100	104
10714	5/16"-12	1"	1/2"	21/32"	Hex Washer Head	AB	Phosphate	50	104
21517	M9.5	46mm (1-13/16")	#3 Sq. Drive	22mm (7/8")	Nylon Square Drive Truss Head	AB	Black Nylon	25	104
20970	M14 (1-11/32")	34mm Drive	#3 Sq. Drive (7/8")	22mm	Nylon Square Drive Truss Head	AB	Black Nylon	25	104

SPECIAL TAPPING SCREWS



9877

Zinc

#4-24 x 3/8"

Special Phillips Flat Head
Head Diameter: 7/32"

Use to replace Welded Studs for Moulding Clips

UNIT PACKAGE: 100



9863

Zinc

#8-18 x 3/8"

Phillips Round Washer Head
Head Diameter: 9/32"
Chrysler

UNIT PACKAGE: 100



10642

(381671-S)

Zinc

#8 x 3/8"

Phillips Oval Washer Head
Washer Head Outer Diameter: 3/8"
Wheel Opening Mouldings
Ford

UNIT PACKAGE: 100



13707

(9422246)

Zinc

#8 x 3/8"

Phillips Flat Top Washer Head
Washer Head Outer Diameter: 13/32"
Chrysler

UNIT PACKAGE: 100



16997

Same as 10642 with Black E-Coat
(168 Hours Salt Spray)

#8 x 3/8"

Phillips Oval Washer Head
Washer Head Outer Diameter: 3/8"
Wheel Opening Mouldings

UNIT PACKAGE: 100



8944

Chrome

#8-18 x 3/8"

Phillips Washer Head
Washer Head Outer Diameter: 7/16"
For attaching Chrome Floor Strips
Ford

UNIT PACKAGE: 100



12062
(11501903)
Black Oxide

M4.2-1.41 x 10mm (#8 x 13/32")
Phillips Washer Head Pozi-Drive
Washer Head Outer Diameter: 11mm (7/16")
GM

UNIT PACKAGE: 100



2805
Zinc

#8 x 7/16"
Phillips Washer Head
Washer Head Outer Diameter: 3/8"

UNIT PACKAGE: 100



15037
(588546)
Chrome

#8 x 7/16"
Phillips Washer Head
410 Stainless Steel
Washer Head Outer Diameter: 5/16"
Wheel Mouldings
GM

UNIT PACKAGE: 100



9229
(4879431)
Zinc

#8-18 x 7/16"
Phillips Washer Head Pozi-Drive
Washer Head Outer Diameter: 9/32"
Wheel Mouldings
GM

UNIT PACKAGE: 100



1826
Chrome

#8 x 7/16"
Phillips Truss Head
Head Diameter: 13/32"

UNIT PACKAGE: 100



15941
Black Oxide

M4.2-1.41 x 12mm (#8 x 15/32")
Phillips Truss Head
Head Diameter: 9.5mm (3/8")
Japanese Imports

UNIT PACKAGE: 10

16596

Same as 15491 except for unit package quantity

UNIT PACKAGE: 100



12739
(11501794)
Chrome

M4.2-1.41 x 12mm (#8 x 15/32")
Phillips Washer Head Pozi-Drive
Washer Head Outer Diameter: 10mm (25/64")
GM

UNIT PACKAGE: 100



13708
(9422202)
Zinc

#8 x 1/2"
Phillips Flat Top Washer Head
Washer Head Outer Diameter: 13/32"
Chrysler

UNIT PACKAGE: 100



12213
(11503421, 11503636)
Black E-Coat

#8-18 x 1/2"
Phillips Flat Washer Head
Washer Head Outer Diameter: 13/32"
GM

UNIT PACKAGE: 100



13025
(56910-S2)
Phosphate

#8 x 1/2"
Phillips Washer Head
Washer Head Outer Diameter: 31/64"
Ford

UNIT PACKAGE: 100



20375
Black Phosphate

#8 x 1/2"
Phillips Round Washer Head
Head Diameter: 1/2"

UNIT PACKAGE: 100



15172
Zinc

#8 x 1/2"
Phillips Washer Head with #2 Teks® Point
Washer Head Outer Diameter: 13/32"

UNIT PACKAGE: 100



15171

Zinc

#8 x 1/2"

Phillips Low Profile
Round Washer Head with #2 Teks® Point
Washer Head Outer Diameter: 23/64"

UNIT PACKAGE: 100



13712

(11505104)
Black Zinc

M4.2-1.41 x 13mm (#8 x 33/64")
Phillips Washer Head
Washer Head Outer Diameter: 11mm (7/16")
GM

UNIT PACKAGE: 50



12095

(1689827)
Zinc

#8 x 1/2"

Phillips Washer Head with Teks® Point
Washer Head Outer Diameter: 7/16"
Reveal Moulding to Panel
GM

UNIT PACKAGE: 50



12740

(11503394)
Phosphate

M4.2-1.41 x 13mm (#8 x 33/64")
Hex Head Sems®
Washer Outer Diameter: 12mm (15/32")
Hex: 7mm
GM

UNIT PACKAGE: 100



15774

(GM: 20423550)
(Ford: 381801-S2, 390017-S2)
Black Phosphate

#8 x 1/2"

Phillips Washer Head with Teks® Point
Washer Head Outer Diameter: 7/16"
GM & Ford

UNIT PACKAGE: 50



15721

(11504010)
Phosphate

M4.2-1.41 x 13mm (#8 x 19/32")
Indented Hex Head Sems®
Washer Outer Diameter: 16mm (5/8")
Hex: 7mm
GM

UNIT PACKAGE: 50



16478

(153297)
Black Zinc

#8-18 x 1/2"

Phillips Flat Top Round Washer Head Teks®
Washer Head Outer Diameter: 13/32"
Chrysler

UNIT PACKAGE: 100



18781

(11515566)
Phosphate

M4.2-1.41 x 14mm (#8 x 9/16")
Hex Head Sems®
Washer Outer Diameter: 8mm (5/16")
Hex: 7mm
GM

UNIT PACKAGE: 50



12059

(11501883)
Zinc

M4.2-1.41 x 13mm (#8 x 33/64")
Phillips Washer Head Pozi-Drive
Washer Head Outer Diameter: 11mm (7/16")
GM

UNIT PACKAGE: 100



21122

Chrome

M4.2-1.41 x 14mm (#8 x 9/16")
Phillips Pozi-Drive Washer Head Teks®
Washer Head Outer Diameter: 11mm (7/16")

UNIT PACKAGE: 50



12061

(11501896)
Black Oxide

M4.2-1.41 x 13mm (#8 x 33/64")
Phillips Round Washer Head Pozi-Drive
Washer Head Outer Diameter: 8.5mm (11/32")
GM

UNIT PACKAGE: 100



2806

Chrome

#8 x 5/8"
Phillips Round Washer Head
Washer Head Outer Diameter: 13/32"

UNIT PACKAGE: 100



13711
 (56911-S2, 56929-S2)
 Phosphate
 #8 x 5/8"
 Phillips Washer Head
 Washer Head Outer Diameter: 31/64"
 Ford

UNIT PACKAGE: 100



13026
 (56912-S2)
 Phosphate
 #8 x 3/4"
 Phillips Washer Head
 Washer Head Outer Diameter: 31/64"
 Ford

UNIT PACKAGE: 100



18817
 (1746408)
 Black Zinc
 M4.2-1.41 x 16mm (#8 x 41/64")
 Phillips Round Washer Head
 with Serrations under the Head
 Pozi-Drive with Teks® Point
 Washer Head Outer Diameter: 11mm (7/16")
 Moulding, Trim & General Purpose
 GM

UNIT PACKAGE: 100



17460
 (382413-S9)
 Zinc
 #8 x 3/4"
 Phillips Round Washer Head
 with Teks® Point
 Washer Head Outer Diameter: 7/16"
 Door Scuff Plate
 Ford

UNIT PACKAGE: 50



16720
 Black Oxide
 M4.2-1.41 x 16mm (#8 x 5/8")
 Phillips Truss Head
 Head Outer Diameter: 9.5mm (3/8")
 Honda

UNIT PACKAGE: 100



17650
 Phosphate
 #8 x 3/4"
 Phillips Round Washer Head
 with Teks® Point
 Washer Head Outer Diameter: 7/16"

UNIT PACKAGE: 50



12741
 (11503395)
 Phosphate
 M4.2-1.41 x 16mm (#8 x 5/8")
 Hex Head Sems®
 Washer Outer Diameter: 12mm (15/32")
 Hex: 7mm
 GM

UNIT PACKAGE: 100



16534
 (154534)
 Black Zinc
 #8-18 x 3/4"
 Phillips Pan Head
 with Teks® Point & Sealer
 Head Diameter: 5/16"
 Cargo Door Scuff Plate
 Chrysler Full Size Van

UNIT PACKAGE: 50



18261
 (11503578, 11503785)
 Phosphate
 M4.2-1.41 x 16mm (#8 x 5/8")
 Hex Washer Head Sems® with Teks® Point
 Washer Outer Diameter: 12mm (1/2")
 Hex: 7mm
 GM

UNIT PACKAGE: 50



12060
 (11501884)
 Black Oxide
 M4.2-1.41 x 20mm (#8 x 25/32")
 Phillips Washer Head
 Washer Outer Diameter: 11mm (7/16")
 GM

UNIT PACKAGE: 100



13687
 Zinc
 #8 x 3/4"
 Phillips Washer Head
 Washer Head Outer Diameter: 9/32"

UNIT PACKAGE: 100



12097

(9420052, 11502483)
Chrome

M4.2-1.41 x 20mm (#8 x 25/32")
Phillips Pan Head Sems® Pozi-Drive
Washer Outer Diameter: 12mm (1/2")
GM

UNIT PACKAGE: 50



12738

(11504056, 11513801)
Phosphate

M4.2-1.41 x 20mm (#8 x 25/32")
Hex Washer Head Sems®
Washer Outer Diameter: 12mm (1/2")
Hex: 7mm
Radiator & Grille
GM

UNIT PACKAGE: 50



12742

(11503396, 11503483)
Phosphate

M4.2-1.41 x 20mm (#8 x 25/32")
Hex Head Sems®
Washer Outer Diameter: 12mm (1/2")
Hex: 7mm
Front End & Air Conditioner
GM

UNIT PACKAGE: 100



15373

(11503892, 11500434)
Phosphate

M4.2-1.41 x 20mm (#8 x 25/32")
Hex Head Sems®
Washer Outer Diameter: 16mm (5/8")
Hex: 7mm
GM

UNIT PACKAGE: 50



20271

Phosphate

M4.2-1.41 x 20mm (#8 x 25/32")
Phillips Pan Head Sems®
Washer Outer Diameter: 16mm (5/8")
Ford

UNIT PACKAGE: 50



20476

Phosphate

M4.2-1.41 x 20mm (#8 x 25/32")
Hex Washer Head Sems® Teks®
Washer Outer Diameter: 17mm (11/16")
Hex: 7mm
General Purpose

UNIT PACKAGE: 50



19278

(GM: 14090382;
Chry: 6506161-AA)
Black Phosphate

M4.2-1.41 x 20mm (#8 x 25/32")
Hex Head Sems®
Washer Outer Diameter: 20mm (25/32")
Hex: 7mm
GM

UNIT PACKAGE: 50



15775

Phosphate

M4.2-1.41 x 20mm (#8 x 25/32")
Hex Head Sems® with Teks® point
Washer Outer Diameter: 12mm (1/2")
Hex: 7mm

UNIT PACKAGE: 50



22070

(GM: 11570637)
Black Zinc

M4.2-1.41 x 20mm (#8 x 25/32")
Torx® Pan Head Sems®
Tapping Screw with Dog Point
T15 Drive
Washer Outer Diameter: 17mm (11/16")
GM 2007 - On

UNIT PACKAGE: 50



22104

(Ford: N801169-S900;
W710763-S901)
Black Zinc

M4.2-1.41 x 22mm
Hex Head Sems® Tapping Screw
Washer Diameter: 16mm
Hex Size: 5.5mm
Front Bumper Exterior Trim & Front Fender
Ford Edge & Expedition and Lincoln MKT
& MKX 1997 - On

UNIT PACKAGE: 50



18296

Zinc

#8 x 1"
Phillips Round Washer Head
with Teks® Point
Washer Head Outer Diameter: 7/16"
General Purpose

UNIT PACKAGE: 50



19006
Phosphate

M4.2-1.41 x 25mm (#8 x 1")
Round Washer Head
Pozi-Drive with Tek's® Point
Washer Head Outer Diameter: 11mm (7/16")
General Purpose

UNIT PACKAGE: 100



20382

(Not Available from O.E.M.)
Black Zinc

M4.2-1.41 x 25mm (#8 x 1")
Torx® Pan Head Sems®
T-15 Drive
Washer Outer Diameter: 12mm (1/2")

UNIT PACKAGE: 50



22081

(GM: 11609762)
Black Zinc

M4.2-1.41 x 25mm
Pozi-Drive Round Washer Head Sems®
Tapping Screw
Washer Diameter: 17mm
Chevrolet Equinox, GMC Acadia & Terrain
and Saturn Outlook 2007 - On

UNIT PACKAGE: 50



20376

Black Phosphate

#8 x 1"
Phillips Round Washer Head
Head Diameter: 1/2"

UNIT PACKAGE: 100



18336

Black Phosphate

M4.2-1.41 x 25mm (#8 x 1")
Hex Head Sems®
Washer Outer Diameter: 12mm (1/2")
Hex: 7mm

UNIT PACKAGE: 100



19653

(N811534-S61)
Black Phosphate

M4.2-1.41 x 30mm (#8 x 1-3/16")
Hex Head Sems®
Washer Outer Diameter: 17mm (11/16")
Hex: 7mm
Ford

UNIT PACKAGE: 15



18460

Phosphate

#8 x 1-1/4"
Phillips Oval Head Sems®
Flush Washer with #2 Tek's® Point
Washer Outer Diameter: 3/8"
Interior Trim

UNIT PACKAGE: 50



19778

Zinc

#8 x 1-1/4"
Phillips Round Washer Head with Tek's® Point
Washer Head Outer Diameter: 7/16"
General Purpose

UNIT PACKAGE: 50



2178

Zinc

#10 x 3/8"
Phillips Round Washer Head
Washer Head Outer Diameter: 31/64"

UNIT PACKAGE: 100



2028

Zinc

#10 x 1/2"
Phillips Round Head
Head Diameter: 11/32"

UNIT PACKAGE: 100



13027

(9428273)
Zinc

#10 x 1/2"
Phillips Flat Washer Head
Washer Head Outer Diameter: 15/32"
Chrysler

UNIT PACKAGE: 100



15827

(9423950)
Phosphate

#10 x 1/2"
Phillips Flat Washer Head
Washer Head Outer Diameter: 15/32"
Chrysler

UNIT PACKAGE: 100



18340

Black Phosphate

M4.8-1.6 x 15mm (#10 x 19/32")
Phillips Truss Head
Head Outer Diameter: 14mm (9/16")
Nissan Bumpers

UNIT PACKAGE: 50



20364

Zinc

#10 x 5/8"

Phillips Washer Head with Teks® Point
and serrations under the Washer Head
Washer Head Outer Diameter: 7/16"
GM

UNIT PACKAGE: 100



17459

Black Oxide

M4.8-1.61 x 16mm (#10 x 5/8")

Phillips Truss Head

Head Outer Diameter: 11mm (7/16")

Imports

UNIT PACKAGE: 100



22030

(BMW: 07-14-7-129-160)

Black Zinc

M4.8-1.61 x 16mm (#10 x 5/8")

Hex Head Sems®

Washer Outer Diameter: 18mm

Hex: 8mm

BMW, 2013 - 1999

UNIT PACKAGE: 50



22110

(VW: N90775801, BMW: 07146963883)

Black Zinc

M4.8-1.61 x 18mm

Torx® Truss Head Tapping Screw

T25 Drive

Head Diameter: 15mm

Audi & VW 1998 - On

BMW 5, 6 & 7 Series 2011 - 00

UNIT PACKAGE: 25



20259

(90114-SZ3-000, 90114-SE0-000)

Black E-Coat

M4.8-1.61 x 19mm (#10 x 3/4")

Phillips Truss Head Sems®

Washer Outer Diameter: 16mm (5/8")

Splash Shield & General Purpose

Honda 1986 - On

UNIT PACKAGE: 25



13709

(9427977)

Zinc

#10 x 3/4"

Phillips Flat Top Washer Head

Washer Head Outer Diameter: 15/32"

Chrysler

UNIT PACKAGE: 50



19240

Black E-Coat

#10 x 3/4"

Phillips Flat Top Round Washer Head
Washer Head Outer Diameter: 1/2"
General Purpose

UNIT PACKAGE: 100



16589

Zinc & Yellow Dichromate

#10 x 3/4" (19mm)

Indented Hex Head Sems®

Washer Outer Diameter: 19/32"

Hex: 5/16" (8mm)

Honda, Nissan, Toyota

UNIT PACKAGE: 50



21774

(Mercedes-Benz: 201-990-05-36)

Black E-Coat

M4.8-1.61 x 20mm (#10 x 25/32")

Hex Head Sems®

Washer Outer Diameter: 26mm

Hex: 8mm

Front Bumper & Moulding Strip

Mercedes-Benz 2014 - 1993

UNIT PACKAGE: 25



21865

(Chrysler: 6509539-AA)

Phosphate

M4.8-1.61 x 32mm (#10 x 1-1/4")

Hex Head Sems® Tapping Screw

Washer Outer Diameter: 19mm (3/4")

Hex: 8mm

Chrysler Town & Country and

Dodge Ram 2014 - 09

UNIT PACKAGE: 50



19237

(W701649-S,
W704881-S300)

Black Nylon

#10 x 1-1/32"

Cowl Top Vent Grille Nylon Screw

Head Outer Diameter: 9/16"

Use with Auveco 19238

Ford Taurus & Sable 1996 - On

UNIT PACKAGE: 50



21746
 (Mitsubishi: MF453091)
 Black Oxide
 M5-1.59 x 11mm
 Phillips Truss Head
 Head Outer Diameter: 11mm
 Interior Trim
 Mitsubishi Galant 2008 - 2004
 UNIT PACKAGE: 50



21747
 Black Oxide
 M5 - 1.59 x 11mm
 Phillips Round Washer Head
 Washer Head Outer Diameter: 12mm
 Chrysler & Imports
 UNIT PACKAGE: 50



22294
 (Mazda: 9CF600516B)
 Black Phosphate
 M5-1.81 x 16mm
 Phillips Hex Head Sems®
 Washer Outer Diameter: 16mm
 Hex: 8mm
 Mazda 2, 3, 5, 6, 626, 929, CX-5, CX-7, CX-9, Miata,
 Millenia, MPV, Mx-3, Protégé, RX-7 & RX-8 2014 - 1992
 UNIT PACKAGE: 25



22203
 (Honda: 90103-SDA-A00)
 Black Phosphate
 M5-1.81 x 20mm
 Phillips Flat Head
 Head Diameter: 13mm
 Front & Rear Bumper
 Honda Civic, Pilot & Ridgeline 2006 - On
 UNIT PACKAGE: 100



22111
 (VW: N90892001, N90775001)
 Black Zinc
 M5-2.12 x 19mm
 Torx® Truss Head Tapping Screw
 T25 Drive
 Head Diameter: 14mm
 Audi, Porsche & VW 2014 - 07
 UNIT PACKAGE: 25



20455
 Black Phosphate
 M5-2.12 x 20mm (#12 x 25/32")
 Phillips Truss Head
 Head Outer Diameter: 14mm (9/16")
 Imports
 UNIT PACKAGE: 50



21841
 (Toyota: 75392-42030)
 Black E-Coat
 M5.2-2.0 x 20mm (#12 x 25/32")
 Phillips Hex Head Sems®
 Washer Outer Diameter: 12mm (1/2")
 Hex: 8mm
 Front Bumper Moulding
 Toyota & Lexus 2010 - On
 UNIT PACKAGE: 25



21839
 (Toyota: 90159-A0001;
 90159-50316)
 Zinc
 M5.2-2.0 x 21mm (#12 x 13/16")
 Phillips Hex Head Sems®
 Washer Outer Diameter: 14mm (9/16")
 Hex: 10mm
 Front Bumper, Bumper Stay & Radiator Grille
 Toyota & Lexus 2000 - On
 UNIT PACKAGE: 25



21541
 (13144822)
 Black Zinc
 M5.5 x 20mm (12 x 25/32")
 Torx® Truss Head
 T-20 Drive
 Head Outer Diameter: 15mm (19/32")
Use with Auveco 21539 & 21540
 GM 2011 - On
 Saab 2003 - On
 UNIT PACKAGE: 25



22292
 (Nissan: 01454-N5061)
 Black Phosphate
 M5.5-1.81 x 16mm (#12 x 5/8")
 Phillips Truss Head
 Head Outer Diameter: 13mm
 Fender Liner
 Nissan Cube, Murano, Pathfinder, Quest,
 Rogue, Sentra & Versa 2014 - On
 UNIT PACKAGE: 25



17461
 Zinc & Yellow Dichromate
 M5.5-1.81 x 18mm (#12 x 45/64")
 Hex Head Sems®
 Washer Outer Diameter: 15mm (19/32")
 Hex: 8mm
 Imports
 UNIT PACKAGE: 50



21744

(Mitsubishi: MS452348)
Black E-Coat

M6-1.81 x 20mm
Phillips Hex Head Sems®
Washer Outer Diameter: 13mm (1/2")
Hex: 10mm
Bumper, Exterior Trim,
Fender Shield and Quarter Panel
Mitsubishi Diamante, Eclipse, Galant, Lancer,
Mirage, Montero & 3000GT 2012 - 1991

UNIT PACKAGE: 25



19170

Black Phosphate

M6.3-1.81 x 16mm (#14 x 5/8")
Phillips Truss Head
Head Outer Diameter: 15mm (19/32")
Japanese Imports

UNIT PACKAGE: 50



15776

(N800312-S2)
Phosphate

M6.3-1.81 x 16mm (#14 x 41/64")
Hex Head Sems®
Washer Outer Diameter: 16mm (5/8")
Hex: 8mm
Ford

UNIT PACKAGE: 50



12057

(11500994, 11509371)
Phosphate

M6.3-1.81 x 16mm (#14 x 41/64")
Hex Head Sems®
Washer Outer Diameter: 17mm (11/16")
Hex: 10mm
GM

UNIT PACKAGE: 50



22106

(Toyota: 90159-60303)
Zinc

M6.3-2.5 x 18mm
Phillips Hex Head Sems® Tapping Screw
Washer Outer Diameter: 14mm
Hex: 10mm
Toyota & Scion 1993 - On

UNIT PACKAGE: 25



15962

Zinc & Yellow Dichromate

M6.3-1.81 x 18mm (#14 x 23/32")
Hex Head Sems®
Washer Outer Diameter: 22mm (7/8")
Hex: 10mm
Honda, Nissan, Toyota

UNIT PACKAGE: 25



13021

(55914-S2)
Phosphate

#14 x 3/4"
Hex Washer Head
Washer Head Outer Diameter: 1/2"
Hex: 3/8"
Ford

UNIT PACKAGE: 50



13019

(N610959-S2)
Phosphate

M6.3-1.81 x 19mm (#14 x 3/4")
Hex Washer Head
Washer Head Outer Diameter: 11.5mm (29/64")
Hex: 8mm
Ford

UNIT PACKAGE: 50



20556

Black Zinc

M6.3-1.81 x 20mm (#14 x 25/32")
Phillips Hex Head Sems®
Washer Outer Diameter: 16mm (5/8")
Hex: 10mm
Imports

UNIT PACKAGE: 50

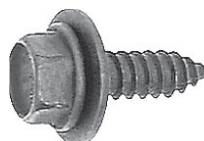

12351

(11505022)
Black Phosphate

M6.3-1.81 x 20mm (#14 x 25/32")
Hex Washer Head Sems®
Washer Outer Diameter: 17mm (11/16")
Hex: 10mm
GM

UNIT PACKAGE: 50



16828
Zinc & Yellow Dichromate
M6.3-1.81 x 20mm (#14 x 25/32")
Hex Head Sems®
Washer Outer Diameter: 18mm (45/64")
Hex: 10mm
Honda, Nissan & Toyota

UNIT PACKAGE: 25



20557
Black Zinc
M6.3-1.81 x 20mm (#14 x 25/32")
Phillips Hex Head Sems®
Washer Outer Diameter: 20mm (25/32")
Hex: 10mm
Imports

UNIT PACKAGE: 50



18934
(6034703, 6035188)
Zinc Organic
#14 x 7/8"
Hex Washer Head
Serrations under the Washer Head
Washer Head Outer Diameter: 13/16"
Hex: 3/8"
Front Fender & Fascia Attachment
Chrysler 1993-On

UNIT PACKAGE: 25



21838
(Toyota: 90159-60488)
Zinc
M6.3-2.5 x 24mm (#14 x 15/16")
Phillips Hex Head Sems®
Washer Outer Diameter: 16mm (5/8")
Hex: 10mm
Front Bumper, Bumper Stay, Hood and Front Fender
Lexus CT200, ES350, HS250, IS & SC430,
Scion and Toyota 1995 - On

UNIT PACKAGE: 25



12339
(11500996, 11505023)
Phosphate
M6.3-1.81 x 25mm (#14 x 1")
Hex Head Sems®
Washer Outer Diameter: 17mm (21/32")
Hex: 10mm
GM

UNIT PACKAGE: 50



12354
(11500997)
Phosphate
M6.3-1.81 x 30mm
(#14 x 1-3/16")
Hex Head Sems®
Washer Outer Diameter: 17mm (21/32")
Hex: 10mm
GM

UNIT PACKAGE: 50



12068
(11504981)
Phosphate
M6.3-1.81 x 30mm
(#14 x 1-3/16")
Hex Head Sems®
Washer Outer Diameter: 24mm(15/16")
Hex: 10mm
GM

UNIT PACKAGE: 50



22295
(Hyundai: 12493-06207B)
Black Phosphate
M6.5-1.81 x 18mm
Phillips Truss Head
Head Outer Diameter: 16mm
Fender Liner
Hyundai Accent, Azera, Elantra,
Entourage, Genesis, I30, Santa Fe,
Sonata, Tiburon, Tucson, Veloster &
Veracruz 2013 - 2005

UNIT PACKAGE: 25



22296
(Hyundai: 92155-22000;
11254-06206)
Black Phosphate
M6.5-1.81 x 25mm
Phillips Truss Head
Head Outer Diameter: 16mm
Headlamp Assembly Mounting Screw
Hyundai 2000 - On

UNIT PACKAGE: 25



21837

(Toyota: 90159-60525)
Black E-Coat

M6.5-2.5 x 19mm (#14 x 3/4")
Phillips Hex Head Sems®
Washer Outer Diameter: 20mm (25/32")
Hex: 10mm
Floor Pan & Lower Back Panel Moulding,
Rear Bumper Stay, Suspension Cross
Member and Under Cover
Toyota 1998 - On

UNIT PACKAGE: 25



10364

Black Oxide

5/16"-12 x 7/8"
Hex Washer Head
Washer Head Outer Diameter: 21/32"
Hex: 1/2"

UNIT PACKAGE: 100



10714

(9796223)
Phosphate

5/16"-12 x 1"
Hex Washer Head
Washer Head Outer Diameter: 21/32"
Hex: 1/2"
GM

UNIT PACKAGE: 50

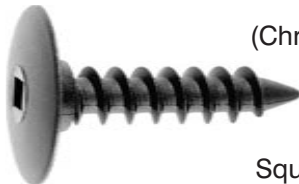

19417

(Chry: 6503819, 6503401;
GM: 25631448)
Black Nylon

M7.5 x 35mm
Square Drive Truss Head
Head Diameter: 22mm
Shoulder Diameter: 9mm
Foam to Bumper Fascia
Chrysler 1993-On
GM 1997-On

UNIT PACKAGE: 15



21517

(GM: 25705182)
Black Nylon

M9.5 x 46mm
Bumper Fascia Nylon Screw
Square Drive
Head Diameter: 22mm
GM 2004 - On

UNIT PACKAGE: 25



12350

(11500086)
Phosphate

M8-2.12 x 20mm (5/16"-12 x 25/32")
Hex Washer Head
Washer Head Outer Diameter: 16mm (5/8")
Hex: 13mm
GM

UNIT PACKAGE: 25



20970

(Not Available from O.E.M.)
Black Nylon

M14 x 34mm
Bumper and Door Insulator
Nylon Screw
No. 3 Square Drive
Head Outer Diameter: 22mm
Fits into 12mm Hole
GM, Ford & Chrysler 2005 - On

UNIT PACKAGE: 25

HAVE YOU VISITED US ONLINE?

**Auveco's website has been completely renovated.
Our new design is user friendly with easy navigation and ordering.**

Product is searchable by car make, OEM number and category, as well as, several attribute drop downs within individual categories. All product also has stock availability listed.

**Make sure to head over to
www.auveco.com
to receive up to date information on all our products.**

Sec. 5

License Plate Screw Specification Chart

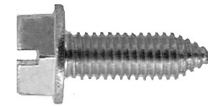

Auveco Part No.	Size	Length	Hex Size	Washer/Head O.D.	Type	Point Type	Finish	Unit Pkg.	Page No.
Machine Screw Thread									
18779	M5-0.8	12mm (15/32")		12.7mm (1/2")	Phillips Pan Washer Head	B	Zinc & Yellow Dichromate	100	107
17315	M6-1.0	12mm (15/32")	10mm	14mm (9/16")	Hex Flange Head	B	Zinc & Clear	50	107
17316	M6-1.0	16mm (5/8")	10mm	14mm (9/16")	Hex Flange Head	B	Zinc & Clear	50	108
14473	M6-1.0	16mm (5/8")		14mm (9/16")	Slotted Round Washer Head	B	Zinc	50	108
17152	M6-1.0	16mm (5/8")		14mm (9/16")	Slotted Round Washer Head	B	Black E-Coat	50	108
20680	M6-1.0	16mm (5/8")		14mm (9/16")	Phillips Round Washer Head	BT	Black Zinc	50	108
21181	M6-1.0	16mm (5/8")		12mm (15/32")	Slotted Pan Head with Hex Nut	B	Black Nylon	50 Sets	110
15413	M6-1.0	20mm (25/32")		12mm (15/32")	Slotted Pan Head with Hex Nut	B	Black Nylon	50 Sets	110
21606	M6-1.0	20mm (25/32")		12mm (15/32")	Phillips Pan Head with Hex Nut	B	Black Nylon	50 Sets	111
13934	M6-1.0	20mm (25/32")		12mm (15/32")	Slotted Pan Head with Hex Nut	B	Natural Nylon	25 Sets	111
18769	M6-1.0	20mm (25/32")		12mm (15/32")	Phillips Pan Head	B	Black E-Coat	50	108
16826	M6-1.0	20mm (25/32")	10mm	13mm (1/2")	Slotted Hex Washer Head	CA	Zinc	50	108
18239	M6-1.0	25mm (1")		12mm (15/32")	Slotted Pan Head with Hex Nut	B	Natural Nylon	25 Sets	111
18241	M6-1.0	25mm (1")		12mm (15/32")	Slotted Pan Head with Hex Nut	B	Black Nylon	25 Sets	111
5908	1/4"-20	1/2"		9/16"	Slotted Round Head	B	Zinc	100	107
5909	1/4"-20	1/2"		1/2"	Slotted Round Washer Head	B	Zinc	100	107
1313	1/4"-20	1/2"		9/16"	Slotted Truss Head with Hex Nut	B	Zinc	100 Sets	107
3184	1/4"-20	1/2"		9/16"	Slotted Truss Head with Square Nut	B	Zinc	100 Sets	109
3182	1/4"-20	1/2"		1/2"	Slotted Round Washer Head with Hex Nut	B	Zinc	100 Sets	109
3183	1/4"-20	1/2"		1/2"	Slotted Round Washer Head with Square Nut	B	Zinc	100 Sets	109
5885	1/4"-20	1/2"		1/2"	Slotted Round Washer Head with Wing Nut	B	Zinc	50 Sets	109
8427	1/4"-20	5/8"		1/2"	Slotted Pan Head with Nylon Nut	F	Zinc	50 Sets	110
13922	1/4"-20	5/8"		19/32"	Slotted Truss Washer Head with Washer Nut	B	Natural Nylon	25 Sets	110

(Continued on next page)

License Plate Screw Specification Chart

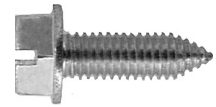

Auveco Part No.	Size	Length	Hex Size	Washer/ Head O.D.	Type	Point Type	Finish	Unit Pkg.	Page No.
Machine Screw Thread (continued)									
18484	1/4"-20	5/8"		19/32"	Slotted Truss Washer Head with Washer Nut	B	Black Nylon	25 Sets	110
5910	1/4"-20	3/4"		9/16"	Slotted Truss Head	B	Zinc	100	108
2472	1/4"-20	3/4"		9/16"	Slotted Round Washer Head with Square Nut	B	Zinc	100 Sets	110
Tapping Screw Thread									
18156	M4.8-1.59 (#10)	16mm (5/8")		10mm (3/8")	Phillips Wafer Head	AB	Zinc & Yellow	50	107
5278	#10	5/8"		1/2"	Slotted Truss Washer Head	AB	Zinc	100	107
17558	#10	3/4"		15/32"	Phillips Flat Washer Head	AB	Black E-Coat	100	107
17980	M6-1.81 (1/4"-14)	16mm (5/8")	10mm	13mm (1/2")	Phillips Hex Washer Head	AB	Zinc & Yellow Dichromate	50	108
16960	M6-1.81 (1/4"-14)	20mm (25/32")	10mm	12mm (15/32")	Phillips Hex Washer Head	AB	Zinc & Yellow Dichromate	50	109
17098	M6.3-1.81 (1/4"-14)	15mm (19/32")		13mm (1/2")	Phillips Truss Head	AB	Zinc & Yellow Dichromate	50	107
19777	M6.3-1.81 (#14)	16mm (5/8")		14mm (9/16")	Duo-Drive Truss Head	B	Dacromet 320	50	108
21081	M6.3-1.81 (#14)	20mm (25/32")		14mm (9/16")	Duo-Drive Truss Head	AB	Dacromet 320	50	109
15170	#14	1/2"			Thumb Screw	AB	Zinc Die Cast	25	109
15758	#14	5/8"		9/16"	Slotted Truss Head	Dog Pt	Zinc	50	107
8249	1/4"	5/8"		9/16"	Slotted Round Washer Head	B	Zinc	100	107
8250	1/4"	5/8"		9/16"	Slotted Round Washer Head with Nylon Nut	B	Zinc	25 Sets	109
16421	#14 (1/4")	5/8"	5/16"	5/8"	Slotted Hex Washer Head	B	Black E-Coat	50	107
16422	#14 (1/4")	5/8"	5/16"	5/8"	Slotted Hex Washer Head	B	Zinc	50	107
20446	#14 (1/4")	5/8"	5/16"	5/8"	Slotted Hex Washer Head	AB	Black E-Coat	50	108
21609	#14	3/4"		15/32"	Phillips Pan Head	A	Stainless Steel	100	108
9603	#14	3/4"		9/16"	Slotted Truss Head	AB	Zinc	100	108
16323	#14	3/4"		9/16"	Slotted Truss Head	AB	Black E-Coat	100	108
11369	#14	3/4"	3/8"	1/2"	Slotted Hex Washer Head	AB	Zinc	50	109
11370	#14	3/4"	3/8"	1/2"	Slotted Hex Washer Head with Nylon Nut	AB	Zinc	25 Sets	110
18354	#14	3/4"	3/8"	1/2"	Slotted Hex Washer Head	AB	Black E-Coat	50	109
20301	#14	1-3/16"		9/16"	Slotted Truss Head	B	Black E-Coat	50	109



18156

(51-81-1-821-830)
Zinc & Yellow

M4.8-1.59 x 16mm (#10 x 5/8")
Phillips Wafer Head License Plate Screw
Head O.D.: 10mm (3/8")
BMW

UNIT PACKAGE: 50



5278

(3783002)
Zinc

#10 x 5/8"
Slotted Truss Washer Head License Plate Screw
Washer Head O.D.: 1/2"
Use with Auveco Nut 5228
GM

UNIT PACKAGE: 100



17558

Black E-Coat (168 Hours Salt Spray)

#10 x 3/4"
Phillips Flat Washer Head License Plate Screw
Washer Head O.D.: 15/32"

UNIT PACKAGE: 100



18779

Zinc & Yellow Dichromate

M5-0.8 x 12mm
Phillips Pan Washer Head License Plate Screw
Washer Head O.D.: 12.7mm (1/2")
Ford Contour & Mercury Mystique 1995-On

UNIT PACKAGE: 100



17315

Zinc & Clear

M6-1.0 x 12mm
Hex Flange License Plate Screw
Flange O.D.: 14mm (9/16")
Hex: 10mm
Class 10.9
Acura

UNIT PACKAGE: 50



5908

Zinc

1/4"-20 x 1/2"
Slotted Round Head License Plate Screw
Head Diameter: 9/16"

UNIT PACKAGE: 100



5909

Zinc

1/4"-20 x 1/2"
Slotted Round Washer Head
License Plate Screw
Washer Head O.D.: 1/2"

UNIT PACKAGE: 100



17098

Zinc & Yellow Dichromate

M6.3-1.81 x 15mm (1/4"-14 x 19/32")
Phillips Truss Head License Plate Screw
Head Diameter: 13mm (1/2")

UNIT PACKAGE: 50



15758

Zinc

#14 x 5/8"
Slotted Truss Head with Dog Point
License Plate Screw
Head O.D.: 9/16"

UNIT PACKAGE: 50



8249

Zinc

1/4" x 5/8"
Slotted Round Washer Head
License Plate Screw
Washer Head O.D.: 9/16"
Use with Auveco Nut 8242

UNIT PACKAGE: 100



16421

(N800369-S2)
Black E-Coat

#14 (1/4") x 5/8"
Slotted Hex Washer Head License Plate Screw
Washer Head O.D.: 5/8"
Hex: 5/16"
Ford

UNIT PACKAGE: 50



16422

(N800369)
Zinc

#14 (1/4") x 5/8"
Slotted Hex Washer Head License Plate Screw
Washer Head O.D.: 5/8"
Hex: 5/16"
Ford

UNIT PACKAGE: 50



20446

Black E-Coat

#14 (1/4") x 5/8"
Slotted Hex Washer Head
License Plate Screw
Washer Head O.D.: 5/8"
Hex: 5/16"
Ford

UNIT PACKAGE: 50



17980

Zinc & Yellow Dichromate

M6-1.81 x 16mm (1/4"-14 x 5/8")
Phillips Hex Washer Head License Plate Screw
Washer Head O.D.: 13mm (1/2")
Hex: 10mm

UNIT PACKAGE: 50



17316

Zinc & Clear

M6-1.0 x 16mm
Hex Flange License Plate Screw
Flange O.D.: 14mm (9/16")
Hex: 10mm
Class 10.9
Acura

UNIT PACKAGE: 50



14473

Zinc

M6-1.0 x 16mm
Slotted Round Washer Head
License Plate Screw
Washer Head O.D.: 14mm (9/16")

UNIT PACKAGE: 50



17152

Black E-Coat (168 Hours Salt Spray)

M6-1.0 x 16mm
Slotted Round Washer Head
License Plate Screw
Washer Head O.D.: 14mm (9/16")

UNIT PACKAGE: 50



20680

Black Zinc

M6-1.0 x 16mm
Phillips Round Washer Head Thread Cutting
License Plate Screw
Washer Head O.D.: 14mm (9/16")
Hyundai

UNIT PACKAGE: 50



19777

Dacromet 320

M6.3-1.81 x 16mm (#14 x 5/8")
Duo-Drive Truss Head License Plate Screw
Head Diameter: 14mm
GM

UNIT PACKAGE: 50



21609

Stainless Steel

#14 x 3/4"
Phillips Pan Head License Plate Screw
Head O.D.: 15/32"

UNIT PACKAGE: 100



5910

Zinc

1/4"-20 x 3/4"
Slotted Truss Head License Plate Screw
Head Diameter: 9/16"

UNIT PACKAGE: 100



9603

Zinc

#14 x 3/4"
Slotted Truss Head License Plate Screw
Head Diameter: 9/16"

UNIT PACKAGE: 100



16323

Black E-Coat (168 Hours Salt Spray)

#14 x 3/4"
Slotted Truss Head License Plate Screw
Head Diameter: 9/16"

UNIT PACKAGE: 100



18769

Black E-Coat
(168 Hours Salt Spray)

M6-1.0 x 20mm
Phillips Pan Head License Plate Screw
Head Diameter: 12mm (15/32")

UNIT PACKAGE: 50

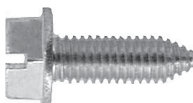

16826

(Chry: 34201287;
AMC: 8934201287)
Zinc

M6-1.0 x 20mm
Slotted Hex Washer Head License Plate Screw
Washer Head O.D.: 13mm (1/2")
Hex: 10mm

Chrysler, Honda & AMC

UNIT PACKAGE: 50



16960

(Toyota: 93904-46320;
Honda: 91500-SM4-999AH)
Zinc & Yellow Dichromate

M6-1.81 x 20mm (1/4"-14 x 3/4")
Phillips Hex Washer Head License Plate Screw
Washer Head O.D.: 12mm (1/2")
Hex: 10mm
Honda, GEO Prizm & Toyota 1990-On

UNIT PACKAGE: 50



11369

Zinc

#14 x 3/4"

Slotted Hex Washer Head License Plate Screw
Washer Head O.D.: 1/2"
Hex: 3/8"
Ford

UNIT PACKAGE: 50



18354

Black E-Coat
(168 Hours Salt Spray)

#14 x 3/4"

Slotted Hex Washer Head License Plate Screw
Washer Head O.D.: 1/2"
Hex: 3/8"
Ford

UNIT PACKAGE: 50



21081

(25732397)
Dacromet 320

M6.3-1.81 x 20mm
(#14 x 3/4")

Duo-Drive Truss Head License Plate Screw
Head Diameter: 14mm
GM 2002 - On

UNIT PACKAGE: 50



20301

(16502342)
Black E-Coat
(168 Hours Salt Spray)

#14 x 1-3/16"

Slotted Truss Head License Plate Screw
Head Diameter: 9/16"
GM S & T Trucks 1998 - On

UNIT PACKAGE: 50



15170

#14 x 1/2"
Dealer License
Plate Thumb Screw
Overall Length: 1-1/8"

UNIT PACKAGE: 25



1313

Zinc

1/4"-20 x 1/2"
Slotted Truss Head
License Plate Screw with Hex Nut
Head Diameter: 9/16"
Hex Width (ATF): 7/16"

UNIT PACKAGE: 100 Sets



3184

Zinc

1/4"-20 x 1/2"
Slotted Truss Head
License Plate Screw with Square Nut
Head Diameter: 9/16"
ATF: 7/16"

UNIT PACKAGE: 100 Sets



3182

Zinc

1/4"-20 x 1/2"
Slotted Round Washer Head
License Plate Screw with Hex Nut
Washer Head O.D.: 1/2"
Hex Width (ATF): 7/16"

UNIT PACKAGE: 100 Sets



3183

Zinc

1/4"-20 x 1/2"
Slotted Round Washer Head
License Plate Screw
with Square Nut
Washer Head O.D.: 1/2"
ATF: 7/16"

UNIT PACKAGE: 100 Sets



5885

Zinc

1/4"-20 x 1/2"
Slotted Round Washer Head
License Plate Screw with Flat Washer
and Wing Nut
Washer Head O.D.: 1/2"
Washer O.D.: 5/8"

UNIT PACKAGE: 50 Sets



8250

Zinc

1/4" x 5/8"
Slotted Round Washer Head
License Plate Screw and Nylon
Nut (Auveco No. 8249 & 8242)
Washer Head O.D.: 9/16"
Chrysler

UNIT PACKAGE: 25 Sets

LICENSE PLATE FASTENERS

Sec. 5



8427
(379046-S)
Zinc

1/4"-20 x 5/8"
Slotted Pan Head Type F Thread Cutting
License Plate Screw and
Nylon Nut (Auveco 5307 & 3682)
Head Diameter: 1/2"

UNIT PACKAGE: 50 Sets



2472
Zinc

1/4"-20 x 3/4"
Slotted Truss Head
License Plate Screw with Square Nut
Head Diameter: 9/16"
Hex Width (ATF): 7/16"

UNIT PACKAGE: 100 Sets



11370
Zinc

#14 x 3/4"
Slotted Hex Washer Head
License Plate Screw and
Nylon Nut (Auveco 11368 & 11369)
Washer Head O.D.: 1/2"
Hex: 3/8"
Ford

UNIT PACKAGE: 25 Sets



13922
Natural Nylon

1/4"-20 x 5/8"
Slotted Truss Washer Head
Washer Head O.D.: 19/32"
Washer Nut O.D.: 9/16"
Hex Width (ATF): 7/16"

UNIT PACKAGE: 25 Sets

17171
Screw only from 13922
UNIT PACKAGE: 50

18342
Screw only from 13922
UNIT PACKAGE: 1000

17228
Nut only from 13922
UNIT PACKAGE: 50

18346
Nut only from 13922
UNIT PACKAGE: 1000



18484
Black Nylon

1/4"-20 x 5/8"
Slotted Truss Washer Head
Washer Head O.D.: 19/32"
Washer Nut O.D.: 9/16"
Hex Width (ATF): 7/16"

UNIT PACKAGE: 25 Sets

18485
Screw only from 18484
UNIT PACKAGE: 50

18486
Screw only from 18484
UNIT PACKAGE: 1000

18487
Nut only from 18484
UNIT PACKAGE: 50

18488
Nut only from 18484
UNIT PACKAGE: 1000



21181
Black Nylon

M6-1.0 x 16mm
Slotted Pan Head
Head Diameter: 12mm (15/32")
Hex Width (ATF): 10mm (25/64")

UNIT PACKAGE: 50 Sets

21182
Screw only from 21181
UNIT PACKAGE: 100

21183
Screw only from 21181
UNIT PACKAGE: 1000

18348
Nut only from 21181
UNIT PACKAGE: 1000



15413
Black Nylon

M6-1.0 x 20mm
Slotted Pan Head
Head Diameter: 12mm (15/32")
Hex Width (ATF): 10mm (25/64")

UNIT PACKAGE: 50 Sets

17091
Screw only from 15413
UNIT PACKAGE: 100

18344
Screw only from 15413
UNIT PACKAGE: 1000

18348
Nut only from 15413
UNIT PACKAGE: 1000



13934

Natural Nylon

M6-1.0 x 20mm
Slotted Pan Head
Head Diameter: 12mm (15/32")
Hex Width (ATF): 10mm (25/64")

UNIT PACKAGE: 25 Sets

17169

Screw only from 13934
UNIT PACKAGE: 100

18343

Screw only from 13934
UNIT PACKAGE: 1000

18347

Nut only from 13934
UNIT PACKAGE: 1000



21606

Black Nylon

M6-1.0 x 20mm
Phillips Pan Head
Head Diameter: 12mm (15/32")
Hex Width (ATF): 10mm (25/64")

UNIT PACKAGE: 50 Sets

21607

Screw only from 21606
UNIT PACKAGE: 100

21608

Screw only from 21606
UNIT PACKAGE: 1000

18348

Nut only from 21606
UNIT PACKAGE: 1000



18239

Natural Nylon

M6-1.0 x 25mm
Slotted Pan Head
Head Diameter: 12mm (15/32")
Hex Width (ATF): 10mm (25/64")

UNIT PACKAGE: 25 Sets

18238

Screw only from 18239
UNIT PACKAGE: 50



18241

Black Nylon

M6-1.0 x 25mm
Slotted Pan Head
Head Diameter: 12mm (15/32")
Hex Width (ATF): 10mm (25/64")

UNIT PACKAGE: 25 Sets

18240

Screw only from 18241
UNIT PACKAGE: 50



16669

Bagged Hardware

2 Pieces each of 9603
(Slotted Truss
Head Screw: #14 x 3/4")
And 11719 (Nylon Nut)
Packaged in unmarked,
see-thru plastic bags.

UNIT PACKAGE: 50 Sets



16670

Bagged Hardware

4 Pieces each of 9603
(Slotted Truss
Head Screw: #14 x 3/4")
And 11719 (Nylon Nut)
Packaged in unmarked,
see-thru plastic bags.

UNIT PACKAGE: 50 Sets

16690

Same as 16670 except for unit package quantity

UNIT PACKAGE: 100 Sets



16800

Nylon Screw, Spacer,
Washer & Brass Nut

M6-1.0 x 20mm
Slotted Pan Head License
Plate Screw & Hardware
Head Diameter: 12mm (15/32")
Hex Width (ATF): 10mm (25/64")
Washer O.D.: 12.5mm (1/2")
Spacer O.D.: 19mm (3/4")
Toyota

UNIT PACKAGE: 25 Sets



17636

Nylon

License Plate Bracket Spacer
I.D.: 1/4" (6mm)
O.D.: 3/4" (19mm)
Thickness: 1/4" (6mm)
Toyota

UNIT PACKAGE: 50



2625

Nylon

License Plate Nut & Headlight Door Screw
Screw Size: #8
Mounting Screw Nut
Chrysler

UNIT PACKAGE: 100



5228
(3783006)
Nylon

License Plate Nut
Screw Size: #10
Use with Auveco Screw 5278
GM

UNIT PACKAGE: 50



20927
(N811478-S100)
Black Nylon

License Plate & Rear Bumper
Nylon Nut with Sealer
Screw Size: M6.3 (#14)
Head Size: 16mm x 16mm
Stem Length: 8mm
Ford Fusion & Mustang 2005 - On

UNIT PACKAGE: 15



13466
(6032516)
Black Nylon

License Plate Nut
Screw Size: #12
Chrysler

UNIT PACKAGE: 25



11368
(380707-S)
Nylon

License Plate Nut
Screw Size: #14
Ford

UNIT PACKAGE: 50

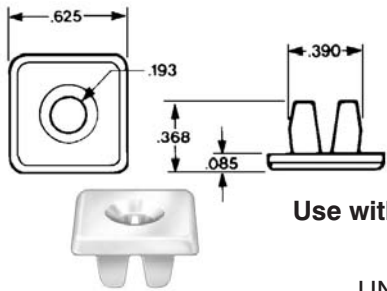

3682
(1196781)
Nylon

License Plate Nut
Screw Size: 1/4" -20
Use with Auveco Screw 5307
GM

UNIT PACKAGE: 50



8242
(6023925)
Nylon

License Plate Nut
Screw Size: 1/4" (#14)
Use with Auveco Screw 8249
Chrysler

UNIT PACKAGE: 50

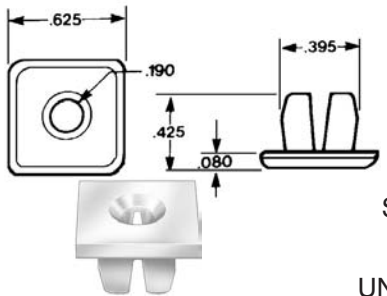

8435
(4755299)
Nylon

License Plate Nut
Screw Size: 1/4" (#14)
GM

UNIT PACKAGE: 50



8418
(380370)
Nylon

License Plate Nut
Screw Size: #14
Use with Auveco Screw 3089
GM

UNIT PACKAGE: 50



8954
Nylon

License Plate Nut
Screw Size: #14
Use with Auveco Screws 8249 or 8952

UNIT PACKAGE: 50

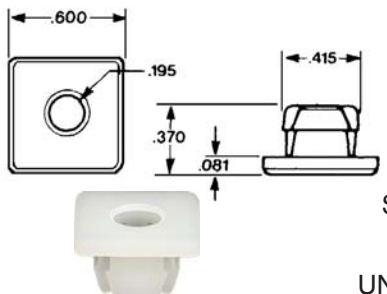

11719
(3907444)
Nylon

License Plate Nut
Screw Size: 1/4" (#14)
GM

UNIT PACKAGE: 50



19485
(6027958)
Natural Nylon

License Plate Nut
Screw Size: 1/4" (#14)
Chrysler

UNIT PACKAGE: 10



20937
(22546934)
Black Nylon

License Plate Screw Grommet
Screw Size: M6.3 (#14)
Head Size: 20mm x 20mm
Stem Length: 14mm
Buick Skylark, Chevrolet, Malibu,
Oldsmobile Achieva, Cutlass
& Intrigue 1992 - On

UNIT PACKAGE: 50



19317
(15707256)
Zinc Organic

Front Fender Extension
& License Plate Bracket
Retainer Nut
Screw Size: M6-1.0
GM Express &
Savanna 1996-On

UNIT PACKAGE: 10

AN IMPROVED FASTRACK WEB

FasTrack is an easy-to-use, web based system designed to assist body shops and dealerships in recovering the cost of body repair clips and fasteners used in daily collision repairs.

Features:

- **New Look:** User-friendly design and intuitive functions with over 10,000 collision repair fasteners by Auveco
- **Repair Kits:** Simple to build your own kits or choose one of the other preloaded kits
- **Add Part Numbers with Ease:** Add unique non-auveco items. Add new numbers on the fly during invoicing
- **OEM Numbers:** Available with the latest OEM pricing and ability to use during invoicing
- **Reports:** Page by page user selected printing to gather usage information
- **Inventory Management:** Allows shop and/or the distributor to track inventory
- **Labeling:** End user can print individual bar code labels and lid labels
- **Barcode Scanning:** Done with our app using any smart phone or with our wedge scanner
- **Online Catalog & OEM Crossover**
- **Repair Type:** Requested by many insurance companies you can now add Repair Type during invoice processing (Front Bumper, Front Fender, Door, etc.)
- **CCC® Integration:** Enables users to import FasTrack invoices into CCC's Estimating system
- **Tutorial Videos:** Found in the Help Menu, videos demonstrating all FasTrack features
- **Security:** Site protected by Verisign Internet Security.

Questions or concerns.

Call 1-800-354-9816 or email fastrack.support@auveco.com

CYLINDER HEAD AND MANIFOLD STUDS

Grade 8 Medium Carbon Heat Treated Alloy Steel

Sec. 6

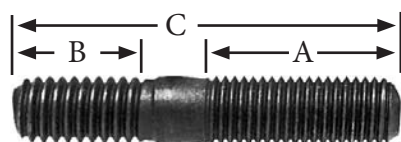

Auveco Part No.	A Diameter & Length	B Diameter & Length	C Overall Length	Unit Pkg.
19595•	1/4"-20 USS x 1/2"	1/4"-20 USS x 8"	9"	10
9667	1/4"-28 SAE x 3/8"	1/4"-20 USS x 7/16"	1"	10
9668	1/4"-28 SAE x 1/2"	1/4"-20 USS x 1/2"	1-1/4"	10
9669	1/4"-28 SAE x 3/4"	1/4"-20 USS x 1/2"	1-1/2"	10
9670	1/4"-28 SAE x 1"	1/4"-20 USS x 1/2"	2"	10
9673	5/16"-24 SAE x 7/16"	5/16"-18 USS x 3/8"	1"	10
9674	5/16"-24 SAE x 5/8"	5/16"-18 USS x 1/2"	1-1/4"	10
9675	5/16"-24 SAE x 5/8"	5/16"-18 USS x 3/4"	1-1/2"	10
9676	5/16"-24 SAE x 7/8"	5/16"-18 USS x 9/16"	1-3/4"	10
9677	5/16"-24 SAE x 1"	5/16"-18 USS x 9/16"	2"	10
14824	5/16"-24 SAE x 1-5/8"	5/16"-18 USS x 1/2"	2-1/2"	10
9679	5/16"-18 USS x 7/8"	5/16"-18 USS x 7/16"	1-1/2"	10
9680	5/16"-18 USS x 1"	5/16"-18 USS x 7/16"	2"	10
9681	5/16"-24 SAE x 1-1/2"	5/16"-18 USS x 5/8"	3"	10
9683	3/8"-24 SAE x 3/4"	3/8"-16 USS x 1/2"	1-1/2"	10
9684	3/8"-24 SAE x 3/4"	3/8"-16 USS x 1/2"	1-3/4"	10
9686	3/8"-24 SAE x 1"	3/8"-16 USS x 5/8"	2"	10
9687	3/8"-16 USS x 1"	3/8"-16 USS x 3/4"	2"	10
9688	3/8"-16 USS x 1"	3/8"-16 USS x 5/8"	2-1/8"	10
14827*	3/8"-16 USS x 1-5/8"	3/8"-16 USS x 7/16"	2-7/32"	10
19597*	3/8"-16 USS x 1/2"	3/8"-16 USS x 1-7/8"	2-1/2"	10
9689	3/8"-24 SAE x 1"	3/8"-16 USS x 3/4"	2-3/4"	10
12129	3/8"-16 USS x 5/8"	3/8"-16 USS x 2"	3"	10
9690	3/8"-24 SAE x 2"	3/8"-16 USS x 5/8"	3"	10
9692	3/8"-16 USS x 1-5/8"	3/8"-16 USS x 7/16"	3-1/4"	10
9695	3/8"-16 USS x 2"	3/8"-16 USS x 3/4"	4"	10
9696	3/8"-24 SAE x 1-7/8"	3/8"-16 USS x 1/2"	4"	10
9699	7/16"-20 SAE x 3/4"	7/16"-14 USS x 9/16"	1-3/4"	10
9701	7/16"-20 SAE x 7/8"	7/16"-14 USS x 3/4"	2"	10
9702	7/16"-14 USS x 15/16"	7/16"-14 USS x 3/4"	2"	10
9705	7/16"-20 SAE x 3/4"	7/16"-14 USS x 3/4"	2-1/4"	10
9709	7/16"-20 SAE x 7/8"	7/16"-14 USS x 3/4"	2-1/2"	10
9711	7/16"-14 USS x 1-1/4"	7/16"-14 USS x 3/4"	2-1/2"	10
9712	7/16"-20 SAE x 1-3/8"	7/16"-14 USS x 3/4"	2-1/2"	10
9715	7/16"-20 SAE x 1-13/16"	7/16"-14 USS x 3/4"	3"	10
9727	1/2"-20 SAE x 3/4"	1/2"-13 USS x 3/4"	1-7/8"	10
9728	1/2"-20 SAE x 15/16"	1/2"-13 USS x 13/16"	2"	10
9729	1/2"-20 SAE x 1"	1/2"-13 USS x 3/4"	2-1/4"	10
9731	1/2"-20 SAE x 1"	1/2"-13 USS x 3/4"	2-1/2"	10
9732	1/2"-20 SAE x 2"	1/2"-13 USS x 3/4"	3"	10
9739	9/16"-18 SAE x 1-1/4"	9/16"-12 USS x 1"	3"	10
9744	5/8"-11 USS x 1-1/2"	5/8"-11 USS x 13/16"	2-3/4"	10
9745	5/8"-18 SAE x 1-1/4"	5/8"-11 USS x 1"	3"	10

• Grade 2, Zinc Plated

* With Dog Point

CYLINDER HEAD AND MANIFOLD STUDS

Grade 8 Medium Carbon Heat Treated Alloy Steel

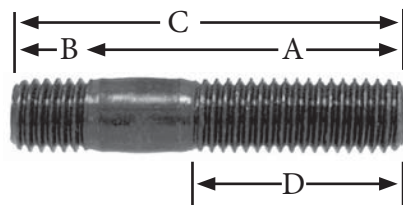

Auveco Part No.	A Diameter & Length	B Diameter & Length	C Overall Length	D Length	Unit Pkg.
11973	6mm-1.00 x 20mm	6mm-1.00 x 7.5mm	27.5mm	18mm	10
11974	6mm-1.00 x 25mm	6mm-1.00 x 7.5mm	32.5mm	18mm	10
11980	8mm-1.25 x 20mm	8mm-1.25 x 10mm	30.0mm	16mm	10
11981	8mm-1.25 x 25mm	8mm-1.25 x 10mm	35.0mm	22mm	10
11982	8mm-1.25 x 30mm	8mm-1.25 x 10mm	40.0mm	22mm	10
11983	8mm-1.25 x 35mm	8mm-1.25 x 10mm	45.0mm	22mm	10
11984	8mm-1.25 x 40mm	8mm-1.25 x 10mm	50.0mm	22mm	10
11987	8mm-1.25 x 55mm	8mm-1.25 x 10mm	65.0mm	22mm	10
11989	10mm-1.50 x 30mm	10mm-1.50 x 12mm	42.0mm	18mm	10
11990	10mm-1.50 x 35mm	10mm-1.50 x 12mm	47.0mm	26mm	10
11991	10mm-1.50 x 40mm	10mm-1.50 x 12mm	52.0mm	26mm	10
11993	10mm-1.50 x 50mm	10mm-1.50 x 12mm	62.0mm	26mm	10
11995	10mm-1.50 x 65mm	10mm-1.50 x 12mm	77.0mm	26mm	5
11998	12mm-1.75 x 30mm	12mm-1.75 x 15mm	45.0mm	25mm	5



11404

(N14-4003)
Plain

M8-1.25 x 35mm
Class 4.8
Volkswagen Intake Manifold

UNIT PACKAGE: 25

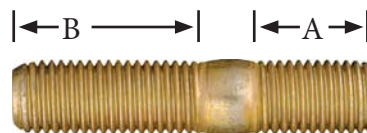

17560

Zinc & Yellow Dichromate

M10-1.25 x 48mm
Dim. A: 15mm; Dim. B: 25mm
Class 8.8
Exhaust Systems
Honda, Nissan & Toyota

UNIT PACKAGE: 10



17559

Zinc & Yellow Dichromate

M10-1.25 x 42mm
Class 8.8
Exhaust Systems
Honda, Nissan & Toyota

UNIT PACKAGE: 10



17596

Zinc & Yellow Dichromate

M12-1.25 x 50mm
Class 8.8
Catalytic Converter
Mazda

UNIT PACKAGE: 5



**Phillips Pan Head
Metric Machine Screws**
DIN 7985
Regular Pitch • Zinc Plated

Auveco Part No.	Diameter & Pitch	Length	Unit Pkg.
15867	4mm-.70	8mm	100
15868	4mm-.70	10mm	100
15869	4mm-.70	16mm	100
15870	5mm-.80	8mm	100
15871	5mm-.80	10mm	100
15872	5mm-.80	12mm	100
15873	5mm-.80	16mm	100
15874	5mm-.80	20mm	100
15875	5mm-.80	25mm	100
15876	6mm-1.00	10mm	100
15877	6mm-1.00	12mm	100
15878	6mm-1.00	16mm	50
15879	6mm-1.00	20mm	50
15880	6mm-1.00	25mm	50
15881	6mm-1.00	30mm	50



**Slotted Flat Fillister Head
Metric Machine Screws**
DIN 84
Regular Pitch • Zinc Plated

Auveco Part No.	Diameter & Pitch	Length	Unit Pkg.
10459	5mm-.80	16mm	25
10460	5mm-.80	20mm	25
14396	6mm-1.00	10mm	100
10464	6mm-1.00	20mm	25
14398	6mm-1.00	20mm	50



**Slotted Pan Head
Metric Machine Screws**
DIN 85
Regular Pitch • Zinc Plated

Auveco Part No.	Diameter & Pitch	Length	Unit Pkg.
10427	4mm-.70	10mm	25
10431	5mm-.80	12mm	25
10436	6mm-1.00	10mm	25
14391	6mm-1.00	10mm	100
10437	6mm-1.00	12mm	25
14392	6mm-1.00	12mm	100
10438	6mm-1.00	16mm	25
14393	6mm-1.00	16mm	100
10439	6mm-1.00	18mm	25
14394	6mm-1.00	18mm	100
10440	6mm-1.00	20mm	25
14395	6mm-1.00	20mm	100
10441	6mm-1.00	25mm	25



**Phillips Oval Head
Metric Machine Screws**
DIN 966
Regular Pitch • Zinc Plated

Auveco Part No.	Diameter & Pitch	Length	Unit Pkg.
15888	5mm-.80	12mm	100
15890	5mm-.80	20mm	100
15893	6mm-1.00	12mm	100
15895	6mm-1.00	20mm	50
15896	6mm-1.00	25mm	50



Slotted Flat Head Metric Machine Screws
DIN 963 (Medium Head)
Regular Pitch • Zinc Plated

Auveco Part No.	Diameter & Pitch	Length	Unit Pkg.
10478	4mm-.70	8mm	25

Auveco Part No.	Diameter & Pitch	Length	Unit Pkg.
10488	6mm-1.00	25mm	25



Regular Pitch Metric Hex Head Cap Screws

DIN 931 & DIN 933

Fully Threaded • 8.8 Heat Treated Alloy Steel • Zinc Plated
Tensile Strength: 116,000 PSI

Auveco Part No.	Diameter & Pitch	Length	Unit Pkg.
4mm (7mm Hex)			
14581	4mm-.7	12mm	50
10501	4mm-.7	16mm	25
14400	4mm-.7	16mm	50
10502	4mm-.7	20mm	25
14401	4mm-.7	20mm	50
14582	4mm-.7	25mm	50
5mm (8mm Hex)			
10504	5mm-.8	10mm	25
14402	5mm-.8	10mm	50
14583	5mm-.8	12mm	50
10505	5mm-.8	16mm	25
14403	5mm-.8	16mm	50
10506	5mm-.8	20mm	25
14404	5mm-.8	20mm	50
10507	5mm-.8	25mm	25
14405	5mm-.8	25mm	50
10508	5mm-.8	30mm	10
14406	5mm-.8	30mm	25
15512	5mm-.8	40mm	50
6mm (10mm Hex)			
14584	6mm-1.00	10mm	50
10509	6mm-1.00	12mm	25
14407	6mm-1.00	12mm	50
16697	6mm-1.00	12mm	100
10510	6mm-1.00	16mm	10
14408	6mm-1.00	16mm	25
16698	6mm-1.00	16mm	100
10511	6mm-1.00	20mm	10
14409	6mm-1.00	20mm	25
16699	6mm-1.00	20mm	100
10512	6mm-1.00	25mm	10
14410	6mm-1.00	25mm	25
16700	6mm-1.00	25mm	100
10513*	6mm-1.00	30mm	10
14411*	6mm-1.00	30mm	25
16701*	6mm-1.00	30mm	100
10514*	6mm-1.00	35mm	10
14412*	6mm-1.00	35mm	25
10515*	6mm-1.00	40mm	10
14413*	6mm-1.00	40mm	25
10516*	6mm-1.00	45mm	10
14414*	6mm-1.00	45mm	25
14585*	6mm-1.00	50mm	25
15514*	6mm-1.00	60mm	25
7mm (11mm Hex)			
14586	7mm-1.00	12mm	25
10517	7mm-1.00	16mm	10
14415	7mm-1.00	16mm	25
10519	7mm-1.00	25mm	10
14417	7mm-1.00	25mm	25
10520	7mm-1.00	30mm	10
14418	7mm-1.00	30mm	25
14587	7mm-1.00	40mm	25

Auveco Part No.	Diameter & Pitch	Length	Unit Pkg.
8mm (13mm Hex)			
14588	8mm-1.25	12mm	25
10521	8mm-1.25	16mm	10
14419	8mm-1.25	16mm	25
16702	8mm-1.25	16mm	50
10522	8mm-1.25	20mm	10
14420	8mm-1.25	20mm	25
16703	8mm-1.25	20mm	50
10523	8mm-1.25	25mm	10
14421	8mm-1.25	25mm	25
16704	8mm-1.25	25mm	50
10524	8mm-1.25	30mm	10
14422	8mm-1.25	30mm	25
16705	8mm-1.25	30mm	50
10525*	8mm-1.25	35mm	10
14423*	8mm-1.25	35mm	25
16706*	8mm-1.25	35mm	50
10526*	8mm-1.25	40mm	10
14424*	8mm-1.25	40mm	25
16707*	8mm-1.25	40mm	50
10527*	8mm-1.25	45mm	10
14425*	8mm-1.25	45mm	25
10528*	8mm-1.25	50mm	10
14426*	8mm-1.25	50mm	25
10529*	8mm-1.25	55mm	10
14427*	8mm-1.25	55mm	25
10530*	8mm-1.25	60mm	10
14428*	8mm-1.25	60mm	25
10532	8mm-1.25	70mm	5
14429	8mm-1.25	70mm	10
14589*	8mm-1.25	75mm	10
17399*	8mm-1.25	80mm	15
17400*	8mm-1.25	90mm	15
17401*	8mm-1.25	100mm	10
10mm (17mm Hex)			
10534	10mm-1.50	20mm	10
14430	10mm-1.50	20mm	25
16708	10mm-1.50	20mm	50
10535	10mm-1.50	25mm	10
14431	10mm-1.50	25mm	25
16709	10mm-1.50	25mm	50
10536	10mm-1.50	30mm	10
14432	10mm-1.50	30mm	25
16710	10mm-1.50	30mm	50
10537	10mm-1.50	35mm	5
14433	10mm-1.50	35mm	15
16711	10mm-1.50	35mm	25
10538*	10mm-1.50	40mm	5
14434*	10mm-1.50	40mm	15
16712*	10mm-1.50	40mm	25
10539*	10mm-1.50	45mm	5
14435*	10mm-1.50	45mm	15
10540*	10mm-1.50	50mm	5
14436*	10mm-1.50	50mm	15
16713*	10mm-1.50	50mm	25

*DIN 931 - Not Fully Threaded

(Continued on next page)



Regular Pitch Metric Hex Head Cap Screws

DIN 931 & DIN 933

Fully Threaded • 8.8 Heat Treated Alloy Steel • Zinc Plated
Tensile Strength: 116,000 PSI

Auveco Part No.	Diameter & Pitch	Length	Unit Pkg.	Auveco Part No.	Diameter & Pitch	Length	Unit Pkg.
10mm (17mm Hex) Continued				12mm (19mm Hex) Continued			
10541*	10mm-1.50	55mm	5	14444*	12mm-1.75	45mm	10
14437*	10mm-1.50	55mm	10	10549*	12mm-1.75	50mm	5
10542*	10mm-1.50	60mm	5	14445*	12mm-1.75	50mm	10
14438*	10mm-1.50	60mm	10	10550*	12mm-1.75	60mm	5
16714*	10mm-1.50	60mm	25	14446*	12mm-1.75	60mm	10
10543*	10mm-1.50	70mm	5	10551*	12mm-1.75	70mm	5
14439*	10mm-1.50	70mm	10	14447*	12mm-1.75	70mm	10
15515*	10mm-1.50	80mm	10	17403*	12mm-1.75	80mm	10
15516*	10mm-1.50	90mm	10	17404*	12mm-1.75	90mm	10
15517*	10mm-1.50	100mm	10	17405*	12mm-1.75	100mm	5
12mm (19mm Hex)				14mm (22mm Hex)			
10544	12mm-1.75	25mm	5	14590	14mm-2.0	30mm	10
14440	12mm-1.75	25mm	10	14591	14mm-2.0	40mm	10
16715	12mm-1.75	25mm	25	14592	14mm-2.0	50mm	10
10545	12mm-1.75	30mm	5	16mm (24mm Hex)			
14441	12mm-1.75	30mm	10	14595	16mm-2.0	30mm	5
16716	12mm-1.75	30mm	25	14598*	16mm-2.0	60mm	5
10546	12mm-1.75	35mm	5	20mm (30mm Hex)			
14442	12mm-1.75	35mm	10	14602	20mm-2.5	60mm	5
16717	12mm-1.75	35mm	25	*DIN 931 - Not Fully Threaded			
10547	12mm-1.75	40mm	5				
14443	12mm-1.75	40mm	10				
16718	12mm-1.75	40mm	25				
10548*	12mm-1.75	45mm	5				

J.I.S Small Head Cap Screws

J.I.S. B 1180 • I.S.O. Class 8.8

Heat Treated • Steel • Zinc Plated



J.I.S. fasteners have a smaller hex dimension (across the flats) than DIN or ISO metric fasteners. They fit in those tight spots where the hex of an ISO or DIN fastener is too large. J.I.S. fasteners are OEM equipment on many GM and Japanese import car applications.

Auveco Part No.	Diameter & Pitch	Length	Unit Pkg.	Auveco Part No.	Diameter & Pitch	Length	Unit Pkg.
M8-1.25 (12mm Hex)				M12-1.25 (17mm Hex)			
14777	8mm-1.25	16mm	25	16609	12mm-1.25	20mm	10
14778	8mm-1.25	20mm	25	16610	12mm-1.25	25mm	10
14779	8mm-1.25	25mm	25	16611	12mm-1.25	30mm	10
14780	8mm-1.25	30mm	25	16612	12mm-1.25	35mm	10
14781	8mm-1.25	35mm	25	16613	12mm-1.25	40mm	10
14782	8mm-1.25	40mm	25	16614	12mm-1.25	50mm	10
14784	8mm-1.25	50mm	25				
M10-1.25 (14mm Hex)							
14787	10mm-1.25	20mm	25				
14788	10mm-1.25	25mm	25				
14789	10mm-1.25	30mm	25				
14790	10mm-1.25	35mm	15				
14791	10mm-1.25	40mm	15				
14792	10mm-1.25	45mm	15				
14793	10mm-1.25	50mm	15				
14794	10mm-1.25	60mm	10				



Fine Pitch Metric Hex Head Cap Screws
DIN 960 & DIN 961

Fully Threaded
8.8 Heat Treated Alloy Steel • Black Finish
Tensile Strength: 116,000 PSI

Auveco Part No.	Diameter & Pitch	Length	Unit Pkg.
8mm (13mm Hex)			
11255	8mm-1.00	10mm	10
11257	8mm-1.00	25mm	10
11259	8mm-1.00	40mm	10
14604*	8mm-1.00	50mm	25
10mm (17mm Hex)			
11262	10mm-1.00	30mm	10
11263	10mm-1.00	40mm	10
11264	10mm-1.00	50mm	10
14605	10mm-1.25	20mm	10
11265	10mm-1.25	25mm	10
11266	10mm-1.25	30mm	10
11267	10mm-1.25	35mm	10
11268	10mm-1.25	40mm	10
11269	10mm-1.25	50mm	10
14606*	10mm-1.25	60mm	10
12mm (19mm Hex)			
11270	12mm-1.25	25mm	10
14607	12mm-1.25	30mm	5
11271	12mm-1.25	35mm	5
14608	12mm-1.25	40mm	5
14610*	12mm-1.25	70mm	5
11273	12mm-1.50	20mm	10
11274	12mm-1.50	30mm	10
11275	12mm-1.50	40mm	5
11276	12mm-1.50	50mm	5
14mm (22mm Hex)			
14611	14mm-1.50	30mm	5
14612	14mm-1.50	40mm	5
14613	14mm-1.50	50mm	5
16mm (24mm Hex)			
14616	16mm-1.50	30mm	5
14617	16mm-1.50	40mm	5

*DIN 931 - Not Fully Threaded



Metric Low Socket Head Cap Screws
DIN 6912

Regular Pitch - Grade 8.8
Heat Treated Alloy Steel • Plain Finish
Tensile Strength: 116,000 PSI

Auveco Part No.	Diameter & Pitch	Length	Unit Pkg.
10898	5mm-.8	10mm	10



Metric Hex Socket Head Cap Screw
DIN 912

Regular Pitch - Grade 12.9
Heat Treated Alloy Steel • Plain Finish
Tensile Strength: 177,000 PSI

Auveco Part No. Unit Package		Diameter & Pitch	Length
10	100		
10845	10872	4mm-.7	12mm
10846	10873	5mm-.8	12mm
10848	10875	5mm-.8	20mm
10851	10878	6mm-1.00	16mm
10853		6mm-1.00	25mm
10854		6mm-1.00	30mm
10855		8mm-1.25	16mm
10858	10885	8mm-1.25	30mm
10859		8mm-1.25	35mm
10861		10mm-1.50	20mm
10863		10mm-1.50	30mm
10864		10mm-1.50	40mm
10865		10mm-1.50	50mm
10866		12mm-1.75	30mm
10868		12mm-1.75	40mm
10870		12mm-1.75	60mm



Metric Flat Head Socket Cap Screws
DIN 7991

Regular Pitch - Grade 10.9
Heat Treated Alloy Steel • Plain Finish
Tensile Strength 150,800 PSI

Auveco Part No. Unit Package		Diameter & Pitch	Length
10	100		
10960	10961	6mm-1.00	16mm
10970		8mm-1.25	20mm
10972		8mm-1.25	25mm



Metric Hex Key
Plain Finish

Use with Din 912 & Din 7991

Auveco Part No.	Hex Size	For Screw Size	Unit Pkg.
7965	3mm	4mm	10



Metric Socket Set Screws - Cup Point DIN 916

Regular Pitch - Grade 12.9
Heat Treated Alloy Steel • Plain Finish

Auveco Part No.	Diameter & Pitch	Length	Unit Pkg.
11006	5mm-.8	10mm	10
11024	8mm-1.25	20mm	10
11032	10mm-1.50	20mm	10

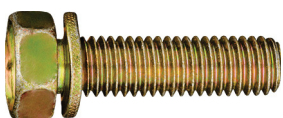

Hex Head Sems® Split Wave Washer Body Bolts for Import Cars

Class 9.8 • Zinc & Yellow Dichromate Plated

Auveco Part No.	Size	Hex Size	Washer O.D.	Unit Pkg.
16751	M6-1.0 x 30mm	10mm	11mm	25
16754	M8-1.25 x 30mm	13mm	14mm	25
16755	M8-1.25 x 40mm	13mm	14mm	25



Hex Head Sems® Split Wave Washer Body Bolts with Flat Washers for Import Cars

Flat Washer is packed loose in box

Class 9.8 • Zinc & Yellow Dichromate Plated

Auveco Part No.	Size	Hex Size	Wave Washer O.D.	Flat Washer O.D.	Unit Pkg.
16761	M8-1.25 x 30mm	13mm	14mm	17mm	25
16762	M8-1.25 x 40mm	13mm	14mm	17mm	25



Torx® Round Washer Head Body Bolts CA Point • Plated

Auveco Part No.	Size	Finish	Washer Head Dia.	Torx Drive	Unit Pkg.
15807	M6-1.0 x 25mm	Zinc	18mm	T-30	50



Hex Head Sems® Body Bolts for Import Cars

Class 8.8 • Zinc & Yellow Dichromate Plated

Auveco Part No.	Size	Hex Size	Washer O.D.	Unit Pkg.
20434	M6-1.0 x 12mm	10mm	12.5mm	50
18177	M6-1.0 x 16mm	10mm	12.5mm	50
20435	M6-1.0 x 20mm	10mm	12.5mm	50
18187	M8-1.25 x 45mm	12mm	17mm	25

Metric Hex Flange Serrated Bolts



Serrations under the Head
Class 10.9
(Property Class 90)
Black Phosphate

Auveco Part No.	Size	Hex	Unit Pkg.
16793	M6-1.0 x 16mm	10mm	25
16794	M6-1.0 x 20mm	10mm	25
16795	M8-1.25 x 16mm	13mm	25



J.I.S. Small Head Hex Flange Bolts

J.I.S. B1189 • I.S.O. Class 10.9 • Zinc Plated
10mm Bolts are used with Auveco Hex Flange Nut 16470 on Import Car Exhaust Systems

Auveco Part No.	Size	Hex Size	Flange O.D.	Unit Pkg.
17315	M6-1.0 x 12mm	10mm	14mm	50
17316	M6-1.0 x 16mm	10mm	14mm	50
18807	M6-1.0 x 20mm	10mm	14mm	50
21048	M6-1.0 x 25mm	10mm	14mm	25
18808	M6-1.0 x 30mm	10mm	14mm	25
21049	M6-1.0 x 35mm	10mm	14mm	25
18809	M6-1.0 x 40mm	10mm	14mm	25
21050	M6-1.0 x 45mm	10mm	14mm	25
18980	M8-1.25 x 12mm	12mm	17.5mm	25
17387	M8-1.25 x 16mm	12mm	17.5mm	15
17388	M8-1.25 x 20mm	12mm	17.5mm	15
21051	M8-1.25 x 25mm	12mm	17.5mm	15
17389	M8-1.25 x 30mm	12mm	17.5mm	15
21052	M8-1.25 x 35mm	12mm	17.5mm	15
17390	M8-1.25 x 40mm	12mm	17.5mm	15
21053	M8-1.25 x 45mm	12mm	17.5mm	15

17188	M10-1.25 x 16mm	14mm	20mm	10
17189	M10-1.25 x 20mm	14mm	20mm	10
21054	M10-1.25 x 25mm	14mm	20mm	10
17190	M10-1.25 x 30mm	14mm	20mm	10
21055	M10-1.25 x 35mm	14mm	20mm	10
17191	M10-1.25 x 40mm	14mm	20mm	10
21056	M10-1.25 x 45mm	14mm	20mm	10



**Metric Body Bolt
Specification Chart**



Auveco Part No.	Size	Length	Hex Size	Washer/ Head O.D.	Type	Point Type	Finish	Unit Pkg.	Page No.
22164	M4-7	16mm	7mm	13mm	Hex Head Sems®	Dog Pt	Phosphate	50	123
12232	M5-0.8	20mm	8mm	12mm	Hex Head Sems	Dog Pt	Phosphate	50	123
22271	M5-0.8	23mm	8mm	18mm	Phillips Hex Head Sems	Dog Pt	Zinc	50	123
21840	M6-1.0	11mm	10mm	15.5mm	Hex Head Flange	C	Black E-Coat	25	123
20434	M6-1.0	12mm	10mm	12.5mm	Hex Head Sems	C	Zinc & Yellow Dichromate	50	120
22293	M6-1.0	15mm	10mm	18mm	Hex Washer Head Sems		Black Phos.	25	123
18177	M6-1.0	16mm	10mm	12.5mm	Hex Head Sems	C	Zinc & Yellow Dichromate	50	120
15791	M6-1.0	16mm	10mm	17mm	Hex Head Sems	C	Black Fluorocarbon	50	123
12064	M6-1.0	16mm	10mm	18.5mm	Hex Head Sems	C	Zinc & Yellow	50	123
20176	M6-1.0	18.5mm	11mm	19mm	Hex Head Sems	Dog Pt.	Phos.	50	123
18515	M6-1.0	20mm	T-30 Drive	13.5mm	Torx® Washer Head	Dog Pt.	Black Organic	25	123
20435	M6-1.0	20mm	10mm	12.5mm	Hex Head Sems	C	Zinc & Yellow Dichromate	50	120
12324	M6-1.0	20mm	10mm	13mm	Hex Washer Head	CA	Blk Phos.	50	123
16826	M6-1.0	20mm	10mm	13mm	Slotted Hex Washer Head	CA	Zinc	50	124
12322	M6-1.0	20mm	10mm	17mm	Hex Head Sems	C	Phos.	25	124
12693	M6-1.0	20mm	10mm	17mm	Hex Head Sems	CA	Phos.	25	124
12067	M6-1.0	20mm	10mm	17mm	Hex Head Sems	C	Phos.	50	124
13617	M6-1.0	20mm	10mm	24mm	Hex Head Sems	CA	Phos.	50	124
12160	M6-1.0	22mm	8mm	19mm	High Hex Head Sems	Dog Pt	Phos.	25	124
15778	M6-1.0	22.5mm	8mm	19mm	Hex Head Sems	Dog Pt	Zinc	50	124
13715	M6-1.0	25mm	10mm	13mm	Hex Washer Head	CA	Phos.	50	124
15807	M6-1.0	25mm	T-30 Drive	18mm	Torx Round Washer Head	CA	Zinc	50	120
12065	M6-1.0	25mm	10mm	17mm	Hex Head Sems	CA	Phos.	50	124
15788	M6-1.0	25mm	10mm	17mm	Hex Head Sems	CA	Zinc	50	124
19455	M6-1.0	25mm	10mm	19mm	Hex Head Sems	Dog Pt	Phos.	25	125
12066	M6-1.0	25mm	10mm	24mm	Hex Head Sems	CA	Phos	50	125
12323	M6-1.0	25mm	10mm	24mm	Hex Head Sems	CA	Blk Polyseal	25	125
14947	M6-1.0	26mm	T-30 Drive	16mm	Pan Head Torx Sems	Dog Pt	Stainless Steel	25	125
15779	M6-1.0	28mm	8mm	19mm	Hex Head Sems	Dog Pt	Blk Zinc Phos.	50	125
12335	M6-1.0	28mm	8mm	19mm	Hex Head Sems	Dog Pt	Zinc & Yellow	25	125
16893	M6-1.0	28mm	8mm	25mm	Hex Head Sems	Dog Pt	Phos.	25	125
16751	M6-1.0	30mm	10mm	11mm	Hex Head Sems® Split Wave Washer	C	Zinc & Yellow Dichromate	25	120

(Continued on next page)

METRIC ITEMS



Metric Body Bolt Specification Chart



Auveco Part No.	Size	Length	Hex Size	Washer/ Head O.D.	Type	Point Type	Finish	Unit Pkg.	Page No.
22232	M6-1.0	30mm	10mm	18mm	Hex Head Sems	Dog Pt	Black Zinc	25	125
15818	M6-1.0	30mm	10mm	19mm	Hex Head Sems	Dog Pt	Phos.	50	125
20261	M6-1.0	30mm	10mm	20mm	Hex Head Sems	CA	Phos.	25	126
13618	M6-1.0	30mm	10mm	24mm	Hex Head Sems	CA	Phos.	50	126
18416	M6-1.0	35mm	10mm	17mm	Hex Head Sems	CA	Blk Phos.	50	126
11633	M6.3-1.0	20mm	10mm	17mm	Hex Head Sems	CA	Phos.	25	126
11935	M6.3-1.0	25mm	10mm	17mm	Hex Head Sems	CA	Zinc	25	126
11638	M8-1.25	16mm	13mm	18mm	Hex Washer Head with Serrations Under the Head	Dog Pt	Phos	25	126
13704	M8-1.25	20mm	13mm	24mm	Hex Head Sems	CA	Phos	25	126
12336	M8-1.25	25mm	13mm	17mm	Hex Washer Head	CA	Phos.	25	126
15790	M8-1.25	25mm	13mm	17mm	Hex Head Sems	CA	Phos.	50	126
11639	M8-1.25	25mm	13mm	17mm	Hex Washer Head	CA	Phos.	25	126
13613	M8-1.25	25mm	13mm	24mm	Hex Head Sems	CA	Phos.	25	126
16754	M8-1.25	30mm	13mm	14mm	Hex Head Sems Split Wave Washer	C	Zinc & Yellow Dichromate	25	120
16761	M8-1.25	30mm	13mm	14mm & 17mm	Hex Head Sems Split Wave Washer & Flat Washer	C	Zinc & Yellow Dichromate	25	120
12348	M8-1.25	30mm	13mm	17mm	Hex Washer Head	CA	Phos.	25	127
11640	M8-1.25	30mm	13mm	17mm	Hex Washer Head	CA	Zinc Organic	25	127
13614	M8-1.25	30mm	13mm	24mm	Hex Head Sems	CA	Phos.	25	127
15780	M8-1.25	33mm	10mm	22mm	Hex Head Sems	Dog Pt	Phos.	50	127
12343	M8-1.25	35mm	13mm	17mm	Hex Washer Head	CA	Phos.	25	127
13705	M8-1.25	35mm	13mm	24mm	Hex Head Sems	CA	Phos.	25	127
16755	M8-1.25	40mm	13mm	14mm	Hex Head Sems Split Wave Washer	C	Zinc & Yellow Dichromate	25	120
16762	M8-1.25	40mm	13mm	14mm & 17mm	Hex Head Sems Split Wave Washer & Flat Washer	C	Zinc & Yellow Dichromate	25	120
16931	M8-1.25	42mm	10mm	22mm	Hex Head Sems	Dog Pt	Phos.	25	127
18187	M8-1.25	45mm	12mm	17mm	Hex Head Sems	C	Zinc & Yellow Dichromate	25	120
13619	M10-1.50	30mm	15mm	29mm	Hex Head Sems	CA	Phos.	10	127
12327	M10-1.50	33mm	13mm	20mm	Hex Washer Head	Dog Pt	Phos.	25	127
11641	M10-1.50	40mm	15mm	29mm	Hex Head Sems	CA	Phos.	25	127



22164
(GM: 11502618)
Phosphate

M4-.7 x 16mm
Hex Head Sems® with Dog Point
Washer Diameter: 13mm
Hex: 7mm
GM

UNIT PACKAGE: 50

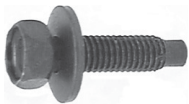

12232
(6100539)
Phosphate

M5-0.8 x 20mm
Hex Head Sems®
Thread Cutting Screw with Dog Point
Outer Diameter Washer: 12mm (1/2")
Hex: 8mm
Chrysler

UNIT PACKAGE: 50



22271
(Subaru: 901935002)
Black Zinc

M5-0.8 x 23mm
Phillips Hex Head Sems®
Body Bolt with Dog Point
Washer Diameter: 18mm
Hex Size: 8mm
Use with Auveco 22175
Subaru Forester & Legacy 1995 - On

UNIT PACKAGE: 50



21840
(Toyota: 90105-06037)
Black E-Coat

M6-1.0 x 11mm
Hex Head Flange
Flange Outer Diameter: 15.5mm
Hex: 10mm
Luggage Compartment Door & Lock and Radiator Grille
Toyota & Lexus 2001 - On

UNIT PACKAGE: 25



22293
(Mazda: 9GG600616T)
Black Phosphate

M6-1.0 x 15mm
Hex Washer Head Sems®
Washer Outer Diameter: 18mm
Hex: 10mm
Fender Liner
Mazda 1996 - On

UNIT PACKAGE: 25



15791
(11508930)
Black Fluorocarbon

M6-1.0 x 16mm
Hex Head Sems®
Class 9.8
Washer Outer Diameter: 17mm (21/32")
Hex: 10mm
GM

UNIT PACKAGE: 50



12064
(11503812)
Zinc & Yellow

M6-1.0 x 16mm
Hex Head Sems®
Class 9.8
Washer Outer Diameter: 18.5mm (47/64")
Hex: 10mm
GM

UNIT PACKAGE: 50



20176
(N800510-S100)
Phosphate

M6-1.0 x 18.5mm
Hex Head Sems® with Dog Point
Class 9.8
Washer Outer Diameter: 19mm (3/4")
Hex: 11mm
Replaces Auveco 15719
Ford

UNIT PACKAGE: 50



18515
(21094240)
Black

500 Hour Salt Spray
M6-1.0 x 20mm
Torx® Washer Head with Dog Point &
Sealant on Threads
T-30 Drive
Washer Head Outer Diameter: 13.5
Front & Rear Door Lock
GM Saturn

UNIT PACKAGE: 25



12324
(11503800)
Phosphate

M6-1.0 x 20mm
Hex Washer Head
Class 9.8
Washer Head Outer Diameter: 13mm (1/2")
Hex: 10mm
GM

UNIT PACKAGE: 50

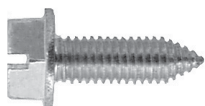

16826

(Chry: 34201287;
AMC: 8934201287)
Zinc

M6-1.0 x 20mm
Slotted Hex Washer Head
License Plate Screw
Washer Head O.D.: 13mm (1/2")
Hex: 10mm
Chrysler, Honda & AMC

UNIT PACKAGE: 50



12322

(11503815, 11508023)
Phosphate

M6-1.0 x 20mm
Hex Head Sems® with Grounding Teeth
Class 9.8
Washer Outer Diameter: 17mm (21/32")
Hex: 10mm
GM

UNIT PACKAGE: 25



12693

(11502941, 11506174)
Phosphate

M6-1.0 x 20mm
Hex Head Sems®
Class 9.8
Washer Outer Diameter: 17mm (21/32")
Hex: 10mm
GM

UNIT PACKAGE: 25



12067

(11504570, 11509816, 11514623)
Phosphate

M6-1.0 x 20mm
Hex Head Sems®
Class 9.8
Washer Outer Diameter: 17mm (21/32")
Hex: 10mm
GM

UNIT PACKAGE: 50



13617

(11503941)
Phosphate

M6-1.0 x 20mm
Hex Head Sems®
Class 9.8
Washer Outer Diameter: 24mm (15/16")
Hex: 10mm
GM

UNIT PACKAGE: 50



15778

(N606676-S36)
Zinc

M6-1.0 x 22.5mm
Hex Head Sems® with Dog Point
Class 9.8
Washer Outer Diameter: 19mm (3/4")
Hex: 8mm
Ford

UNIT PACKAGE: 50



12160

(N606676-S2, S100)
Phosphate

M6-1.0 x 22mm
High Hex Head Sems® with Dog Point
Class 9.8
Washer Outer Diameter: 19mm (3/4")
Hex: 8mm
Ford

UNIT PACKAGE: 25



13715

(11503958)
Phosphate

M6-1.0 x 25mm
Hex Washer Head
Class 9.8
Washer Head Outer Diameter: 13mm (1/2")
Hex: 10mm
GM

UNIT PACKAGE: 50



12065

(11503834, 20351035)
Phosphate

M6-1.0 x 25mm
Hex Head Sems®
Class 9.8
Washer Outer Diameter: 17mm (21/32")
Hex: 10mm
GM

UNIT PACKAGE: 50



15788

(11503833)
Zinc

M6-1.0 x 25mm
Hex Head Sems®
Washer Outer Diameter: 17mm (21/32")
Hex: 10mm
GM

UNIT PACKAGE: 50



19455
(6100567)
Phosphate

M6-1.0 x 25mm
Hex Head Sems® with Dog Point
Class 9.8
Washer Outer Diameter: 19mm (3/4")
Hex: 10mm
Grille, Fender, Hood Prop & Latch
Chrysler

UNIT PACKAGE: 25



12335
(N606677-S36)
Zinc & Yellow

M6-1.0 x 28mm
Hex Head Sems® with Dog Point
Class 9.8
Washer Outer Diameter: 19mm (3/4")
Hex: 8mm
Ford

UNIT PACKAGE: 25



12066
(11503982)
Phosphate

M6-1.0 x 25mm
Hex Head Sems®
Class 9.8
Washer Outer Diameter: 24mm (15/16")
Hex: 10mm
GM

UNIT PACKAGE: 50



16893
(N800947-S, AB-181-GG)
Phosphate

M6-1.0 x 28mm
Hex Head Sems® with Dog Point
Class 9.8
Washer Outer Diameter: 25mm (1")
Hex: 8mm
Ford

UNIT PACKAGE: 25



12323
(11504493)
Black Polyseal

M6-1.0 x 25mm
Hex Head Sems®
Class 9.8
Washer Outer Diameter: 24mm (15/16")
Hex: 10mm
GM

UNIT PACKAGE: 25



22232
(Ford: W711390-S900)
Black Zinc

M6-1.0 x 30mm
Hex Head Sems
with Dog Point & Thread Locking Patch
Washer Outer Diameter: 18mm (23/32")
Hex: 10mm
Ford F-150 Trucks with Aluminum Body 2015 - On

UNIT PACKAGE: 25



14947
(N801851-S45)
Stainless Steel

M6-1.0 x 26mm
Pan Head Internal Torx® Drive Sems®
T-30 Drive
Head Diameter: 14mm
Washer Outer Diameter: 16mm (5/8")
Truck Mirror Mounting Bracket Bolt
Ford Trucks

UNIT PACKAGE: 25



15818
(6100568)
Phosphate

M6-1.0 x 30mm
Hex Head Sems® with Dog Point
Class 9.8
Washer Outer Diameter: 19mm (3/4")
Hex: 10mm
Chrysler

UNIT PACKAGE: 50



15779
(N606677-S53B)
Black Zinc Phosphate

M6-1.0 x 28mm
Hex Head Sems® with Dog Point
Washer Outer Diameter: 19mm (3/4")
Hex: 8mm
Ford

UNIT PACKAGE: 50



20261
(10287379)
Phosphate

M6-1.0 x 30mm
Hex Head Sems®
Class 9.8
Washer Outer Diameter: 20mm (13/16")
Hex: 10mm
GM

UNIT PACKAGE: 25



13618
(11503825)
Phosphate

M6-1.0 x 30mm
Hex Head Sems®
Class 9.8
Washer Outer Diameter: 24mm (15/16")
Hex: 10mm
GM

UNIT PACKAGE: 50

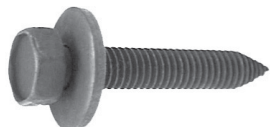

18416
(11505044)
Black Phosphate

M6-1.0 x 35mm
Hex Head Sems®
Class 9.8
Washer Outer Diameter: 17mm (21/32")
Hex: 10mm
GM

UNIT PACKAGE: 50



11633
(11501105)
Phosphate

M6.3-1.0 x 20mm
Hex Head Sems®
Class 9.8
Washer Outer Diameter: 17mm (21/32")
Hex: 10mm
GM

UNIT PACKAGE: 25



11935
(11502790)
Zinc

M6.3-1.0 x 25mm
Hex Head Sems®
Class 9.8
Washer Outer Diameter: 17mm (21/32")
Hex: 10mm
GM

UNIT PACKAGE: 25



11638
(362029m 11509589)
Phosphate

M8-1.25 x 22mm
Hex Washer Head with Serrations
under the Head & Dog Point
Washer Head Outer Diameter: 18mm (23/32")
Hex: 13mm
GM

UNIT PACKAGE: 25



13704
Phosphate

M8-1.25 x 20mm
Hex Head Sems®
Class 9.8
Washer Outer Diameter: 24mm (15/16")
Hex: 13mm

UNIT PACKAGE: 25

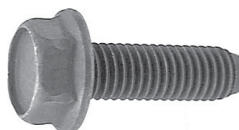

11639
(11502605,
11502624, 11509511)
Phosphate

M8-1.25 x 25mm
Hex Washer Head
Class 9.8
Washer Head O.D.: 17mm (21/32")
Hex: 13mm
GM

UNIT PACKAGE: 25



12336
(11503632)
Phosphate

M8-1.25 x 25mm
Hex Washer Head
Class 9.8
Washer Head Outer Diameter: 17mm (21/32")
Hex: 13mm
GM

UNIT PACKAGE: 25



15790
(11505326)
Phosphate

M8-1.25 x 25mm
Hex Head Sems®
Class 9.8
Washer Outer Diameter: 17mm (21/32")
Hex: 13mm
GM

UNIT PACKAGE: 50



13613
(11503619)
Phosphate

M8-1.25 x 25mm
Hex Head Sems®
Class 9.8
Washer Outer Diameter: 24mm (15/16")
Hex: 13mm
GM

UNIT PACKAGE: 25



12348
(11500971)
Phosphate

M8-1.25 x 30mm
Hex Washer Head
Class 9.8
Washer Head Outer Diameter: 17mm (21/32")
Hex: 13mm
GM

UNIT PACKAGE: 25



13705
(11503668)
Phosphate

M8-1.25 x 35mm
Hex Head Sems®
Class 9.8
Washer Outer Diameter: 24mm (15/16")
Hex: 13mm
GM

UNIT PACKAGE: 25



11640
(549790, 11500971)
Zinc Organic

M8-1.25 x 30mm
Hex Washer Head
Class 9.8
Washer Head Outer Diameter: 17mm (21/32")
Hex: 13mm
GM

UNIT PACKAGE: 25



16931
(N606692-S2,
AB-187EH)
Phosphate

M8-1.25 x 42mm
Hex Head Sems® with Dog Point
Class 9.8
Washer Outer Diameter: 22mm (7/8")
Hex: 10mm
Ford

UNIT PACKAGE: 25



13614
(11501188)
Phosphate

M8-1.25 x 30mm
Hex Head Sems®
Class 9.8
Washer Outer Diameter: 24mm (15/16")
Hex: 13mm
GM

UNIT PACKAGE: 25



13619
Phosphate

M10-1.50 x 30mm
Hex Head Sems®
Class 9.8
Washer Outer Diameter: 29mm (1-1/8")
Hex: 15mm

UNIT PACKAGE: 10



15780
(N606690-S2)
Phosphate

M8-1.25 x 33mm
Hex Head Sems® with Dog Point
Class 9.8
Washer Outer Diameter: 22mm (7/8")
Hex: 10mm
Ford

UNIT PACKAGE: 50



12327
(N605920-S2)
Phosphate

M10-1.50 x 33mm
Hex Washer Head with Dog Point
Class 9.8
Washer Head O.D.: 20mm (13/16")
Hex: 13mm
Ford

UNIT PACKAGE: 25



12343
(11504982)
Phosphate

M8-1.25 x 35mm
Hex Washer Head
Class 9.8
Washer Head Outer Diameter: 17mm (21/32")
Hex: 13mm
GM

UNIT PACKAGE: 25



11641
(11501193)
Phosphate

M10-1.50 x 40mm
Hex Head Sems®
Class 9.8
Washer Outer Diameter: 29mm (1-5/32")
Hex: 15mm
GM

UNIT PACKAGE: 25

METRIC ITEMS

Sec. 7



13620

Phosphate

M10-1.50 x 45mm

Hex Head Sems®

Class 9.8

Washer Outer Diameter: 30mm (1-3/16")

Hex: 15mm

UNIT PACKAGE: 10

Metric Special Tapping Screw Specification Chart

Auveco Part No.	Size	Length	Hex Size	Washer/ Head O.D.	Type	Point Type	Finish	Unit Pkg.	Page No.
12062	M4.2-1.41 (#8)	10mm (13/32")		11mm (7/16")	Phillips Washer Head Pozi-Drive	AB	Black Oxide	100	131
15941	M4.2-1.41 (#8)	12mm (15/32")		9.5mm (3/8")	Phillips Truss Head	AB	Black Oxide	10	131
16596	M4.2-1.41 (#8)	12mm (15/32")		9.5mm (3/8")	Phillips Truss Head	AB	Black Oxide	100	131
12739	M4.2-1.41 (#8)	12mm (15/32")		10mm (25/64")	Phillips Washer Head Pozi-Drive	AB	Chrome	100	131
12059	M4.2-1.41 (#8)	13mm (33/64")		11mm (7/16")	Phillips Washer Head	AB	Zinc	100	131
12061	M4.2-1.41 (#8)	13mm (33/64")		8.5mm (11/32")	Phillips Round Washer Head, Pozi-Drive	AB	Black Oxide	100	131
13712	M4.2-1.41 (#8)	13mm (33/64")		11mm (7/16")	Phillips Washer Head	AB	Black Zinc	50	131
12740	M4.2-1.41 (#8)	13mm (33/64")	7mm	12mm (15/32")	Hex Head Sems	AB	Phosphate	100	131
15721	M4.2-1.41 (#8)	13mm (33/64")	7mm	16mm (5/8")	Hex Head Sems	AB	Phosphate	50	131
18781	M4.2-1.41 (#8)	14mm (9/16")	7mm	8mm (5/16")	Hex Head Sems	AB	Phosphate	50	131
21122	M4.2-1.41 (#8)	14mm (9/16")		11mm (7/16")	Phillips Washer Head Pozi-Drive	Teks®	Chrome	50	131
18817	M4.2-1.41 (#8)	16mm (5/8")		11mm (7/16")	Phillips Round Washer Head, Pozi-Drive	Teks	Black Zinc	100	132
16720	M4.2-1.41 (#8)	16mm (5/8")		9.5mm (3/8")	Phillips Truss Head	AB	Black Oxide	100	132
12741	M4.2-1.41 (#8)	16mm (5/8")	7mm	12mm (15/32")	Hex Head Sems	AB	Phosphate	100	132
18261	M4.2-1.41 (#8)	16mm (5/8")	7mm	12mm (15/32")	Hex Washer Head Sems	Teks	Phosphate	50	132
12060	M4.2-1.41 (#8)	20mm (25/32")		11mm (7/16")	Phillips Washer Head	AB	Black Oxide	100	132
12097	M4.2-1.41 (#8)	20mm (25/32")		12mm (15/32")	Phillips Pan Head Sems®	AB	Chrome	50	132
12738	M4.2-1.41 (#8)	20mm (25/32")	7mm	12mm (15/32")	Hex Washer Head Sems	AB	Phosphate	50	132
12742	M4.2-1.41 (#8)	20mm (25/32")	7mm	12mm (15/32")	Hex Head Sems	AB	Phosphate	100	132
15373	M4.2-1.41 (#8)	20mm (25/32")	7mm	16mm (5/8")	Hex Head Sems	AB	Phosphate	50	132
20271	M4.2-1.41 (#8)	20mm (25/32")		16mm (5/8")	Phillips Pan Head Sems	AB	Phosphate	50	132
20476	M4.2-1.41 (#8)	20mm (25/32")	7mm	17mm (11/16")	Hex Washer Head Sems	Teks	Phosphate	50	132

(Continued on next page)

Auveco Part No.	Size	Length	Hex Size	Washer/ Head O.D.	Type	Point Type	Finish	Unit Pkg.	Page No.
19278	M4.2-1.41 (#8)	20mm (25/32")	7mm	20mm (25/32")	Hex Head Sems	AB	Black Phos.	50	132
15775	M4.2-1.41 (#8)	20mm (25/32")	7mm	12mm (15/32")	Hex Head Sems	Teks®	Phosphate	50	133
22070	M4.2-1.41 (#8)	20mm (25/32")		17mm (11/16")	Torx® Pan Head Sems®	Dog Pt	Black Zinc	50	133
22104	M4.2-1.41 (#8)	22mm (1")	5.5mm	16mm (7/16")	Hex Head Sems	AB	Black Zinc	50	133
14053	M4.2-1.41 (#8)	25mm (1")		7mm (9/32")	Torx Oval Head	AB	Black Oxide	50	130
19006	M4.2-1.41 (#8)	25mm (1")		11mm (7/16")	Round Washer Head, Pozi-Drive	Teks	Phosphate	100	133
20382	M4.2-1.41 (#8)	25mm (1")	T-15 Drive	12mm (15/32")	Torx Pan Head Sems	AB	Black Zinc	50	133
22081	M4.2-1.41 (#8)	25mm (1-3/16")		17mm (11/16")	Pozi-Drive Round Washer Head Sems	AB	Black Zinc	50	133
18336	M4.2-1.41 (#8)	25mm (1")	7mm	12mm (15/32")	Hex Head Sems	AB	Black Phos	100	133
19653	M4.2-1.41 (#8)	30mm (1-3/16")	7mm	17mm (11/16")	Hex Head Sems	AB	Black Phos	15	133
18340	M4.8-1.61 (#10)	15mm (19/32")		14mm (9/16")	Phillips Truss Head	AB	Black Phos	50	133
17459	M4.8-1.61 (#10)	16mm (5/8")		11mm (7/16")	Phillips Truss Head	AB	Black Oxide	100	133
22030	M4.8-1.61 (#10)	16mm (5/8")	8mm	18mm	Hex Head Sems	AB	Black Zinc	50	133
22110	M4.8-1.61 (#10)	18mm	T-25 Drive	15mm	Torx Truss Head	AB	Black Zinc	25	133
21774	M4.8-1.61 (#10)	20mm (25/32")	8mm	26mm	Hex Head Sems	AB	Black E-Coat	25	134
20259	M4.8-1.61 (#10)	19mm (3/4")		16mm (5/8")	Phillips Truss Head Sems	AB	Black E Coat	25	134
16589	M4.8-1.61 (#10)	19mm (3/4")	8mm	15mm (19/32")	Hex Head Sems	AB	Zinc & Yellow Dichromate	50	134
21865	M4.8-1.61 (#10)	32mm (1-1/4")	8mm	19mm (3/4")	Hex Head Sems	AB	Phosphate	50	134
21746	M5-1.59	11mm		11mm	Phillips Truss Head	AB	Black Oxide	50	134
21747	M5-1.59	11mm		12mm	Phillips Round Washer Head	AB	Black Oxide	50	134
19251	M5-1.59	16mm	8mm	16mm	Phillips Hex Head Sems	A	Black Zinc	50	134
22294	M5-1.81	16mm	8mm	16mm	Phillips Hex Head Sems	B	Black Phos.	25	134
22203	M5-1.81	20mm		13mm	Phillips Flat Head	AB	Black Phos.	100	134
21841	M5.2-2.0 (#12)	20mm (25/32")	8mm	12mm (1/2")	Phillips Hex Head Sems®	AB	Black E-Coat	25	134
21839	M5.2-2.0 (#12)	21mm (13/16")	10mm	14mm (9/16")	Phillips Hex Head Sems	AB	Zinc	25	134
22111	M5-2.12 (#12)	19mm (3/4")	T-25 Drive	14mm	Torx Truss Head	AB	Black Zinc	25	134
20455	M5 (#12)	20mm (25/32")		14mm (9/16")	Phillips Truss Head	AB	Black Phos	50	135
21541	M5.5 (#12)	20mm (25/32")	T-20 Drive	15mm (19/32")	Torx® Truss Head	AB	Black Zinc	25	135
22292	M5.5-1.81 (#12)	16mm (5/8")		13mm (33/64")	Phillips Truss Head		Black Phos.	25	135
17461	M5.5-1.81 (#12)	18mm (45/64")	8mm	15mm (19/32")	Hex Head Sems	AB	Zinc & Yellow Dichromate	50	135
21744	M6-1.81	20mm	10mm	13mm	Phillips Hex Head Sems	AB	Black E-Coat	25	135

(Continued on next page)

Auveco Part No.	Size	Length	Hex Size	Washer/ Head O.D.	Type	Point Type	Finish	Unit Pkg.	Page No.
19170	M6.3-1.81 (#14)	16mm (5/8")		15mm (19/32")	Phillips Truss Head	AB	Black Phos.	50	135
15776	M6.3-1.81 (#14)	16mm (5/8")	8mm	16mm (5/8")	Hex Head Sems	AB	Phosphate	50	135
12057	M6.3-1.81 (#14)	16mm (5/8")	10mm	17mm (11/16")	Hex Head Sems	AB	Phosphate	50	135
22106	M6.3-2.5	18mm	10mm	14mm	Phillips Hex Head Sems	AB	Zinc	25	136
15962	M6.3-1.81 (#14)	18mm (23/32")	10mm	22mm (7/8")	Hex Head Sems	AB	Zinc & Yellow Dichromate	25	135
13019	M6.3-1.81 (#14)	19mm (3/4")	8mm	11.5mm (29/64")	Hex Washer Head	AB	Phosphate	50	135
20556	M6.3-1.81 (#14)	20mm (25/32")	10mm	16mm (5/8")	Phillips Hex Head Sems	AB	Black Zinc	50	135
12351	M6.3-1.81 (#14)	20mm (25/32")	10mm	17mm (11/16")	Hex Washer Head Sems	AB	Black Phos.	50	136
16828	M6.3-1.81 (#14)	20mm (25/32")	10mm	18mm (45/64")	Hex Head Sems	AB	Zinc & Yellow Dichromate	25	136
20557	M6.3-1.81 (#14)	20mm (25/32")	10mm	20mm (25/32")	Phillips Hex Head Sems	AB	Black Zinc	50	136
21838	M6.3-2.5 (#14)	24mm (15/16")	10mm	16mm (5/8")	Phillips Hex Head Sems	AB	Zinc	25	136
12339	M6.3-1.81 (#14)	25mm (1")	10mm	17mm (11/16")	Hex Head Sems	AB	Phosphate	50	136
12354	M6.3-1.81 (#14)	30mm (1-3/16")	10mm	17mm (11/16")	Hex Head Sems	AB	Phosphate	50	136
12068	M6.3-1.81 (#14)	30mm (1-3/16")	10mm	24mm (15/16")	Hex Head Sems	AB	Phosphate	50	136
22295	M6.5-1.81	18mm		16mm	Phillips Truss Head		Black Phos.	25	136
22296	M6.5-1.81	25mm		16mm	Phillips Truss Head		Black Phos.	25	136
21837	M6.5-2.5	19mm	10mm	20mm	Phillips Hex Head Sems	AB	Black E-Coat	25	136
19417	M7.5	35mm (1-3/8")	#3 Sq. Drive	22mm (7/8")	Nylon Square Drive Truss Head	AB	Black Nylon	15	137
12350	M8-2.12 (5/16"-12)	20mm (25/32")	13mm	16mm (5/8")	Hex Washer Head	AB	Phosphate	25	137
21517	M9.5	46mm (1-13/16")	#3 Sq. Drive	22mm (7/8")	Nylon Square Drive Truss Head	AB	Black Nylon	25	137
20970	M14	34mm (1-11/32")	#3 Sq. Drive	22mm (7/8")	Nylon Square Drive Truss Head	AB	Black Nylon	25	137

Metric Torx® Head Tapping Screws



300 Series Stainless Steel

Auveco Part No.	Size	Head Style	GM Number	Finish	Unit Pkg.
14053	M4.2-1.41 x 25mm	M7 Oval	11505182	Black Ox	50



**Metric Torx® Insert Bits
for Torx Screws
1" Shank**

Auveco Part No.	Bit Size	For Screw Size	Unit Pkg.
12472	T-10	No. 4	1
11949	T-15	No. 6, M4.2	1
11950	T-20	No. 8, M4.2	1
12103	T-25	No. 10	1
14913	T-27	No. 12, 1/4"	1
12104	T-30	1/4", M6	1
12105	T-40	5/16", M8	1
14916*	T-55	1/2", 9/16", 5/8"	1

* 1/4" Shank



12062
(11501903)
Black Oxide

M4.2-1.41 x 10mm (#8 x 13/32")
Phillips Washer Head
Pozi-Drive
Washer Head Outer Diameter: 11mm (7/16")
GM

UNIT PACKAGE: 100



15941
Black Oxide

M4.2-1.41 x 12mm (#8 x 15/32")
Phillips Truss Head
Head Diameter: 9.5mm (3/8")
Japanese Imports

UNIT PACKAGE: 10

16596

Same as 15941 except for unit package quantity

UNIT PACKAGE: 100



12059
(11501883)
Zinc

M4.2-1.41 x 13mm (#8 x 33/64")
Phillips Washer Head
Pozi-Drive
Washer Head Outer Diameter: 11mm (7/16")
GM

UNIT PACKAGE: 100



12061
(11501896)
Black Oxide

M4.2-1.41 x 13mm (#8 x 33/64")
Phillips Round Washer Head
Pozi-Drive
Washer Head Outer Diameter: 8.5mm (11/32")
GM

UNIT PACKAGE: 100



12739
(11501794)
Chrome

M4.2-1.41 x 12mm (#8 x 15/32")
Phillips Washer Head
Pozi-Drive
Washer Head Outer Diameter: 10mm (25/64")
GM

UNIT PACKAGE: 100



13712
(11505104)
Black Zinc

M4.2-1.41 x 13mm (#8 x 33/64")
Phillips Washer Head
Washer Head Outer Diameter: 11mm (7/16")
GM

UNIT PACKAGE: 50



12740
(11503394)
Phosphate

M4.2-1.41 x 13mm (#8 x 33/64")
Hex Head Sems®
Washer Outer Diameter: 12mm (15/32")
Hex: 7mm
GM

UNIT PACKAGE: 100



15721
(11504010)
Phosphate

M4.2-1.41 x 13mm (#8 x 19/32")
Indented Hex Head Sems®
Washer Outer Diameter: 16mm (5/8")
Hex: 7mm
GM

UNIT PACKAGE: 50



21122
Chrome

M4.2-1.41 x 14mm (#8 x 9/16")
Phillips Pozi Drive
Washer Head TekS®
Washer Head Outer Diameter: 11mm (7/16")

UNIT PACKAGE: 50



18781
(11515566)
Phosphate

M4.2-1.41 x 14mm (#8 x 9/16")
Hex Head Sems®
Washer Outer Diameter: 8mm (5/16")
Hex: 7mm
GM

UNIT PACKAGE: 50

METRIC ITEMS

Sec. 7



18817
(1746408)
Black Zinc

M4.2-1.41 x 16mm (#8 x 41/64")
Phillips Round Washer Head with
Serrations under the Head
Pozi-Drive with Teks® Point
Washer Head Outer Diameter: 11mm (7/16")
Moulding, Trim & General Purpose
GM

UNIT PACKAGE: 100



16720
Black Oxide

M4.2-1.41 x 16mm (#8 x 5/8")
Phillips Truss Head
Head Diameter: 9.5mm (3/8")
Honda

UNIT PACKAGE: 100



12741
(11503395)
Phosphate

M4.2-1.41 x 16mm (#8 x 5/8")
Hex Head Sems®
Washer Outer Diameter: 12mm (15/32")
Hex: 7mm
GM

UNIT PACKAGE: 100



18261
(11503578, 11503785)
Phosphate

M4.2-1.41 x 16mm (#8 x 5/8")
Hex Washer Head Sems® with Teks® Point
Washer Outer Diameter: 12mm (1/2")
Hex: 7mm
GM

UNIT PACKAGE: 50

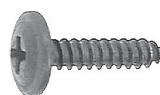

12060
(11501884)
Black Oxide

M4.2-1.41 x 20mm (#8 x 25/32")
Phillips Washer Head
Washer Head Outer Diameter: 11mm (7/16")
GM

UNIT PACKAGE: 100



12097
(9420052, 11502483, 11503503)
Chrome

M4.2-1.41 x 20mm (#8 x 25/32")
Phillips Pan Head Sems®
Pozi-Drive
Washer Outer Diameter: 12mm (1/2")
GM

UNIT PACKAGE: 50



12738
(11504056, 11513801)
Phosphate

M4.2-1.41 x 20mm (#8 x 25/32")
Hex Washer Head Sems®
Washer Outer Diameter: 12mm (1/2")
Hex: 7mm
Radiator & Grille
GM

UNIT PACKAGE: 50



12742
(11503396, 11503483)
Phosphate

M4.2-1.41 x 20mm (#8 x 25/32")
Hex Head Sems®
Washer Outer Diameter: 12mm (1/2")
Hex: 7mm
Front End & Air Conditioner
GM

UNIT PACKAGE: 100



15373
(11503892, 11500434)
Phosphate

M4.2-1.41 x 20mm (#8 x 25/32")
Hex Head Sems®
Washer Outer Diameter: 16mm (5/8")
Hex: 7mm
GM

UNIT PACKAGE: 50



20271
(N801603-S2)
Phosphate

M4.2-1.41 x 20mm (#8 x 25/32")
Phillips Pan Head Sems®
Washer Outer Diameter: 16mm (5/8")
Ford

UNIT PACKAGE: 50



20476
Phosphate

M4.2-1.41 x 20mm (#8 x 25/32")
Hex Washer Head Sems® Teks®
Washer Outer Diameter: 17mm (11/16")
Hex: 7mm
General Purpose

UNIT PACKAGE: 50



19278
(GM: 14090382; Chry: 6506161-AA)
Black Phosphate

M4.2-1.41 x 20mm (#8 x 25/32")
Hex Head Sems®
Washer Outer Diameter: 20mm
Hex: 7mm
GM

UNIT PACKAGE: 50



15775
Phosphate

M4.2-1.41 x 20mm (#8 x 25/32")
Hex Head Sems® with Teks® Point
Washer Outer Diameter: 12mm (1/2")
Hex: 7mm

UNIT PACKAGE: 50



22070
(GM: 11570637)
Black Zinc

M4.2-1.41 x 20mm (#8 x 25/32")
Torx® Pan Head Sems®
Tapping Screw with Dog Point
T15 Drive
Washer Outer Diameter: 17mm (11/16")
GM 2007 - On

UNIT PACKAGE: 50



22104
(Ford: N801169-S900)
Black Zinc

M4.2-1.41 x 22mm
Hex Head Sems® Tapping Screw
Hex Size: 5.5mm
Washer Diameter: 16mm
Front Bumper, Exterior Trim & Front Fender
Ford & Lincoln 2010 - 1997

UNIT PACKAGE: 50



19006
Phosphate

M4.2-1.41 x 25mm (#8 x 1")
Round Washer Head
Pozi-Drive with Teks® Point
Washer Head Outer Diameter: 11mm (7/16")
General Purpose

UNIT PACKAGE: 100



20382
(Not Available from O.E.M.)
Black Zinc

M4.2-1.41 x 25mm (#8 x 1")
Torx® Pan Head Sems®
T-15 Drive
Washer Outer Diameter: 12mm (1/2")

UNIT PACKAGE: 50



22081
(GM: 11609762)
Black Zinc

M4.2-1.41 x 25mm
Pozi-Drive Round Washer
Head Sems® Tapping Screw
Washer Diameter: 17mm
Chevrolet Equinox, GMC Acadia & Terrain
and Saturn Outlook 2007 - On

UNIT PACKAGE: 50



18336
Black Phosphate

M4.2-1.41 x 25mm (#8 x 1")
Hex Head Sems®
Washer Outer Diameter: 12mm (1/2")
Hex: 7mm

UNIT PACKAGE: 100



19653
(N811534-S61)
Black Phosphate

M4.2-1.41 x 30mm (#8 x 1-3/16")
Hex Head Sems®
Washer Outer Diameter: 17mm (11/16")
Hex: 7mm
Ford

UNIT PACKAGE: 15



18340
Black Phosphate

M4.8-1.61 x 15mm (#10 x 19/32")
Phillips Truss Head
Head Outer Diameter: 14mm (9/16")
Nissan Bumpers

UNIT PACKAGE: 50



17459
Black Oxide

M4.8-1.61 x 16mm (#10 x 5/8")
Phillips Truss Head
Head Diameter: 11mm (7/16")
Imports

UNIT PACKAGE: 100



22030
(BMW: 07-14-7-129-160)
Black Zinc

M4.8-1.61 x 16mm (#10 x 5/8")
Hex Head Sems®
Washer Outer Diameter: 18mm
Hex: 8mm
BMW 2013 - 1999

UNIT PACKAGE: 50



22110
(VW: N90775801,
BMW: 07146963883)
Black Zinc

M4.8-1.61 x 18mm
Torx® Truss Head Tapping Screw
T25 Drive
Head Diameter: 15mm
Audi & VW 1998 - On
BMW 5, 6 & 7 Series 2011 - 00

UNIT PACKAGE: 25



20259
 (90114-SZ3-000, 90114-SE0-000)
 Black E-Coat
 M4.8-1.61 x 19mm (#10 x 3/4")
 Phillips Truss Head Sems®
 Washer Outer Diameter: 16mm (5/8")
 Splash Shield & General Purpose
 Honda 1986 - On

UNIT PACKAGE: 25

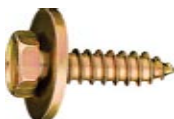

16589
 Zinc & Yellow Dichromate
 #10 x 3/4 (19mm)
 Indented Hex Head Sems®
 Washer Outer Diameter: 19/32"
 Hex: 5/16" (8mm)
 Honda, Nissan, Toyota

UNIT PACKAGE: 50



21774
 (Mercedes-Benz: 201-990-05-36)
 Black E-Coat
 M4.8-1.61 x 20mm (#10 x 25/32")
 Hex Head Sems®
 Washer Outer Diameter: 26mm
 Hex: 8mm
 Front Bumper & Moulding Strip
 Mercedes-Benz 2014 - 1993

UNIT PACKAGE: 25



21865
 (Chrysler: 6509539-AA)
 Phosphate
 M4.8-1.61 x 32mm (#10 x 1-1/4")
 Hex Head Sems® Tapping Screw
 Washer Outer Diameter: 19mm (3/4")
 Hex: 8mm
 Chrysler Town & Country
 and Dodge Ram 2014 - 09

UNIT PACKAGE: 50



21746
 (Mitsubishi: MF453091)
 Black Oxide
 M5-1.59 x 11mm
 Phillips Truss Head
 Head Outer Diameter: 11mm
 Interior Trim
 Mitsubishi Galant 2008 - 2004

UNIT PACKAGE: 50



21747
 Black Oxide
 M5-1.59 x 11mm
 Phillips Round Washer Head
 Washer Head Outer Diameter: 12mm
 Chrysler & Imports

UNIT PACKAGE: 50



19251
 Black Zinc
 M5-1.59 x 16mm
 Phillips Hex Head Sems®
 Washer Outer Diameter: 16mm
 Hex: 8mm

UNIT PACKAGE: 50



22294
 (Mazda: 9CF600516B)
 Black Phosphate
 M5-1.81 x 16mm
 Phillips Hex Head Sems®
 Washer Outer Diameter: 16mm
 Hex: 8mm
 Mazda 2, 3, 5, 6, 626, 929, CX-5, CX-7, CX-9, Miata,
 Millenia, MPV, Mx-3, Protégé, RX-7 & RX-8 2014 - 1992

UNIT PACKAGE: 25



22203
 (Honda: 90103-SDA-A00)
 Black Phosphate
 M5-1.81 x 20mm
 Phillips Flat Head
 Head Diameter: 13mm
 Front & Rear Bumper
 Honda Civic, Pilot & Ridgeline 2006 - On

UNIT PACKAGE: 100



21841
 (Toyota: 75392-42030)
 Black E-Coat
 M5.2-2.0 x 20mm (#12 x 25/32")
 Phillips Hex Head Sems®
 Washer Outer Diameter: 12mm (1/2")
 Hex: 8mm
 Front Bumper Moulding
 Toyota & Lexus 2010 - On

UNIT PACKAGE: 25



21839
 (Toyota: 90159-A0001;
 90159-50316)
 Zinc
 M5.2-2.0 x 21mm (#12 x 13/16")
 Phillips Hex Head Sems®
 Washer Outer Diameter: 14mm (9/16")
 Hex: 10mm
 Front Bumper, Bumper Stay & Radiator Grille
 Toyota & Lexus 2000 - On

UNIT PACKAGE: 25



22111
 (VW: N90892001, N90775001)
 Black Zinc
 M5-2.12 x 19mm (#12 x 3/4")
 Torx® Truss Head Tapping Screw
 T25 Drive
 Head Diameter: 14mm
 Audi, Porsche & VW 2014 - 07

UNIT PACKAGE: 25



20455

Black Phosphate

M5-2.12 x 20mm (#12 x 25/32")
Phillips Truss Head
Head Outer Diameter: 14mm
Imports

UNIT PACKAGE: 50



19170

Black Phosphate

M6.3-1.81 x 16mm (#14 x 5/8")
Phillips Truss Head
Head Outer Diameter: 15mm (19/32")
Japanese Imports

UNIT PACKAGE: 50



22292

(Nissan: 01454-N5061)
Black Phosphate

M5.5-1.81 x 16mm (#12 x 5/8")
Phillips Truss Head
Head Outer Diameter: 13mm
Fender Liner
Nissan Cube, Murano, Pathfinder, Quest,
Rogue, Sentra & Versa 2014 - On

UNIT PACKAGE: 25



15776

(N800312-S2)
Phosphate

M6.3-1.81 x 16mm (#14 x 5/8")
Hex Head Sems®
Washer Outer Diameter: 16mm (5/8")
Hex: 8mm
Ford

UNIT PACKAGE: 50



17461

Zinc & Yellow Dichromate

M5.5-1.81 x 18mm (#12 x 45/64")
Hex Head Sems®
Washer Outer Diameter: 15mm (19/32")
Hex: 8mm
Imports

UNIT PACKAGE: 50



12057

(11500994)
Phosphate

M6.3-1.81 x 16mm (#14 x 5/8")
Hex Head Sems®
Washer Outer Diameter: 17mm (11/16")
Hex: 10mm
GM

UNIT PACKAGE: 50



21541

(13144822)
Black Zinc

M5.5 x 20mm (#12 x 25/32")
Torx® Truss Head
T-20 Drive
Head Outer Diameter: 15mm (19/32")

Use with Auveco 21540

GM 2011 - On
Saab 2003 - On

UNIT PACKAGE: 25



15962

Zinc & Yellow Dichromate

M6.3-1.81 x 18mm (#14 x 23/32")
Hex Head Sems®
Washer Outer Diameter: 22mm (7/8")
Hex: 10mm
Honda, Nissan, Toyota

UNIT PACKAGE: 25



13019

(N610959-S2)
Phosphate

M6.3-1.81 x 19mm (#14 x 3/4")
Hex Washer Head
Washer Outer Diameter: 11.5mm (29/64")
Hex: 8mm
Ford

UNIT PACKAGE: 50



21744

(Mitsubishi: MS452348)
Black E-Coat

M6-1.81 x 20mm
Phillips Hex Head Sems®
Washer Outer Diameter: 13mm (1/2")
Hex: 10mm
Bumper, Exterior Trim,
Fender Shield and Quarter Panel
Mitsubishi Diamante, Eclipse, Galant, Lancer,
Mirage, Montero & 3000GT 2012 - 1991

UNIT PACKAGE: 25



20556

Black Zinc

M6.3-1.81 x 20mm (#14 x 25/32")
Phillips Hex Head Sems®
Washer Outer Diameter: 16mm (5/8")
Hex: 10mm
Imports

UNIT PACKAGE: 50

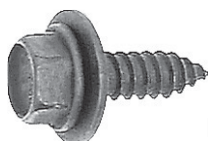

12351
(11505022)
Black Phosphate
M6.3-1.81 x 20mm (#14 x 25/32")
Hex Washer Head Sems®
Washer Outer Diameter: 17mm (11/16")
Hex: 10mm
GM

UNIT PACKAGE: 50



16828
Zinc & Yellow Dichromate
M6.3-1.81 x 20mm (#14 x 25/32")
Hex Head Sems®
Washer Outer Diameter: 18mm (45/64")
Hex: 10mm
Honda, Nissan, & Toyota

UNIT PACKAGE: 25



20557
Black Zinc
M6.3-1.81 x 20mm (#14 x 25/32")
Phillips Hex Head Sems®
Washer Outer Diameter: 20mm (25/32")
Hex: 10mm
Imports

UNIT PACKAGE: 50



12339
(11500996, 11505023)
Phosphate
M6.3-1.81 x 25mm (#14 x 1")
Hex Head Sems®
Washer Outer Diameter: 17mm (21/32")
Hex: 10mm
GM

UNIT PACKAGE: 50



12354
(11500997)
Phosphate
M6.3-1.81 x 30mm (#14 x 1-3/16")
Hex Head Sems®
Washer Outer Diameter: 17mm (21/32")
Hex: 10mm
GM

UNIT PACKAGE: 50



12068
(11504981)
Phosphate
M6.3-1.81 x 30mm (#14 x 1-3/16")
Hex Head Sems®
Washer Outer Diameter: 24mm (15/16")
Hex: 10mm
GM

UNIT PACKAGE: 50



22106
(Toyota: 90159-60303)
Zinc
M6.3-2.5 x 18mm
Phillips Hex Head Sems® Tapping Screw
Washer Outer Diameter: 14mm
Hex: 10mm
Toyota & Scion 1993 - On

UNIT PACKAGE: 25



21838
(Toyota: 90159-60488)
Zinc
M6.3-2.5 x 24mm (#14 x 15/16")
Phillips Hex Head Sems®
Washer Outer Diameter: 16mm (5/8")
Hex: 10mm
Front Bumper, Bumper Stay, Hood and Front Fender
Lexus CT200, ES350, HS250, IS & SC430,
Scion and Toyota 1995 - On

UNIT PACKAGE: 25



22295
(Hyundai: 12493-06207B)
Black Phosphate
M6.5-1.81 x 18mm
Phillips Truss Head
Head Outer Diameter: 16mm
Fender Liner
Hyundai Accent, Azera, Elantra, Entourage, Genesis,
I30, Santa Fe, Sonata, Tiburon, Tucson, Veloster &
Veracruz 2013 - 2005

UNIT PACKAGE: 25



22296
(Hyundai: 92155-22000;
11254-06206)
Black Phosphate
M6.5-1.81 x 25mm
Phillips Truss Head
Head Outer Diameter: 16mm
Headlamp Assembly Mounting Screw
Hyundai 2000 - On

UNIT PACKAGE: 25



21837
(Toyota: 90159-60525)
Black E-Coat
M6.5-2.5 x 19mm (#14 x 3/4")
Phillips Hex Head Sems®
Washer Outer Diameter: 20mm (25/32")
Hex: 10mm
Floor Pan & Lower Back Panel Moulding, Rear Bumper
Stay, Suspension Cross Member and Under Cover
Toyota 1998 - On

UNIT PACKAGE: 25

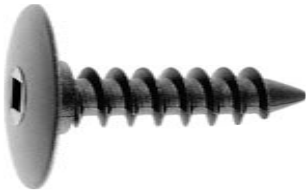

19417
(Chry: 6503819, 6503401;
GM: 25631448)
Black Nylon

M7.5 x 35mm
Square Drive Truss Head
Head Diameter: 22mm
Shoulder Diameter: 9mm
Foam to Bumper Fascia
Chrysler 1993-On
GM 1997 - On

UNIT PACKAGE: 15



12350
(11500086)
Phosphate

M8-2.12 x 20mm (5/16"-12 x 25/32")
Hex Washer Head
Washer Head Outer Diameter: 16mm (5/8")
Hex: 13mm
GM

UNIT PACKAGE: 25

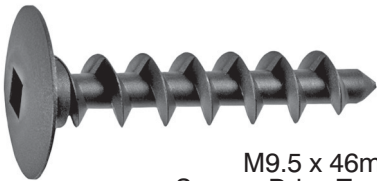

21517
(25705182)
Black Nylon

M9.5 x 46mm
Square Drive Truss Head
Head Diameter: 22mm
GM

UNIT PACKAGE: 25



20970
(Not Available from O.E.M.)
Black Nylon

M14 x 34mm
Bumper and Door
Insulator Nylon Screw
No. 3 Square Drive
Head Outer Diameter: 22mm
Fits into 12mm Hole
GM, Ford & Chrysler 2005 - On

UNIT PACKAGE: 25



16986
(14003784)
Zinc

M8-1.25 x 25mm
Stainless Steel Capped
Pan Head without Nuts
Head Diameter: 19mm
Shoulder Length: 3mm
GM

UNIT PACKAGE: 25



11404
(N14-4003)
Plain

M8-1.25 x 35mm
Class 4.8
Volkswagen Intake Manifold

UNIT PACKAGE: 25



17559
Zinc &
Yellow Dichromate

M10-1.25 x 42mm
Class 8.8
Exhaust Systems
Honda, Nissan & Toyota

UNIT PACKAGE: 10

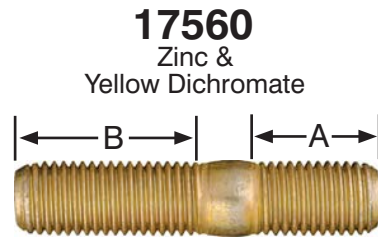

17560
Zinc &
Yellow Dichromate

M10-1.25 x 48mm
Dim. A: 15mm Dim. B: 25mm
Class 8.8
Exhaust Systems
Honda, Nissan & Toyota

UNIT PACKAGE: 10



17596
Zinc &
Yellow Dichromate

M12-1.25 x 50mm
Class 8.8
Catalytic Converter
Mazda

UNIT PACKAGE: 5

METRIC ITEMS

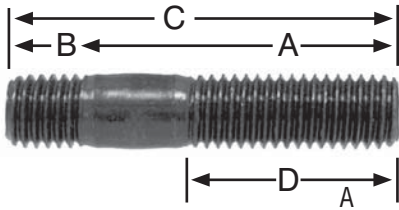

Cylinder Head and Manifold Metric Studs
Grade 8 Medium Carbon Heat Treated Alloy Steel
Regular Pitch

Auveco Part No.	Diameter & Length	B Diameter & Length	C Overall Length	D Length	Unit Pkg.
11973	6mm-1.00 x 20mm	6mm-1.00 x 7.5mm	27.5mm	18mm	10
11974	6mm-1.00 x 25mm	6mm-1.00 x 7.5mm	32.5mm	18mm	10
11980	8mm-1.25 x 20mm	8mm-1.25 x 10mm	30.0mm	16mm	10
11981	8mm-1.25 x 25mm	8mm-1.25 x 10mm	35.0mm	22mm	10
11982	8mm-1.25 x 30mm	8mm-1.25 x 10mm	40.0mm	22mm	10
11983	8mm-1.25 x 35mm	8mm-1.25 x 10mm	45.0mm	22mm	10
11984	8mm-1.25 x 40mm	8mm-1.25 x 10mm	50.0mm	22mm	10
11987	8mm-1.25 x 55mm	8mm-1.25 x 10mm	65.0mm	22mm	10
11989	10mm-1.50 x 30mm	10mm-1.50 x 12mm	42.0mm	18mm	10
11990	10mm-1.50 x 35mm	10mm-1.50 x 12mm	47.0mm	26mm	10
11991	10mm-1.50 x 40mm	10mm-1.50 x 12mm	52.0mm	26mm	10
11993	10mm-1.50 x 50mm	10mm-1.50 x 12mm	62.0mm	26mm	10
11995	10mm-1.50 x 65mm	10mm-1.50 x 12mm	77.0mm	26mm	5
11998	12mm-1.75 x 30mm	12mm-1.75 x 15mm	45.0mm	25mm	5



Regular Pitch Metric Hex Nuts
DIN 934
Class 8 • Steel • Zinc Plated
Tensile Strength: 116,000 Max.

Auveco Part No.	Size	Pitch (mm)	Hex Width	Unit Pkg.
10569	4mm	.70	7mm	25
14448	4mm	.70	7mm	50
10570	5mm	.80	8mm	25
14449	5mm	.80	8mm	50
10571	6mm	1.00	10mm	25
14450	6mm	1.00	10mm	100
10572	7mm	1.00	11mm	25
14451	7mm	1.00	11mm	50
10573	8mm	1.25	13mm	25
14452	8mm	1.25	13mm	100
10575	10mm	1.50	17mm	10
14454	10mm	1.50	17mm	50
10576	12mm	1.75	19mm	10
14455	12mm	1.75	19mm	25
14625	14mm	2.00	22mm	25
14626	16mm	2.00	24mm	25



J.I.S. Small Hex Nuts
J.I.S. B1181 • I.S.O. Class 8
Steel • Heat Treated
Zinc Plated

Auveco Part No.	Size	Pitch (mm)	Hex Width	Unit Pkg.
14796	8mm	1.25	12mm	25
17391	8mm	1.25	12mm	100
14797	10mm	1.25	14mm	15
17392	10mm	1.25	14mm	50
16617	12mm	1.25	17mm	25



Fine Pitch Metric Hex Nuts
DIN 934
Class 8 • Steel • Zinc Plated
Tensile Strength: 116,000 Max.

Auveco Part No.	Size	Pitch (mm)	Hex Width	Unit Pkg.
10574	8mm	1.00	13mm	25
14453	8mm	1.00	13mm	50
11277	10mm	1.00	17mm	10
14456	10mm	1.00	17mm	25
11278	10mm	1.25	17mm	10
14457	10mm	1.25	17mm	25
11279	12mm	1.25	19mm	10
14458	12mm	1.25	19mm	25
11280	12mm	1.50	19mm	10
14459	12mm	1.50	19mm	25
21426	14mm	1.50	22mm	10
14629	16mm	1.50	24mm	25



Metric Nylon Insert Lock Nuts
DIN 985
Heat Treated Alloy Steel
Zinc Plated

Auveco Part No.	Size	Pitch (mm)	Hex Width	Unit Pkg.
11049	4mm	.70	7mm	100
11051	5mm	.80	8mm	100
11053	6mm	1.00	10mm	100
11055	8mm	1.25	13mm	100
11057	10mm	1.50	17mm	100
11059	12mm	1.75	19mm	100



Type A



Type B

Metric Free Spinning Washer Nuts

Auveco Part No.	Thread Size	Type	Washer O.D.	Hex Size	Height	Plating	O.E.M. No.	Unit Pkg.
15325	M4-0.7	B	12mm	9mm	4.5mm	Phosphate	N621900, N800466	50
16883	M5-0.8	B	10mm	8mm	7mm	Zinc & Yellow	N802775-S36	50
15326	M5-0.8	B	15mm	10mm	7mm	Phosphate	N621903	50
15327	M5-0.8	B	19mm	10mm	7mm	Phosphate	11504614	50
19216	M6-1.0	B	14mm	10mm	8mm	Phosphate	6100047	50
12595	M6-1.0	A	16mm	10mm	7mm	Phosphate	11505329, 11503752, N90100001	25
16268	Same as 12595 except for packaging							50
15328	M6-1.0	B	16mm	11mm	8.5mm	Phosphate	N621905	50
16136	M6-1.0	B	18mm	10mm	7mm	Zinc	94515340	25
15329	M6-1.0	B	18mm	10mm	9mm	Phosphate	6100048	50
12596	M6-1.0	A	19mm	11mm	9.5mm	Phosphate	11503754, 11503756	25
15330	M6-1.0	B	19mm	10mm	8mm	Zinc	11508275	50
16774	M6-1.0	B	19mm	11mm	9mm	Zinc & Yellow	N621906-S36	50
15331	M6-1.0	B	20mm	10mm	9mm	Phosphate	6100049	50
15332	M6-1.0	B	24mm	11mm	9mm	Zinc & Yellow	N621907	25
15333	M8-1.25	B	18mm	13mm	10mm	Phosphate	6100050	25
15334	M8-1.25	B	19mm	13mm	10mm	Phosphate	11501800	25
15335	M8-1.25	B	24mm	13mm	10.5mm	Phosphate	11503695, 11506117, N621940	25
15337	M10-1.5	B	24mm	15mm	13mm	Phosphate	N621942	25
21001	M12-1.75	B	28mm	18mm	16mm	Phosphate	N621945-S2	10

Metric Flange Lock Nuts



Auveco Part No.	Thread Size	Flange O.D.	Hex Size	Height	Plating	O.E.M. No.	Unit Pkg.
18251	M6-1.0	14mm	10mm	6mm	Zinc & Yellow		50
15316	M6-1.0	14mm	10mm	7.5mm	Phosphate	N620480	50
11709	M8-1.25	17mm	13mm	8.5mm	Zinc	11502811	50
15318	M10-1.5	20.5mm	15mm	13mm	Phosphate	N620482	25
11708	M10-1.5	21mm	15mm	11.5mm	Zinc	11502812	25
14521	M10-1.5	21mm	15mm	12mm	Phosphate		25
14522	M12-1.75	25mm	18mm	14mm	Phosphate		25
14523	M16-2.0	33mm	24mm	18mm	Phosphate		10



Metric Hex Flange Nuts



Auveco Part No.	Thread Size	Flange O.D.	Hex Size	Height	Plating	O.E.M. No.	Unit Pkg.	
16880	M4-.7	11mm	7mm	5mm	Black Zinc	14031900	50	
17495*	M4-.7	14mm	9mm	6mm	Zinc	N620391-S36	50	
19309	M5-.8	11.5mm	8mm	5mm	Black Oxide		50	
19308	M5-.8	11.5mm	8mm	5mm	Zinc	11502702	50	
19205	M6-1.0	14mm	10mm	6mm	Phosphate	11503745	100	
20450	M6.3-1.81	20mm	11mm	7mm	Zinc Organic	22516030	25	
11644	M8-1.25	17mm	13mm	8mm	Phosphate	11501889	25	
16269	Same as 11644 except for unit package quantity						11502609, 11507036	50
18253	M10-1.25	19mm	14mm	9mm	Zinc & Yellow		50	
11645	M10-1.5	21mm	15mm	10mm	Phosphate	11501850	25	
20606	M12-1.75	25mm	18mm	12mm	Phosphate		25	

*with Sealer



Metric Spin Lock Nuts with Serrations Case Hardened



Auveco Part No.	Thread Size	Flange O.D.	Hex Size	Plating	Unit Pkg.
Standard Flange					
16769	M6-1.0	14mm	10mm	Zinc	50
16830	M8-1.25	17mm	12mm	Zinc	50
16470	M10-1.25	19mm	14mm	Zinc	25
Large Flange					
14855	M6-1.0	17mm	10mm	Phos	100
14856	M8-1.25	19mm	13mm	Phos	100
22045	M10-1.50	20mm	15mm	Zinc	25



Nylon Coated Acorn Nuts

Auveco Part No.	Size	Hex	Height	Unit Pkg.
20570	M4-0.7	10mm	11mm	15



Metric Wing Nuts DIN D00213 Zinc Plated

Auveco Part No.	Thread Size	Unit Pkg.
17010	M6-1.0	25



18531 (6503837) Black

Ziptwist Wing Nut
Fits 6mm Stud
Outer Diameter: 5/8"
UNIT PACKAGE: 50



12254 (11501814) Zinc

Metric Washer Lock Nuts
Thread Size: M5-.8
Flange Diameter: 14mm
Height: 6mm
Hex Size: 10mm
UNIT PACKAGE: 100



Washer Type Metric Self-Threading Nuts



Auveco Part No.	Stud Size	Hex Width	Washer Diameter	Finish	O.E.M. Number	Unit Pkg.
16134*	3mm	8mm	13.5mm	Zinc & Yellow		25
12115	4mm	9mm	15mm	Zinc	11502549	100
12116	5mm	10mm	15mm	Phosphate	11508900	50
12253	5mm	10mm	15mm	Phosphate	11501835, 10062	50
19548	6mm	11mm	15mm	Zinc	6100814	50
16829	6mm	11mm	18mm	Zinc	6100815	100
12117	6.3mm	11mm	18mm	Zinc	11503432	50
12255	6.3mm	11mm	18mm	Zinc	11501836	50
15711	8mm	13mm	20mm	Zinc	11502507, 11509535 11514282	100

*With Sealer



Metric Push-On Retainers
For Non-Threaded Fasteners

Auveco Part No.	Stud Size	Diameter	Finish	Unit Pkg.
12118	3.2mm	9.5mm	Zinc	100
12119	4mm	11mm	Zinc	100

Please order items in unit package quantities and by number of pieces needed



Metric Pushnut Bolt Retainers
For Threaded Fasteners

Auveco Part No.	Thread Size	O.D.	Finish	Unit Pkg.
12122	M5-0.8	11mm	Zinc	100
12123	M6-1.0	13mm	Zinc	100
14980	M6-1.0	17mm	Zinc	100
12124	M6.3-1.0	13mm	Zinc	100
12125	M8-1.25	16mm	Zinc	100
12259	M8-1.25	24mm	Zinc	50
12126	M10-1.50	20mm	Phosphate	50
12260	M10-1.50	24mm	Zinc	100
12127	M12-1.75	21mm	Zinc	50
16980	M14-2.0	25mm	Phosphate	50

TUBULAR TYPE NUTS

(Listed by Stud Size)



13227

(113-853-615A)
Natural Nylon

For 3mm Stud
Fits into 4mm Hole
Overall Length: 10mm

UNIT PACKAGE: 50



16124

(001-988-20-81)
Red Nylon

For 5mm Stud
Fits into 9mm Hole
Overall Length: 14mm

UNIT PACKAGE: 50



20472

(91512-SR3-004)
White Nylon

Tubular Nut with Sealer & Sealed End
For 3mm Stud
Fits into 6mm Hole
Head Diameter: 8.5mm

UNIT PACKAGE: 10



13170

(5131-1-802-258)
Natural Nylon

For 7mm Stud
Fits into 8mm hole
Overall Length: 20mm

UNIT PACKAGE: 50

CAGE NUTS



16142
Zinc

Screw Size: M6-1.0
Panel Range: 1.7mm-2.7mm

UNIT PACKAGE: 25



20651
(001-990-00-91)
Zinc & Yellow

Screw Size: M6-1.0
Panel Range: .5mm - 1.7mm
Center of Hole to Edge: 15mm

UNIT PACKAGE: 10

U & J NUTS BY SCREW SIZE



13221
(0712-9-925-706)
Zinc

Screw Size: 2.9mm
Panel Range: .5mm-1.5mm
Center of Hole to Edge: 6mm

UNIT PACKAGE: 50



20649
Zinc

Screw Size: 3.5mm (#6)
Panel Range: .5mm - 1.5mm
Center of Hole to Edge: 8mm

UNIT PACKAGE: 50



13224
(000-994-04-45)
Zinc

Screw Size: 4.2mm (#8)
Panel Range: .5mm-1.7mm
Center of Hole to Edge: 8mm

UNIT PACKAGE: 50



13223
(BMW: 0712-9-925-708;
Mercedes: 000-994-25-45)
Zinc

Screw Size: 4.2mm (#8)
Panel Range: 3mm-4mm
Center of Hole to Edge: 7mm

UNIT PACKAGE: 50



13225
Zinc

Screw Size: 4.2mm (#8)
Panel Range: .5mm-2.5mm
Center of Hole to Edge: 8mm

UNIT PACKAGE: 50



13216
Zinc

Screw Size: 4.8mm (#10)
Panel Range: .9mm-2mm
Center of Hole to Edge: 8mm

UNIT PACKAGE: 25



20650
(123-994-08-45)
Zinc

Screw Size: 4.2mm (#8)
Panel Range: .5mm-2.5mm
Center of Hole to Edge: 14mm

UNIT PACKAGE: 25



21017
(Nissan: 76882-0M000)
White Nylon

Screw Size: 4.8mm(#10)
Panel Range: Up to 1.5mm
Center of Hole to Edge: 8mm

UNIT PACKAGE: 15



13215
Zinc

Screw Size: 4.8mm(#10)
Panel Range: .8mm-1.7mm
Center of Hole to Edge: 11mm

UNIT PACKAGE: 50



13218
Zinc & Yellow

Screw Size: 4.8mm(#10)
Panel Range: .5mm-1.7mm
Center of Hole to Edge: 7mm

UNIT PACKAGE: 50

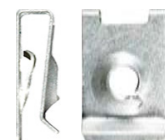

22114
(BMW: 07129904150)
Zinc Finish

U Type Nut
Screw Size: M4.8 (#10)
Panel Range: 2.3mm - 3.5mm (.090"-.138")
Center of Hole to Edge: 8.5mm
BMW 2011 - 1992

UNIT PACKAGE: 25

**METRIC ITEMS
U & J NUTS BY SCREW SIZE**



14750

Black Nylon

Screw Size: 4.8mm (#10)
Panel Range: Up to 1mm
Center of Hole to Edge: 11mm

UNIT PACKAGE: 15

19669

Same as 14750 except for unit package quantity

UNIT PACKAGE: 25



17993

Black Nylon

Screw Size: 4.8mm (#10)
Panel Range: Up to 3mm
Center of Hole to Edge: 14mm

UNIT PACKAGE: 10



19735

(Nissan: 63848-35F00)
Black Nylon

Screw Size: 4.8mm (#10)
Panel Range: Up to 2mm
Center of Hole to Edge: 8mm

UNIT PACKAGE: 15



21359

(Toyota: 53879-17020)
Black Nylon

Screw Size: M4.8 (#10)
Panel Range: Up to 2mm
Center of Hole to Edge: 10mm

UNIT PACKAGE: 10



21616

(Toyota: 76647-42010)
Black Nylon

Screw Size: M4.8 (#10)
Panel Range: Up to 2mm
Center of Hole to Edge: 7mm

UNIT PACKAGE: 15



21540

(GM: 24449408)
Orange Nylon

Screw Size: M5.5 (#12)
Panel Range: Up to 2mm (5/64")
Center of Hole to Edge: 12mm (15/32")

Use with Auveco 21541

UNIT PACKAGE: 25



21613

(Toyota: 53879-20020)
Black Nylon

Screw Size: M5.5 (#12)
Panel Range: Up to 2mm
Center of Hole to Edge: 11mm

UNIT PACKAGE: 15



13162

Zinc

Screw Size: 5.6mm
Panel Range: 1.2mm-2.0mm
Center of Hole to Edge: 10mm

UNIT PACKAGE: 50



17193

(Nissan: 01241-00551, 63848-D0100)
Nylon

Screw Size: 5.6mm (#12)
Panel Range: Up to 1mm
Center of Hole to Edge: 9mm

UNIT PACKAGE: 15

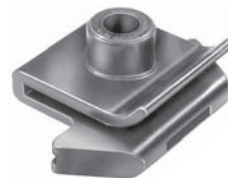

17385

(Nissan: 63848-D4000)
Black Nylon

Screw Size: 5.6mm (#12)
Panel Range: Up to 2mm
Center of Hole to Edge: 9mm

UNIT PACKAGE: 10



20956

(Toyota: 90467-05114)
Black Nylon

Screw Size: 5.5mm (#12)
Panel Range: Up to 1mm
Center of Hole to Edge: 14mm

UNIT PACKAGE: 10

METRIC ITEMS U & J NUTS BY SCREW SIZE

Sec. 7



21614

(Toyota: 90467-05128)
White Nylon

Screw Size: M6 (#14)
Panel Range: Up to 2mm
Center of Hole to Edge: 12mm

UNIT PACKAGE: 15



21378

(Hyundai: 86825-28000)
Black Nylon

Screw Size: M6 (#14)
Panel Range: Up to 1.5mm
Center of Hole to Edge: 8mm

UNIT PACKAGE: 25



21615

(Toyota: 90467-A0018,
90467-05081)
Maroon Nylon

Screw Size: M6 (#14)
Panel Range: Up to 2mm
Center of Hole to Edge: 12mm

UNIT PACKAGE: 15



13220

(Mercedes: 000-994-09-14;
Volvo: 946-418; Opel: 20-72-175)
Zinc & Yellow

Screw Size: 6.5mm (#14)
Panel Range: .7mm-1.5mm
Center of Hole to Edge: 13mm

UNIT PACKAGE: 50

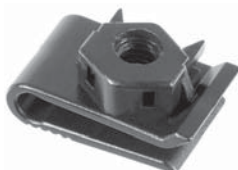

21459

(Nissan: 01241-00881)
Black Nylon with Captive Metal

Hex Nut
Thread: M6 - 1.0
Panel Range: Up to 4mm
Center of Hole to Edge: 14mm

UNIT PACKAGE: 10



14276

(Toyota: 53879-22010)
Black Nylon

Screw Size: 6.3mm (#14)
Panel Range: Up to 1mm
Center of Hole to Edge: 15mm

UNIT PACKAGE: 15

LOOKING FOR OIL DRAIN PLUGS?

Flip over to pages 275-282 to find all of Auveco's Oil Drain Plugs

You can also find all oil drain plugs at www.auveco.com

With our new site plugs can be found by part or OEM number, car make or within the oil drain plug section. You will also be able to search by color, size and other item attributes.



Metric Extruded U-Nuts
Fold Over Nuts

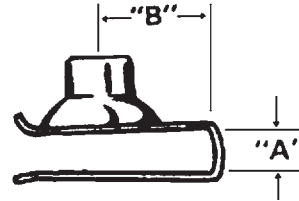

Auveco Part No.	Thread Size	"A" Panel Range		"B" Foldover Clear		Finish	O.E.M. No.	Unit Pkg.
		mm	Inches	mm	Inches			
18337	M4-7	0.60-3.80	1/32-5/32	9.5	3/8	Zinc Organic	11500654, N623330-S2	50
11625	M4-7	0.80-4.00	1/32-5/32	13.5	17/32	Phosphate	11500655	50
20339	M4.2-1.41*	0.50-2.00	1/32-5/64	10	25/64	Zinc Organic	11516397	50
21040	M4.2-1.41*	0.65-3.80	1/32-5/32	9.5	3/8	Zinc Organic	11513599	25
22074	M 4.2-1.41*	0.65-3.80	1/32-5/32	15		Zinc Organic	11515638	25
22113	M5-8	0.45-1.5	1/64-1/16	11.5		Zinc Finish	51127070202, N90168602	25
18338	M5-8	0.60-3.80	1/32-5/32	11	7/16	Phosphate	11505596, N623331-S2	50
11626	M5-8	0.80-4.00	1/32-5/32	15.8	5/8	Phosphate	11500657	50
16846	M6-1.0*	0.80-4.00	1/32-5/32	12	15/32	Phosphate	6502152	50
16842	M6-1.0	3.40-6.30	9/64-1/4	13.5	17/32	Phosphate	11504047, N802331-S53	25
18449	M6-1.0*	0.80-4.00	1/32-5/32	13.5	17/32	Phosphate	6101308	50
11864	M6-1.0	0.80-4.00	1/32-5/32	13.5	17/32	Phosphate	11503714, 11503716	50
12669	M6-1.0	0.80-4.00	1/32-5/32	13.5	17/32	Phosphate	1016937, 12337917, 11503957, N623332-S2, -S53 & S-100 W520822-S426	25
22105	M6-1.0	2.00-4.00	5/64-5/32	14.5	9/16	Zinc	90675-SA5-003	25
12666	M6-1.0	3.40-6.30	9/64-1/4	14.5	9/16	Zinc Organic	11504978	25
20416	M6-1.0	2.00-5.00	5/64-3/16	14.5	9/16	Zinc Organic	11516372	25
12575	M6-1.0	0.80-4.00	1/32-5/32	19.5	25/32	Phosphate	11503715	25
16322	M6-1.0	1.00-2.50	3/64-3/32	19.5	25/32	Phosphate	14040999	50
19480	M6-1.0	4.30-5.60	11/64-7/32	21.0	13/16	Phosphate	N805889-S100	15
11627	M6.3-1.0	0.80-4.00	1/32-5/32	13.5	17/32	Phosphate	11502785	25
11628	M6.3-1.0	0.80-4.00	1/32-5/32	13.5	17/32	Phosphate	11500658	25
12667	M8-1.25	1.50-5.50	1/16-7/32	14.5	9/16	Zinc Organic	11503455, 11504288	25
11629	M8-1.25	0.80-4.00	1/32-5/32	14.5	9/16	Phosphate	11500660, 11502617, N623333-S2	25
11630	M8-1.25	0.80-4.50	1/32-11/64	20	13/16	Phosphate	11500661, 11503317, N623343-S2	25
19644	M8-1.25	1.70-5.50	1/16-7/32	28.5	1-1/8	Phosphate	10084751	15
18401	M8-1.25*	4.00-7.00	5/32-9/32	21	13/16	Black Phosphate	N801117-S10	25
11631	M10-1.50	1.00-6.00	3/64-15/64	19	3/4	Phosphate	11500662	25
18339	M10-1.50	1.50-5.50	1/16-7/32	28	1-3/32	Zinc Organic	11500663, N623344-S2	25

*Locking Feature



Metric Flat Washers DIN 125



Auveco Part No.	Screw Size	Inner Diameter	Outer Diameter	Thickness	Finish	Unit Pkg.
10577	4mm	4.3mm	9mm	0.8mm	Zinc	50
10578	5mm	5.3mm	11mm	1mm	Zinc	50
10579	6mm	6.4mm	12mm	1.5mm	Zinc	50
17393	6mm	6.4mm	12mm	1.5mm	Zinc	100
16763	6mm	6.4mm	12mm	1.5mm	Zinc	100
10580	7mm	7.4mm	14mm	1.5mm	Zinc	50
10581	8mm	8.4mm	15.8mm	2mm	Zinc	25
17394	8mm	8.4mm	15.8mm	2mm	Zinc	100
16764	8mm	8.4mm	15.8mm	1.5mm	Zinc & Yellow	100
10582	10mm	10.5mm	21mm	2mm	Zinc	25
17395	10mm	10.5mm	21mm	2mm	Zinc	100
10583	12mm	13mm	24mm	2.5mm	Zinc	25
14632	14mm	15mm	28mm	2.5mm	Zinc	50
14633	16mm	17mm	30mm	3mm	Zinc	50
14634	20mm	21mm	37mm	3mm	Zinc	50



Metric Lock Washers DIN 127 Spring Steel • Zinc Plated

Auveco Part No.	Screw Size	I.D.	O.D.	Thick-ness	Unit Pkg.
10584	4mm	4.1mm	7.4mm	0.9mm	50
10585	5mm	5.1mm	9.0mm	1.2mm	50
10586	6mm	6.1mm	11.5mm	1.6mm	50
17396	6mm	6.1mm	11.5mm	1.6mm	100
10587	7mm	7.1mm	12.2mm	1.6mm	50
10588	8mm	8.2mm	14.4mm	2mm	50
17397	8mm	8.2mm	14.4mm	2mm	100
10589	10mm	10.2mm	17.5mm	2.2mm	50
17398	10mm	10.2mm	17.5mm	2.2mm	100
10590	12mm	12.2mm	20.3mm	2.5mm	25
14636	16mm	16.2mm	27.4mm	3.5mm	50
14637	20mm	20.2mm	33.6mm	4mm	50



Metric Spring Washers DIN 137 Spring Steel • Zinc Plated

Auveco Part No.	Screw Size	I.D.	O.D.	Thick-ness	Unit Pkg.
10591	4mm	4.3mm	8mm	0.5mm	50
10592	5mm	5.3mm	10mm	0.5mm	50
10593	6mm	6.4mm	11mm	0.5mm	50
10595	8mm	8.4mm	15mm	0.8mm	50
10596	10mm	10.5mm	18mm	1.0mm	25



Metric Copper Washers DIN 7603

Auveco Part No.	Screw Size	Inner Diameter	Outer Diameter	Thickness	Unit Pkg.
14866	8mm	8.2mm	11.8mm	0.8mm	50
14867	10mm	10.2mm	15.8mm	0.8mm	50
14868	12mm	12.2mm	17.8mm	1.4mm	25
14869	14mm	14.2mm	17.8mm	1.4mm	25
14870	14mm	14.2mm	19.8mm	1.4mm	25
14871	16mm	16.2mm	19.8mm	1.4mm	25

METRIC ITEMS

For Actual Size Illustrations, Refer to Pages 185 - 186



Retaining Rings - Basic Internal
DIN 472 - 1300
 Groove required in Bore
 Phosphate & Oil Finish



Auveco Part No.	Shaft Diameter		Groove Diameter		Groove Width		Unit Pkg.
	mm	Inches	mm	Inches	mm	Inches	
11486	26	1.024	27.2	1.072	1.30	.051	50
11488	30	1.181	31.4	1.237	1.30	.051	50
11489	32	1.260	33.7	1.328	1.30	.051	50
11490	35	1.378	37.0	1.457	1.60	.063	50
11491	40	1.575	42.5	1.675	1.85	.073	25
11492	42	1.654	44.5	1.753	1.85	.073	25
11494	52	2.047	55.0	2.165	2.15	.085	25
11495	62	2.441	65.0	2.559	2.15	.085	10



Retaining Rings - Basic External
DIN 471 - 1400
 Groove required on Shaft
 Phosphate & Oil Finish



Auveco Part No.	Shaft Diameter		Groove Diameter		Groove Width		Unit Pkg.
	mm	Inches	mm	Inches	mm	Inches	
11500	10.0	.394	9.6	.378	1.10	.043	100
11501	12.0	.472	11.5	.452	1.10	.043	100
11502	15.0	.591	14.3	.563	1.10	.043	100
11503	17.0	.670	16.2	.637	1.10	.043	50
11505	25.0	.985	23.9	.941	1.30	.051	50
11506	30.0	1.182	28.6	1.126	1.60	.063	50
11507	35.0	1.378	33.0	1.299	1.60	.063	50



Retaining Rings - E Type
DIN 6799 - 1500
 Phosphate & Oil Finish



Auveco Part No.	Shaft Diameter		Groove Diameter		Groove Width		Unit Pkg.
	mm	Inches	mm	Inches	mm	Inches	
11513	1.4	.055	1.2	.047	0.34	.0134	100
11514	2.0	.079	1.5	.059	0.44	.0173	100
11515	2.5	.098	1.9	.075	0.54	.0213	100
11516	3.0	.118	2.3	.091	0.64	.0252	100
11517	4.0	.157	3.2	.126	0.64	.0252	100
11518	5.0	.197	4.0	.157	0.74	.0291	100
11519	6.0	.236	5.0	.197	0.74	.0291	100
11520	7.0	.276	6.0	.236	0.74	.0291	100
11521	8.0	.315	7.0	.276	0.94	.0370	100
11523	10.0	.394	9.0	.354	1.15	.0453	100
11527	20.0	.787	19.0	.748	1.78	.0700	50

METRIC ITEMS

Metric Grease Fittings

(Available in Large Bulk Quantities)



6mm-1.00, Straight
DIN 71412 (VW: N185151)
Overall Length: 14mm
Ball Check, Plated
Ref No. 8601

- 11097** Unit Package: 5
- 15122** Unit Package: 50
- 15123** Unit Package: 100
- 15426** Unit Package: 1000



8mm-1.00, Straight
DIN 71412 (VW: N185161)
Overall Length: 15mm
Ball Check, Plated
Ref No. 8901

- 11098** Unit Package: 5
- 15124** Unit Package: 50
- 15125** Unit Package: 100



8mm-1.25, Straight
Overall Length: 15mm
Ball Check, Plated
Ref No. 9201

- 11778** Unit Package: 10
- 15138** Unit Package: 50
- 15139** Unit Package: 100
- 15434** Unit Package: 1000



10mm-1.00, Straight
DIN71412 (VW: N185301)
Overall Length: 15mm
Ball Check, Plated
Ref No. 9301

- 11100** Unit Package: 5
- 15128** Unit Package: 50
- 15129** Unit Package: 100



10mm-1.5 Straight
Overall Length: 15mm
Ball Check
Ref No. 9501

- 17555** Unit Package: 50



6mm-1.00, 45°
Overall Length: 22mm
Ball Check, Plated
Ref No 7045

- 11775** Unit Package: 10
- 15132** Unit Package: 50
- 15133** Unit Package: 100
- 15431** Unit Package: 1000



8mm-1.00, 45°
Overall Length: 23mm
Ball Check, Plated
Ref No. 7445

- 11777** Unit Package: 10
- 15136** Unit Package: 50
- 15137** Unit Package: 100



8mm-1.25, 45°
Overall Length: 23mm
Ball Check, Plated
Ref No. 7545

- 11779** Unit Package: 10
- 15140** Unit Package: 50
- 15141** Unit Package: 100



10mm-1.00, 45°
Overall Length: 23mm
Ball Check, Plated
Ref No.9345

- 15067** Unit Package: 25
- 15098** Unit Package: 100
- 15099** Unit Package: 250



6mm-1.00, 90°
Overall Length: 18mm
Ball Check, Plated
Ref No.7090

- 11776** Unit Package: 10
- 15134** Unit Package: 50
- 15135** Unit Package: 100



8mm-1.00, 90°
DIN 71412 (VW: N18 511 2)
Overall Length: 18mm
Ball Check, Plated
Ref No. 7940

- 11099** Unit Package: 5
- 15126** Unit Package: 50
- 15127** Unit Package: 100



8mm-1.25, 90°
Overall Length: 18mm
Ball Check, Plated
Ref No. 7590

- 11780** Unit Package: 10
- 15142** Unit Package: 50
- 15143** Unit Package: 100



10mm-1.00, 90°
DIN 71412 (VW: N18 510 1)
Overall Length: 19mm
Ball Check, Plated
Ref No. 9390

- 11101** Unit Package: 5
- 15130** Unit Package: 50
- 15131** Unit Package: 100

Stainless Steel Grease Fittings with Ball Check

303 Series Body · 420 Series Ball · 302 Series Spring



17156
Ref. No. 8058

8mm-1.00, Straight
Overall Length: 15mm

UNIT PACKAGE: 5



Concave Type



Cup Type

Metric Expansion Plugs
Zinc Plated

Auveco Part No.	Size	Type	Unit Pkg.
11876	18.0mm	Cup	25
11877	20.0mm	Cup	25
11878	22.0mm	Cup	25
11879	25.0mm	Cup	25
11881	30.0mm	Cup	25
11884	35.0mm	Cup	10
11886	38.0mm	Cup	10
11888	40.3mm	Cup	10
11895	49.5mm	Cup	10
11896	50.0mm	Cup	10
11899	35.0mm	Concave	25

Metric Cotter Pins
ASME B18.8.6M • Steel



Auveco Part No.	Diameter	Length	Unit Pkg.
10553	2mm	18mm	100
10554	2mm	20mm	100
10556	2.5mm	25mm	100
10557	3.2mm	20mm	100
10558	3mm	25mm	100
10559	3mm	30mm	100
10560	3mm	35mm	50
10562	4mm	30mm	50
10564	4mm	40mm	50
10566	5mm	35mm	25
10567	5mm	40mm	25
10568	5mm	45mm	25

For an assortment of Metric Cotter Pins, see Fix-Kit No. 6158 in the green pages.

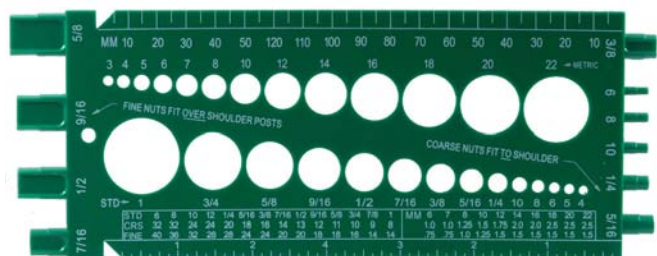

21152

U.S.S., S.A.E. & Metric Bolt and Nut Gauge. Excellent for sizing bolts, screws, nuts (USS, SAE, and Metric) and twist drills. Determine the bolt diameter by pushing the bolt through the sizing holes, as well as, gauges hex nuts and washers (USS & SAE) size. Metric hex nuts and washers can be measured by holding them under the metric holes.

The back of the gauge includes a feature for measuring U.S. and Metric thread pitch. Special notches on the front of the tool allow you to measure flat head metal and wood screws.

Made of sturdy, light weight green plastic that resists water, alcohol, oil and grease.

UNIT PACKAGE: 1

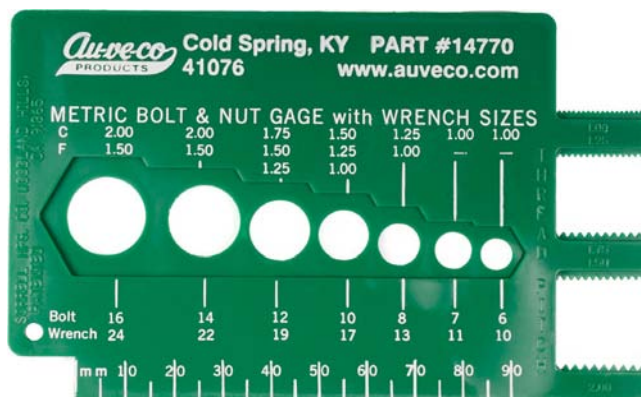

14770

Metric Bolt & Nut Gauge

Determine the diameter of the bolts by pushing them through the holes. Measure the hex head of bolts and screws or the "across the flat" dimension of hex nuts in the recesses around the holes (listed as wrench size).

Right-hand side of tool measures thread pitch (1.00, 1.50, 1.75 & 2.00)

UNIT PACKAGE: 1

Thread Pitches

Approximate threads per inch for Metric Screws, Bolts and Nuts

Diameter in mm	3	4	5	6	7	8	10	12	14	16
Diameter in Inch	.118	.157	.197	.236	.276	.315	.394	.472	.551	.630
Standard Pitch mm	.5	.7	.8	1.0	1.0	1.25	1.5	1.75	2.0	2.0
Approx. Threads/Inch	51	36	32	25	25	20	17	14	12	12
Fine Pitch mm						1.0	1.25	1.5	1.5	1.5
Approx. Threads/Inch						25	20	17	17	17
Extra Fine Pitch mm							1.0	1.25	1.25	1.25
Approx. Threads/Inch							25	20	20	20

Inch Fractions and Decimals to Metric Equivalents

Inches			Inches			Inches		
Fractions	Decimals	mm	Fractions	Decimals	mm	Fractions	Decimals	mm
—	.0004	.01	31/64	.48437	12.303	—	1.1417	29
—	.004	.10	—	.492	12.5	1-5/32	1.156	29.369
—	.01	.25	1/2	.500	12.700	—	1.1811	30
1/64	.0156	.397	—	.5118	13	1-3/16	1.1875	30.163
—	.0197	.50	33/64	.5156	13.097	1-7/32	1.219	30.956
—	.0295	.75	17/32	.53125	13.494	—	1.2205	31
1/32	.03125	.794	35/64	.54687	13.891	1-1/4	1.250	31.750
—	.0394	1	—	.5512	14	—	1.2598	32
3/64	.0469	1.191	9/16	.5625	14.288	1-9/32	1.281	32.544
—	.059	1.5	—	.571	14.5	—	1.2992	33
1/16	.0625	1.588	37/64	.57812	14.684	1-5/16	1.312	33.338
5/64	.0781	1.984	—	.5906	15	—	1.3386	34
—	.0787	2	19/32	.59375	15.081	1-11/32	1.344	34.131
3/32	.094	2.381	39/64	.60937	15.478	1-3/8	1.375	34.925
—	.0984	2.5	5/8	.6250	15.875	—	1.3779	35
7/64	.1093	2.776	—	.6299	16	1-13/32	1.406	35.719
—	.1181	3	41/64	.6406	16.272	—	1.4173	36
1/8	.1250	3.175	—	.6496	16.5	1-7/16	1.438	36.513
—	.1378	3.5	21/32	.65625	16.669	—	1.4567	37
9/64	.1406	3.572	—	.6693	17	1-15/32	1.469	37.306
5/32	.15625	3.969	43/64	.67187	17.066	—	1.4961	38
—	.1575	4	11/16	.6875	17.463	1-1/2	1.500	38.100
11/64	.17187	4.366	45/64	.7031	17.859	1-17/32	1.531	38.894
—	.177	4.5	—	.7087	18	—	1.5354	39
3/16	.1875	4.763	23/32	.71875	18.256	1-9/16	1.562	39.688
—	.1969	5	—	.7283	18.5	—	1.5748	40
13/64	.2031	5.159	47/64	.73437	18.653	1-19/32	1.594	40.481
—	.2165	5.5	—	.7480	19	—	1.6142	41
7/32	.21875	5.556	3/4	.7500	19.050	1-5/8	1.625	41.275
15/64	.23437	5.953	49/64	.7656	19.447	—	1.6535	42
—	.2362	6	25/32	.78125	19.844	1-21/32	1.6562	42.069
1/4	.2500	6.350	—	.7874	20	1-11/16	1.6875	42.863
—	.2559	6.5	51/64	.79687	20.241	—	1.6929	43
17/64	.2656	6.747	13/16	.8125	20.638	1-21/32	1.719	43.656
—	.2756	7	—	.8268	21	—	1.7323	44
9/32	.28125	7.144	53/64	.8281	21.034	1-3/4	1.750	44.450
—	.2953	7.5	27/32	.84375	21.431	—	1.7717	45
19/64	.29687	7.541	55/64	.85937	21.828	1-25/32	1.781	45.244
5/16	.3125	7.938	—	.8662	22	—	1.8110	46
—	.3150	8	7/8	.8750	22.225	1-13/16	1.8125	46.038
21/64	.3281	8.334	57/64	.8906	22.622	1-27/32	1.844	46.831
—	.335	8.5	—	.9055	23	—	1.8504	47
11/32	.34375	8.731	29/32	.90625	23.019	1-7/8	1.875	47.625
—	.3543	9	59/64	.92187	23.416	—	1.8898	48
23/64	.35937	9.128	15/16	.9375	23.813	1-29/32	1.9062	48.419
—	.374	9.5	—	.9449	24	—	1.9291	49
3/8	.3750	9.525	61/64	.9531	24.209	1-15/16	1.9375	49.213
25/64	.3906	9.922	31/32	.96875	24.606	—	1.9685	50
—	.3937	10	—	.9843	25	1-31/32	1.969	50.006
13/32	.4062	10.319	1	1.000	25.4	2	2.000	50.800
—	.413	10.5	—	1.0236	26	—	2.0079	51
27/64	.42187	10.716	1-1/32	1.0312	26.194	—	2.0472	52
—	.4331	11	1-1/16	1.062	26.988	2-1/16	2.062	52.388
7/16	.4375	11.113	—	1.063	27	—	2.0866	53
29/64	.4531	11.509	1-3/32	1.094	27.781	2-1/8	2.125	53.975
15/32	.46875	11.906	—	1.1024	28	—	2.126	54
—	.4724	12	1-1/8	1.125	28.575	—	2.165	55

Inch Fractions and Decimals to Metric Equivalents

Inches			Inches			Inches		
Fractions	Decimals	mm	Fractions	Decimals	mm	Fractions	Decimals	mm
2-3/16	2.1875	55.563	—	3.1496	80	4-1/4	4.250	107.950
—	2.2047	56	3-3/16	3.1875	80.963	4-5/16	4.312	109.538
—	2.244	57	—	3.1890	81	—	4.3307	110
2-1/4	2.250	57.150	—	3.2283	82	4-3/8	4.375	111.125
—	2.2835	58	3-1/4	3.250	82.550	4-7/16	4.438	112.713
2/5-16	2.312	58.738	—	3.2677	83	4-1/2	4.500	114.300
—	2.3228	59	—	3.3071	84	—	4.5275	115
—	2.3622	60	3-5/16	3.312	84.1377	4-9/16	4.562	115.888
2-3/8	2.375	60.325	—	3.3464	85	4-5/8	4.625	117.475
—	2.4016	61	3-3/8	3.375	85.725	—	4.7244	120
2-7/16	2.438	61.913	—	3.3858	86	4-3/4	4.750	120.650
—	2.4409	62	—	3.4252	87	4-7/8	4.875	123.825
—	2.4803	63	3-7/16	3.438	87.313	—	4.9212	125
2-1/2	2.500	63.500	—	3.4646	88	5	5.000	127
—	2.5197	64	3-1/2	3.500	88.900	—	5.1181	130
—	2.559	65	—	3.5039	89	5-1/4	5.250	133.350
2-9/16	2.562	65.088	—	3.5433	90	5-1/2	5.500	139.700
—	2.5984	66	3-9/16	3.562	90.4877	—	5.5118	140
2-5/8	2.625	66.675	—	3.5827	91	5-3/4	5.750	146.050
—	2.638	67	—	3.622	92	—	5.9055	150
—	2.6772	68	3-5/8	3.625	92.075	6	6.000	152.400
2-11/16	2.6875	68.263	—	3.6614	93	6-1/4	6.250	158.750
—	2.7165	69	3-11/16	3.6875	93.663	—	6.2992	160
2-3/4	2.750	69.850	—	3.7008	94	6-1/2	6.500	165.100
—	2.7559	70	—	3.7401	95	—	6.6929	170
—	2.7953	71	3-3/4	3.750	95.250	6-3/4	6.750	171.450
2-13/16	2.8125	71.438	—	3.7795	96	7	7.000	177.800
—	2.8346	72	3-13/16	3.8125	96.838	—	7.0866	180
—	2.8740	73	—	3.8189	97	—	7.4803	190
2-7/8	2.875	73.025	—	3.8583	98	7-1/2	7.500	190.500
—	2.9134	74	3-7/8	3.875	98.425	—	7.8740	200
2-15/16	2.9375	74.613	—	3.8976	99	8	8.000	203.200
—	2.9527	75	—	3.9370	100	—	8.2677	210
—	2.9921	76	3-15/16	3.9375	100.013	8-1/2	8.500	215.900
3	3.000	76.200	—	3.9764	101	—	8.6614	220
—	3.0315	77	4	4.000	101.600	9	9.000	228.600
3-1/16	3.062	77.788	4-1/16	4.062	103.188	—	9.0551	230
—	3.0709	78	4-1/8	4.125	104.775	—	9.4488	240
—	3.1102	79	—	4.1338	105	9-1/2	9.500	241.300
3-1/8	3.125	79.375	4-3/16	4.1875	106.363	—	9.8425	250

U.S. STANDARD GAUGE CHART

Gauge	Decimal Size	Gauge	Decimal Size	Gauge	Decimal Size	Gauge	Decimal Size
7	.188"	14	.078"	21	.034"	28	.016"
8	.172"	15	.070"	22	.031"	29	.014"
9	.156"	16	.063"	23	.028"	30	.013"
10	.141"	17	.056"	24	.025"	31	.011"
11	.125"	18	.050"	25	.022"		
12	.109"	19	.044"	26	.019"		
13	.094"	20	.038"	27	.017"		

Prevailing Torque Lock Nuts

Grade 8 • Cad and Waxed

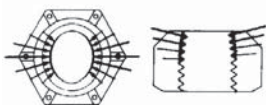

Auveco Part No.	Thread Size	Hex Width	Unit Pkg.
12697	1/4"-20 USS	7/16"	50
12705	1/4"-28 SAE	7/16"	50
12698	5/16"-18 USS	1/2"	50
12699	3/8"-16 USS	9/16"	50
12707	3/8"-24 SAE	9/16"	50
12700	7/16"-14 USS	11/16"	50
12708	7/16"-20 SAE	11/16"	50
12701	1/2"-13 USS	3/4"	25
12709	1/2"-20 SAE	3/4"	25
12710	9/16"-18 SAE	7/8"	25
12703	5/8"-11 USS	15/16"	10
12711	5/8"-18 SAE	15/16"	10
12704	3/4"-10 USS	1-1/8"	10



Hexagon Machine Screw Nuts

Zinc Plated Steel

Auveco Part No.	Thread Size	Hex Width	Unit Pkg.
727	6-32	5/16"	100
728	8-32	11/32"	100
729	10-32	3/8"	100
730	10-24	3/8"	100
731	12-24	7/16"	100
733	1/4"-20	7/16"	100



Reversible Lock Nuts

Grade 2 • Zinc Plated

Auveco Part No.	Thread Size	Hex Width	Unit Pkg.
11740	1/4"-20	7/16"	100
11741	5/16"-18	1/2"	100
11742	3/8"-16	9/16"	50
11743	1/2"-13	3/4"	25
11744	5/8"-11	15/16"	25



Hexagon Machine Screw Nuts

Double Chamfered • Plain Brass

Auveco Part No.	Thread Size	Hex Width	Unit Pkg.
3868	10-24 USS	3/8"	100



Slotted Hex Nuts

Zinc Finish

Auveco Part No.	Thread Size	Hex Width	Slot Width	Unit Pkg.
12723	5/8"-18	15/16"	3/16"-15/64"	25



Nylon Insert Lock Nuts

Grade 2 • Zinc Plated

Auveco Part No.	Thread Size	Hex Width	Unit Pkg.
9535	8-32	11/32"	100
9536	10-24 USS	3/8"	100
9537	10-32 SAE	3/8"	100
9538	12-24	7/16"	100
9539	1/4"-20 USS	7/16"	100
9540	1/4"-28 SAE	7/16"	100
9541	5/16"-18 USS	1/2"	50
9542	5/16"-24 SAE	1/2"	50
9543	3/8"-16 USS	9/16"	50
9544	3/8"-24 SAE	9/16"	50
9545	7/16"-14 USS	5/8"	50
9546	7/16"-20 SAE	5/8"	50
9547	1/2"-13 USS	3/4"	50
9548	1/2"-20 SAE	3/4"	50
15863	5/8"-11 USS	15/16"	25
15864	5/8"-18 SAE	15/16"	25
15865	3/4"-10 USS	1-1/8"	25



Finished USS (Coarse) & SAE (Fine) Hexagon Nuts

Grade 2 • Zinc Plated

Auveco Part No.	Thread Size	Hex Width	Unit Pkg.
3541	1/4"-20 USS	7/16"	100
3542	1/4"-28 SAE	7/16"	100
3543	5/16"-18 USS	1/2"	100
3544	5/16"-24 SAE	1/2"	100
3545	3/8"-16 USS	9/16"	100
3546	3/8"-24 SAE	9/16"	100
3547	7/16"-14 USS	11/16"	100
3548	7/16"-20 SAE	11/16"	100
3549	1/2"-13 USS	3/4"	100
3550	1/2"-20 SAE	3/4"	100
8659	9/16"-12 USS	7/8"	50
8660	9/16"-18 SAE	7/8"	50
8661	5/8"-11 USS	15/16"	50
8662	5/8"-18 SAE	15/16"	50
8663	3/4"-10 USS	1-1/8"	50

Sec. 8

Finished USS (Coarse) & SAE (Fine) Hex Nuts Grade 5 • Zinc Plated



Fully Certified for S.A.E. J995 Standard
Proof Load: 120,000 PSI
C32 Max. Rockwell Hardness

Auveco Part No.	Thread Size	Hex Width	Unit Pkg.
15586	1/4"-20 USS	7/16"	100
15595	1/4"-28 SAE	7/16"	100
15587	5/16"-18 USS	1/2"	100
15596	5/16"-24 SAE	1/2"	100
15588	3/8"-16 USS	9/16"	100
15597	3/8"-24 SAE	9/16"	100
15589	7/16"-14 USS	11/16"	50
15598	7/16"-20 SAE	11/16"	50
15590	1/2"-13 USS	3/4"	50
15599	1/2"-20 SAE	3/4"	50
16981	9/16"-12 USS	7/8"	25
15591	5/8"-11 USS	15/16"	25
15592	3/4"-10 USS	1-1/8"	25
15601	3/4"-16 SAE	1-1/8"	25
15594	1"-8 USS	1-15/32"	10



Finished USS (Coarse) & SAE (Fine) Hexagon Nuts Grade 8 • Zinc & Yellow Plated High Alloy

Auveco Part No.	Thread Size	Hex Width	Unit Pkg.
9300	1/4"-20 USS	7/16"	100
9307	1/4"-28 SAE	7/16"	100
9301	5/16"-18 USS	1/2"	100
9308	5/16"-24 SAE	1/2"	100
9302	3/8"-16 USS	9/16"	100
9309	3/8"-24 SAE	9/16"	100
9303	7/16"-14 USS	11/16"	50
9310	7/16"-20 SAE	11/16"	50
9304	1/2"-13 USS	3/4"	50
9311	1/2"-20 SAE	3/4"	50
9305	5/8"-11 USS	15/16"	25
9312	5/8"-18 SAE	15/16"	25
9306	3/4"-10 USS	1-1/8"	25

Refer to assortments 1020, 1021, 1030 & 1031 in the green pages.



Ziptwist Wing Nut

Auveco Part No.	Thread Size	O.D.	Height	Finish	Unit Pkg.
18531	6mm	5/8"	7/32"	Black	50

NUTS



Washer Base Wing Nuts Zinc Alloy

Auveco Part No.	Thread Size	Wing Spread	Overall Height	Washer O.D.	Unit Pkg.
10036	1/4"-20	1"	1/2"	3/4"	50



Finished USS (Coarse) & SAE (Fine) Hex Nuts Grade 8 • Zinc & Yellow Plated

Fully Certified for S.A.E. J995 Standard
Proof Load: 150,000 PSI
C24-C32 Max. Rockwell Hardness for 1/4 thru 5/8
C26-C34 Max. Rockwell Hardness for 3/4 thru 1

Auveco Part No.	Thread Size	Hex Width	Unit Pkg.
15640	1/4"-20 USS	7/16"	100
15649	1/4"-28 SAE	7/16"	100
15641	5/16"-18 USS	1/2"	100
15650	5/16"-24 SAE	1/2"	100
15642	3/8"-16 USS	9/16"	100
15651	3/8"-24 SAE	9/16"	100
15643	7/16"-14 USS	11/16"	50
15652	7/16"-20 SAE	11/16"	50
15644	1/2"-13 USS	3/4"	50
15653	1/2"-20 SAE	3/4"	50
16983	9/16"-12 USS	7/8"	25
15645	5/8"-11 USS	15/16"	25
15654	5/8"-18 SAE	15/16"	25
15646	3/4"-10 USS	1-1/8"	15

Refer to assortments 1020, 1021 1030 & 1031 in the green pages.



Keps® Lock Washer & Nut Zinc Plated

Auveco Part No.	Thread Size	Hex Width	Unit Pkg.
3492	6-32	5/16"	100
3493	8-32	11/32"	100
3494	10-24	3/8"	100
3495	10-32	3/8"	100
3496	1/4"-20	7/16"	100
3497	1/4"-28	7/16"	100
3498	5/16"-18	1/2"	100
3499	5/16"-24	1/2"	100
3500	3/8"-16	9/16"	100



Square Nuts

Auveco Part No.	Thread Size	Width	Finish	Unit Pkg.
3249	3/16"-24	3/8"	Bright Zinc	100
3250	1/4"-20	7/16"	Bright Zinc	100



Cage Nuts

Phosphate Plated

Auveco Part No.	Thread Size	Fits Sq. Hole	Panel Range	Unit Pkg.
3144	1/4"-20	3/8"	.064-.105"	50
10773	1/4"-20	3/8"	.064-.105"	25
3798	5/16"-18	1/2"	.023-.063"	50



Spin Lock Nuts with Serrations



Auveco Part No.	Thread Size	Flange O.D.	Hex Width	Unit Pkg.
Standard Flange - Zinc Plated				
14878	8-32	15/32"	11/32"	100
14873	10-24	USS 1/2"	3/8"	100
14874	1/4"-20	USS 19/32"	7/16"	100
14875	5/16"-18	USS 11/16"	1/2"	100
14876	3/8"-16	USS 3/4"	9/16"	100
14877	7/16"-14	USS 15/16"	11/16"	50
17084	1/2"-13	USS 1"	3/4"	25
Large Flange - Black Phosphate				
2769	1/4"-20	USS 11/16"	7/16"	100
5167	5/16"-18	USS 13/16"	1/2"	100
5596	3/8"-16	USS 7/8"	9/16"	100



Wing Nuts

Nickel Plated

Auveco Part No.	Size	Unit Pkg.
3741	1/4"-20	100
3743	3/8"-16	50



Self-Locking Wing Nuts

Bright Zinc Chromate

Auveco Part No.	Size	Unit Pkg.
9846	1/4"-20	100



Pushnut Bolt Retainers

For Threaded Fasteners



Auveco Part No.	Bolt Dia.	O.D.	Finish	Unit Pkg.
16851	9/64"	(#6) 11/32"	Zinc	100
10085	5/32"	(#8) 3/8"	Phos.	100
16852	3/16"	(#10) 7/16"	Phos.	100
10086	1/4"	1/2"	Zinc	100
10087	5/16"	5/8"	Zinc	100
9297	3/8"	25/32"	Zinc	100
9298	7/16"	27/32"	Zinc	100
9299	1/2"	15/16"	Zinc	100

For an assortment of Pushnut Bolt Retainers see Fit-Kit No. 6164



Washer Lock Nuts

Zinc Plated



Auveco Part No.	Thread Size	Hex Width	O.D.	Unit Pkg.
2554	6-32	5/16"	7/16"	100
2555	8-32	11/32"	15/32"	100
2556	10-32	3/8"	1/2"	100
2557	10-24	3/8"	1/2"	100
2558	10-24	3/8"	3/4"	100
2560	12-24	3/8"	3/4"	100
2561	1/4"-20	7/16"	19/32"	100
2562	1/4"-20	7/16"	13/16"	100
10764	5/16"-18	1/2"	13/16"	100

For an assortment of Washer Lock Nuts, see Fix-Kit 6043



Flat Push-On Retainers

For Non-Threaded Fasteners



Auveco Part No.	Stud Size	O.D.	Plating	Unit Pkg.
8861	1/16"	3/16"	Phos	100
8862	3/32"	3/16"	Phos	100
8863	1/8"	3/8"	Zinc	100
8864	5/32"	7/16"	Zinc	100
8865	3/16"	7/16"	Zinc	100
8867	.240"	17/32"	Zinc	100
8868	1/4"	17/32"	Zinc	100
8869	5/16"	5/8"	Zinc	100
10374	3/8"	3/4"	Zinc	100
10375	1/2"	1"	Zinc	100
21080	5/8"	1"	Zinc	100



Hex Pal Nuts

Plated



Auveco Part No.	Thread Size	Hex Width	Unit Pkg.
3975	3/8"-24	9/16"	100
8858	1/2"-20	3/4"	100



Acorn Cap Nuts

Nickel Plated

Auveco Part No.	Thread Size	Hex Width	Height	Unit Pkg.
11179	8-32	5/16"	9/32"	100
11180	10-24	3/8"	11/32"	100
11181	10-32	3/8"	11/32"	100
11182	1/4"-20	7/16"	3/8"	50
11183	5/16"-18	9/16"	7/16"	50
11184	3/8"-16	5/8"	1/2"	25



Free Spinning Washer Nuts



Auveco Part No.	Thread Size	Washer O.D.	Hex Size	Height	Plating	O.E.M. No.	Unit Pkg.
16770	#10-24	3/8"	5/16"	11/64"	Zinc & Yellow	383255-S36	100
16771	#10-32	3/8"	5/16"	11/64"	Zinc & Yellow		100
15345	1/4"-20	5/8"	7/16"	9/32"	Zinc & Yellow	3866846, 385400	50
15347	1/4"-20	7/8"	7/16"	5/16"	Phosphate	45334,6023204, 6025004	50
15350	5/16"-18	3/4"	1/2"	3/8"	Phosphate	6025007	50
15351	3/8"-16	7/8"	9/16"	7/16"	Phosphate	376785	25

For metric sizes of Free Spinning Washer Nuts, refer to page 139

THREAD CUTTING NUTS



3400
Zinc

Stud Size: 1/8"
Hex: 1/4"

UNIT PACKAGE: 200



3401
Zinc

Stud Size: 1/8"
Hex: 5/16"

UNIT PACKAGE: 200



2895
Zinc

Stud Size: 1/8"
Hex: 5/16"
Washer Diameter: 17/32"

UNIT PACKAGE: 100



2896
Zinc

Stud Size: 3/16"
Hex: 3/8"
Washer Diameter: 5/8"

UNIT PACKAGE: 100



2897
Zinc

Stud Size: 1/4"
Hex: 7/16"
Washer Diameter: 19/32"

UNIT PACKAGE: 100



3403
Zinc

Stud Size: 1/8"
Hex: 5/16"
Washer Diameter: 7/16"

UNIT PACKAGE: 200



3404
Zinc

Stud Size: 3/16"
Hex: 3/8"
Washer Diameter: 1/2"

UNIT PACKAGE: 200



8855
Zinc

Stud Size: 5/32"
Hex: 3/8"
Washer Diameter: 9/16"

UNIT PACKAGE: 100



3405
Zinc

Stud Size: 1/4"
Hex: 7/16"
Washer Diameter: 11/16"

UNIT PACKAGE: 200



10733
Zinc

Stud Size: 5/16"
Hex: 1/2"
Washer Diameter: 7/8"

UNIT PACKAGE: 100

WHEEL STUDS, BOLTS AND NUTS

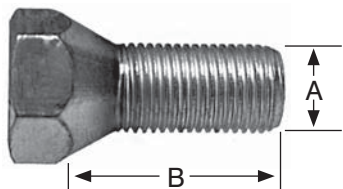

Type #1

Wheel Studs & Bolts
Grade 8 Steel • Plated
UNIT PACKAGE: 10

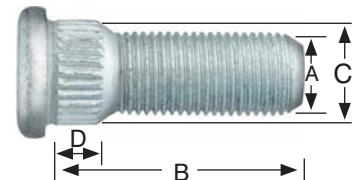

Type #2

Auveco Part No.	Type	Diameter (A)	Length (B)	Knurl Dia. (C)	Shoulder Length (D)	Application
14225	1	1/2"-20	1.070"/1.100"	N/A	N/A	Universal (3/4" Hex)
14227	2	1/2"-20	1.510"/1.540"	.618"/.628"	.310"/.330"	GM 76-55; Int. 80-67
14228	2	7/16"-20	1.380"/1.410"	.556"/.566"	.300"/.320"	GM 51-On
14231	2	1/2"-20	1.615"/1.635"	.618"/.628"	.440"/.460"	Ford 62-On
14235	2	1/2"-20	1.620"/1.650"	.618"/.628"	.630"/.650"	Dodge Tk 82-69; Ford 72-65; GMC 70-60
14237	2	1/2"-20	1.435"/1.465"	.556"/.566"	.420"/.440"	Ford 75-73
14241	2	7/16"-20	1.470"/1.500"	.460"/.470"	.333"/.343"	Chrysler 76-64; GM 84-62; Jeep 82-74
14244	2	1/2"-20	1.720"/1.750"	.615"/.625"	.445"/.460"	Ford 75-On

Wheel Nuts



Type 1 (Outer)



Type 3
(Stainless Steel Cap)



Type 5

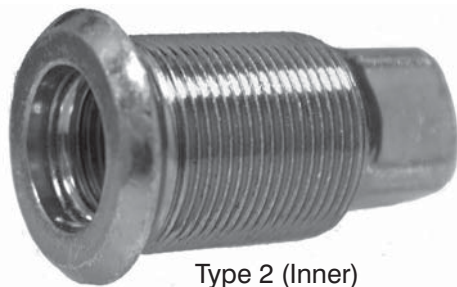

Type 2 (Inner)



Type 4
(Stainless Steel Cap)



Type 6
(Stainless Steel Cap)

Auveco Part No.	Unit Pkg.	Type	Size	Height	Hex	O.E.M No.
8742	50	1	1/2"-20	9/16"	3/4"	Chry: 2409826
8744	50	1	1/2"-20	5/8"	13/16"	GM: 413945, 516637 Ford: C0AZ-1012A
8746	50	1	7/16"-20	9/16"	3/4"	Chry: 2072728
12520	5	2	3/4"-16 L.H. (Inner) 1-1/8"-16 L.H. (Outer)	2-7/32"	13/16" Sq.	Budd: 10709
12521	5	1	1-1/8"-16 L.H.	7/8"	1-1/2"	Budd: 37892
12522	5	2	3/4"-16 (Inner) R.H. 1-1/8"-16 (Outer) R.H.	2-7/32"	13/16" Sq.	Budd: 10708
12523	5	1	1-1/8"-16	7/8"	1-1/2"	Budd: 37891
12524	5	1	3/4"-16 L.H.	7/8"	1-1/2"	Budd: 37889
12525	5	1	3/4"-16	7/8"	1-1/2"	Budd: 37888
12617	5	5	12mm-1.5	23mm	19mm	Chry: 6500092
12675	25	1	12mm-1.5	14mm	19mm	GM: 9590477
12695	5	4	12mm-1.5	34mm	19mm	GM: 10018202
12715	10	1	12mm-1.5	14mm	19mm	Chry: 6500526
14253	10	1	12mm-1.25	16mm	21mm	Nissan: 40224-21001
17353	5	6	12mm-1.5	30mm	19mm	Chry: 6502738
18163	5	4	1/2"-20	1-11/32"	3/4"	Chry: J4006956

Sec. 8

TRUCK WHEEL HARDWARE

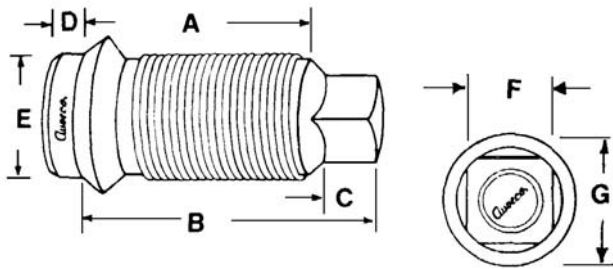

1-1/8" Inner Cap Nuts
 3/4"-16 Inner Thread; 1-1/8"-16 Outer Thread
 Zinc Plated

Auveco Part No.	Thread Type	Description	Dimensions						Unit Pkg.	
			A	B	C	D	E	F		G
12520	LH	for Steel Wheels	1-7/16"	2-7/32"	17/32"		1-3/16"	13/16"	1-13/32"	5
12522	RH	for Steel Wheels	1-7/16"	2-7/32"	17/32"		1-3/16"	13/16"	1-13/32"	5
15004	LH	for Steel/Alum. Combo	1-15/16"	2-5/8"	19/32"		1-7/32"	13/16"	1-13/32"	5
15009	RH	for Alum. Wheels; GR 8	1-21/32"	2-21/32"	5/8"	5/16"	1-1/8"	13/16"	1-13/32"	5
15010	LH	for Alum. Wheels; GR 8	1-21/32"	2-21/32"	5/8"	5/16"	1-1/8"	13/16"	1-13/32"	5

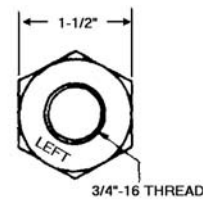
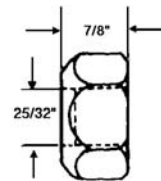
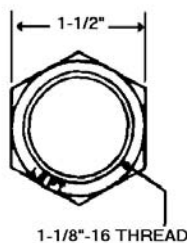
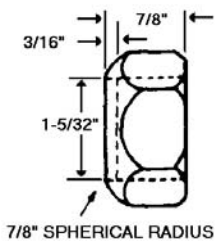

1-1/8" Outer Cap Nut
 Zinc Plated

Auveco Part No.	Description	Unit Pkg.
12521	LH	5
12523	RH	5

3/4" Outer Cap Nut
 Single (3/4") Mounting Front & Rear
 Zinc Plated

Auveco Part No.	Description	Unit Pkg.
12524	LH	5
12525	RH	5



Flange Wheel Nuts

Auveco Part No.	Thread	Hex Size	Flange O.D.	Unit Pkg.
15011	5/8"-18(RH)	1-1/8"	1-5/8"	10



Rim Clamp Nuts
 Zinc Plated

Auveco Part No.	Thread	Hex Size	Unit Pkg.
15015	3/4"-10	1-1/4"	25

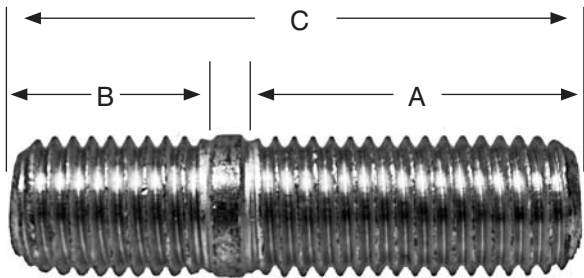

Rim Studs
Grade 8 • Zinc Plated

Auveco Part No.	A Dia. & Length	B Dia. & Length	C Overall Length	Unit Pkg.
15017	3/4"-10 USS x 1-13/16"	3/4"-10 USS x 7/8"	3"	25
15018	3/4"-10 USS x 1-7/8"	3/4"-10 USS x 1"	3-1/8"	25

Truck Wheel Hardware Interchange

The numbers listed in this interchange are cross referenced to the closest equivalent Auveco part. In some instances the parts are not identical, however the Auveco part is designed to service the same application

Part No.	Auveco Part No.	Part No.	Auveco Part No.	Part No.	Auveco Part No.
ALCOA		DAYTON		GMC	
5988-L	15010	5715	15017	2201406	12522
5988-R	15009	5716	15015	2201407	12520
		6654	15016	279670L	12521
		8411	15018	279670R	12523
BATCO		DAYTON WALTHER		NUTURN	
13-3005-R	12522	08-853501	12523	W-5	15016
13-3008-L	15004	08-853502	12521	W-6	15017
13-3012-L	12521	08-853701	12522	W-8	15015
13-3013-L	12524	08-853702	12520	W-11	12522
13-3026-L	15010			W-12	12520
13-3026-R	15009	EUCLID		W-13	12523
13-6003	15017	4956-A	15017	W-14	12521
13-6005	15018	4958	15016	W-15	12525
13-8004	15015	4963	15015	W-16	12524
		5549-L	12520	W-159	15004
BUDD		5549-R	12522	W-246	15018
10708	12522	5552-L	12521	W-486	15009
35337	15004	5552-R	12523	W-487	15010
37888	12525	5652-L	12524		
37889	12524	5652-R	12525		
37891	12523	5706	15018		
37892	12521	5735-L	15004		
95188	15011	5735-R	15003		
		5988-L	15010		
		5988-R	15009		

Round Base: 3 Rivet or Nail Holes for Assembly
Material: Low Carbon Steel, Zinc Finish

For applications into materials of high density and where repeated bolt removal and replacement is expected.

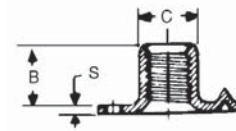
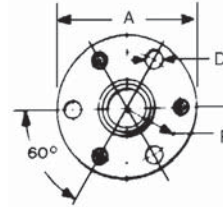

Auveco Part No.	Thread Size	A	B	C	D + .005	R	S	Unit Pkg.
18341	1/4"-20	3/4"	5/16"	.311/.306"	.098"	19/64"	.050"	50
2262	3/8"-16	1"	1/2"	.471/.466"	.145"	5/64"	.075"	100

Claw Prongs: Round Base

Material: Low Carbon Steel, Plain Finish

This Long Prong Teenut has six claw-like prongs that penetrate into wood, toe in, and grip so tightly that you have to drive it to back it out of its hole.

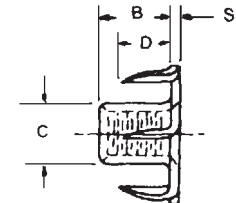
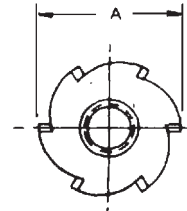

Auveco Part No.	Thread Size	A	B	C	D	S	Unit Pkg.
10729	10-24	3/4"	9/32"	.232/.227"	13/64"	.035"	50
11324	1/4"-20	3/4"	5/16"	.294/.289"	15/64"	.042"	50
10730	1/4"-20	3/4"	7/16"	.294/.289"	15/64"	.042"	50
10731	5/16"-18	7/8"	3/8"	.369/.364"	19/64"	.052"	50
10732	3/8"-16	1.0"	7/16"	.448/.443"	11/32"	.062"	25

Claw Prongs: Slimline, Round Base

Material: Low Carbon Steel, Plain Finish

Recommended where superior retention in soft wood is required.

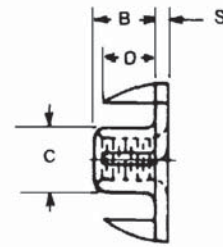
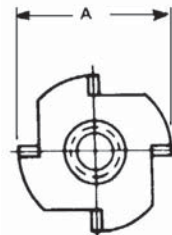

Auveco Part No.	Thread Size	A	B	C	D	S	Unit Pkg.
11325	1/4"-20	3/4"	5/16"	.294/.289"	15/64"	.042"	100
11326	5/16"-18	7/8"	3/8"	.369/.364"	19/64"	.052"	50
11327	3/8"-16	1.00"	7/16"	.448/.443"	11/32"	.062"	25

Claw Prongs: Slimline, Round Base

Material: 300 Series Stainless Steel, Plain Finish

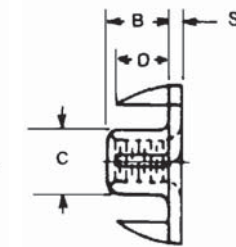
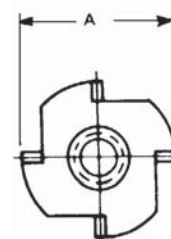

Auveco Part No.	Thread Size	A	B	C	D	S	Unit Pkg.
17013	1/4"-20	3/4"	5/16"	19/64"	3/16"	.047"	25

Straight Prongs: Round Base

Material: Low Carbon Steel, Plain Finish

This Teenut is recommended for thick material applications and applications requiring the top of the barrel to provide a bearing surface for mating parts.

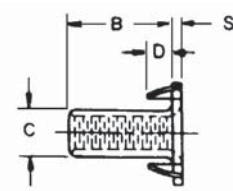
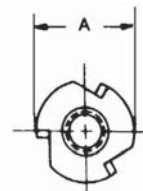

Auveco Part No.	Thread Size	A	B	C	D	Type	S	Unit Pkg.
11328	6-32	9/16"	15/64"	.164/.157"	1/8"	3 Prongs	.020"	50
11331	10-32	3/4"	9/32"	.232/.227"	13/64"	3 Prongs	.035"	50
11332	1/4"-20	3/4"	5/16"	.311/.306"	15/64"	4 Prongs	.050"	50

AUVECO THIN SHEET NUTSERT® INSERTS

U.S.S., S.A.E. & Metric - Steel and Aluminum

Sec. 9

Threaded Inserts for Thin Material

The Auveco Thin Sheet Nutsert has been designed to provide a highly efficient method of securing threads from one side of the work, in materials generally too thin to support threads. Its performance has been proven in plastic, aluminum, mild steel and fiberglass. They can also withstand high loads without vibrating or loosening under extreme operating conditions. The Auveco Thin Sheet Nutsert is a tension fastener with high pull out, insuring no rotation or vibration where a cover plate is used. The system's unique blind tooling installs TSNs at consistent rates using unskilled labor.

How it Works

The Thin Sheet Nutsert, held securely by the tool, is placed into a prepared hole. Upon the tool's actuation, the threaded portion is pulled until the fastener's wall collapses radially outward, clinching it tight against the sheet. The tool is withdrawn, leaving the Thin Sheet Nutsert ready to receive a bolt or screw. This complete operation takes only a few seconds and can be performed by anyone.



Strength Tests: Torque Strength: with an attaching part over the Thin Sheet Nutsert, offering a bearing surface, the TSN will remain intact past the point of the screw or bolt breaking (head torqued off). In almost all cases the threads of the TSN will remain undistorted and serviceable; an exception to this statement is when an extremely high tensile bolt is used.

Steel: 1010 Low Carbon Steel, Type 11 Class 3 with Zinc Plate, Clear Chromate

Aluminum: Aluminum Alloy 5056, Plain Finish, Metric Class 6H, U.S. Class 2B

To set Nutserts, Use tool 11805 & Conversion Kits listed on Page 163.

U.S.S. & S.A.E.

Auveco Part No. Steel	Aluminum	Unit Pkg.	Thread Size after Installation	Recommended Grip Range	A Max.	B Max.	D Ref.	Hole Size	Drill Size
11310	13476	50	6-32 U.S.S.	.020-.080"	.249"	.410"	.287"	.250-.254"	1/4"
11315	13477	100							
11311		50	8-32 U.S.S.	.020-.080"	.249"	.410"	.287"	.250-.254"	1/4"
11316		100							
11312	13480	50	10-24 U.S.S.	.020-.130"	.280"	.465"	.320"	.281-.285"	9/32"
11317	13481	100							
12978		50	10-32 S.A.E.	.020-.130"	.280"	.465"	.320"	.281-.285"	9/32"
12979		100							
11313		25	1/4"-20 U.S.S.	.030-.165"	.347"	.610"	.415"	.375-.379"	3/8"
11318		100							
11314		25	5/16"-18 U.S.S.	.040-.200"	.499"	.720"	.540"	.500-.504"	1/2"
11319		100							
16785*		15	3/8"-16 U.S.S.	.040-.200"	.499"	.720"	.540"	.500-.504"	1/2"

*Cannot be set with Auveco tool 11805, requires pneumatic tool.

Regular Pitch Metric

Auveco Part No. Steel	Aluminum	Unit Pkg.	Thread Size after Installation	Recommended Grip Range	A Max.	B Max.	D Ref.	Hole Size	Drill Size
12980		50	M4-.7	.020-.080" .508/2.030mm	.249" 6.32mm	.410" 10.41mm	.287" 7.29mm	.250-.254" 6.35mm/6.45mm	1/4"
12981		100							
12982		50	M5-.8	.020-.130" .508/3.300mm	.280" 7.11mm	.465" 11.81mm	.320" 8.13mm	.281-.285" 7.14/7.24mm	9/32"
12983		100							
12984	13494	25	M6-1.0	.030-.165" .762/4.190mm	.374" 9.50mm	.610" 15.49mm	.415" 10.54mm	.375-.379" 9.53/9.63mm	3/8"
12985	13495	100							
12986		25	M8-1.25	.040-.200" 1.020/5.080mm	.499" 12.67mm	.720" 18.29mm	.540" 13.72mm	.500-.504" 12.71/12.80mm	1/2"
12987		100							

Sec. 9

LARGE FLANGE THIN SHEET NUTSERT® INSERTS

U.S.S., S.A.E. & Metric - Steel & Aluminum

The Large Flange system provides captive threads in materials too thin to independently support threads, or where costly tapping operations are to be eliminated. The Large Flange fastener can be used as a rivet to join materials that will ultimately have a separate component attached.

Materials: Low Carbon Steel, Zinc Plated
(Metric: Zinc & Yellow Plated)
Aluminum Alloy, Plain Finish

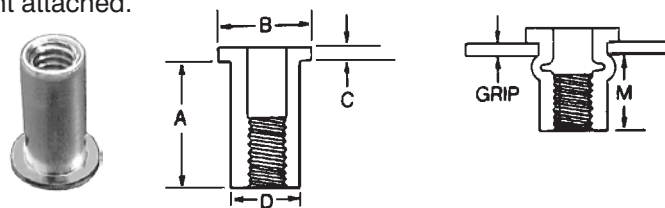

To Set 8-32, 10-24 and 10-32 Large Flange Nutserts, use tool 11805 and conversion kits listed on page 163.

Large Flange Nutserts, 1/4"-20, 5/16"-18 and 3/8"-16, require a pneumatic tool for installation. They cannot be set with 11805.

U.S.S. & S.A.E.

Auveco Part No.		Unit Pkg.	Thread Size	Grip Range	Hole Size	A	B	C	D	M
Aluminum	Steel					+ .015	+ .015	(NOM)	+ .000 - .004	(Ref.)
16177	16187	50	8-32 U.S.S.	.010-.075"	.221-.226"	.438"	.357"	.032"	.221"	.300"
16178	16188	50	10-24 U.S.S.	.010-.080"	.250-.256"	.531"	.406"	.038"	.250"	.380"
16179	16189	50	10-24 U.S.S.	.080-.130"	.250-.256"	.594"	.406"	.038"	.250"	.390"
16180	16190	25	10-32 S.A.E.	.010-.080"	.250-.256"	.531"	.406"	.038"	.250"	.380"
16182*	16192*	25	1/4"-20 U.S.S.	.020-.080"	.332-.338"	.625"	.475"	.058"	.332"	.450"
16183*	16193*	25	1/4"-20 U.S.S.	.080-.140"	.332-.338"	.687"	.475"	.058"	.332"	.450"
16184*	16194*	25	5/16"-18 U.S.S.	.030-.125"	.413-.423"	.750"	.665"	.062"	.413"	.505"
	16195*	25	5/16"-18 U.S.S.	.125-.200"	.413-.423"	.875"	.665"	.062"	.413"	.555"
16789*		10	3/8"-16 U.S.S.	.030-.115"	.490-.500"	.844"	.781"	.088"	.490"	.585"
	16788*	10	3/8"-16 U.S.S.	.115-.200"	.490-.500"	.938"	.781"	.088"	.490"	.595"

*Cannot be set with Auveco tool 11805, requires pneumatic tool

Regular Pitch Metric

Auveco Part No.		Unit Pkg.	Thread Size	Grip Range	Hole Size	A	B	C	D	M
Aluminum	Steel					± .015	± .015	(NOM)	+ .000 - .004	(Ref.)
16978		25	M6-1.0	.020-.118" .5-3.0mm	.358" 9.1mm	.630" 16mm	.510" 13mm	.059" 1.5mm	.356" 9mm	.450" 11.5mm

STAY UP TO DATE WITH US

Auveco releases new items every other week.
Our Hot New Items bulletins can keep you up to date on all new product.

To receive these bulletins please contact customer service:
mail@auveco.com or 1-800-354-9816

We also have all previous and current bulletins posted on www.auveco.com.

NUTSERT® INSERTS

U.S.S. & S.A.E. Thread

Sec. 9

The Auveco Nutsert was developed to offer both the production-oriented designer and the engineer a unique and versatile anchor nut-type insert for high-speed installation. This Auveco system gives the designer the option to design for **blind** or **open** applications, eliminating and simplifying their design problems.

Our system provides a cost-saving method of installing clean, load-bearing steel threads in castings, fiberglass, fiberboard, plastics, wood or almost any ductile material more than .030" thick.

A simple hand tool installs the Nutsert, it is ready for use in seconds and no finishing is required after installation.

Auveco Nutsert's advanced design offers unlimited grip range in a minimum of sizes. Inventory is minimized to one body dimension per thread size; ideally suited for blind, buried and through holes. The ingenious "taper-lock" principle locks-in the Nutsert preventing spin or twist; installs in flat or curved surfaces and is self-tightening with repeated use. The unique design of the installation tool eliminates marring of the parent material surface



Material: Mild Steel, Tin Plated
Minimum Grip: .030"

To set Nutserts use tool 11805 & Conversion Kits listed on page 163.

Auveco Part No.	Unit Pkg.	Thread (Class 2B)	A	B	L	M	C	D	Nominal Hole Size	Thousand (In lbs)
10264	25	6-32 U.S.S.	.218"	.238"	.185"	.370"			7/32"	1.50
10265	100									
10266	1000									
10267	25	8-32 U.S.S.	.249"	.264"	.185"	.370"			1/4"	2.00
10268	100									
10269	1000									
10270	25	10-24 U.S.S.	.280"	.300"	.185"	.370"			9/32"	2.25
10271	100									
10272	1000									
10273	25	10-32 S.A.E.	.280"	.300"	.185"	.370"			9/32"	2.25
10274	100									
10275	1000									
10276	25	1/4"-20 U.S.S.	.374"	.398"	.255"	.510"			3/8"	6.00
10277	100									
10278	1000									
10279	25	1/4"-28 S.A.E.	.374"	.398"	.255"	.510"			3/8"	6.00
10280	100									
10282	10	5/16"-18 U.S.S.	.499"	.524"	.305"	.610"			1/2"	12.87
10283	100									
10284	500									
10285	10	5/16"-24 S.A.E.	.499"	.524"	.305"	.610"			1/2"	12.87
10286	100									
10288*	10	3/8"-16 U.S.S.	.561"	.590"	.370"	.740"			9/16"	18.00
10289*	50									
10290*	100									

Diameters vary with material density in blind application

Dependent upon material thickness and application

*Cannot be set with Auveco tool 11805, requires pneumatic tool.



11805

Nutsert Hand Tool
For regular and thin sheet Nutserts
(Does not include any conversion kits)
Hand tool only with wrench

UNIT PACKAGE: 1

Conversion Kits for Item 11805 Gun

Size	Use Tool 11805 with Auveco Conversion Kit Listed
6-32 U.S.S.	11807
8-32 U.S.S.	11808
10-32 S.A.E.	11809
10-24 U.S.S.	11810
1/4"-20 U.S.S.	11811
1/4"-28 S.A.E.	11812
5/16"-18 U.S.S.	11813
5/16"-24 S.A.E.	11814
3/8"-16 U.S.S.	11815
M4-.7	12988
M5-.8	12989
M6-1.0	12990
M8-1.25	12991

UNIT PACKAGE: 1



11806

Nutsert Tool Kit in metal case
Includes hand tool 11805, nose piece wrench, and conversion kits (nose piece & mandrel) for the following sizes: 6-32, 8-32, 10-24, 10-32, 1/4"-20 & 5/16"-18.

UNIT PACKAGE: 1

16341

Metric Nutsert Tool Kit in metal case
Includes hand tool 11805, nose piece wrench, and conversion kits (nose piece & mandrel) for the following sizes: M4-.7, M5-.8, M6-1.0 (2 in kit) & M8-1.25.

UNIT PACKAGE: 1



15544

Mandrel Puller
Replacement Mandrel Puller
for Auveco 11805 Nutsert Tool
1/4"-28 Left-Hand Thread

UNIT PACKAGE: 1

THREAD REPAIR INSERTS

Professional Insert Installation Tool



Auveco Tool No.	Installs Insert Sizes (Internal Thread)
12394	1/4"-20 & 1/4"-28
12395	5/16"-18 & 5/16"-24
12396	3/8"-16 & 3/8"-24
12397	7/16"-14 & 7/16"-20
12399	M5-0.8
12400	M6-1.0
16163	5/8"-11 H.D. & 5/8"-18 H.D.
16164	3/4"-10 H.D. & 3/4"-16 H.D.

Economy Driver Tool



12404

Will install approximately 10 Inserts.
Use with Thinwall Inserts up to 1/2" and 10mm internal diameter and Heavy Duty Inserts up to 1/2" internal diameter

UNIT PACKAGE: 5

THREAD REPAIR INSERTS

The easy way to repair stripped threads.

Sec. 9

Easy installation with 4 Simple Steps. Instructions must be followed exactly.

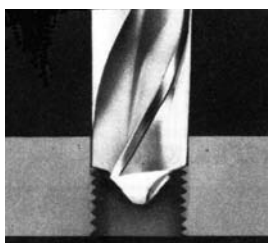

1 Drill out old threads, using standard drill.

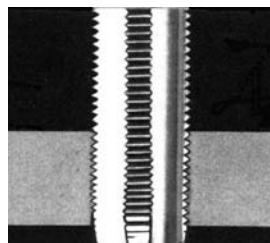

2 Tap new threads, using standard tap.

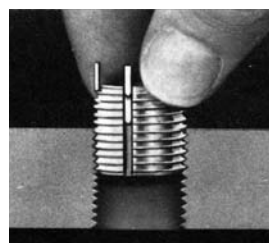

3 Screw in insert until slightly below surface. "Kees" act as depth stop.

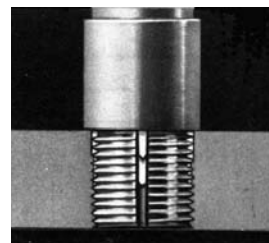

4 Drive "Kees" down with several light taps on installation tool.



5 Installed insert.

Features:

- Installed with standard drills and taps.
- No prewinder tool required.
- Impossible to cross thread while installing.
- No tang break-off.
- May be used in virtually any material: aluminum, magnesium, cast iron, cold rolled steel and plastic.
- Provide high strength and reliability. One length per size provides maximum pullout strength.
- Positive mechanical lock against rotation.
- Breaks Grade 8 bolts in test after test.
- Easy to remove.
- Material: Carbon Steel

Thinwall Inserts

Auveco Part No.	Internal Thread Size (Bolt Size)	External Thread Size	Number of Kees	Insert Length	Drill Size	Tap Size	Professional Installation Tool Part No.	Inserts Per Unit Package
12374	10-24	5/16"-18	2	5/16"	"I"	5/16"-18		4*
17515								25
17516								50
12375	10-32	5/16"-18	2	5/16"	"I"	5/16"-18		4*
17517								25
17518								50
12376	1/4"-20	3/8"-16	2	3/8"	"Q"	3/8"-16	12394	4*
17519								25
17520								50
12377	1/4"-28	3/8"-16	2	3/8"	"Q"	3/8"-16	12394	4*
17521								25
12378	5/16"-18	7/16"-14	4	7/16"	"X"	7/16"-14	12395	4*
17522								25
17523								50
12379	5/16"-24	7/16"-14	4	7/16"	"X"	7/16"-14	12395	4*
17524								25
12380	3/8"-16	1/2"-13	4	1/2"	29/64"	1/2"-13	12396	3*
17525								25
17526								50
12381	3/8"-24	1/2"-13	4	1/2"	29/64"	1/2"-13	12396	3*
17527								25
12382	7/16"-14	9/16"-12	4	9/16"	33/64"	9/16"-12	12397	3*
17528								25
12383	7/16"-20	9/16"-12	4	9/16"	33/64"	9/16"-12	12397	3*
17529								25
12384	1/2"-13	5/8"-11	4	5/8"	37/64"	5/8"-11		2*
17530								15
17531								25
12385	1/2"-20	5/8"-11	4	5/8"	37/64"	5/8"-11		2*
17532								15

*Contains Economy Drive Tool No. 12404

For an assortment of Thinwall Inserts, see Fix-Kit No. 6176

Heavy Duty Thread Repair Inserts

Auveco Part No.	Internal Thread Size (Bolt Size)	External Thread Size	Number of Kees	Insert Length	Drill Size	Tap Size	Professional Installation Tool Part No.†	Inserts Per Unit Package
17238	10-24	3/8"-16	2	.31"	"Q"	3/8"-16	◆	4
17239	10-32							4
17241	1/4"-28	7/16"-14	2	.37"	"X"	7/16"-14	◆	4
17242	5/16"-18	1/2"-13	4	.43"	29/64"	1/2"-13	◆	4
17243	5/16"-24							4
17244	3/8"-16	9/16"-12	4	.50"	33/64"	9/16"-12	◆	3
17245	3/8"-24							3
17246	7/16"-14	5/8"-11	4	.62"	37/64"	5/8"-11	◆	3
17248	1/2"-13	3/4"-16	4	.62"	45/64"	3/4"-16	◆	2
17249	1/2"-20							2
16159	5/8"-11	7/8"-14	4	.87"	53/64"	7/8"-14	16163	2
17533								15
16161	3/4"-10	1-1/8"-12	4	1.12"	1-1/16"	1-1/8"-12	16164	2
17535								10
16162	3/4"-16	1-1/8"-12	4	1.12"	1-1/16"	1-1/8"-12	16164	2
17536								10

† Not packaged with the Thread Repair Inserts

◆ Professional tool not available. Can be set with 12404 Economy Drive Tool one kee at a time.

Metric Thread Repair Inserts®

Auveco Part No.	Internal Thread Size (Bolt Size)	External Thread Size	Number of Kees	Insert Length	Drill Size	Tap Size	Professional Installation Tool Part No.†	Inserts Per Unit Package
12386	M5-0.8	M8-1.25	2	.315"	"H"	M8-1.25	12399	3*
17537								15
12387	M6-1.0	M10-1.25	2	.394"	"S"	M10-1.25	12400	3*
17538								15
12389	M8-1.0	M12-1.25	4	.472"	27/64"	M12-1.25	◆	2*
17539								10
12390	M8-1.25	M12-1.25	4	.472"	27/64"	M12-1.25	◆	2*
17540								10
12391	M10-1.25	M14-1.5	4	.551"	1/2"	M14-1.5	◆	2*
17541								10
12392	M10-1.5	M14-1.5	4	.551"	1/2"	M14-1.5	◆	2*
17542								10

*Contains Economy Drive Tool 12404

† Not packaged with the Thread Repair Inserts

◆ Professional tool not available. Can be set with 12404 Economy Drive Tool one kee at a time.

Thread Repair Insert Assortments

12405 Assortment Kit Contains			12406 Assortment Kit Contains			12407 Assortment Kit Contains		
Auveco Part No.	Qty.	Size	Auveco Part No.	Qty.	Size	Auveco Part No.	Qty.	Size
12374	3	10-24	12375	3	10-32	12387	2	M6-1.0
12376	3	1/4"-20	12377	3	1/4"-28	12389	2	M8-1.0
12378	3	5/16"-18	12379	3	5/16"-24	12390	2	M8-1.25
12380	3	3/8"-16	12381	3	3/8"-24	12391	2	M10-1.25
12404	2	Installation Tools	12404	2	Installation Tools	12404	1	Installation Tool

HELICAL THREAD REPAIR INSERTS & KITS

Sec. 9

For repairing stripped or damaged threads



The most effective and universally accepted method of thread repair. Inserts quickly and permanently restores stripped, worn or damaged threads to their original size and condition.

Easy to use... 1: Drill 2: Tap 3: Install
Now you're back to the original size and the original size fastener can be used.



When threads become stripped, worn or damaged for any reason, the strength and reliability are greatly reduced. When this happens on critical threaded assemblies, cars, and other types of equipment, it may become unsafe to operate.

These potentially dangerous situations are eliminated when the damaged thread is repaired with a thread repair insert. The threaded insert provides stronger, more reliable threads than the original tapped hole and at the same time eliminates the possibility of thread wear, seizing and corrosion.

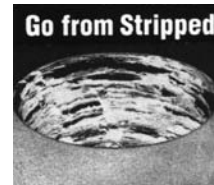

Thread Size & Length	Kits		Insert		Metal Installation Tool		Tap		Required Drill Size
	Contents: Number of inserts shown, one installation tool & one tap.		Auveco Part No.	Unit Pkg.	Auveco Part No.	Unit Pkg.	Auveco Part No.	Unit Pkg.	
	Auveco Kit No.	Inserts Per Kit							

U.S.S. COARSE THREAD (18-8 Stainless Steel)

1/4"-20 x .375"								18597	1	17/64"
3/8"-16 x .562"	18624	10	18547	10						25/64"
7/16"-14 x .656"			18548	10						29/64"
1/2"-13 x .750"	18626	5			18576	1				17/32"

S.A.E. FINE THREAD (18-8 Stainless Steel)

1/4"-28 x .375"	18630	10								17/64"
5/16"-24 x .469"			18554	10						21/64"
3/8"-24 x .562"							18607	1		25/64"
1/2"-20 x .750"			18557	10						33/64"

METRIC REGULAR PITCH (18-8 Stainless Steel)

M8-1.25 x 12.0mm					18586	1				21/64"
M10-1.50 x 15.0mm							18613	1		13/32"

METRIC FINE PITCH (18-8 Stainless Steel)

M10-1.25 x 15.0mm			18563	10						13/32"
M12-1.25 x 18.0mm							18619	1		31/64"

SPARK PLUG THREAD (Mild Carbon Steel)

M14-1.25 x 3/8"			18568	2						Do Not Drill. Use Piloted Tap
M14-1.25 x 1/2"			18569	2	18595	1				

Sec. 9

JACK NUTS®

Material: 1010 Steel, Zinc Plated

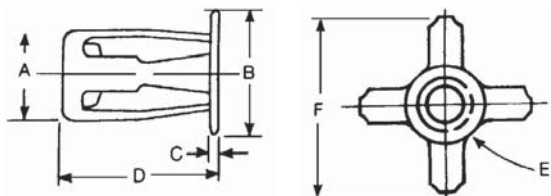

Type 1



Type 2



Type 3

Auveco Part No.	Unit Pkg.	Type	Thread (E)	Body Dia. (A)	Head Dia. (B)	Cap Thick (C)	Overall Length (D)	Grip Range	Required Hole Dia.	Maximum Spread (F)**
13012	25	1	6-32	.318"	.468"	.073"	.653"	1/64"-3/16"	.315"-.330"	.660"
13014	25	1	10-24	.382"	.531"	.073"	.716"	1/64"-3/16"	.385"-.400"	.760"
13016	25	1	1/4"-20	.438"	.625"	.073"	.731"	1/64"-3/16"	.434"-.450"	.890"
13017	25	1	1/4"-20	.438"	.625"	.073"	.919"	3/16"-3/8"	.434"-.450"	.890"

Special Purpose Jack Nuts

Auveco Part No.	O.E.M. Number	Type	Thread	Finish	O.E.M. Application	Unit Pkg.
12995	GM: 367292 Chry: 6031438	3	1/4"-20	Zinc w/Sealer	GM Mirror Mounting Nut	25
12996	GM: 367292 Chry: 6031438	3	1/4"-20	Zinc w/ Sealer	GM Mirror Mounting Nut	100
12997	GM: 1635218, 10014363	1	M6-1.0	Zinc	GM License Plate Nut	25
12999	GM: 14007940	2	M6-1.0	Zinc w/Raintite	GM "X" & "Y" Roof Rack Mounting Nut	10

Jack Nut Installation Tools

Photos not actual size



22402

Professional Jack Nut Installation Tool

UNIT PACKAGE: 1

An economical tool for rapidly installing Jack Nuts in any material. Takes interchangeable screw rods. Just screw rod into Jack Nut, push into hole, squeeze to set and remove. Sets all size Jack Nut Threaded Inserts.

Tool comes with 22403 (6-32 Thread) Installation Rod

Jack Nut Installation Rods Use with 22402 Installation Tool



Auveco Part No.	Unit Pkg.	Thread
22403	1	6-32
22404	1	10-24
22405	1	1/4"-20
22406	1	4mm
22407	1	5mm
22408	1	6mm

22342

Friction Wrench



For use when installing a limited quantity of Jack Nuts. Insert the wrench between the screw and the head of the fastener, hold wrench and run in screw to set Jack Nut.

UNIT PACKAGE: 3

Mirror Mounting Screws and Jack Nuts

For additional information refer to listings on pages 21 and 52.



Auveco Part No.	Description	Unit Pkg.
13231	1/4"-20 x 7/8" Screw (Phos.)	25
13232	1/4"-20 x 7/8" Screw (Phos.) & Jack Nut	25
14947	M6 x 26mm Screw (Chrome)	25
14976	1/4"-20 x 1-1/4" Screw (Stainless Steel)	25
14977	1/4"-20 x 1-1/4" Screw (Stainless Steel) & Jack Nut	10

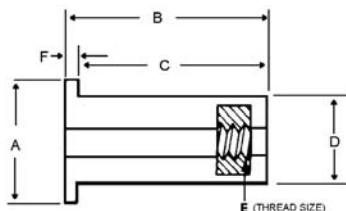

WELL NUTS

Material - Neoprene with Captive Brass Nut



Auveco Part No.	Unit Pkg.	(E) Thread	(A) Head Dia.	(B) Overall Length	(C) Shank Length	(D) Shank Dia.	(F) Head Thick	Hole Size	For Wall Thickness	O.E.M. Number	O.E.M. Application
13006	25	#6-32	.452"	.499"	.437"	.312"	.062"	5/16"	.015"-.156"		
16236	25	#6-32	.554"	.981"	.946"	.240"	.035"	1/4"	.375"-.607"		
16237	25	#8-32	.438"	.499"	.447"	.312"	.052"	5/16"	.015"-.156"	Chry: 6026166 GM: 347065	Rear Compt. Cover Support
13005	25	#8-32	.750"	.575"	.500"	.312"	.062"	5/16"	.015"-.172"	GM: 14048060	License Plate
16240	25	#10-24	.562"	.767"	.580"	.375"	.187"	3/8"	.030"-.227"	GM: 3876130	Voltage Reg & Dome Light
13007	25	#10-32	.500"	.554"	.518"	.377"	.036"	3/8"	.015"-.192"		
13009	10	#10-32	.562"	.665"	.625"	.377"	.040"	3/8"	.035"-.232"	GM: 12338025	Luggage Rack
17586	15	#10-32	.750"	.703"	.625"	.375"	.078"	3/8"	.030"-.227"		
16244	25	#10-32	.750"	.807"	.620"	.375"	.187"	3/8"	.030"-.227"		
13008	10	#10-32	.562"	1.051"	1.000"	.375"	.051"	3/8"	.312"-.643"		
13004	25	1/4"-20	.625"	.641"	.594"	.500"	.051"	1/2"	.015"-.111"	GM: 528846 AMC: 4003120	Luggage Rack
16255	15	1/4"-20	.635"	.801"	.750"	.500"	.051"	1/2"	.187"-.343"		
13010	10	1/4"-20	.740"	.829"	.642"	.500"	.187"	1/2"	.031"-.187"		
16253	25	1/4"-20	.635"	1.051"	1.000"	.500"	.079"	1/2"	.250"-.457"	GM: 342271	Luggage Rack
13011	10	5/16"-18	.875"	.725"	.600"	.620"	.125"	5/8"	.015"-.187"		
16242	25	M5-.8	.500"	.554"	.518"	.375"	.036"	3/8"	.015"-.192"		
16248	25	M5-.8	.562"	.665"	.625"	.375"	.040"	3/8"	.035"-.232"	GM: 14005097	Service Part
13002	10	M6-1.0	.787"	.630"	.579"	.500"	.051"	1/2"	.015"-.094"	GM: 20130258 GM: 14002811	Station Wagon Roof Rack
13003	50									GM: 20130258 GM: 14002811	Station Wagon Roof Rack
16251	25	M6-1.0	.630"	.630"	.579"	.500"	.051"	1/2"	.015"-.111"	GM: 15505451 AMC: 8934201293	Luggage Rack License Plate
16252	25	M6-1.0	.750"	.829"	.642"	.500"	.187"	1/2"	.031"-.187"	VW: 175 820 435	Luggage Rack
16256	10	M8-1.25	.875"	.725"	.600"	.620"	.125"	5/8"	.015"-.156"	AMC: 8934201493	Radiator Brkt.

MISSING SOMETHING?

Is there an item you are looking for that doesn't seem to be in our catalog?

We welcome all suggestions for new items to add to our expansive line of body hardware and specialty fastener selection.

Contact us at mail@auveco.com or 1-800-354-9816

You can also send us all suggestions at www.auveco.com

Photo not actual size



3776

Phosphate

Stud Size: 3/32"
Panel Range: .032"-.040"
Fits into 1/8" Hole

UNIT PACKAGE: 100

Photo not actual size



3137

Phosphate

Stud Size: 3/32"
Panel Range: .025"-.175"
Fits into 1/8" Hole

UNIT PACKAGE: 100



11293

(375890-S102)
Green with Sealer

Stud Size: 1/8"
Panel Range: .035"-.045"
Fits into 3/16" Hole

UNIT PACKAGE: 50



13964

Natural Nylon

Stud Size: 1/8"
Barrel Length: 11/32"
Head Diameter: 15/64"
Head Thickness: 1/32"
Fits into 11/64" Hole

UNIT PACKAGE: 50



2595

Phosphate

Stud Size: 1/8"
Panel Range: .040"-.045"
Fits into 3/16" Hole

UNIT PACKAGE: 100



3777

Phosphate

Stud Size: 1/8"
Panel Range: .038"-.044"
Fits into 5/32" Hole

UNIT PACKAGE: 100



2611

Phosphate

Stud Size: 1/8"
Panel Range: .030"-.036"
Fits into 5/32" Hole

UNIT PACKAGE: 100



5854

(373528-S32), (6000605)
Phosphate

Stud Size: 1/8"
Panel Range: .025"-.045"
Fits into 3/16" Hole

UNIT PACKAGE: 100



5195

(375480-S100)
(3783794)
Phosphate

Stud Size: 1/8"
Panel Range: .036"-.046"
Fits into 1/4" Hole

UNIT PACKAGE: 100



13965

(4006316)
White Nylon

Stud Size: 5/32"
Barrel Length: 1/4"
Head Diameter: 1/4"
Head Thickness: 1/32"
Fits into 3/16" Hole

UNIT PACKAGE: 100



8545

Phosphate

Stud Size: 5/32"
Panel Range: .062"-.068"
Fits into 7/32" Hole

UNIT PACKAGE: 100



8546

Phosphate

Stud Size: 5/32"
Panel Range: .049"-.055"
Fits into 7/32" Hole

UNIT PACKAGE: 100



10073

(6000558)
Phosphate

Stud Size: 3/16"
Panel Range: .038"-.044"
Fits into 7/32" Hole

UNIT PACKAGE: 100

TUBULAR TYPE AND FLAT NUTS

Listed by Stud Size

Sec. 9



13966
(8934-201-767)
Black Nylon

Stud Size: 3/16"
Barrel Length: 17/64"
Head Diameter: 5/16"
Head Thickness: 1/32"
Fits into 17/64" Hole

UNIT PACKAGE: 100



5196
(354341-S)
Phosphate

Stud Size: 1/4"
Panel Range: .034"-.040"
Fits into 9/32" Hole

UNIT PACKAGE: 100



8578
White Nylon

Thread Screw Size: #10
Fits into 5/16" Hole

UNIT PACKAGE: 50



19537
(6000258)
Phosphate

Stud Size: 1/4"
Panel Range: .030"-.034"
Fits into 5/16" Hole

UNIT PACKAGE: 50

FLAT NUTS

For Screws



1896
Phosphate

7/32" x 3/8"
Machine Screw Size: #2-56

UNIT PACKAGE: 100



2089
Phosphate

5/16" x 1/2"
Machine Screw Size: #6-32

UNIT PACKAGE: 100



1898
Phosphate

1/2" x 7/8"
Machine Screw Size: #6-32

UNIT PACKAGE: 100



5563
Phosphate

13/32" x 5/8"
Tapping Screw Size: No. 8

UNIT PACKAGE: 100



3793
Phosphate

13/32" x 5/8"
Tapping Screw Size: No. 8

UNIT PACKAGE: 100

For Screws



1899
Phosphate

1/2" x 7/8"
Machine Screw Size: #8-32

UNIT PACKAGE: 100



2091
Phosphate

5/16" x 1/2"
Machine Screw Size: #8-32

UNIT PACKAGE: 100



1900
Phosphate

1/2" x 7/8"
Tapping Screw Size: #10

UNIT PACKAGE: 100



2092
Phosphate

7/16" x 3/4"
Machine Screw Size: #10-24

UNIT PACKAGE: 100



1912
Phosphate

1/2" x 3/4"
Tapping Screw Size: #12

UNIT PACKAGE: 100

For Screws



1903

Phosphate

9/16" x 1"
Machine Screw Size: 1/4"-20

UNIT PACKAGE: 100

For Studs



2098

Phosphate

7/32" x 3/8"
Stud Size: 1/16"

UNIT PACKAGE: 100



2100

Phosphate

1/4" x 7/16"
Stud Size: 3/32"

UNIT PACKAGE: 100



1906

Phosphate

7/32" x 7/16"
Stud Size: .100" or 3/32"

UNIT PACKAGE: 100



2099

Phosphate

5/16" x 9/16"
Stud Size: 1/8"

UNIT PACKAGE: 100



2102

Phosphate

3/8" x 9/16"
Stud Size: 5/32"

UNIT PACKAGE: 100

For Studs



1905

Phosphate

7/16" x 3/4"
Stud Size: 5/32"

UNIT PACKAGE: 100



2426

Phosphate

3/8" x 5/8"
Stud Size: 3/16"

UNIT PACKAGE: 100



2103

Phosphate

3/8" x 5/8"
Stud Size: 3/16"

UNIT PACKAGE: 100



2105

Phosphate

7/16" x 5/8"
Stud Size: 1/4"

UNIT PACKAGE: 100



3138

Phosphate

1/2" x 11/16"
Stud Size: 5/16"

UNIT PACKAGE: 100

All items available in bulk quantities.

**Call customer service
1-800-354-9816
for a price quote**

U & J TYPE NUTS BY SCREW SIZE

Sec. 9



9625

Phosphate

Screw Size: #6
Panel Range: .090" - .110"
Center of Hole to Edge: 9/32"

UNIT PACKAGE: 100



11292

(445429, 9422552)
Phosphate

Screw Size: #8
Panel Range: .045" - .062"
Center of Hole to Edge: 3/8"

UNIT PACKAGE: 50



21007

Phosphate

Screw Size: #6-32
Panel Range: .045" - .062"
Center of Hole to Edge: 5/16"

UNIT PACKAGE: 50



11768

(388248-S-36B)
Phosphate

Screw Size: #8
Panel Range: .075" - .090"
Center of Hole to Edge: 9/32"

UNIT PACKAGE: 50



5571

Phosphate

Screw Size: #8
Panel Range: .025" - .040"
Center of Hole to Edge: 1/4"

UNIT PACKAGE: 100



19826

(382163-S)
Phosphate

Screw Size: #8
Panel Range: .145" - .160"
Center of Hole to Edge: 9/32"
Replaces Auveco 11063

UNIT PACKAGE: 50



5836

Phosphate

Screw Size: #8
Panel Range: .025" - .035"
Center of Hole to Edge: 3/8"

UNIT PACKAGE: 100



8337

Phosphate

Screw Size: #8-18
Panel Range: .025" - .040"
Center of Hole to Edge: 3/8"

UNIT PACKAGE: 50



2346

Phosphate

Screw Size: #8
Panel Range: .025" - .040"
Center of Hole to Edge: 9/32"

UNIT PACKAGE: 100



14822

(25527289)
Phosphate

Screw Size: M4.2-1.41 (#8)
Panel Range: .094" - .109"
Center of Hole to Edge: 7/32"

UNIT PACKAGE: 50



3796

(9428481)
Phosphate

Screw Size: #8
Panel Range: .025" - .040"
Center of Hole to Edge: 1/4"

UNIT PACKAGE: 100



14814

(N803183-S32)
Phosphate

Screw Size: M4.2-1.41 (#8)
Panel Range: .094" - .156"
Center of Hole to Edge: 1/2"

UNIT PACKAGE: 25



10666

Phosphate

Screw Size: #8
Panel Range: .025" - .035"
Center of Hole to Edge: 11/32"

UNIT PACKAGE: 100



18208

Phosphate

Screw Size: #10
Panel Range: .015" - .085"
Center of Hole to Edge: 11/32"

UNIT PACKAGE: 100

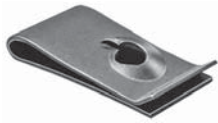

11429

Phosphate

Screw Size: #10
Panel Range: .015"-.060"
Center of Hole to Edge: 15/32"

UNIT PACKAGE: 50



2303

Phosphate

Screw Size: #10
Panel Range: .027"-.045"
Center of Hole to Edge: 3/16"

UNIT PACKAGE: 100



3797

Phosphate

Screw Size: #10
Panel Range: .045"-.062"
Center of Hole to Edge: 13/32"

UNIT PACKAGE: 100



1913

Phosphate

Screw Size: #10
Panel Range: .020"-.051"
Center of Hole to Edge: 15/32"

UNIT PACKAGE: 50



3770

Phosphate

Screw Size: #10
Panel Range: .030"-.037"
Center of Hole to Edge: 3/8"

UNIT PACKAGE: 100



2422

Phosphate

Screw Size: #10
Panel Range: .025"-.064"
Center of Hole to Edge: 3/8"

UNIT PACKAGE: 100



5576

Phosphate

Screw Size: #10
Panel Range: .045"-.062"
Center of Hole to Edge: 13/32"

UNIT PACKAGE: 100



8341

Phosphate

Screw Size: #10
Panel Range: .025"-.060"
Center of Hole to Edge: 11/32"

UNIT PACKAGE: 100



5197

Phosphate

Machine Screw Size: #10-24
Panel Range: .045"-.062"
Center of Hole to Edge: 9/16"

UNIT PACKAGE: 100



2057

Phosphate

Screw Size: #14
Panel Range: .032"-.040"
Center of Hole to Edge: 1/2"

UNIT PACKAGE: 100



2420

Phosphate

Screw Size: #14
Panel Range: .028"-.056"
Center of Hole to Edge: 15/32"

UNIT PACKAGE: 100



2293

(9431647)

Phosphate

Machine Screw Size: 1/4"-20
Panel Range: .064"-.125"
Center of Hole to Edge: 9/16"

UNIT PACKAGE: 100



1907

Phosphate

Tapping Screw Size: 5/16"-10
Panel Range: .032"-.064"
Center of Hole to Edge: 1/2"

UNIT PACKAGE: 50

J TYPE CAGE NUTS

Phosphate Finish



Auveco Part No.	Screw Size	Panel Range	Center of Hole to Edge	Unit Pkg.
5586	1/4"-20 USS	.032/.093"	1/2"	50
3616	5/16"-18 USS	.087"-.093"	9/16"	25
5589	5/16"-18 USS	.087"-.093"	9/16"	50
5170	3/8"-16 USS	.050/.090"	9/16"	25

SPRING TYPE U-NUTS



10064

Phosphate

Screw Size: #6
Panel Range: .025"-.125"
Center of Hole to Edge: 3/8"

UNIT PACKAGE: 50



10065

Phosphate

Screw Size: #8
Panel Range: .025"-.125"
Center of Hole to Edge: 3/8"

UNIT PACKAGE: 25

16267

Same as 10065 except for unit package quantity

UNIT PACKAGE: 100



9880

(9424837, 9431530; 381818-S2)
Phosphate

Screw Size: #8
Panel Range: .025"-.150"
Center of Hole to Edge: 3/8"
GM, Ford

UNIT PACKAGE: 100



9879

(9440178, 11504531; 381863-S2)
Phosphate

Screw Size: #8
Panel Range: .025"-.150"
Center of Hole to Edge: 5/8"
GM, Ford

UNIT PACKAGE: 100



20582

(9433156)
Phosphate

Screw Size: #8
Panel Range: .125"-.250"
Center of Hole to Edge: 3/8"
GM

UNIT PACKAGE: 100



10066

Phosphate

Screw Size: #10
Panel Range: .025"-.125"
Center of Hole to Edge: 11/32"

UNIT PACKAGE: 25



15752

Phosphate

Screw Size: #10
Panel Range: .025"-.150"
Center of Hole to Edge: 9/16"

UNIT PACKAGE: 50



9881

(9425491)
Phosphate

Screw Size: #14
Panel Range: .025"-.150"
Center of Hole to Edge: 5/16"
GM

UNIT PACKAGE: 100



10067

Phosphate

Screw Size: #14
Panel Range: .025"-.125"
Center of Hole to Edge: 3/8"

UNIT PACKAGE: 25



14526
(N802538-S100)
Green Phosphate

Screw Size: #8
Panel Range: 1/16"-5/32"
Center of Hole to Edge: 5/16"
Width: 17/32", Length: 51/64"
Ford

UNIT PACKAGE: 50



14527
(10041588, 25530441)
Phosphate

Screw Size: #8
Panel Range: 1/16"-3/16"
Center of Hole to Edge: 19/32"
Width: 35/64", Length: 1-1/32"
GM

UNIT PACKAGE: 50



14750
(Toyota: 53879-14010-A,
53879-14020, 53879-22030;
GM: 94841226;
Mazda: LA01-56-135)

Nylon U-Nut Fender/
Wheel Housing Applications
Screw Size: #10
Panel Range: Up to 1mm
Center of Hole to Edge: 11mm
Width: 20mm, Length: 31mm
Toyota, Geo Prizm, Nova & Mazda

UNIT PACKAGE: 15

19669

Same as 14750 except for unit package quantity

UNIT PACKAGE: 25



20956
(90467-05114)
Black Nylon

Bumper & Fender Apron
Nylon U-Nut
Screw Size: M5.5 (#12)
Center of Hole to Edge: 14mm
Panel Range: Up to 1mm
Width: 20mm, Length: 36mm
Lexus & Toyota

UNIT PACKAGE: 10



19162
(1638575, 25512688)
Zinc

Screw Size: M4.2 (#8)
Panel Range: .035"-.049"
Center of Hole to Edge: 9/16"
GM

UNIT PACKAGE: 25



19163
Zinc

3 Position U-Nut
Screw Size: M4.2 (#8)
Panel Range: Up to 3/32"
Center of Hole to Edge: 15/32"
Width: 27/32", Length: 7/8"

UNIT PACKAGE: 25



19164
Phosphate

4 Position U-Nut
Screw Size: M4.2 (#8)
Panel Range: Up to 5/32"
Center of Hole to Edge: 7/16"
Width: 15/16", Length: 29/32"

UNIT PACKAGE: 25



19165
Phosphate

Multi-Position U-Nut
Screw Size: M4.2 (#8)
Panel Range: Up to 5/64"
Center of Hole to Edge: 25/64"
Width: 3/4", Length: 11/16"

UNIT PACKAGE: 25



19166
(1260888, 25556911)
Phos. & Blue

Multi-Position U-Nut
Screw Size: M4.2 (#8)
Panel Range: 1/16"-5/64"
Center of Hole to Edge: 7/16"
Windshield Defroster Nozzle & Various
Instrument Panel Applications
GM 1984 - On

UNIT PACKAGE: 25

EXTRUDED U-NUTS

Fold Over Nuts

Sec. 9



10048

(45262)

Phosphate

Screw Size: #8-32
Panel Range: .025"-.150"
Center of Hole to Edge: 3/8"
Ford

UNIT PACKAGE: 50



8375

(152266)

Phosphate

Screw Size: 5/16"-18
Panel Range: .025"-.060"
Center of Hole to Edge: 9/16"
GM

UNIT PACKAGE: 50



18898

(45262)

Phosphate

Screw Size: #8-32
Panel Range: .079"-.118"
Center of Hole to Edge: 3/8"
Ford

UNIT PACKAGE: 50



10053

(Chry: 6023171; Ford: 45264)
Phosphate

Screw Size: 5/16"-18
Panel Range: .025"-.150"
Center of Hole to Edge: 9/16"
Ford

UNIT PACKAGE: 50



15677

(152273)

Phosphate

Screw Size: #10-24
Panel Range: .025"-.125"
Center of Hole to Edge: 15/32"
GM

UNIT PACKAGE: 50



12265

(45264-S2)

Phosphate

Screw Size: 5/16"-18
Panel Range: .040"-.125"
Center of Hole to Edge: 9/16"
Ford

UNIT PACKAGE: 50



8359

(1480627, 1494252)

Phosphate

Screw Size: 1/4"-20
Panel Range: .025"-.150"
Center of Hole to Edge: 17/32"
GM

UNIT PACKAGE: 50



8377

(1480909)

Phosphate

Screw Size: 5/16"-18
Panel Range: .060"-.090"
Center of Hole to Edge: 9/16"
GM

UNIT PACKAGE: 50



10050

(45263-S2)

Phosphate

Screw Size: 1/4"-20
Panel Range: .025"-.150"
Center of Hole to Edge: 17/32"
Ford

UNIT PACKAGE: 25



8372

(152267)

Phosphate

Screw Size: 5/16"-18
Panel Range: .120"-.150"
Center of Hole to Edge: 9/16"
GM

UNIT PACKAGE: 50

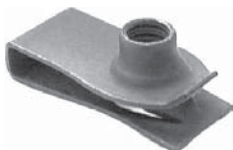

10051

(45267; 1494257)

Phosphate

Screw Size: 1/4"-20
Panel Range: .025"-.150"
Center of Hole to Edge: 25/32"
Ford, GM

UNIT PACKAGE: 50



10830

(1494253)

Phosphate

Screw Size: 5/16"-18
Panel Range: .025"-.150"
Center of Hole to Edge: 9/16"
GM

UNIT PACKAGE: 50

EXTRUDED U-NUTS

Fold Over Nuts



8814

(1494258; 379831-S)
Phosphate

Screw Size: 5/16"-18
Panel Range: .025"-.150"
Center of Hole to Edge: 27/32"
GM & Ford

UNIT PACKAGE: 25



10052

(10008002; 45268-S2)
Phosphate

Screw Size: 5/16"-18
Panel Range: .025"-.150"
Center of Hole to Edge: 7/8"
GM & Ford

UNIT PACKAGE: 25



10054

(1494254, 12337873, 45265-S2)
Phosphate

Screw Size: 3/8"-16
Panel Range: .050"-.200"
Center of Hole to Edge: 3/4"
GM & Ford

UNIT PACKAGE: 25



10055

(45269)
Phosphate

Screw Size: 3/8"-16
Panel Range: .050"-.200"
Center of Hole to Edge: 1-1/8"
Ford

UNIT PACKAGE: 25

Metric Extruded U-Nuts



18337

(GM: 11500654;
Ford: N623330-S2)
Zinc Organic

Screw Size: M4-.7
Panel Range: .60mm-3.8mm (.024"-.150")
Center of Hole to Edge: 9.5mm (3/8")
GM & Ford

UNIT PACKAGE: 50



11625

(11500655)
Phosphate

Screw Size: M4-.7
Panel Range: .80mm-4.00mm (.030"-.160")
Center of Hole to Edge: 13.5mm (17/32")
GM

UNIT PACKAGE: 50



20339

(11516397)
Zinc Organic

Locking Thread
Screw Size: M4.2-1.41 (#8)
Panel Range: .5mm-2.0mm (.020"-.079")
Center of Hole to Edge: 10mm (25/64")
GM

UNIT PACKAGE: 50



21040

(11513599)
Zinc Organic

Locking Thread
Screw Size: M4.2-1.41 (#8)
Panel Range: .65mm-3.8mm (.025"-.150")
Center of Hole to Edge: 9.5mm (3/8")
GM

UNIT PACKAGE: 25

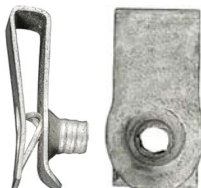

22074

(GM: 11515638)
Zinc Organic

Locking Thread
Metric Extruded U-Nut
Screw Size: M4.2-1.41 (#8)
Panel Range: .65mm-3.80mm (.025"-.150")
Center of Hole to Edge: 15mm
GM

UNIT PACKAGE: 25

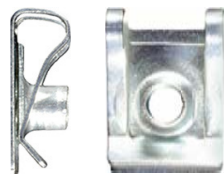

22113

(BMW: 51127070202;
VW: N90168602)
Zinc Finish

Metric Extruded U-Nut
Screw Size: M5-.8
Panel Range: .45mm - 1.5mm
Center of Hole to Edge: 11.5mm
BMW 1999 - 1992
VW 1993 - On

UNIT PACKAGE: 25



18338

(GM: 11505596; Ford: N623331-S2)
Phosphate

Screw Size: M5-.8
Panel Range: .60mm-3.8mm (.024"-.150")
Center of Hole to Edge: 11mm (7/16")
GM, Ford

UNIT PACKAGE: 50

EXTRUDED U-NUTS

Fold Over Nuts

Sec. 9



11626

(11500657)
Phosphate

Screw Size: M5-.8
Panel Range: .80mm-4.00mm (.030"-.160")
Center of Hole to Edge: 15.8mm (5/8")
GM

UNIT PACKAGE: 50



21540

(GM: 24449408)
Orange Nylon

Screw Size: M5.5 (#12)
Panel Range: Up to 2mm (.079")
Center of Hole to Edge: 12mm (15/32")
GM & Saab

Use with Auveco 21541

UNIT PACKAGE: 25



16846

(6502152)
Phosphate

Tri-Lobular Locking Thread
Screw Size: M6-1.0
Panel Range: .80mm-4.00mm (.030"-.160")
Center of Hole to Edge: 12mm (15/32")
Chrysler

UNIT PACKAGE: 50



16842

(11504047; N802331-S53)
Phosphate

Screw Size: M6-1.0
Panel Range: 3.4mm-6.3mm (.140"-.250")
Center of Hole to Edge: 13.5mm (17/32")
GM & Ford

UNIT PACKAGE: 25



18449

(6101308)
Phosphate

Locking Thread
Screw Size: M6-1.0
Panel Range: .80mm-4.00mm (.030"-.160")
Center of Hole to Edge: 13.5mm (17/32")
Chrysler

UNIT PACKAGE: 50



11864

(11503714, 11503716)
Phosphate

Screw Size: M6-1.0
Panel Range: .80mm-4.00mm (.030"-.160")
Center of Hole to Edge: 13.5mm (17/32")
GM

UNIT PACKAGE: 50



12669

1016937, 11503957; 12337917
N623332-S2, -S53 & -S100;
W5220822-S426)
Phosphate

Screw Size: M6-1.0
Panel Range: .80mm-4.00mm (.030"-.160")
Center of Hole to Edge: 13.5mm (17/32")
GM, Ford

UNIT PACKAGE: 25

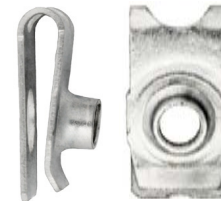

22105

(Honda: 90675-SA5-003)
Zinc

Metric Extruded U-Nut
Screw Size: M6-1.0
Panel Range: 2mm - 4mm
Center of Hole to Edge: 14.5mm (9/16")
Acura 2007 - 1998; Honda 2014 - 1983

UNIT PACKAGE: 25



12666

(11504978)
Zinc Organic

Screw Size: M6-1.0
Panel Range: 3.4mm-6.3mm (1.35"-.250")
Center of Hole to Edge: 14.5mm (9/16")
GM

UNIT PACKAGE: 25



20416

(11516372)
Zinc Organic

Screw Size: M6-1.0
Panel Range: 2.0mm-5.0mm (.079" - .197")
Center of Hole to Edge: 14.5mm (9/16")
GM

UNIT PACKAGE: 25



12575

(11503715, 11508241,
11609385)
Phosphate

Screw Size: M6-1.0
Panel Range: .80mm-4.0mm (.030"-.160")
Center of Hole to Edge: 19.5mm (25/32")
GM

UNIT PACKAGE: 25



16322

(14040999)
Phosphate

Screw Size: M6-1.0
Panel Range: 1.0mm-2.5mm (.045"-.095")
Center of Hole to Edge: 19.5mm (25/32")
GM

UNIT PACKAGE: 50

EXTRUDED U-NUTS

Fold Over Nuts



19480
(N805889-S100)
Phosphate

Screw Size: M6-1.0
Panel Range: 4.3mm-5.6mm
(.172"-.219")
Center of Hole to Edge: 21mm (13/16")
Ford

UNIT PACKAGE: 15



11630
(11500661, 11503317,
11516150;
N623343-S2 & S100)
Phosphate

Screw Size M8-1.25
Panel Range: .80mm-4.00mm (.030"-.160")
Center of Hole to Edge: 20mm (13/16")
GM, Ford

UNIT PACKAGE: 25



11627
(11502785, 11504035)
Phosphate

Screw Size: M6.3-1.0
Panel Range: .80mm-4.00mm (.030"-.160")
Center of Hole to Edge: 13.5mm (17/32")
GM

UNIT PACKAGE: 25



19644
(10084751)
Phosphate

Screw Size: M8-1.25
Panel Range: 1.7mm-5.5mm (.067"-.217")
Center of Hole to Edge: 28.5mm (1-1/8")
GM

UNIT PACKAGE: 15



11628
(9433043, 11500658)
Phosphate

Screw Size: M6.3-1.0
Panel Range: .80mm-4.00mm (.030"-.160")
Center of Hole to Edge: 13.5mm (17/32")
GM

UNIT PACKAGE: 25



18401
(N801117-S100)
Black Phosphate

Locking Thread
Screw Size: M8-1.25
Panel Range: 4mm-7mm (.157"-.276")
Center of Hole to Edge: 21mm (13/16")
Ford

UNIT PACKAGE: 25



12667
(11503455, 11504288)
Zinc Organic

Screw Size: M8-1.25
Panel Range: 1.50mm-5.50mm
(.060"-.216")
Center of Hole to Edge: 14.5mm (9/16")
GM

UNIT PACKAGE: 25



11631
(11500662, 22531616)
Phosphate

Screw Size: M10-1.50
Panel Range: 1.0mm-6.0mm
(.040"-.230")
Center of Hole to Edge: 19mm (3/4")
GM

UNIT PACKAGE: 25

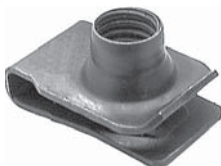

11629
(11500660, 11502617;
N623333-S2; 6101283)
Phosphate

Screw Size: M8-1.25
Panel Range: .80mm-4.00mm (.030"-.160")
Center of Hole to Edge: 14.5mm (9/16")
GM, Ford, Chrysler

UNIT PACKAGE: 25

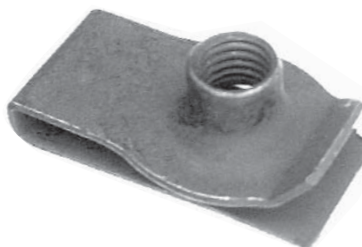

18339
(GM: 11500663;
Ford: N623344-S2)
Phosphate

Screw Size: M10-1.5
Panel Range: 1.5mm-5.5mm (.060"-.215")
Center of Hole to Edge: 28mm (1-3/32")
GM, Ford

UNIT PACKAGE: 25



Countersunk Type Washers

Screw Size	I.D.	O.D.	Nickel Plated Brass			Black Zinc Plated Brass		Plain Brass	
			Unit Pkg. 100	Unit Pkg. 144	Unit Pkg. 1000	Part No.	Unit Pkg.	Part No.	Unit Pkg.
#4	9/64"	3/8"	612		7613				
#6	11/64"	7/16"	614	7143	7615	16011	100		
#8	13/64"	1/2"	616	7145	7616	16012	100		
#10	1/4"	19/32"	618	7147	7618	16013	100	16593	100
#12	9/32"	11/16"	619	7148					



Flanged Type Countersunk Washers

Screw Size	I.D.	O.D.	Nickel on Brass Part No.	Black Zinc on Brass Part No.	Stainless Steel Part No.	Unit Pkg.
#6	5/32"	1/2"	3469		3470	100
#8	13/64"	5/8"	2515	16009	2597	100
#10	1/4"	11/16"	3471		3472	100



Flush Type Washers Nickel Plated on Brass

Unit Pkg. 100	Unit Pkg. 144	Unit Pkg. 1000	Screw Size	I.D.	O.D.
602	7137	7624	#6	5/32"	11/32"
604	7138	7625	#8	3/16"	3/8"
16015		16016	#10	13/64"	15/32"

Nylon Finishing Washers

Available in natural or black nylon.
 These molded washers protect cabinets from scratching, cover misaligned holes, etc.
 May also be used as guides, bumpers and spacers.

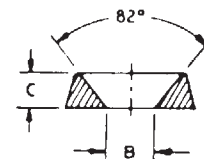
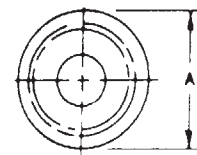

Auveco Part No.	Screw Size	O.D. (A)	I.D. (B)	Thickness (C)	Color	Unit Pkg.
13717	#6	.437" (11.10mm)	.143" (3.63mm)	.100" (2.54mm)	Black	50
13718	#8	.515" (13.08mm)	.171" (4.34mm)	.115" (2.92mm)	Natural	50
13719	#8	.515" (13.08mm)	.171" (4.34mm)	.115" (2.92mm)	Black	50
13720	#10	.580" (14.73mm)	.191" (4.85mm)	.152" (3.86mm)	Natural	50
13721	#10	.580" (14.73mm)	.191" (4.85mm)	.152" (3.86mm)	Black	50
13723	#12	.609" (15.47mm)	.225" (5.72mm)	.160" (4.06mm)	Black	50
13724	#14	.683" (17.35mm)	.251" (6.38mm)	.183" (4.65mm)	Natural	50
13725	#14	.683" (17.35mm)	.251" (6.38mm)	.183" (4.65mm)	Black	50



USS (Wrought) Washers

Bolt Size	I.D.	O.D.	Thick-ness	Zinc Part No.	Plain Part No.	Unit Pkg.
3/16"	1/4"	9/16"	3/64"	8605		100
1/4"	5/16"	3/4"	1/16"	8606	3929	100
5/16"	3/8"	7/8"	1/16"	8607	3930	100
3/8"	7/16"	1"	5/64"	8608	3931	100
7/16"	1/2"	1-1/4"	5/64"	8609	3932	100
1/2"	9/16"	1-3/8"	7/64"	8610	3933	100
9/16"	5/8"	1-1/2"	7/64"	8611		100
5/8"	11/16"	1-3/4"	9/64"	8612	3935*	50
3/4"	13/16"	2"	5/32"	8613		50

* Unit package quantity is 100



SAE Washers Zinc

Auveco Part No.	Bolt Size	I.D.	O.D.	Thick-ness	Unit Pkg.
3984	#6 (1/8")	5/32"	3/8"	3/64"	100
16721	#8 (5/32")	3/16"	7/16"	3/64"	100
3985	#10 (3/16")	7/32"	1/2"	1/16"	100
3986	1/4"	9/32"	5/8"	1/16"	100
3987	5/16"	11/32"	11/16"	1/16"	100
3988	3/8"	13/32"	13/16"	1/16"	100
3989	7/16"	15/32"	15/16"	1/16"	100
3990	1/2"	17/32"	1-1/16"	3/32"	100
3991	9/16"	19/32"	1-3/16"	3/32"	100
3992	5/8"	21/32"	1-5/16"	3/32"	100
3993	3/4"	13/16"	1-1/2"	1/8"	100
8621	7/8"	29/32"	1-3/4"	1/8"	100



High Strength Grade 8 Washers

1035 Steel • R/C38-45 Hardness • Zinc & Gold Dichromate Finish

For use with Grades 5 and 8 Bolts

USS Sizes

Auveco Part No.	Bolt Size	I.D.	O.D.	Thick-ness	Unit Pkg.
12771	1/4"	5/16"	3/4"	.051/.080"	100
12772	5/16"	3/8"	7/8"	.064/.104"	100
12773	3/8"	7/16"	1"	.064/.104"	100
12774	7/16"	1/2"	1-1/4"	.064/.104"	50
12775	1/2"	9/16"	1-3/8"	.097/.121"	50
12776	9/16"	5/8"	1-1/2"	.097/.121"	25
12777	5/8"	11/16"	1-3/4"	.108/.160"	25
12778	3/4"	13/16"	2"	.122/.177"	10
12779	7/8"	15/16"	2-1/4"	.136/.192"	10

SAE Sizes

Auveco Part No.	Bolt Size	I.D.	O.D.	Thick-ness	Unit Pkg.
12781	1/4"	9/32"	5/8"	.055/.072"	100
12782	5/16"	11/32"	11/16"	.055/.072"	100
12783	3/8"	13/32"	13/16"	.055/.072"	100
12784	7/16"	15/32"	59/64"	.055/.072"	50
12785	1/2"	17/32"	1-1/16"	.097/.121"	50
12786	9/16"	19/32"	1-3/16"	.097/.121"	50
12787	5/8"	11/16"	1-5/16"	.122/.146"	25
12788	3/4"	13/16"	1-15/32"	.122/.146"	25
12789	7/8"	15/16"	1-3/4"	.136/.160"	15
12790	1"	1-1/8"	2"	.136/.160"	10



Spring Type Lock Washers

Grade 5 • Zinc

Auveco Part No.	Bolt Size	Unit Pkg.
5717	#6 (1/8")	200
5718	#8 (5/32")	200
5719	#10 (3/16")	200
5720	1/4"	200
5721	5/16"	200
5722	3/8"	200
5723	7/16"	200
5724	1/2"	200
8649	9/16"	100
8650	5/8"	100
14879	3/4"	50



Copper Washers

Auveco Part No.	Bolt Size	I.D.	O.D.	Thick-ness	Unit Pkg.
15911	3/16"	1/4"	7/16"	1/32"	50
15914	3/16"	1/4"	5/8"	1/16"	25
15912	1/4"	5/16"	1/2"	1/32"	50
15915	1/4"	5/16"	11/16"	1/16"	25
15913	5/16"	3/8"	9/16"	1/32"	50
15916	5/16"	3/8"	3/4"	1/16"	25
15917	3/8"	7/16"	13/16"	1/16"	25
15918	7/16"	1/2"	7/8"	1/16"	25
15919	1/2"	9/16"	13/16"	3/32"	25



Belleville Washers

Phosphate and Oil

Auveco Part No.	Bolt Size	I.D.	O.D.	Thick-ness	Unit Pkg.
14847	1/4"-6mm	.255"	.500"	.022"	50
14848	1/4"-6mm	.255"	.500"	.038"	50
14850	5/16"-8mm	.317"	.625"	.047"	50
14851	3/8"-10mm	.380"	.750"	.034"	25
14852	3/8"-10mm	.380"	.750"	.056"	25
14854	1/2"-12mm	.505"	1.00"	.050"	25



High Alloy Lock Washers

Grade 8

Zinc & Yellow Dichromate

For use with Grade 5 & 8 Bolts

Auveco Part No.	Bolt Size	Unit Pkg.
11925	1/4"	100
11926	5/16"	100
11927	3/8"	100
11928	7/16"	50
11929	1/2"	50
11931	5/8"	50
11933	7/8"	25



Bowed Spring Washers

Black Parkerized

Auveco Part No.	Bolt Size	I.D.	O.D.	Thick-ness	Unit Pkg.
9630	3/8"	25/64"	3/4"	1/64"	50

For fastener assortments refer to assortments 1020 and 1030 in the green pages.



Fender Washers Zinc Plated

Auveco Part No.	Bolt Size	I.D.	O.D.	Thick-ness	Unit Pkg.
2007	3/16"	7/32"	1/2"	3/64"	100
1183	3/16"	7/32"	3/4"	3/64"	100
16018	3/16"	7/32"	1"	3/64"	100
16019	3/16"	7/32"	1-1/4"	3/64"	50
2008	1/4"	9/32"	5/8"	3/64"	100
16020	1/4"	9/32"	1"	1/16"	100
2333	1/4"	9/32"	1-1/4"	1/16"	100
16021	1/4"	9/32"	1-1/2"	3/64"	50
1376	5/16"	21/64"	3/4"	1/16"	100
768	5/16"	11/32"	1-1/4"	3/64"	100
17095	5/16"	11/32"	1-1/4"	1/8"	25
1700	5/16"	11/32"	1-1/2"	3/64"	50
3553	3/8"	13/32"	1-1/4"	1/16"	100
2227	3/8"	13/32"	1-1/2"	3/64"	50
16022	3/8"	27/64"	1-5/8"	1/16"	50
1294	3/8"	7/16"	1-3/4"	1/16"	25
17094	3/8"	7/16"	1-3/4"	1/8"	25
3554	1/2"	17/32"	1-1/4"	3/64"	100
3556	1/2"	17/32"	1-1/2"	3/64"	100
16023	1/2"	17/32"	2"	1/16"	25



Vibration Proof Lock Washers Zinc Flake Coated

For use with Grade 5, Grade 8 & ASTM 574 High Grade Bolts

These washers have cams or wedges on one side, a lead angle greater than a thread angle, and radial teeth or ribs on the other side. The washers are installed cam face to cam face. When tightening the fastener to preload, the teeth penetrate and seat against the joint material and the nut and/or fastener head. When subjected to vibration the interacting cams create a wedge action which prevents the fastener from vibrating loose.

Material: Carbon Steel

Hardness: Through Hardened: 465HV1

Auveco Part No.	Bolt Size	O.D.	Unit Pkg.
19282	3/16" (5mm)	11/32"	50 (25 pr.)
19283	1/4" (6mm)	27/64"	50 (25 pr.)
19284	5/16" (8mm)	17/32"	50 (25 pr.)
19285	3/8" (10mm)	21/32"	50 (25 pr.)
19286	7/16" (11mm)	23/32"	30 (15 pr.)
19287	1/2" (12mm)	49/64"	20 (10 pr.)
19288	9/16" (14mm)	29/32"	20 (10 pr.)
19289	5/8" (16mm)	1"	20 (10 pr.)
19290	3/4" (20mm)	1-7/32"	10 (5 pr.)
19291	1" (25mm)	1-17-32"	10 (5 pr.)



External Lock Washers Zinc

Auveco Part No.	Bolt Size	O.D.	Unit Pkg.
5249	#4 (3/32")	1/4"	100
5250	#6 (1/8")	5/16"	100
5251	#8 (5/32")	3/8"	100
5252	#10 (3/16")	3/8"	100
5253	#12 (7/32")	15/32"	100
5254	#14 (1/4")	1/2"	100
5255	5/16"	19/32"	100
5256	3/8"	11/16"	100
5257	7/16"	3/4"	100
5258	1/2"	7/8"	100
16676	5/8"	1-1/32"	50
16677	3/4"	1-3/16"	50



Countersunk External Lock Washers Zinc

Auveco Part No.	Bolt Size	O.D.	Unit Pkg.
5270	#6 (1/8")	9/32"	100
5271	#8 (5/32")	5/16"	100
5272	#10 (3/16")	11/32"	100
5274	#14 (1/4")	7/16"	100



Internal Lock Washers Zinc

Auveco Part No.	Bolt Size	O.D.	Unit Pkg.
5259	#4 (3/32")	1/4"	100
5260	#6 (1/8")	9/32"	100
5261	#8 (5/32")	5/16"	100
5262	#10 (3/16")	3/8"	100
5263	#12 (7/32")	13/32"	100
5264	#14 (1/4")	15/32"	100
5265	5/16"	19/32"	100
5266	3/8"	11/16"	100
5267	7/16"	25/32"	100
5268	1/2"	7/8"	100
16672	5/8"	1-1/16"	100
16673	3/4"	1-7/32"	50
16675	1"	1-19/32"	10



**Internal-External
Combination
Lock Washers**
Zinc

Auveco Part No.	Bolt Size	O.D.	Unit Pkg.
17017	#6 (1/8")	1/2"	100
17018	#8 (5/32")	1/2"	100
17019	#10 (3/16")	9/16"	100
17020	#14 (1/4")	23/32"	100
17021	5/16"	7/8"	100
17022	3/8"	31/32"	100
17023	7/16"	1-1/32"	50
17024	1/2"	1-7/32"	50



**Natural Nylon Flat
Washers**

Auveco Part No.	Bolt Size	I.D. + .015	O.D. + .015	Thick. + .010	Unit Pkg.
13888	1/16"	.115"	.250"	.032"	100
13891	1/16"	.140"	.312"	.062"	100
13892	1/8"	.171"	.375"	.032"	100
13893	1/8"	.171"	.375"	.062"	100
13894	1/8"	.194"	.375"	.032"	100
13895	1/8"	.194"	.375"	.062"	100
13896	3/16"	.242"	.375"	.062"	100
13897	1/8"	.200"	.437"	.062"	100
13898	3/16"	.257"	.500"	.062"	100
13899	1/4"	.281"	.500"	.030"	100
13900	1/4"	.317"	.500"	.062"	100
13902	3/16"	.260"	.562"	.062"	100
13903	1/8"	.187"	.625"	.062"	50
13904	5/16"	.380"	.625"	.062"	50
13905	3/16"	.260"	.687"	.060"	50
13906	3/8"	.421"	.687"	.062"	50
13907	1/2"	.568"	.687"	.062"	50
13908	1/4"	.317"	.750"	.062"	50
13909	5/16"	.390"	.750"	.062"	50
13910	3/8"	.443"	.750"	.062"	50
13911	7/16"	.505"	.750"	.062"	50
13912	3/16"	.257"	.875"	.062"	50
13913	5/16"	.343"	.885"	.062"	50
13914	3/8"	.406"	1.000"	.062"	25
13916	7/16"	.516"	1.250"	.062"	25
13918	5/16"	.390"	1.260"	.062"	25
13919	7/16"	.500"	1.375"	.062"	25
13920	7/16"	.525"	1.375"	.125"	25
13921	5/8"	.665"	1.500"	.094"	25

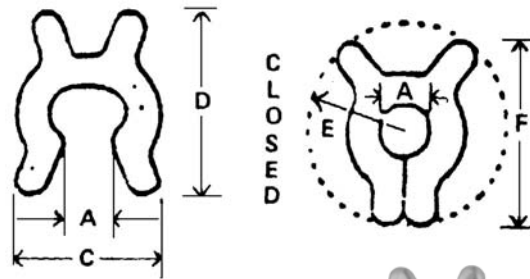

X-Washers
Zinc



Auveco Part No.	Material Thickness	A	C	D	E	F	Unit Pkg.
13691	.025	.086	.320	.406	.210	.406	50
13692	.055	.098	.364	.490	.297	.475	50
13693	.055	.130	.438	.576	.338	.558	50
13694	.065	.164	.523	.687	.422	.665	50
13695	.065	.190	.593	.745	.437	.730	25
13696	.075	.222	.622	.776	.469	.775	25
13697	.075	.256	.698	.905	.500	.890	25
13698	.075	.285	.822	.986	.563	.984	25
13699	.089	.317	.872	1.100	.609	1.078	25
13701	.089	.381	1.060	1.297	.797	1.281	10

Commercial tolerances all X-Washers

Illustrations actual size

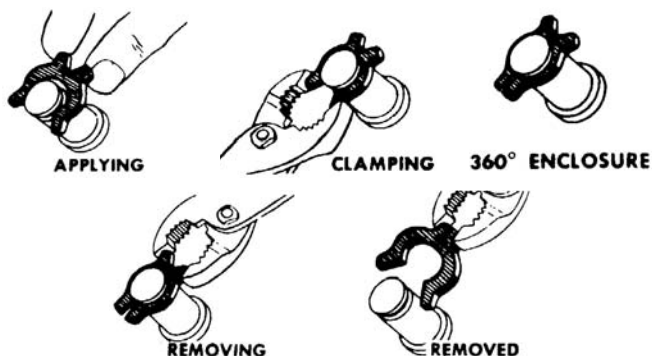
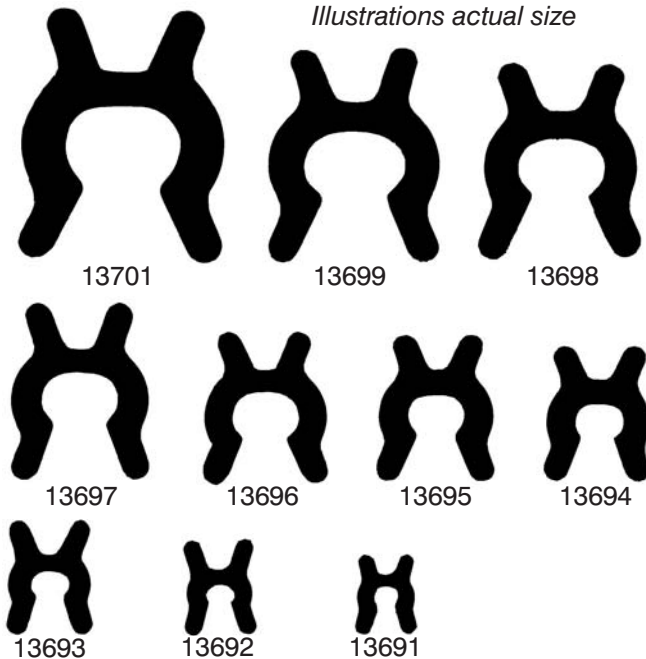

SHIMS

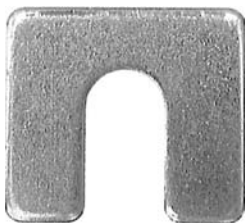

1-1/4" x 1-1/8"
Slot: 3/8"
Zinc

3155 Thick: 1/16" UNIT PKG: 100
3156 Thick: 1/8" UNIT PKG: 100



2" x 1-1/2"
Slot: 5/8"
Zinc

2999
1/8" Thick
UNIT PKG: 50



2" x 1-1/2"
Slot: 3/4"
Zinc

3000
Thick: 1/8"
UNIT PKG: 50



Outer Diameter: 15/16"
Slot: 3/8"
Zinc

20448 Thick: 1/16" UNIT PKG: 50
20449 Thick: 1/8" UNIT PKG: 50



1-3/8" x 1-1/4"
Slot: 5/8"
Zinc

20322
Thick: 1/8"
UNIT PKG: 50



1-3/4" x 1-1/4"
Slot: 1/2"
Zinc

8445
Thick: 1/8"
(10 Gauge Steel)
UNIT PACKAGE: 50

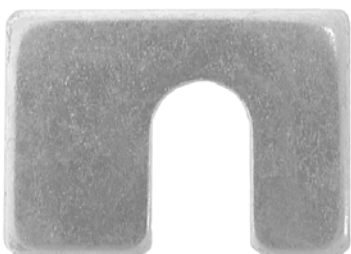

1-3/4" x 1-1/4"
Slot: 1/2"
Zinc

2452
Thick: 1/16"
UNIT PKG: 50

2453
Thick: 1/8"
UNIT PKG: 50



Universal Alignment Shim

1-3/16" x 1-15/32"
Slot: 5/8"
Zinc

Auveco Part No.	Thickness	Unit Pkg.
11187	1/32"	25



Caster and Camber and Ball Joints Ford

1-1/8" x 1-1/8"
Slot: 1/2"
Zinc

Auveco Part No.	Thickness	Unit Pkg.
5074	1/64"	50
5075	1/32"	50
5076	1/16"	50
5077	1/8"	50



Caster and Camber Shims Chevrolet and GMC Trucks

1-1/2" x 2-1/2"
Slot: 9/16"
Zinc

Auveco Part No.	Thickness	Unit Pkg.
5096	1/32"	50
5097	1/16"	50

Metric Basic Internal Retaining Rings

DIN 472 - 1300
Groove Required in Bore
Phosphate & Oil Finish

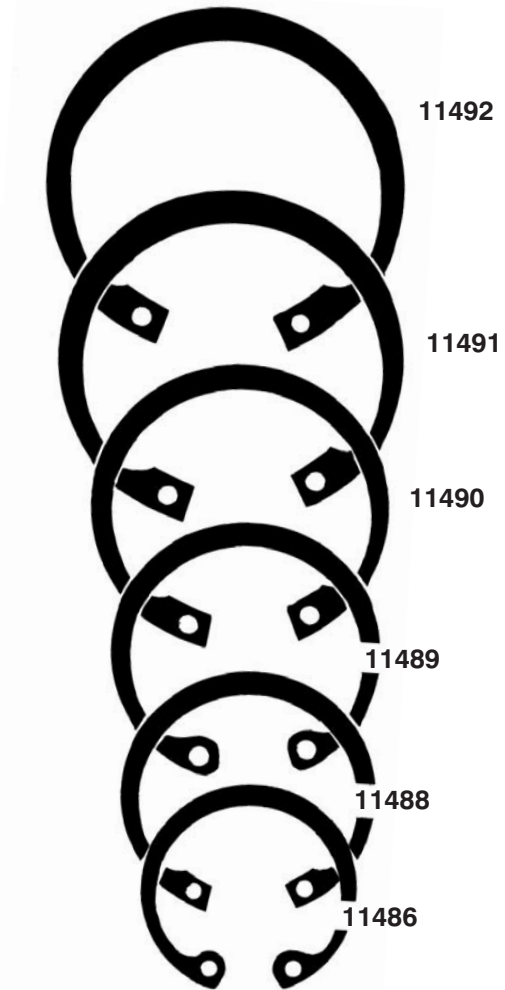
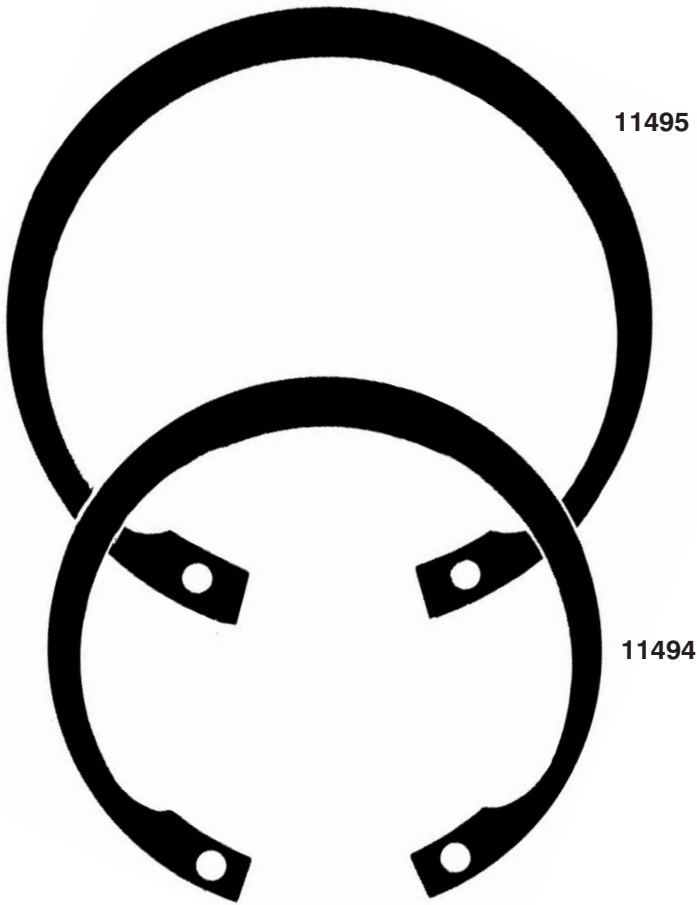

Auveco Part No.	Shaft Diameter		Groove Diameter		Groove Width		Unit Pkg.
	mm	Inches	mm	Inches	mm	Inches	
11486	26	1.024	27.2	1.072	1.30	.051	50
11488	30	1.181	31.4	1.237	1.30	.051	50
11489	32	1.260	33.7	1.328	1.30	.051	50
11490	35	1.378	37.0	1.457	1.60	.063	50
11491	40	1.575	42.5	1.675	1.85	.073	25
11492	42	1.654	44.5	1.753	1.85	.073	25
11494	52	2.047	55.0	2.165	2.15	.085	25
11495	62	2.441	65.0	2.559	2.15	.085	10

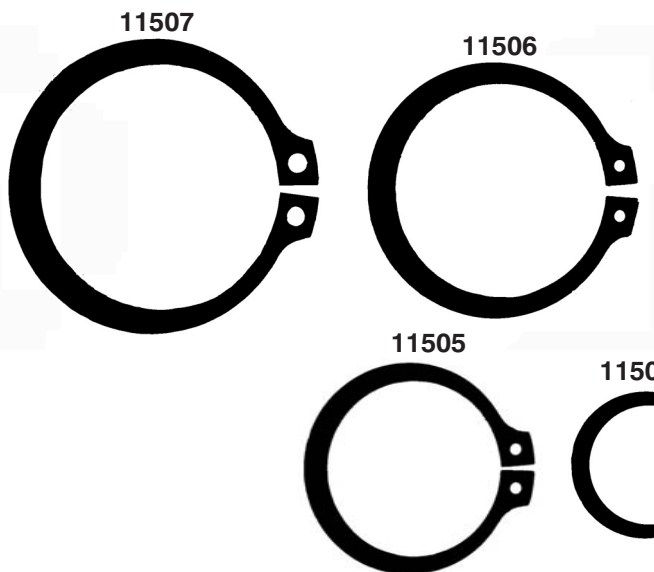

Metric Basic External Retaining Rings

DIN 471 - 1400

Groove Required on Shaft
Phosphate & Oil Finish

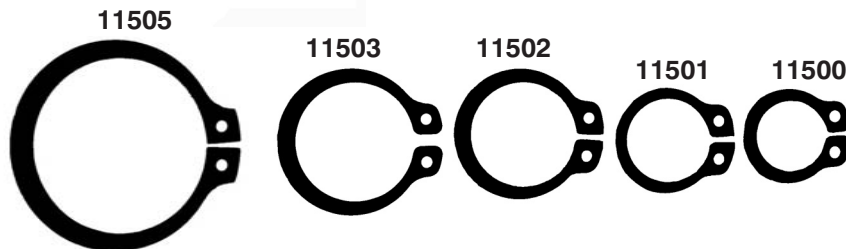

Auveco Part No.	Shaft Diameter		Groove Diameter		Groove Width		Unit Pkg.
	mm	Inches	mm	Inches	mm	Inches	
11500	10.0	.394	9.6	.378	1.10	.043	100
11501	12.0	.472	11.5	.452	1.10	.043	100
11502	15.0	.591	14.3	.563	1.10	.043	100
11503	17.0	.670	16.2	.637	1.10	.043	50
11505	25.0	.985	23.9	.941	1.30	.051	50
11506	30.0	1.182	28.6	1.126	1.60	.063	50
11507	35.0	1.378	33.0	1.299	1.60	.063	50

E Type Retaining Rings

DIN 6799 - 1500

Phosphate & Oil Finish



Auveco Part No.	Shaft Diameter		Groove Diameter		Groove Width		Unit Pkg.
	mm	Inches	mm	Inches	mm	Inches	
11513	1.4	.055	1.2	.047	0.34	.0134	100
11514	2.0	.079	1.5	.059	0.44	.0173	100
11515	2.5	.098	1.9	.075	0.54	.0213	100
11516	3.0	.118	2.3	.091	0.64	.0252	100
11517	4.0	.157	3.2	.126	0.64	.0252	100
11518	5.0	.197	4.0	.157	0.74	.0291	100
11519	6.0	.236	5.0	.197	0.74	.0291	100
11520	7.0	.276	6.0	.236	0.74	.0291	100
11521	8.0	.315	7.0	.276	0.94	.0370	100
11523	10.0	.394	9.0	.354	1.15	.0453	100
11527	20.0	.787	19.0	.748	1.85	.0728	50

Internal Self-Locking Retaining Rings



No Groove Required
Bright Zinc

Auveco Part No.	Shaft Diameter	Unit Pkg.
8715	3/16" - (.184 to .192 Shaft)	100

External Grip Rings

No Groove Required
Bright Zinc

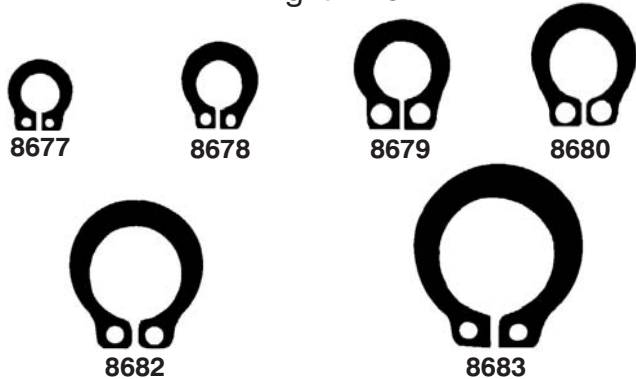

Auveco Part No.	Shaft Diameter	Unit Pkg.
8677	3/16" - (.185 to .189 Shaft)	50
8678	1/4" - (.248 to .252 Shaft)	50
8680	3/8" - (.373 to .379 Shaft)	50
8682	1/2" - (.497 to .503 Shaft)	50
8683	5/8" - (.622 to .628 Shaft)	50

Basic Internal Retaining Rings

Groove Required on Shaft
Bright Zinc

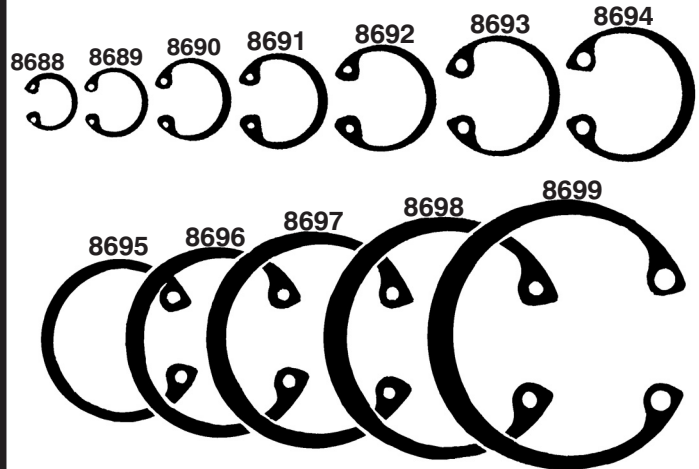

Auveco Part No.	Housing Dia.	Groove Dia.	Groove Width	Unit Pkg.
8688	1/4"	.268"	.020"	50
8689	5/16"	.330"	.020"	50
8690	3/8"	.397"	.029"	50
8691	7/16"	.461"	.029"	50
8692	1/2"	.530"	.039"	50
8693	9/16"	.596"	.039"	50
8694	5/8"	.665"	.039"	50
8695	3/4"	.796"	.039"	50
8696	7/8"	.931"	.046"	50
8697	1"	1.066"	.046"	50
8698	1-1/8"	1.197"	.056"	50
8699	1-1/4"	1.330"	.056"	50

Basic External Retaining Rings

Groove Required on Shaft
Zinc

Actual Size Illustrations to the right

Auveco Part No.	Shaft Diameter	Groove Diameter	Groove Width	Unit Pkg.	Auveco Part No.	Shaft Diameter	Groove Diameter	Groove Width	Unit Pkg.
8700	1/8"	.117"	.012"	50	8710	1"	.940"	.046"	50
8701	1/4"	.230"	.029"	50	10123	1-1/16"	.998"	.056"	50
10116	9/32"	.261"	.029"	50	8711	1-1/8"	1.059"	.056"	50
8702	5/16"	.290"	.029"	50	10124	1-3/16"	1.118"	.056"	50
10117	11/32"	.321"	.029"	50	8712	1-1/4"	1.176"	.056"	50
8703	3/8"	.352"	.029"	50	16743	1-5/16"	1.232"	.056"	50
10118	13/32"	.382"	.029"	50	16744	1-3/8"	1.291"	.056"	50
8704	7/16"	.412"	.029"	50	10125	1-1/2"	1.406"	.056"	25
8705	1/2"	.468"	.039"	50	16745	1-5/8"	1.529"	.068"	25
8706	9/16"	.530"	.039"	50	10126	1-3/4"	1.650"	.068"	25
8707	5/8"	.588"	.039"	50	16746	1-7/8"	1.769"	.068"	25
10120	11/16"	.646"	.046"	50	10127	2"	1.886"	.068"	10
8708	3/4"	.704"	.046"	50	16747	2-1/8"	2.003"	.086"	10
10121	13/16"	.762"	.046"	50	10128	2-1/4"	2.120"	.086"	10
8709	7/8"	.821"	.046"	50	16748	2-3/8"	2.239"	.086"	10
10122	15/16"	.882"	.046"	50	10129	2-1/2"	2.360"	.086"	10

For an assortment of Basic Internal and External Retaining Rings see Kit No. 6116 and Large Drawer Assortment No. 6507

BASIC EXTERNAL RETAINING RINGS

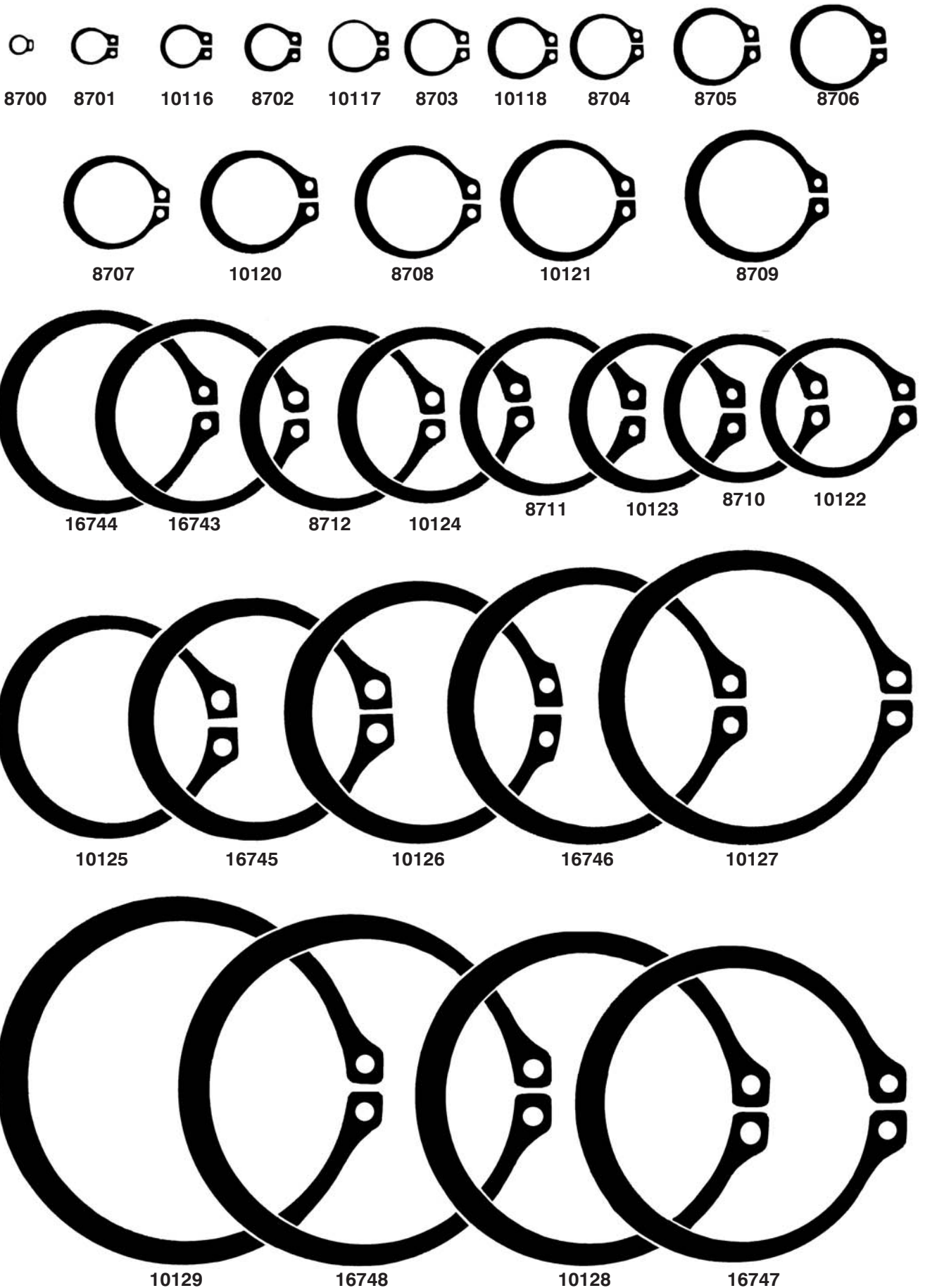

Reinforced E Type Retaining Rings

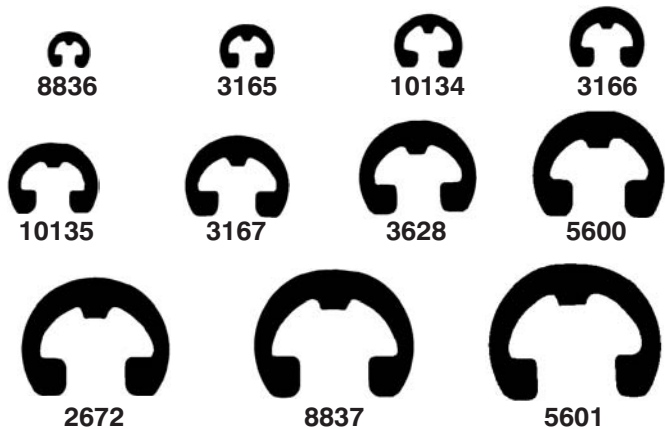

Auveco Part No.	Shaft Dia.	Groove Dia.	Groove Width	Unit Pkg.
8836	3/32"	.074"	.018"	100
3165	1/8"	.095"	.018"	100
10134	5/32"	.116"	.029"	100
3166	3/16"	.147"	.029"	100
10135	7/32"	.188"	.029"	100
3167	1/4"	.210"	.029"	100
3628	5/16"	.250"	.039"	100
5600	3/8"	.303"	.039"	100
2672	7/16"	.343"	.039"	100
8837	1/2"	.396"	.046"	100
5601	9/16"	.437"	.046"	100

E Type Retaining Rings

Phosphate & Oil

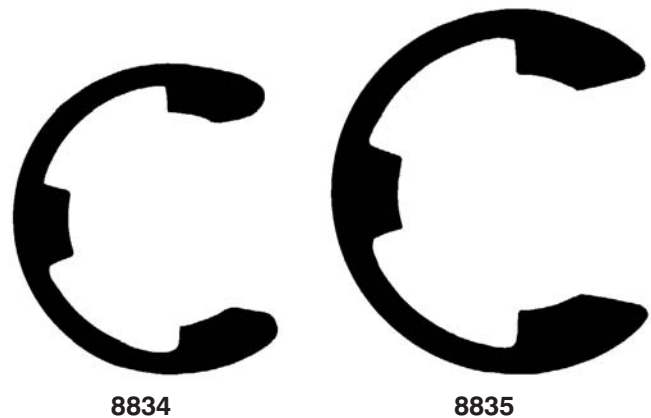
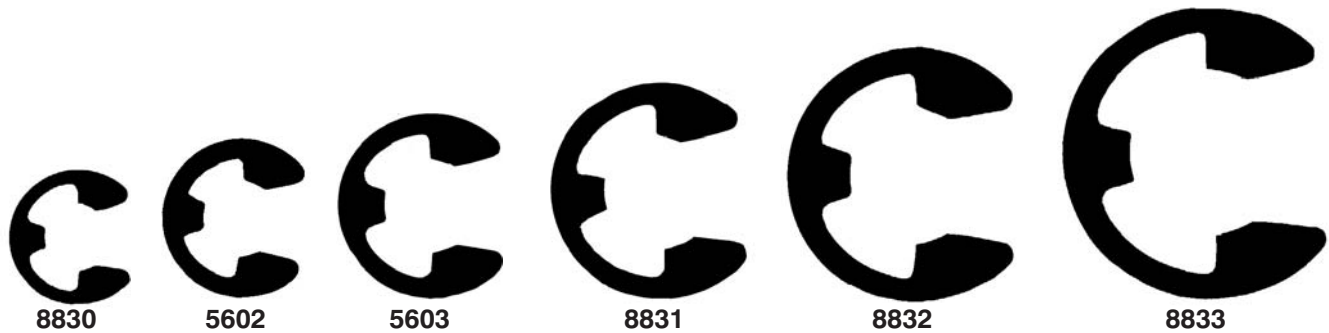

Auveco Part No.	Shaft Dia.	Groove Dia.	Groove Width	Unit Pkg.
8824	1/16"	.052"	.012"	100
8825	3/32"	.074"	.018"	100
8826	1/8"	.095"	.018"	100
10130	9/64"	.105"	.018"	100
10131	5/32"	.116"	.029"	100
10132	11/64"	.127"	.029"	100
8827	3/16"	.147"	.029"	100
10133	7/32"	.188"	.029"	100
8828	1/4"	.210"	.029"	100
3824	5/16"	.250"	.029"	100
8829	3/8"	.303"	.039"	100
8830	7/16"	.343"	.039"	100
5602	1/2"	.396"	.046"	100
5603	5/8"	.485"	.046"	100
8831	3/4"	.580"	.056"	50
8832	7/8"	.675"	.056"	50
8833	1"	.835"	.056"	50
8834	1-3/16"	1.079"	.068"	50
8835	1-3/8"	1.230"	.068"	50

For an assortment of E and Reinforced E Type Retaining Rings see Kit No. 6086, 6123 and Large Drawer 6508

Grooveless Retainer Ring

300 Series Stainless Steel

These Grooveless Retainer Rings press over studs, shafts or any round shape with a .375" diameter. They become an integral part of the axial application replacing snap or bearing rings and cotter pins. Designed without slots or shears, these rings will not "walk-off" or spring free.

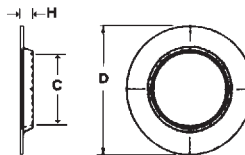

Auveco Part No.	Unit Pkg.	Stud Size	Outside Dia. (C)	Height (D)	Material Thickness (H)
14113	25	.375"	.625"	.030"	.010"

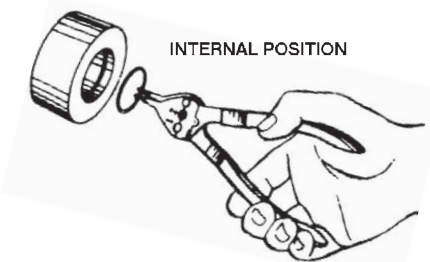

INTERNAL POSITION

Convertible Retaining Ring Pliers

For Internal and External Retaining Rings

Illustrations and photos not actual size

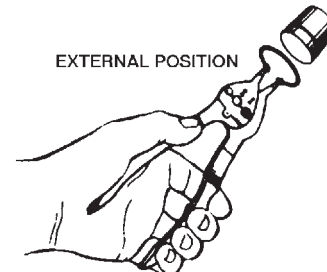

EXTERNAL POSITION



7909

Tip Diameter: .042"
Use with Auveco Retaining Rings:
8677 to 8678 (External)
8688 to 8697 (Internal)
8700 to 8709 (External)
10116 to 10121 (External)

UNIT PACKAGE: 1



7910

Tip Diameter: .070"
Use with Auveco Retaining Rings:
8679 to 8633 (External)
8698 & 8699 (Internal)
8710 to 8712 (External)
10122 to 10129 (External)
16743 to 16748 (External)

UNIT PACKAGE: 1

SPRINGS



Type 1



Type 2 (Double loop on both ends)



Type 3



Type 4

Extension Springs

Zinc

Photos not actual size



Type 5



Type 6

Auveco Part No.	Unit Pkg.	Type	Length Overall	Coil Length	O.D.	Wire Size	Lbs Rate /Inch	Approx. Lbs Load at Reference Ext.
14059	5	2	6.438"	5.575"	.438"	.048"	1.1	4.2 @ 8.437"
14060	5	1	6.500"	5.925"	.328"	.035"	7.5 oz.	2.2 @ 8.500"
14063	5	4	3.250"	2.750"	.375"	.041"	1.9	5.2 @ 5.250"
14064	5	1	4.00"	3.450"	.250"	.028"	13 oz.	1.9 @ 6.00"
14065	5	3	4.500"	3.575"	.484"	.063"	6.2	14 @ 6.500"
14066*	5	1	4.062"	2.750"	.734"	.062"	1.4	4.3 @ 6.062"
14067	5	3	4.00"	2.825"	.719"	.105"	12.5	36.5 @ 5.00"
14068	10	6	5.250"	3.000"	.531"	.062"	5.0	8.5 @ 6.250"
14070	5	5	2.656"	1.500"	.750"	.080"	10.3	12.5 @ 3.656"
14072	10	3	1.438"	.825"	.344"	.048"	15.0	10 @ 1.812"
14074	10	1	1.125"	.700"	.234"	.020"	12.0	9 oz. @ 1.625"

*Not Zinc Plated

Sec. 10

SPRINGS, PINS & CLIPS

Universal Springs

Galvanized • *Photos not actual size*

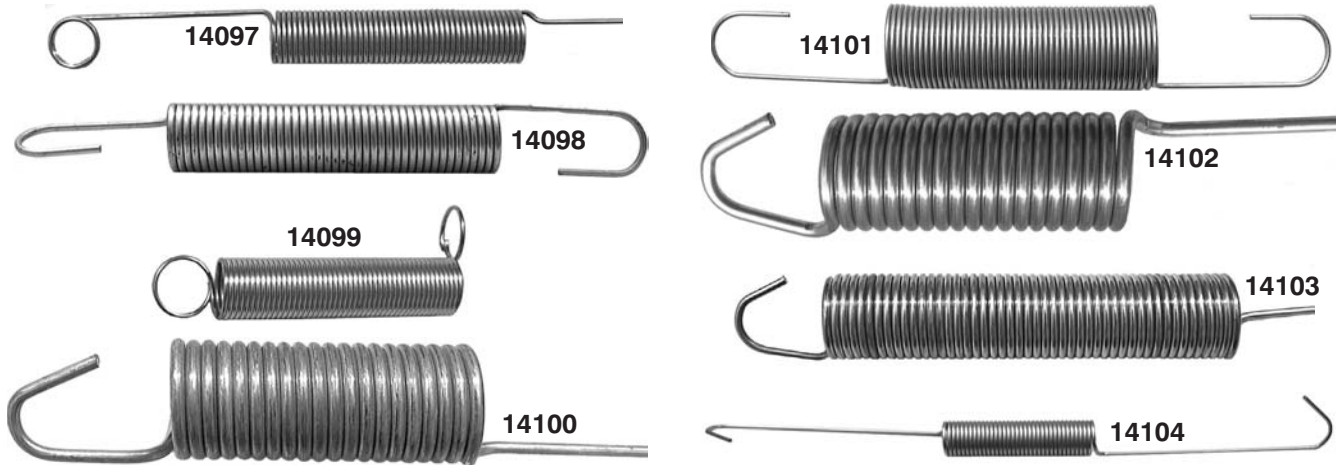

Auveco Part No.	Unit Pkg.	Length Overall	Coil Length	O.D.	Wire Size
14097	10	11-1/2"	1-7/8"	25/64"	1/32"
14098	10	4-3/8"	2-1/2"	1/2"	1/16"
14099	10	1-13/16"	1-1/2"	3/8"	1/32"
14100	10	8-1/2"	1-7/8"	3/4"	3/32"
14101	10	5-3/4"	2-3/8"	25/32"	3/64"
14102	10	18-1/2"	2"	13/16"	3/32"
14103	10	17-1/2"	3-1/2"	3/4"	1/16"
14104	10	8-1/4"	2"	7/16"	1/16"



Compression Springs

Zinc

Auveco Part No.	Unit Pkg.	Length Overall	O.D.	Wire Size	Approx. Solid Ht.	Lbs. Rate /Inch
14089	20	2.193"	.590"	.040"	.380"	3.1
14094*	20	.781"	.375"	.042"	.378"	7.4
14095	10	2.625"	.438"	.048"	.950"	6.0
14096	10	2.500"	.500"	.063"	1.00"	18.0

*Brass

Throttle Rod Clips

Black Phosphate



Left-hand Type



Right-hand Type

Auveco Part No.	Rod Diameter	Ind. Std.	Unit Pkg.
3609	5/32"	2	Right 100
3610	5/32"	2	Left 100
3611	3/16"	4	Right 100
3612	3/16"	4	Left 100
3613	1/4"	7	Right 100
3614	1/4"	7	Left 100

For an assortment of Throttle Rod Clips see Kit No. 6086.

Retainer Pins

Zinc

Photo not actual size



Auveco Part No.	Inside Diameter	Overall Length	Wire Dia.	Unit Pkg.
9114	1/16"	3/8"	.035"	100
9894	1/16"	19/32"	.045"	100
10390	7/64"	3/4"	.050"	100
9112	1/8"	1-1/8"	.070"	100
9110	3/16"	1-3/16"	.070"	100

PINS

Sec. 10

Hair Pin Cotter

Zinc



16934



16727



11872



10391



11873



10392



10393

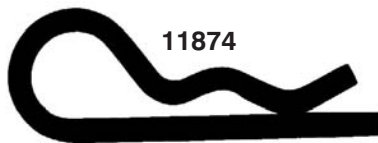

11874

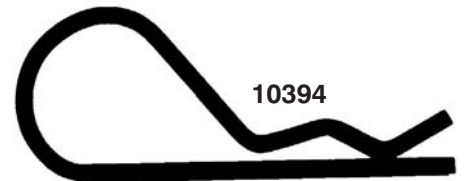

10394

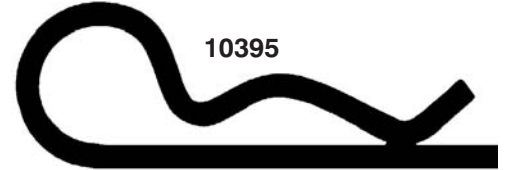

10395

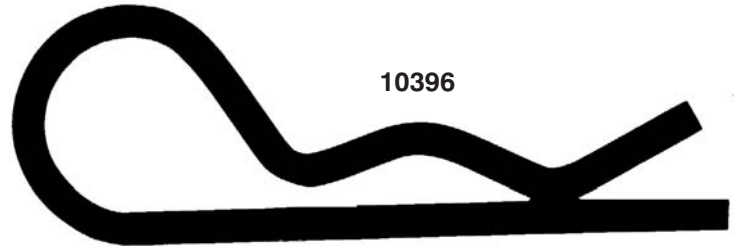

10396

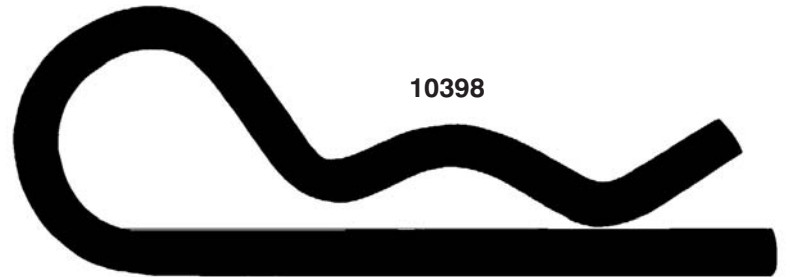

10398

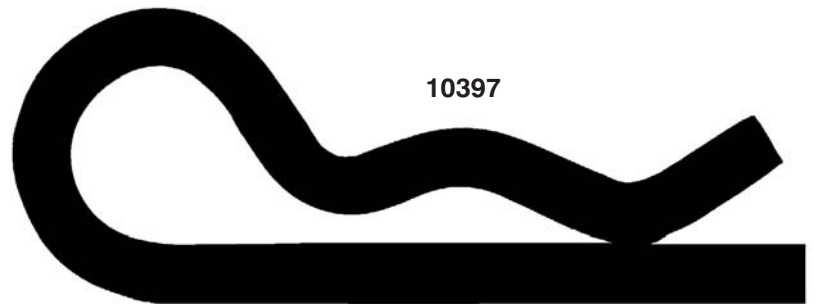

10397

Auveco Part No.	Wire Dia.	Drill Hole Size	Min. Shaft Dia.	Max Shaft Dia.	Overall Length	Inside Dia. of Eye	Unit Pkg.
16934	.042" (3/64")	3/64"	3/16"	1/4"	1"	1/4"	100
16727	.080" (5/64")	3/32"	1/4"	3/8"	1-3/16"	1/4"	100
11872	.080" (5/64")	3/32"	3/8"	1/2"	1-9/16"	5/16"	100
10391	.080" (5/64")	3/32"	3/8"	1/2"	1-9/16"	5/16"	100
11873	.062" (1/16")	5/64"	3/8"	1/2"	1-9/16"	5/16"	100
10392	.062" (1/16")	5/64"	3/8"	1/2"	1-9/16"	5/16"	100
10393	.125" (1/8")	9/64"	1/2"	3/4"	1-15/16"	7/16"	50
11874	.125" (1/8")	9/64"	1/2"	3/4"	1-15/16"	7/16"	50
10394	.093" (3/32")	7/64"	1/4"	5/8"	2-5/16"	5/8"	50
10395	.125" (1/8")	9/64"	5/8"	7/8"	2-1/2"	1/2"	25
10396	.177" (3/16")	3/16"	7/8"	1-1/4"	3-3/4"	7/8"	10
10398	.243" (1/4")	17/64"	3/4"	1"	4"	15/16"	10
10397	.310" (5/16")	21/64"	7/8"	1"	3-15/16"	7/8"	5

Hair Pin Cotter



3168



9890



2598



9892

Auveco Part No.	Inside Diameter	Overall Length	Wire Diameter	Unit Pkg.
3168	1/16"	23/64"	.025"	200
9890	3/32"	3/8"	.025"	100
2598	7/32"	3/4"	.060"	100
9892	5/16"	1"	.060"	100



Lynch Pins

Auveco Part No.	Pin Size	Ring I.D.	Ring O.D.	Unit Pkg.
11733	7/16" O.D. x 2-1/2" Long Black Powder Coated	1-7/8"	2-1/4"	5
11736	1/4" O.D. x 2-1/8" Long Zinc Plated	1-5/8"	1-7/8"	10



**Clevis Pins
Drilled for
Cotter Pins**
Zinc

Auveco Part No.	Dia.	Use Pin Dia.	Length Under Head to Ctr of Hole	Length Under Head to End of Pin
9433	1/4"	1/16"	29/32"	1"
9435	5/16"	3/32"	7/8"	1"
9436	5/16"	3/32"	1"	1-1/8"
9438	5/16"	3/32"	1-1/4"	1-3/8"
9440	3/8"	3/32"	7/8"	1"
9441	3/8"	3/32"	1"	1-1/8"
9443	3/8"	3/32"	1-1/8"	1-1/4"
9444	3/8"	3/32"	1-3/8"	1-1/2"
9446	1/2"	1/8"	1-11/32"	1-1/2"
9447	1/2"	1/8"	1-19/32"	1-3/4"

UNIT PACKAGE: 25

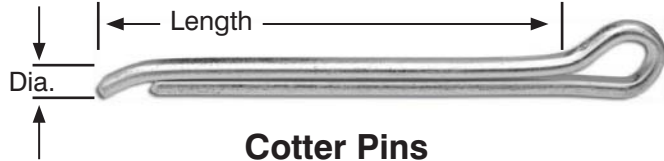

**Cotter Pins
Hammer-Lock Type
C 1008 Steel**

Auveco Part No. Plated	Auveco Part No. Plain	Size	Unit Pkg.
8477	3502	1/16" x 1/2"	200
8478	3503	1/16" x 3/4"	200
8479	3504	1/16" x 1"	200
14901	3505	1/16" x 1-1/4"	200
8480	3506	1/16" x 1-1/2"	200
	3508	1/16" x 2"	200
14903	3509	3/32" x 1/2"	200
8481		3/32" x 3/4"	200
8482	3511	3/32" x 1"	200
8483	3512	3/32" x 1-1/4"	200
8484	3513	3/32" x 1-1/2"	200
8485	3515	3/32" x 2"	200
14904	3519	1/8" x 3/4"	200
8486	3520	1/8" x 1"	200
8487	3521	1/8" x 1-1/4"	200
8488	3522	1/8" x 1-1/2"	200
8489		1/8" x 1-3/4"	200
8490	3524	1/8" x 2"	200
8491	3526	1/8" x 2-1/2"	200
8492		5/32" x 1"	100
14905	8506	5/32" x 1-1/4"	100
8493	8507	5/32" x 1-1/2"	100
14906	8508	5/32" x 1-3/4"	100
8494	8509	5/32" x 2"	100
14907	8511	5/32" x 2-1/2"	100
14908		5/32" x 3"	100
14909		3/16" x 1"	100
14910		3/16" x 1-1/4"	100
8495	8516	3/16" x 1-1/2"	100
8496	8518	3/16" x 2"	100
8497		3/16" x 2-1/2"	100
14911	8521	3/16" x 3"	100
8498		1/4" x 1-1/2"	100
8499		1/4" x 2"	100
8500		1/4" x 2-1/2"	100
8501	8530	1/4" x 3"	100
14912		1/4" x 4"	100
8502		5/16" x 2-1/2"	50
8503		5/16" x 3"	50

For assortments of Cotter Pins see Fix-Kit Assortment No. 6051, 6112 and Large Drawer (6500 Series) No. 6506

Yoke Ends

Drop Forged • Adjustable • Zinc Finish

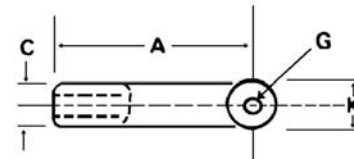
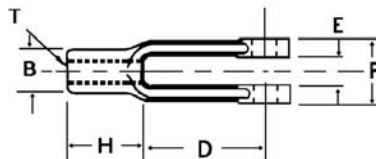
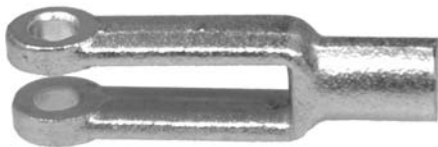

Auveco Part No.	"T" Tap Size	A	B	C	D	E	F	G	H	K	Unit Pkg.
10737	1/4"-28	2"	7/16"	7/16"	1-1/4"	9/32"	5/8"	1/4"	3/4"	1/2"	10
10788	1/4"-28	2"	7/16"	7/16"	1-1/4"	9/32"	5/8"	1/4"	3/4"	1/2"	2
10738	5/16"-24	2-1/4"	1/2"	1/2"	1-7/16"	11/32"	3/4"	5/16"	13/16"	19/32"	10
10789	5/16"-24	2-1/4"	1/2"	1/2"	1-7/16"	11/32"	3/4"	5/16"	13/16"	19/32"	2
10739	3/8"-24	2-1/2"	5/8"	5/8"	1-5/8"	7/16"	7/8"	3/8"	7/8"	11/16"	10
10790	3/8"-24	2-1/2"	5/8"	5/8"	1-5/8"	7/16"	7/8"	3/8"	7/8"	11/16"	2
10740	7/16"-20	2-7/8"	23/32"	23/32"	1-7/8"	1/2"	1"	7/16"	1"	13/16"	10
10791	7/16"-20	2-7/8"	23/32"	23/32"	1-7/8"	1/2"	1"	7/16"	1"	13/16"	2
10741	1/2"-20	3"	13/16"	13/16"	1-7/8"	9/16"	1-1/8"	1/2"	1-1/8"	15/16"	10
10792	1/2"-20	3"	13/16"	13/16"	1-7/8"	9/16"	1-1/8"	1/2"	1-1/8"	15/16"	2
10742	5/8"-18	4-15/16"	1-1/16"	1-1/16"	3-11/16"	11/16"	1-3/8"	5/8"	1-1/4"	1-3/16"	10
10793	5/8"-18	4-15/16"	1-1/16"	1-1/16"	3-11/16"	11/16"	1-3/8"	5/8"	1-1/4"	1-3/16"	2



Spring Pins

Zinc

Auveco Part No.	Dia.	Length	Wall Thick.	Unit Pkg.	Auveco Part No.	Dia.	Length	Wall Thick.	Unit Pkg.
8981	1/16"	3/16"	.012"	50	9019	3/16"	1/2"	.040"	50
8983	1/16"	1/2"	.012"	50	9021	3/16"	3/4"	.040"	50
8985	1/16"	3/4"	.012"	50	9022	3/16"	1"	.040"	50
8987	1/16"	1"	.012"	50	9023	3/16"	1-1/4"	.040"	50
8988	5/64"	1/4"	.018"	50	9024	3/16"	1-1/2"	.040"	50
8989	5/64"	1/2"	.018"	50	9025	3/16"	1-3/4"	.040"	50
8991	5/64"	3/4"	.018"	50	9026	3/16"	2"	.040"	50
8992	5/64"	1"	.018"	50	9027	7/32"	5/8"	.048"	50
8993	5/64"	1-1/4"	.018"	50	9028	7/32"	1-3/8"	.048"	50
8994	5/64"	1-1/2"	.018"	50	9029	7/32"	1-3/4"	.048"	50
8995	3/32"	5/16"	.022"	50	9030	1/4"	5/8"	.050"	50
8996	3/32"	1/2"	.022"	50	9031	1/4"	3/4"	.050"	50
8997	3/32"	5/8"	.022"	50	9033	1/4"	1"	.050"	50
8998	3/32"	3/4"	.022"	50	9034	1/4"	1-1/4"	.050"	50
8999	3/32"	7/8"	.022"	50	9035	1/4"	1-1/2"	.050"	50
9000	3/32"	1"	.022"	50	9036	1/4"	1-3/4"	.050"	50
9001	3/32"	1-1/4"	.022"	50	9037	1/4"	2"	.050"	50
9002	3/32"	1-1/2"	.022"	50	9038	1/4"	2-1/4"	.050"	50
9003	1/8"	3/8"	.028"	50	9039	1/4"	2-1/2"	.050"	50
9004	1/8"	1/2"	.028"	50	9040	5/16"	3/4"	.062"	50
9005	1/8"	5/8"	.028"	50	9042	5/16"	1"	.062"	50
9006	1/8"	3/4"	.028"	50	9043	5/16"	1-1/2"	.062"	50
9007	1/8"	7/8"	.028"	50	9044	5/16"	1-3/4"	.062"	25
9008	1/8"	1"	.028"	50	9045	5/16"	2"	.062"	25
9009	1/8"	1-1/4"	.028"	50	9046	5/16"	2-1/2"	.062"	25
9010	1/8"	1-1/2"	.028"	50	9048	3/8"	1"	.077"	25
9011	1/8"	1-3/4"	.028"	50	9049	3/8"	1-1/2"	.077"	25
9012	1/8"	2"	.028"	50	9050	3/8"	2"	.077"	25
9013	5/32"	1/2"	.032"	50	9051	3/8"	2-1/2"	.077"	25
9015	5/32"	3/4"	.032"	50					
9016	5/32"	1"	.032"	50					
9017	5/32"	1-1/4"	.032"	50					
9018	5/32"	1-1/2"	.032"	50					

For Spring Pin Assortments see Kits 6124, 6125 and Large Drawer (6500 Series) Assortment No. 6509 and 6510.

Sec. 10

PLUG BUTTONS

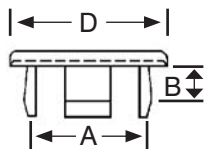

Nylon Hole Plug
Nylon 6/6 • Matte Finish



Auveco Part No.	Hole Size (A)	Panel Thickness (B)	Head Size (D)	Head Height	Color	Unit Pkg.
13863	3/16"	1/32"-9/64"	11/32"	.040"	Black	100
13864	1/4"	1/32"-1/16"	27/64"	.040"	Natural	100
13865	1/4"	1/32"-1/16"	27/64"	.040"	Black	100
13866	5/16"	1/32"-9/64"	29/64"	.050"	Natural	100
13867	5/16"	1/32"-9/64"	29/64"	.050"	Black	100
13869	3/8"	1/32"-9/64"	37/64"	.050"	Black	100
13871	7/16"	1/32"-11/64"	39/64"	.050"	Black	50
13872	1/2"	1/32"-9/64"	43/64"	.062"	Natural	50
13873	1/2"	1/32"-9/64"	43/64"	.062"	Black	50
13875	9/16"	1/32"-9/64"	47/64"	.062"	Black	50
13876	5/8"	1/32"-5/64"	51/64"	.062"	Natural	50
13877	5/8"	1/32"-5/64"	51/64"	.062"	Black	50
13879	11/16"	1/32"-7/64"	57/64"	.062"	Black	50
13880	3/4"	1/32"-7/64"	63/64"	.062"	Natural	50
13881	3/4"	1/32"-7/64"	63/64"	.062"	Black	50
13883	13/16"	1/32"-7/64"	1-1/32"	.062"	Black	50
13885	7/8"	1/32"-7/64"	1-5/64"	.062"	Black	50
13887	1"	1/32"-7/64"	1-7/32"	.062"	Black	50



Plastic Plug Buttons
Depressed Center
Black Polyethylene

Auveco Part No.	Hole Size	Head Dia.	Working Thickness	Unit Pkg.
9288	1/2"	7/8"	.02 -.07"	100
9289	3/4"	1-5/32"	.02 -.14"	100
9290	7/8"	1-1/4"	.02 -.10"	100
9291	1"	1-3/8"	.04 -.10"	100
9292	1-1/4"	1-5/8"	.04 -.10"	100
9293	1-1/2"	1-7/8"	.04 -.10"	100
17207	1-3/4"	2-1/8"	.15 -.17"	50
17208	2"	2-3/8"	.17 -.19"	50
18798	2-1/2"	3"	.15 -.17"	25
18799	3"	3-1/2"	.18 -.20"	10



Flush Sheet Metal Plugs
Fits 14 to 26 Gauge Material
Black Polyethylene

Auveco Part No.	Hole Size	Head Dia.	Unit Pkg.
14923	3/8"	3/4"	100
11746	1/2"	7/8"	100
18750	5/8"	1-3/64"	100
11747	3/4"	1"	100
11748	7/8"	1-5/32"	100
11749	1"	1-7/16"	100
18800	1-1/4"	1-5/8"	50
18801	1-1/2"	1-7/8"	25
18802	1-3/4"	2-1/8"	25
18803	2"	2-7/16"	10
18804	2-1/2"	3"	10
18806	3"	3-3/8"	5



Plug Buttons
Nickel Plated

Auveco Part No.	Hole Size	Head Dia.	Working Thickness	Unit Pkg.
3750	1/4"	13/32"	.035" -.062"	50
3751	3/8"	1/2"	.037" -.078"	50
3752	1/2"	21/32"	.037" -.062"	50
3753	5/8"	13/16"	.062" -.078"	50
3754	3/4"	15/16"	.037" -.093"	50
3755	7/8"	1-1/16"	.031" -.093"	50
3756	1"	1-1/8"	.062" -.093"	50
10231	1-1/4"	1-7/16"	.062" -.093"	10
10232	1-1/2"	1-21/32"	.038" -.141"	10

**FasTrack Web is your next step to savings.
Recover money spent on repair fasteners
during collision repair jobs.**

**Go to www.auveco.com to learn more about
Auveco's FasTrack Web
"Your body shop cost recovery system."**

BLACK NYLON LOCKING HOLE PLUGS



These hole plugs are designed with multiple locks to positively snap into panel thicknesses ranging from 1/64" to 1/8". Excellent for paintless dent repair. Made of heat stabilized nylon and suitable for elevated temperatures.

Auveco Part No.	Panel Hole Diameter	Maximum Panel Thickness	Plug Dimensions		Unit Pkg.
			Head Diameter	Thickness	
19764	3/16"	1/16"	1/4"	15/64"	100
18900	1/4"	1/16"	5/16"	5/16"	50
19765	5/16"	1/16"	3/8"	5/16"	50
18901	3/8"	1/8"	15/32"	13/32"	50
19766	7/16"	1/8"	17/32"	13/32"	50
18902	1/2"	1/8"	37/64"	13/32"	50
19767	9/16"	1/8"	21/32"	13/32"	50
18903	5/8"	1/8"	23/32"	13/32"	50
18904	3/4"	1/8"	59/64"	13/32"	50
19769	13/16"	1/8"	57/64"	13/32"	50
18905	7/8"	1/8"	1-1/64"	29/64"	50
18906	1"	1/8"	1-13/64"	29/64"	50
19770	1-3/32"	1/8"	1-7/32"	29/64"	50
19771	1-3/16"	1/8"	1-5/16"	29/64"	50
18907	1-1/4"	1/8"	1-3/8"	29/64"	50
19772	1-3/8"	1/8"	1-1/2"	29/64"	25
18908	1-1/2"	1/8"	1-43/64"	29/64"	25
18909	1-3/4"	1/8"	1-29/32"	29/64"	25
18910	2"	1/8"	2-9/64"	29/64"	25

KEYS

Woodruff Keys

1035 Carbon Steel • Plain



Auveco Part No.	Size	Unit Pkg.	Auveco Part No.	Size	Unit Pkg.
3877	(No. 3) 1/8" x 1/2"	100	3887	(No. 16) 3/16" x 1-1/8"	50
3878	(No. 5) 1/8" x 5/8"	100	3888	(No. 12) 7/32" x 7/8"	50
3879	(No. 7) 1/8" x 3/4"	100	3889	(No. 14) 7/32" x 1"	50
3880	(No. 4) 3/32" x 5/8"	100	3890	(No. 17) 7/32" x 1-1/8"	50
3881	(No. 6) 5/32" x 5/8"	100	3891	(No. A) 1/4" x 7/8"	50
3882	(No. 8) 5/32" x 3/4"	100	3892	(No. 15) 1/4" x 1"	50
3883	(No. 10) 5/32" x 7/8"	100	3893	(No. 18) 1/4" x 1-1/8"	50
3884	(No. 9) 3/16" x 3/4"	100	3894	(No. 21) 1/4" x 1-1/4"	50
3885	(No. 11) 3/16" x 7/8"	100	3895	(No. B) 5/16" x 1"	50
3886	(No. 13) 3/16" x 1"	50	3896	(No. C) 5/16" x 1-1/8"	50

Straight Keys

Plain



Auveco Part No.	Size	Unit Pkg.
Short Lengths		
9759	1/4" x 1/4" x 2-1/2"	10
Long Lengths		
9794	3/16" x 3/16" x 12"	5
9795	1/4" x 1/4" x 12"	5
9796	5/16" x 5/16" x 12"	5
9800	3/8" x 3/8" x 12"	5
9801	7/16" x 7/16" x 12"	5
9802	1/2" x 1/2" x 12"	5

Vinyl Vacuum Caps

Can be used for capping lines and hoses while testing carburetors, emission control systems, vacuum lines, etc.
Color coded for size identification.



Auveco Part No.	I.D.	Fits Tube O.D.	Color	Length	Unit Pkg.
18202	1/8"	3/16"	Blue	5/8"	50
18203	3/16"	1/4"	Red	5/8"	50
18204	1/4"	5/16"	White	5/8"	50
18205	5/16"	3/8"	Black	5/8"	50

Rubber Caps

Special Heat Resistant EPDM Rubber
Ford - GM - Chrysler



Can be used for capping lines and hoses while testing carburetors, emission control systems, vacuum lines, etc

Auveco Part No.	Fits Tube O.D.	Inside Length	Unit Pkg.
12209	1/8"	9/16"	25
4440	3/16"	9/16"	25
16264	3/16"	9/16"	100
19000	3/16"	1-1/4"	25
4439	1/4"	9/16"	25
19001	1/4"	1-1/4"	25
19002	5/16"	9/16"	25
12907	5/16"	1-1/4"	25
12210	3/8"	31/32"	25
19003	3/8"	1-1/2"	25
12908	1/2"	11/16"	10

NYLON CONNECTORS



12929

1/8" x 1/8"
Connector

UNIT PACKAGE: 10



12930

1/8" x 3/16"
Connector

UNIT PACKAGE: 10



12936

1/8" x 1/4"
Connector

UNIT PACKAGE: 10



12937

3/16" x 3/16"
Connector

UNIT PACKAGE: 10



12935

3/16" x 1/4"
Connector

UNIT PACKAGE: 10



12931

1/4" x 1/4"
Connector

UNIT PACKAGE: 10

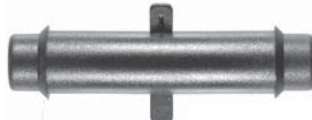

12946

5/16" x 5/16"
Connector

UNIT PACKAGE: 10



12938

3/8" x 1/4"
Connector

UNIT PACKAGE: 10



12934

3/8" x 3/8"
Connector

UNIT PACKAGE: 10



18835

(E1ZE-9E499-EA)

3/16" All Ends
Emission Harness Connector
Ford

UNIT PACKAGE: 25

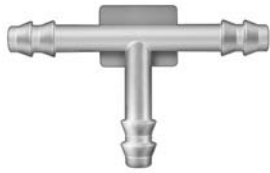

12923
1/8" All Ends Tee
UNIT PACKAGE: 10



10697
1/8" All Ends Tee
UNIT PACKAGE: 10



12916
1/8" x 3/16" x 1/8" Tee
UNIT PACKAGE: 10



12924
1/8" x 3/16" x 3/16" Tee
UNIT PACKAGE: 10



12926
3/16" x 3/16" x 1/8" Tee
UNIT PACKAGE: 10



12917
1/8" x 1/8" x 1/4" Tee
UNIT PACKAGE: 10



12918
3/16" All Ends Tee
UNIT PACKAGE: 10

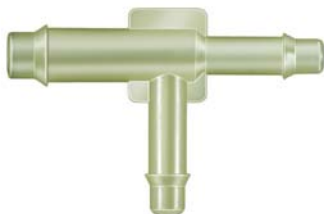

12919
1/4" x 3/16" x 3/16" Tee
UNIT PACKAGE: 10

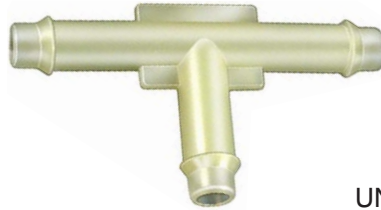

17629
1/4" All Ends Tee
UNIT PACKAGE: 10



11738
1/4" x 1/4" x 3/16" Tee
UNIT PACKAGE: 10



12921
3/8" x 3/8" 1/4" Tee
UNIT PACKAGE: 10



12922
1/4" x 3/8" x 3/8" Tee
UNIT PACKAGE: 10



12920
5/16" All Ends Tee
UNIT PACKAGE: 10



12925
3/8" All Ends Tee
UNIT PACKAGE: 10

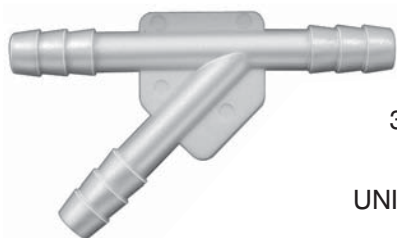

12927

3/16" All Ends
Y Connector

UNIT PACKAGE: 10



12943

1/4" All Ends
Y Connector

UNIT PACKAGE: 10



12944

5/16" All Ends
Y Connector

UNIT PACKAGE: 10



12947

1/8" x 3/16"
Elbow

UNIT PACKAGE: 10



12932

3/16" x 3/16"
Elbow

UNIT PACKAGE: 10



18836

(E1ZE-9E499CA)

5/32" x 5/32" x 8/16"
Emission Harness
Elbow Connector
Ford

UNIT PACKAGE: 25



12948

3/16" x 1/4"
Elbow

UNIT PACKAGE: 10



12933

1/4" x 1/4"
Elbow

UNIT PACKAGE: 10



12940

3/16" All Ends
F Connector

UNIT PACKAGE: 10



12939

3/16" All Ends
Cross Connector

UNIT PACKAGE: 5



11419

3/16" All Ends
4 Way Connector

UNIT PACKAGE: 25



12949

3/16" All Ends
5 Way Tee

UNIT PACKAGE: 5

Nylon Connectors Cross Reference O.E.M. Number Chart

Auveco Part No.	OEM No.	Auveco Part No.	OEM No.	Auveco Part No.	OEM No.
11419	GM: 560692, 22508803 Ford: 383847-S	12924	GM: 14017780	12935	GM: 1621253, 472812 Ford: 800843 AMC: 3239826
11738	GM: 3963228	12925	GM: 14023108 Ford: 388131-S		
12916	GM: 14025274, 14031144 Ford: 383016 Chry: 4241362	12926	GM: 14031114	12936	GM: 14017702
12917	GM: 1610403	12927	GM: 10003617, 22508052 Ford: 383031 AMC: 3236813	12937	GM: 560625, 22508051 Ford: 383003, 389138 Chry: 4104998
12918	GM: 357020, 272766, 22508050 Ford: 373846-S Chry: 3671410 AMC: 3673945	12928	GM: 14046514	12938	Ford: E0VE-9K319AB
12919	GM: 1617333, 10003294 Ford: 388034 12920 GM: 6466355 Chry: 4167810	12929	GM: 14047034 Ford: 383000 Chry: 4095145	12939	GM: 354400 Ford: 387042 Chry: 4241054
12921	GM: 472814 Ford: D9AE-9E645AA	12930	GM: 14017701 Ford: 383001 Chry: 3441743, 4241296	12940	GM: 14029095
12922	GM: 472815 Ford: 801471	12931	GM: 1614858, 14004876, 10017487 Ford: 383005	12941	GM: 14031149
12923	GM: 14017705 Ford: 3895904 Chry: 3751212	12932	GM: 556992, 14031145, 22508049 Ford: 387065 Chry: 4100727	12943	GM: 10004121 Chry: 4019472 AMC: 4006848
		12933	Ford: 387074	12944	Chry: 4179982
		12934	GM: 22505958 Chry: 4201198	12946	Chry: 4179981
				12947	GM: 14017779
				12948	Ford: 387980
				12949	Ford: 384111 AMC: 3237451



Nylon Hose Connectors

Barbed on Both Ends

Auveco Part No.	Hose Size	Unit Pkg.
10101*	1/8" x 1/8"	10
10102	3/16" x 3/16"	10
10103	1/4" x 1/4"	10
10104	5/16" x 5/16"	10
10105	3/8" x 3/8"	10
16961	1/2" x 1/2"	10

*Single barb on each end



Nylon Reducer Connectors

Barbed on Both Ends

Auveco Part No.	Hose Size	Unit Pkg.
10106	1/4" x 3/16"	10
10107	3/8" x 1/4"	10



Nylon Tubing & Hose Tee Connectors

Barbed on All Ends

Auveco Part No.	Hose Size I.D.	Unit Pkg.
10108	5/32" x 5/32" x 5/32"	10
10109	3/16" x 3/16" x 3/16"	10
10110	1/4" x 1/4" x 1/4"	10
14813	5/16" x 5/16" x 5/16"	10
11228	3/8" x 3/8" x 3/8"	10
11229	1/2" x 1/2" x 1/2"	10



11321

Butyrate

Universal Tubing Connector

For 1/8", 1/4" or 3/8"

For use with Vacuum and Windshield Washer Tubing

Not for use in Fuel Line

UNIT PACKAGE: 10

Photos are not actual size

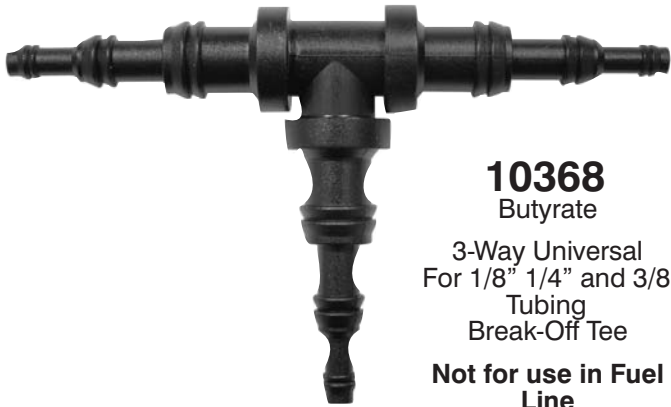

10368
Butyrate
3-Way Universal
For 1/8" 1/4" and 3/8"
Tubing
Break-Off Tee
**Not for use in Fuel
Line**

UNIT PACKAGE: 5



11224
Non-Corrosive
Black Polyethylene
High-Density Tubing and Hose Elbows
Barbed on Both Sides
Hose Size: 3/8" x 3/8" I.D.

UNIT PACKAGE: 10



16654
Santoprene Rubber
4mm All Ends

UNIT PACKAGE: 25



11226
Non-Corrosive
Black Polyethylene
High-Density Tubing and
Hose Tee Connectors
Pipe Thread: 1/4"
Hose Size: 1/4" x 1/4" I.D.

UNIT PACKAGE: 10



11220
Non-Corrosive
Black Polyethylene
High-Density Tubing and Hose Elbows
Pipe Thread: 1/4"
Hose Size: 3/8" I.D.

UNIT PACKAGE: 10

AIRLINE COUPLINGS

210 Series: Push-to-connect, pin-type hose couplings designed for one-way shutoff in 1/4" capacity. **Average flow:** 18 cfm at 90 PSIG (6.2 bar) inlet and 10 PSIG (0.69 bar) pressure drop. Maximum inlet pressure: 250 PSIG (17 bar). Zinc chromate finish.



16045
1/4" Female NPT
UNIT PKG: 5



16046
1/4" Male NPT
UNIT PKG: 5



16049
1/4" Female NPT
UNIT PKG: 5



16051
1/4" Male NPT
UNIT PKG: 5



16052
1/4" Hose Stem I.D.
UNIT PKG: 5

MS Series: For use with industrial interchange style connectors. Push-to-connect type designed for one-way shutoff in 1/4" capacity. **Average flow:** 36 cfm at 90 PSIG (6.2 bar) inlet and 10 PSIG (0.69 bar) pressure drop. Maximum inlet pressure: 250 PSIG(17 bar). Zinc Chromate finish.



16066
1/4" Female NPT
UNIT PKG: 5



16067
1/4" Male NPT
UNIT PKG: 5



16070
1/4" Female NPT
UNIT PKG: 5



16071
1/8" Male NPT
UNIT PKG: 5



16072
1/4" Male NPT
UNIT PKG: 5

Photos are not actual size



19576

Safety lever blow gun easily controls air flow. Ideal for hundreds of automotive and industrial uses in small or large industrial plants, service stations, garages, etc. Zinc alloy and brass construction. Meets OSHA 150 PSI Inlet, Max. Nozzle 30 PSI SCFM 10.0 @ 100 PSI. 1/4" NPT air inlet.

UNIT PACKAGE: 1

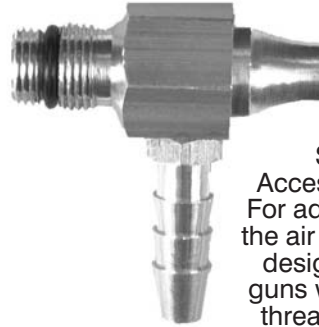

19578

Siphon Spray Nozzle. Accessory for 19577 Blow Gun. For adding moisture or solvent to the air stream. Unique dual thread design permits use on all blow guns with 7/16"-27 and 1/8" NPS threads. O-ring seal creates an air-tight assembly. Aluminum body construction.

UNIT PACKAGE: 1



19577

Compact safety lever blow gun. Includes a safety nozzle and a non-safety rubber tip nozzle. Features an easy to use hang-up hook. Chrome plated zinc alloy construction. Meets OSHA 150 PSI Inlet, Max. Nozzle 30 PSI. Safety tip SCFM 11.7 @ 100 PSI. Non-safety tip 12.9 @ 100 PSI. 1/4" NPT air inlet

UNIT PACKAGE: 1



19579

Rubber Blow Gun Tip. Accessory for 19577 Blow Gun. For positive leak-proof connection when blowing out any fluids where a metal tip could mar the finish. Unique dual thread design permits use on all blow guns with 7/16"-27 and 1/8" NPS threads. O-ring seal creates an air-tight assembly. Brass body construction.

UNIT PACKAGE: 2

Clear Flexible Vinyl (PVC)

Our tubing has a broad range of chemical resistance to acids, alkalies and solvents. It's ideal for use in industrial air pressure line applications, in the food industry (FDA approved), for potable water, and for various gases and chemicals. Not for use with gasoline.



The Clear Flexible Tubing can be used with our connectors which are cataloged on page 200. The tubing can also be installed with our Hose Clamps (refer to the alphabetical index).

Auveco Part No.	I.D.	O.D.	Wall Thickness	*Maximum Suggested Working Pressure (PSI @ 70 F)	Unit Pkg.
14801	1/8"	1/4"	1/16"	59	100 Ft.
14802	3/16"	5/16"	1/16"	51	100 Ft.
14803	1/4"	3/8"	1/16"	51	100 Ft.
14804	5/16"	7/16"	1/16"	48	100 Ft.
14805	3/8"	1/2"	1/16"	41	100 Ft.
14807	1/2"	5/8"	1/16"	28	100 Ft.
14808	1/2"	3/4"	1/8"	41	100 Ft.

*We recommend verification by testing of the size and material to be used.

Red Air Hose

Photo not actual size



Male Brass Fitting

Four spiral reinforced EPDM rubber construction offers superior durability and excellent flexibility. Limited oil resistance. Coupled with brass fittings. Maximum working pressure is 300 P.S.I.

Auveco Part No.	I.D.	Description	Unit Pkg.
		Impact Tool Air Hose	
15538	3/8"	1/4" Male Pipe Thread Fittings	25' Roll
15539	3/8"	1/4" Male Pipe Thread Fittings	50' Roll

Black O.E.M. Heater Hose



Meets or exceeds SAE20R3 specifications. O.E.M. grade EPDM hose that withstands the abuse of corrosive additives, heat, cold, ozone, weather and abrasion

Auveco Part No.	I.D.	Unit Pkg.
15540	1/2"	50' Roll
15541	5/8"	50' Roll
15542	3/4"	50' Roll

Vacuum and Windshield Washer Tubing



Meets SAE J1037 Type 2 Specifications
EPDM Rubber

Auveco Part No.	I.D.	O.D.		Unit Pkg.
4453	7/64"	9/32"	Fits 1/8" Nipple	25'
4454	7/64"	9/32"	Fits 1/8" Nipple	50'
4456	5/32"	5/16"	Fits 3/16" Nipple	25'
4457	5/32"	5/16"	Fits 3/16" Nipple	50'
4459	7/32"	13/32"	Fits 1/4" Nipple	25'
4460	7/32"	13/32"	Fits 1/4" Nipple	50'
4462	9/32"	15/32"	Fits 5/16" Nipple	25'
4463	9/32"	15/32"	Fits 5/16" Nipple	50'

For a complete listing of Barbed Brass Fittings see page 238.

Electronic Fuel Injection Hose



Meets or exceeds SAE 30R9 specifications. Quality fluoroelastomer tube and CM cover handles virtually every fuel on the market. Burst strength exceeds 900 PSI. 180 PSI working pressure

Auveco Part No.	Size	Use with Auveco Clamp No.	Unit Pkg.
19271	1/4" I.D. x 1/2" O.D.	15860	10 ft.
19272	5/16 I.D. x 9/16" O.D.	15861	10 ft.
19273	3/8" I.D. x 5/8" O.D.	15862	10 ft.



Fuel Line Hose

Not for Electronic Fuel Injection

Meets the following O.E.M. Specifications:
GM: 6165-M • SAE J30R7 • Chrysler MSEA219

Auveco Fuel Line Hose is of the highest quality and meets all O.E.M. specifications. It has a special chemical resistant interior, a single braid, and a neoprene exterior for maximum life and durability. For temperature range from -29°F to 257°F.

Auveco Hose is designed for gas and diesel fuel lines (except Electronic Fuel Injection), emission control devices, and crankcase ventilation. In addition to the automotive applications, this hose is widely used on lawn mowers, marine motors, tractors and construction equipment to mention only a very few.

Auveco Part No.	Size	Working Pressure	Unit Pkg.
17085	3/16" I.D. x 13/32" O.D.	50 PSI	25'
4464	1/4" I.D. x 1/2" O.D.	50 PSI	25'
4465	1/4" I.D. x 1/2" O.D.	50 PSI	50'
4466	5/16" I.D. x 9/16" O.D.	50 PSI	25'
4467	5/16" I.D. x 9/16" O.D.	50 PSI	50'
4468	3/8" I.D. x 5/8" O.D.	35 PSI	25'

For a complete listing of Barbed Brass Fittings see page 292.

20900

Hose Cutter



Razor sharp blade cleanly cuts heater hoses, fuel line hoses and any other type of flexible hose up to 1-1/4" diameter.

The stainless steel blade is reversible for double the life.

The pliers are made of glass-filled gray nylon for strength. Includes a locking hoop for safe storage.

Overall length: 9-1/2"

UNIT PACKAGE: 1

SOLDERLESS TERMINALS

Nylon Insulated • Our Finest

Sec. 12

Nylon Insulated with Insulation Grip

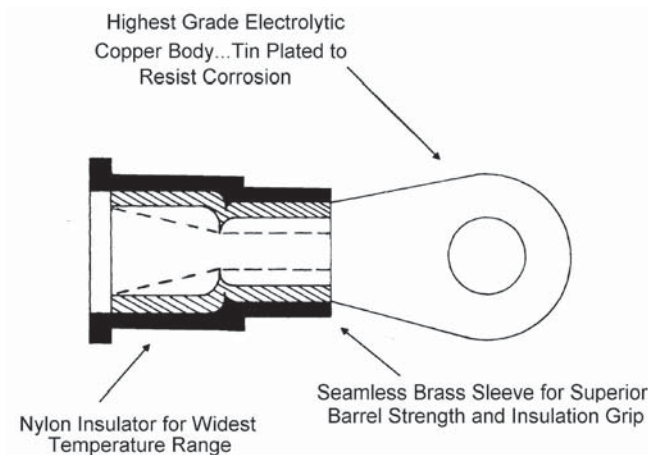

- Superior vibration resistance with insulated grip
- Superior barrel strength
- Constructed to meet the highest military and industrial standards

22-18 Gauge Wire Range (Red)

Actual Size	Stud Size	Auveco Part No.	Unit Pkg.
	#4 - #6	12149	25
	#8 - #10	12150	25
	#12 - 1/4"	17041	50
	#8 - #10	12163	25
	#4 - #6	12164	25
	Butt Connector	5791 16487	50 1000

16-14 Gauge Wire Range (Blue)

Actual Size	Stud Size	Auveco Part No.	Unit Pkg.
	#4 - #6	9052	25
	#8 - #10	9055	25
	#12 - 1/4"	9056	25

16-14 Gauge Wire Range (Blue)

Actual Size	Stud Size	Auveco Part No.	Unit Pkg.
	1/4" - 5/16"	9057	25
	5/16" - 3/8"	9058	25
	#4 - #6	9059	25
	#8 - #10	9060	25
	#8 - #10	9064	25
	Butt Connector	5792 16488	50 1000
	1/4" Female Quick Connect	12148	25
	1/4" Male Quick Connect	12147	25

12-10 Gauge Wire Range (Yellow)

Actual Size	Stud Size	Auveco Part No.	Unit Pkg.
	#8 - #10	12151	25
	#12 - 1/4"	12152	25
	5/16" - 3/8"	12153	25
	#8 - #10	12162	25
	Butt Connector	5793 16489	50 500

SOLDERLESS TERMINALS

Vinyl Insulated • Copper • Electro Tin Plated
 For an assortment of Solderless Terminals see the Fix-Kits in the green pages

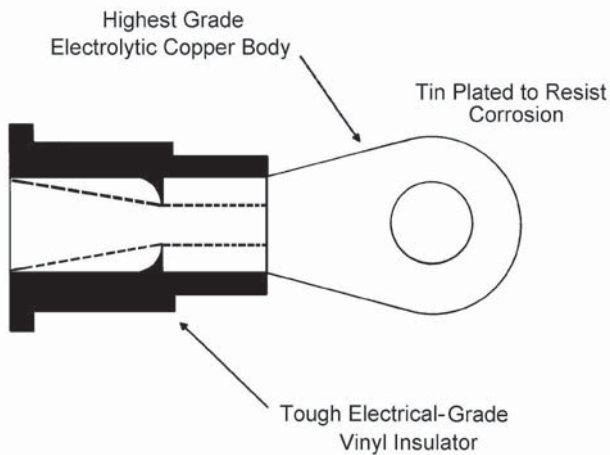

- Funnel barrel for easy wire insertion
- Friction groove in barrel resists wire pullout
- Heat treated for maximum strength

22-18 Gauge Wire Range (Red)

Actual Size	Stud Size	Auveco Part No.	Unit Pkg.
	#4 - #6	5021	100
	#8 - #10	5023	100
	#12 - 1/4"	17040	50
	#4 - #6	5033	100
	#8 - #10	5034	100
	#4 - #6	5038	100
	Butt Connector	5047 16484	100 1000
	Closed End Butt Connector 22-14 Ga.	9065	100

16-14 Gauge Wire Range (Blue)

Actual Size	Stud Size	Auveco Part No.	Unit Pkg.
	#4 - #6	5024	100
	#8 - #10	5026	100

16-14 Gauge Wire Range (Blue)

Actual Size	Stud Size	Auveco Part No.	Unit Pkg.
	#12 - 1/4"	5027	100
	5/16" - 3/8"	12144	25
	#4 - #6	5035	100
	#8 - #10	5036	100
	#8 - #10	5040	100
	Butt Connector	5048 16485	100 1000
	Closed End Butt Connector 16-10 Ga.	5072	100

12-10 Gauge Wire Range (Yellow)

Actual Size	Stud Size	Auveco Part No.	Unit Pkg.
	#8 - #10	5028	100
	#12 - 1/4"	5029	100
	1/4" - 5/16"	5030	100
	5/16" - 3/8"	5031	100
	7/16" - 1/2"	5032	100

SOLDERLESS TERMINALS

Vinyl Insulated • Copper - Electro Tin Plated

For an assortment of Solderless Terminals see the Fix-Kits in the green pages

12-10 Gauge Wire Range (Yellow)

Actual Size	Stud Size	Auveco Part No.	Unit Pkg.
	#8 - #10	5037	100
	#8 - #10	5041	100
	Butt Connector	5049 16486	100 500
	3-Way Connector	5056	25



8 Gauge Wire Range (Red)

Actual Size	Stud Size	Auveco Part No.	Unit Pkg.
	#12 - 1/4"	17042	25
	1/4" - 5/16"	17043	25
	5/16"-3/8"	17044	25
	7/16" - 1/2"	17045	15
	Butt Connector	17037	10

6 Gauge Wire Range (Blue)

Actual Size	Stud Size	Auveco Part No.	Unit Pkg.
	#12 - 1/4"	17046	15
	1/4" - 5/16"	17047	15
	5/16" - 3/8"	17048	15
	7/16" - 1/2"	17049	10
	Butt Connector	17038	10

4 Gauge Wire Range (Yellow)

Actual Size	Stud Size	Auveco Part No.	Unit Pkg.
	5/16"-3/8"	17052	10
	Butt Connector	17039	10



Quick-Connect Terminals

1/4" Female Terminals Vinyl Insulated

Actual Size	Wire Size	Auveco Part No.	Unit Pkg.
 Red	22-18 Ga.	12155	25
 Blue	16-14 Ga.	5068	100
 Yellow	12-10 Ga.	12157	25

Quick-Connect Terminals

Fully Insulated Nylon Mating 1/4" Quick-Connects

Actual Size	Wire Size	Auveco Part No.	Unit Pkg.
	22-18 Ga. Female Red	11827	50
	22-18 Ga. Male Red	11828	50
	16-14 Ga. Female Blue	11606	50
	16-14 Ga. Male Blue	11605	50
	12-10 Ga. Female	11829	25
	12-10 Ga. Male Yellow	11830	25





Quick-Connect Terminals

1/4" Male Tabs • Vinyl Insulated

Actual Size	Wire Size	Auveco Part No.	Unit Pkg.
 Red	22-18 Ga.	12154	25
 Blue	16-14 Ga.	5067	100
 Yellow	12-10 Ga.	12156	25



Quick-Connect Terminals

.187 (3/16") Sizes • Vinyl Insulated

Actual Size	Wire Size	Auveco Part No.	Unit Pkg.
	22-18 Ga. Male	17462	25
	22-18 Ga. Female	12159	25
	16-14 Ga. Male, Blue	12165	25
	16-14 Ga. Female, Blue	8781	50

Piggyback Terminals

1/4" Female • Fully Insulated Nylon

Actual Size	Wire Range	Auveco Part No.	Unit Pkg.
	22-18 Ga. 1/4" Tab Std. Barrel Red	19298	15
	16-14 Ga. 1/4" Tab Std. Barrel Blue	19299	15



Fully Insulated Tap Disconnect

Mates with 11828, 11605 & 11830

Wire Range	Auveco Part No.	Unit Pkg.
22-18 Ga. (Red)	12791	10
18-14 Ga. (Blue)	12161	10
12 Ga. (Yellow)	14898	100
	12792	10

Fully insulated connectors are for tapping into a line without stripping the insulation. No special tools are required.

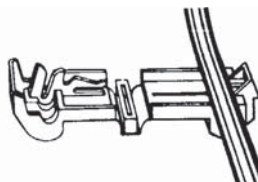

Place wire to be tapped in locating notch. Then close with pliers.

Complete connection with Auveco fully insulated male terminal: 11828 (22-18 Ga.), 11605 (16-14 Ga.) or 11830 (12 Ga.)

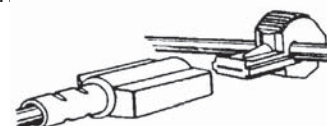



12158
Vinyl Insulated
Specialty Terminal
Wire Range: 1/4" Tab
Gauge: 16-14
UNIT PACKAGE: 25



17686
Mini Fuse Blade Type Fuse Tap
For tapping "hot side" of
mini fuse type fuse block
Refer to page 234
UNIT PACKAGE: 50





14474
Blade Type Fuse Tap
For tapping "hot side" of fuse block
Refer to page 173
UNIT PACKAGE: 25



11405
Fuse Block Accessory Clip
For add-on electrical equipment
UNIT PACKAGE: 50



SNAP PLUGS AND CONNECTORS

Snap Plugs • 22-18 Gauge Universal • .157" Diameter

Actual Size	Description	Auveco Part No.	Unit Pkg.
	Vinyl Insulated	11604	50
	Insulated Crimp-on Female	10720	10

Mates with 11604

Snap Plugs • 16-14 Gauge Universal • .157" Diameter Use with 10719 Connector

Actual Size	Description	Auveco Part No.	Unit Pkg.
	Vinyl Insulated	5063	100
	Nylon Insulated	12146	25

Snap Plugs • 16-14 Gauge Ford (American & Lucas) • .176" Dia. Use with 11602 Connector

Actual Size	Description	Auveco Part No.	Unit Pkg.
	Vinyl Insulated	5062	100

Fully Insulated Crimp-On Female (.157")

Actual Size	Description	Auveco Part No.	Unit Pkg.
	Nylon 16-14 Ga.	10719 17494	10 25

Mates with 5063 & 12146

Fully Insulated Crimp-on Female (.176")

Actual Size	Description	Auveco Part No.	Unit Pkg.
	Nylon 16-14 Ga.	11602 17493	25 50



Mates with 5062 & 12145

Snap Plug Tap-Disconnect Use Universal Snap Plugs (left column)

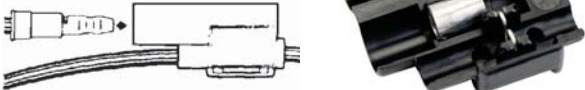
Actual Size	Description	Auveco Part No.	Unit Pkg.
	18-14 Ga.	10319	10



Dual Male-Female Adapter

Actual Size	Description	Auveco Part No.	Unit Pkg.
	Converts .250" x .032" Male Tab to 2 Male Tabs	8009	100
	Converts .250" x .032" Male Tab to 2 Male Tabs	8788	25

KRIMP & SEAL TERMINALS

Special polyolefin tubing when heated terminal shrinks with a 3-1 ratio to completely seal entire connection, making penetration by any foreign material impossible.







24-22 Gauge Wire Range (Clear)

Actual Size	Wire Size	Auveco Part No.	Unit Pkg.
	Butt Connector	21317	10

22-18 Gauge Wire Range (Red)

Actual Size	Wire Size	Auveco Part No.	Unit Pkg.
	#6	13656	10
	#10	13657	10
	Butt Connector	13659 19258	10 25
	.250" Female	13660	10
	.250" Male	13661	10
	#10	13658	10







16-14 Gauge Wire Range (Blue)

Actual Size	Wire Size	Auveco Part No.	Unit Pkg.
	#6	13662	10
	#10	13663	10
	1/4"	13664	10
	5/16"	13665	10
	3/8"	13666	10
	Butt Connection	13669 19259	10 25

16-14 Gauge Wire Range (Blue)

Actual Size	Wire Size	Auveco Part No.	Unit Pkg.
	.157"	13681	10
Mates with 13682			
	.157"	13682	10
Mates with 13681			
	.250"	13670	10
	.250"	13671	10
	.250" Female	13672 19260	10 25
	.250" Male	13673 19261	10 25

12-10 Gauge Wire Range (Yellow)

Actual Size	Wire Size	Auveco Part No.	Unit Pkg.
	#10	13674	10
	1/4"	13675	10
	3/8"	13676	10
	Butt Connector	13678 19262	10 25
	#10	13677	10
	.250" Female	13679	10
	.250" Male	13680	10

Crimped for mechanical reliability, soldered for superior strength and conductivity, and sealed with heat shrink tubing for maximum durability.

Crimp Connector

- Crimp indicators show where the installation tool should be positioned
- Wire-stops in butt connectors prevent over-insertion of the wire
- Window in the connector allows for visual inspection & solder to flow into

Solder

- Flux coating to clean metal surfaces
- Low-temperature solder alloy for ease of installation
- Pre-measured solder to provide the right amount of solder ensuring a solid termination

Heat Shrink Tubing

- Adhesive lined polyolefin to seal the connection
- Translucent tubing to allow for visual inspection







24-22 Gauge Wire Range (Clear)

Actual Size	Wire Size	Auveco Part No.	Unit Pkg.
	Butt Connector	21002	10





20 - 18 Gauge Wire Range (Red)

Actual Size	Wire Size	Auveco Part No.	Unit Pkg.
	#8	21260	10
	#10	21261	10
	1/4"	21262	10
	5/16"	21263	10
	3/8"	21264	10
	1/4" Female Slip-On	21278	10
	1/4" Male Slip-On	21279	10
	Butt Connector	21003	10
	24 - 22 Ga. to 20 - 18 Ga. Step down butt connector	21275	10





16 - 14 Gauge Wire Range (Blue)

Actual Size	Wire Size	Auveco Part No.	Unit Pkg.
	#8	21265	10
	#10	21266	10
	1/4"	21267	10
	5/16"	21268	10
	3/8"	21269	10
	1/4" Female Slip-On	21280	10
	1/4" Male Slip-On	21281	10
	Butt Connector	21004	10
	20-18 Ga. to 16-14 Ga. Step down butt connector	21276	10

12 - 10 Gauge Wire Range (Yellow)

Actual Size	Wire Size	Auveco Part No.	Unit Pkg.
	#8	21270	10
	#10	21271	10
	1/4"	21272	10
	5/16"	21273	10

Sealed Crimp & Solder Terminals
Continued 12 - 10 Gauge Wire Range (Yellow)

Actual Size	Wire Size	Auveco Part No.	Unit Pkg.
	3/8"	21274	10
	1/4" Female Slip-On	21282	10
	1/4" Male Slip-On	21283	10
	Butt Connector	21005	10
	16-14 Ga. to 12-10 Ga. Step down butt connector	21277	10

 **Moisture Resistant Nylon Insulated Butt Connectors**

Protect electrical connections from corrosive environments: road chemicals, salt spray, etc. Insert wire and crimp twice (electrical and mechanical) at each end. No need for heat or chemicals.

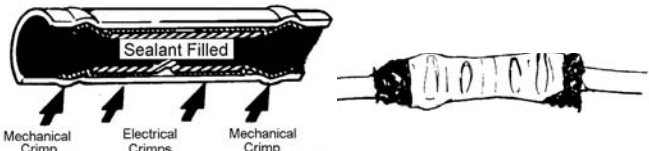

Auveco Part No.	Wire Range	Color	Unit Pkg.
13683	22-18 Ga.	Red	10
13684	16-14 Ga.	Blue	10
13685	12-10 Ga.	Yellow	10



Heat-Shrinkable, Solder-Type Closed-End Connector

Heat-shrinkable thermoplastic sleeve containing a spiral wound copper insert that is fitted with a pre-fluxed solder band. Easy installation: Insert stripped wires, then twist slightly. Twisting causes the copper insert to tightly grip, compress and hold the wires together. Apply heat.









Insulated & Sealed Closed-End Connector
Color Code: Green
Wire Range: 22-14 Gauge
Minimum Combination: 3 22 Gauge
Maximum Combination: 1 14 Gauge & 1 22 Gauge
UNIT PACKAGE: 10





Solderless Terminals
Non-Insulated
22-18 Gauge Wire Range

Actual Size	Wire Size	Auveco Part No.	Unit Pkg.
	#4-#6	5000	100
	#8-#10	5002	100
	Butt Connector	5044	100

16-14 Gauge Wire Range

Actual Size	Wire Size	Auveco Part No.	Unit Pkg.
	#4-#6	5003	100
	#8-#10	5005	100
	#12-1/4"	5006	100
	#4-#6	5014	100
	#8-#10	5015	100
	Butt Connector	5045	100





16-14 Gauge Wire Range
High Temperature

Actual Size	Wire Size	Auveco Part No.	Unit Pkg.
	#8-#10	17491	50
	#12-1/4"	17492	50
	.187" Female	10724	25
	1/4" Female	5066	100
	1/4" Male	17490	50



SOLDERLESS TERMINALS

Non-Insulated

12-10 Gauge Wire Range

Actual Size	Wire Size	Auveco Part No.	Unit Pkg.
	#8-#10	5007	100
	#12-1/4"	5008	100
	5/16"	5009	100
	3/8"	5010	100
	Butt Connector	5046	100

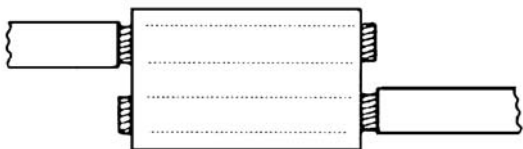

Parallel Connectors (Fusible Link Connectors)

Actual Size	Wire Size	Auveco Part No.	Unit Pkg.
	16-14 Ga.	12630	100
	12-10 Ga.	12631	50





Parallel Connectors Proper Wire Insertion



Splice Clips

Actual Size	Wire Size	Auveco Part No.	Unit Pkg.
	Max. of 3 #16 Ga.	18952	50
	Max of 3 #12 Ga.	22341	25





8 Gauge Wire Range

Actual Size	Wire Size	Auveco Part No.	Unit Pkg.
	1/4"	15158	25
	5/16"	15159	25



8 Gauge Wire Range

Actual Size	Wire Size	Auveco Part No.	Unit Pkg.
	3/8"	15160	25
	1/2"	15161	25

6 Gauge Wire Range

Actual Size	Wire Size	Auveco Part No.	Unit Pkg.
	1/4"	15162	25
	5/16"	15163	25
	3/8"	15164	25
	1/2"	15165	25

4 Gauge Wire Range

Actual Size	Wire Size	Auveco Part No.	Unit Pkg.
	1/4"	15166	10
	5/16"	15167	10
	3/8"	15168	10

Tap Splice Electrical Connectors



Make quick, reliable pre-insulated tap splices, in-line splices, pass-through connections and pigtail connections without stripping, twisting, soldering or using special tools.

Easy to use:

- Open the connector making sure the piercing barb is clear of the wire channels.
- Insert unstripped wires in the proper channels.
- Use pliers to squeeze down the piercing barb until the top is flush with the connector body.
- Close the hinged cover so it locks securely.

Auveco Part No.	Wire Size	Color	Unit Pkg.
17036	22-18 Ga.	Red	25
9481	18-14 Ga.	Blue	25
14896	18-14 Ga.	Blue	100
14897	18-14 Ga.	Blue	500



10385
Tan

Heavy duty self-stripping connector designed for 14, 16, 18 gauge wire connected on to 10 or 12 gauge automotive wire. Ideal for over the road equipment where tap, in-line, and pigtail splices are required.

UNIT PACKAGE: 10



10386
Yellow

Designed exclusively for 10 or 12 gauge splicing on heavy duty vehicle wiring. Tap, in-line, and pigtail splices made quick and easy with this self-stripping connector.

UNIT PACKAGE: 10



10319

Bullet receptacle connector for use with 18-14 gauge wire. Mates with Auveco snap plugs 5063 and 12146. Place wire to be tapped into connector channel, snap body together and lock into place with pliers.

UNIT PACKAGE: 10



Moisture-Resistant Tap Connector

Tap connector with patented application system forces protective gel around the wire and element, providing a moisture-resistant barrier to destructive substances such as salt water and other corrosive environments. Withstands continuous operating temperatures of -40°C to 75°C (-40°F to 167°F).

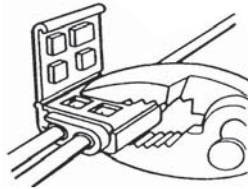

Auveco Part No.	Wire Size	Color	Unit Pkg.
17360	18-14 Ga.	Blue	50

Electrical Connectors



Fully insulated connector for tapping into a line without stripping the insulation. No special tools are required.

Place wire to be tapped in locating notch. Then close with pliers.

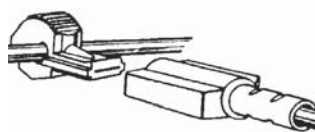
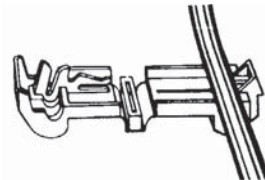

mate connection with Auveco insulated male terminal: 11828 (22-18 Gauge), 11605 (16-14 Gauge) or 11830 (12 Gauge)

Auveco Part No.	Wire Size	Color	Unit Pkg.
12791	22-18 Ga.	Red	10
12161	18-14 Ga.	Blue	10
14898	18-14 Ga.	Blue	100
12792	12 Ga.	Yellow	10



14920
With Sealant

Self-stripping connector for making 2 or 3 wire pigtail connections with a wire range of 22-14 gauge.

Simply insert 2 or 3 unstripped wires completely into the connector. Hold a crimping tool perpendicular to the wires and make the connection by driving the cap down. For use to 600V maximum.

UNIT PACKAGE: 10

O.E.M. SHELLS

GM Weather Pack Series • *Photos not actual size*

Sec. 12



15949
(12010996)
Nylon

Single Cavity Shroud
Mates with Auveco 15950

UNIT PACKAGE: 25



15953
(12010717)
Nylon

Triple Cavity Shroud
Mates with
Auveco 15954

UNIT PACKAGE: 15



18147
(12015798)
Nylon

4 Cavity Square Tower
Mates with Auveco 18148

UNIT PACKAGE: 5



15950
(12015791)
Nylon

Single Cavity Tower
Mates with Auveco 15949

UNIT PACKAGE: 25



15954
(12015793)
Nylon

Triple Cavity Tower
Mates with
Auveco 15953

UNIT PACKAGE: 15



18148
(12015024)
Nylon

4 Cavity Square Shroud
Mates with Auveco 18147

UNIT PACKAGE: 5



15951
(12010973)
Nylon

Double Cavity Shroud
Mates with Auveco 15952

UNIT PACKAGE: 25



18145
(12015797)
Nylon

4 Cavity Flat Tower
Mates with Auveco 18146

UNIT PACKAGE: 5



18149
(12034342)
Nylon

5 Cavity Round Tower
Mates with Auveco 18150

UNIT PACKAGE: 2



15952
(12015792)
Nylon

Double Cavity Tower
Mates with Auveco 15951

UNIT PACKAGE: 25



18146
(12010974)
Nylon

4 Cavity
Flat Shroud
Mates with
Auveco 18145

UNIT PACKAGE: 5



18150
(12065158)
Nylon

5 Cavity
Round Shroud
Mates with
Auveco 18149

UNIT PACKAGE: 5



18151
(12015799)
Nylon

6 Cavity Flat Tower
Mates with Auveco 18152

UNIT PACKAGE: 3

O.E.M. SHELLS

GM Weather Pack Series • *Photos not actual size*



18152

(12010975)

Nylon

6 Cavity Flat Shroud
Mates with Auveco 18151

UNIT PACKAGE: 5



14462

(12014012)

Weather Pack Terminal Extractor Tool
Designed for extracting Weather Pack terminals from their connector housing. Slide the hollow shaft of the tool over the retention barbs of the terminal. Then pull the terminal out of its shell.

UNIT PACKAGE: 1

O.E.M. TERMINALS

GM Weather Pack Series

Male Terminals are used with Shrouds • Female Terminals are used with Towers



20747

(GM: 12089307)
Tin Plated

Gauge: 24-22
Mates with Auveco 20748

UNIT PACKAGE: 15



15937

(12010182, 12124580)
Tin Plated

Gauge: 16-14
Mates with Auveco 15948

UNIT PACKAGE: 50



20748

(GM: 12020801)
Tin Plated

Gauge: 24-22
Mates with Auveco 20747

UNIT PACKAGE: 15



18325

(12089306, 12124587)
Tin Plated

Gauge: 12
20 Amp Max.
Mates with Auveco 18324

UNIT PACKAGE: 25



14151

(12034051, 12089188)
Tin Plated

Gauge: 20-18
Mates with Auveco 14150

UNIT PACKAGE: 50



18324

(12015917, 12124581)
Tin Plated

Gauge: 12
20 Amp Max.
Mates with Auveco 18325

UNIT PACKAGE: 25



14150

(12033674, 12089040)
Tin Plated

Gauge: 20-18
Mates with Auveco 14151

UNIT PACKAGE: 50



20749

(GM: 12015899)
Red Silicone

Cable Seal
Use with Auveco 20747 & 20748

UNIT PACKAGE: 25



15948

(12010085, 12089305)
Tin Plated

Gauge: 16-14
Mates with Auveco 15937

UNIT PACKAGE: 50



14152

(12015323)
Green Silicone

Cable seal
Use with Auveco 14150, 14151, 15937 & 15948

UNIT PACKAGE: 50

O.E.M. TERMINALS

GM Weather Pack Series

Sec. 12

Male Terminals are used with Shrouds • Female Terminals are used with Towers



18326

(12010293)
Gray Silicone

Use with 14 Gauge GPT & Cross-Link
Polyethylene Primary Wire

UNIT PACKAGE: 25



14154

(12014837)

Gauge: 20-18
Set of 14151 and 14152

UNIT PACKAGE: 25 Sets



20618

(12015193)
Blue Silicone

Use with Auveco 18324 & 18325

UNIT PACKAGE: 25



15955

(12010300)
Silicone

Cavity Plug
Used to plug empty cavities in connector shell

UNIT PACKAGE: 25



15921

Repair Lead Gauge: 20-18
Gauge Wire: 10" of 18

UNIT PACKAGE: 5



14153

(12014836)

Gauge: 20-18
Set of 14150 & 14152

UNIT PACKAGE: 25 Sets



15922

Repair Lead Gauge: 20-18
Gauge Wire: 10" of 18

UNIT PACKAGE: 5

O.E.M. TERMINALS



15957

(2965142)
Tin Plated

Gauge: 16-14
Insulated with shell 8777
Mates with terminal 15956

UNIT PACKAGE: 25



8776

(2962987)
Tin Plated

Gauge: 16-14
Insulated with shell 8775
Mates with terminal 8774

UNIT PACKAGE: 50



15956

(2971962)
Tin Plated

Gauge: 16-14
Insulated with shell 8775
Mates with terminal 15957

UNIT PACKAGE: 25



17002

(8917283;12015878)
Tin Plated
Copper

Gauge: 12-10
Insulated with shell 8775

UNIT PACKAGE: 25



8774

(2084421,2962447)
Unplated Brass

Gauge: 16-14
Insulated with shell 8777
Mates with terminal 8776

UNIT PACKAGE: 50



8775

(2962984)

Insulates 8776 and 15956
Mates with shell 8777

UNIT PACKAGE: 25



8777

(2962448)

Insulates 8774 and 15957
Mates with shell 8775

UNIT PACKAGE: 25

GM Micro - Pack Terminals



14883

(12020757)
Tin Plated

Gauge: 20-18

UNIT PACKAGE: 10



15924

(12040902)
Tin Plated

Gauge: 22

UNIT PACKAGE: 50

GM Pack-Con I Series Terminals



11948

(8900524, 12020320)
Tin Plated

Gauge: 16-14
Mates with Auveco 15935

UNIT PACKAGE: 25



15935

(12020347)

Gauge: 16-14
Mates with Auveco 11948

UNIT PACKAGE: 50

GM Pack-Con H.D. I Series Terminals



15960

(12033817)
Tin Plated

Gauge: 12-10

UNIT PACKAGE: 25

GM Pack-Con III Series Terminals



18650

(12020321)
Brass

Gauge: 16-14

UNIT PACKAGE: 25

GM Metri-Pack 150 Series Terminals



18653

(12045773)
Tin Plated

Gauge: 20-18

UNIT PACKAGE: 25



15498

(12047581)
Tin Plated

Gauge: 20-18
Mates with Auveco 15497

UNIT PACKAGE: 25



15497

(12047680)
Tin Plated

Gauge: 20-18
Mates with Auveco 15498

UNIT PACKAGE: 25



18654

(12048074)
Tin Plated

Gauge: 20-18

UNIT PACKAGE: 25



15499

(GM: 12047767; Chry: 4368618)
Tin Plated

Gauge: 20-16

UNIT PACKAGE: 25



20212

(12129484)
Tin Plated

Gauge: 18-16

UNIT PACKAGE: 15



20213

(12129373)
Tin Plated

Gauge: 22-20

UNIT PACKAGE: 15

GM Metri-Pack 150.2 Pull to Seat



20214
(12124075)
Tin Plated

Gauge: 18-16

UNIT PACKAGE: 15



20215
(12124076)
Tin Plated

Gauge: 22-20

UNIT PACKAGE: 15

GM Metri-Pack 150.1 Series Terminal



16806
(12052922, 12089340)

Gauge: 20-18
Not for use with 150.2 Series

UNIT PACKAGE: 25

GM 56 Series Terminal



18690
(2973215)
Tin Plated

Two Gauge Leads: 16-14
Or One Gauge Lead: 12
Fits 5/16" Male Tab

UNIT PACKAGE: 25

GM 59 Series Terminal



18651
(2973216)
Tin Plated

Gauge: 16-14
Blade Size: 5/16"

UNIT PACKAGE: 25

GM Metri-Pack 280 Series Terminal



18659
(12129497)
Tin Plated

Gauge: 16-14
Mates with Auveco 18658

UNIT PACKAGE: 25



14880
(12020116)
Tin Plated

Gauge: 16-14
Mates with Auveco 14881

UNIT PACKAGE: 25

GM Metri-Pack 280 Series Terminal



15946
(12034047)
Tin Plated

Gauge: 20-18
Mates with Auveco 15947

UNIT PACKAGE: 50



18658
(12129493)
Tin Plated

Gauge: 16-14
Mates with Auveco 18659

UNIT PACKAGE: 25



14881
(12015857)
Tin Plated

Gauge: 16-14
Mates with Auveco 14880

UNIT PACKAGE: 25



15947
(12034046)
Tin Plated

Gauge: 20-18
Mates with Auveco 15946

UNIT PACKAGE: 50



20216
(12015858)
Tin Plated

Gauge: 12-10

UNIT PACKAGE: 15



20220
(12186456)
Tin Plated

Gauge: 14-12
Mates with Auveco 20226

UNIT PACKAGE: 15



20226
(12092344)
Tin Plated

Gauge: 14-12
Mates with Auveco 20220

UNIT PACKAGE: 15

GM Metri-Pack 280 Series Terminal



20221
(12186457)
Tin Plated

Gauge: 18-16
Mates with Auveco 20227

UNIT PACKAGE: 15



20227
(12092345)
Tin Plated

Gauge: 18-16
Mates with Auveco 20221

UNIT PACKAGE: 15

GM Metri-Pack 280 Series Tangless



20217
(12110842)
Tin Plated

Gauge: 14-12
Used without cable seal

UNIT PACKAGE: 15



20222
(12110845)
Tin Plated

Gauge: 14-12
Used with cable seal

UNIT PACKAGE: 15



20223
(12129409)
Tin Plated

Gauge: 16-14
Used with cable seal

UNIT PACKAGE: 15



20218
(12110844)
Tin Plated

Gauge: 18-16
Used without cable seal

UNIT PACKAGE: 15



20224
(12110847)
Tin Plated

Gauge: 18-16
Used with cable seal

UNIT PACKAGE: 15

GM Metri-Pack 280 Series Tangless



20219
(12110843)
Tin Plated

Gauge: 22-20
Used without Cable seal

UNIT PACKAGE: 15



20225
(12110846)
Tin Plated

Gauge: 22-20
Used with cable seal

UNIT PACKAGE: 15

GM Metri-Pack 280 Fuel Injector



20230
(12103360)
Tin Plated

Gauge: 22-20

UNIT PACKAGE: 15

GM Metri-Pack 480 Series



15939
(12020120)
Tin Plated

Gauge: 16-14
Blade Width: 3/16"
Mates with Auveco 15938

UNIT PACKAGE: 25



15938
(12015861)
Tin Plated

Gauge: 16-14
Mates with Auveco 15939

UNIT PACKAGE: 25

GM Metri-Pack 630 Series



15944
(12020126)
Tin Plated

Gauge: 16-14
Blade Width: 1/4"
Mates with Auveco 15945

UNIT PACKAGE: 50

GM Metri-Pack 630 Series



15945
(12015870)
Tin Plated

Gauge: 16-14
Mates with Auveco 15944

UNIT PACKAGE: 50

GM Metri-Pack 630 Pull to Seat



20231
(12066614)
Tin Plated

Gauge: 16-14

UNIT PACKAGE: 15

GM Micro-Pack 100 W Series Terminals



20209
(12084912)
Gold/Nickel Plated

Gauge: 18
Mates with Auveco 20211

UNIT PACKAGE: 10



20211
(12160551)
Gold/Nickel Plated

Gauge: 18
Mates with Auveco 20209

UNIT PACKAGE: 10



20210
(12084913)
Gold/Nickel Plated

Gauge: 22-20

UNIT PACKAGE: 10

Ford Wedgelock Pin Type Terminals



20475
(E7EB-14461-BA)
Tin Plated

Gauge: 20-18
Diameter Pin: .060"

UNIT PACKAGE: 25

Ford Wedgelock Pin Type Terminals



14887
(D1AB-14461-AA)

Gauge: 20-18
Diameter Pin: .110"
Mates with Auveco 14888

UNIT PACKAGE: 25



14888
(D1AB-14488-CA)

Gauge: 20-18
Diameter Pin: .110"
Mates with Auveco 14887

UNIT PACKAGE: 25

Ford Miniature Pin Type Terminals



18853
(E3VB-14461-AA)

Gauge: 20-18
Diameter Pin: .062"
Reference A-9

UNIT PACKAGE: 25

Ford Mini Block Terminals



16342
(E7EB-14421-EA)

Gauge: 20-18
Blade Width: 1/8"
Mates with Auveco 16344

UNIT PACKAGE: 25



16344
(E7EB-14474-CA)

Gauge: 20-18
For 1/8" Blade
Mates with Auveco 16342

UNIT PACKAGE: 25

Ford Standard Box Terminals



16348
(E8EB-14474-VA)
Tin Plated

Gauge: 16-14
For 3/16" Blade

UNIT PACKAGE: 25



14889
(D8BB-14474-BA, D3AB-14474-DA)

Gauge: 20-18

UNIT PACKAGE: 25

Ford Terminals



20815
(D20B-14421-BB)

Gauge: 20-18
Blade Width: 3/16"
Replaces Auveco 14890

UNIT PACKAGE: 25



20816
(D5AB-14474-FA, D3AZ-14474-G)

Gauge: 20-18
Replaces Auveco 14891

UNIT PACKAGE: 25

Chrysler Quick Connect Terminals



16349
(3843386)

Gauge: 16-14
Blade Width: 1/4"

UNIT PACKAGE: 25

Chrysler Terminals



16801
(7368261)

Gauge: 20-18
Diameter Pin: 3/32"
Male

UNIT PACKAGE: 25



16804
(4304729)

Gauge: 24-18
Double Cantilever Spring Terminal
Used with P.C. board connections & general purpose

UNIT PACKAGE: 25

UNIVERSAL TERMINALS



14892
(GM: 2965470;
Ford: C5AB-14474-B;
Chry: 2096466)
Unplated Brass

Gauge: 20-18
Female: 1/4"

UNIT PACKAGE: 25



17115
(GM: 2962953;
Ford: C2TB-14462A;
Chry: 2096454)
Bare Copper

Gauge: 12-10
Stud Size: 3/8" (10mm)

UNIT PACKAGE: 25



15504
(GM: 2965580;
Ford: C1SF-14474-A;
Chry: 2096467)
Unplated Brass

Gauge: 14-12
Female: 1/4"

UNIT PACKAGE: 25



21401
(GM: 2984172;
Ford: C8AB-14463N;
Chry: 4274166)
Tin Plated

Gauge: 16-14
Stud Size: 1/4" (6.3mm)
Locking Type

UNIT PACKAGE: 10

MATE-N-LOCK TERMINALS

Commonly used in cellular phone and communication equipment installations, office machines and machine controls.



18855

Tin Plated Brass

Gauge: 20-14
Diameter Pin: .084"
Single Retention Barb
Mates with Auveco 18856

UNIT PACKAGE: 25



18856

Tin Plated Brass

Gauge: 20-14
Diameter Pin: .084"
Single Retention Barb
Mates with Auveco 18855

UNIT PACKAGE: 25



18857

Tin Plated Brass

Gauge: 20-14
Diameter Pin: .084"
Dual Retention Barbs
Mates with Auveco 18858

UNIT PACKAGE: 25



18858

Tin Plated Brass

Gauge: 20-14
Diameter Pin: .084"
Dual Retention Barbs
Mates with Auveco 18857

UNIT PACKAGE: 25

Terminal Extractor Picks



Photo not actual size

Used to release most GM, Ford and Chrysler OEM terminals from their insulating shells. Not suitable for round, pin-type terminals.

14884

(12012000)

Narrow Blade (.050")

UNIT PACKAGE: 1

14885

(8913369)

Wide Blade (.090")

UNIT PACKAGE: 1

20583

(12094429)

Micro Terminal Extractor Pick

.035" Wide Blade used to release: 150 Metri-Pack, 280 Metri-Pack, 280 Tangless, 280 Bus Bar, 630 Pull to Seat, GT 150, GT 280, Wedge Base Light Socket terminals and indexing Candelabra Bayonet Double Contact Light Socket terminals.

UNIT PACKAGE: 1

CRIMPING & CUTTING TOOLS

20901

Electrical Connector Separator

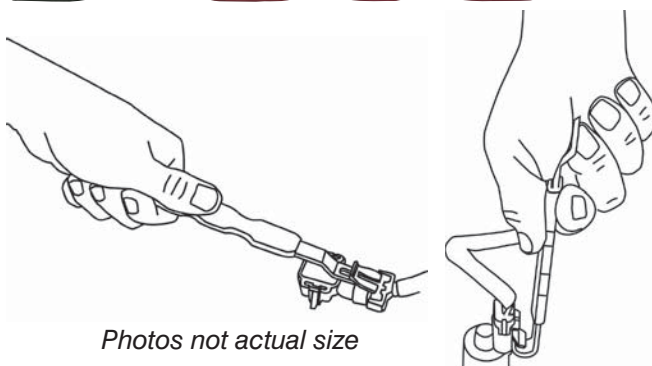

Photos not actual size

Quickly disconnects electrical connectors without damage. Simply engage the tool tip behind the connector locking clip and then pull or push to disconnect. The tool is double-ended to fit different access angles. Works on Weather Pack and other automotive electrical connectors.

UNIT PACKAGE: 1

15035

Self-Adjusting Wire Stripper/Crimping Tool



Photos not actual size

The quick and easy way to strip wire. Unique steel jaws self-adjust to strip any 26 - 10 gauge wire. Only light handle pressure is needed to make wire stripping fast and easy.

Crimps insulated and non-insulated 22 - 10 gauge and 7mm/8mm terminals

Also features precision machined blade for cutting wire sharp and smooth. Overall Length: 8-1/4"

UNIT PACKAGE: 1

Photos not actual size

21424

Wire Stripper for recessed areas



This specially designed, narrow profile tool provides easy access to limited and hard-to-reach areas.

Strips 22-12 gauge single or multiple-stranded conductor wire and automatically adjusts to the wire size. The tool has an adjustable strip length gauge and built in wire cutter.
Lightweight and easy to use

UNIT PACKAGE: 1

Open Barrel Terminal Crimping Tool For O.E.M. Terminals



16004

Duplicates factory crimps on open barrel terminals used in automotive, computer and control applications. Features five machined and hardened crimp stations for 14 to 24 gauge wire terminations. Parallel jaws eliminate faulty crimps.
Overall Length: 8-1/2"

UNIT PACKAGE: 1

Insulation Crimp:

Crimp Station A for 14-18 Gauge
Crimp Station B for 20-24 Gauge

Stripped Wire Crimp:

Crimp Station C for 14-16 Gauge
Crimp Station D for 18-20 Gauge
Crimp Station E for 22-24 Gauge

7711

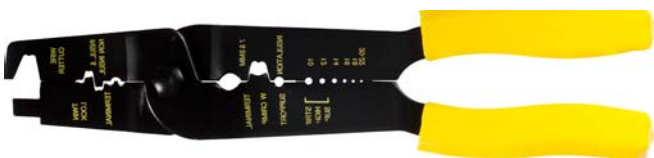

Cuts and strips 22-8 gauge wire. Crimps insulated and non-insulated solderless terminals in sizes from 22-10 gauge.
Overall Length: 9"

UNIT PACKAGE: 1

20751

(GM: 12014254)



Weather Pack Crimping Tool designed specifically to crimp only Weather Pack 20-18 Gauge & 16-14 Gauge Weather Pack seals and terminals in one cycle. Ratchet mechanism ensures completion of cycle.

UNIT PACKAGE: 1

20750

Micro Crimper
30-16 Gauge
Best for 24-20 Gauge



Insulation Crimp:

Crimp Station A for 20-16 Gauge
Crimp Station B for 30-22 Gauge

Stripped Wire Crimp:

Use Crimp Station C for 18-16 Gauge
Use Crimp Station D for 22-20 Gauge
Use Crimp Station E for 30-24 Gauge

UNIT PACKAGE: 1

20752

(GM: 12085270)



20-14 Gauge
Crimps most sealed GM terminals
Ratchet mechanism ensures completion of crimp cycle

Seal Crimp:

Crimp Station 1 for 150 Series Metri-Pack Seals
Crimp Station 3 for 480 & 630 Series Metri-Pack Seals
Crimp Station 5 for Weather Pack & 280 Series Metri-Pack Seals

Stripped Wire Crimp:

Crimp Station 2 for 20-18 Gauge
Crimp Station 4 for 16-14 Gauge

UNIT PACKAGE: 1

Twist-Type Wire Connectors



Color: Gray

Joins 18 & 16 Gauge Wires
Minimum of 2 #18 Gauge Wires
Maximum of 2 #16 Gauge Wires

10378: UNIT PACKAGE: 25
15204: UNIT PACKAGE: 100



Color: Blue

Joins 18-14 Gauge Wires
Minimum of 2 #18 Gauge Wires
Maximum of 3 #16 Gauge Wires

10379: UNIT PACKAGE: 25
15205: UNIT PACKAGE: 100



Color: Orange

Joins 18-14 Gauge Wires
Minimum of 2 #18 Gauge Wires
Maximum of 3 #16 Ga &
1 #18 Gauge Wires

10380: UNIT PACKAGE: 25
15206: UNIT PACKAGE: 100



Color: Yellow

Joins 18-12 Gauge Wires
Minimum of 1 #14 Gauge &
1 #18 Gauge Wires
Maximum of 2 #14 Gauge &
3 #16 Gauge Wires

10381: UNIT PACKAGE: 25
15207: UNIT PACKAGE: 100



Color: Red

Joins 18-10 Gauge Wires
Minimum of 1 #12 Gauge &
2 #18 Gauge Wires
Maximum of 2 #10 Gauge &
1 #12 Gauge Wires

10382: UNIT PACKAGE: 25
15208: UNIT PACKAGE: 100

Twist-Type Wire Connectors

Combines both the wide range and torque of wing-style connectors with a new flexible skirt that provides over-strip protection without taking additional space in the electrical box.



18312

Orange & Blue

Joins from two 22 gauge
to two 12 gauge wires

UNIT PACKAGE: 25



Wing Twist-Type Wire Connectors

Color: Blue

Joins 14-6 Ga. Wires
Minimum of 1 #10 Ga. & 1
#12 Ga. Wires
Maximum of 1 #6 Ga. & 2
#8 Ga.

10384 UNIT PACKAGE: 25
15209 UNIT PACKAGE: 50



15705

Yellow

Joins 22-12 Ga. Wires
Minimum of 2 #18 Ga. Wires
Maximum of 2 #12 Ga. Wires

UNIT PACKAGE: 50



15706

Red

Joins 20-8 Ga. Wires
Minimum of 2 #16 Ga. Wires
Maximum of 4 #12 Ga. Wires

UNIT PACKAGE: 50

CIRCUIT TESTER

20818

Photo not actual size



Computer Safe Automotive Logic Probe

This circuit tester with its high impedance feature draws less than 7 milliamps to protect all vehicle circuits including computerized engine and body controls, sensitive electronic sensors, microprocessors, electronic ignition components and air bags. Instructions included.

For 6, 12 and 24 volt systems

Insulated probe has an exposed length of 3-3/8"
Includes Protect-A-Terminal® Probe Adapter to prevent damage to electrical connectors

6 feet of heavy duty, 18 gauge dual leads with large battery clips for easy hook-up.

UNIT PACKAGE: 1

20819

Photo not actual size



Heavy Duty Circuit Tester

An excellent quality electrical circuit tester for checking 6 and 12 volt systems. It's made to last! Has a heavy duty battery clip. 5 feet of tough, flexible, heavily insulated rubber coated wire is retained in a spring supported strain-relief design that withstands the most rugged use.

UNIT PACKAGE: 1

**For Troubleshooting
DC Primary Circuits
on 6 & 12 Volt
Vehicles**



Photo not actual size

16420

Use to Check:
Lighting Systems
Wipers
Horn
Electric Clock,
Windows, Locks
Fuses
Relays

Features:

- 4 Feet of Wire
- Mechanical Strain Relief
- Impact & Chemical Resistant Housing
- 8" Long Probe/Housing
- Super Sharp Probe, Tempered to Last
- 2" Long Alligator Clip

UNIT PACKAGE: 1

WIRE LOOM

Split Flexible Tubing • Maximum Temperature of 345°F



I.D. 1/4" - O.D. 3/8"
Nylon 6 - Black

14197: 10' Length
14201: 50' Length (Bulk)



I.D. 3/8" - O.D. 9/16"
Nylon 6 - Black

14198: 10' Length
14202: 50' Length (Bulk)



I.D. 1/2" - O.D. 11/16"
Nylon 6 - Black

14199: 10' Length
14203: 50' Length (Bulk)



I.D. 5/8"
O.D. 13/16"
Nylon 6
Black

20536:
50' Length



I.D. 3/4" - O.D. 15/16"
Nylon 6 - Black

14200:
10' Length
14204:
50' Length (Bulk)



I.D. 1"
O.D. 1-1/8"
Nylon 6
Black

18194:
25' Length

**Please place orders in
Unit Package quantities,
not based on pieces needed**

PRIMARY AND FUSIBLE WIRE

Photos not actual size



Primary Wire

Standard PVC Insulation (SE/GPT Type)
Suitable for most automotive applications.
Free of stripping, abrasion resistant,
meets most O.E.M. vehicle standards

UNIT PACKAGE: 1 Roll

The lower the gauge number, the thicker the wire
(i.e. 10 gauge is thicker than 16 gauge)

Gauge	Stranding	Outer Diameter	Auveco Part No.				Length
			Red	White	Black	Blue	
18	16 x 30	.092	20486	20487	20488	20489	45 Ft.
16	19 x 29	.104	20490	20491	20492	20493	35 Ft.
12	19 x 25	.142	20494	20495	20496	20497	15 Ft.
10	19 x 23	.175	20498	20499	20500	20501	10 Ft.

25 Foot Spool

Gauge	Stranding	Outer Diameter	Auveco Part No.					Yellow
			Red	White	Black	Blue	Green	
14	19 x 27	.117	12419	12420	12421	12422	15239	15240

100 Foot Spool

Gauge	Stranding	Outer Diameter	Auveco Part No.						
			Red	White	Black	Blue	Green	Yellow	Brown
20	10 x 30	.085	21339	21340	21341	21342	21343	21344	21345
18	16 x 30	.092	12423	12424	12425	12426	12427	12428	15256
16	19 x 29	.104	12429	12430	12431	12432	12433	12434	15257
14	19 x 27	.117	12435	12436	12437		12439	12440	15258
12	19 x 25	.142	12441	12442	12443	12444	15259	15260	
10	19 x 23	.175	12445		12447	12448		15263	

Spooled Fusible Link Wire

The lower the gauge number, the thicker the wire (i.e. 10 Ga. is thicker than 16 Ga.)



A fusible link is a special section of low tension cable installed by an OEM and designed to open a circuit when subjected to extreme current overload. Its purpose is to minimize wiring system damage when such an overload accidentally occurs in those circuits protected by the fusible link. A short circuit causes the fusible link to act as an element in a "slow-blow" fuse. A fusible link is not intended to be used in place of a fuse but only where a fuse cannot be economically employed. Our fusible line wire meets the requirements of SE J-156 and the insulation has the characteristics as listed for EAE, SE J-1128 Type SXL. The vehicle manufacturer should be consulted about questions on fusible link length and size. General practice has been for a fusible link to be 4 gauges smaller than the circuit wire.

Example: if the circuit wire is 12 gauge, use a 16 gauge fusible link.

Final determination should be based on O.E.M. application.

Note: Extreme care should be taken to always replace a fusible link with then same gauge and length as installed by the manufacturer.

Auveco Part No.	Gauge	Color	Length	Replaces	Unit Pkg.
15372	14	Orange	25 Ft.	GM: 6292995	1 Spool
20484	8	Black or Rust	25 Ft.		1 Spool

*Color may vary at manufacturer's option

FUSIBLE LINKS

Photos not actual size



Universal Fusible Links

Auveco Part No.	Gauge	Length	Replaces	Unit Pkg.
12627	18	9"	Chry: 3843392 & other 18 Ga. links	5
12628	16	9"	GM: 6292996, 8903489 Ford D3AZ-14526-E & other 16 Ga. links	5
12629	14	9"	GM: 6292995, 8903488 Ford D3AZ-14526D & other 14 Ga. links	5
17465	12	9"	GM: 6293923	5
17464	10	9"	GM: 12077140	5

TEST CLIPS



Type 1

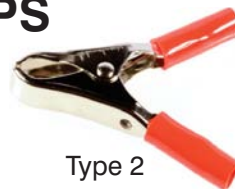

Type 2

Auveco Part No.	Type	Description	Unit Pkg.
20478	1	10 Amp, Alligator Clip, Nickel Plated, 2" Long	5
16969	2	10 Amp, Red Insulation, 2-1/4" Long	5
16970	2	10 Amp, Black Insulation, 2-1/4" Long	5
16971	2	1 Each of 16969 & 16970	1 Pair
16972	2	30 Amp, Red Insulation, 3" Long	5
16973	2	30 Amp, Black Insulation, 3" Long	5
16974	2	1 Each of 16972 & 16973	1 Pair
16975	2	50 Amp, Red Insulation, 3" Long	5
16976	2	50 Amp, Black Insulation, 3" Long	5
16977	2	1 Each of 16975 & 16976	1 Pair

BATTERY CABLE & TERMINALS



Battery Cable

Bare Copper Standard Conductor, covered with tough black Polyvinyl Chloride insulation. The thick jacket is easy to strip, resistant to moisture, weather, oil and acids.

Auveco Part No.	Gauge	Stranding	O.D.	Unit Pkg.
11392	4	70 x 22.5	.380	25' Roll
13850	1/0	133 x 21	.530	25' Roll
13851	2/0	133 x 20	.590	25' Roll

Solderless Battery Cable Terminals



Tin Plated Copper

Auveco Part No.	Cable Size	Post Size	Unit Pkg.
11360	No. 6 AWG	Universal	2
11361	No. 4 AWG	Universal	2
11362	No. 1 AWG	Positive	2
11363	No. 1 AWG	Negative	2
11364	No. 1/0 AWG	Positive	2
11365	No. 1/0 AWG	Negative	2
11366	No. 2/0 AWG	Positive	2
11367	No. 2/0 AWG	Negative	2
15858	No. 3/0 AWG	Positive	2

Note: Use with Auveco Tool No. 7996



Universal Battery Terminal

9948

For Positive & Negative Posts
Cable Range 8 thru 2/0 AWG

UNIT PACKAGE: 2

Marine Battery Terminals

Lead Plated Brass Terminal
Nickel Plated Grade 2 Steel Wing Nut
Zinc Plated Grade 2 Steel Bolt & Nut



8772

For Positive Posts
Stud: 3/8"-16

UNIT PACKAGE: 5



8773

For Negative Posts
Stud: 5/16"-18

UNIT PACKAGE: 5

BATTERY CABLE & TERMINALS

Photos not actual size

Sec. 12

Engine Ground & Bonding Strap



19499

Replacement for body to engine block straps. Solves light dimming problems by grounding charging system. Also reduces radio noise. Copper braided wire with tin-plated brass ring terminals.

Length: 8"

Gauge: 10

Stud Size Ring Terminal: 5/16" - 3/8"

UNIT PACKAGE: 2



Universal Side Mount Battery Cable Terminal

12975

Fits all small diameter cables - both positive and negative.

UNIT PACKAGE: 2



All Lead Terminal

10808

Zinc Plated Steel Bolt & Nuts

Stud: 5/16"-18

Universal Positive & Negative

UNIT PACKAGE: 2

COMPRESSION BATTERY CABLE TERMINALS

All clamps and lugs are made of cast copper • All clamps, lugs and fasteners are tin plated

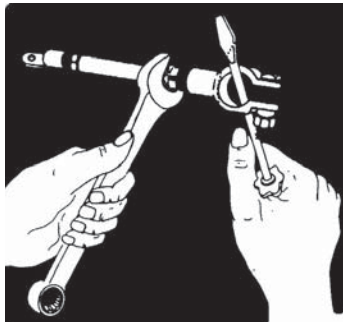

Assemble with common hand tools.

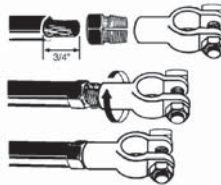

Three Easy Steps

1. Strip 3/4" of insulation from the end of the cable. Insert bared wire into the compression nut.
2. Thread terminal on compression nut.
3. Grip compression nut with wrench and turn the terminal until the compression nut seats. With larger gauges you may want to hold the terminal in a vise



Straight Clamp

Auveco Part No.	Cable Gauge	Description.	Color	Unit Pkg.
15603	4	Pos.	Gray	2
15605	1&2	Pos.	Green	2
15606	1/0	Neg.	Black	2
15607	1/0	Pos.	Black	2
15608	2/0	Neg.	Orange	2
15609	2/0	Pos.	Orange	2
15610	3/0	Neg.	Purple	2
15611	3/0	Pos.	Purple	2

Heavy Wall Copper Lug



Auveco Part No.	Cable Gauge	Hole Size	Color	Unit Pkg.
15618	4	3/8"	Gray	2
15619	1&2	3/8"	Green	2
15620	1/0	3/8"	Black	2
15621	1/0	1/2"	Black	2
15622	2/0	3/8"	Orange	2
15625	3/0	1/2"	Purple	2



Stud/Side Terminal

Auveco Part No.	Cable Gauge	Color	Unit Pkg.
15628	1/0	Black	2



Compression Nut



Auveco Part No.	Cable Gauge	Color	Unit Pkg.
15632	2/0	Orange	5

Photos not actual size



Copper Battery Cable Lugs

Auveco Part No.	Cable Size	Stud Size	Unit Pkg.
5794	4 Ga.	3/8"	25
5796	1/0 Ga.	3/8"	25
11467	2/0 Ga.	1/2"	10

Use Auveco 7996 Crimping Tool

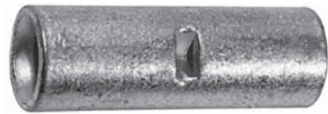

Butt Connector (Double Flared)

Pure Copper with Tin Plating

Applications: Field or shop splicing of battery cables and welding cables.

Auveco Part No.	Cable Size	Length	Unit Pkg.
11729	2/0 Ga.	1-3/4"	5



11083
(8917444)
Zinc

Battery Side Terminal Bolt
Thread Size: 3/8"-16
Overall Length: 1-1/8"
GM

UNIT PACKAGE: 10



19199
(12004188)
Zinc

Battery Side Terminal Bolt
Thread Size: 3/8"-16
Overall Length: 1-3/4"
GM

UNIT PACKAGE: 5



13816
Stainless Steel

Battery Hold Down Nuts
Thread Size: 3/8-16
Overall Length: 18/8

UNIT PACKAGE: 4

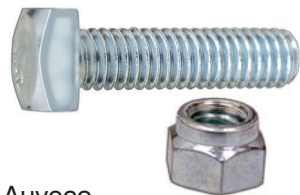

Battery Terminal Bolt & Nut
Zinc Chromate

Auveco Part No.	Size	Unit Pkg.
3186	5/16"-18 x 1-1/4" Bolt w/Collared Nut	100
8003	5/16"-18 x 1-1/4" Bolt W/Hex Nut	50
14974	5/16"-18 x 1-1/4" Bolt Only	50
14975	5/16"-18 Collared Nut Only	50

Heavy Duty Battery Cable Terminal Ends for Stud-Type Batteries
For Auto, Truck, Marine and H.D. Equipment



Single Barrel
Copper/Plated
Stud Size: 3/8

Auveco Part No.	Cable Size	Unit Pkg.
13810	1/0	2
13811	2/0	2



Double Barrel
Copper/Plated
Stud Size: 3/8

Auveco Part No.	Cable Size	Unit Pkg.
13814	2/0	1

Suggested Terminal Assemblies

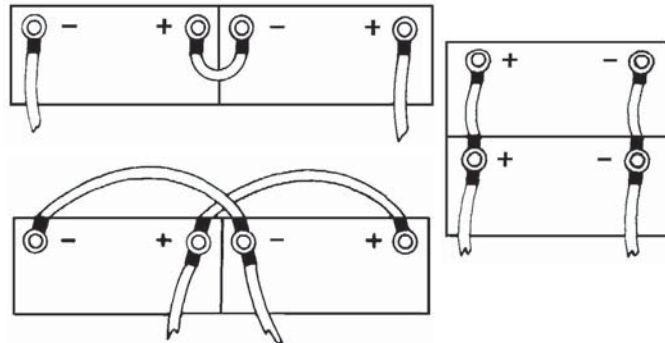

20899

Side Terminal Battery Cleaner



Coil spring cutters polish the battery contacts while the stainless steel brushes clean the cable terminals.

UNIT PACKAGE: 1

BATTERY TERMINAL TOOLS

Photos not actual size



20898
Battery Brush

Cleans dirt and corrosion from post type battery terminals and cable clamps. Made of heavy duty stainless steel wire. Case is made of high impact plastic that will not weaken in cleaning solutions.

UNIT PACKAGE: 1



15039
Anti-Corrosion Protectant

A non-drying coating protectant, formulated especially for battery terminals and other exposed electrical connections.

UNIT PACKAGE: 1 8oz. Can



7996

Crimps cable range
Gauge: 8 to 4/0
Use with vise or hammer

UNIT PACKAGE: 1

3M Vinyl Electrical Tape
Made in U.S.A.

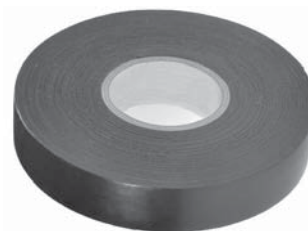

.007" Thick x 3/4" Wide x 60 Ft. Long

16527: Unit Package: 5 Rolls
16578: Unit Package: 15 Rolls

General purpose vinyl insulating tape with excellent resistance to abrasion, moisture, alkalis, acid, copper corrosion and varying weather conditions. Can be used as a primary electrical insulation for all wire and cable splices rated up to 600 volts.

Linerless Self-Bonding Rubber Tape



14389

.030" Thick x 3/4" Wide x 15ft. Long

UNIT PACKAGE: 1 Roll

Replace heat shrink tubing with a safe, tight, long-lasting seal that withstands temperature extremes from -50° to 300°F. No heat guns or open flames needed. No paper liner to mess with.

Tape is stretched when applied and retains its elasticity to ensure a tight seal at all points. The tape is unaffected by salt spray and common automotive fluids. As long as it is stretched when it is applied, it will not unravel after application due to its self-bonding characteristics.

CIRCUIT BREAKERS

Automatic Re-Set

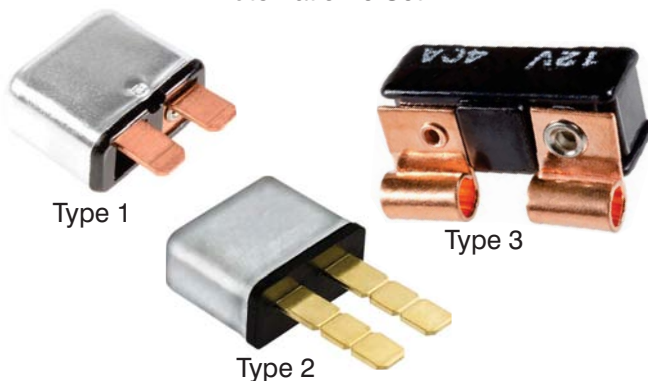

Auveco Part No.	Type	Specifications	Unit Pkg.
15046	1	30 Amps at 12 Volts	5
18518	2	10 Amps at 12 Volts	2
18519	2	15 Amps at 12 Volts	2
18520	2	20 Amps at 12 Volts	2
18521	2	30 Amps at 12 Volts	2
18522	2	40 Amps at 12 Volts	2
15048	3	30 Amps at 12 Volts	5
15049	3	40 Amps at 12 Volts	5

HEAT SHRINK TUBING

Made in the U.S.A. • Photos not actual size



Black Thin Wall Heat Shrink Tubing

- 2 to 1 Shrink Ratio
- Cross linked Polyolefin
- Highly Flame Retardant (VW-1)

Auveco Part No.	Size	Pre-Shrink I.D.	Post-Shrink I.D.	Length	Unit Pkg.
18693	3/64"	.046"	.023"	6"	25
18694	1/16"	.063"	.031"	6"	25
18695	3/32"	.093"	.046"	6"	25
18696	1/8"	.125"	.062"	6"	25
18697	3/16"	.187"	.093"	6"	25
18698	1/4"	.250"	.125"	6"	25
18699	3/8"	.375"	.187"	6"	15
18700	1/2"	.500"	.250"	6"	15
18701	3/4"	.750"	.375"	6"	10
18702	1"	1.00"	.500"	6"	10
18703	1-1/2"	1.50"	.750"	6"	5



Adhesive Lined Heat Shrink Tubing

- 4.5 to 1 Shrink Ratio
- Cross linked, Semi-Rigid Polyolefin Outer Jacket
- Hot-Melt Adhesive Inner Wall adheres to all major types of Wire
- Environmentally Seals & Insulates
- Meets O.E.M. Specs: Ford: ESB M99 D56 A1 Chrysler: MS-DB56

Auveco Part No.	Pre-Shrink I.D.	Post-Shrink I.D.	Length	Color	Unit Pkg.
18705	.225"	.050"	3-1/2"	Black	10
18706	.293"	.065"	3-1/2"	Black	10
18707	.427"	.095"	3-1/2"	Black	10
18708	.700"	.175"	3-1/2"	Black	5



Adhesive Lined Dual Wall Self-Sealing Heat Shrink Tubing

- 3 to 1 Shrink Ratio
- Excellent Insulating, Abrasion-Resisting & Strain Relief Properties
- Provides Waterproofing & Environmental Protection

Auveco Part No.	Size	Pre-Shrink I.D.	Post-Shrink I.D.	Length	Color	Unit Pkg.
16665	22-14 Gauge	.188"	.062"	12"	Black	4
16666	12-10 Gauge	.250"	.083"	12"	Black	4
18733	14-10 Gauge	.400"	.150"	6"	Black	4
19102	14-10 Gauge	.400"	.150"	6"	Black	25
18734	14-10 Gauge	.400"	.150"	6"	Red	4
19103	14-10 Gauge	.400"	.150"	6"	Red	25
18735	8-1 Gauge	.750"	.220"	6"	Black	4
19104	8-1 Gauge	.750"	.220"	6"	Black	25
18736	8-1 Gauge	.750"	.220"	6"	Red	4
19105	8-1 Gauge	.750"	.220"	6"	Red	25
18737	2-4/0 Gauge	1.100"	.375"	6"	Black	4
19106	2-4/0 Gauge	1.100"	.375"	6"	Black	25
18738	2-4/0 Gauge	1.100"	.375"	6"	Red	4
19107	2-4/0 Gauge	1.100"	.375"	6"	Red	25



18887

Six inch lengths of black thin wall, cross linked polyolefin, heat shrink tubing in a durable translucent polypropylene box. The tubing has 2:1 shrink ratio.

Heat Shrink Tubing Kit

Auveco Part No.	Qty.	Pre-Shrink Size	Post-Shrink I.D.	I.D.
18697	36	3/16"	.187"	.093"
18698	24	1/4"	.250"	.125"
18699	12	3/8"	.375"	.187"
18700	6	1/2"	.500"	.250"
18701	4	3/4"	.750"	.375"
18702	4	1"	1.00"	.500"

UNIT PACKAGE: 1

FUSE HOLDERS & ACCESSORIES

Photos not actual size

Sec. 12

12592

Nylon



Glass Tube Fuse Puller

UNIT PACKAGE: 1

12079

Nylon



Moulded In-Line Fuse Holder with 8" of 18 Gauge Wire
Use with Auveco 1/4" x 1-1/4" Glass Tube Fuses
Up to and including 20 Amps

UNIT PACKAGE: 3

11618

Nylon



Fuse Assembly with 30 Amp Fuse Included
12 Gauge Wire

UNIT PACKAGE: 5

18103

Tests ATO® (Blade Type) and Mini-Fuses.

Now you can make sure the fuse is good before installing it.

Also functions as a fuse puller.
40 Amp maximum

UNIT PACKAGE: 1



12359

In-Line Fuse Holder

Accommodates all ATO/ATC fuses from 3-30 Amps
Heavy Duty Hard Shell Construction
10" Loop of 14 Gauge Wire

UNIT PACKAGE: 3

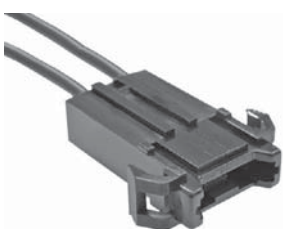

14055

In-Line Fuse Holder

Accommodates all ATO/ATC fuses from 3-30 Amps Heavy Duty Hard Shell Construction
10" Loop of 12 Gauge Wire

UNIT PACKAGE: 3



12363

In-Line Fuse Holder

Accommodates all ATO/ATC fuses from 3 thru 20 Amps. Comes with two 4" 16 Gauge Wire Leads.

UNIT PACKAGE: 5

20789

In-Line Mini Fuse Holder



30 Amp Maximum
12 Gauge Wire

Use with Auveco Mini Fuses 16351-16360
Replaces Auveco 17648
Fuse NOT Included

UNIT PACKAGE: 3

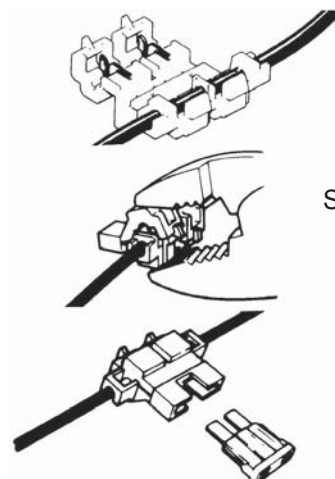

12977

Self-Stripping Fuse Holder



Mates with most plug-in blade type fuses found in late-model domestic and some import cars.
For 18-14 gauge copper wire.

32 volts maximum
20 amp maximum with 14 gauge wire
10 amp maximum with 16 gauge wire
7.5 amp maximum with 18 gauge wire

UNIT PACKAGE: 5

Photos not actual size

Sealed Fuse Holders For ATM Mini® Fuses



20206

20, 25 & 30 Amp Capacity
10" Long 12 Gauge Cross-Linked Polyethylene Leads
Fuse NOT Included

UNIT PACKAGE: 1



20207

2-15 Amp Capacity
10" Long 16 Gauge Cross-Linked Polyethylene Leads
Fuse NOT Included

UNIT PACKAGE: 1

High Power Sealed Fuse Holder

20320

For ATC & ATO Fuses
40 Amp Capacity
12" Long 10 Gauge
105 Strand
EZ Flex Wire Leads
Fuse NOT Included

UNIT PACKAGE: 1

Environmentally Sealed Blade Type Fuse Holder

Also used as Fuel Pump Fuse Holder on GM Vehicles



13686

(GM: 12101917; Delco: PT-189)

UNIT PACKAGE: 1

Electrical system protection for fleets, construction equipment, aircraft service vehicles, outdoor power equipment and marine installations.

Resistant to moisture, salt spray and engine compartment fluids. Withstands 50g physical shock. Operating temperature range from -40° to 125°C.

- Nylon Body with Latching Cap
- Silicone Rubber Seals at Wires and Cap
- 12 Gauge SE/GPT Wire Leads
- 3 to 30 Amp Capacity - Type ATC/ATO Fuses
 - 5" Long Wire Leads
 - Fuses NOT included

Low Profile JCase Fuses



Auveco Part No.	Amp Rating	Color	Unit Pkg.
21472	20	Blue	3
21473	25	White	3
21474	30	Pink	3
21106	40	Green	3
21475	50	Red	3
21476	60	Yellow	3

PAL™ (Pacific Auto Link) Fuses



Type 1

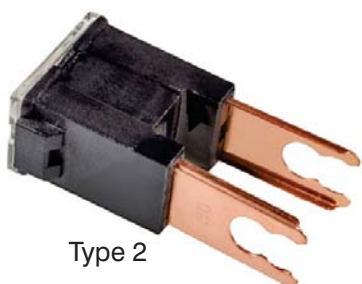

Type 2



Type 3



Type 4

Auveco Part No.	Type	Amp Rating	Color	Unit Pkg.
20560	1	20	Blue	1
15926	1	30	Pink	1
15927	1	40	Green	1
19294	1	50	Red	3
15928	1	60	Yellow	1
15929	2	30	Pink	1
15930	2	60	Yellow	1
15931	2	80	Black	1
15932	3	30	Pink	1
15933	3	40	Green	1
19295	3	80	Black	2
19296	3	100	Blue	2
20551	4	20	Blue	2
20552	4	30	Pink	2
20553	4	40	Green	2
20554	4	50	Red	2
20555	4	60	Yellow	2

Photos not actual size

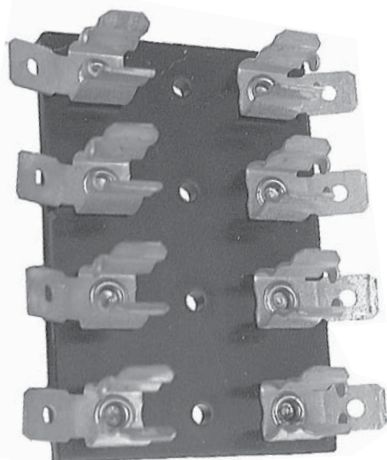

13445

Four Gang Fuse Block

Size: 2-7/16" x 2-15/16" x 3/4"

For use with SFE-20 Amp. fuse or any 3 AG series fuse. Phosphor bronze fuse clips. Brass screws

UNIT PACKAGE: 1

Terminal/Junction Blocks



For marine and exposed applications. Brass nickel plated terminal links and binding head terminal screws. Moisture repellent molded ABS base with protective insulator barrier strips. 20 Amp rating.

13446

4 Gang (Circuits)

Size: 3-1/4" x 1-5/16" x 5/8"

UNIT PACKAGE: 1

13447

6 Gang (Circuits)

Size 3-3/8" x 1-1/8" x 9/16"

UNIT PACKAGE: 1

13449

10 Gang (Circuits)

Size: 5-1/8" x 1-1/8" x 9/16"

UNIT PACKAGE: 1



14474

Blade Type Fuse Tap

A quick, easy alternative to direct wiring when tapping the "hot side" of the fuse block. The blade type fuse tap is made of sturdy brass and is engineered for quick connect and disconnect of accessories such as C.B. radios, hand-held lights, etc.

UNIT PACKAGE: 25

Installation can be completed in three steps:

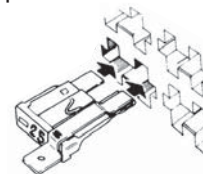

1. Use a test probe to locate the "hot side" of the circuit in the fuse block. Then snap the tap over the corresponding "hot side" blade of the fuse. Insert the fuse into the fuse block.

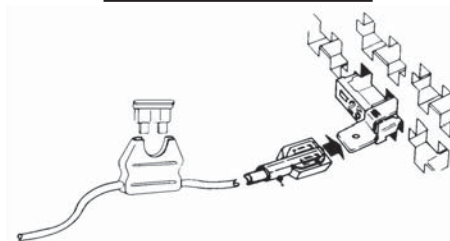

2. Crimp one end of an in-line fuse holder (with the fuse installed) to a fully insulated nylon .250" female quick-connect terminal. Attach the other fuse holder lead to the accessory wire.

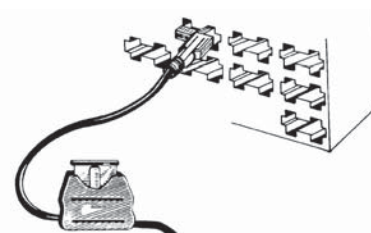

3. Complete the connection by sliding the female quick-connect terminal onto protruding tab of the tap.



17686

Mini Fuse Blade Type Fuse Tap

"Tapping" fuse blocks equipped with Mini® Fuses are no Problem!

Now there's a quick, easy alternative to direct wiring for tapping the "hot side" of mini fuse style fuse blocks. The blade type fuse tap is made of .016" thick sturdy brass with a .187" (3/16") wide tab. It is engineered for quick connect and disconnect of accessories.

UNIT PACKAGE: 50

Installation can be complete in 3 steps:



1. Locate "hot side" of circuit in fuse block with a test probe. Slide the tap onto corresponding "hot side" blade of fuse.

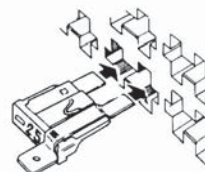

2. Insert the fuse into the fuse block

3. Crimp one end of an in-line fuse holder (with the fuse installed) to the appropriate Auveco female connector 8781 (16-14 Ga.) or 12159 (22-18 Ga.). Attach the other fuse holder lead to the accessory wire. Slide the female connector onto protruding tab of the tap.

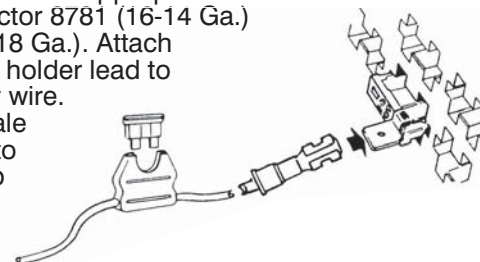

ATC®/ATO® (Blade Type) Fuses



Auveco Part No.		Amp Rating	Color
Unit Pkg. 5	Unit Pkg. 25		
12534	12548	3	Violet
12535	12549	4	Pink
12536	12550	5	Tan
12537	12551	7-1/2	Brown
12538	12552	10	Red
12539	12553	15	Blue
12540	12554	20	Yellow
12541	12555	25	White
12542	12556	30	Green

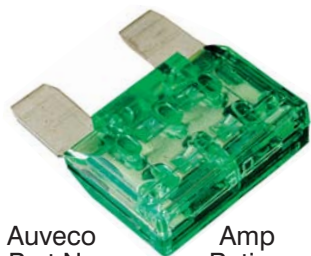

Maxi™ Fuses

Auveco Part No.	Amp Rating	Color	Unit Pkg.
15505	20	Yellow	2
15506	30	Green	2
15507	40	Orange	2
15508	50	Red	2
15509	60	Blue	2



Low Profile Mini Fuses

Auveco Part No.	Amp Rating	Color	Unit Pkg.
21602	5	Tan	5
21603	7.5	Brown	5
21436	10	Red	5
21437	15	Blue	5
21166	20	Yellow	5
21438	25	Clear	5
21604	30	Green	5

Mega® Fuses



Auveco Part No.	Amp Rating	Unit Pkg.
21598	40	2
21599	60	2
21600	80	2
18986	100	2
18987	125	2
18988	150	2
18989	175	2
18990	200	2
22118	250	2
22119	300	2
22120	500	2

FUSES



Glass Tube Fuses

Auveco Part No.	Size	Amp	Code	Unit Pkg.
18981	1/4" x 1-1/4"	2	AGC-2	5
17625	1/4" x 1-1/4"	3	AGC-3	5
17626	1/4" x 1-1/4"	5	AGC-5	10
17627	1/4" x 1-1/4"	7.5	AGC-7.5	10
12545	1/4" x 1-1/4"	10	AGC-10	5
12546	1/4" x 1-1/4"	15	AGC-15	5
18982	1/4" x 1-1/4"	20	AGC-20	5
12543	1/4" x 1-1/4"	20	SFE-20	5
18983	1/4" x 1-1/4"	25	AGC-25	5
12544	1/4" x 1-7/16"	30	SFE-30	5
12547	1/4" x 1-1/4"	30	AGC-30	5



Mini® Fuses

Auveco Part No.	Amp Rating	Color	Unit Pkg.
16351	2	Gray	5
16352	3	Purple	5
16353	4	Pink	5
16354	5	Tan	5
16355	7.5	Brown	5
16356	10	Red	5
16357	15	Blue	5
16358	20	Yellow	5
16359	25	White	5
16360	30	Green	5



Micro Fuses 2 Blades

Auveco Part No.	Amp Rating	Color	O.E.M No.	Unit Pkg.
21828	5	Tan	GM: 19209790	5
21829	7.5	Brown	GM: 19209791	5
21830	10	Red	GM: 19209792	5
21831	15	Blue	GM: 19209793	5
21832	20	Yellow	GM: 19209794	5
21833	25	Natural	GM: 19209795	5
21834	30	Green	GM: 19209796	5



Micro Fuses 3 Blades

Auveco Part No.	Amp Rating	Color	O.E.M No.	Unit Pkg.
21749	5	Tan	Ford: DG9Z-14526-N GM: 19209797	2
21750	7.5	Brown	Ford: DG9Z-14526-S GM: 19209798	2
21751	10	Red	Ford: DG9Z-14526-P GM: 19209799	2
21752	15	Blue	Ford: DG9Z-14526-R GM: 19119304	2

Use with butt connectors on pages 205-211 • *Photos not actual size*



9905

(Chry: 2496279; GM: 2973932;
AMC: 3509575; IHC: 374985C1)

Instrument Panel Socket for 5/8" Hole
Bulb No. 158, 194, 194A
GM, Chrysler, AMC & International

UNIT PACKAGE: 10



12237

(Chry: 3744750; GM: 12004311,
25015169; Ford: C80Z-13711A)

Instrument Panel Socket for 1/2" Hole
Bulb No. 158, 194, 194A
GM, Ford & Chrysler

UNIT PACKAGE: 2



9883

(GM: 6298886,
6298892, 6298935;
Ford: D0DZ-15A434B)

Side Marker Assembly
Bulb No. 158, 194, 194A
GM & Ford

UNIT PACKAGE: 5



11441

Instrument Panel and
Marker Lights
Bulb No. 158, 194, 194A
GM & Ford

UNIT PACKAGE: 10



11166

(GM: 6294015, 8901283, 8918527;
Ford: D40Z-13410E,
D7AZ-13412A, D7FZ-13412A)

Side Marker and
License Plate Lights
Bulb No. 158, 194, 194A
GM & Ford

UNIT PACKAGE: 1



13540

(8912750)

Side Marker, License,
Parking & Tail Lights
Bulb No. 158, 194, 194A
GM

UNIT PACKAGE: 1

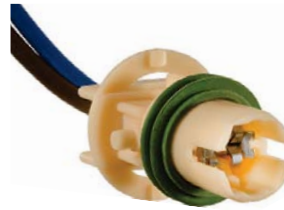

17108

(12083007)

Marker Light Pigtail
Bulb No. 24
GM 1988-On

UNIT PACKAGE: 1



18924

(12083460)

Rear Side Marker Lights
Bulb No. 158, 194, 194A
GM 1985-On

UNIT PACKAGE: 1



13549

(12001470)

Side Marker, License,
Tail & Stop Lights
Bulb No. 158, 194, 194A
GM

UNIT PACKAGE: 1

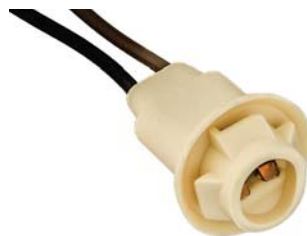

13558

(6298892, 6298886)

Side Marker Assembly
Bulb No. 158, 194, 194A
GM

UNIT PACKAGE: 1



8755

(2978302)

License Plate, Back-Up
& Instrument Panel Lights
For 1-1/8" Hole
Bulb No. 63, 67, 81, 87, 89, 93,
209, 1003, 1073, 1129, 1133 & 1141
GM

UNIT PACKAGE: 10



8759

Signal, Park, Stop
& Tail Lights
For 3/4" Hole
Bulb No. 198, 1016,
1034, 1154 & 1157
GM

UNIT PACKAGE: 5

Use with butt connectors on pages 205-211 • *Photos not actual size*



8756

(2974309)

Signal, Park, Stop & Tail Lights
For 1-1/8" Hole
Bulb No. 198, 1016, 1034, 1154 & 1157
GM

UNIT PACKAGE: 10



13544

(12003878, 8904251)

Back-up, Cornering
& Turn Signal
Bulb No. 1156
GM

UNIT PACKAGE: 1



8754

Weatherproof Signal,
Park, Stop & Tail Lights
For 3/4" Hole
Bulb No. 198, 1016, 1034, 1154 & 1157
GM

UNIT PACKAGE: 5

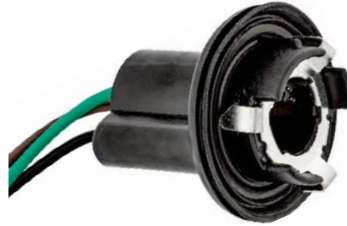

11446

(8902487, 8903283,
8907701 & 8909908)

Stop & Tail Lights
Bulb No. 1157
GM

UNIT PACKAGE: 5



8750

(2974309, 2983540,
6299087 & 8912698)

Signal, Park, Stop & Tail Lights
Bulb No. 1034, 1154 & 1157
GM

UNIT PACKAGE: 5



11154

(8903202, 8914822)

Park, Stop & Tail Lights
Bulb No. 1034,
1154 & 1157
GM

UNIT PACKAGE: 1



11157

(AMC: 4486948;
GM: 2983540, 8912698;
6299087)

Signal, Park, Stop
& Tail Lights
Bulb No. 1034,
1154 & 1157
GM & AMC

UNIT PACKAGE: 1



11475

(8903202, 8914822)

Park, Stop & Tail Lights
Bulb No. 1034, 1154 & 1157
GM

UNIT PACKAGE: 5



11156

(GM: 5963268,
8904437, 8909518;
IHC: 57172C91)

Back-up & Cornering
Bulb No. 1156
GM & IHC

UNIT PACKAGE: 1



21006

(15306157)

White Shell, Natural Insert

Daytime Running Lights
& Turn Signal
Bulb No. 3156 & 4156
GM 1999 - On

UNIT PACKAGE: 1



11476

(8903203, 8914823)

Park, Stop & Tail Lights
Bulb No. 1157
GM

UNIT PACKAGE: 5



17175

(12076946)

Ivory Shell

Stop, Tail, Turn &
Parking Lights
Bulb No. 3057 & 3157
GM 1988-On

UNIT PACKAGE: 1

GM SOCKET ASSEMBLY & HARNESS CONNECTORS

Use with butt connectors on pages 205-211 • *Photos not actual size*

Sec. 12

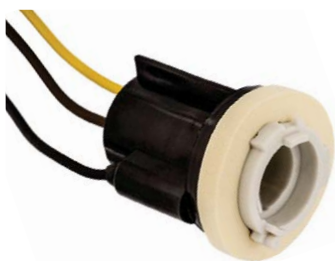

13543
(8919916,12013813)

Park, Stop &
Tail Lights
Bulb No. 1157
GM

UNIT PACKAGE: 1



13546
(12003757)

Signal & Park Lights
Bulb No. 198 & 2057
GM

UNIT PACKAGE: 1



16585
(12083005)

Signal, Park, Stop & Tail Lights
Dual Filament Wedge Base
Bulb No. 3057
GM

UNIT PACKAGE: 1



17172
(12083680)
Black Shell

Stop, Tail, Turn
& Parking Lights
Bulb No. 3057 & 3157
GM: 1989-On

UNIT PACKAGE: 1



16586
(12083006)

Signal, Park, Stop &
Tail Lights
Dual Filament Wedge Base
Bulb No. 3057
GM

UNIT PACKAGE: 1



17173
(12083689)
Ivory Shell

Stop, Tail, Turn
& Parking Lights
Bulb No. 3057 & 3157
GM 1990-On

UNIT PACKAGE: 1



18923
(12027133)

Back-Up Lights
GM 1982-On

UNIT PACKAGE: 1



17174
(12085330)
Brown Shell

Back-Up Lights
Bulb No. 2456 & 3156
GM 1990-On

UNIT PACKAGE: 1

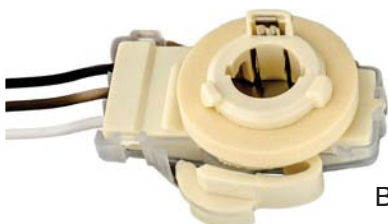

12600
(GM: 12003759;
AMC: 812893)

90° Pigtail &
Socket Assembly
Bulb No. 1016, 1034,
1154 & 1157
GM & AMC

UNIT PACKAGE: 1



14918
(12048369)

Headlight Socket Assembly
for High-Low 9004 & 9007
Halogen Bulb
GM, Ford & Imports

UNIT PACKAGE: 1



13545
(12003758)

Tail Lights
Single Contact
Bulb No. 87, 93 & 1156
GM

UNIT PACKAGE: 1



16174

Headlight Socket Assembly
For Low Beam 9006
Halogen Bulb
Single Indexing Groove
GM, Ford, AMC & Imports

UNIT PACKAGE: 4

Use with butt connectors on pages 205-211 • *Photos not actual size*



16175
(GM: 12101898)

Headlight Socket Assembly
For High Beam 9005
Halogen Bulb
Two Indexing Grooves
GM, Ford, AMC & Imports

UNIT PACKAGE: 4



16967
(12101906)

Heater Blower connector
pigtail on GM 1985-On.
Can also be used as
an ATO/ATC Fuse Holder.
Features two 9" long 12 gauge
GXL wire leads.

UNIT PACKAGE: 1



17114
(12085496)

Direct Ignition Throttle
Body Injection Pigtail
GM 1987-On

UNIT PACKAGE: 2



17112
(12085497)

Not Supplied By O.E.M.
Distributor Module Pigtail
Used on GM distributor
module 1987466
on 6 cylinder 2.8 engines
1985-On

UNIT PACKAGE: 1



18916
(12085483)

Ignition Module, Crankshaft
Coolant Sensor & Power
Steering Pressure Switch
Harness Connector
GM 1986-On

UNIT PACKAGE: 1



18870
(12101855)

Direct Ignition
Vehicle Speed Sensor
Harness Connector
GM
1987-On

UNIT PACKAGE: 1



18867
(12101880)

Direct Ignition
Harness Connector
GM
1987-On

UNIT PACKAGE: 1



18318
(12101857)

Air Divert Valve
Harness Connector
GM 1994-87

UNIT PACKAGE: 1



18320
(12101856)

Air Switch Valve
Harness Connector
GM 1993-91

UNIT PACKAGE: 1



18524
(12085497)

MAP Mass Air Flow Sensor
Harness Connector
GM with 2.8 Eng &
Sequential Fuel Injection
1989-85

UNIT PACKAGE: 1



18868
(12085495)

Mass Air Flow Sensor
Harness Connector
GM 1988-On

UNIT PACKAGE: 1



16694
(12043215, 12085498)

Cornering & Fog Light Socket
for 881 & H11 Halogen Bulbs
GM

UNIT PACKAGE: 1

GM SOCKET ASSEMBLY & HARNESS CONNECTORS

Sec. 12

Use with butt connectors on pages 205-211 • *Photos not actual size*



21490

(GM: 12102664, 88862264)
(Ford: 1U2Z-14S411-YA)

Fog & Front Lights, Power Steering & Oil Pressure Switch Harness Connector
GM 2005 - 1986
Ford 2004 - 1995
Jeep Eagle 1994

UNIT PACKAGE: 1



17110

(12102747)

Windshield Washer Pump, Low Coolant Sensor Harness Connector
GM Cars & Trucks 1992-87

UNIT PACKAGE: 1



17111

(12116958)

Horn Harness Connector
Fits Horns 1999160, 1999161, 10456327 and 10456328
GM 1988-On

UNIT PACKAGE: 1



21212

(88988609)

Window Motor Regulator Harness Connector
Two 12 Gauge
10" Long Leads
GM 1995 - On

UNIT PACKAGE: 1



16693

(12046624, 12102620)

Replacement harness connector used with 1985-on GM Manifold Air Temperature Sensors including 25036751. Features two 9" long 18 gauge wire leads.

UNIT PACKAGE: 1



18917

(12085538)

Camshaft Sensor Harness Connector
Buick, Olds & Pontiac
1992-86

UNIT PACKAGE: 1



18925

(25117765)

E.F.I. Fuel Pump Harness Connector
GM with Fuel Pump in Gas Tank 1995-88

UNIT PACKAGE: 1



19891

(Not Available from O.E.M.)

Windshield Wiper Motor Harness Connector
GM 1994 - 86

UNIT PACKAGE: 1



17109

(12085525, 12085527, 12085528, 12101895, 12117361)

3 Wire Alternator Harness Connector
Two 18 gauge and one 12 gauge leads
Can be used to replace two wire and single wire harness connectors by taping (do NOT cut) the appropriate unused leads.

GM 1986-On

UNIT PACKAGE: 1

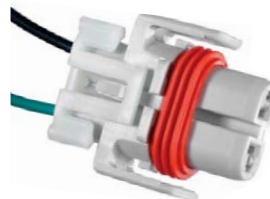

21220

(GM: 88987187)

Headlight Socket Harness Connector for H9 Halogen Bulb (Auveco Bulb No. BH9)

GM, Audi, Mazda, Mini-Cooper, Porsche, Volkswagen & Volvo

UNIT PACKAGE: 1



17113

(12101937)

A.C. Compressor Clutch Harness Connector
GM Cars & APV 1989-On

UNIT PACKAGE: 1



16514

(12085503)

Replacement harness connector used on GM V-5 Air Conditioning Compressor Pressure Cut-off Switches. Fits GM low Pressure Switch 6551946 and others. Index slot is at three o'clock position. Features two 9" long 18 gauge wire leads

UNIT PACKAGE: 1

Use with butt connectors on pages 205-211 • *Photos not actual size*



18527
(12102748)

Throttle Position Sensor
Harness Connector
GM 1994-90

UNIT PACKAGE: 1



14580
(12102621)

Radiator Fan Sensor Switch
Harness Connector
Fits electric cooling fan switches:
3040674, 14043275 and 14043276
GM 1980-On

UNIT PACKAGE: 1



18674
(12126451)

Coolant Temperature
Sensor Harness Connector
Fits Sensor 10232601 & 25037203
GM 1987-On

UNIT PACKAGE: 1



17107
(12117385)

Oxygen Sensor
Connector Pigtail

Fits the Following Oxygen Sensors:
8990469 (AC-Delco AFS13P)
8990625 (AC-Delco AFS15P)
8990741 (AC-Delco AFS16P)
10042186 (AC-Delco 213-15)
25105107 (AC-Delco AFS20)
25105901 (AC-Delco AFS21)
25106073 (AC-Delco AFS22)
Most GM Models 1982-On

UNIT PACKAGE: 1



16962

(Not Supplied by O.E.M.)

Harness Connector used with GM
Mixture Control Solenoid Kits:
17067343, 17067344 and
17111102 on
2 & 4 barrel Rochester
Varajet Carburetors.
GM cars and trucks 1980-On

UNIT PACKAGE: 1



19882
(12085485)

Back-Up Light Switch &
Speed Sensor Harness Connector
Used with Switch 23049569,
PT107 & IACV Motor
GM 1971-On

UNIT PACKAGE: 1



16965
(12085507)
Gray

Air Conditioner Pressure
Switch Harness Connector
Used on GM vehicles
(28 models) 1988-84

UNIT PACKAGE: 1



17198

(Not Supplied by O.E.M.)

Throttle Position Sensor
Harness Connector
Fits Sensor 17078051,
17078448 & 17078481 on
2 & 4 Barrel Rochester Carburetors
GM 1990-80

UNIT PACKAGE: 1



16964
(12085502)
Green

Manifold Absolute Pressure
(MAP) Harness Connector.
Fits GM MAP Sensor 6137039
on GM vehicles (38 models)
1982-on

UNIT PACKAGE: 1



17199
(12085533)

Transmission
Converter Clutch
Harness Connector

3 Wires (Cavity "C" is not wired)
GM 1990-84

UNIT PACKAGE: 1

GM SOCKET ASSEMBLY & HARNESS CONNECTORS

Sec. 12

Use with butt connectors on pages 205-211 • *Photos not actual size*



18918

(12085506)

Fuel Injection
Idle Air Control Valve,
Stoplight Switch & Torque
Converter Clutch Valve
Harness Connector
GM 1985 - On

UNIT PACKAGE: 1



16968

(12085491)

Fuel Injector
Solenoid Harness Connector
Fits GM Multi-Port Fuel
Injector 1711799 on 2.8
and 3.1 liter engines
(27 models) 1986 - On
Fits Fuel Injectors on Ford,
Chrysler & Imports (Bosch)

UNIT PACKAGE: 1

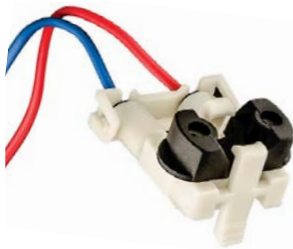

17463

(12102568)

Fuel Injector Connector for
TBI (Throttle Body Injector)
Systems
All GM (Including
Trucks) 1978 - On

UNIT PACKAGE: 1



17690

(12101903)

Washer Fluid Sensor
Harness Connector
Also used on Back-Up
Light Switch & A.C. Compressor Switch
GM 1985-On

UNIT PACKAGE: 5



19556

(12117354)

Harness Connector
Brake Light Switch 25529862
GM: Camaro, Caprice,
Century, Firebird, Lumina APV,
K,S, & T Truck, Silhouette &
Trans Sport 1991 - On

UNIT PACKAGE: 1



18525

(Not Supplied by O.E.M.)

Tail Light
Harness Connector
GM Full Size Pick-Up
Trucks 1995 - 88

UNIT PACKAGE: 1



11444

Voltage Regulator
Pigtail
GM

UNIT PACKAGE: 10



21033

(88953358)

Harness Connector
For Blower Motor Resistors 89019088, 89019089 &
89019100 and Various Relays, Switches & Actuators
8" Leads
GM Cars and Light & Medium Duty Trucks 1990 - On

UNIT PACKAGE: 1



21542

(GM: 88953358)

Harness Connector with Seven 12 Gauge, 12" Leads
For Blower Motor Resistors 89019088, 89019089 &
89019100 and Various Relays, Switches & Actuators
GM Cars and Light & Medium Duty Trucks 1990 - On

UNIT PACKAGE: 1



19554

(12101927)

Harness Connector Headlight
and Ignition Switches
15693540, 10471139,
1070881, 26693547 & 15693548
GM: Astro, Safari, C, K, S, T Trucks,
Kodiak & Grand Am 1990-On

UNIT PACKAGE: 1



11440

(GM: 2962510)

Air Conditioner Blower Relay
Harness Connector
18 Gauge Wire
GM, AMC & Chrysler

UNIT PACKAGE: 10

Use with butt connectors on pages 205-211 • *Photos not actual size*



11443
(6294493)

Alternator Harness Connector with Transistorized Alternators GM

UNIT PACKAGE: 10



19555
(12102757)

Harness Connector Headlight Dimmer Switch GM Most Models 1990-On

UNIT PACKAGE: 1



17691
(12101909)

Alternator Harness Connector Two 16 Gauge Leads Fits Delcotron Models 10-SI, 12-SI, 15-SI & 27-SI with Internal Voltage Regulator GM 1980-71

UNIT PACKAGE: 5



18871
(12101939)

Harness Connector for Cooling Fan, Fuel Pump, Starter Interrupt Relay & Fan Control Switch Cadillac 1988-On

UNIT PACKAGE: 1



11442
(2977373)

Alternator Harness Connector with External Voltage Regulators GM 1977-62

UNIT PACKAGE: 10



18530
(Not Supplied by O.E.M)

Headlight Switch Harness Connector Fits Switch 1995217 GM 1991-68

UNIT PACKAGE: 1



13547
(2977373)

Alternator Extender Harness Connector with Female Connector GM 1974-62

UNIT PACKAGE: 2



9884
(916638, 916581)
Plastic

Amber Lens Front Fender Marker Lamp Assembly **Use with Auveco 9883** GM

UNIT PACKAGE: 1



13548
(6294493)

Alternator Extender Harness Connector with Female Connector GM 1971-On

UNIT PACKAGE: 2



9885
(916638, 916581)
Plastic

Clear Lens Front Fender Marker Lamp Assembly **Use with Auveco 9883** GM

UNIT PACKAGE: 1



11436

Dimmer Switch Harness Connector GM

UNIT PACKAGE: 10



9916
(916632)
Plastic

Red Lens Rear Quarter Marker Lamp Assembly **Use with Auveco 9883** GM

UNIT PACKAGE: 1

Use with butt connectors on pages 205-211 • *Photos not actual size*



12237

(Chry: 3744750; GM: 12004311, 25015169; Ford: C80Z-13711A)

Instrument Panel Socket for 1/2" Hole
Bulb No. 194
GM, Ford & Chrysler

UNIT PACKAGE: 2

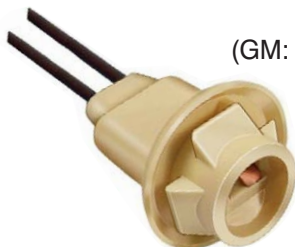

9883

(GM: 6298886, 6298892, 6298935; Ford: D0DZ-15A434B)

Side Marker Assembly
Bulb No. 158, 194, 194A
GM & Ford

UNIT PACKAGE: 5



11441

Instrument Panel and
Marker Lights
Bulb No. 158, 194, 194A
GM & Ford

UNIT PACKAGE: 10



11166

(GM: 6294015, 8901283, 8918527; Ford: D40Z-13410E, D7AZ-13412A, D7FZ-13412A)

Side Marker &
License Plate Lights
Bulb No. 158, 194, 194A
GM & Ford

UNIT PACKAGE: 1



8761

License Plate & Instrument
Panel Lights
For 5/8" Hole
Bulb No. 51, 53, 55, 57 & 57X
Ford

UNIT PACKAGE: 10



13537

(D1AZ-13410B)

Stop & Tail Lights
with one Ground Male
Blade Terminal
Bulb No. 1034, 1154 & 1157
Ford

UNIT PACKAGE: 1



13533

(D3AZ-13410B, D5DZ-13410A)

Rear Lights
Bulb No. 1157
Ford

UNIT PACKAGE: 1



13535

(D3AZ-13410A)

Signal, Stop & Tail Lights
Bulb No. 1156
Ford

UNIT PACKAGE: 1

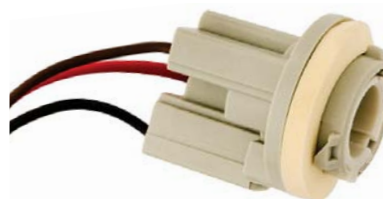

14133

(D4LY-13410-A)

Tail & Stop Lights
Bulb No. 1157
Ford

UNIT PACKAGE: 1



14131

(D3AZ-13410-E)

Back-up/Cornering Lights
Bulb No. 1141
Ford

UNIT PACKAGE: 1



14128

(D4OZ-13234-A)

Signal & Parking Lights
Bulb No. 1157
Ford

UNIT PACKAGE: 1



14132

(D3AZ-13410-G)

Tail & Stop lights
Bulb No. 1157
Ford

UNIT PACKAGE: 1



14135

(D1FZ-13234-A)

Parking Lights
Bulb No. 1157
Ford

UNIT PACKAGE: 1

Use with butt connectors on pages 205-211 • *Photos not actual size*



14130
(D4ZZ-13234-A)

Signal & Parking Lights
Bulb No. 1157
Ford

UNIT PACKAGE: 1

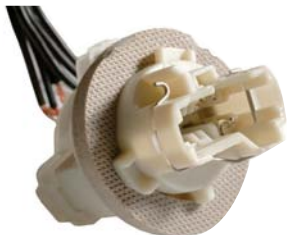

20837
(Not Supplied by O.E.M.)

Stop & Tail Light
Three 20 Gauge
Wire Leads
Uses 2458, 3057 &
3157 Wedge Type Bulbs
Ford 1987 - On

UNIT PACKAGE: 1



20848
(Not Supplied by O.E.M.)

Rear Light Assembly
Harness Connector
Four 18 Gauge Wire Leads
Ford F250 thru F750 without Pick Up Box 1999 - On

UNIT PACKAGE: 1

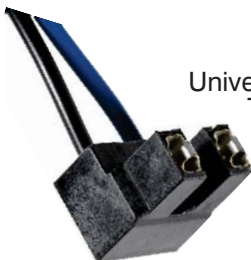

21210
(Not Available from O.E.M.)

Universal Headlight Harness Connector
Two 18 Gauge 6" Long Leads
For H7 Halogen Bulbs
Ford, Audi, BMW, Hyundai,
Kia, Mazda, Mercedes,
Mini Cooper, Saab & Subaru

UNIT PACKAGE: 1



16174

Headlight Socket Assembly
For Low Beam 9006
Halogen Bulb
Single Indexing Groove
GM, Ford, AMC & Imports

UNIT PACKAGE: 4



16175
(GM: 12101898)

Headlight Socket Assembly
For High Beam 9005
Halogen Bulb
Two Indexing Grooves
GM, Ford, AMC & Imports

UNIT PACKAGE: 4



21490
(GM: 12102664, 88862264)
(Ford: 1U2Z-14S411-YA)

Fog & Front Lights,
Power Steering & Oil Pressure
Switch Harness Connector
GM 2005 - 1986
Ford 2004 - 1995
Jeep Eagle 1994

UNIT PACKAGE: 1



14918
(12048369)

Headlight Socket Assembly
For High-Low 9004 &
9007 Halogen Bulb
GM, Ford & Imports

UNIT PACKAGE: 1

HAVE YOU VISITED US ONLINE?

Auveco's website has been completely renovated. Our new design is user friendly with easy navigation and ordering.

Product is searchable by car make, OEM number and category, as well as, several attribute drop downs within individual categories. All product also has stock availability listed.

Make sure to head over to www.auveco.com to receive up to date information on all our products.



19890
(Not Available from O.E.M.)

Back-Up Light Switch
Harness Connector
Fits Switches
C9TZ-15520C & SW-849
Ford Trucks & T-Bird 1967-On

UNIT PACKAGE: 1



19125
(Not Supplied by O.E.M.)

Stop, Tail, Turn & Parking Lights
Plugs into Light Socket Base
For Double Filament
Wedge Type Bulbs
Ford Ranger, Explorer & Econoline
1991-On

UNIT PACKAGE: 1

Use with butt connectors on pages 205-211 • *Photos not actual size*



22184

(Ford: F1TZ-13411-A;
GM: 88860592)

Park, Stop & Turn Signal
Lights Socket Base
Bulb No. 3157
Three Terminals
Black Housing
90° Angle Base

Use with Auveco 19125
Ford Cars &
Trucks 1994 - On

UNIT PACKAGE: 1



19126

(Not Supplied by O.E.M.)

Back-Up Lights Plugs into
Light Socket Base
For Single Filament
Wedge Type Bulbs
Ford Ranger, Explorer &
Econoline 1991-On

UNIT PACKAGE: 1



18463

(Not Supplied by O.E.M.)

Headlight Switch
Harness Connector
Fits Headlight Switches
E6DZ-11654A & F2DZ-11654A
Ford Taurus & Mercury Sable
with Rotary Knob 1994-86

UNIT PACKAGE: 1



17624

(Not Supplied by O.E.M.)

Headlight Switch Assembly
Harness Connector
Fits Instrument Panel
Headlight Switch
E7TZ-11654-C
Ford Trucks: F150, F250, F350
& Bronco 1991-87

UNIT PACKAGE: 1



18464

(Not Supplied by O.E.M.)

Turn Signal Switch
Harness Connector
Fits Switch E7FZ-13341-A
Ford Tempo, Topaz, EXP, LN7,
Capri, Mustang, LTD, Marquis,
Escort & Lynx 1994-85

UNIT PACKAGE: 1



20547

(Not Supplied by O.E.M.)

Multi-Function Switch
Harness Connector
Fits 13K359 Switches E8DZ-B,
E8ZZ-B, E9DZ-A,B,C, E90Y-D,
E9SZ-B,D,E & F0ZZ-A,B
Ford Taurus, Sable, T-Bird, Cougar
and Continental 1993 - 86

UNIT PACKAGE: 1



20548

(Not Supplied by O.E.M.)

Multi-Function Switch
Harness Connector
Fits 13K359 Switches E8DZ-B,
E8ZZ-B, E9DZ-A, B, C, E90Y-D,
E9SZ-B, D, E & F0ZZ-A, B
Ford Taurus, Sable, T-Bird, Cougar and
Continental 1993 - 86

UNIT PACKAGE: 1



20246

(Not Supplied by O.E.M.)

Multi-Function Switch
Repair Harness
Eleven 18 Gauge Leads
Aerostar, E Van, Expedition,
Mustang, Navigator, Sable,
Taurus & Windstar 1992 - On

UNIT PACKAGE: 1



20550

(Not Supplied by O.E.M.)

Multi-Function Switch
Harness Connector
Fits 13K359 Switches
F1AZ-A, B, F1DZ-B, F1LY-B,
F10Y-D, F1VY-C, F3TZ-B, F3UZ-C,
F4ZZ-AA, F58Z-A, F5AZ-A, F5TZ-B, F65Z-AA, F6DZ-A,
F75Z-AB,AC,BA, F77Z-AA, F79Z-CA & F85Z-AA
Ford Aerostar, Bronco, Continental, Cougar,
Expedition, Explorer, F Pick-Ups, Mark Series,
Mountaineer, Mustang, Navigator, Ranger, Sable,
T-Bird, Taurus, Town Car & Windstar 1990 - On

UNIT PACKAGE: 1



18673

(Not Supplied by O.E.M.)

Multi-Function Switch
Harness Connector
(Turn Signal & Windshield Wiper)
Fits Switch E9DZ-13K359-A, B, C,
E8ZZ-13K359-B & F0ZZ-13K359-A
Ford Mustang 1993-87
Taurus & Sable 1989-86

UNIT PACKAGE: 1

Use with butt connectors on pages 205-211 • *Photos not actual size*



17623

(Not Supplied by O.E.M.)

EEC IV Test Plug
Repair Harness Connector
Two Connectors with eight 18
Gauge Leads
Ford 1983-On

UNIT PACKAGE: 1



19581

(Not Supplied by O.E.M.)

EEC IV Test Plug
Repair Harness Connector
One 18 Gauge Wire Lead
**Component of Auveco
17623 Harness Connector**
Ford 1983-On

UNIT PACKAGE: 5



19881

(Not Supplied by O.E.M.)

Ignition Switch
Harness Connector
Used with Switches
D0TZ-11572A, SW944
Ford Trucks: 100-900 Series
1970-On

UNIT PACKAGE: 1



20853

(Not Supplied by O.E.M.)

Ignition Coil
Harness Connector
Two 16 Gauge Wire Leads
Fits Coils F7TZ-12029-CC &
1L2Z-12029-AA
Ford Cars & Lt. Duty Trucks
1999 - On

UNIT PACKAGE: 1



20172

(Not Supplied by O.E.M.)

EEC Relay Harness Connector
Used with Relay E3AZ-12A646-A
Two 18 Gauge Wire Leads,
Two 16 Gauge Wire Leads &
One 14 Gauge Wire lead
Ford Cars & Trucks 1981-On

UNIT PACKAGE: 1



20844

(Not Supplied by O.E.M.)

Electronic
Ignition Module
Harness Connector
Four 16 Gauge Wire Leads
Fits Modules
F2PZ-12A199-AA, DY683
Ford 1975 - On

UNIT PACKAGE: 1



20841

(Not Supplied by O.E.M.)

Electronic
Ignition Module
Harness Connector
Four 18 Gauge Wire Leads
Fits Module F2PZ-12A199-AA, DY683
Ford Cars & Lt. Trucks 1985 - 75
700 Series & Larger 1991 - 75

UNIT PACKAGE: 1



17684

(Not Supplied by O.E.M.)

Ignition Switch
Harness Connector
Fits Ignition Switch
E6FZ-11572A
Ford 1992-80

UNIT PACKAGE: 1



18676

(E6DZ-14A411-A)

Ignition Switch
Harness Connector
Fits Switch E7DZ-11572-A
Ford Taurus, Sable &
Lincoln Continental
1986-On

UNIT PACKAGE: 1



18214

(Not Supplied by O.E.M.)

Ignition Module
Harness Connector
Fits Ignition Module
E8TZ-12A297A
Ford Ranger: 1995-88

UNIT PACKAGE: 1

Use with butt connectors on pages 205-211 • *Photos not actual size*



18217
(E5ZZ-12A209A)

Ignition Module &
Neutral Safety Switch
Harness Connector
For E.E.C. IV Ignition 1995-83
Ford Neutral Safety Switch
E80Z-7A247-A 1988-On

UNIT PACKAGE: 1



18819
(Not Supplied by O.E.M.)

Heater & Air Conditioner
Blower Switches
Harness Connector
Fits most Ford Switches with
Base Number 19986
1973-On

UNIT PACKAGE: 1

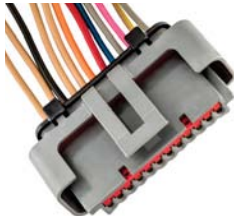

19623
(Not Supplied by O.E.M.)

Ignition Control Module Harness
For Modules F1AZ,
F4SZ-12072A & F5SZ-12072AA
Wire Gauge: 5 of 18 & 7 of 16
8" Leads
Ford: Full Size Trucks & Vans, T-Bird,
Cougar Lincoln Town & Mark 1991 - On

UNIT PACKAGE: 1

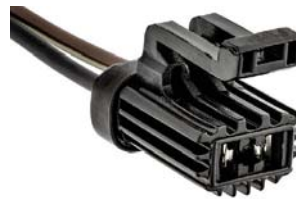

19582
(Not Supplied by O.E.M.)

Harness Connector for
Heater Blower Motor &
Radiator Cooling Fan Motor
Replaces Auveco 18213
Ford Truck & Vans 1986-82
Ford 4-Cylinder Engine
1979-On

UNIT PACKAGE: 5

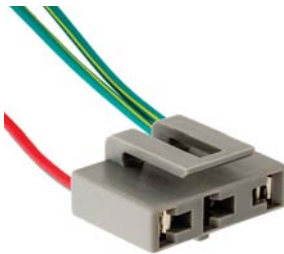

17661
(Not Supplied by O.E.M.)

Electronic Ignition Coil
Harness Connector
Fits Coil E73Z-12029A
Ford 1986-On

UNIT PACKAGE: 1

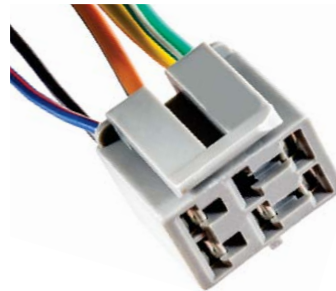

19883
(Not Supplied by O.E.M.)

Blower Motor Switch
Harness Connector
Used with Switch
E83Z-19986A, YH-481
Tempo & Topaz 1994-88

UNIT PACKAGE: 1



20839
(Not Supplied by O.E.M.)

Coil to Ignition
Harness Connector
Two 18 Gauge Wire Leads
Ford 1977 - On

UNIT PACKAGE: 10



19887
(Not Supplied by O.E.M.)

Auxiliary Blower Switch
Harness Connector
Fits Switch F2UZ-19986C, YH-538
Ford Vans E150/350 1992-On

UNIT PACKAGE: 1



17620
(Not Supplied by O.E.M.)

Air Conditioning Blower
Motor Resistor Assembly
Harness Connector
Fits Resistor Assembly
E7TZ-19A706-A
Ford Trucks 1983 - On

UNIT PACKAGE: 1



20849
(Not Supplied by O.E.M.)

Blower Motor Switch
Harness Connector
Five 16 Gauge Wire Leads
Fits Switches D0HZ-19986-A, YH411
Ford Heavy Duty Trucks 1989 - 1968

UNIT PACKAGE: 1

Use with butt connectors on pages 205-211 • *Photos not actual size*



17598

(Not Supplied by O.E.M.)
Air Conditioning Clutch
Cycling Pressure Switch
Harness Connector
Fits Switch E35Y-19E561-A
Ford 1980-On

UNIT PACKAGE: 1

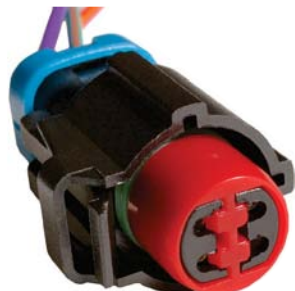

20843

(F81Z-19D887-AA, WPT-169,
1U2Z-14S411-AEA)
A/C Clutch Cycling
Pressure Switch
Harness Connector
Four 16 Gauge Wire Leads
Fits Switches F5VY-19E561-A,
F3AZ-19D594-C,
F5TZ-19D594-AA & YH-592
Ford 1990 - On

UNIT PACKAGE: 1



17617

(Not Supplied by O.E.M.)
Gray
Engine Cooling Fan
Motor Switch
Harness Connector
Fits Switch E43Z-8B607-A
Ford 1984-On

UNIT PACKAGE: 1



17618

(Not Supplied by O.E.M.)
Black
Engine Cooling Fan
Motor Switch
Harness Connector
Fits Switches E5SZ-8B607-A &
E4FZ-8B607-A
Ford 1984-On

UNIT PACKAGE: 1



19661

(Not Supplied by O.E.M.)
Blower Motor Resistor
Harness Connector
Fits Resistors F1CZ-19A706-A
& F7CZ-19A706-AA
One Connector has one each of
8" Long 20 Gauge, 16 Gauge, 14
Gauge & 12 Gauge GXL Wire Leads.
The other Connector has one 8" Long
12 Gauge GXL Wire Lead.
Ford Escort & Tracer 1991-On

UNIT PACKAGE: 1



22185

(Ford: 1U2Z-14S411-BHA,
WPT-153)
Blower Motor Resistor
Harness Connector
Two 10 Gauge &
Three 20 Gauge
TXL Wire Leads
Ford, Lincoln &
Mercury 2011 - 1991

UNIT PACKAGE: 1



20277

(Not Supplied by O.E.M.)
Heater/Air Conditioner
Fan Speed Switch
Harness Connector
Two 12 Gauge, one 14 Gauge &
One 16 Gauge Leads
Fits Switches E6DZ-A, E9SZ-A,
F2DZ-A & F2UZ-19986A,B
Ford Cougar, E Van, Mustang, Sable,
Taurus & T-Bird 1986 - On

UNIT PACKAGE: 1



20852

(Not Supplied by O.E.M.)
Radiator Cooling
Motor & Resistor
Harness Connector
Two 12 Gauge Leads
For Resistor F5RZ-8L603-AC &
Motors F8RZ-8C607-GC, GE, RF28, RF76 & RF81
Ford Contour, Mystique & Cougar 1995 - On

UNIT PACKAGE: 1

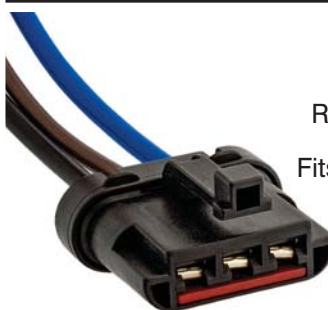

20549

(Not Supplied by O.E.M.)
Radiator Cooling Fan Motor
Harness Connector
Fits Fan & Shroud Assemblies
F4DZ-8C607B &
F5CA-8C607A
Ford Contour, Continental,
Escort, Mystique,
Sable & Taurus 1997 - 90

UNIT PACKAGE: 1



17619

(E4FZ-8C290-A)

Engine Cooling Fan
Harness Connector
Wiring Kit
Ford 4 Cylinder
(2.3 Engine)
with Air Conditioning
1983-On

UNIT PACKAGE: 1

Use with butt connectors on pages 205-211 • *Photos not actual size*



17683

(Not Supplied by O.E.M.)

Coolant Temperature Sensor
Harness Connector
Fits Sensor E1AZ-12A648A
Ford 1981-On

UNIT PACKAGE: 1



17621

(Not Supplied by O.E.M.)

Windshield Washer
Pump Harness Connector
Fits Pumps E0AZ-17664-A
& E30Z-17664-A
Ford 1968 - On

UNIT PACKAGE: 1



18216

(Not Supplied by O.E.M.)
Gray Shell

Exhaust Oxygen Sensor
Harness Connector
Fits Sensors F0TZ-9F472-A & C,
F09Z-9F472-A & C,
F1SZ-9F472-A & F1UZ-9F472-C
Ford 1995-89

UNIT PACKAGE: 1

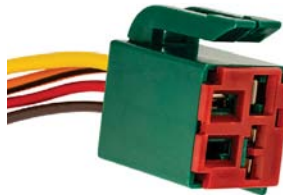

17622

(Not Supplied by O.E.M.)

Fuel Pump Relay Assembly
Harness Connector
Fits Relay Assembly
E3FZ-9345-B
Ford 1983 - On

UNIT PACKAGE: 1



18215

(Not Supplied by O.E.M.)
Black Shell

Exhaust Oxygen Sensor
Harness Connector
Fits Sensors
F0SZ-9F472-A & B,
F0TZ-9F472-B & E,
F02Z-9F472-C &
F03Z-9F472-A
Ford 1995-89

UNIT PACKAGE: 1



20842

(Not Supplied by O.E.M.)

Fuel Injectors
Harness Connector
One 16 Gauge &
One 18 Gauge Wire Leads
with Oval Injector Connectors
Ford 1999 - On

UNIT PACKAGE: 1



19889

(Not Supplied by O.E.M.)

Exhaust Oxygen Sensor
Harness Connector
Used with 3 Wire O2 Sensors
(Base No. 9F472)
Ford 1986-On

UNIT PACKAGE: 1



16968

(12085491)

Fuel Injector
Solenoid Harness Connector
Fits GM Multi-Port Fuel
Injector 1711799 on 2.8
and 3.1 liter engines
(27 models) 1986 - On
Fits Fuel Injectors on Ford,
Chrysler & Imports (Bosch)

UNIT PACKAGE: 1

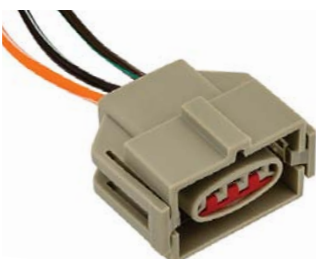

17662

(Not Supplied by O.E.M.)

EGR Sensor
Harness Connector
Fits Sensor E6AZ-9J460-A
Ford Escort, Lynx, Sable &
Taurus 1988 - On

UNIT PACKAGE: 1



18671

(Not Supplied by O.E.M.)

Air Conditioner
Clutch Field Coil
Harness Connector
Ford

UNIT PACKAGE: 10



19156

(Not Supplied by O.E.M.)

Alternator Regulator &
Air Conditioner Clutch Field
Harness Connector
Ford 1994-On

UNIT PACKAGE: 10

Use with butt connectors on pages 205-211 • *Photos not actual size*



20846

(F4VY-14A411-S)

Starter Solenoid
In-line Repair
Harness Connector
12 Gauge Wire Lead
Ford & Lincoln Town Car
1997 - 91

UNIT PACKAGE: 1



19076

(Not Supplied by O.E.M.)

Master Cylinder,
Door Jamb Switch
& Power Mirror
Harness Connector
Ford 1987-On

UNIT PACKAGE: 1



19157

(Not Supplied by O.E.M.)

Variable Speed Sensor
Harness Connector
For Speed Sensors with
Ford Base No. 9E731
Ford 1993-On

UNIT PACKAGE: 1



19813

(D1AZ-13410-A)

Power Brake
Harness Connector
Ford 1965-On

UNIT PACKAGE: 10



20561

(Not Supplied by O.E.M.)

Brake Light Switch
Harness Connector
Fits Switches YF1Z-13480-AA
& YF1Z-13480BA
Ford, Lincoln
& Mercury 2000 - On
Ford Explorer & Mercury
Mountaineer 1999 - 98

UNIT PACKAGE: 1



20845

(Not Supplied by O.E.M.)

Cam Shaft &
Crank Shaft Sensors
Harness Connector
Two 18 Gauge Leads
Fits Sensors F0CZ-6B288-A,
F1AZ-6B288-A, F1AZ-6C315-A
& XC3Z-6B288-AA
Ford 1991 - On

UNIT PACKAGE: 1



19880

(Not Supplied by O.E.M.)

Transmission Gear Shift
Position Sensor
Harness Connector
Eight Wire Leads

Used with Switch F5TZ-7A247
on Ford Trucks with E 4 OD Transmission,
RWD 1989-84 and E, F & U Series 1989-On

UNIT PACKAGE: 1



19004

(F2PZ-14A464C,
F4UB-14A464A)

Transmission MLP Sensor
Harness Connector
E150/350, F250/350 &
U150 (Bronco)
1990-On

UNIT PACKAGE: 1



20840

(Not Supplied by O.E.M.)

Glow Plug Pass thru
at Valve Cover Gasket
Harness Connector
Two 16 Gauge & Three 18 Gauge Wire Leads
Ford E350, F250-F550SD
& Excursion 7.3 Diesel 1996 - On

UNIT PACKAGE: 1

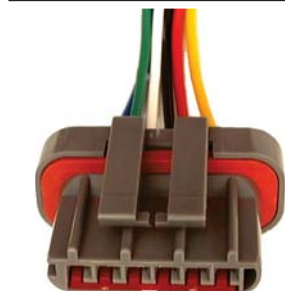

19885

(F4PZ-14A411C)

Windshield Wiper Motor
Harness Connector
For New Single Connector
Replacement Motors
(6 Positions)
Ford 1987-On

UNIT PACKAGE: 1

Use with butt connectors on pages 205-211 • *Photos not actual size*



18668
(Not Supplied by O.E.M.)
In-Tank Fuel Pump & Sending Unit Connector
Ford 1985 - On
UNIT PACKAGE: 5



17659
(Not Supplied by O.E.M.)
Voltage Regulator Plug Harness Connector
Sable, Taurus, Tempo & Topaz with Internal Voltage Regulator
1986 - On
UNIT PACKAGE: 1



11445
Voltage Regulator Harness Connector
Ford
UNIT PACKAGE: 10

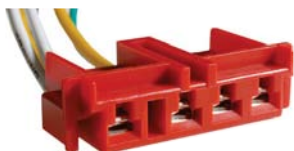

20850
(Not Supplied by O.E.M.)
Voltage Regulator Harness Connector
Four 14 Gauge & two 18 Gauge Wire Leads
Fits Voltage Regulator F0PZ-10316-A
Ford 1975 - On
UNIT PACKAGE: 10



18218
(Not Supplied by O.E.M.)
Alternator Harness Connector
Ford Aerostar, Tempo, Topaz, Taurus & Sable with 6 Cylinder Engine & 75 Amp Alternator 1989-On
4 Cylinder Engine 1985-On
UNIT PACKAGE: 1



20851
(1U2Z-14S411-TA, WPT118)
Alternator Harness Connector
Three 14 Gauge Wire Leads
Ford 1996 - On
UNIT PACKAGE: 1



20838
(Not Supplied by O.E.M.)
Alternator Harness Connector
Two 16 Gauge Wire Leads
100 Amp Alternator
Ford 1990 - 75
UNIT PACKAGE: 10



11437
Dimmer Switch Harness Connector
Ford & Chrysler
UNIT PACKAGE: 10



13644
Right Angle Pigtail
General Purpose
11-1/2" Wire Lead for .160 Stud
Ford
UNIT PACKAGE: 10

"428" DISPLAY BOARDS

428 of the most popular body hardware and fastener items are shrink-wrapped onto seven different boards. Each board contains product groups, body shops are familiar with and use often.

The back of each board contains each part number, unit package quantity, OEM number and size specification. The backs are protected by a clear plastic liner.

Learn more about the display boards at the front of the catalog, online at www.auveco.com or contact customer service at 1-800-354-9816 or mail@auveco.com

Use with butt connectors on pages 205-211 • *Photos not actual size*



12237

(Chry: 3744750; GM: 12004311, 25015169; Ford: C80Z-13711A)

Instrument Panel Socket for 1/2" Hole
Bulb No. 158, 194, 194A
GM, Ford & Chrysler

UNIT PACKAGE: 2



9905

(Chry: 2496279; GM: 2973932; AMC: 3509575; IHC: 374985C1)

Instrument Panel Socket
For 5/8" Hole
Bulb No. 194
GM, Chrysler, AMC & International

UNIT PACKAGE: 10



13541

(3588314)

Side Marker Assembly
Bulb No. 194, 194A
Chrysler

UNIT PACKAGE: 2



13542

(3513686, 4055028)

Side Marker Assembly
Bulb No. 194, 194A
Chrysler

UNIT PACKAGE: 2



12598

(3764865, 3843245, 4124721, 4163003)

Single Contact
with Ground
Bulb No. 87, 93,
1073, 1141 & 1156
Chrysler

UNIT PACKAGE: 1



12599

(3764863)

Double Contact with Ground
Bulb No. 1034, 1154 & 1157
Chrysler

UNIT PACKAGE: 1



13233

(3843432)

Signal & Park Lights
Bulb No. 198, 1016, 1034,
1154 & 1157
Chrysler

UNIT PACKAGE: 1



20389

(Not Supplied by O.E.M.)

Signal, Stop, Tail &
Turn Lights
Bulb No. 1157
Chrysler including Trucks
1992 - 89

UNIT PACKAGE: 1

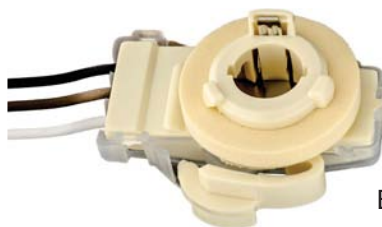

12600

(GM: 12003759;
AMC: 812893)

90° Pigtail &
Socket Assembly
Bulb No. 1016, 1034,
1154 & 1157
GM & AMC

UNIT PACKAGE: 1



18921

(4636360)

Signal, Park &
Back-Up Lights
Chrysler 1993-88

UNIT PACKAGE: 1

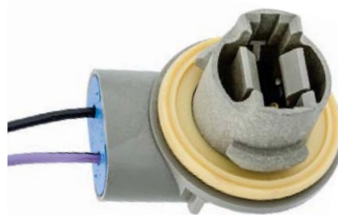

18920

(4636362)

Back-Up Lights
Chrysler 1990-On

UNIT PACKAGE: 1



11157

(AMC: 4486948;
GM: 8912698, 6299087)

Signal, Park, Stop &
Tail Lights
Bulb No. 1034,
1154 & 1157
GM & AMC

UNIT PACKAGE: 1

Use with butt connectors on pages 205-211 • *Photos not actual size*



16174

Headlight Socket Assembly
For Low Beam 9006
Halogen Bulb
Single Indexing Groove
GM, Ford, AMC & Imports

UNIT PACKAGE: 4



16175

(GM: 12101898)

Headlight Socket Assembly
For High Beam 9005
Halogen Bulb
Two Indexing Grooves
GM, Ford, AMC & Imports

UNIT PACKAGE: 4



21490

(GM: 12102664, 88862264
Ford: 1U2Z-14S411-YA)

Fog & Front Lights, Power
Steering & Oil Pressure Switch
Harness Connector
GM 2005 - 1986
Ford 2004 - 1995
Jeep Eagle 1994

UNIT PACKAGE: 1



16968

(12085491)

Fuel Injector
Solenoid Harness Connector
Fits GM Multi-Port Fuel
Injector 1711799 on 2.8
and 3.1 liter engines
(27 models) 1986 - On
Fits Fuel Injectors on Ford,
Chrysler & Imports (Bosch)

UNIT PACKAGE: 1



11437

Dimmer Switch
Harness Connector
Ford & Chrysler

UNIT PACKAGE: 10



11438

Temperature Sending Unit
Harness Connector
GM
Voltage Regulator
Harness Connector
Chrysler

UNIT PACKAGE: 10



11440

(GM: 2962510)

Air Conditioner
Blower Relay
Harness Connector
18 Gauge Wire
GM, AMC & Chrysler

UNIT PACKAGE: 10



Auveco releases new items every other week. Our Hot New Items bulletins can keep you up to date on all new product.

**To receive these bulletins please contact customer service:
mail@auveco.com or 1-800-354-9816**

We also have all previous and current bulletins posted on www.auveco.com.

IMPORT CAR HARNESS CONNECTORS

Use with butt connectors on pages 205-211 • *Photos not actual size*



21210
(Not Supplied by O.E.M.)

Universal Headlight Harness Connector
For H7 Halogen Bulbs
Two 18 Gauge 6" Long Leads
Ford, Audi, BMW, Hyundai,
Kia, Mazda, Mercedes, Mini
Cooper, Saab & Subaru

UNIT PACKAGE: 1

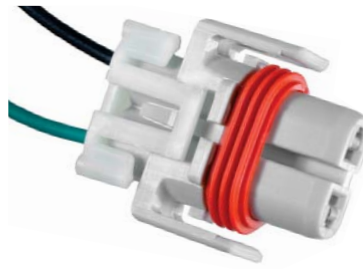

21220
(GM: 88987187)

Headlight Socket
Assembly
For H9 Halogen Bulb
GM, Audi, Mazda,
Mini-Cooper, Porsche,
Volkswagen & Volvo

UNIT PACKAGE: 1



16174

Headlight Socket Assembly
For Low Beam 9006
Halogen Bulb
Single Indexing Groove
GM, Ford, AMC & Imports

UNIT PACKAGE: 4



14918
(12048369)

Headlight Socket
Assembly
For High-Low 9004 &
9007 Halogen Bulb
GM, Ford & Imports

UNIT PACKAGE: 1



16175

(GM: 12101898)

Headlight Socket Assembly
For High Beam 9005
Halogen Bulb
Two Indexing Grooves
GM, Ford, AMC & Imports

UNIT PACKAGE: 4



16968
(12085491)

Fuel Injector
Solenoid Harness Connector
Fits GM Multi-Port Fuel
Injector 1711799 on 2.8
and 3.1 liter engines
(27 models) 1986 - On
Fits Fuel Injectors on Ford,
Chrysler & Imports (Bosch)

UNIT PACKAGE: 1

UNIVERSAL SOCKET ASSEMBLY & HARNESS CONNECTORS

Use with butt connectors on pages 139-147 • *Photos not actual size*



5219

Pigtail Connector
Single Small Wire
Lead - 12" Long
For Sockets Housing
Miniature Lights

UNIT PACKAGE: 10



5221

Pigtail Connector
Double Wire
Lead - 12" Long
Aligned Ears
For Sockets Housing
Double Contact Lights

UNIT PACKAGE: 10



5220

Pigtail Connector
Single Large Wire
Lead - 12" Long
For Sockets Housing
Single Contact Lights

UNIT PACKAGE: 10



8763
(13235-A)

Weatherproof Covered Neoprene
Signal, Park, Stop & Tail Lights
Bulb No. 198, 1016, 1034,
1154 & 1157

UNIT PACKAGE: 10

Use with butt connectors on pages 205-211 • *Photos not actual size*



8764

Single Contact License Plate Lights
For 7/8"-1-1/8" Holes
Bulb No. 63, 67, 87, 89, 93, 97, 209,
1003, 1073, 1129, 1133, 1141 & 1156

UNIT PACKAGE: 5



5226

Universal Signal, Park,
Stop & Tail Lights
For 7/8" to 1-1/8" Hole
Bulb No. 198, 1016,
1034, 1154 & 1157

UNIT PACKAGE: 10



5225

Pigtail Connector
Three Wire Sealed Beam
12" Long - Molded

UNIT PACKAGE: 10



13554

Shielded License/Utility Light
Sealed Socket Assembly
with Chrome Plastic Shield
14" Sealed Plastic Boot
28" Lead with Male Spade Terminal
Bulb Included-Mounts in 1-1/4" Hole

UNIT PACKAGE: 1



11439

Headlight & Flasher
For all cars using 3 prong
sealed Headlight Bulbs 4002,
3, 5, 5040, 2, 5400, 2,
40, 421, 6006, 12 & 13
Also fits 2 & 3 Prong Flashers

UNIT PACKAGE: 10



16968
(12085491)

Fuel Injector
Solenoid Harness Connector
Fits GM Multi-Port Fuel
Injector 1711799 on 2.8
and 3.1 liter engines
(27 models) 1986 - On
Fits Fuel Injectors on Ford,
Chrysler & Imports (Bosch)

UNIT PACKAGE: 1



13559

Headlight & Flasher
For all cars using 2 prong
Sealed Headlight
Bulb No. 4001

UNIT PACKAGE: 3



16966

Three terminal Flasher connector pigtail
designed specifically for heavy duty
thermal and electronic flashers with
variable and fixed loads - single
and alternating flash patterns.
Features three 10" long 14
gauge GXL wire leads.

UNIT PACKAGE: 2



9901

Pigtail Connector
Single Wire Lead
16 Gauge - 12" Long
Receptacle for use wherever there is a
junction of two or more wires; such as behind an
instrument panel or in an engine compartment.

Use with Auveco 9900

UNIT PACKAGE: 20



9900

Pigtail Connector
Single Wire Lead
16 Gauge - 12" Long
Snap plug for use wherever there is a
junction of two or more wires; such as behind an
instrument panel or in an engine compartment.

Use with Auveco 9901

UNIT PACKAGE: 20



8770

2 Way Harness Connector
7-1/2" Leads - 18 Gauge
For Automotive, Truck and Marine
Use where a double harness is required
Also used on Trailers and Farm Implements

UNIT PACKAGE: 5



8768

3-Way Harness Connector
7-1/2" Leads
Color Coded Wire Automotive
For Truck and Marine
Use where a Triple Harness is required
Use with Auveco 8769

UNIT PACKAGE: 5

Use with butt connectors on pages 205-211 • *Photos not actual size*



8769

3-Way Harness Connector
7-1/2" Leads
Color Coded Wire
For Automotive, Truck and Marine
Use where a Triple Harness is required
Use with Auveco 8768

UNIT PACKAGE: 5

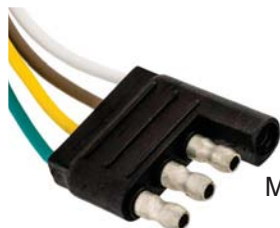

10222

4 Way Harness Connector
12" Leads - 18 Gauge
For Automotive, Truck, Trailer,
Marine and Farm Implement Use
Use with Auveco 10223

UNIT PACKAGE: 5



10223

4 Way Harness Connector
12" Leads - 18 Gauge
For Automotive, Truck, Trailer,
Marine and Farm Implement Use
Use with Auveco 10222

UNIT PACKAGE: 5



10782

4 Way Harness Connector
48" Wire Leads - 18 Gauge
For Automotive, Truck, Trailer,
Marine and Farm Implement Use
Use with Auveco 10783

UNIT PACKAGE: 2

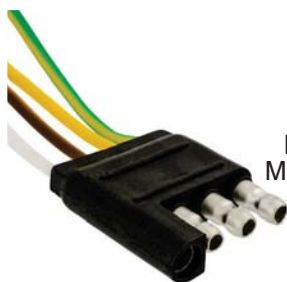

10783

4 Way Harness Connector
48" Wire Leads - 18 Gauge
For Automotive, Truck, Trailer,
Marine and Farm Implement Use
Use with Auveco 10782

UNIT PACKAGE: 2



11434

Six Way Trailer Connector
6 Color Coded Wire Leads
For Trailer Application (Male)
Use with Auveco 11435

UNIT PACKAGE: 5



11435

Six Way Trailer Connector
6 Color Coded Wire leads
For Trailer Application
(Female)
Use with Auveco 11434

UNIT PACKAGE: 5



13634

Complete 4-Way Trailer Connector
Polarized four prong
Chrome plated die cast housing
2-hole flange mounting
1-13/16" on centers
Mounting bracket available

UNIT PACKAGE: 1 Set

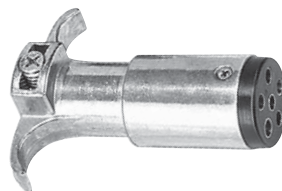

13639

6-Way Trailer
Connector Plug

UNIT PACKAGE: 1



13636

Complete 6-Way Trailer Connector
Assembly consists of
13639 plug and 13640 socket.
Specifically designed for
Recreational Vehicles
Die cast plug housing is
chrome plated and socket is
one piece plastic molded unit
complete with plated spring
loaded cover and a special
moisture and dust-proof boot.

UNIT PACKAGE: 1 Set



13643

Universal Bracket
For use with 13634 and
13640 trailer connectors.
Designed to fit under
trailer high ball
Heavy gauge zinc plated steel

UNIT PACKAGE: 2

MINIATURE BULBS

Wagner Miniature Bulbs • *Photos not actual size*



Auveco Part No.	Type	Replaces Bulb No.	Unit Pkg.
16899	1	1157	10
16901	1	1157NA	10
16902	2	194	10
16904	3	1156	10
16905	4	67	10
16906	4	1895	10
16907	1	2057	10
16908	1	2057NA	10
16909	5	1893	10
16910	4	57	10
16911	4	89	10
16912	4	97	10
16913	6	211-2	10
16914	4	53	10
16915	7	3057	10
16916	7	3057NA	10
16917	7	3157	10
16918	3	1003	10
16919	5	1816	10
16920	17	1004	10
16921	2	168	10
16922	10	906	10
16923	3	1141	10
16924	1	198	10
16925	1	1034	10
16926	3	93	10
16927	8	PR2	10
17597	3	1156NA	10
17994	9	13050	10
17995	9	12100	10
17996	18	3156	10
17997	18	3155	10

Auveco Part No.	Type	Replaces Bulb No.	Unit Pkg.
17998	3	2396	10
17999	1	2357	10
18000	1	2357NA	10
18001	7	3157NA	10
18002	5	1891	10
18003	5	1889	10
18004	3	1073	10
18005	10	921	10
18006	10	916	10
18007	10	916NA	10
18008	10	912	10
18010	11	561	10
18011	6	212-2	10
18012	2	194NA	10
18013	2	193	10
18014	2	158	10
18015	12	90	10
18016	2	74	10
18017	13	24	10
18018	13	24NA	10
18465	2	37	10
18466	3	199	10
18467	4	293	10
18468	4	631	10
18469	17	1076	10
18470	4	1155	10

A - Amber (Darker)
 LL - Long Life
 NA - Natural Amber (Lighter)
 SA - Special Application

Continued on next page

MINIATURE BULBS

Wagner Miniature Bulbs • *Photos not actual size*



Type 1



Type 2



Type 3



Type 4



Type 5



Type 7



Type 9



Type 10



Type 11



Type 12



Type 14



Type 15



Type 16



Type 18



Type 19



Type 20



Type 21

Auveco Part No.	Type	Replaces Bulb No.	Unit Pkg.
18472	4	1445	10
18473	14	1449	10
18474	5	1815	10
18475	18	3156NA	10
18476	7	3157NA-SA	10
18477	15	3357	10
18478	15	3357NA	10
18479	15	3157SA	10
19206	16	7440	2
19207	16	7443	2
19208	3	1295NA	10
20282	4	55	10
20283	4	63	10
20284	2	73	10
20285	2	161	10
20286	2	192	10
20287	19	222	10
20289	11	562	10
20291	10	904	10
20292	12	68	10
20294	10	922	10

Auveco Part No.	Type	Replaces Bulb No.	Unit Pkg.
20295	1	1638	10
20296	20	3496	10
20298	2	3652	10
20299	9	11005	10
20300	9	11006	10
20585	1	1176	10
20587	7	3457	10
20588	7	3457NA	10
20589	5	17131	10
20590	21	17171	10
20591	2	17177	10
20593	1	17916	10
20620	7	4157LL	2
20621	7	4157NALL	2
20681	1	1142	10
20859	7	3757NALL	2

A -Amber (Darker)
 LL - Long Life
 NA -Natural Amber (Lighter)
 SA - Special Application

WAGNER HALOGEN LIGHT BULBS

Photos not actual size

Sec. 12



16896

9004/HB1 Bulb
High-Low Beam in Single Headlight
Assemblies
Volts: 12-18
Watts: 25-65

Use with Auveco Socket 14918

UNIT PACKAGE: 1



18662

9007/HB5 Bulb
High-Low Beam
Volts: 12.8
Watts: 55-65

Use with Auveco Socket 14918

UNIT PACKAGE: 1



16897

9005/HB3 Bulb
High Beam in Dual Headlight Assemblies
Volts: 12.8
Watts: 65

Use with Auveco Socket 16175

UNIT PACKAGE: 1



16898

9006/HB4 Bulb
Low Beam in Dual Headlight Assemblies
Volts: 12.8
Watts: 55

Use with Auveco Socket 16174

UNIT PACKAGE: 1



20683

886 Bulb

UNIT PACKAGE: 1



20595

881 Bulb

UNIT PACKAGE: 1



18661

9003/HB2 Bulb
High-Low Beam
Volts: 12.0
Watts: 55-60

Use with Auveco Socket 5225

UNIT PACKAGE: 1



20601

1260/H4 Bulb

UNIT PACKAGE: 1



20596

885 Bulb

UNIT PACKAGE: 1



20599

893 Bulb

UNIT PACKAGE: 1



19209

2040 Bulb
Center Grille
Mercury Sable and Villager

UNIT PACKAGE: 1



20598

891 Bulb

UNIT PACKAGE: 1



20600

1255/H3 Bulb

UNIT PACKAGE: 1

**BULB NUMBER TO
AUVECO'S WAGNER BULB NUMBER**

Bulb No.	Auveco No.	Bulb No.	Auveco No.	Bulb No.	Auveco No.
H3	20600	881	20595	2057NA	16908
H4	20601	885	20596	2357	17999
HB1	16896	886	20683	2357NA	18000
HB2	18661	891	20598	2396	17998
HB3	16897	893	20599	3057	16915
HB4	16898	904	20291	3057NA	16916
HB5	18662	906	16922	3155	17997
PR2	16927	912	18008	3156	17996
24	18017	916	18006	3156NA	18475
24NA	18018	916NA	18007	3157	16917
37	18465	921	18005	3157NA	18001
53	16914	922	20294	3157NA-SA	18476
55	20282	1003	16918	3157SA	18479
57	16910	1004	16920	3357	18477
63	20283	1034	16925	3357NA	18478
67	16905	1073	18004	3457	20587
68	20292	1076	18469	3457NA	20588
73	20284	1141	16923	3496	20296
74	18016	1142	20681	3652	20298
89	16911	1155	18470	3757NALL	20859
90	18015	1156	16904	4157LL	20620
93	16926	1156NA	17597	4157NALL	20621
97	16912	1157	16899	7440	19206
158	18014	1157NA	16901	7443	19207
161	20285	1176	20585	9003/HB2	18661
168	16921	1255/H3	20600	9004/HB1	16896
192	20286	1260/H4	20601	9005/HB3	16897
193	18013	1295NA	19208	9006/HB4	16898
194	16902	1445	18472	9007/HB5	18662
194NA	18012	1449	18473	11005	20299
198	16924	1638	20295	11006	20300
199	18466	1815	18474	12100	17995
211-2	16913	1816	16919	13050	17994
212-2	18011	1889	18003	17131	20589
222	20287	1891	18002	17171	20590
293	18467	1893	16909	17177	20591
561	18010	1895	16906	17916	20593
562	20289	2040	19209		
631	18468	2057	16907		

**Halogen Bulb Industry Standard Number to
Auveco Harness Connector Number**

Halogen Bulb No.	Auveco Harness No.	Halogen Bulb No.	Auveco Harness No.	Halogen Bulb No.	Auveco Harness No.
880	21490	898	16694	H8	16694
881	16694	899	21490	H9	21220
884	21490	9003	11439	H10	16175
885	21490	9004	14918	H11	16694
886	16694	9005	16175	H12	16175
889	16694	9006	16174	HB1	14918
890	21490	9007	14918	HB2	11439
892	21490	9055	16175	HB3	16175
893	21490	H4	11439	HB4	16174
894	16694	H7	21210		
896	16694				

HIGH PERFORMANCE IMPORTED MINIATURE BULBS

Photos not actual size



Type 1



Type 2



Type 3



Type 4



Type 5



Type 9



Type 10



Type 12



Type 13



Type 15



Type 16



Type 18



Type 22

Auveco Part No.	Type	Replaces Bulb No.	Unit Pkg.
B24	13	24	10
B24A	13	24A	10
B53	4	53	10
B57	4	57	10
B67	4	67	10
B67A	4	67A	10
B68	12	68	10
B89	4	89	10
B97	4	97	10
B168	2	168	10
B194	2	194	10
B194-100	2	194	100
B194A	2	194A	10
B906	10	906	10
B906A	10	906A	10
B912	10	912	10
B916	10	916	10
B916A	10	916A	10
B921	10	921	10
B921A	10	921A	10
B1141	3	1141	10
B1156	3	1156	10
B1156A	3	1156A	10
B1157	1	1157	10
B1157A	1	1157A	10
B1893	5	1893	10
B1895	4	1895	10
B2057	1	2057	10
B2057A	1	2057A	10
B2357	1	2357	10
B2357A	1	2357A	10
B2721	2	2721	10
B2722	2	2722	10
B2821	2	2821	10

Auveco Part No.	Type	Replaces Bulb No.	Unit Pkg.
B2825	2	2825	10
B2827	2	2827	10
B3057	15	3057	10
B3057A	15	3057A	10
B3156	18	3156	10
B3156A	18	3156A	10
B3157	15	3157	10
B3157A	15	3157A	10
B3357	15	3357	10
B3357A	15	3357A	10
B3457	15	3457	10
B3457A	15	3457A	10
B3893	5	3893	10
B4114K	15	4114K	10
B4157	15	4157	10
B4157K	15	4157K	10
B5007	5	5007	10
B5008	5	5008	10
B6411	9	6411	10
B6413	9	6413	10
B6418	9	6418	10
B6438	9	6438	10
B6461	9	6461	10
B7225	1	7225	10
B7440	22	7440	10
B7440A	22	7440A	10
B7443	16	7443	10
B7443A	16	7443A	10
B7505	22	7505	10
B7506	3	7506	10
B7507	3	7507	10
B7515	16	7515	10
B7528	1	7528	10

HIGH PERFORMANCE IMPORTED HALOGEN BULBS

Photos not actual size



B880

880 Bulb

UNIT PACKAGE: 1



B890

890 Bulb

UNIT PACKAGE: 1



B881

881 Bulb

UNIT PACKAGE: 1



B891

891 Bulb

UNIT PACKAGE: 1



B884

884 Bulb

UNIT PACKAGE: 1



B893

893 Bulb

UNIT PACKAGE: 1



B885

885 Bulb

UNIT PACKAGE: 1



B894

894 Bulb

UNIT PACKAGE: 1



B886

886 Bulb

UNIT PACKAGE: 1



B896

896 Bulb

UNIT PACKAGE: 1



B889

889 Bulb

UNIT PACKAGE: 1



B899

899 Bulb

UNIT PACKAGE: 1

HIGH PERFORMANCE IMPORTED HALOGEN BULBS

Photos not actual size

Sec. 12



B9004

9004/HB1 Bulb
High-Low Beam in
Single Headlight Assemblies
Volts: 12-18
Watts: 25-65

Use with Auveco Socket 14918

UNIT PACKAGE: 1



BD2C

D2C Bulb

UNIT PACKAGE: 1



B9005

9005/HB3 Bulb
High Beam in
Dual Headlight Assemblies
Volts: 12.8
Watts: 65

Use with Auveco Socket 16175

UNIT PACKAGE: 1



BD2R

D2R Bulb

UNIT PACKAGE: 1



B9006

9006/HB4 Bulb
Low Beam in
Dual Headlight Assemblies
Volts: 12.8
Watts: 55

Use with Auveco Socket 16174

UNIT PACKAGE: 1



BD2S

D2S Bulb

UNIT PACKAGE: 1



B9007

9007/HB5 Bulb
High-Low Beam
Volts: 12.8
Watts: 55-65

Use with Auveco Socket 14918

UNIT PACKAGE: 1



BH1

H1 Bulb

UNIT PACKAGE: 1



BD1S

D1S Bulb

UNIT PACKAGE: 1



B64150ULT

H1LL/ 64150ULT Bulb

UNIT PACKAGE: 1

HIGH PERFORMANCE IMPORTED HALOGEN BULBS

Photos not actual size



BH3

H3/12V 55W Bulb
UNIT PACKAGE: 1



B64193

H4/ 64193 Bulb
UNIT PACKAGE: 1



B64193ULT

H4LL/ 64193ULT Bulb
UNIT PACKAGE: 1



B64132

H6W/ 64132 Bulb
UNIT PACKAGE: 10



BH7

H7 Bulb
UNIT PACKAGE: 1



B64210ULT

H7LL/ 64210ULT Bulb
UNIT PACKAGE: 1



BH9

H9 Bulb
UNIT PACKAGE: 1



BH10

H10/9145 Bulb
UNIT PACKAGE: 1



B64113

H10W/ 64113 Bulb
UNIT PACKAGE: 10



BH11

H11 Bulb
UNIT PACKAGE: 1



BH13

H13/9008 Bulb
UNIT PACKAGE: 1

HIGH PERFORMANCE IMPORTED BULBS

Bulb Number to Auveco's High Performance Imported Bulb Number

Halogen Bulb No.	Auveco No.	Halogen Bulb No.	Auveco No.	Halogen Bulb No.	Auveco No.
24	B24	1157A	B1157A	7440A	B7440A
24A	B24A	1893	B1893	7443	B7443
53	B53	1895	B1895	7443A	B7443A
57	B57	2057	B2057	7505	B7505
67	B67	2057A	B2057A	7506	B7506
67A	B67A	2357	B2357	7507/Amber	B7507
68	B68	2357A	B2357A	7515	B7515
89	B89	2721	B2721	7528	B7528
97	B97	2722	B2722	9004	B9004
168	B168	2821	B2821	9005	B9005
194	B194	2825	B2825	9006	B9006
194A	B194A	2827/Amber	B2827	9007	B9007
880	B880	3057	B3057	9008	BH13
881	B881	3057A	B3057A	9145	BH10
884	B884	3156	B3156	D1S	BD1S
885	B885	3156A	B3156A	D2C	BD2C
886	B886	3157	B3157	D2R	BD2R
889	B889	3157A	B3157A	D2S	BD2S
890	B890	3357	B3357	H1	BH1
891	B891	3357A	B3357A	H1LL	B64150ULT
893	B893	3457	B3457	H3	BH3
894	B894	3457A	B3457A	H4	B64193
896	B896	3893	B3893	H4LL	B64193ULT
899	B899	4114K	B4114K	H6W	B64132
906	B906	4157	B4157	H7	BH7
906A	B906A	4157K	B4157K	H7LL	B64210ULT
912	B912	5007	B5007	H9	BH9
916	B916	5008	B5008	H10	BH10
916A	B916A	6411	B6411	H10W	B64113
921	B921	6413	B6413	H11	BH11
921A	B921A	6418	B6418	H13	BH13
1141	B1141	6438	B6438	HB1	B9004
1156	B1156	6461	B6461	HB3	B9005
1156A	B1156A	7225	B7225	HB4	B9006
1157	B1157	7440	B7440	HB5	B9007

Bulb Number to Auveco's Premium Imported Bulb Number

Bulb No.	Auveco No.	Bulb No.	Auveco No.
24NA	20702	1893	20715
89	20705	2040	20717
168	20706	2357	20720
880	20854	2357NA	20721
881	20855	3057	20722
885	20856	3457	20728
889	20857	3457NA	20729
916NA	20712	3496	20730

NA- Natural Amber (Lighter)

PREMIUM IMPORTED MINIATURE BULBS

Photos not actual size



Type 1



Type 2



Type 4



Type 5



Type 7



Type 10



Type 13



Type 20



Type 23

Auveco Part No.	Type	Replaces Bulb No.	Unit Pkg.
20702	13	24NA	10
20705	4	89	10
20706	2	168	10
20712	10	916NA	10
20715	5	1893	10
20720	1	2357	10
20721	1	2357NA	10
20722	7	3057	10
20728	23	3457	10
20729	23	3457NA	10
20730	20	3496	10

PREMIUM IMPORTED HALOGEN BULBS



20855

881 Bulb

UNIT PACKAGE: 1



20717

2040 Bulb
Center Grille
Mercury Sable and Villager

UNIT PACKAGE: 1

All items available in bulk quantities.

**Call customer service
1-800-354-9816
for a price quote**



20857

889 Bulb

UNIT PACKAGE: 1



20856

885 Bulb

UNIT PACKAGE: 1



20854

880 Bulb

UNIT PACKAGE: 1

SWITCHES

Photos not actual size

Push-Pull Switches



13552

Marine Switch
3 Position "Off-On-On"
First 'On' position energizes one circuit.
In second "On" position both circuits are energized.
Mounting stem 1-1/4" long. 3/8" diameter.
Brass hex back-up nut, brass washer, chrome plated brass face nut and chrome plated knob.
15 Amps @ 12 Volts

UNIT PACKAGE: 1



12077

Push-Pull Switch
Heavy Duty
2 position "Off-On" switch with 2 Screw Terminals.
25 Amps @ 6 Volts; 15 Amps @ 12 Volts

UNIT PACKAGE: 1



Push Button Switch
Heavy Duty Construction

12078

Horn Button
UNIT PACKAGE: 1

TOGGLE & ROCKER SWITCHES



13555
Brass

S.P. S.T. Toggle Switch "Off-On"
Mounting Stem 3/8" long
Diameter: 7/16" with 7/16" x 28 threads
Rating: 35 Amps @ 6 Volts
20 Amps @ 12 Volts

UNIT PACKAGE: 1



13630

S.P. S.T. Toggle Switch "Off-On"
Phenolic Housing
Mounting Stem 15/32" long
Diameter: 15/32"
2 Screw Terminals
Bat Handle
Rating: 15 Amps 125 Volts AC
10 Amps 250 Volts AC
3/4 HP 120-240 Volts AC

UNIT PACKAGE: 1



13632

D.P. D.T. Toggle Switch "On-Off-On"
Phenolic Housing
Mounting Stem 15/32" long
Diameter: 15/32"
6 Screw Terminals
Rating: 15 Amps 125 Volts AC
10 Amps 250 Volts AC
3/4 HP 120-240 Volts AC

UNIT PACKAGE: 1



13631

S.P. D.T. Toggle Switch "On-Off-On"
Phenolic Housing
Mounting Stem 15/32" long
15/32" Diameter
3 Screw Terminals
Bat Handle
Rating: 15 Amps 125 Volts AC
10 Amps 250 Volts AC
3/4 HP 120-240 Volts AC

UNIT PACKAGE: 1

Photos not actual size



13629

S.P. S.T. Toggle Switch "Off-On"
Two 6" Wire Leads
Nickel plated "Off-On" indicator plate assembled
Mounting Stem 3/8" long
Diameter: 15/32" diameter
Bat handle
Rating: 15 Amps 12 Volts DC
6 Amps 125 Volts AC

UNIT PACKAGE: 1



12076

Chrome Plated Handle

Heavy Duty Toggle Switch
2 Position "On-Off"
Stem Diameter: 15/32"
Low Voltage -High Amp Application
Rating: 35 Amps @ 6-12 Volts DC

UNIT PACKAGE: 1



13556

Toggle Switch
2 Positions "On-Off"
For lights, blower, pump, etc.
Black plastic paddle and locking ring with level seal and knurled cap nut

Sealed to resist water penetration.
Fits panels up to 1/4" thick
Requires 15/32" Mounting Hole
Rating: 20 Amps @ 12 Volts D.C. with 1/4" spade terminals

UNIT PACKAGE: 1

13514
Black Molded Bat Handle



Heavy Duty S.P. D.T. Toggle Switch
3 Position "On-Off-On"
3 Blade Terminals
Spring loaded for positive snap action
Includes bezel nut and collar
Fits in 1/2" diameter hole
Rating: 16 Amps @12 Volts

UNIT PACKAGE: 1

Illuminated Toggle Switches

2 Position "Off-On"
Handle illuminated in 'On' position
With bezel nut and back-up collar for mounting in 1/2" hole.
Rating: 20 Amps @ 12 Volts



Auveco Part No.	Color
13523	Red illuminated toggle
13524	Green illuminated toggle
12236	Amber illuminated toggle

UNIT PACKAGE: 1

Illuminated Rocker Switches

2 Position "Off-On"
Rocker illuminated in 'On' position
Snaps into 1" x 1/2" rectangular hole
Rating: 20 Amps. @ 12 Volts



Terminal Coding:
1 -Power
2 -Accessory
3 -Ground

Auveco Part No.	Color
12234	Red illuminated rocker
13529	Green illuminated rocker
13530	Amber illuminated rocker
13531	Blue illuminated rocker

UNIT PACKAGE: 1

13528

Non-illuminated Rocker Switch
2 position "Off-On"
Fits 1-1/8" x 7/16" rectangular hole
Rating: 20 Amps @ 12 Volts



UNIT PACKAGE: 1

Illuminated Toggle Switch Mounting Panel

12233

1-1/8" x 7/16" Hole
Use with Auveco 12234, 13529, 13530 & 13531

UNIT PACKAGE: 1

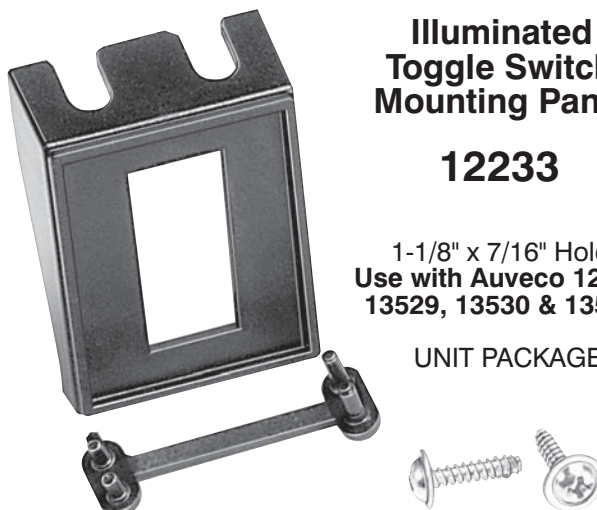

TOGGLE SWITCHES

Photos not actual size

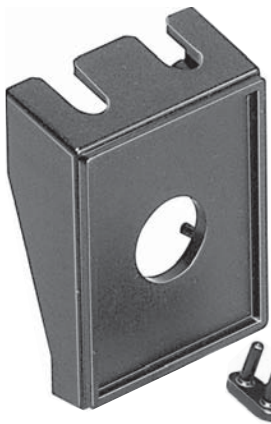

Illuminated Toggle Mounting Panel

12235

1/2" Hole Diameter

UNIT PACKAGE: 1



Indicator Lamps

Has wire leads for easy installation
Mounts into 1/2" hole
12 Volt application
Installs in Auveco
Mounting Panel 12235

Auveco
Part No.

Color

20477	Red Lens
13520	Green Lens
13521	Amber Lens
13522	Blue Lens

UNIT PACKAGE: 1

WIRE LOOM CLIPS



1340

Wire Loom Clips
Clamping
Diameter: 1/4"

UNIT PACKAGE: 100



1341

Wire Loom Clips
Clamping Diameter: 3/16"

UNIT PACKAGE: 100



3758

Wire Loom Clips
Clamping Diameter: 3/8"

UNIT PACKAGE: 100



14388

(145525)

Heavy Duty
Frame Wiring Clip
Clamping Diameter: 3/16"
Fits panels from .030"-.230"

UNIT PACKAGE: 50



9864

(372741-S100)

General Purpose
Wire Loom Clip

UNIT PACKAGE: 100

ROUTING CLIPS



Nylon Cable Clips

Auveco Part No.	Cable Size	Screw Size	Unit Pkg.
13939	3/16"	#8-10	50
13944	1/2"	#8-10	50



13937

Nylon Spring Clip

Width: 3/8"
Overall Length: 1-5/16"
Thickness: .060
Use with #8 Screw

UNIT PACKAGE: 50



Nylon Tubing & Hose Clips

Adhesive Backed

Auveco Part No.	Range	Unit Pkg.
10057	5/32" to 1/4"	10
10058	5/16" to 1/2"	10
10059	9/16" to 3/4"	10



Cable Clips for Co-Ax Cable

Polyethylene clips with corrosion resistant galvanized steel nail.

15854

Cable Diameter: 3/16"-9/32"
Nail Length: 1"

UNIT PACKAGE: 50



Strain-Relief Cable Connector

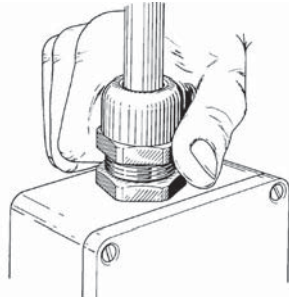

Photo not actual size

Reliable, liquid-tight, nylon strain-relief cable connector for quick and easy installation. They do not have to be disassembled before using. Simply insert a cable into the connector, tighten the cap nut and the cable is automatically fixed, centered, and strain relieved.

15851

Wire Diameter: .236" - .472"
 Thread: 1/2" NPT
 Thread Length (Bottom): .512"
 Hex: .945"

UNIT PACKAGE: 5



Routing Clips

A quick, economical method of fastening wires, tubes, hoses or rods from 1/4" to 1" diameter to metal, plastic or any other surface ranging from 1/32" to 1/8" thickness. Clips are molded of durable black nylon plastic. They snap into 1/4" diameter holes and are held firmly in place by flexible "snubber tips" which compensate for variation in wall thickness.

Auveco Part No.	Tube/Hose Wire Outside Dia.	Clip Overall Height	Clip Height Above Panel	Unit Pkg.
14529	1/4"	27/32"	7/16"	25
14530	3/8"	29/32"	15/32"	25
14531	1/2"	1-1/16"	5/8"	25
14532	5/8"	1-3/16"	3/4"	25
14533	3/4"	1-5/16"	7/8"	25

Wire Loom Routing Clips

Black Nylon • Also called split flexible tubing, convoluted conduit or wiring harness



Type 1



Type 2



Type 3



Type 4



Type 5

Auveco Part No.	Type	For Conduit Size		GM No.	Unit Pkg.
		I.D.	O.D.		
19440	3	1/4"	3/8"	12040984	15
19795	4	1/4"	3/8"	12015631	15
14544	1	11/32"	1/2"	8911473	25
20397*	6	10mm	13mm	12160858	15
20471	4	10mm	13mm	8905794	15
14545	1	13/32"	19/32"	8911497	25
14546	1	1/2"	11/16"	8911472	25
19851	5	1/2"	11/16"	12040983	15
14547	1	3/4"	1"	3816659	25
				8917320	
20665	7	19mm	24mm	12160374	15
16941	2	1"	1-9/32"	12015983	25

*Gray Nylon



Type 6



Type 7

CABLE & HARNESS STRAPS

Sec. 12



8550
Black Nylon, 2-1/4" Long
UNIT PACKAGE: 25



8273
Black Nylon, 2-3/4" Long
For 1/4" Hole in 115" Thick Metal
UNIT PACKAGE: 50



3690
Photo not actual size
Natural Nylon, 3-1/2" Long
UNIT PACKAGE: 100

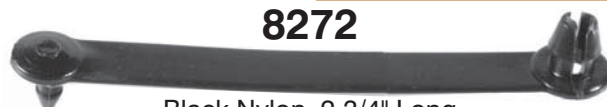

8272
Black Nylon, 2-3/4" Long
For 1/4" Hole in .093" Thick Metal
UNIT PACKAGE: 50

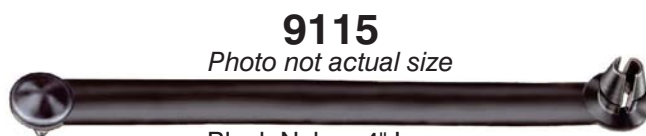

9115
Photo not actual size
Black Nylon, 4" Long
UNIT PACKAGE: 50



14376
(Mazda: 9928-90-753)
Black Nylon, 110mm (4-3/8") Long, Releasable,
Max. Bundle Diameter: 25mm (1"), Fits into 7mm Hole
UNIT PACKAGE: 15



20654
(Mercedes: 001-997-42-90)
Black Nylon 120mm (4-3/4") Long,
Fits into 8mm Hole
UNIT PACKAGE: 10



5879
Natural Nylon, 5" Long
UNIT PACKAGE: 25



14284
(Honda: 90669-671-000, 90669-671-003;
Toyota: 90463-10337)
Aqua Nylon, 110mm (5-5/16") Long, Max. Bundle Diameter: 23mm (7/8"), Fits into 6mm Hole
UNIT PACKAGE: 15



14298
(Honda: 90672-SA0-003; Mazda: 9928-91-053)
Black Nylon, 140mm (5-1/2") Long, Releasable, Max. Bundle Dia: 30mm (1-5/32"), Fits into 7mm Hole
UNIT PACKAGE: 25



21203
Gray Nylon, 155mm (6-1/8") Long, Max. Bundle Dia: 30mm (1-3/16"), Fits into 6.3mm (1/4") Hole
UNIT PACKAGE: 25

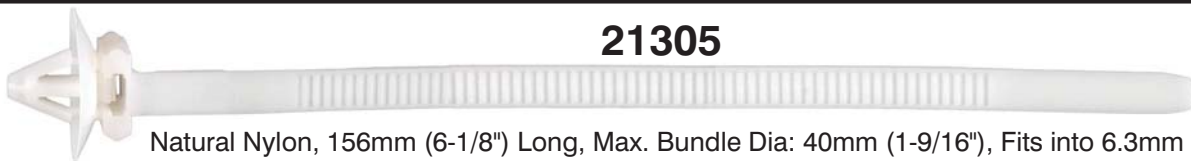

21305
Natural Nylon, 156mm (6-1/8") Long, Max. Bundle Dia: 40mm (1-9/16"), Fits into 6.3mm (1/4") Hole
UNIT PACKAGE: 25

20655

(Mercedes: 114-997-02-90)



Black Nylon, 160mm (6-3/8") Long, Fits into 8mm (5/16") Hole

UNIT PACKAGE: 10

21355

Black Nylon, 160mm (6-3/8") Long, Max. Bundle Diameter: 36mm (1-13/32"), Fits into 7mm Hole

UNIT PACKAGE: 25

10649

(GM: 3816659, 19130464)



Black Nylon, 6-1/2" Long

UNIT PACKAGE: 10

21553

(Toyota: 82711-12200) • *Photo not actual size*



Black Nylon, 170mm (6-3/4") Long, Max. Bundle Dia.: 40mm (1-9/16"), Fits into 13mm (1/2") Hole

UNIT PACKAGE: 25

21310

Black Nylon, 174MM (6-15/16") Long, Max. Bundle Diameter: 40mm (1-9/16"), Fits into 13mm (1/2") Hole

UNIT PACKAGE: 25

20380

Photo not actual size

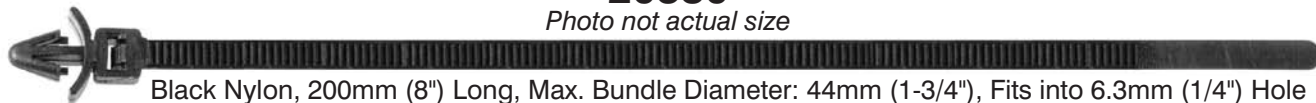

Black Nylon, 200mm (8") Long, Max. Bundle Diameter: 44mm (1-3/4"), Fits into 6.3mm (1/4") Hole

UNIT PACKAGE: 25

21259

(Nissan: 24225-89960)

Photo not actual size



Black Nylon, 200mm (8") Long, Max. Bundle Diameter: 55mm (2-3/16"), Fits into 8mm (5/16") Hole

UNIT PACKAGE: 25

CABLE & HARNESS STRAPS

Photos not actual size

Self-Clamping Natural Nylon Straps



Reusable

Auveco Part No.	Tensile Strength	Strap Length	Max Bundle Dia.	Width	Unit Pkg.
10217	18 lb.	3-7/8"	3/4"	3/32"	10
9637	50 lb.	14-7/8"	4"	3/16"	10
10218	120 lb.	14-1/2"	4"	9/32"	10

Black Nylon Cable Ties Self Clamping



Auveco Part No.	Tensile Strength	Length	Width	Unit Pkg.
15144	18 lb.	4"	3/32"	100
15196	18 lb.	4"	3/32"	1000
15145	30 lb.	5-1/2"	1/8"	100
15197	30 lb.	5-1/2"	1/8"	1000
15146	50 lb.	7"	3/16"	50
15198	50 lb.	7"	3/16"	1000
15147	50 lb.	11"	3/16"	50
15199	50 lb.	11"	3/16"	500
15753	50 lb.	14"	3/16"	25
15148	120 lb.	14"	5/16"	25
15200	120 lb.	14"	5/16"	500

Natural Nylon Cable Ties Self Clamping



Auveco Part No.	Tensile Strength	Length	Width	Unit Pkg.
11953	18 lb.	3"	3/32"	50
11954	18 lb.	4"	3/32"	50
14836	18 lb.	4"	3/32"	100
15188	18 lb.	4"	3/32"	1000
11955	30 lb.	5"	1/8"	50
14837	30 lb.	5"	1/8"	100
15189	30 lb.	5"	1/8"	1000
11956	50 lb.	7"	5/32"	25
14838	50 lb.	7"	5/32"	50
15190	50 lb.	7"	5/32"	1000
11957	50 lb.	11"	5/32"	25
14839	50 lb.	11"	5/32"	50
15191	50 lb.	11"	5/32"	500
15754	50 lb.	14"	5/32"	25
11958	120 lb.	14"	9/32"	10
14840	120 lb.	14"	9/32"	25
15192	120 lb.	14"	9/32"	500

Black Nylon Cable Ties Self-Clamping with Mounting Hole



Auveco Part No.	Tensile Strength	Length	Screw Hole Size	Width	Unit Pkg.
15150	50 lb.	7-1/2"	#10	3/16"	50
15202	50 lb.	7-1/2"	#10	3/16"	250
15151	120 lb.	14-3/4"	#14	5/16"	25
15203	120 lb.	14-3/4"	#14	5/16"	200

Natural Nylon Cable Ties Self-Clamping with Mounting Hole



Auveco Part No.	Tensile Strength	Length	Screw Hole Size	Width	Unit Pkg.
11961	50 lb.	7"	#10	5/32"	50
15194	50 lb.	7"	#10	5/32"	250
11963	120 lb.	13"	#14	9/32"	10



14568
Cable Tie Tool



1. Feed Cable Tie in tool head, pull trigger to tension



2. Hold trigger tension and twist tool 1/2 turn.

A light-weight, durable hand tool that's perfect for installing cable ties. The tool works on 18 pound, 30 pound, 40 pound, and 50 pound tensile rated cable ties. Length: 6-1/4". Made of rugged plastic.

UNIT PACKAGE: 1

Cable Tie Mount with Adhesive

Uses a #6 flat head screw or 1/8" flat head rivet. Features a 4 way insertion and accepts 18, 30, and 50 pound cable ties. 1" x 1" Adhesive backing



12361
Natural Nylon

UNIT PACKAGE: 10

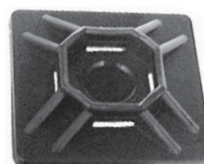

16001
Black Nylon

UNIT PACKAGE: 10



**Steel with Rubber Seal
Oil Drain Plug Gaskets**

Auveco Part No.	I.D.	O.D.	Thick-ness	Unit Pkg.
16026	1/2"	1"	3/64"	5
18299	14mm	25mm	1mm	10
18931	16mm	24mm	2mm	10
18932	18mm	27mm	2mm	10



**Oil Drain Plug
Rubber Gaskets**

21180

I.D.: 11mm
O.D.: 18mm
Replacement Gasket
For Auveco No. 20347
Ford 1993 - On

UNIT PACKAGE: 10

21179

I.D.: 11mm
O.D.: 19mm
Replacement Gasket
For Auveco No. 21047
GM 1985 - On

UNIT PACKAGE: 10

18665

I.D.: 11mm
O.D.: 21mm
Replacement Gasket
For Auveco 18663
18664 & 20372
GM 12mm-1.75

UNIT PACKAGE: 10

19630

I.D.: 11mm
O.D.: 25mm
Replacement Gasket
For Auveco 18023
GM 12mm-1.75

UNIT PACKAGE: 10

20896

(Not Supplied by O.E.M.)

I.D.: 13mm
O.D.: 19mm
Replacement Gasket
For Auveco No.
19773
M14-1.5

UNIT PACKAGE: 10

20453

(F5TZ-6734-BA)

I.D.: 13mm
O.D.: 22mm
Replacement Gasket
For Auveco No.
19279 & 21354
M14-1.5

UNIT PACKAGE: 10



22169

(Not Supplied by O.E.M.)

I.D.: 18mm
O.D.: 23mm
Replacement Gasket for Auveco 21650
Chevrolet Cruze & Volt 2010 - On

UNIT PACKAGE: 10



22134

(Toyota: 90430-12031, 90430-12018,
90430-12027 & 90430-C0005)
Fibre & Aluminum

Oil & Transmission
Drain Plug Gasket
Inner Diameter: 12mm
Outer Diameter: 21mm
Thickness: 1.75mm

Toyota 4Runner, Avalon, Camry, Celica, Corolla, Echo,
FJ Cruiser, Highlander, Land Cruiser, Matrix, MR2,
Paseo, Previa, Prius, RAV4, Sequoia, Sienna, Solara,
Supra, T100, Tacoma, Tercel, Tundra, Venza & Yaris
1991 - On

UNIT PACKAGE: 5



Fibre

**Oil Drain
Plug Gaskets**

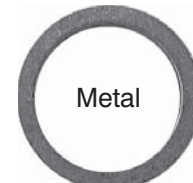

Metal

Auveco Part No.	I.D.	O.D.	Thick-ness	Mat.	Unit Pkg.
19538	1/2"	3/4"	5/64"	Bk Fibre	50
8277	1/2"	3/4"	3/32"	Nylon	25
15918	1/2"	7/8"	1/16"	Copper	25
19590	1/2"	7/8"	1/16"	Aluminum	25
16996	1/2"	15/16"	1/16"	Nylon	25
18019	1/2"	15/16"	5/64"	Fibre	50
19539	9/16"	13/16"	5/64"	BK. Fibre	50
8281	9/16"	13/16"	3/32"	Nylon	25
15919	9/16"	13/16"	3/32"	Copper	25
8278	5/8"	1"	3/32"	Nylon	25
18021	3/4"	1"	1/16"	Copper	25
8279	3/4"	1-1/16"	3/32"	Nylon	25
18849	12mm	21mm	1.8mm	Steel*	5
16680	12mm	22mm	1.5mm	Nylon	50
19591	12mm	22mm	1.5mm	Copper	15
19601	12mm	22mm	1.5mm	Aluminum	50
18726	12mm	22mm	2mm	Bk Fibre	50
19621	14mm	20mm	1mm	Aluminum	50
20454	14mm	20mm	1.5mm	Copper	15
19592	14mm	22mm	1.5mm	Copper	15
16956	14mm	22mm	2mm	Aluminum	50
16681	14mm	24mm	1.5mm	Nylon	50
16682	14mm	24mm	2mm	Bk Fibre	50
19604	16mm	22mm	1.5mm	Copper	10
19603	16.4mm	27mm	2mm	Bk Fibre	50
16683	16.5mm	27mm	1.5mm	Nylon	50
20462	18mm	24mm	1.2mm	Aluminum	25
16955	18mm	25.5mm	2mm	Aluminum	50
16684	18mm	29mm	1.5mm	Nylon	50
19605	18mm	26mm	1.5mm	Copper	10
18829	18mm	29mm	1.5mm	Grn Fibre	25
16685	20mm	28mm	1.5mm	Nylon	50
19593	20mm	25mm	1.6mm	Copper	10
18830	20mm	28mm	1.5mm	Grn Fibre	25
21647	20mm	28mm	2mm	Bk Fibre	25
21178	20mm	28.5mm	1.6mm	Aluminum	25
21648	23mm	29mm	2mm	Bk Fibre	25
21649	24mm	30mm	1.8mm	Aluminum	10
18020	25.5mm	35mm	2mm	Bk Fibre	50

* Teflon coated steel



Oil Drain Plug Crushable Gaskets



Auveco Part No.	Inner Diameter	Outer Diameter	Thickness	Material	Unit Pkg.
19545	1/2"	3/4"	5/64"	Copper	10
17261	12mm	18mm	2mm	Copper	10
21258	12mm	18mm	3mm	Copper	10
19007	14mm	19mm	2mm	Steel	10
17262	14mm	20mm	2mm	Copper	10
22223	14mm	22mm	2mm	Copper	10
21677	16mm	21mm	2.5mm	Steel	10
17263	16mm	22mm	2mm	Copper	10
17264	18mm	24mm	2mm	Copper	10
21116	18mm	24mm	2.5mm	Steel	10
17265	20mm	26mm	2mm	Copper	10
19139	20mm	26mm	2mm	Steel	15

OIL & TRANSMISSION DRAIN PLUGS WITH GASKETS



14196

Zinc

Thread: 1/2"-20
Hex: 7/8"
Length Under Head: 1/2"

Fits the following 1/2"-20 applications:

AMC: 6 & 8 Cylinder All 64-On

Buick: 4, 6 & 8 Cylinder All [Exc. 2.5 (151), 3.0, 4.3, 4.9 (301 Eng.)] 59-On

Cadillac: 6 & 8 Cylinder All (Exc. 4.1 Eng) 66-On

Chevrolet (Includes Light Truck): 4, 6 & 8 Cylinder All [Exc. 1.8 (diesel), 2.5 (151), 4.3 (diesel) Eng.] 28-On

Chrysler Corp.: 6 & 8 Cylinder All 62-On

Ford Motor Co.: 4, 6 & 8 Cylinder All (Exc. 98, 122, 140, 171 Eng) 57-On

GMC (Light Truck): 6 & 8 Cylinder All 39-On

Oldsmobile: 4, 6 & 8 Cylinder All [Exc. 2.5 (151), 3.0, 4.3, (diesel), 4.3S, 4.9T (301)] 61-On

Pontiac: 4, 6, & 8 Cylinder All [Exc. 1.8 (diesel), 2.5 (151), 4.3 (diesel), 4.3S, 4.9T (301)] 60-On

UNIT PACKAGE: 10



19130

(3921988)
Phosphate

Thread: 1/2"-20
Hex: 9/16"
Length Under Head: 13/16"
Washer Head O.D.: 7/8"

Fits the following applications:

Buick: 4, 6 & 8 Cylinder All [Exc. 2.5(151) 3.0, 4.3, 4.9 (301 Eng.)] 59-On

Cadillac: 6 & 8 Cylinder All (Exc. 4.1 Eng) 66-On

Chevrolet (Inc. GMC Light Truck): 4, 6 & 8 Cylinder All [Exc. 1.8 (diesel), 2.5 (151), 4.3 (diesel) Eng.] 28-On

Oldsmobile: 4, 6 & 8 Cylinder All [Exc. 1.8 (diesel), 2.5 (151), 3.0, 4.3, (diesel), 4.3S, 4.9T (301)Eng.] 61-On

Pontiac: 4, 6 & 8 Cylinder All [Exc. 1.8 (diesel), 2.5 (151), 4.3 (diesel), 4.3S, 4.9T (301)Eng.] 60-On

UNIT PACKAGE: 15



18373

(6034376)

Plain with Rubber
Washer Face Gasket

Thread: 1/2"-20
Hex: 5/8"
Length Under Head: 13/16"
Rubber Gasket O.D.: 1-3/32"

Fits the following applications:

Chrysler

UNIT PACKAGE: 2

Sec. 13**OIL & TRANSMISSION DRAIN PLUGS WITH GASKETS****18022**
(948187-0)
ZincThread: 3/4"-16
Hex: 1"
Length Under Head: 1/2"Fits the following applications:
Volvo: 4 Cylinder

UNIT PACKAGE: 2

**21665**
(BC3Z-6730-A)
Yellow Plastic with
Rubber GasketDiameter: 13/16"
Square Drive: 3/8"
Overall Length: 1-13/16"Fits the following applications:
Ford: F250 & F350 with 6.7L
PowerStroke 2011 - On

UNIT PACKAGE: 1

**22143**
(VW: 06L-103-801)
Black PlasticPlastic Oil Drain Plug
Head Diameter: 23mm
(with Screw Driver Slot)
Overall Height: 20mm

With Installed Rubber O-Ring

Fits the following applications:
Audi: A3 & S3 and Volkswagen Golf & GTI 2015 - On

UNIT PACKAGE: 1

**19318**
(Jeep: 83504041;
Lexus: 90341-10006, 90341-10012)
Zinc & YellowThread: M10-1.5; Hex: 14mm
Length Under Head: 9mmFits the following transmission applications:
Jeep: Cherokee, Comanche & XJ 1991-On
Lexus: GS300, LS400 & SC400 1991-On

UNIT PACKAGE: 2

**20807**
(F81Z-6730-AA)
Plain with Rubber
Washer Face GasketThread: M10-1.5
Hex: 13mm
Length Under Head: 15mm
Rubber Gasket O.D.: 28mmFits the following 4R100 transmission applications:
Ford: E150-450, F150-450 Excursion &
Expedition 1980 - On

UNIT PACKAGE: 1

**15527**
ZincThread M12-1.25
Hex: 14mm
Length Under Head: 11mm
Washer Head O.D.: 20mmFits the following M12-1.25 applications:
Nissan: Sentra, Stanza & Pulsar with FWD 1982-On

UNIT PACKAGE: 5

**19589**
ZincThread M12-1.5
Hex: 13mm
Length Under Head: 12mm
Washer Head O.D.: 17mmFits the following applications:
BMW & Mercedes

UNIT PACKAGE: 5

**21293**
(11128-01M0B)
Zinc & YellowThread: M12-1.25
Hex: 14mm
Length Under Head: 12mm
Washer Head O.D.: 23mmFits the following applications:
Nissan Sentra & 350Z and Infiniti 1992 - On

UNIT PACKAGE: 2

**19588**
ZincThread: M12-1.25
Hex: 14mm
Length Under Head: 17mm
Washer Head O.D.: 20mmFits the following applications:
Nissan

UNIT PACKAGE: 5

**18023**
(21006725)
Black Zinc
With Rubber GasketThread: M12-1.75
Hex: 14mm
Length Under Head: 19mm
Rubber Gasket O.D.: 31mmFits the following application:
GM: Saturn

UNIT PACKAGE: 2



21093

(24233099)
Zinc with
Rubber Gasket

Thread: M12-1.75
Hex: 15mm
Length Under Head: 20mm
Washer Head O.D.: 32mm

Fits the following applications:
4L80-E Transmissions on **Chevrolet** 2 WD Full Size
Vans & Pickup Trucks 1997 - On

UNIT PACKAGE: 2



21047

(GM: 3536964, 3538469,
11519408,
11562588, 24100042;
Isuzu: 8-11519-408-0)
Zinc with Rubber Gasket

Thread: M12-1.75
Hex: 15mm
Length Under Head: 25mm
Washer Head O.D.: 26mm

Fits the following applications:
GM: 2.2 (4), 3.1 (M), 3.8 (K), 3.8 (1), 2.3, 4.9 & 6.0L
Eng. 1985 - On

UNIT PACKAGE: 2



18374

(F5AZ-6730)
Plain With Rubber
Washer Face Gasket

Thread: M12-1.75
Hex: 15mm
Length Under Head: 21mm
Rubber Gasket O.D.: 28mm

Fits the following applications:
Ford: 2.5, 3.0 & 4.6 Eng. with Modular
& Aluminum Pans

UNIT PACKAGE: 2



14677

Zinc

Thread: M12-1.75
Hex: 15mm
Length Under Head: 26mm
Washer Head O.D.: 22mm

Fits the following M12-1.75 applications:
Buick: 4 Cylinder 151 (2.5) Eng. 80-On
6 Cylinder 3.0, 4.3 (Diesel) Eng. 82-On
8 Cylinder 4.3, 4.9 Eng. 81-77

Cadillac: 8 Cylinder 4.1 Eng. 82-On

Chevrolet: 4 Cylinder 151 (2.5) Eng. 78-On
6 Cylinder 4.3 (Diesel) Eng. 82-On

Oldsmobile: 4 Cylinder 151 (2.5) Eng. 78-On
6 Cylinder 3.0, 4.3 (Diesel) Eng. 82-On
8 Cylinder 4.3S, 4.9T (301) Eng. 80-79

Pontiac: 4 Cylinder 151 (2.5) Eng. 77-On
6 Cylinder 4.3 (Diesel) Eng. 82-On
8 Cylinder 4.3S, 4.9T (301) Eng. 81-77

UNIT PACKAGE: 5



21354

(6507741-AA)
Zinc with
Rubber Gasket

Thread: M14-1.5
Hex: 13mm
Length Under Head: 21mm
Washer Head O.D.: 29mm

Fits the following application:
Chrysler

UNIT PACKAGE: 2



21353

(90009-PH1-000)
Zinc & Yellow

Thread: M14-1.5
Hex: 17mm
Length Under Head: 10mm
Washer Head: 24mm

Fits the following applications:
Acura & Honda

UNIT PACKAGE: 5



20347

(YS4Z-6730AA)
Plain with
Rubber Gasket

Thread: M12-1.75
Hex: 13mm
Length Under Head: 25mm
Washer Head O.D.: 26mm

Fits the following applications:
Ford 1999 - 93

UNIT PACKAGE: 2



21352

(N90288901)
Black Zinc

Thread: M14-1.5
Hex: 19mm
Length Under Head: 14mm

Fits the following applications:
Volkswagen

UNIT PACKAGE: 2

Sec. 13

OIL & TRANSMISSION DRAIN PLUGS WITH GASKETS



21135

(21512-23001)
Dacromet

Thread: M14-1.5
Hex: 17mm
Length Under Head: 17mm
Washer Head O.D.: 22.5mm

Fits the following applications:

Hyundai & Kia 1995 - On

UNIT PACKAGE: 2



18024

Zinc

Thread: M14-1.25
Hex: 13mm
Length Under Head: 16mm
Washer Head O.D.: 23mm

Fits the following applications:

Jeep

UNIT PACKAGE: 5



16308

Zinc

Thread: M14-1.5
Hex: 16mm
Length Under Head: 11mm
Washer Head O.D.: 25mm

Fits the following M14-1.5 applications:

Chrysler Imports: 83-On

Honda: 83-On

Isuzu: 87-On

Mazda: 72-On

Spectrum: 88-On

Sprint: 88-On

VW-Audi: 74-On

UNIT PACKAGE: 5



21798

(VW: N91167901)
Zinc

Oil Drain Plug with Gasket
Thread: M14-1.5
T-50 Torx® Drive
Length Under Head: 12mm
Head O.D.: 19mm

Fits the following M14-1.5 applications:

Audi: A3, A4 Quattro, A5 Quattro, A6, A6 Quattro, All Road Quattro & Q5

VW: Beetle Turbo, CC Lux, Eos Executive, Eos Komfort, Eos Sport, GTI, Jetta GLI, Tiguan S, Tiguan SE & Tiguan SEL 2007 - On

UNIT PACKAGE: 2



20426

(90009-PY3-000)

Zinc & Yellow
with Aluminum Gasket

Thread: M14-1.5
Hex: 17mm
Length Under Head: 15mm
Washer Head O.D.: 24mm

Fits the following M14-1.5 applications:

Acura & Honda: 2000 - On

UNIT PACKAGE: 5



21650

(55568037)

Zinc

Thread: M14-1.5
Hex: 10mm
Length Under Head: 16mm
Washer Head O.D.: 27mm

Fits the following applications:

Chevrolet: Cruze & Volt 2010 - On

UNIT PACKAGE: 2



18025

(E9DZ-6730-B)

Zinc

Thread: M14-1.5
Hex 13mm
Length Under Head: 16mm
Washer Head O.D.: 23mm

Fits the following applications:

Ford: Escort

UNIT PACKAGE: 5



22196

(Mazda: FS50-21-249 - Drain Plug,
9956-41-400 - Gasket)

Zinc

Oil Drain Plug with Gasket
Thread: M14-1.5
Drive: 8mm Allen
Head Diameter: 22mm
Length Under Head: 16mm

Fits the following applications:

Mazda: 3, 6 & CX-5 2012 - On; RX-8 2011 - 09

UNIT PACKAGE: 2



22205
(Honda: 90009-R70-A00)
Zinc
Oil Drain Plug with Gasket
Thread: M14-1.5
Hex: 17mm
Length Under Head: 18mm
Washer Head O.D.: 24.5mm

Fits the following applications
Honda: Accord 1999 - On; Civic 2014 - On

UNIT PACKAGE: 5



19773
(F75Z-6730-BA)
Phosphate with Rubber Gasket
Thread: M14-1.5
Hex: 16mm
Length Under Head: 20mm
Washer Head O.D.: 28mm

Fits the following applications:
Ford Vans & Trucks with 6.8L Eng. 2000-96

UNIT PACKAGE: 1



18375
(6503433)
Plain with Rubber Washer Face Gasket
Thread: M14-1.50
Hex: 17mm
Length Under Head: 18mm
Rubber Gasket O.D.: 28mm

Fits the following applications:
Chrysler 1.5 & 2.0 Eng.

UNIT PACKAGE: 2



19279
(F6TZ-6730BA)
Phosphate with Rubber Gasket
Thread M14-1.50
Hex: 13mm
Length Under Head: 20mm
Washer Head O.D.: 28mm

Fits the following applications:
Chrysler: with 2.0(F), 2.4(B,G,8), 2.7(R,T), 3.3(G,S,3) & 3.5(G,4) Eng. 2000 - On

Ford: Aerostar, Explorer & Ranger 6 Cylinder 4 Ltr. Eng. 1996-On

UNIT PACKAGE: 2

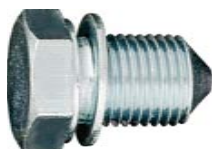

20746
(N90813201)
Zinc with Sems® Gasket
Thread: M14-1.5
Hex: 19mm
Length Under Head: 20mm
Sems® Washer O.D.: 20mm

Fits the following applications:
Audi Cabriolet & Quattro with 1.8,1.9, 2.0, 2.7, 2.8, & 3.0 Eng.

VW Beetle, Eurovan, Golf, Jetta, Passat & Touareg with 1.8, 1.9, 2.0, 2.8, 3.2 & 4.0 Eng.

UNIT PACKAGE: 2



14678
Zinc
Thread: M14-1.5
Hex: 16mm
Length Under Head: 20mm
Washer Head O.D.: 25mm

Fits the following M14-1.5 applications:
AMC: 4 Cylinder VW 121 Eng. 79-77

Chevrolet: 4 Cylinder 1.8 (Diesel) Eng. 81-On

Chrysler Corp. (Exc. Imports): 4 Cylinder All 78-On

Chrysler Corp. Imports: 4 Cylinder All 83-On
4 Cylinder K & W Engines (built after 10-81) 82

Ford Motor Co.: 4 & 6 Cylinder 98, 122, 140, 171 Eng. 73-On

Honda: 4 Cylinder Prelude 83-On

Mazda: 4 Cylinder All 72-On

Pontiac: 4 Cylinder 1.8 (Diesel) 83-On

Volkswagen: 4 Cylinder All (Water Cooled Engine) 74-On

UNIT PACKAGE: 5



19141
(6504018)
Plain with Rubber Washer Face Gasket
Thread: M14-1.50
Hex: 13mm
Length Under Head: 20mm
Rubber Gasket O.D.: 28mm

Fits the following applications:
Chrysler 2.0, 2.4, 2.7, 3.2, 3.5, 3.7 & 4.7 Eng. 2000 - On

UNIT PACKAGE: 2

Sec. 13

OIL & TRANSMISSION DRAIN PLUGS WITH GASKETS



18026
(601-997-02-30)
Zinc

Thread: M14-1.5
Hex: 13mm
Length Under Head: 24mm
Washer Head O.D.: 19mm

Fits the following applications:

Mercedes: 300 Series

UNIT PACKAGE: 2



21326
(Subaru: 807016160, 803916010;
Toyota: SU003-02194)
Zinc

Thread: M16-1.5 x 9mm
Hex 14mm
Washer Head O.D.: 24mm

Fits the following applications:

Subaru: Legacy & Outback 2.5L

Scion: FR-S 2.0L 2013

UNIT PACKAGE: 2



15528
Zinc

Thread: M16.4-1.33 O.S.
Hex: 19mm
Length Under Head: 13mm
Washer Head O.D.: 26mm

Fits the following M16.4 O.S. applications:

Nissan: All (Exc. Sentra, Stanza & Pulsar with FWD 62-On)

Renault: Fuego & Le Car 80-On

UNIT PACKAGE: 5



15529
Zinc

Thread: M18-1.5
Hex: 19mm
Length Under Head: 12mm
Washer Head O.D.: 29mm

Fits the following M18-1.5 applications:

Chrysler: All imports 70-On

Renault: Le Car 79-76

Toyota: All 75-On

UNIT PACKAGE: 5



15530
Zinc

Thread: M20-1.5
Hex: 17mm
Length Under Head: 15mm
Washer Head O.D.: 27mm

Fits the following M20-1.5 applications:

Chevrolet Truck: Luv 82-75

Honda: All exc. Prelude 73-On

Subaru: All 79-On

UNIT PACKAGE: 5



21041
(028-103-059-A)
Zinc

Thread: M24-1.5
Drive: 10mm Allen
Length Under Head: 10mm
Head Diameter: 32mm

Fits the following applications:

Audi: Cabriolet, A6, A8, Avant, Quattro, RS6, S4, S6 & S8

VW: Phaeton 6.0L & V8 4.2L and Touareg 4.2L

UNIT PACKAGE: 1



22344
(BMW: 11-13-7-605-018)
Black Plastic



Plastic Oil Drain Plug
With Rubber Gasket
Thread: M24-1.5 x 11mm
Top Head Diameter: 36mm
Internal Hex Drive: 10mm

Fits the following applications:

BMW: 228i, 320i, 328i, 428i, 528i, X1 & Z4 2014 - On

UNIT PACKAGE: 1



18027
Zinc

Thread: M25-1.5
Hex: 24mm
Length Under Head: 13mm
Washer Head O.D.: 35mm

Fits the following applications:

Toyota

UNIT PACKAGE: 1



Type 1



Type 2



Type 3

**Magnetic Oil Drain
Plugs with Gaskets**
Zinc Plated

Auveco Part No.	Type	Thread Size	Hex	Length Under Head	Finish	Unit Pkg.
19365	3	1/2"-20	3/4"	43/64"	Zinc	1
17145	1	1/2"-20 Single Oversize	3/4"	13/16"	Zinc	2
17146	1	1/2"-20 Double Oversize	3/4"	13/16"	Zinc & Yellow	2
17147	1	1/2"-20 Triple Oversize	3/4"	13/16"	Black Zinc	2
17148	2	12mm-1.75	13mm	19mm	Zinc	2



Metric

**Oversize Oil Pan Drain Plugs
with Fibre Gaskets**
Self-Tapping



Standard

Auveco Part No.	Size	Finish	Unit Pkg.
19587	1/2"-20, Single Oversize	Zinc	5
18121	1/2"-20, Double Oversize	Zinc & Yellow	5
18122	1/2"-20, Triple Oversize	Black Zinc	5
8285	5/8"-18, Single Oversize	Zinc	5
8286	11/16"-20, Single Oversize	Zinc	5
8288	3/4"-16, Single Oversize	Zinc	5
8289	7/8"-14, Single Oversize	Zinc	5
19618	M12-1.25, Single Oversize	Zinc	5
20759	M12-1.50, Single Oversize	Zinc	5
19619	M12-1.75, Single Oversize	Zinc	5
19620	M14-1.50, Single Oversize	Zinc	5

Oversize "Piggy-Back" Drain Plugs with Gasket



11782
Zinc

1/2"-20 Single Oversize
UNIT PACKAGE: 5



11783
Zinc & Yellow

1/2"-20 Double Oversize
UNIT PACKAGE: 5

Also available in Large Bulk Quantities



Ref. No: **1792**

1/4"-28, Straight
Thread Length: 9/64"
Overall Length: 1/2"
Ball Check, Plated

15055 Unit Pkg: 50
15074 Unit Pkg: 250
15075 Unit Pkg: 500
15440 Unit Pkg: 1000



Ref. No. **1952**

1/4" Drive Fit, Straight
Overall Length: 27/64"
No Check Valve, Plated

15065 Unit Pkg: 50
15094 Unit Pkg: 250
15450 Unit Pkg: 1000



Ref. No: **5530**

1/4"-28, Straight
Self-Tapping
Overall Length: 9/16"
Ball Check, Plated

15000 Unit Pkg: 50
15068 Unit Pkg: 250
15069 Unit Pkg: 500



Ref. No: **1911**

1/4"-28, 90°
Overall Length: 45/64"
Ball Check, Plated

9261 Unit Pkg: 25
15108 Unit Pkg: 100
15109 Unit Pkg: 250



Ref. No: **1636**

1/4"-28, 45°
Thread Length: .3"
Overall Length: 1"
Ball Check, Plated

15056 Unit Pkg: 25
15076 Unit Pkg: 100
15077 Unit Pkg: 250



Ref. No. **1680**

1/4"-28, Straight
Overall Length: 15/16"
Ball Check, Plated

9259 Unit Pkg: 25
15104 Unit Pkg: 100
15417 Unit Pkg: 1000



Ref. No: **1641**

1/4"-28, Straight
Thread Length: 7/32"
Overall Length: 9/16"
Ball Check, Plated

9257 Unit Pkg: 50
15100 Unit Pkg: 250
15101 Unit Pkg: 500
15415 Unit Pkg: 1000



Ref. No: **1637**

1/4"-28, 45°
Overall Length: 29/32"
Ball Check, Plated

9260 Unit Pkg: 25
15106 Unit Pkg: 100
15107 Unit Pkg: 250
15418 Unit Pkg: 1000



Ref. No: **1743**

1/4" Drive Fit, Straight
Overall Length: 1/2"
Ball Check, Plated

15054 Unit Pkg: 25
15072 Unit Pkg: 100
15073 Unit Pkg: 250
15439 Unit Pkg: 1000



Ref No: **5590**

1/4"-28, 90°
Self-Tapping
Overall Length: 43/64"
Ball Check, Plated

19176 Unit Pkg. 25
19177 Unit Pkg. 100
19178 Unit Pkg. 250



Ref. No: **1652**

1/4"-28 Straight
Overall Length: 11/16"
Ball Check, Plated

9258 Unit Pkg: 50
15102 Unit Pkg: 250
15103 Unit Pkg: 500
15416 Unit Pkg: 1000



Ref No: **1610**

1/8" Pipe, Straight
Overall Length: 5/8"
Ball Check, Plated

9262 Unit Pkg: 50
15110 Unit Pkg: 250
15111 Unit Pkg: 500
15420 Unit Pkg: 1000

GREASE FITTINGS

Also available in Large Bulk Quantities



Ref. No: **1688**

1/8" Pipe, 45°
Overall Length: 1"
Ball Check, Plated

- 9264** Unit Pkg: 25
- 15114** Unit Pkg: 100
- 15115** Unit Pkg: 250
- 15422** Unit Pkg: 1000



Ref. No: **1711**

5/16"-24, Straight
Overall Length: 5/8"
Ball Check, Plated

- 15057** Unit Pkg: 25
- 15078** Unit Pkg: 100
- 15079** Unit Pkg: 250



Ref. No: **1612**

1/8" Pipe, 65°
Overall Length: 7/8"
Ball Check, Plated

- 9265** Unit Pkg: 25
- 15116** Unit Pkg: 100
- 15117** Unit Pkg: 250
- 15423** Unit Pkg: 1000



Ref. No: **1608**

5/16" Drive Fit, Straight
Overall Length: 9/16"
Ball Check, Plated

- 15061** Unit Pkg: 50
- 15086** Unit Pkg: 250
- 15087** Unit Pkg: 500
- 15446** Unit Pkg: 1000



Ref No: **1607**

1/8" Pipe, Straight
Overall Length: 1-1/4"
Ball Check, Plated

- 9267** Unit Pkg: 25
- 15120** Unit Pkg: 100
- 15121** Unit Pkg: 250



Ref. No: **1710**

3/8"-24, Straight
Overall Length: 5/8"
Ball Check, Plated

- 15058** Unit Pkg: 25
- 15080** Unit Pkg: 100



Ref. No: **5570**

1/8" Pipe, Straight
Self-Tapping
Overall Length: 39/64"
Nominal Hole Size: 3/8"
Ball Check, Plated

- 15066** Unit Pkg: 25
- 15096** Unit Pkg: 100
- 15097** Unit Pkg: 250



Ref. No: **1627**

1/4" Pipe, Straight
Overall Length: 27/32"
Ball Check, Plated

- 15059** Unit Pkg: 25
- 15082** Unit Pkg: 100
- 15083** Unit Pkg: 250
- 15444** Unit Pkg: 1000



Ref. No: **1613**

1/8" Pipe, 90°
Overall Length: 53/64"
Ball Check, Plated

- 9266** Unit Pkg: 25
- 15118** Unit Pkg: 100
- 15119** Unit Pkg: 250
- 15424** Unit Pkg: 1000



Ref. No: **1629**

1/4" Pipe, 65°
Overall Length: 1"
Ball Check, Plated

- 15062** Unit Pkg: 10
- 15088** Unit Pkg: 50
- 15089** Unit Pkg: 100



Ref. No: **1728**

3/16" Drive Fit, Straight
Overall Length: 1/2"
Ball Check, Plated

- 15060** Unit Pkg: 50
- 15084** Unit Pkg: 250
- 15085** Unit Pkg: 500

Email your product suggestions to

mail@auveco.com

Sec. 13

METRIC GREASE FITTINGS

Also available in Large Bulk Quantities



Ref No: **8601**

6mm-1.00, Straight
DIN 71412
Overall Length: 14mm
Ball Check, Plated

11097 Unit Pkg: 5
15122 Unit Pkg: 50
15123 Unit Pkg: 100
15426 Unit Pkg: 1000



Ref. No: **7045**

6mm-1.00, 45°
Overall Length: 22mm
Ball Check, Plated

11775 Unit Pkg: 10
15132 Unit Pkg: 50
15133 Unit Pkg: 100
15431 Unit Pkg: 1000



Ref No: **7090**

6mm-1.00, 90°
Overall Length: 18mm
Ball Check, Plated

11776 Unit Pkg: 10
15134 Unit Pkg: 50
15135 Unit Pkg: 100



Ref No: **8901**

8mm-1.00, Straight
DIN 71412
Overall Length: 15mm
Ball Check, Plated

11098 Unit Pkg: 5
15124 Unit Pkg: 50
15125 Unit Pkg: 100



Ref No: **7445**

8mm-1.00, 45°
Overall Length: 23mm
Ball Check, Plated

11777 Unit Pkg: 10
15136 Unit Pkg: 50
15137 Unit Pkg: 100



Ref No: **7490**

8mm-1.00, 90°
DIN 71412
Overall Length: 18mm
Ball Check, Plated

11099 Unit Pkg: 5
15126 Unit Pkg: 50
15127 Unit Pkg: 100



Ref No: **9201**

8mm-1.25, Straight
Overall Length: 15mm
Ball Check, Plated

11778 Unit Pkg: 10
15138 Unit Pkg: 50
15139 Unit Pkg: 100
15434 Unit Pkg: 1000



Ref No: **7545**

8mm-1.25, 45°
Overall Length: 23mm
Ball Check, Plated

11779 Unit Pkg: 10
15140 Unit Pkg: 50
15141 Unit Pkg: 100



Ref No: **7590**

8mm-1.25, 90°
Overall Length: 18mm
Ball Check, Plated

11780 Unit Pkg: 10
15142 Unit Pkg: 50
15143 Unit Pkg: 100



Ref No: **9301**

10mm-1.00, Straight
DIN71412
Overall Length: 15mm
Ball Check, Plated

11100 Unit Pkg: 5
15128 Unit Pkg: 50
15129 Unit Pkg: 100



Ref No: **9345**

10mm-1.00, 45°
Overall Length: 23mm
Ball Check, Plated

15067 Unit Pkg: 25
15098 Unit Pkg: 100
15099 Unit Pkg: 250



Ref No: **9390**

10mm-1.00, 90°
DIN 71412
Overall Length: 19mm
Ball Check, Plated

11101 Unit Pkg: 5
15130 Unit Pkg: 50
15131 Unit Pkg: 100



Ref. No: **9501**

10mm-1.5 Straight
Overall Length: 15mm
Ball Check, Plated

17555 Unit Pkg: 50

Stainless Steel with Ball Check

303 Series Body • 420 Series Ball • 302 Series Spring



17156

Ref. No: 8058

8mm-1.00, Straight
Overall Length: 15mm

UNIT PACKAGE: 5

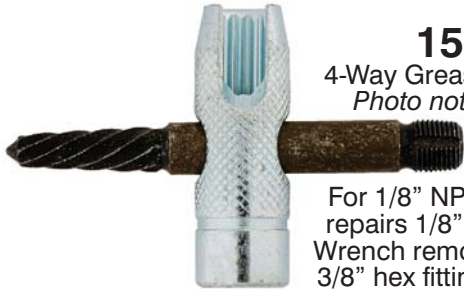

15694
4-Way Grease Fitting Tool
Photo not actual size

For 1/8" NPT fittings. Tap repairs 1/8" NPT threads. Wrench removes 7/16" and 3/8" hex fittings and plugs. Installs new 1/8" NPT fittings. "Easy Out" removes broken fittings.

UNIT PACKAGE: 1



Photo not actual size

16275

One-Hand Grease Gun
3-Way Loading
Uses 14.5 oz. Cartridge
16 oz. Bulk Capacity
2500 PSI Working Pressure
3 Claw Coupler

UNIT PACKAGE: 1

Photo not actual size

16277
Zinc with Black Rubber Grip



Professional Grease Gun
Delivers Grease at various Lever Openings
3-Way Loading
Uses 14.5 oz. Cartridge, 16 oz. Bulk Capacity
Variable Pressure
4 Claw Coupler

UNIT PACKAGE: 1

16276

Photo not actual size



Heavy Duty Grease Gun
3-Way Loading
Uses 14.5 oz. Cartridge, 16 oz. Bulk Capacity
10,000 PSI Working Pressure
3 Claw Coupler

UNIT PACKAGE: 1



15688

Grease Gun Coupler with Ball Check

Fits 1/8" NPT Threads
Working pressure: 3,000 PSI
Overall Length: 1-3/8"
For hand operated lube equipment

UNIT PACKAGE: 1



15689

Heavy Duty Grease Gun Coupler with Ball Check

Fits 1/8" NPT Threads
Working pressure: 5,000 PSI
Overall Length: 1-7/16"
For hand operated lube equipment only

UNIT PACKAGE: 1

Grease Gun Hoses
1/8" NPT Male Fittings

Photo not actual size



15691

12"
3000 PSI

UNIT PACKAGE: 1

15692

18"
3000 PSI

UNIT PACKAGE: 1

16279

12"
5800 PSI

UNIT PACKAGE: 1

16280

18"
5800 PSI

UNIT PACKAGE: 1

Grease Fitting Caps

Polyethylene caps that snap over fittings to seal out dirt and moisture. Integral ring keeps cap in place during servicing.



18109
Black

UNIT PACKAGE: 50



18110
Red

UNIT PACKAGE: 50



18111
Yellow

UNIT PACKAGE: 50



Hex Head Pipe Plugs
Cold Rolled Steel
Plain Finish

Auveco Part No.	O.E.M. No.	Pipe Size	Unit Pkg.
9278	GM: 444613	1/8-27	25
9279	GM: 444619, GM: 444620	1/4-18	25



Socket Head Pipe Plugs
Cold Rolled Steel
Plain Finish

Auveco Part No.	O.E.M. No.	Pipe Size	Unit Pkg.
9282	GM: 9427882	1/8-27	25
9283	GM: 444776	1/4-18	25
9284	GM: 444782	3/8-18	25
9285	GM: 444667, GM: 444789	1/2-14	25

BRASS FITTINGS

Inverted Flare Fittings



Inverted Nut
Brass

Auveco Part No.	Tube Size	Unit Pkg.
30	3/16"	10
31	1/4"	10
32	5/16"	10
33	3/8"	10



Inverted Nut
Steel

Auveco Part No.	Tube Size	Unit Pkg.
35	1/8"	10
36	3/16"	10
37	1/4"	10
38	5/16"	10
39	3/8"	10



Steel Plug

Auveco Part No.	Tube Size	Unit Pkg.
45	3/16"	10
46	1/4"	10
47	5/16"	10



Male Connector
Brass

Auveco Part No.	Tube Size	Pipe Thread	Unit Pkg.
49	1/8"	1/8"	5
50	3/16"	1/8"	5
51	1/4"	1/8"	5
52	5/16"	1/8"	5
53	3/8"	1/4"	5



Union
Brass

Auveco Part No.	Tube Size	Unit Pkg.
69	3/16"	5
70	1/4"	5
72	3/8"	5
73	1/2"	5



90° Male Elbow
Brass

Auveco Part No.	Tube Size	Pipe Thread	Unit Pkg.
75	3/16"	1/8"	5
76	1/4"	1/8"	5
77	5/16"	1/8"	5
78	3/8"	1/4"	5



45° Male Elbow
Brass

Auveco Part No.	Tube Size	Pipe Thread	Unit Pkg.
91	1/4"	1/8"	5



Male Branch
Brass
Photo not actual size

Auveco Part No.	Tube Size	Pipe Thread	Unit Pkg.
96	3/16"	1/8"	5

BRASS FITTINGS

Compression Fittings



**Sleeve
Brass**

Auveco Part No.	Tube Size	Unit Pkg.
101	1/8"	25
102	3/16"	25
103	1/4"	25
105	3/8"	25
107	1/2"	10



**Union
Brass**

Auveco Part No.	Tube Size	Unit Pkg.
150	1/8"	5
151	3/16"	5
152	1/4"	5
153	5/16"	5
154	3/8"	5
155	1/2"	5



**Nut
Brass**

Auveco Part No.	Tube Size	Unit Pkg.
110	1/8"	10
111	3/16"	10
112	1/4"	10
113	5/16"	10
114	3/8"	10



**Male Elbow
Brass**

Auveco Part No.	Tube Size	Pipe Thread	Unit Pkg.
158	1/8"	1/8"	5
159	3/16"	1/8"	5
161	1/4"	1/4"	5
162	5/16"	1/8"	5
163	5/16"	1/4"	5
164	3/8"	1/8"	5
168	1/2"	1/2"	5



**Male Connector
Brass**

Auveco Part No.	Tube Size	Pipe Thread	Unit Pkg.
119	1/8"	1/8"	5
120	3/16"	1/8"	5
121	1/4"	1/8"	5
122	1/4"	1/4"	5
123	5/16"	1/8"	5
124	5/16"	1/4"	5
125	3/8"	1/8"	5
126	3/8"	1/4"	5
127	3/8"	3/8"	5
128	1/2"	3/8"	5



**Female Connector
Brass**

Auveco Part No.	Tube Size	Pipe Thread	Unit Pkg.
134	1/8"	1/8"	5
135	3/16"	1/8"	5
137	5/16"	1/8"	5



**Union Tee
Brass**

Auveco Part No.	Tube Size	Unit Pkg.
186	3/16"	5
187	1/4"	5
189	3/8"	5

Double Compression Fittings

Threaded Sleeve



**Nut
Brass**

Auveco Part No.	Tube Size	Unit Pkg.
192	1/8"	10
193	3/16"	10
194	1/4"	10



**Male Connector
Brass**

Auveco Part No.	Tube Size	Pipe Thread	Unit Pkg.
198	1/8"	1/8"	5
200	1/4"	1/8"	5
201	5/16"	1/8"	5

Sec. 13

BRASS FITTINGS

S.A.E. 45° Flared Tube Fittings



S.A.E. Flare Nut
Long • Brass

Auveco Part No.	Tube Size	Unit Pkg.
211	3/16"	5



S.A.E. Flare Nut
Short • Brass

Auveco Part No.	Tube Size	Unit Pkg.
221	1/4"	5
223	3/8"	5
224	1/2"	5

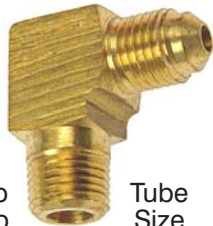

Male Elbow
Brass

Auveco Part No.	Tube Size	Pipe Thread	Unit Pkg.
230	1/4"	1/8"	5
231	1/4"	1/4"	5
232	5/16"	1/8"	5
233	5/16"	1/4"	5



Union
Brass

Auveco Part No.	Tube Size	Unit Pkg.
245	5/16"	5
246	3/8"	5
247	1/2"	5



Male Connector
Brass

Auveco Part No.	Tube Size	Pipe Thread	Unit Pkg.
262	1/4"	1/4"	5
263	5/16"	1/8"	5
264	5/16"	1/4"	5
265	3/8"	1/4"	5
266	3/8"	1/8"	5
268	1/2"	3/8"	5
269	1/2"	1/2"	5

**Refer to page 291 for
Pipe Thread Identification**

BRASS FITTINGS

Pipe Fittings



Cap
Brass

Auveco Part No.	Pipe Thread	Unit Pkg.
287	1/8"	5
288	1/4"	5



Slotted Plug
Brass

Auveco Part No.	Pipe Thread	Unit Pkg.
289	1/8"	5



Square Head Plug
Brass

Auveco Part No.	Pipe Thread	Unit Pkg.
291	1/8"	5
292	1/4"	5
293	3/8"	5
294	1/2"	5



Hex Head Plug
Brass

Auveco Part No.	Pipe Thread	Unit Pkg.
295	1/8"	5
296	1/4"	5
297	3/8"	5
298	1/2"	5



Bushing
Brass

Auveco Part No.	External Pipe Thread	Internal Pipe Thread	Unit Pkg.
299	1/4"	1/8"	5
300	3/8"	1/8"	5
301	3/8"	1/4"	5
302	1/2"	1/8"	5
303	1/2"	1/4"	5
304	1/2"	3/8"	5

BRASS FITTINGS

Pipe Fittings



**Close Nipple
Brass**

Auveco Part No.	Length	Pipe Thread	Unit Pkg.
305	3/4"	1/8"	5
306	7/8"	1/4"	5
307	1"	3/8"	5
308	1-1/8"	1/2"	5



**Long Nipple
Brass**

Auveco Part No.	Length	Pipe Thread	Unit Pkg.
309	1-1/2"	1/8"	5
310	2"	1/8"	5
311	2-1/2"	1/8"	5
313	1-1/2"	1/4"	5
314	2"	1/4"	5
315	2-1/2"	1/4"	5



**Hex Nipple
Brass**

Auveco Part No.	Pipe Thread A	Pipe Thread B	Unit Pkg.
316	1/8"	1/8"	5
317	1/4"	1/4"	5
318	1/4"	1/8"	5
319	3/8"	3/8"	5
320	3/8"	1/8"	5
321	3/8"	1/4"	5
322	1/2"	1/2"	5



**Adapter
Brass**

Auveco Part No.	Pipe Thread A	Pipe Thread B	Unit Pkg.
325	1/8"	1/8"	5
326	1/4"	1/8"	5
327	1/4"	1/4"	5
328	3/8"	1/4"	5
329	3/8"	3/8"	5
330	1/2"	3/8"	5



**Coupling
Brass**

Auveco Part No.	Pipe Thread	Unit Pkg.
331	1/8"	5
332	1/4"	5
333	3/8"	5
334	1/2"	5



**Reducing Coupling
Brass**

Auveco Part No.	Pipe Thread A	Pipe Thread B	Unit Pkg.
335	1/4"	1/8"	5
336	3/8"	1/8"	5
337	3/8"	1/4"	5
339	1/2"	3/8"	5



**Union
Brass**

Auveco Part No.	Pipe Thread	Unit Pkg.
341	1/4"	5



**90° Street Elbow
Brass**

Auveco Part No.	Internal Pipe Thread	External Pipe Thread	Unit Pkg.
342	1/8"	1/8"	5
343	1/4"	1/4"	5
344	3/8"	3/8"	5



**45° Street Elbow
Brass**

Auveco Part No.	Pipe Thread	Unit Pkg.
347	1/8"	5
348	1/4"	5
349	3/8"	5

Sec. 13

BRASS FITTINGS
Pipe Fittings, Drain Cocks and Valves



90° Pipe Elbow
Brass

Auveco Part No.	Internal Pipe Thread	Unit Pkg.
350	1/8"	5
351	1/4"	5
352	3/8"	5



Tee
Brass

Auveco Part No.	Pipe Thread	Unit Pkg.
355	1/8"	5
356	1/4"	5



Cross
Brass

Auveco Part No.	Pipe Thread	Unit Pkg.
353	1/8"	5

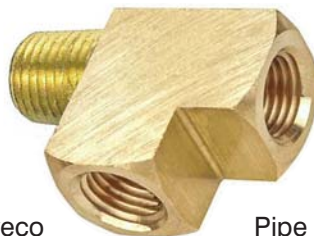

Street Tee
Brass

Auveco Part No.	Pipe Thread	Unit Pkg.
359	1/8"	5
360	1/4"	5

PIPE THREAD IDENTIFICATION



1/8"



1/4"



3/8"



1/2"

BRASS FITTINGS

Drain Cocks and Valves



External Seat
Brass

Auveco Part No.	Pipe Thread	Unit Pkg.
370	1/8"	5
371	1/4"	5
372	3/8"	5



Angle Bib Drain
Brass

Auveco Part No.	Pipe Thread	Height	Unit Pkg.
374	1/4"	1-11/16"	5



Compression Line
Brass

Auveco Part No.	Tube Size	Unit Pkg.
385	1/4"	3



Ground Plug Drain
Brass

Auveco Part No.	Pipe Thread	Unit Pkg.
405	1/8"	5
406	1/4"	5

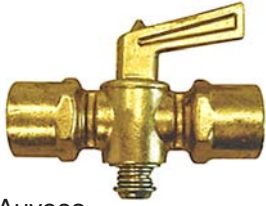

**Female Pipe
Ground Plug Line
Brass**

Auveco Part No.	Pipe Thread	Unit Pkg.
399	1/8"	3
401	1/4"	3



**Multiple
Shut-Off Valves
Stem Short
Brass**

Auveco Part No.	Description	Unit Pkg.
404	3 Way, 1/4 Female, 3 Ends	1



**Beaded Hose Barb
90° Elbow Tube
to Male Pipe**

Auveco Part No.	I.D. Hose Size	Pipe Thread	Unit Pkg.
464	5/8"	1/2"	3
465	3/4"	1/2"	2



**Beaded Hose Barb
Tube to Male Pipe**

Auveco Part No.	I.D. Hose Size	Pipe Thread	Unit Pkg.
413	3/8"	3/8"	5
415	1/2"	3/8"	5
416	5/8"	3/8"	5
417	5/8"	1/2"	5
418	3/4"	1/2"	5



**Hose Barb to
Taper Male Pipe**

Auveco Part No.	I.D. Hose Size	Pipe Thread	Unit Pkg.
424	3/16"	1/8"	10
425	1/4"	1/8"	10
426	1/4"	1/4"	10
427	1/4"	3/8"	5
428	5/16"	1/8"	10
429	5/16"	1/4"	5
430	3/8"	1/8"	10
431	3/8"	1/4"	10
432	3/8"	3/8"	5
433	1/2"	1/4"	5
434	1/2"	3/8"	5
435	1/2"	1/2"	5



**Barbed Hose
Coupler**

Auveco Part No.	I.D. Hose Size	Overall Length	Unit Pkg.
419*	3/16"	1.44"	5
420	1/4"	2.00"	5
421	5/16"	2.00"	5
422	3/8"	2.00"	5
423	1/2"	2.00"	5

* 3 Barb Design



**Hose Barb to
Taper Female Pipe**

Auveco Part No.	I.D. Hose Size	Pipe Thread	Unit Pkg.
437	1/4"	1/4"	5
438	5/16"	1/4"	5
439	3/8"	1/8"	5
440	3/8"	1/4"	5
442	1/2"	3/8"	5
443	1/2"	1/2"	5



**Hose Barb 90° Elbow
Tube to Male Pipe**

Auveco Part No.	I.D. Hose Size	Pipe Thread	Unit Pkg.
455	1/4"	1/8"	5
456	1/4"	1/4"	5
457	3/8"	1/4"	5



**Brazier Head
Solid Aluminum Rivets**

Auveco Part No.	Diameter	Length	Head Diameter	Unit Pkg.
9643	3/16"	3/8"	15/32"	100
9644	3/16"	3/8"	15/32"	1000
12528	3/16"	1/2"	15/32"	100
12529	3/16"	1/2"	15/32"	1000
9647	1/4"	3/8"	5/8"	100
9648	1/4"	3/8"	5/8"	1000

**Refer to pages 316 for
Drill Bits used with Rivets**



Pan'l Blind Rivets



Dome Head

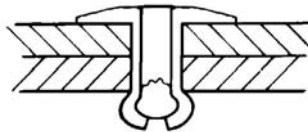

Large Flange

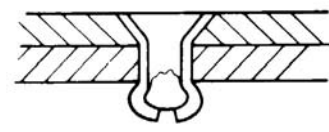

Countersunk

Auveco Part No.					Head (Flange) Type & Diameter	Rivet Diameter	Grip Range	Rivet Length Exc. Flange	Cross Reference	
25	50	100	500	1000					POP®	Marson Klik-Fast

Steel Rivet & Mandrel •Plated

	19045				Dome	3/16"	3/32"	1/8" - 1/4"	23/64"	SD34BS	SB3-4
	19046				Dome	1/4"	1/8"	1/32" - 1/16"	13/64"	SD41BS	SB4-1
	5749	5748	8871		Dome	1/4"	1/8"	1/16" - 1/8"	7/32"	SD42BS	SB4-2
	5751	5750	8872		Cntrsnsk	7/32"	1/8"	1/16" - 1/8"	7/32"	SK42BS	SC4-2
	8291	8290	8873		Lg Flange	3/8"	1/8"	1/16" - 1/8"	7/32"	SD42BSLF	SBL4-2
	8874	8875			Dome	1/4"	1/8"	1/8" - 3/16"	5/16"	SD43BS	SB4-3
	5753	5752	8877		Dome	1/4"	1/8"	3/16" - 1/4"	25/64"	SD44BS	SB4-4
	8303	8302			Cntrsnsk	7/32"	1/8"	3/16" - 1/4"	25/64"	SK44BS	SC4-4
	8293	8292	8879		Lg Flange	3/8"	1/8"	3/16" - 1/4"	25/64"	SD44BSLF	SBL4-4
	8880	8881	8882		Dome	1/4"	1/8"	5/16" - 3/8"	1/2"	SD46BS	SB4-6
	19047				Dome	1/4"	1/8"	3/8" - 1/2"	41/64"	SD48BS	SB4-8
	8883	8884			Dome	5/16"	5/32"	1/16" - 1/8"	7/32"	SD52BS	SB5-2
	8886	8887	8888		Dome	5/16"	5/32"	3/16" - 1/4"	3/8"	SD54BS	SB5-4
	8889				Dome	3/8"	3/16"	1/16" - 1/8"	9/32"	SD62BS	SB6-2
	8892	8893	8894		Dome	3/8"	3/16"	1/8" - 1/4"	7/16"	SD64BS	SB6-4
18811					Lg Flange	5/8"	3/16"	1/8" - 1/4"	7/16"	SD64BSLF	SBL6-4
	8895	8896	8897		Dome	3/8"	3/16"	1/4" - 3/8"	9/16"	SD66BS	SB6-6
	8305	8304	8898		Lg Flange	5/8"	3/16"	1/4" - 3/8"	9/16"	SD66BSLF	SBL6-6
	8899	8900	8901		Dome	3/8"	3/16"	3/8" - 1/2"	11/16"	SD68BS	SB6-8
18812					Lg Flange	5/8"	3/16"	3/8" - 1/2"	11/16"	SD68BSLF	SBL6-8
	8902	8903			Dome	3/8"	3/16"	1/2" - 5/8"	13/16"	SD610BS	SB6-10
18814					Lg Flange	5/8"	3/16"	5/8" - 3/4"	15/16"	SD612BSLF	SBL6-12
21402					Dome	1/2"	1/4"	5/8" - 3/4"	1"	SD812BS	
19048					Dome	1/2"	1/4"	3/4" - 1"	1-15/64"	SD816BS	

(Continued on next page)

PAN'L BLIND RIVETS

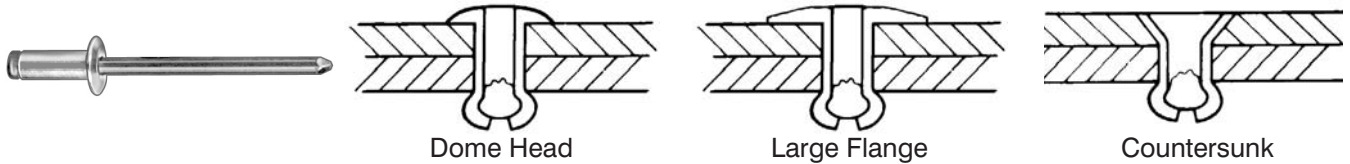

Auveco Part No.				Head (Flange) Type & Diameter	Rivet Diameter	Grip Range	Rivet Length Exc. Flange	Cross Reference	
Unit	Package	Quantity	POP®					Marson Klik-Fast	

Aluminum Rivet • Steel Mandrel

25	50	100	500	1000	Dome 1/4"	1/8"	1/16" - 1/8"	7/32"	AD42BS	AB4-2
					Cntrs nk 7/32"	1/8"	1/16" - 1/8"	7/32"	AK42BS	AC4-2
					Dome 1/4"	1/8"	3/16" - 1/4"	3/8"	AD44BS	AB4-4
					Cntrs nk 7/32"	1/8"	3/16" - 1/4"	3/8"	AK44BS	AC4-4
					Dome 1/4"	1/8"	3/8" - 1/2"	41/64"	AD48BS	AB4-8
					Dome 5/16"	5/32"	3/16" - 1/4"	27/64"	AD54BS	AB5-4
					Dome 3/8"	3/16"	1/16" - 1/8"	9/32"	AD62BS	AB6-2
					Dome 3/8"	3/16"	1/8" - 1/4"	3/8"	AD64BS	AB6-4
					Dome 3/8"	3/16"	1/4" - 3/8"	9/16"	AD66BS	AB6-6
					Lg Flange 5/8"	3/16"	3/8" - 1/2"	11/16"	AD68BSLF	ABL6-8

Aluminum Rivet & Mandrel

					Dome 3/16"	3/32"	1/32" - 1/8"	15/64"	AD32ABS	AB3-2A
					Dome 1/4"	1/8"	1/16" - 1/8"	7/32"	AD42ABS	AB4-2A
					Cntrs nk 7/32"	1/8"	1/16" - 1/8"	7/32"	AK42ABS	AC4-2A
					Lg Flange 3/8"	1/8"	1/16" - 1/8"	7/32"	AD42ABSLF	ABL4-2A
					Dome 1/4"	1/8"	3/16" - 1/4"	3/8"	AD44ABS	AB4-4A
					Cntrs nk 7/32"	1/8"	3/16" - 1/4"	3/8"	AK44ABS	AC4-4A
					Lg Flange 3/8"	1/8"	3/16" - 1/4"	3/8"	AD44ABSLF	ABL4-4A
					Dome 1/4"	1/8"	5/16" - 3/8"	1/2"	AD46ABS	AB4-6A
					Dome 1/4"	1/8"	3/8" - 1/2"	5/8"	AD48ABS	AB4-8A
					Lg. Flange 3/8"	1/8"	3/8" - 1/2"	5/8"		ABL4-8A
					Dome 5/16"	5/32"	1/16" - 1/8"	9/32"	AD52ABS	AB5-2A
					Dome 5/16"	5/32"	1/8" - 3/16"	11/32"	AD53ABS	AB5-3A
					Dome 5/16"	5/32"	3/16" - 1/4"	13/32"	AD54ABS	AB5-4A
					Lg Flange 15/32"	5/32"	3/16" - 1/4"	13/32"	AD54ABSLF	
					Dome 5/16"	5/32"	1/4" - 3/8"	1/2"	AD56ABS	AB5-6A
					Dome 5/16"	5/32"	3/8" - 1/2"	5/8"	AD58ABS	AB5-8A
					Dome 3/8"	3/16"	1/16" - 1/8"	9/32"	AD62ABS	AB6-2A
					Dome 3/8"	3/16"	1/8" - 1/4"	7/16"	AD64ABS	AB6-4A
					Lg Flange 5/8"	3/16"	1/8" - 1/4"	7/16"	AD64ABSLF	ABL6-4A
					Dome 3/8"	3/16"	1/4" - 3/8"	9/16"	AD66ABS	AB6-6A
					Lg Flange 5/8"	3/16"	1/4" - 3/8"	9/16"	AD66ABSLF	ABL6-6A
					Dome 3/8"	3/16"	3/8" - 1/2"	11/16"	AD68ABS	AB6-8A
					Lg Flange 5/8"	3/16"	3/8" - 1/2"	11/16"	AD68ABSLF	ABL6-8A
					Dome 3/8"	3/16"	1/2" - 5/8"	13/16"	AD610ABS	AB6-10A
					Lg Flange 5/8"	3/16"	1/2" - 5/8"	13/16"	AD610ABSLF	ABL6-10A
					Dome 1/2"	1/4"	1/4" - 3/8"	39/64"	AD86ABS	AB8-6A

Stainless Steel Rivet & Mandrel

					Dome 1/4"	1/8"	3/16" - 1/4"	25/64"	SSD44SSBS	SSB4-4S
					Dome 3/8"	3/16"	3/8" - 1/2"	11/16"	SSD68SSBS	SSB6-8S

Stainless Steel Rivet • Steel Mandrel

Replaces Ford No.: 383229-S

To replace welded studs on body. (Use Auveco Rivet Gun 7915 with 7981 Nose Piece.)

					Sm. Flange 3/16"	1/8"	3/16" - 1/4"	5/16"	R4357	SSBN4-3
--	--	--	--	--	------------------	------	--------------	-------	-------	---------



Steel Rivet Washers
Zinc

16791

Outer Diameter: 1/2"
For 1/8" Diameter

UNIT PACKAGE: 100

15973

Outer Diameter: 1/2"
For 5/32" Diameter

UNIT PACKAGE: 100

16792

Outer Diameter: 15/32"
For 3/16" Diameter

UNIT PACKAGE: 100

22409

Economy Rivet Gun

Photo not actual size



Overall Length: 10"
With 3/32", 1/8", 5/32" and 3/16" nose pieces.
Replacement accessories are not available

UNIT PACKAGE: 1

7915

Pan'l Rivet Gun

Photo not actual size



Overall Length: 9-1/2"
With 3/32", 1/8", 5/32" and 3/16" nose pieces

UNIT PACKAGE: 1



19215

Replacement Jaws for
Auveco Rivet Gun 7915

UNIT PACKAGE: 1 Set



Nose Pieces

For Auveco Rivet Gun 7915

Auveco Part No.	Description	Unit Pkg.
7981	Use with 1/8" rivet 11104 to replace welded studs	1
7983	For 1/8" diameter rivets	1
7984	For 5/32" diameter rivets	1
7985	For 3/16" diameter rivets	1

11817

Photo not actual size



Rivet gun for setting 3/16" & 1/4" rivets.
Use to install "Peel-Type" Rivets.
Comes complete with 3/16" and 1/4" standard nose pieces plus a nose piece for 1/4" "Peel Type" rivets.
Length: 22"

UNIT PACKAGE: 1



19132

Nose piece for 1/8" standard rivets
Auveco 11817 Accessory

UNIT PACKAGE: 1



19133

Nose piece for 3/16" standard rivets
Auveco 11817 Accessory

UNIT PACKAGE: 1



19134

Nose piece for 1/4" standard rivets
Auveco 11817 Accessory

UNIT PACKAGE: 1



11853

Nose piece for 1/4" "Peel Type" rivets.
Auveco 11817 Accessory

UNIT PACKAGE: 1



14799

Replacement jaws repair kit for
Auveco Rivet Gun 11817

UNIT PACKAGE: 1



21655

Nose Piece
For 3/16" Monobolts
Auveco 11817 Accessory

UNIT PACKAGE: 1



21656

Nose Piece
For 1/4" Monobolts
Auveco 11817 Accessory

UNIT PACKAGE: 1



13808

For 3/16" Rivets
Nose piece for setting
Auveco Klamp-Tite Rivets with
a Pneumatic Tool.

UNIT PACKAGE: 1



19066
Rivet Gun

Photo not actual size

Overall Length: 21"
With nose pieces for 3/32", 1/8", 5/32",
3/16" & 1/4" diameter rivets.

UNIT PACKAGE: 1



13756

Rivet Setter Gun
For Nylon Rivets

For use with nylon
(plastic) blind rivets.

A durable tool that sets all
sizes with a single stroke.
All steel construction.
Not for use with metal rivets.
Length: 6-1/2"

UNIT PACKAGE: 1

TIPS FOR NAVIGATING THE CATALOG

• Color Coded Pages

Yellow- New Items

Blue- Metric Items

Brown- Electric Accessories

Green- Assortments, Cabinets,
Bins and Racks

Gray- Key Blanks & Accessories

Pink- Import Car Body Hardware

• Specification Charts

Body Bolts- Pages: 88 & 121-122

Special Tapping Screws- Pages: 91-94 & 128-130

License Plate Screws- Pages: 105-106

Retainers- Pages: 475-489

Push-Type Retainers- Pages: 534-545

• Indexes. Located in the front

Pictorial

Alphabetical

Numerical

• Images are actual size unless noted otherwise

• OEM Part Cross Reference: Indexed
according to OEM number and Part Number.
Located in the back

Located in the front after the numerical index

• Screw Identification charts: head styles,
driving recesses, point styles and sizing.

• List of common terminology with brief
descriptions

• Plating and finish types with brief descriptions

Sec. 14

AUTOMOTIVE O.E.M. NYLON BLIND RIVETS

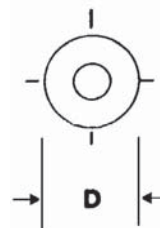
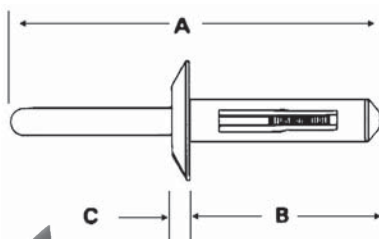
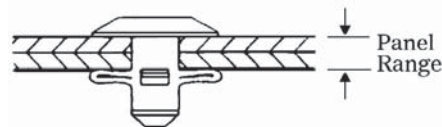

Type 1

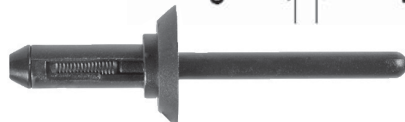

Type 2



Type 3



Type 4



Type 5



Type 6

Auveco Part No.	Type	Color	O.E.M. Number	Hole Diameter	Panel Range (Grip)	A	B	C	D	Unit Pkg.
17220	3	Black	GM: 21094747	5/32"	7/64"-7/32"	1-7/8"	3/4"	3/32"	**	50
15187	6	Black	Ford: N804583S	4mm	6mm-10.5mm	65mm	26mm	2.5mm	***	25
13746	1	Black	GM: 20612732	3/16"	1/16"-9/64"	1-7/8"	23/32"	3/32"	11/32"	25
18501	1	Black	Chry: 6502689	3/16"	5/32"-1/4"	1-27/32"	21/32"	1/16"	11/32"	25
21327	1	Black	GM: 11588308	4.95mm	3mm - 6mm	48mm	18mm	1.7mm	9mm	25
13747	1	Black	GM: 20423647, Ford: N804189S	13/64"	1/16"-11/64"	1-7/8"	23/32"	1/8"	15/32"	25
14005	1	Black	GM: 20465395, Chry: 6004212	13/64"	1/8"-5/32"	1-13/16"	21/32"	1/16"	11/32"	25
13748	1	Black	GM: 20432975, VW:175-853-57701C, Chry: 6503800, Ford: N804343S	13/64"	1/8"-15/64"	1-7/8"	25/32"	1/16"	15/32"	25
13754	1	Black	Chry: 6500859	13/64"	1/8"-3/16"	1-7/8"	25/32"	1/16"	15/32"	25
13755	1	Black	Chry: 6500898 GM: 15718794	13/64"	15/64"-25/64"	2"	1"	1/16"	15/32"	25
14004	1	Black	GM: 25524005	15/64"	11/64"-11/32"	2-3/64"	1-1/8"	3/32"	1/2"	25
14023	1	Black	GM: 10036503	15/64"	5/32"-5/16"	2-1/8"	1-5/32"	3/32"	5/8"	25
18913	1	Black	Chry: 6503938	15/64"	5/32"-9/32"	2-5/32"	1-1/16"	3/32"	1/2"	25
20754	1	Black	BMW: 51-71-7-002-953-2	6mm	2.5mm-4.8mm	53mm	22mm	2.5mm	20mm	25
18028	2	Black	Chry: 4630088	1/4"	1/32"-11/64"	2-3/16"	13/16"	3/32"	21/32"	25
18031	2	Black*	Chry: 4630660	1/4"	1/32"-3/16"	2-1/8"	3/4"	3/32"	21/32"	25
15488	4	Black	GM: 10069112	1/4"	3/64"-5/32"	2-3/16"	15/16"	7/64"	13/16"	50
18242	5	Black	Chry: 6501509	1/4"	3/64"-3/16"	2-7/32"	1-1/8"	3/32"	25/32"	25
13749	1	White	GM: 14070914	1/4"	5/32"-15/64"	2-3/16"	23/32"	3/32"	21/32"	25
21446	1	Black	Chry: 6508444-AA	1/4"	5/32"-15/64"	2-3/16"	1-1/8"	3/32"	1-1/32"	15
18502	1	Black	General Purpose	1/4"	5/32"-1/4"	2-3/16"	23/32"	3/32"	21/32"	25
21028	1	Black	GM: 15614746	1/4"	5/32"-3/8"	2-3/16"	1-1/8"	3/32"	21/32"	25
18108	1	Black	Chry: 34201631	1/4"	5/32"-3/8"	2-7/32"	1-1/8"	3/32"	11/16"	25
17496	1	Gray	AMC: 8934-201-835	1/4"	5/32"-3/8"	2-7/32"	1-1/8"	3/32"	11/16"	25
14012	1	White	GM: 15506827	1/4"	5/32"-13/32"	2"	1-1/8"	3/32"	21/32"	25

* Black Rivet Body, White Mandrel

** 5/16" x 19/32"

*** 8.5mm x 15.5mm

(Continued on next page)

AUTOMOTIVE O.E.M. NYLON BLIND RIVETS

Sec. 14



Type 1

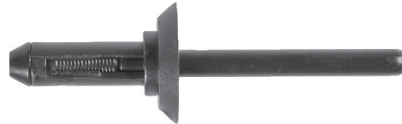

Type 2



Type 3



Type 4

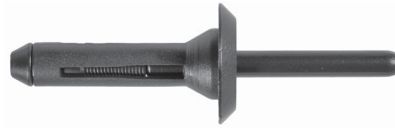

Type 5



Type 6

Auveco Part No.	Type	Color	O.E.M. Number	Hole Diameter	Panel Range (Grip)	A	B	C	D	Unit Pkg.
13751	1	Black	GM: 10184895 Ford: N803862-S Chry: 6501559,6506007-AA	1/4"	5/32"-13/32"	2-3/16"	1-3/32"	3/32"	1/2"	25
13750	1	Black	GM: 14063981 Ford: N803043-S Chry: 6500911, 6504700	1/4"	5/32"-13/32"	2-3/16"	1-3/32"	3/32"	21/32"	25
15491	1	Black	Ford: N804759-S	1/4"	19/64"-27/64"	2-1/8"	13/16"	3/32"	21/32"	25
17101	1	Black	Ford: N804675S Chry: 4370138, 6503860	1/4"	5/16"-15/32"	2-9/32"	1-1/4"	3/32"	21/32"	25
22139	4	Black	Ford: N803739-S	6.3mm	.70-.85mm	56mm	20mm	3mm	18mm	25
13752	1	Black	GM: 15955172, 20421672	17/64"	3/32"-3/16"	1-7/8"	25/32"	3/32"	1/2"	25
13753	1	Black	GM: 20433026 VW: 175-853-577A	17/64"	3/32"-3/16"	1-7/8"	25/32"	3/32"	23/32"	25
15490	1	Black	GM: 10109689, 12337915	9/32"	3/32"-15/64"	2-3/16"	15/16"	3/32"	23/32"	25

Note: Use rivet guns 13756 to install all of the above rivets.

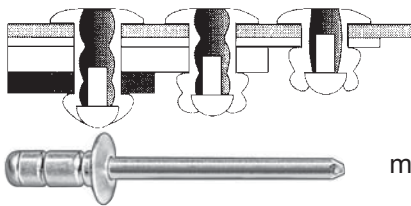

POP® MULTI-GRIP BLIND RIVETS

Functions in a Wide Range of Material Thickness

The Multi-Grip rivet will serve in applications where solid, soft materials and thicknesses normally require several rivet sizes. Oversize, irregular or misaligned holes are automatically compensated for by self-adjusting hole-filling capability. The mandrel head is retained in the rivet body, forming a tight, weather resistant seal.

Auveco Part No.	Head Style & Diameter	Rivet Diameter	Hole Size	Grip Range	Rivet Length Excluding Flange	Unit Pkg.	Pop® No.
Aluminum Rivet • Steel Mandrel							
19033	Large Flange 3/8"	1/8"	.129"-.142"	3/64"-3/16"	21/64"	100	AD41-43BSLF
19025	Dome 1/4"	1/8"	.129"-.142"	5/32"-5/16"	15/32"	100	AD43-45BS
19034	Large Flange 3/8"	1/8"	.129"-.142"	5/32"-5/16"	15/32"	100	AD43-45BSLF
19026	Dome 1/4"	1/8"	.129"-.142"	1/4"-7/16"	39/64"	100	AD45-47BS
18743	Dome 5/16"	5/32"	.160"-.173"	3/64"-1/4"	13/32"	100	AD52-54BS
17468	Large Flange 15/32"	5/32"	.160"-.173"	3/64"-1/4"	13/32"	50	AD52-54BSLF
19027	Dome 5/16"	5/32"	.160"-.173"	1/8"-5/16"	1/2"	50	AD53-55BS
18744	Dome 3/8"	3/16"	.192"-.205"	1/16"-1/4"	7/16"	50	AD62-64BS
19036	Large Flange 5/8"	3/16"	.192"-.205"	1/16"-1/4"	7/16"	50	AD62-64BSLF
19028	Dome 3/8"	3/16"	.192"-.205"	3/16"-3/8"	5/8"	50	AD63-66BS
19029	Dome 3/8"	3/16"	.192"-.205"	1/4"-1/2"	47/64"	50	AD66-68BS
19037	Large Flange 5/8"	3/16"	.192"-.205"	1/4"-1/2"	47/64"	50	AD66-68BSLF
19030	Dome 3/8"	3/16"	.192"-.205"	7/16"-3/4"	1-1/16"	50	AD68-612BS
19031	Dome 1/2"	1/4"	.261"-.275"	5/64"-11/32"	39/64"	25	AD82-86BS

What makes Avex different and better?

The Avex rivet adds important and exclusive features to those offered by ordinary blind rivets. The unique advantages designed into the Avex rivet allow for its use:

In wide-tolerance holes. Since the rivet can expand up to its own head diameter, accurate hole sizing or alignment is not necessary.

To pull sheets together. The extraordinary rivet tail expansion automatically effects superior clamp-up action on the parts being assembled.

Over a vast range of thicknesses. The “dubble-bubble” expansion feature offers the capability to fasten securely in both thick and thin grip ranges with a single length rivet.

While providing a sealed stem. The rivet material flows both behind and in front of the mandrel insuring a positively retained and sealed stem.

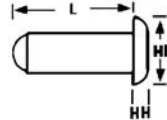

Dome Head

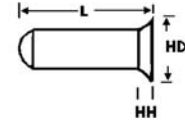

120° Countersunk

Auveco Part No.				Head (Flange) Style	Rivet Diameter	Grip	Length L	Flange Diameter HD	Flange Height HH	Hole Size
Unit	Package	Quantity								
25	100	500	1000							
	10336	10337		Countersunk	1/8"	To 1/4"	15/32"	.205"	.030"	.136"
	10351	10352		Dome	5/32"	To 1/4"	15/32"	.255"	.057"	.166"
	10357	10358	10359	Dome	3/16"	To 7/16"	23/32"	.349"	.070"	.199"
	10345	10346		Countersunk	3/16"	To 1/2"	25/32"	.339"	.050"	.199"
17654	17655			Dome	1/4"	To 11/32"	21/32"	.500"	.094"	.268"

Avex® Brazier Head Rivet



17433
Yellow Zinc

Diameter: 3/16"
Grip: 3/16"-7/16"
Head Diameter: 15/32"
Body Length: 11/16"
Aluminum Rivet & Steel Mandrel

UNIT PACKAGE: 50

Large Head 3/16" Plywood Rivets



Non-Structural
Break Mandrel Rivets
Aluminum Rivet & Steel Mandrel (Plated)

Auveco Part No.	Grip	Head Diameter	Head Thickness	Hole Size & Drill	Unit Pkg.
13805	3/8"-1/2"	5/8"	3/32"	.192 to .196"	50
13807	7/8"-1"	5/8"	3/32"	#11	50

Stavex® Large Flange Rivets

- Large flange head enables soft, pliable materials to be fastened
- All steel construction (zinc plated) provides high shear and tensile values.
- Typical applications:
 - Plastic energy absorbing strip to automotive bumper
 - Plywood liners to both sidewalls and roofs in truck bodies and trailers



Auveco Part No.	Diameter	Grip	Flange Diameter	Hole Size	Unit Pkg.
16988	3/16"	3/64"-1/4"	5/8"	.192-.196"	25
16989	3/16"	1/16"-3/8"	5/8"	.192-.196"	25

Auveco Klamp-Tite Rivets

- Largest Blind Head
 - Fills hole tightly
 - High Clamp-Up
- Water Tight Capability
 - Fully Cored
- Structural- Self Plugging
- Head Style- Protruding

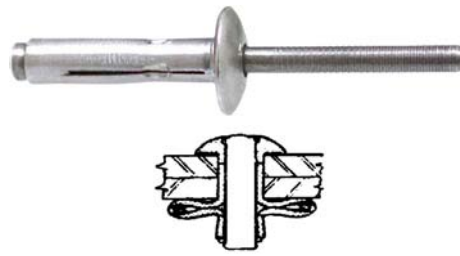

Mandrel breaks flush with top of rivet head anywhere within grip range.

Material: Rivet 5056 Aluminum,
Mandrel 7075 Aluminum
Finish: Wax (Do Not Remove)

Note: For use with pneumatic tool using 13808 (3/16") nose piece on page 296.

Auveco Part No.	Unit Pkg.	Rivet Diameter	Grip Range	Hole & Drill Size	Mandrel Diameter	Head Diameter	Head Thickness	Rivet Length Max
13766	50	3/16	3/64" - 1/4"	.204-.209 (#5)	.103	.445	.088	.890
13767			3/16" - 3/8"					.985
13768			3/8" - 9/16"					1.045
13769	25	1/4	3/64" - 1/4"	.252-.262 (F)	.136	.560	.113	.920
13770			3/16" - 3/8"					1.045

Blind Tacking Rivets

- Steel Rivet: Plated
- Non-Structural: Break mandrel rivets
 - Steel Mandrel: Coated
- Conform to IFI-114 Standards

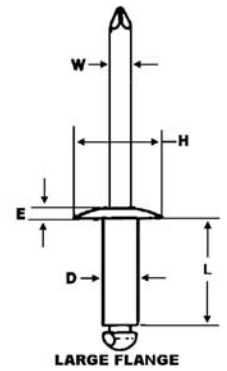
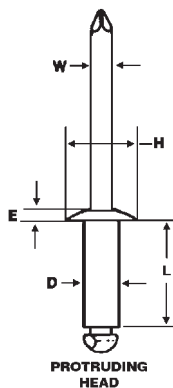

Nom. Rivet Diameter	Hole Size & Drill Number	W Mandrel Diameter	D Rivet Diameter	Protruding Head		Large Flange Head	
				H Head Diameter	E Max.	H Head Diameter	E Max.
1/4"	.257-.261 (F)	.151	.250	.500	.080	.750	.107

Auveco Part No.	Head Style	Rivet Diameter	Grip	Rivet Length L	Unit Pkg.
13796	Large Flange	1/4"	1/2" - 5/8"	13/16"	25

Large Secondary Head Rivets



Rivets that fasten securely into thick and thin materials. Will pull soft or brittle materials. Can be used in an oversized hole.

Auveco Part No.	Head (Flange) Type & Diameter	Rivet Diameter	Grip Range	Rivet Length Excluding Flange	Unit Pkg.
Aluminum Rivet & Mandrel					
17471*	Dome 5/16"	1/8"	5/64"-3/8"	31/32"	25
19062	Dome 5/16"	5/32"	0-1/4"	23/32"	25

* Not a Split Type

Monobolt® Fastening System

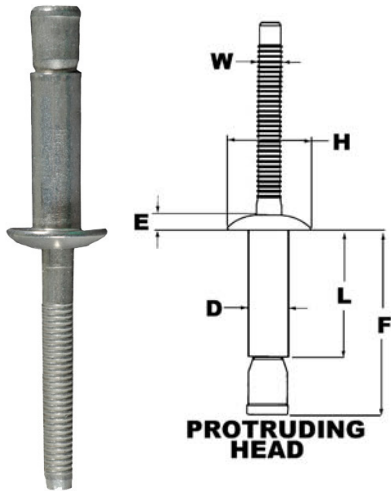

Nom. Rivet Diameter	Hole Size & Drill Number	W Mandrel Diameter	D Rivet Diameter	Protruding Head	
				H Head Diameter	E Head Max.
3/16	.191-.201 (#11)	.118	.187	.390	.070
1/4	.261-.272(G)	.157	.257	.515	.100

Typical Rivet Shear and Tensile Strength (lbs) and Mandrel push-out when installed in Nominal Grip.

Rivet Diameter	Aluminum Rivet & Mandrel			Steel Rivet & Mandrel		
	Shear	Tensile	Mandrel Push-out	Shear	Tensile	Mandrel Push-out
3/16	625	500	50	1300	1000	100
1/4	1300	890	100	2400	2150	250

Auveco Part No.	Diameter	Grip	DIM "L"	DIM "F"	Head Style	Material	Unit Pkg.
12080	3/16"	.062/.270	.406	.748	Protruding	Steel-Zinc Plated	25
12088	3/16"	.062/.270	.406	.748	Protruding	Steel-Zinc Plated	100
12081	3/16"	.214/.420	.531	.882	Protruding	Steel-Zinc Plated	25
12089	3/16"	.214/.420	.531	.882	Protruding	Steel-Zinc Plated	100
12084	1/4"	.080/.375	.550	.971	Protruding	Steel-Zinc Plated	25
12092	1/4"	.080/.375	.550	.971	Protruding	Steel-Zinc Plated	100
12085	1/4"	.350/.625	.855	1.123	Protruding	Steel-Zinc Plated	25
12093	1/4"	.350/.625	.855	1.123	Protruding	Steel-Zinc Plated	100
12086	1/4"	.080/.375	.550	.961	Protruding	Aluminum	25
12094	1/4"	.080/.375	.550	.961	Protruding	Aluminum	100
13773	1/4"	.350/.625	.810	1.174	Protruding	Aluminum	25
13774	1/4"	.350/.625	.810	1.174	Protruding	Aluminum	100

The System

Blind Installation: The single side installation feature of the Auveco Monobolt System allows one operator to produce high quality structural joints in seconds. Use of the Monobolt power tool does not require special skill or training, because the tool completely controls the installation cycle.

Multi-Grip: One size Monobolt fastener will function effectively in a wide range of material thicknesses (Example: .080" to .375"). This versatility decreases the potential for production errors and reduces fastener inventory requirements.

Uniform Clamping Action: Monobolt fasteners are engineered to draw materials together by developing positive clamping action.



Its Advantages

Structural Fastening: An installed Monobolt fastener yields high shear and tensile values. Conventional fasteners can be replaced by Monobolt without compromising structural requirements.

Positive Stem Retention: At the completion of the installation cycle, the stem is mechanically locked into the Monobolt shell, creating a vibration-proof joint of assured structural quality.

Flush Break Stem: Within the specific grip range for each size, Monobolt fastener, the stem is designed to break flush with the low profile head. Secondary finishing operations, such as grinding or milling, are not necessary to achieve good product appearance.

Complete Hole Fill: During installation, the Monobolt shell expands into 360° contact with the walls of the parent material. This feature, in conjunction with positive stem retention, produces weather resistant joints.

Quiet, Safe Installation: The Monobolt System, operating at 85db ("A" Weighted), complies with OSHA regulation governing plant noise levels and operator safety

How it Works



1. The Monobolt fastener is loaded into the nose of the placing tool and inserted in a prepared hole. As the tool is actuated, the pulling jaws grip the Monobolt stem.



2. An axial pull draws the stem through the shell, expanding it radially. During this phase, the hole is completely filled and work pieces are drawn together.



3. When the stem reaches a pre-determined position within the Monobolt shell, it separates flush with the head profile regardless of work piece thickness. Simultaneously, the stem section remaining in the shell is mechanically locked in place by the Monobolt tool.

Interlock® Dome Head High Strength Rivets



High strength Interlock® rivets feature a positive mechanical locking system that provides superior holding power. This system also guarantees 100% mandrel retention that's visually verifiable. Can be set with Auveco Rivet Gun 11817.

Auveco Part No.	Rivet Diameter	Grip Range	Rivet Body Length	Head Diameter	Unit Pkg.	Conversion			
						Interlock®	Cherry Monobolt	Avdel Monobolt	Huck Magna-lock
Aluminum Rivet & Mandrel									
17421	3/16"	1/16" - 17/64"	13/32"	3/8"	25	AD6270UG	BAPV-64	2774-0613	MGLP-B6-4
17422	3/16"	1/16" - 7/16"	9/16"	3/8"	25	AD6437UGX		2774-0617	MGLP-B6-E
17423	1/4"	5/64" - 3/8"	9/16"	1/2"	25	AD8375UG	BAPV-86	2774-0817	MGLP-B8-6
17424	1/4"	5/64" - 5/8"	13/16"	1/2"	15	AD8625UGX		2774-0824	MGLP-B8-E
Steel Rivet & Mandrel									
17425	3/16"	1/16" - 17/64"	13/32"	3/8"	25	SD6270UG	SSPV-64	2771-0613	MGLP-R6-4
17427	1/4"	5/64" - 3/8"	9/16"	1/2"	25	SD8375UG	SSPV-86	2771-0817	MGLP-R8-6
17428	1/4"	5/64" - 5/8"	13/16"	1/2"	15	SD8625UGX		2771-0824	MGLP-R8-E
Stainless Steel Rivet & Mandrel									
17429	3/16"	1/16" - 17/64"	13/32"	3/8"	10	SSD6270UG	CCPV64	2711-0613	MGLP-U6-4



Closed - End Rivets

Can be set with Auveco Rivet Gun 7915

Auveco Part No.	Head (Flange) Type	Head Diameter	Rivet Diameter	Grip Range	Rivet Length Excluding Flange	Unit Pkg.
Black Aluminum Rivet & Mandrel						
17408	Dome	15/64"	1/8"	13/64" - 9/32"	15/32"	50
17410	Dome	3/8"	3/16"	3/8" - 1/2"	11/16"	25
Aluminum Rivet & Mandrel						
17419	Dome	3/8"	3/16"	1/16" - 1/8"	11/32"	50
17420	Dome	3/8"	3/16"	1/8" - 1/4"	15/32"	50
Aluminum Rivet & Steel Mandrel						
17411	Dome	15/64"	1/8"	1/16" - 1/8"	5/16"	50
19065	Countersunk	5/16"	5/32"	1/8" - 3/16"	13/32"	100
17415	Dome	3/8"	3/16"	1/8" - 1/4"	15/32"	50
17416	Dome	3/8"	3/16"	1/4" - 3/8"	19/32"	50

"PEEL - TYPE" SPECIALTY RIVETS

Use 11817 Rivet Gun with 11853 Nose Piece (Page 295) to set all 1/4" "Peel-Type" Rivets



19414
(W525170-S417)

"Peel-Type" Rivet
Diameter: 3/16"
Grip: 1/32"-1/4"
Flange Diameter: 1/2"
Aluminum Rivet (Black) & Steel Mandrel (Zinc)
Side Door Lock Attachment
Mercury Villager 1995 - On

UNIT PACKAGE: 25



11620
(GM: 9436175;
Ford: 385189-S100;
Chry: 6031115)

"Peel-Type" Rivet
Diameter: 1/4"
Grip: 1/32" - 9/64"
Flange Diameter: 1/2"
Aluminum Rivet & Steel Mandrel
Window Regulators
GM, Ford & Chrysler 1971 - On

UNIT PACKAGE: 25

16837

Same as 11620 except for unit package quantity

UNIT PACKAGE: 50

Sec. 14**“PEEL - TYPE” SPECIALTY RIVETS**

Use 11817 Rivet Gun with 11853 Nose Piece
(Page 295) to set all 1/4” “Peel-Type” Rivets



19110
(W525172-S)

“Peel-Type” Rivet
Diameter: 1/4”
Grip: 1/32”-7/32”
Flange Diameter: 1/2”
Aluminum Rivet & Steel Mandrel (Zinc)
Glass, Regulator Assembly
& Remote Latch Assembly
Ford Mustang & Lincoln Continental 1994 - On

UNIT PACKAGE: 25



15684
(20713843)

“Peel-Type” Rivet
Diameter: 1/4”
Grip: 7/64” - 11/64”
Flange Diameter: 1/2”
Recess under Head
Aluminum Rivet & Steel Mandrel
Used on Window Regulators
& Door Lock Assemblies
GM A & J Cars

UNIT PACKAGE: 25



19461
(W525172-S417)

“Peel-Type” Rivet
Diameter: 1/4”
Grip: 1/32”-7/32”
Flange Diameter: 1/2”
Aluminum Rivet (Black) & Steel Mandrel (Zinc)
Outside Door Handle
Ford Crown Victoria, Econoline, Explorer,
Grand Marquis, Ranger, Sable,
Taurus & Windstar 1995 - On

UNIT PACKAGE: 15



12655
(GM: 9437486;
Chry: 6032926)

“Peel-Type” Rivet
Diameter: 1/4”
Grip: 9/64” - 3/16”
Flange Diameter: 1/2”
Aluminum Rivet & Steel Mandrel
Window Regulators
GM 1981 - On

UNIT PACKAGE: 25

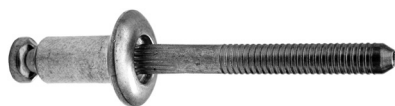

11852
(Ford: 388047-S100;
GM: 14078435)

“Peel-Type” Rivet
Diameter: 1/4”
Grip: 5/64” - 7/64”
Flange Diameter: 1/2”
Recess under Head
Aluminum Rivet & Steel Mandrel
Attaches Outside Door Handle
Ford 1978 - On
Heat Shield Attachment
GM

UNIT PACKAGE: 25



14486
(GM: 9437486;
Chry: 6032926)

“Peel-Type” Rivet
Diameter: 1/4”
Grip: 9/64” - 3/16”
Flange Diameter: 1/2”
Aluminum Rivet & Steel Mandrel
Used on Window Regulators,
Quarter Vent Handle Assemblies &
Electrical Door Lock Linkage
GM & Chrysler 1981 - On

UNIT PACKAGE: 25



12653
(388047-S102)

“Peel-Type” Rivet
Diameter: 1/4”
Grip: 3/32”-1/8”
Flange Diameter: 1/2”
Aluminum Rivet (Black) & Steel Mandrel
Door Handle Assembly
Ford 1981 - On

UNIT PACKAGE: 25



20402
(9437643)

“Peel-Type” Rivet
Diameter : 1/4”
Grip: 3/16” - 1/4”
Flange Diameter: 1/2”
Aluminum Rivet & Steel Mandrel (Zinc)
Window Regulator
Saturn 1993 - On

UNIT PACKAGE: 25

"PEEL - TYPE" SPECIALTY RIVETS

Sec. 14

Use 11817 Rivet Gun with 11853 Nose Piece
(Page 295) to set all 1/4" "Peel-Type" Rivets

11621

(Ford: 385323-S100; Chry: 6031091; GM: 9437938)



"Peel-Type" Rivet
Diameter: 1/4"
Grip: 33/64" - 19/32"
Flange Diameter: 1/2"
Aluminum Rivet & Steel Mandrel
Window Regulator
GM, Ford & Chrysler 1976 - On

UNIT PACKAGE: 10

16838

Same as 11621 except for unit package quantity

UNIT PACKAGE: 25

12658

(GM: 12338153, 20184399; Ford: 389268-S100)



"Peel-Type" Rivet
Diameter: 1/4"
Grip: 11/16" - 3/4"
Flange Diameter: 1/2"
Aluminum Rivet & Steel Mandrel
Window Regulator
GM & Ford 1979 - On

UNIT PACKAGE: 25

18396

(N808594-S100)
Zinc & Yellow



"Peel-Type" Rivet
Diameter: 1/4"
Grip: 1/8"-5/16"
Flange Diameter: 5/8"
Aluminum Rivet & Steel Mandrel
Door Lock Actuator
Ford

UNIT PACKAGE: 25

19420

(W525174S)



"Peel-Type" Rivet
Diameter: 1/4"
Grip: 13/64"-13/32"
Flange Diameter: 5/8"
Aluminum Rivet & Steel Mandrel (Zinc)
Door Handle
Ford Ranger 1997 - On

UNIT PACKAGE: 25

19456

(W525175-S)



"Peel-Type" Rivet
Diameter: 1/4"
Grip: 25/64" - 21/32"
Flange Diameter: 5/8"
Aluminum Rivet & Steel Mandrel (Zinc)
Front Door Window
Ford Continental, Crown Victoria, Explorer, Grand
Marquis, Mark VIII, Mustang, Ranger, Sable, Taurus,
Town Car & Windstar 1996 - On

UNIT PACKAGE: 15

18167

(Ford: N804193-S100;
GM: 9441592, 15672713)

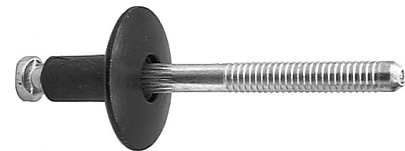

"Peel-Type" Rivet
Diameter: 1/4"
Grip: 3/32"-9/64"
Flange Diameter: 3/4"
Aluminum Rivet (Black) & Steel Mandrel
Front Door Handle & Door Lock Actuator
Tempo, Topaz, T-Bird & Cougar 1984 - On
Rocker Panel Moulding
Chevrolet Beretta & Corsica 1996 - 92

UNIT PACKAGE: 25

19458

(N808689-S417)



"Peel-Type" Rivet
Diameter: 1/4"
Grip: 1/8"-21/64"
Flange Diameter: 3/4"
Aluminum Rivet (Black) & Aluminum Mandrel
Door Lock Actuator
Ford Continental, Crown Victoria,
F Series Truck, Grand Marquis, Mark VII, Mustang,
Ranger, Sable, Taurus, Town Car & Windstar 1995 - On

UNIT PACKAGE: 10



10658

Diameter: 3/32"
Grip: 1/8"-1/4"
Flange Diameter: 3/16"
Aluminum Rivet & Mandrel

Replaces welded studs on body panels.

UNIT PACKAGE: 100



18499

Diameter: 1/8"
Grip: 1/8"-3/16"
Flange Diameter: 3/16"
Aluminum Rivet & Mandrel
Trim Moulding Attachment

UNIT PACKAGE: 100



18500

Diameter: 1/8"
Grip: 3/16"-1/4"
Flange Diameter: 3/16"
Aluminum Rivet & Mandrel
Trim Moulding Attachment

UNIT PACKAGE: 100



11104

(Ford: 383229-S)

Diameter: 1/8"
Grip: 3/16"-1/4"
Flange Diameter: 3/16"

Stainless Steel Rivet & Steel Mandrel

Replaces welded studs on body panels.

Use Auveco Rivet Gun 7915 & Nose Piece 7981

UNIT PACKAGE: 100

11105

Same as 11104 except for unit package quantity

UNIT PACKAGE: 500

11106

Same as 11104 except for unit package quantity

UNIT PACKAGE: 1000



7981

Rivet Gun Nose Piece
**Used to set Auveco Rivet 11104
with Rivet Gun 7915**

UNIT PACKAGE: 1



20788

(90269-04051,
90269-A0006)

Diameter: 1/8" (3.2mm)
Grip: 3/64" - 1/8" (1.2mm - 3.4mm)
Flange Diameter: 15/64" (6mm)
Aluminum Rivet with Plastic Cap
Steel Mandrel

Lexus 1998 - On

UNIT PACKAGE: 10



17408

(N803933-S101)

Diameter: 1/8"
Grip: 13/64"-9/32"
Flange Diameter: 15/64"
Closed End
Black Aluminum Rivet & Mandrel
Luggage Rack
Ford

UNIT PACKAGE: 50



17469

(375936-S)

Diameter: 1/8"
Grip: 1/32"-1/8"
Flange Diameter: 1/4"
Stainless Steel Rivet & Mandrel
Attaches Body Side Mouldings
Sets flush, does not leave a raised stud

UNIT PACKAGE: 100



21418

(6508540-AA)

Diameter: 1/8"
Grip: 1/32" - 3/16"
Flange Diameter: 1/4"
Black Aluminum Rivet & Steel Mandrel (Zinc)
Chrysler General Purpose

UNIT PACKAGE: 25



18303

Diameter: 1/8"
Grip: 1/16"-1/8"
Flange Diameter: 1/4"
Aluminum Rivet (Black) & Aluminum Mandrel
Attachment of Rear Window Trim Moulding
Ford Explorer 1990-On

UNIT PACKAGE: 50



17470

(378527)

Diameter: 1/8"
Grip: 1/8"-3/16"
Flange Diameter: 1/4"
Aluminum Rivet & Mandrel
Attaches Climate Controls
Ford

UNIT PACKAGE: 50



17467

(375203S)

Diameter: 1/8"
Grip: 1/8"-3/16"
Flange Diameter: 1/4"
Stainless Steel Rivet & Steel Mandrel
Attaches Body Side Moulding Retainer
Sets flush, does not leave a raised stud
Ford

UNIT PACKAGE: 100

SPECIALTY RIVETS

Sec. 14



21114
(11610210)

Diameter: 1/8"
Grip: 5/32" - 5/16"
Flange Diameter: 1/4"
Aluminum Rivet & Mandrel
Rear Bumper Fascia
Chevrolet Equinox 2005 - On

UNIT PACKAGE: 50



19406
(6035414)

Diameter: 1/8"
Grip: 1/16"-1/4"
Flange Diameter: 5/16"
Aluminum Rivet & Steel Mandrel (Zinc)
Cladding to Fender Attachment
Chrysler Concorde, Eagle & Intrepid
1997 - On

UNIT PACKAGE: 50



19202

Diameter: 1/8"
Grip: 3/16"-1/4"
Flange Diameter: 1/4"
Aluminum Rivet (Black) & Aluminum Mandrel
GM & General Purpose

UNIT PACKAGE: 100



12656
(20325696)

Diameter: 1/8"
Grip: 1/8" - 3/16"
Flange Diameter: 5/16"
Aluminum Rivet & Steel Mandrel
Rear Window Gasket Attachment
GM 1981 - On

UNIT PACKAGE: 50



19657
(6034848)
Zinc & Yellow

Diameter: 1/8"
Grip: 1/32"-3/16"
Flange Diameter: 5/16"
Aluminum Rivet & Steel Mandrel
Rocker Panel & Cladding
Chrysler LH Series 1993 - On

UNIT PACKAGE: 50



20628
(90269-04050)

Diameter: 1/8" (3.2mm)
Grip: 5/32" - 5/16" (4mm - 8mm)
Flange Diameter: 5/16" (8mm)
Aluminum Rivet with Plastic Cap
Steel Mandrel
Windshield, Side & Trunk Moulding
Lexus GS300, 400, 430 & SC430
1998 - On

UNIT PACKAGE: 15



20787
(90269-04006)

Diameter: 1/8" (3.2mm)
Grip: 3/64" - 5/32" (1.2mm - 4.0mm)
Flange Diameter: 5/16" (8mm)
Aluminum Rivet with Plastic Cap
Steel Mandrel
Lexus 1998 - On

UNIT PACKAGE: 10



17615
(6032856)

Diameter: 1/8"
Grip: 3/16"-3/8"
Flange Diameter: 5/16"
Aluminum Rivet (Black) & Steel Mandrel
Body Side Moulding
& Universal Applications
Chrysler

UNIT PACKAGE: 50



20627
(90269-04053)

Diameter: 1/8" (3.2mm)
Grip: 3/64" - 3/16" (1mm - 4.8mm)
Flange Diameter: 5/16" (8mm)
Aluminum Rivet (Black) with Plastic Cap
Steel Mandrel (Black)
Mouldings
Toyota Land Cruiser 1998 - On

UNIT PACKAGE: 10



18304

Diameter: 1/8"
Grip: 1/16"-1/8"
Flange Diameter: 3/8"
Aluminum Rivet (Black) & Steel Mandrel
Attachment of Door Glass Moulding
Ford 1993 - On

UNIT PACKAGE: 50



21320
(90269-03064)

Diameter: 3.2mm (1/8")
Grip: 1.6mm-3.2mm (1/16"-1/8")
Flange Diameter: 9.5mm (3/8")
Aluminum Rivet & Mandrel
Black Flange
Rocker Moulding
Lexus ES 300 & Others 2002 - On

UNIT PACKAGE: 15



16834
(N805759-S100)

Diameter: 1/8"
Grip: 1/8"-3/16"
Flange Diameter: 3/8"
Aluminum Rivet (Black) & Aluminum Mandrel
Windshield Side Rail
Ford T-Bird & Mercury Cougar 1989-On

UNIT PACKAGE: 50



16686
(9432552)

Multi-Purpose Rivet
Diameter: 1/8"
Grip: 1/8" - 3/16"
Flange Diameter: 3/8"
Aluminum Rivet & Steel Mandrel
Large Flange
GM 1978-On

UNIT PACKAGE: 100



19419
(N811460-S100)

Diameter: 1/8"
Grip: 1/8"-3/16"
Flange Diameter: 3/8"
Steel Rivet (Black) & Steel Mandrel
Door Moulding
Ford Taurus 1996-On

UNIT PACKAGE: 15



21082
(75547-51021)

Diameter: 1/8" (3.2mm)
Nylon Shoulder Diameter: 1/4" (6.3mm)
Grip: 1/32" - 1/16" (.8mm - 1.5mm)
Flange Diameter: 13/32" (10.3mm)
Aluminum Rivet with Plastic Cap
Steel Mandrel
Windshield
Lexus IS 250, IS 350 & IS F 2006 - On
Toyota 2002 - On

UNIT PACKAGE: 15



21714
(Lexus: 90269-04060)

Specialty Rivet
Diameter: 5/32" (4mm)
Grip: 3/64" - 9/32" (1mm - 7mm)
Flange Diameter: 15/64" (6mm)
Steel Rivet & Mandrel
Lexus GS 300, GS 350, GS 430, GS 450h
& GS 460 2006 - On

UNIT PACKAGE: 25



22089
(GM: 92139150)

Front Bumper & Grille Specialty Rivet
Diameter: 5/32" (4mm)
Grip Range: 11/64" - 11/32" (4.4mm - 8.5mm)
Flange Diameter: 9/32" (7.1mm)
Aluminum Rivet & Stainless Steel Mandrel
Chevrolet Camaro 2012 - On

UNIT PACKAGE: 25



22173
(GM: 11611651)

Zinc & Clear Trivalent
Door & Exterior Trim Specialty Rivet
Diameter: 5/32" (4mm)
Grip Range: 3/64" - 5/32" (1mm - 4mm)
Flange Diameter: 5/16" (8mm)
Steel Rivet & Mandrel
Cadillac ATS, CTS, CTS-V & Escalade,
Chevrolet Avalanche, Camaro & Equinox and
GMC Terrain 2010 - On

UNIT PACKAGE: 50



22332
(Subaru: 905920039;
Toyota: 76879-48010)

Roof, Liftgate & Exterior Trim
Specialty Rivet with Plastic Cap
Rivet Diameter: 4mm (5/32")
Diameter of Plastic Cap: 5mm
Flange Diameter: 8mm (5/16")
Plastic Cap Flange Diameter:
10mm (Top), 12mm (Bottom)
Grip Range: .8mm - 2.4mm (.031" - .094")
Aluminum Rivet, Steel Mandrel
Subaru Forester, Impreza, Legacy,
Outback & XV Crosstrek 2015 - 2009
Toyota Prius 2009 - 2004

UNIT PACKAGE: 10

18461

(Ford: N807620-S100; GM: 10131511)



Split-Type Rivet
 Diameter: 5/32"
 Grip: 3/64"-1/4"
 Flange Diameter: 5/16"
 Aluminum Rivet (Black) & Aluminum Mandrel
 Wheel Openings
 Lincoln 1994-On
 Bumper Cover, Grille & Rocker Moulding
 GM 1997 - On

UNIT PACKAGE: 25

20971

(Mazda: BBM450-355;
 Mercedes-Benz: 003-990-94-97)



Split-Type Rivet
 Diameter: 5/32" (4mm)
 Grip: 3/64" - 9/32" (1mm - 7mm)
 Flange Diameter: 5/16" (8mm)
 Aluminum Rivet & Mandrel
 Mazda 2012 - On
 Mercedes-Benz 2004 - On

UNIT PACKAGE: 25



21113
 (01515-0009U)

Split-Type Rivet
 Diameter: 5/32" (4mm)
 Grip: 3/64" - 9/32" (1mm - 7mm)
 Flange Diameter: 5/16" (8mm)
 Aluminum Rivet (Black) & Aluminum Mandrel
 Bumper
 Nissan Pathfinder 2006 - On

UNIT PACKAGE: 25



20383
 (90084-26002)

Diameter: 5/32" (4mm)
 Grip: 1/16" - 1/4" (1.6mm - 6.3mm)
 Flange Diameter: 5/16" (8mm)
 Aluminum Rivet & Mandrel
 Door Window Moulding
 Toyota Camry 1997 - On

UNIT PACKAGE: 50

16687

(GM: 9432137;
 Chry: 6032138)



Diameter: 5/32"
 Grip: 1/8" - 3/16"
 Flange Diameter: 5/16"
 Aluminum Rivet & Steel Mandrel
 Countersunk Head
 Trunk Lock Swivel Emblem Rivet
 GM 1973-On

UNIT PACKAGE: 25

21864

(Ford: W713819-S900)



Specialty Rivet
 Diameter: 5/32" (4mm)
 Grip: 3/64" - 1/8" (1.2mm - 3.2mm)
 Flange Diameter: 3/8" (9mm)
 Aluminum Rivet (Black) with Plastic Cap
 Steel Mandrel
 Cab & Exterior Trim
 Ford F-150 2014 - 2009

UNIT PACKAGE: 25



20629
 (6036148-AA)

Split-Type Rivet
 Diameter: 5/32"
 Grip: 3/64" - 1/4"
 Flange Diameter: 7/16"
 Aluminum Rivet (Black) & Aluminum Mandrel
 Front Bumper, Trim Panel,
 Instrument Panel & Running Boards
 Chrysler 1999 - On

UNIT PACKAGE: 25



22088
 (GM: 9132667)

Front & Rear Bumper Specialty Rivet
 Diameter: 5/32" (4mm)
 Grip Range: 9/64" - 3/8" (3.6mm - 9.5mm)
 Flange Diameter: 7/16" (11.1mm)
 Aluminum Rivet & Stainless Steel Mandrel
 Buick Regal & Verano; Chevrolet Avalanche, Camaro,
 Cruze, Malibu, Sonic & Volt 2010 - On

UNIT PACKAGE: 25



17468
 (16715497)

Diameter: 5/32"
 Grip: 3/64"-1/4"
 Flange Diameter: 15/32"
 Aluminum Rivet & Steel Mandrel
 Attaches Support Rails to Load Floor
 GM

UNIT PACKAGE: 50



21742
(Toyota: 90269-06054)

Specialty Rivet
Diameter: 5/32" (4mm)
Grip: 3/64" - 3/8" (1mm - 9.5mm)
Flange Diameter: 15/32" (12mm)
Aluminum Rivet (Black) & Steel Mandrel (Black)
European Toyota and Universal

UNIT PACKAGE: 25



21715
(Toyota: 90269-04047)

Specialty Rivet
Diameter: 5/32" (4mm)
Grip: 3/64" - 15/32" (1mm - 12mm)
Flange Diameter: 15/32" (12mm)
Aluminum Rivet & Steel Mandrel (Black)
Black Flange
Toyota RAV4 & 4Runner 1996 - On

UNIT PACKAGE: 25



19376
(979878-6)

Diameter: 5/32" (4mm)
Grip: 1/8" - 11/32" (3mm - 8.5mm)
Flange Diameter: 15/32" (12mm)
Aluminum Rivet (Black Polyethylene Coating)
Aluminum Mandrel
Bumper & Wheel Housing
Volvo 1993-On

UNIT PACKAGE: 15



17006
(N900-845-01)

Diameter: 5/32"
Grip: 1/4" - 3/8"
Flange Diameter: 15/32"
Aluminum Rivet (Black) & Steel Mandrel
Wheel Opening Moulding Attachment
Jetta, Rabbit & Golf

UNIT PACKAGE: 25



15187
(N804583S)
Black Nylon

Cowl Vent Grille
Retainer Rivet
Diameter: 5/32" (4mm)
Grip: 15/64" - 13/32" (6mm - 10.5mm)
Flange Size: 11/32" x 5/8" (8.5mm x 15.5mm)
Ford Aerostar 1986-On

UNIT PACKAGE: 25



18169
(15956062)

Diameter: 3/16"
Grip: 1/8" - 1/4"
Flange Diameter: 11/32"
Aluminum Rivet & Steel Mandrel
Door Assembly
GM Trucks C, K Models 1994-On

UNIT PACKAGE: 25



19514
(10125439, 10201332)

Split-Type Rivet
Diameter: 3/16"
Grip: 3/64" - 15/64"
Flange Diameter: 3/8"
Aluminum Rivet (Black) & Aluminum Mandrel
Door Actuator, Door, Body & Fender
Moulding and Dash Panel Insulation
Buick Regal, Chevrolet Lumina APV, K & T Trucks,
Olds Silhouette and Pontiac Trans Sport 1990 - On

UNIT PACKAGE: 25



16864
(10125439)

Split-Type Rivet
Diameter: 3/16"
Grip: 3/64" - 11/32"
Flange Diameter: 3/8"
Aluminum Rivet (Black) & Aluminum Mandrel
Moulding Attachment
APV Vans 1990 - On

UNIT PACKAGE: 25



22333
(Ford: W717984-S417)

Cab & Exterior Trim Countersunk
Closed End Specialty Rivet
Diameter: 4.8mm (3/16")
Flange Diameter: 9.5mm (3/8")
Grip Range: 1.6mm - 3.18mm (.063" - .125")
Black Aluminum Rivet & Mandrel
Ford F-150 2015 - On

UNIT PACKAGE: 15



20830
(N-904-374-01)

Diameter: 3/16" (4.8mm)
Grip: 1/16" - 1/4" (1.6mm - 6.4mm)
Flange Diameter: 3/8" (10mm)
Aluminum Rivet & Steel Mandrel
Inner Fender
Volkswagen

UNIT PACKAGE: 25



18912
(22585836, 22641917)

Diameter: 3/16"
Grip: 1/16" - 17/64"
Flange Diameter: 3/8"
Steel Rivet (Black) & Steel Mandrel (Zinc)
Rear Side Door Outside Handle Attachment
Cadillac DeVille & Seville, Chevrolet Cavalier and
Pontiac Sunfire 1994 - On

UNIT PACKAGE: 25



17410
(390428-S100)

Diameter: 3/16"
Grip: 3/8" - 1/2"
Flange Diameter: 3/8"
Closed End
Black Aluminum Rivet & Mandrel
Luggage Rack
Ford

UNIT PACKAGE: 25



19459
(384432-S)

Diameter: 3/16"
Grip: 1/16" - 1/8"
Flange Diameter: 3/8"
Aluminum Rivet & Steel Mandrel
Outer Moulding
Ford F Series & Villager
and Nissan Quest 1995 - On

UNIT PACKAGE: 25



19515
(15704030)

Diameter: 3/16"
Grip: 3/16" - 3/8"
Flange Diameter: 25/64"
Aluminum Rivet (Black)
Steel Mandrel (Zinc & Yellow)
Body Moulding, Bumper Fascia,
Hood Prop Rod and Window Hinge
Chev. Beretta, Camaro, Corsica &
Trucks, Olds Silhouette, Pontiac Firebird,
Grand Am and Trans Sport 1992 - On

UNIT PACKAGE: 25



21184
(003-990-24-97)

Door Handle, Air Bag, Rocker Moulding &
Window Regulator Rivet
Diameter: 3/16" (4.8mm)
Grip: 1/16" - 1/8" (1.6mm - 3.2mm)
Flange Diameter: 3/8" (9.5mm)
Steel Rivet & Mandrel
Mercedes-Benz 1998 - On

UNIT PACKAGE: 100



17121
(GM: 25618730;
Ford: N805592-S100)

Split-Type Rivet
Diameter: 3/16"
Grip: 5/64" - 15/64"
Flange Diameter: 7/16"
Aluminum Rivet (Black) & Aluminum Mandrel
Wheel House Moulding & General Purpose

UNIT PACKAGE: 25



21439

Diameter: M4.8 (3/16")
Grip: 1.5mm - 6mm (1/16" - 15/64")
Flange Diameter: 9mm (3/8")
Steel Rivet & Mandrel
Cadillac CTS; Chevrolet Colorado &
Equinox and GMC Canyon & Terrain 2004 - On

UNIT PACKAGE: 50



18927
(22569178,
22579423)



18329
(3828472)

Diameter: 3/16"
Grip: 1/4" - 3/8"
Flange Diameter: 3/8"
Aluminum Rivet (Black) & Aluminum Mandrel
Attachment of Front Fender Lower Rocker Moulding
Chevrolet Astro & GMC Safari Mini-Vans 1995 - On

UNIT PACKAGE: 50

Split-Type Rivet
Diameter: 3/16"
Grip: 5/16" - 7/16"
Flange Diameter: 7/16"
Aluminum Rivet & Steel Mandrel (Zinc)
Front & Rear Door Window Sash Attachment
Buick Skylark, Chevrolet Cavalier,
Olds Achieva & Pontiac Grand Am 1992-On

UNIT PACKAGE: 25



18244
(GM: 15614774)

Split-Type Rivet
Diameter: 3/16"
Grip: 3/16"-3/8"
Flange Diameter: 29/64"
Aluminum Rivet (Black) & Aluminum Mandrel
For Camper Style Mirrors on GM Trucks

UNIT PACKAGE: 10



21713
(Toyota: 90269-05034, 90269-05056)

Specialty Rivet
Diameter: 3/16" (5mm)
Grip: 3/64" - 15/32" (1mm - 12mm)
Flange Diameter: 1/2" (13mm)
Aluminum Rivet with Plastic Cap
Steel Mandrel
Lexus IS 300 and Toyota Celica, Corolla, Matrix, Prius, RAV4, Tercel & Yaris 2000 - On

UNIT PACKAGE: 25



21046
(90269-05065)

Diameter: 3/16" (5mm)
Grip: 5/32" - 9/32" (4mm - 7mm)
Flange Diameter: 1/2" (13mm)
Aluminum Rivet with Plastic Cap
Steel Mandrel
Bumpers & General Purpose
Lexus 2004 - On

UNIT PACKAGE: 10



17641
(9442361, 25609048)

Diameter: 3/16"
Grip: 3/64"-13/64"
Flange Diameter: 9/16"
Aluminum Rivet (Black) & Steel Mandrel (Zinc)
Used in place of screws when attaching new Catalytic Converter Heat Shield
Buick LeSabre & Roadmaster, Cadillac Brougham and Oldsmobile 98 & 88 1986 - On

UNIT PACKAGE: 25



18749
(9439559, 21021319)

Diameter: 3/16"
Grip: 1/16"-1/4"
Flange Diameter: 9/16"
Aluminum Rivet (Black) & Steel Mandrel
Rocker Panel Cover
GM Saturn 1991 - On

UNIT PACKAGE: 50



20834
(90269-06013)

Diameter: 3/16" (4.8mm)
Grip: 1/16" - 1/4" (1.6mm - 6.35mm)
Flange Diameter: 9/16" (14mm)
Aluminum Rivet with Plastic Cap
Steel Mandrel
Gas Filler Door
Toyota Camry & Lexus IS300 2001 - On

UNIT PACKAGE: 15



20626
(90269-05054)

Diameter: 3/16" (5mm)
Grip: 1/8" - 5/16" (3mm - 8mm)
Flange Diameter: 9/16" (14mm)
Aluminum Rivet with Plastic Cap
Steel Mandrel
Windshield Side Moulding & Gas Filler Cap
Toyota Camry & Sienna 1997 - On

UNIT PACKAGE: 10

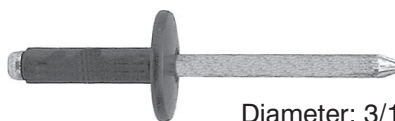

14127
(388664-S100)

Diameter: 3/16"
Grip: 3/8"-1/2"
Flange Diameter: 9/16"
Aluminum Rivet (Black) & Aluminum Mandrel
Fascia & Bumper
Ford 1982 - On

UNIT PACKAGE: 25



20740
(GM: 22638717; Honda: 90671-SDA-A01)

Split-Type Rivet
Diameter: 3/16" (4.8mm)
Grip Range: 3/64"- 23/64" (1mm - 9mm)
Flange Diameter: 5/8" (16mm)
Aluminum Rivet & Mandrel
Bumper Fascia & General Purpose
GM 1987 - On
Honda Civic 2016 - On

UNIT PACKAGE: 25

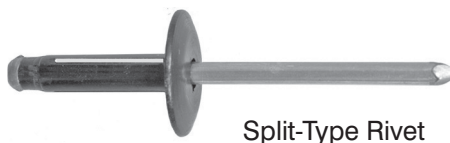

20741
(11516807)

Split-Type Rivet
Diameter: 3/16" (4.8mm)
Grip: 3/64" - 23/64" (1mm-9mm)
Flange Diameter: 5/8" (16mm)
Aluminum Rivet (Black) & Aluminum Mandrel
Bumper Fascia & General Purpose
GM 1990 - On

UNIT PACKAGE: 25



21799
 Split-Type Rivet
 Diameter: 3/16"
 Grip Range: 7/64" - 3/8"
 Flange Diameter: 5/8"
 Aluminum Rivet & Mandrel
 General Purpose
 UNIT PACKAGE: 15



19460
 (385974-S)
 Diameter: 3/16"
 Grip: 3/16"-1/4"
 Flange Diameter: 5/8"
 Aluminum Rivet & Steel Mandrel
 General Purpose
 Ford Econoline & Windstar 1995 - On
 UNIT PACKAGE: 50



22264
 (Ford:W714004-S900)
 Liftgate, Exterior Trim & Quarter Panel Specialty Rivet
 Diameter: 3/16" (4.8mm)
 Grip Range: 3/16" - 3/8" (4.75mm - 9.53mm)
 Flange Diameter: 7/16" (11mm)
 Black Aluminum Rivet & Aluminum Mandrel
 Ford Explorer & Flex 2009 - On
 UNIT PACKAGE: 25



18168
 (9433186)
 Diameter: 3/16"
 Grip 1/4"-3/8"
 Flange Diameter: 5/8"
 Steel Rivet (Zinc) & Steel Mandrel
 Front & Rear Bumper
 GM Saturn 1991 - On
 UNIT PACKAGE: 50



12657
 (9439719)
 Diameter: 3/16"
 Grip: 1/4"-3/8"
 Flange Diameter: 5/8"
 Steel Rivet (Black) & Steel Mandrel
 Attaches Fascia to Underside Bumper
 GM 1981 - On
 UNIT PACKAGE: 50



16940
 (GM: 2085119, 3533539, 3540161;
 Not Supplied by Chrysler O.E.M.)
 Diameter: 3/16"
 Grip: 1/2" - 5/8"
 Flange Diameter: 5/8"
 Aluminum Rivet & Mandrel
 Glass Stop/Roller Rivet
 Chrysler
 Front Bumper Fascia Lower Deflector
 Cadillac 1993 - 87
 UNIT PACKAGE: 25



17466
 (N905150-S)
 Diameter: 3/16"
 Grip: 1/2"-5/8"
 Flange Diameter: 5/8"
 Aluminum Rivet & Steel Mandrel
 Attaches License Plate Bracket
 Ford
 UNIT PACKAGE: 25



18935
 (10160960)
 Diameter: 3/16"
 Grip: 1/2" - 25/32"
 Flange Diameter: 5/8"
 Aluminum Rivet & Steel Mandrel (Zinc)
 Liftgate Strut Gate Side Bracket
 Lumina APV, Silhouette & Trans Sport 1992 - On
 UNIT PACKAGE: 25



17977
 (Not Supplied by O.E.M.)
 Diameter: 3/16"
 Grip: 5/8"-3/4"
 Flange Diameter: 5/8"
 Aluminum Rivet & Mandrel
 Glass Stop/Roller Rivet
 Chrysler
 UNIT PACKAGE: 25



19111
 (N807168-S)
 Diameter: 3/16"
 Grip: 11/16"-13/16"
 Flange Diameter: 3/4"
 Aluminum Rivet & Mandrel
 Grille & Bumper
 Ford Windstar 1995 - On
 UNIT PACKAGE: 25

22122

(Mercedes: 003-990-35-97)



Specialty Rivet
Diameter: 6.3mm (1/4")
Grip Range: 1.0mm - 8.5mm (.039" - .335")
Flange Diameter: 11mm (7/16")
Aluminum Rivet & Steel Mandrel
Mercedes 2012 - 1990

UNIT PACKAGE: 15

21124

(11610383)



Diameter: 1/4"
Grip: 1/64" - 1/8"
Flange Outer Diameter: 1/2"
Steel Rivet (Zinc) & Steel Mandrel
Step Bumper
GM Silverado & Sierra Pick-Ups 2007 - On

UNIT PACKAGE: 25

22266

(GM: 11561334)
Zinc



Rear Compartment, Rocker & Wheelhouse Specialty Rivet
Diameter: 1/4" (6.3mm)
Grip Range: .059" - .138" (1.48mm - 3.50mm)
Flange Diameter: 1/2" (12.70mm)
Steel Rivet & Mandrel
Various GM Models, Cadillac CTS & SRX 2015 - 2009
Cadillac CT6 2016 - On

UNIT PACKAGE: 15

HAVE YOU VISITED US ONLINE?

Auveco's website has been completely renovated. Our new design is user friendly with easy navigation and ordering.

Product is searchable by car make, OEM number and category, as well as, several attribute drop downs within individual categories. All product also has stock availability listed.

Make sure to head over to www.auveco.com to receive up to date information on all our products.

22067

(Ford: W707638-S900C)
Zinc



Cab, Rear Body, Floor, Door, Box, Wheel House & Back Panel Specialty Rivet
Diameter: 1/4" (6.3mm)
Grip: .060"-.138" (1.5mm - 3.5mm)
Flange Diameter: 1/2" (13mm)
Steel Rivet & Mandrel
Ford F-150 Trucks with Aluminum Body 2015 - On

UNIT PACKAGE: 10

18889

(22643056)
Zinc & Yellow Dichromate



Diameter: 1/4"
Grip: 1/16" - 5/32"
Flange Diameter: 1/2"
Steel Rivet & Mandrel
Door Window Regulator
Buick Skylark, Chevrolet Cavalier, Olds Achieva & Aurora, and Pontiac Grand Am & Sunfire 1995-On

UNIT PACKAGE: 25

21315

(90269-A0005,
90269-06017)



Diameter: 1/4" (6.3mm)
Grip: 1/16" - 3/16" (1.6mm - 4.8mm)
Flange Diameter: 1/2" (13mm)
Aluminum Rivet (Black) & Steel Mandrel
Fuel Door & General Purpose
Toyota and Lexus 2000 - On
Scion 2005 - On

UNIT PACKAGE: 10

18938

(2024778)
Zinc



Diameter: 1/4"
Grip: 1/16"-1/4"
Flange Diameter: 1/2"
Steel Rivet & Mandrel
Front Side Door Window Regulator
Chevrolet Lumina APV, Olds Silhouette & Pontiac Trans Sport 1990 - On

UNIT PACKAGE: 25

16939

(10157547)

Yellow Dichromate Coated



Diameter: 1/4"
Grip: 5/64" - 3/8"
Flange Diameter: 1/2"
Aluminum Rivet & Steel Mandrel
Front Door Window Regulator
GM APV Vans 1990 - On

UNIT PACKAGE: 10

18810

(6033688)

Zinc & Yellow



Diameter: 1/4"
Grip: 7/64" - 3/16"
Flange Diameter: 1/2"
Steel Rivet & Mandrel
Glass & Frame Assembly and
Floor Pan Reinforcement Attachment
Dodge Shadow, Plymouth Sundance
& Jeep Cherokee 1991 - On

UNIT PACKAGE: 25

22023

(Ford: W702512-S900C)



Fender, Sill & Radiator Support Specialty Rivet
Diameter: 1/4" (6.3mm)
Grip: .110" - .189" (2.79mm - 4.8mm)
Flange Diameter: 1/2" (13mm)
Steel Rivet & Mandrel
Ford F-150 Trucks with Aluminum Body 2015

UNIT PACKAGE: 10

12654

(372820-S36, S40)



Diameter: 1/4"
Grip: 1/8" - 1/4"
Flange Diameter: 1/2"
Steel Rivet (Zinc & Gold Chrome) & Steel Mandrel
Front Bumper Assembly
Ford 1979 - On

UNIT PACKAGE: 25

22265

(Mercedes: 000-991-59-32)



Front & Rear Door Specialty Rivet
Diameter: 6.3mm (1/4")
Grip Range: 3.5mm - 6.5mm (.138" - .265")
Flange Diameter: 16mm (5/8")
Aluminum Rivet & Steel Mandrel
Mercedes-Benz CLA & GLA Class 2014 - On

UNIT PACKAGE: 15

21286

(Ford: W708777-S900C;

Mercedes: 004-990-16-97)

Zinc



Specialty Rivet
Diameter: 1/4" (6.3mm)
Grip: 3/16" - 17/64" (4.80mm - 6.80mm)
Flange Diameter: 1/2" (13mm)
Steel Rivet & Mandrel
Cab, Radiator, Rail, Floor, Door, Pillar,
Cowl, Box & Back Panel
Ford F-150 Trucks with Aluminum Body 2015 - On
Mercedes Benz 2008 - On

UNIT PACKAGE: 10

22066

(Ford: W702554-S900C)

Zinc



Cab, Floor, Door, Pillar, Box &
Cowl Specialty Rivet
Diameter: 1/4" (6.3mm)
Grip: .268" - .346" (6.8mm - 8.8mm)
Flange Diameter: 1/2" (13mm)
Steel Rivet & Mandrel
Ford F-150 Trucks with
Aluminum Body 2015 - On

UNIT PACKAGE: 10

21245

(W705297-S300)

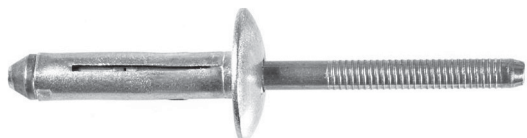

Split-Type Rivet
Diameter: 1/4"
Grip Range: 3/16" - 3/8"
Flange Diameter: 11/16"
Aluminum Rivet & Mandrel
Bumper Cover
Ford Fusion 2009 - On

UNIT PACKAGE: 15

21440

(Not Available from O.E.M.)



Closed End Rivet
Diameter: 1/4"
Grip Range: 1/4" - 3/8"
Flange Diameter: 1/2"
Aluminum Rivet & Steel Mandrel
General Purpose

UNIT PACKAGE: 25

18170

(10204266)



Diameter: 1/4"
Grip: 3/4"-1"
Flange Diameter: 1/2"
Aluminum Rivet & Mandrel
Trunk Lock Cylinder
Pontiac Firebird 1994 - On

UNIT PACKAGE: 10

19516

(N804851-S100)



Split-Type Rivet
Diameter: 1/4"
Grip: 3/64"-1/4"
Flange Diameter: 9/16"
Aluminum Rivet (Black) & Aluminum Mandrel
Front Bumper
Ford Taurus 1996 - On

UNIT PACKAGE: 15

17639

(Ford: N806830-S100;
Chry: 6035201)



Split-Type Rivet
Diameter: 1/4"
Grip: 3/16"-3/8"
Flange Diameter: 11/16"
Aluminum Rivet & (Black) Aluminum Mandrel
Attachment of Bumper Cover to Bumper &
Front License Plate Bracket to Bumper Cover
Ford 1992 - On
Air Dam to Fascia
Chrysler 1993 - On

UNIT PACKAGE: 15

19263

Same as 17639 except for unit package quantity

UNIT PACKAGE: 25

18331

(N805995-S100,
W701566-S417)



Diameter: 1/4"
Grip: 1/32"-7/32"
Flange Diameter: 3/4"
Aluminum Rivet (Black) & Aluminum Mandrel (Yellow)
Attachment of Power Door Lock Actuator
Mustang & Lincoln Continental 1994-On

UNIT PACKAGE: 10

12652

(388442-S100)



Diameter: 1/4"
Grip: 1/8"-1/4"
Flange Diameter: 3/4"
Steel Rivet (Black) & Steel Mandrel
Bumper Assembly
Escort & Lynx 1981 - On

UNIT PACKAGE: 25

Straight Shank 135° Split Point Black Finish



Auveco Part No.	Unit Pkg.	Size	Dec. Equiv.	Flute Length	Overall Length
13039	5	3/32"	.0938	1-1/4"	2-1/4"
13040	5	7/64"	.1094	1-1/2"	2-5/8"
13041	5	1/8"	.1250	1-5/8"	2-3/4"
13095	5	30	.1285	1-5/8"	2-3/4"
13042	5	9/64"	.1406	1-3/4"	2-7/8"
13043	5	5/32"	.1562	2"	3-1/8"
13044	5	11/64"	.1719	2-1/8"	3-1/4"
13045	5	3/16"	.1875	2-5/16"	3-1/2"
13046	5	13/64"	.2031	2-7/16"	3-5/8"
13047	5	7/32"	.2188	2-1/2"	3-3/4"
13048	5	15/64"	.2344	2-5/8"	3-7/8"
13049	5	1/4"	.2500	2-3/4"	4"
13050	5	17/64"	.2656	2-7/8"	4-1/8"
13051	5	9/32"	.2812	2-15/16"	4-1/4"
13052	5	19/64"	.2969	3-1/16"	4-3/8"
13053	5	5/16"	.3125	3-3/16"	4-1/2"
13054	5	21/64"	.3281	3-5/16"	4-5/8"
13055	5	11/32"	.3438	3-7/16"	4-3/4"
13056	5	23/64"	.3594	3-1/2"	4-7/8"
13057	5	3/8"	.3750	3-5/8"	5"
13058	5	25/64"	.3906	3-3/4"	5-1/8"
13059	5	13/32"	.4062	3-7/8"	5-1/4"
13060	5	27/64"	.4219	3-15/16"	5-3/8"
13061	5	7/16"	.4375	4-1/16"	5-1/2"
13062	5	29/64"	.4531	4-3/16"	5-5/8"
13063	5	15/32"	.4688	4-5/16"	5-3/4"
13064	5	31/64"	.4844	4-3/8"	5-7/8"
13065	3	1/2"	.5000	4-1/2"	6"

Cobalt Steel Spot Weld Drills



Auveco Part No.	Unit Pkg.	Size	Flute Length	Overall Length
20479	3	8mm (5/16")	27mm (1-1/16")	58mm (2-1/4")
20480	3	10mm (3/8")	27mm (1-1/16")	58mm (2-1/4")

High Speed Jobber Length Drill Set Metal Drill Indexes



13136

Jobbers Length Straight Shank
135° Split Point
Sizes 1/16" thru 1/2" by 64th
29 Pieces

UNIT PACKAGE: 1 Set

Screw Machine Length Drills 135° Split Point Straight Shank • Black Finish



Auveco Part No.	Unit Pkg.	Size	Dec. Equiv.	Flute Length	Overall Length
13120	5	1/16"	.0625	5/8"	1-5/8"
13121	5	5/64"	.0781	11/16"	1-11/16"
13124*	5	1/8"	.1250	7/8"	1-7/8"
13128	5	3/16"	.1875	1-1/8"	2-3/16"
13132	5	1/4"	.2500	1-3/8"	2-1/2"
13133	5	5/16"	.3125	1-5/8"	2-13/16"
13134	2	3/8"	.3750	1-13/16"	3-1/8"

* For 1/8" Pop Rivets

12676 Black Finish



Double-End Drill Bit
135° Split Point
Diameter: 1/8" (.125)
Length: 2"

UNIT PACKAGE: 5

AuvecoPak AP448 Retail Merchandiser

AuvecoPak part numbers are the same as standard Auveco part numbers with an “AP” prefix. Thus AP11146 is the AuvecoPak version of 11146.

AP448S (Starter Merchandiser): One package each of 448 part numbers

AP448L (Large Merchandiser): Two packages each of the 224 most popular items and one package each of the other 224 part numbers for a total of 672 packages.



The AuvecoPak merchandisers (AP448S and AP448L) provide 448 of the fastest moving, most popular automotive body hardware and specialty fasteners.

Each of the 7 panels contains 32 part numbers per side.

The AP448S (Starter Merchandiser) consists of one package each of the 448 part numbers. The AP448L (Large Assortment) includes two packages each of the 224 most popular items and one package each of the other 224 part numbers for a total of 672 packages.

Two header signs identify the AP448 as an Auveco merchandiser, along with the phrase automotive body hardware and specialty fasteners. Eye-catching color scheme and graphics make the merchandiser visually appealing and portray the contents of the merchandiser.

Initial set-up is easy. The panels come “pre-dressed” with the AuvecoPaks already in place. Simply position the top and bottom brackets on a gondola or pegboard wall. Insert the panels into the brackets.

An individual panel measures 6-1/2” (wide) x 17-1/2” (front to back) x 44-1/2” (high). Merchandisers (AP448S and AP448L) fit on a gondola with 48” x 48” of pegboard or on any pegboard wall.

A gondola is not included with the AP448S or the AP448L. Auveco customer service reps can recommend a source for gondolas.

AuvecoPak packages feature, contemporary graphics with all the necessary application and descriptive information in trilingual verbiage (English, Spanish and French-Canadian).

Re-ordering is a breeze, the AuvecoPak part number and UPC-A bar code are on the panel back-up boards beneath each hook. Restocking the merchandiser is also quick and easy with the AuvecoPak packages’ locator codes identifying their specific location on the panels.



Refer to contents listing for each panel on following pages

AuvecoPak AP448 Retail Merchandiser Contents

Sec. 15

AuvecoPak part numbers are the same as standard Auveco part numbers with an "AP" prefix. Thus AP11146 is the AuvecoPak version of 11146. *Photos not actual size.*

Panel T1 Retainers

AP10832	AP10831	AP11146	AP17664
AP20192	AP11120	AP14921	AP14021
AP11612	AP11721	AP15367	AP17612
AP11679	AP19837	AP16818	AP12731
AP18301	AP14032	AP14036	AP12766
AP15543	AP20366	AP20316	AP11351
AP20362	AP12137	AP15481	AP15480
AP12571	AP12909	AP15479	AP15998



Panel T2 Retainers & Trim Panel Fasteners

AP15457	AP12759	AP15456	AP11130
AP17649	AP12565	AP13470	AP18848
AP11671	AP15970	AP12992	AP19386
AP18915	AP11797	AP18930	AP17075
AP19270	AP16695	AP15461	AP11678
AP11672	AP13461	AP10621	AP12737
AP11796	AP808	AP11863	AP2310
AP2309	AP12134	AP19682	AP18114



Panel U1 Retaining Clips & Retainers

AP19114	AP14356	AP19729	AP20543
AP14355	AP14291	AP18297	AP14736
AP14737	AP19113	AP18842	AP17975
AP19655	AP14738	AP17004	AP14163
AP17339	AP19171	AP18877	AP18033
AP14328	AP10744	AP8853	AP14016
AP17162	AP16782	AP16784	AP11705
AP11699	AP20248	AP11706	AP18353



Panel U2 Push-Type Retainers

AP12567	AP14011	AP14010	AP12757
AP20335	AP20869	AP20908	AP20349
AP19239	AP19118	AP20955	AP18888
AP19274	AP20247	AP20986	AP19453
AP19233	AP19246	AP20327	AP20564
AP19801	AP19639	AP17222	AP20888
AP17103	AP16622	AP13996	AP13993
AP20931	AP20458	AP19615	AP20889



Panel V1 Push-Type Retainers

AP18873	AP20632	AP19422	AP17216
AP13994	AP15044	AP14019	AP14020
AP15042	AP14696	AP14697	AP14260
AP17379	AP16000	AP17632	AP17267
AP14997	AP16858	AP20348	AP17439
AP14992	AP14753	AP17472	AP17057
AP19140	AP19739	AP17143	AP16835
AP18119	AP14994	AP17144	AP19613



Panel V2 Rivets

AP13748	AP13755	AP14023	AP18108
AP13751	AP13750	AP17101	AP13752
AP13753	AP20788	AP20627	AP20834
AP16834	AP17615	AP17006	AP18461
AP20629	AP19376	AP16864	AP17121
AP17410	AP20741	AP14127	AP12652
AP17639	AP8309	AP8925	AP8931
AP5753	AP8311	AP8301	AP8313



Panel W1 Rivets, Specialty Nuts & Nylon Nuts

AP11620	AP11621	AP12655	AP12653
AP18167	AP13007	AP13009	AP13008
AP13004	AP13010	AP16253	AP16251
AP13014	AP13016	AP13017	AP13232
AP15326	AP12595	AP15335	AP18153
AP11855	AP9829	AP10330	AP11691
AP9862	AP13450	AP13960	AP13933
AP13932	AP14274	AP14313	AP3682



Panel W2 Nylon Nuts, Screw Grommets, Thread Cutting Nuts, Push-On Retainers & Pushnut Bolt Retainers

AP11719	AP8435	AP14695	AP20954
AP19194	AP19756	AP20440	AP19721
AP14267	AP19614	AP12255	AP15711
AP3403	AP2895	AP8855	AP3404
AP2896	AP2897	AP3405	AP10733
AP2557	AP8863	AP8864	AP8865
AP8868	AP8869	AP10374	AP10086
AP10087	AP9297	AP9299	AP12127



Auvecopak AP448 Retail Merchandiser Contents

Auvecopak part numbers are the same as standard Auveco part numbers with an "AP" prefix. Thus AP11146 is the Auvecopak version of 11146. *Photos not actual size.*

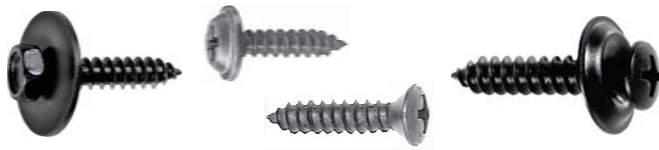

Panel X1
Black Tapping Screws

AP12213	AP12214	AP12215	AP12216
AP12217	AP12218	AP12953	AP12954
AP12957	AP11788	AP11789	AP11791
AP11792	AP15774	AP13026	AP17650
AP12820	AP12060	AP18340	AP17459
AP20259	AP20455	AP16323	AP10165
AP10167	AP10181	AP10182	AP11922
AP12741	AP12742	AP15775	AP15373



Panel X2
License Plate Screws, Body Bolts & Zinc/Chrome Tapping Screws

AP18354	AP16421	AP12351	AP12339
AP10823	AP9480	AP10362	AP11320
AP5711	AP11109	AP11110	AP12324
AP12693	AP12067	AP12160	AP12065
AP12066	AP11633	AP13613	AP12348
AP13614	AP10642	AP2805	AP12095
AP13708	AP15172	AP2806	AP13027
AP2710	AP1799	AP2713	AP1483



Panel Y1
License Plate Screws, Zinc/Chrome Tapping Screws & Body Bolts, Bumper Bolts & Headlight Adjusting Screws

AP1717	AP2730	AP2775	AP2771
AP2751	AP2772	AP2773	AP3466
AP3467	AP17098	AP17980	AP19777
AP11369	AP9603	AP16960	AP14473
AP17315	AP17316	AP16826	AP15170
AP17034	AP12335	AP9615	AP11914
AP8443	AP9355	AP3099	AP3102
AP3178	AP11655	AP11826	AP11243



Panel Y2
Moulding Clips, Clips & Fasteners and Door Hinge Pins & Bushings

AP2744	AP19626	AP2619	AP2752
AP19807	AP19378	AP9965	AP15695
AP20687	AP20390	AP20391	AP20688
AP14642	AP11152	AP19800	AP19757
AP20607	AP20774	AP20328	AP20377
AP19822	AP19821	AP8941	AP11067
AP9633	AP9639	AP9749	AP14559
AP14550	AP14553	AP16936	AP16937



Panel Z1
Extruded U-Nuts, Cage Nuts, Spring Type U-Nuts, Fender & Bumper Cover Nut and Retainer

AP10048	AP15677	AP8359	AP10051
AP10053	AP8814	AP10054	AP10055
AP11625	AP11626	AP16846	AP12669
AP16842	AP16322	AP12575	AP11628
AP11629	AP11630	AP11631	AP14750
AP5586	AP5589	AP5170	AP20758
AP10064	AP10065	AP9880	AP20757
AP9879	AP10066	AP15752	AP10067



Panel Z2
U-Nuts, Flat Nuts, Tubular Nuts, Cable Straps, Wire Loom Clips, Rubber Bumpers, Sheet Metal Plugs, Vacuum Caps, Shims & Miscellaneous

AP10666	AP13225	AP11292	AP5197
AP2293	AP2099	AP2103	AP1903
AP2611	AP2595	AP5195	AP10073
AP2288	AP15518	AP14298	AP20380
AP14546	AP14547	AP19440	AP20397
AP11746	AP4233	AP4188	AP4474
AP9288	AP4440	AP4439	AP2453
AP5076	AP5077	AP3155	AP3156

AuvecoPak AP448

Retail Merchandiser Contents

Sec. 15

Part Number Location Chart

Auveco Pak No.	Location			Auveco Pak No.	Location		
AP808	Panel T2	Row 7	Position 2	AP8301	Panel V2	Row 8	Position 3
AP1483	Panel X2	Row 8	Position 4	AP8309	Panel V2	Row 7	Position 2
AP1717	Panel Y1	Row 1	Position 1	AP8311	Panel V2	Row 8	Position 2
AP1799	Panel X2	Row 8	Position 2	AP8313	Panel V2	Row 8	Position 4
AP1903	Panel Z2	Row 2	Position 4	AP8359	Panel Z1	Row 1	Position 3
AP2099	Panel Z2	Row 2	Position 2	AP8435	Panel W2	Row 1	Position 2
AP2103	Panel Z2	Row 2	Position 3	AP8443	Panel Y1	Row 7	Position 1
AP2288	Panel Z2	Row 4	Position 1	AP8814	Panel Z1	Row 2	Position 2
AP2293	Panel Z2	Row 2	Position 1	AP8853	Panel U1	Row 6	Position 3
AP2309	Panel T2	Row 8	Position 1	AP8855	Panel W2	Row 4	Position 3
AP2310	Panel T2	Row 7	Position 4	AP8863	Panel W2	Row 6	Position 2
AP2453	Panel Z2	Row 7	Position 4	AP8864	Panel W2	Row 6	Position 3
AP2557	Panel W2	Row 6	Position 1	AP8865	Panel W2	Row 6	Position 4
AP2595	Panel Z2	Row 3	Position 2	AP8868	Panel W2	Row 7	Position 1
AP2611	Panel Z2	Row 3	Position 1	AP8869	Panel W2	Row 7	Position 2
AP2619	Panel Y2	Row 1	Position 3	AP8925	Panel V2	Row 7	Position 3
AP2710	Panel X2	Row 8	Position 1	AP8931	Panel V2	Row 7	Position 4
AP2713	Panel X2	Row 8	Position 3	AP8941	Panel Y2	Row 6	Position 3
AP2730	Panel Y1	Row 1	Position 2	AP9288	Panel Z2	Row 7	Position 1
AP2744	Panel Y2	Row 1	Position 1	AP9297	Panel W2	Row 8	Position 2
AP2751	Panel Y1	Row 2	Position 1	AP9299	Panel W2	Row 8	Position 3
AP2752	Panel Y2	Row 1	Position 4	AP9355	Panel Y1	Row 7	Position 2
AP2771	Panel Y1	Row 1	Position 4	AP9480	Panel X2	Row 2	Position 2
AP2772	Panel Y1	Row 2	Position 2	AP9603	Panel Y1	Row 4	Position 2
AP2773	Panel Y1	Row 2	Position 3	AP9615	Panel Y1	Row 6	Position 3
AP2775	Panel Y1	Row 1	Position 3	AP9633	Panel Y2	Row 7	Position 1
AP2805	Panel X2	Row 6	Position 3	AP9639	Panel Y2	Row 7	Position 2
AP2806	Panel X2	Row 7	Position 3	AP9749	Panel Y2	Row 7	Position 3
AP2895	Panel W2	Row 4	Position 2	AP9829	Panel W1	Row 6	Position 2
AP2896	Panel W2	Row 5	Position 1	AP9862	Panel W1	Row 7	Position 1
AP2897	Panel W2	Row 5	Position 2	AP9879	Panel Z1	Row 8	Position 1
AP3099	Panel Y1	Row 7	Position 3	AP9880	Panel Z1	Row 7	Position 3
AP3102	Panel Y1	Row 7	Position 4	AP9965	Panel Y2	Row 2	Position 3
AP3155	Panel Z2	Row 8	Position 3	AP10048	Panel Z1	Row 1	Position 1
AP3156	Panel Z2	Row 8	Position 4	AP10051	Panel Z1	Row 1	Position 4
AP3178	Panel Y1	Row 8	Position 1	AP10053	Panel Z1	Row 2	Position 1
AP3403	Panel W2	Row 4	Position 1	AP10054	Panel Z1	Row 2	Position 3
AP3404	Panel W2	Row 4	Position 4	AP10055	Panel Z1	Row 2	Position 4
AP3405	Panel W2	Row 5	Position 3	AP10064	Panel Z1	Row 7	Position 1
AP3466	Panel Y1	Row 2	Position 4	AP10065	Panel Z1	Row 7	Position 2
AP3467	Panel Y1	Row 3	Position 1	AP10066	Panel Z1	Row 8	Position 2
AP3682	Panel W1	Row 8	Position 4	AP10067	Panel Z1	Row 8	Position 4
AP4188	Panel Z2	Row 6	Position 3	AP10073	Panel Z2	Row 3	Position 4
AP4233	Panel Z2	Row 6	Position 2	AP10086	Panel W2	Row 7	Position 4
AP4439	Panel Z2	Row 7	Position 3	AP10087	Panel W2	Row 8	Position 1
AP4440	Panel Z2	Row 7	Position 2	AP10165	Panel X1	Row 6	Position 4
AP4474	Panel Z2	Row 6	Position 4	AP10167	Panel X1	Row 7	Position 1
AP5076	Panel Z2	Row 8	Position 1	AP10181	Panel X1	Row 7	Position 2
AP5077	Panel Z2	Row 8	Position 2	AP10182	Panel X1	Row 7	Position 3
AP5170	Panel Z1	Row 6	Position 3	AP10330	Panel W1	Row 6	Position 3
AP5195	Panel Z2	Row 3	Position 3	AP10362	Panel X2	Row 2	Position 3
AP5197	Panel Z2	Row 1	Position 4	AP10374	Panel W2	Row 7	Position 3
AP5586	Panel Z1	Row 6	Position 1	AP10621	Panel T2	Row 6	Position 3
AP5589	Panel Z1	Row 6	Position 2	AP10642	Panel X2	Row 6	Position 2
AP5711	Panel X2	Row 3	Position 1	AP10666	Panel Z2	Row 1	Position 1
AP5753	Panel V2	Row 8	Position 1	AP10733	Panel W2	Row 5	Position 4

AuvecoPak AP448 Retail Merchandiser Contents

Part Number Location Chart

Auveco Pak No.	Location			Auveco Pak No.	Location		
AP10744	Panel U1	Row 6	Position 2	AP12137	Panel T1	Row 7	Position 2
AP10823	Panel X2	Row 2	Position 1	AP12160	Panel X2	Row 4	Position 3
AP10831	Panel T1	Row 1	Position 2	AP12213	Panel X1	Row 1	Position 1
AP10832	Panel T1	Row 1	Position 1	AP12214	Panel X1	Row 1	Position 2
AP11067	Panel Y2	Row 6	Position 4	AP12215	Panel X1	Row 1	Position 3
AP11109	Panel X2	Row 3	Position 2	AP12216	Panel X1	Row 1	Position 4
AP11110	Panel X2	Row 3	Position 3	AP12217	Panel X1	Row 2	Position 1
AP11120	Panel T1	Row 2	Position 2	AP12218	Panel X1	Row 2	Position 2
AP11130	Panel T2	Row 1	Position 4	AP12255	Panel W2	Row 3	Position 3
AP11146	Panel T1	Row 1	Position 3	AP12324	Panel X2	Row 3	Position 4
AP11152	Panel Y2	Row 4	Position 2	AP12335	Panel Y1	Row 6	Position 2
AP11243	Panel Y1	Row 8	Position 4	AP12339	Panel X2	Row 1	Position 4
AP11292	Panel Z2	Row 1	Position 3	AP12348	Panel X2	Row 5	Position 4
AP11320	Panel X2	Row 2	Position 4	AP12351	Panel X2	Row 1	Position 3
AP11351	Panel T1	Row 6	Position 4	AP12565	Panel T2	Row 2	Position 2
AP11369	Panel Y1	Row 4	Position 1	AP12567	Panel U2	Row 1	Position 1
AP11612	Panel T1	Row 3	Position 1	AP12571	Panel T1	Row 8	Position 1
AP11620	Panel W1	Row 1	Position 1	AP12575	Panel Z1	Row 4	Position 3
AP11621	Panel W1	Row 1	Position 2	AP12595	Panel W1	Row 5	Position 2
AP11625	Panel Z1	Row 3	Position 1	AP12652	Panel V2	Row 6	Position 4
AP11626	Panel Z1	Row 3	Position 2	AP12653	Panel W1	Row 1	Position 4
AP11628	Panel Z1	Row 4	Position 4	AP12655	Panel W1	Row 1	Position 3
AP11629	Panel Z1	Row 5	Position 1	AP12669	Panel Z1	Row 3	Position 4
AP11630	Panel Z1	Row 5	Position 2	AP12693	Panel X2	Row 4	Position 1
AP11631	Panel Z1	Row 5	Position 3	AP12731	Panel T1	Row 4	Position 4
AP11633	Panel X2	Row 5	Position 2	AP12737	Panel T2	Row 6	Position 4
AP11655	Panel Y1	Row 8	Position 2	AP12741	Panel X1	Row 8	Position 1
AP11671	Panel T2	Row 3	Position 1	AP12742	Panel X1	Row 8	Position 2
AP11672	Panel T2	Row 6	Position 1	AP12757	Panel U2	Row 1	Position 4
AP11678	Panel T2	Row 5	Position 4	AP12759	Panel T2	Row 1	Position 2
AP11679	Panel T1	Row 4	Position 1	AP12766	Panel T1	Row 5	Position 4
AP11691	Panel W1	Row 6	Position 4	AP12820	Panel X1	Row 5	Position 1
AP11699	Panel U1	Row 8	Position 1	AP12909	Panel T1	Row 8	Position 2
AP11705	Panel U1	Row 7	Position 4	AP12953	Panel X1	Row 2	Position 3
AP11706	Panel U1	Row 8	Position 3	AP12954	Panel X1	Row 2	Position 4
AP11719	Panel W2	Row 1	Position 1	AP12957	Panel X1	Row 3	Position 1
AP11721	Panel T1	Row 3	Position 2	AP12992	Panel T2	Row 3	Position 3
AP11746	Panel Z2	Row 6	Position 1	AP13004	Panel W1	Row 3	Position 1
AP11788	Panel X1	Row 3	Position 2	AP13007	Panel W1	Row 2	Position 2
AP11789	Panel X1	Row 3	Position 3	AP13008	Panel W1	Row 2	Position 4
AP11791	Panel X1	Row 3	Position 4	AP13009	Panel W1	Row 2	Position 3
AP11792	Panel X1	Row 4	Position 1	AP13010	Panel W1	Row 3	Position 2
AP11796	Panel T2	Row 7	Position 1	AP13014	Panel W1	Row 4	Position 1
AP11797	Panel T2	Row 4	Position 2	AP13016	Panel W1	Row 4	Position 2
AP11826	Panel Y1	Row 8	Position 3	AP13017	Panel W1	Row 4	Position 3
AP11855	Panel W1	Row 6	Position 1	AP13026	Panel X1	Row 4	Position 3
AP11863	Panel T2	Row 7	Position 3	AP13027	Panel X2	Row 7	Position 4
AP11914	Panel Y1	Row 6	Position 4	AP13225	Panel Z2	Row 1	Position 2
AP11922	Panel X1	Row 7	Position 4	AP13232	Panel W1	Row 4	Position 4
AP12060	Panel X1	Row 5	Position 2	AP13450	Panel W1	Row 7	Position 2
AP12065	Panel X2	Row 4	Position 4	AP13461	Panel T2	Row 6	Position 2
AP12066	Panel X2	Row 5	Position 1	AP13470	Panel T2	Row 2	Position 3
AP12067	Panel X2	Row 4	Position 2	AP13613	Panel X2	Row 5	Position 3
AP12095	Panel X2	Row 6	Position 4	AP13614	Panel X2	Row 6	Position 1
AP12127	Panel W2	Row 8	Position 4	AP13708	Panel X2	Row 7	Position 1
AP12134	Panel T2	Row 8	Position 2	AP13748	Panel V2	Row 1	Position 1

AuvecoPak AP448

Retail Merchandiser Contents

Sec. 15

Part Number Location Chart

Auveco Pak No.	Location			Auveco Pak No.	Location		
AP13750	Panel V2	Row 2	Position 2	AP15367	Panel T1	Row 3	Position 3
AP13751	Panel V2	Row 2	Position 1	AP15373	Panel X1	Row 8	Position 4
AP13752	Panel V2	Row 2	Position 4	AP15456	Panel T2	Row 1	Position 3
AP13753	Panel V2	Row 3	Position 1	AP15457	Panel T2	Row 1	Position 1
AP13755	Panel V2	Row 1	Position 2	AP15461	Panel T2	Row 5	Position 3
AP13932	Panel W1	Row 8	Position 1	AP15479	Panel T1	Row 8	Position 3
AP13933	Panel W1	Row 7	Position 4	AP15480	Panel T1	Row 7	Position 4
AP13960	Panel W1	Row 7	Position 3	AP15481	Panel T1	Row 7	Position 3
AP13993	Panel U2	Row 7	Position 4	AP15518	Panel Z2	Row 4	Position 2
AP13994	Panel V1	Row 2	Position 1	AP15543	Panel T1	Row 6	Position 1
AP13996	Panel U2	Row 7	Position 3	AP15677	Panel Z1	Row 1	Position 2
AP14010	Panel U2	Row 1	Position 3	AP15695	Panel Y2	Row 2	Position 4
AP14011	Panel U2	Row 1	Position 2	AP15711	Panel W2	Row 3	Position 4
AP14016	Panel U1	Row 6	Position 4	AP15752	Panel Z1	Row 8	Position 3
AP14019	Panel V1	Row 2	Position 3	AP15774	Panel X1	Row 4	Position 2
AP14020	Panel V1	Row 2	Position 4	AP15775	Panel X1	Row 8	Position 3
AP14021	Panel T1	Row 2	Position 4	AP15970	Panel T2	Row 3	Position 2
AP14023	Panel V2	Row 1	Position 3	AP15998	Panel T1	Row 8	Position 4
AP14032	Panel T1	Row 5	Position 2	AP16000	Panel V1	Row 4	Position 2
AP14036	Panel T1	Row 5	Position 3	AP16251	Panel W1	Row 3	Position 4
AP14127	Panel V2	Row 6	Position 3	AP16253	Panel W1	Row 3	Position 3
AP14163	Panel U1	Row 4	Position 4	AP16322	Panel Z1	Row 4	Position 2
AP14260	Panel V1	Row 3	Position 4	AP16323	Panel X1	Row 6	Position 3
AP14267	Panel W2	Row 3	Position 1	AP16421	Panel X2	Row 1	Position 2
AP14274	Panel W1	Row 8	Position 2	AP16622	Panel U2	Row 7	Position 2
AP14291	Panel U1	Row 2	Position 2	AP16695	Panel T2	Row 5	Position 2
AP14298	Panel Z2	Row 4	Position 3	AP16782	Panel U1	Row 7	Position 2
AP14313	Panel W1	Row 8	Position 3	AP16784	Panel U1	Row 7	Position 3
AP14328	Panel U1	Row 6	Position 1	AP16818	Panel T1	Row 4	Position 3
AP14355	Panel U1	Row 2	Position 1	AP16826	Panel Y1	Row 5	Position 3
AP14356	Panel U1	Row 1	Position 2	AP16834	Panel V2	Row 4	Position 1
AP14473	Panel Y1	Row 4	Position 4	AP16835	Panel V1	Row 7	Position 4
AP14546	Panel Z2	Row 5	Position 1	AP16842	Panel Z1	Row 4	Position 1
AP14547	Panel Z2	Row 5	Position 2	AP16846	Panel Z1	Row 3	Position 3
AP14550	Panel Y2	Row 8	Position 1	AP16858	Panel V1	Row 5	Position 2
AP14553	Panel Y2	Row 8	Position 2	AP16864	Panel V2	Row 5	Position 3
AP14559	Panel Y2	Row 7	Position 4	AP16936	Panel Y2	Row 8	Position 3
AP14642	Panel Y2	Row 4	Position 1	AP16937	Panel Y2	Row 8	Position 4
AP14695	Panel W2	Row 1	Position 3	AP16960	Panel Y1	Row 4	Position 3
AP14696	Panel V1	Row 3	Position 2	AP17004	Panel U1	Row 4	Position 3
AP14697	Panel V1	Row 3	Position 3	AP17006	Panel V2	Row 4	Position 3
AP14736	Panel U1	Row 2	Position 4	AP17034	Panel Y1	Row 6	Position 1
AP14737	Panel U1	Row 3	Position 1	AP17057	Panel V1	Row 6	Position 4
AP14738	Panel U1	Row 4	Position 2	AP17075	Panel T2	Row 4	Position 4
AP14750	Panel Z1	Row 5	Position 4	AP17098	Panel Y1	Row 3	Position 2
AP14753	Panel V1	Row 6	Position 2	AP17101	Panel V2	Row 2	Position 3
AP14921	Panel T1	Row 2	Position 3	AP17103	Panel U2	Row 7	Position 1
AP14992	Panel V1	Row 6	Position 1	AP17121	Panel V2	Row 5	Position 4
AP14994	Panel V1	Row 8	Position 2	AP17143	Panel V1	Row 7	Position 3
AP14997	Panel V1	Row 5	Position 1	AP17144	Panel V1	Row 8	Position 3
AP15042	Panel V1	Row 3	Position 1	AP17162	Panel U1	Row 7	Position 1
AP15044	Panel V1	Row 2	Position 2	AP17216	Panel V1	Row 1	Position 4
AP15170	Panel Y1	Row 5	Position 4	AP17222	Panel U2	Row 6	Position 3
AP15172	Panel X2	Row 7	Position 2	AP17267	Panel V1	Row 4	Position 4
AP15326	Panel W1	Row 5	Position 1	AP17315	Panel Y1	Row 5	Position 1
AP15335	Panel W1	Row 5	Position 3	AP17316	Panel Y1	Row 5	Position 2

AuvecoPak AP448 Retail Merchandiser Contents

Part Number Location Chart

Auveco Pak No.	Location		
AP17339	Panel U1	Row 5	Position 1
AP17379	Panel V1	Row 4	Position 1
AP17410	Panel V2	Row 6	Position 1
AP17439	Panel V1	Row 5	Position 4
AP17459	Panel X1	Row 5	Position 4
AP17472	Panel V1	Row 6	Position 3
AP17612	Panel T1	Row 3	Position 4
AP17615	Panel V2	Row 4	Position 2
AP17632	Panel V1	Row 4	Position 3
AP17639	Panel V2	Row 7	Position 1
AP17649	Panel T2	Row 2	Position 1
AP17650	Panel X1	Row 4	Position 4
AP17664	Panel T1	Row 1	Position 4
AP17975	Panel U1	Row 3	Position 4
AP17980	Panel Y1	Row 3	Position 3
AP18033	Panel U1	Row 5	Position 4
AP18108	Panel V2	Row 1	Position 4
AP18114	Panel T2	Row 8	Position 4
AP18119	Panel V1	Row 8	Position 1
AP18153	Panel W1	Row 5	Position 4
AP18167	Panel W1	Row 2	Position 1
AP18297	Panel U1	Row 2	Position 3
AP18301	Panel T1	Row 5	Position 1
AP18340	Panel X1	Row 5	Position 3
AP18353	Panel U1	Row 8	Position 4
AP18354	Panel X2	Row 1	Position 1
AP18461	Panel V2	Row 4	Position 4
AP18842	Panel U1	Row 3	Position 3
AP18848	Panel T2	Row 2	Position 4
AP18873	Panel V1	Row 1	Position 1
AP18877	Panel U1	Row 5	Position 3
AP18888	Panel U2	Row 3	Position 4
AP18915	Panel T2	Row 4	Position 1
AP18930	Panel T2	Row 4	Position 3
AP19113	Panel U1	Row 3	Position 2
AP19114	Panel U1	Row 1	Position 1
AP19118	Panel U2	Row 3	Position 2
AP19140	Panel V1	Row 7	Position 1
AP19171	Panel U1	Row 5	Position 2
AP19194	Panel W2	Row 2	Position 1
AP19233	Panel U2	Row 5	Position 1
AP19239	Panel U2	Row 3	Position 1
AP19246	Panel U2	Row 5	Position 2
AP19270	Panel T2	Row 5	Position 1
AP19274	Panel U2	Row 4	Position 1
AP19376	Panel V2	Row 5	Position 2
AP19378	Panel Y2	Row 2	Position 2
AP19386	Panel T2	Row 3	Position 4
AP19422	Panel V1	Row 1	Position 3
AP19440	Panel Z2	Row 5	Position 3
AP19453	Panel U2	Row 4	Position 4
AP19613	Panel V1	Row 8	Position 4
AP19614	Panel W2	Row 3	Position 2
AP19615	Panel U2	Row 8	Position 3
AP19626	Panel Y2	Row 1	Position 2
AP19639	Panel U2	Row 6	Position 2

Auveco Pak No.	Location		
AP19655	Panel U1	Row 4	Position 1
AP19682	Panel T2	Row 8	Position 3
AP19721	Panel W2	Row 2	Position 4
AP19729	Panel U1	Row 1	Position 3
AP19739	Panel V1	Row 7	Position 2
AP19756	Panel W2	Row 2	Position 2
AP19757	Panel Y2	Row 4	Position 4
AP19777	Panel Y1	Row 3	Position 4
AP19800	Panel Y2	Row 4	Position 3
AP19801	Panel U2	Row 6	Position 1
AP19807	Panel Y2	Row 2	Position 1
AP19821	Panel Y2	Row 6	Position 2
AP19822	Panel Y2	Row 6	Position 1
AP19837	Panel T1	Row 4	Position 2
AP20192	Panel T1	Row 2	Position 1
AP20247	Panel U2	Row 4	Position 2
AP20248	Panel U1	Row 8	Position 2
AP20259	Panel X1	Row 6	Position 1
AP20316	Panel T1	Row 6	Position 3
AP20327	Panel U2	Row 5	Position 3
AP20328	Panel Y2	Row 5	Position 3
AP20335	Panel U2	Row 2	Position 1
AP20348	Panel V1	Row 5	Position 3
AP20349	Panel U2	Row 2	Position 4
AP20362	Panel T1	Row 7	Position 1
AP20366	Panel T1	Row 6	Position 2
AP20377	Panel Y2	Row 5	Position 4
AP20380	Panel Z2	Row 4	Position 4
AP20390	Panel Y2	Row 3	Position 2
AP20391	Panel Y2	Row 3	Position 3
AP20397	Panel Z2	Row 5	Position 4
AP20440	Panel W2	Row 2	Position 3
AP20455	Panel X1	Row 6	Position 2
AP20458	Panel U2	Row 8	Position 2
AP20543	Panel U1	Row 1	Position 4
AP20564	Panel U2	Row 5	Position 4
AP20607	Panel Y2	Row 5	Position 1
AP20627	Panel V2	Row 3	Position 3
AP20629	Panel V2	Row 5	Position 1
AP20632	Panel V1	Row 1	Position 2
AP20687	Panel Y2	Row 3	Position 1
AP20688	Panel Y2	Row 3	Position 4
AP20741	Panel V2	Row 6	Position 2
AP20757	Panel Z1	Row 7	Position 4
AP20758	Panel Z1	Row 6	Position 4
AP20774	Panel Y2	Row 5	Position 2
AP20788	Panel V2	Row 3	Position 2
AP20834	Panel V2	Row 3	Position 4
AP20869	Panel U2	Row 2	Position 2
AP20888	Panel U2	Row 6	Position 4
AP20889	Panel U2	Row 8	Position 4
AP20908	Panel U2	Row 2	Position 3
AP20931	Panel U2	Row 8	Position 1
AP20954	Panel W2	Row 1	Position 4
AP20955	Panel U2	Row 3	Position 3
AP20986	Panel U2	Row 4	Position 3

**A great introduction to prospective accounts or
an exciting new program to increase sales with existing customers**

Free Cabinet
when you buy
4 different assortments

The Most Popular
Body Hardware &
Specialty Fasteners



The Body Hardware Master Program, 6600BHM is based on Auveco's **DB-428 Display Boards**.

We have developed 20 large metal drawer assortments, which contain 428 of the most popular domestic and foreign body hardware clips and fasteners. Items come in heavy gauge steel, pre-labeled and pre-loaded large drawers and cabinets.

Each drawer is set up to accommodate the Auveco unit package quantity. No more problems with refills.

6650BHM: Buy a combination of any four different 6600BHM series individual drawer assortments and you'll receive one FREE 2-96 four drawer cabinet

Assortments Based on DB-428 Display Boards

Photos not actual size



6601BHM
Small Retainers &
Retaining Clips
24 Varieties, 840 Pieces

Contains the following
Auveco part numbers:

10621, 11612, 11796, 12565,
12737, 12992, 13470, 14021, 14291,
14328, 14736, 14737, 15367, 15970,
17339, 18033, 18114, 18297, 18848,
18877, 19114, 19682, 19729 & 20543



6603BHM
Hood Insulation Retainers,
Trim Panel Fasteners &
Rubber Vacuum Caps
16 Varieties, 440 Pieces

Contains the following
Auveco part numbers:

4439, 4440, 11863, 11130, 12134, 12209,
12210, 12907, 12908, 14163, 15456,
19613, 19614, 19655, 20757 & 20758



6602BHM
Large Retainers
22 Varieties, 965 Pieces

Contains the following
Auveco part numbers:

10831, 12137, 12571, 12731, 12759,
12766, 12909, 14036, 14738, 15414,
15479, 15543, 15998, 16818, 17004,
17612, 17664, 17975, 19837, 20192,
20362 & 20366



6604BHM
Push-Type Retainers
24 Varieties, 445 Pieces

Contains the following
Auveco part numbers:

14260, 14753, 14992, 14997,
16000, 16858, 17057, 17143,
17144, 17267, 17379, 17472,
17632, 18119, 18888, 19118,
19239, 19739, 20335, 20348,
20349, 20869, 20908 & 20955



6605BHM

Push-Type Retainers
24 Varieties, 492 Pieces

Contains the following
Auveco part numbers:
12757, 13993, 13996, 14010,
14019, 14020, 17216, 17222,
18873, 19233, 19246, 19274,
19422, 19453, 19615, 19639,
19801, 20247, 20327,
20564, 20632, 20889,
20931 & 20986



6606BHM

Push-Type Retainers,
Nylon Rivets
& Specialty Rivets
24 Varieties, 680 Pieces

Contains the following
Auveco part numbers:
12567, 12652, 13748, 13750,
13751, 13753, 13755, 14011,
14023, 14127, 16834, 16864,
17006, 17121, 17410, 17615,
17639, 18108, 18167, 18353,
18461, 19376, 20629 & 20741

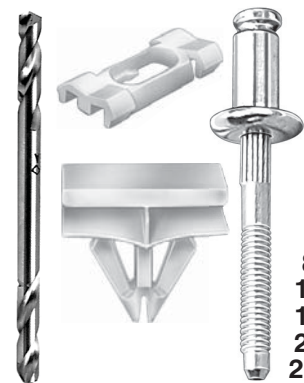

6607BHM

Specialty Rivets, Double End
Drill & Moulding Clips
24 Varieties, 925 Pieces

Contains the following
Auveco part numbers:
8301, 8311, 8313, 8925,
8931, 12653, 12655, 12658,
12676, 14642, 16837, 16838,
19757, 19821, 19822, 20328,
20377, 20523, 20607, 20626,
20627, 20774, 20788 & 20834



6608BHM

Moulding Clips & Fasteners,
Plug Buttons &
Wire Loom Clips
22 Varieties, 840 Pieces

Contains the following
Auveco part numbers:
2619, 2744, 2752, 8941,
9288, 9633, 9749, 9965,
11746, 14545, 14546,
14547, 19378, 19626, 19807,
20390, 20391, 20392, 20397,
20429, 20687 & 20688



6609BHM

Phillips Oval Head, Phillips Pan
Head & Specialty Tapping Screws
(Chrome & Zinc)
24 Varieties, 2400 Pieces

Contains the following
Auveco part numbers:
1423, 1483, 1717, 1794, 1796, 1799, 1940, 1943,
2027, 2365, 2366, 2367, 2710, 2713, 2728, 2730,
2731, 3079, 3090, 9603, 9605, 12095, 15172 & 19777



6610BHM

Phillips Oval Head Sems® (Chrome
& Black Phosphate) & Hex Washer
Head (Zinc and Zinc & Yellow)
Tapping Screws
24 Varieties, 1825 Pieces

Contains the following
Auveco part numbers:
2751, 2772, 2773, 2775, 3466, 3467, 9611, 9615,
11369, 11450, 11451, 11455, 11456, 11788, 11789,
11790, 11791, 11792, 11914, 15170, 16828,
16960, 17098 & 17980



6611BHM

Phillips Oval Head (Black Oxide),
Phillips Pan Head (Black Oxide) &
Specialty Tapping Screws
(Black E-Coat)
24 Varieties, 2175 Pieces

Contains the following Auveco part numbers:
10162, 10164, 10165, 10166, 10167, 10168, 10180,
10181, 10182, 11086, 11087, 11088, 11089, 11917,
11921, 11922, 11923, 12796, 12797, 12799,
12820, 12957, 16323 & 20259

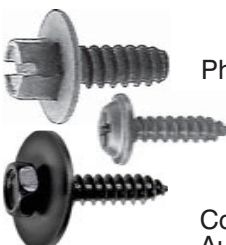

6612BHM

Phillips Flat Top Washer Head (Black),
Hex Head Sems® (Black) &
Hex Slotted Head (Black)
Tapping Screws
23 Varieties, 1750 Pieces

Contains the following
Auveco part numbers:
12060, 12213, 12214, 12215, 12216, 12217, 12218,
12339, 12351, 12738, 12742, 12953, 12954, 13026,
15373, 15774, 15775, 16421, 17459, 17650,
18340, 18354 & 20455



6613BHM

Hex Head Sems & Hex Washer
Head Body Bolts (Black)
21 Varieties, 810 Pieces

Contains the following
Auveco part numbers:
9480, 10362, 10823, 11109,
11110, 11320, 11641, 12065,
12066, 12160, 12232, 12324, 12336,
12343, 12693, 13613, 13614, 13618,
13619, 18416 & 18769

BODY HARDWARE MASTER ASSORTMENTS

Based on DB-428 Display Boards • *Photos not actual size*

Sec. 15



6614BHM

Hex Head Sems® & Hex Washer Head Body Bolts (Zinc), Bumper Bolts & Specialty Fasteners
12 Varieties, 445 Pieces

Contains the following Auveco part numbers:
4474, 5242, 5246, 8443, 11295, 12335, 14473, 14976, 16826, 17316, 18262 & 19339



6615BHM

Spin Lock Nuts, Hex Flange Nuts, Free Spinning Washer Nuts, Jack Nuts & Well Nuts
23 Varieties, 705 Pieces

Contains the following Auveco part numbers:
11644, 11645, 12595, 12596, 12995, 12999, 13004, 13007, 13008, 13009, 13010, 13014, 13016, 14855, 15326, 15329, 15334, 15335, 16470, 16769, 16830, 16883 & 20415



6616BHM

J-Nuts, Spring Type U-Nuts & Extruded U-Nuts
23 Varieties, 965 Pieces

Contains the following Auveco part numbers:
5586, 5589, 8359, 8814, 9879, 9880, 10051, 10053, 10054, 10055, 10064, 10065, 10066, 10067, 11628, 11629, 11630, 11631, 12575, 12669, 14750, 15677 & 15752



6617BHM

Flat Nuts, U-Nuts, Tubular Nuts & Shims
11 Varieties, 950 Pieces

Contains the following Auveco part numbers:
1903, 2089, 2099, 2293, 2595, 3155, 3156, 5076, 5077, 5196 & 11292



6618BHM

Washer Lock Nuts, Thread Cutting Nuts, Push-On Retainers & Pushnut Bolt Retainers
23 Varieties, 2300 Pieces

Contains the following Auveco part numbers:
2555, 2557, 2896, 2897, 3404, 3405, 8863, 8864, 8865, 8868, 8869, 9297, 9299, 10086, 10087, 10374, 10733, 12123, 12127, 12253, 12255, 12259 & 14980



6619BHM

Nylon Nuts & Screw Grommets
23 Varieties, 860 Pieces

Contains the following Auveco part numbers:
3682, 8435, 9829, 9862, 11368, 11691, 11719, 13450, 13932, 13933, 13960, 14031, 14267, 14268, 14274, 14275, 14695, 18153, 19194, 19721, 19756, 20440 & 20954



6620BHM

Door Hinge Pins & Bushings, Headlight Hardware, Door Lock Rod Clips, Window Crank Handle Retainer Clips & Cable Straps
14 Varieties, 336 Pieces

Contains the following Auveco part numbers:
2288, 3178, 11243, 14298, 14550, 14553, 14559, 15518, 15940, 16936, 16937, 19424, 19781 & 20380

6649BHM

Small Size • Grade 5 USS • Cap Screws, Nuts & Washers
12 Varieties, 150 Pieces

Auveco Part No.	Size
5434*	1/4"-20 x 1/2"
5436*	1/4"-20 x 3/4"
5438*	1/4"-20 x 1"
5449*	5/16"-18 x 3/4"
5451*	5/16"-18 x 1"
5452*	5/16"-18 x 1-1/4"
5453	5/16"-18 x 1-1/2"
5455	5/16"-18 x 2"
15586	1/4"-20 Hex Nut
15587	5/16"-18 Hex Nut
8606	1/4" USS Washer
8607	5/16" USS Washer

*Threaded to the head

6634BHM

Large Size • Metric Cap Screws, Nuts & Washers
12 Varieties, 380 Pieces

Auveco Part No.	Size
14430	M10-1.5 x 20mm
14431	M10-1.5 x 25mm
14432	M10-1.5 x 30mm
14433	M10-1.5 x 35mm
14434	M10-1.5 x 40mm
14436	M10-1.5 x 50mm
14438	M10-1.5 x 60mm
14439	M10-1.5 x 70mm
14441	M12-1.75 x 30mm
14442	M12-1.75 x 35mm
14443	M12-1.75 x 40mm
14445	M12-1.75 x 50mm
14454	M10-1.5 Hex Nut
14455	M12-1.75 Hex Nut
17395	10mm Flat Washer
10583	12mm Flat Washer

Based on DB-428 Display Boards • *Photos not actual size*

6642BHM

Large Size • Grade 5 USS • Cap Screws, Nuts & Washers
8 Varieties, 650 Pieces



Auveco Part No.	Size
5463	3/8"-16 x 3/4
5465	3/8"-16 x 1"
5466	3/8"-16 x 1-1/4"
5467	3/8"-16 x 1-1/2"
5469	3/8"-16 x 2"
5471	3/8"-16 x 2-1/2"
5476	7/16"-14 x 1"
5477	7/16"-14 x 1-1/4
15588	3/8"-16 Hex Nut
15589	7/16"-14 Hex Nut
8608	3/8" USS Washer
8609	7/16" USS Washer

6629BHM

J.I.S. Hex Flange Bolts & Spin Lock Nuts
21 Varieties, 550 Pieces



Auveco Part No.	Size
17315	M6-1.0 x 12mm
17316	M6-1.0 x 16mm
18807	M6-1.0 x 20mm
21048	M6-1.0 x 25mm
18808	M6-1.0 x 30mm
18809	M6-1.0 x 40mm
18980	M8-1.25 x 12mm
17387	M8-1.25 x 16mm
17388	M8-1.25 x 20mm
21051	M8-1.25 x 25mm
17389	M8-1.25 x 30mm
21052	M8-1.25 x 35mm
17390	M8-1.25 x 40mm
21053	M8-1.25 x 45mm
17188	M10-1.25 x 16mm
17189	M10-1.25 x 20mm
21054	M10-1.25 x 25mm
17190	M10-1.25 x 30mm
21055	M10-1.25 x 35mm
17191	M10-1.25 x 40mm
21056	M10-1.25 x 45mm
16769	M6-1.0 Nut
16830	M8-1.25 Nut
16470	M10-1.25 Nut

6635BHM

Small Size • Metric Cap Screws, Nuts & Washers
14 Varieties, 925 Pieces



Auveco Part No.	Size
14403	M5-.8 x 16mm
14404	M5-.8 x 20mm
14407	M6-1.0 x 12mm
14408	M6-1.0 x 16mm
14409	M6-1.0 x 20mm
14410	M6-1.0 x 25mm
14411	M6-1.0 x 30mm
14419	M8-1.25 x 16mm
14420	M8-1.25 x 20mm
14421	M8-1.25 x 25mm
14422	M8-1.25 x 30mm
14423	M8-1.25 x 35mm
14424	M8-1.25 x 40mm
14426	M8-1.25 x 50mm
14449	M5-.8 Hex Nut
14450	M6-1.0 Hex Nut
14452	M8-1.25 Hex Nut
10578	5mm Flat Washer
17393	6mm Flat Washer
17394	8mm Flat Washer

6630BHM

Nylon Connectors & Rubber Vacuum Caps
24 Varieties, 310 Pieces



Auveco Part No.	Size	Description
Nylon Connectors		
12929	1/8" x 1/8"	Straight
12930	1/8" x 3/16"	Straight
12936	1/8" x 1/4"	Straight
12937	3/16" x 3/16"	Straight
12935	1/4" x 3/16"	Straight
12931	1/4" x 1/4"	Straight
12946	5/16" x 5/16"	Straight
12923	1/8" x 1/8" x 1/8"	Tee
12926	3/16" x 3/16" x 1/8"	Tee
12918	3/16" x 3/16" x 3/16"	Tee
12919	1/4" x 3/16" x 3/16"	Tee
11738	1/4" x 1/4" x 3/16"	Tee
17629	1/4" x 1/4" x 1/4"	Tee
12920	5/16" x 5/16" x 5/16"	Tee
12927	3/16" x 3/16" x 3/16"	Y
12943	1/4" x 1/4" x 1/4"	Y
12932	3/16" x 3/16"	Elbow
12939	3/16"	Cross

Rubber Caps

12209	For 1/8" O. D. Tube
4440	For 3/16" O. D. Tube
4439	For 1/4" O. D. Tube
12907	For 5/16" O. D. Tube
12210	For 3/8" O. D. Tube
12908	For 1/2" O. D. Tube

6631BHM

Krimp and Seal Terminals & Connectors
24 Varieties, 240 Pieces



Auveco Part No.	Description
13656	Ring Type, 22-18 Ga.
13657	Ring Type, 22-18 Ga.
13658	Spade Type, 22-18 Ga.
13659	Butt Conn., 22-18 Ga.
13660	Female Q. C., 22-18 Ga.
13661	Male Q. C., 22-18 Ga.
13662	Ring Type, 16-14 Ga.
13663	Ring Type, 16-14 Ga.
13664	Ring Type, 16-14 Ga.
13665	Ring Type, 16-14 Ga.
13666	Ring Type, 16-14 Ga.
13669	Butt Conn., 16-14 Ga.
13670	Female Q. C., 16-14 Ga.
13671	Male Q. C., 16-14 Ga.
13672	Female Q. C., 16-14 Ga.
13673	Male Q. C., 16-14 Ga.
13681	Female Plug, 16-14 Ga.
13682	Male Plug, 16-14 Ga.
13674	Ring Type, 12-10 Ga.
13675	Ring Type, 12-10 Ga.
13676	Ring Type, 12-10 Ga.
13678	Butt Conn., 12-10 Ga.
13679	Female Q. C., 12-10 Ga.
13680	Male Q. C., 12-10 Ga.

6699BHM

High Performance Imported
Miniature & Halogen Bulbs
71 Varieties, 494 Pieces



Contains Auveco Assortments
6643BHM, 6644BHM,
6645BHM,
1-924 24 Compartment Empty
Drawer and 2-96
Four Drawer Cabinet.

BODY HARDWARE MASTER ASSORTMENTS

Based on DB-428 Display Boards • *Photos not actual size*

Sec. 15



6643BHM

High Performance
Imported Miniature Bulbs
24 Varieties, 240 Pieces

Contain the following
Auveco Part Numbers:
**B24, B24A, B53, B57, B67,
B67A, B68, B89, B97, B168,
B194, B194A, B906, B906A,
B912, B916, B916A, B921,
B921A, B1141, B1156,
B1156A, B1157 & B1157A**



6644BHM

High Performance
Imported Miniature Bulbs
23 Varieties, 230 Pieces

Contain the following
Auveco Part Numbers:
**B1893, B1895, B2057,
B2057A, B2357, B2357A,
B3057, B3057A, B3156,
B3156A, B3157, B3157A,
B3357, B3357A, B3457,
B3457A, B4114K, B4157,
B4157K, B7440, B7440A,
B7443 & B7443A**



6645BHM

High Performance
Imported Halogen Bulbs
24 Varieties, 24 Pieces

Contain the following
Auveco Part Numbers:
**B880, B881, B884, B885,
B886, B889, B890, B891,
B893, B894, B896, B899,
B9004, B9005, B9006,
B9007, BH1, BH3, BH7, BH9,
BH10, BH11, BH13 & BD2C**



6641BHM

Cable Ties & Straps
10 Varieties, 575 Pieces

Auveco Part No.	Description
8550	2-1/4" Long, 7/16" Wide
14298	140mm Long, 8mm Wide
15144	4" Long, 3/32" Wide
15145	5-1/2" Long, 1/8" Wide
15146	7" Long, 3/16" Wide
15147	11" Long, 3/16" Wide
15148	14" Long, 5/16" Wide
15753	14" Long, 3/16" Wide
20380	200mm Long, 5mm Wide
21203	155mm Long, 5mm Wide

6628BHM

Oil Drain Plugs & Gaskets
24 Varieties, 105 Pieces



Auveco Part No.	Size
-----------------	------

14196	1/2"-20
18373	1/2"-20
19130	1/2"-20
19365	1/2"-20, Magnetic
15527	M12-1.25
19588	M12-1.25
14677	M12-1.75
18023	M12-1.75
18374	M12-1.75
20347	M12-1.75
21047	M12-1.75
18024	M14-1.25
14678	M14-1.5
16308	M14-1.5
18025	M14-1.5
18375	M14-1.5
19141	M14-1.5
19279	M14-1.5
19620	M14-1.5 Single Oversize
19773	M14-1.5
20426	M14-1.5
15528	M16.4-1.33
15529	M18-1.5
15530	M20-1.5

6637BHM

Nylon Rivets
16 Varieties, 475 Pieces



Auveco Part No.	Size	Grip
20754	6mm	2.5mm-4.8mm
13746	3/16"	1/16"-9/64"
13747	13/64"	1/16"-11/64"
13748	13/64"	1/8"-15/64"
13755	13/64"	15/64"-25/64"
14004	15/64"	11/64"-11/32"
13752	17/64"	3/32"-3/16"
13753	17/64"	3/32"-3/16"
18502	1/4"	5/32"-1/4"
13750	1/4"	5/32"-13/32"
17101	1/4"	5/16"-15/32"
18108	1/4"	5/32"-3/8"
21028	1/4"	5/32"-3/8"
13751	1/4"	5/32"-13/32"
15490	9/32"	3/32"-15/64"
14023	15/64"	5/32"-5/16"

6633BHM

Metal Specialty Rivets
24 Varieties - 850 Pieces



Auveco Part No.	Size
1/8" (3.2mm) Diameter	
20788	Grip: 3/64" - 1/8"
20627	Grip: 3/64" - 3/16"
16834	Grip: 1/8" - 3/16"
8931	Grip: 3/16" - 1/4"
17615	Grip: 3/16" - 3/8"
5/32" (4mm) Diameter	
18461	Grip: 3/64" - 1/4"
20629	Grip: 3/64" - 1/4"
20971	Grip: 3/64" - 9/32"
19376	Grip: 1/8" - 11/32"
17006	Grip: 1/4" - 3/8"
3/16" (4.8mm) Diameter	
16864	Grip: 3/64" - 11/32"
20741	Grip: 3/64" - 23/64"
17121	Grip: 5/64" - 15/64"
8311	Grip: 1/8" - 1/4"
17410	Grip: 3/8" - 1/2"
14127	Grip: 3/8" - 1/2"
1/4" (6.4mm) Diameter	
16837	Grip: 1/32" - 9/64"
12653	Grip: 3/32" - 1/8"
18167	Grip: 3/32" - 9/64"
12652	Grip: 1/8" - 1/4"
12655	Grip: 9/64" - 3/16"
17639	Grip: 3/16" - 3/8"
8313	Grip: 1/4" - 3/8"
16838	Grip: 33/64" - 19/32"

6632BHM

GM, Ford & Chrysler
Push-Type Retainers
12 Varieties - 400 Pieces



Contains the following
Auveco part numbers:
**17216, 20889, 20888, 20991,
20826, 20992, 20880, 20988,
20989, 20990, 20993 & 20994**

6622BHM

BMW Clips & Fasteners
14 Varieties - 565 Pieces



Auveco Part No.	Description
13158	Moulding Clip
13162	U-Nut
13215	U-Nut
13216	U-Nut
13218	U-Nut
13223	U-Nut
18156	M4.8-1.59 x 16mm L.P. Screw
20186	Grommet
20234	Push-Type Retainer
20248	Push-Type Retainer
20253	Trim Panel Retainer
20270	Push-Type Retainer
20734	Push-Type Retainer
20754	Nylon Rivet

6624BHM

Honda & Acura
Push-Type Retainers
24 Varieties - 360 Pieces



Contains the following
Auveco part numbers:
**14696, 14697, 16000, 16782,
17057, 17143, 17144, 17267,
17379, 18119, 19118, 19140,
19231, 19233, 19239, 19416,
19453, 20247, 20352, 20564,
20608, 20986, 21173 & 21297**

6638BHM

GM Moulding Clips
24 Varieties - 415 Pieces



Contains the following
Auveco part numbers:
**10617, 14642, 19757, 19800,
19820, 19821, 19822, 20280,
20318, 20328, 20353, 20377,
20607, 20756, 20774, 20808,
20865, 20884, 20934, 20952,
20972, 20976, 21128 &
21374**

6623BHM

Honda & Acura
Retainers & Retaining Clips
24 Varieties - 595 Pieces



Contains the following
Auveco part numbers:
**14289, 14291, 14328, 15998, 16775,
16776, 16779, 17205, 18114, 18294,
18746, 18877, 19114, 19116, 19145,
19171, 19470, 19506, 19682, 20334,
20609, 20610, 20882 & 21107**

6639BHM

Hyundai & Kia
Clips & Fasteners
20 Varieties - 455 Pieces



Auveco Part No.	Description
20543	Hood Ins. Retainer
20566	Moulding Clip
20567	Moulding Clip
20568	Moulding Clip
20680	L. P. Screw
21064	Moulding Clip
21067	Bumper & Grille Retainer
21068	Nylon Nut
21070	Trim Panel Retainer
21136	Moulding Clip
21146	Push-Type Retainer
21188	Trim Panel Retainer
21244	Moulding Clip
21312	Moulding Clip
21321	Moulding Clip
21328	Push-Type Retainer
21360	Trim Panel Retainer
21378	Nylon U-Nut
21381	Hood Seal Retainer
21382	Cowl & Grille Retainer

6621BHM

Mercedes-Benz
Clips & Fasteners
24 Varieties - 665 Pieces



Auveco Part No.	Description
13215	U-Nut
13216	U-Nut
13218	U-Nut
13220	U-Nut
13223	U-Nut
13224	U-Nut
13230	Push-Type Retainer
16124	Tubular Type Nut
20187	Push-Type Retainer
20188	Trim Panel Retainer
20203	Push-Type Retainer
20205	Moulding Insert
20314	Push-Type Retainer
20636	Push-Type Retainer
20637	Push-Type Retainer
20638	Push-Type Retainer
20642	Door Panel Ret. Clip
20645	Carpet Retainer
20650	U-Nut
20735	Door Panel Retainer
20897	Moulding Clip
20909	Push-Type Retainer
20971	Rivet
21105	Hood Ins. Retainer

6625BHM

Nissan & Infiniti
Retainers & Push-Type Retainers
24 Varieties - 525 Pieces



Contains the following
Auveco part numbers:
**14355, 14696, 14737, 16000,
16776, 16782, 16784, 16858, 16859,
17237, 17347, 17452, 17472, 18166, 18948,
19246, 19274, 19684, 20327, 20348,
20349, 20672, 20953 & 21192**

6646BHM

Subaru
Clips & Fasteners
24 Varieties - 450 Pieces



Auveco Part No.	Description
21322	Panel Retainer
21420	Push-Type Retainer
21421	Hood Ins. Retainer
21422	Push-Type Retainer
21500	Push-Type Retainer
21501	Push-Type Retainer
21502	Panel Retainer
21530	Push-Type Retainer
21531	Cowl Panel Vent Cap
21563	Push-Type Retainer
21566	Push-Type Retainer
21570	Push-Type Retainer
21571	Push-Type Retainer
21572	Grille Clip
21574	Trim Retainer
21576	Push-Type Retainer
21580	Push-Type Retainer
21581	Moulding Clip
21584	Panel Retainer
21585	Push-Type Retainer
21591	Moulding Clip
21592	Push-Type Retainer
21593	Push-Type Retainer
21594	Push-Type Retainer

6640BHM

Volkswagen & Audi
Clips & Fasteners
24 Varieties - 595 Pieces



Auveco Part No.	Description
13173	Door Panel Clip
13475	Trim Panel Retainer
17006	Moulding Rivet
19195	Push-Type Retainer
20341	Trim Panel Retainer
20924	Screw Grommet
20925	Screw Grommet
21144	Trim Panel Retainer
21145	Hood Ins. Retainer
21251	Push-Type Retainer
21392	Cowl & Grille Retainer
21393	Trim Retainer
21394	Moulding Clip
21395	Moulding Clip
21396	Moulding Clip
21397	Moulding Clip Grommet
21398	Trim Panel Retainer
21399	Screw Grommet
21449	Moulding Clip
21478	Moulding Clip
21479	Push-Type Retainer
21512	Moulding Clip
21513	Push-On Retainer
21515	Fender & Bumper Retainer

6626BHM

Toyota & Lexus
Retainers & Retaining Clips
24 Varieties - 550 Pieces



Contains the following
Auveco part numbers:
**14269, 14736, 14737, 14738, 15709, 18297, 18692,
18842, 18844, 18876, 18878, 19112, 19113, 19210,
19257, 19729, 19749, 19842, 20437, 20443,
20633, 20757, 20758 & 21102**

6627BHM

Toyota & Lexus
Push-Type Retainers
24 Varieties - 316 Pieces



Contains the following
Auveco part numbers:
**14260, 16784, 17162, 17439,
18270, 18873, 18888, 19140,
19416, 19552, 19739, 20335,
20349, 20577, 20869, 20908,
20931, 20955, 21010, 21011,
21103, 21123, 21201 & 21294**

6647BHM

Mazda Clips & Fasteners
24 Varieties - 560 Pieces



Auveco Part No.	Description
14260	Push-Type Retainer
14274	Nylon Nut
14313	Nylon Nut
14367	Trim Panel Retainer
14695	Screw Grommet
14697	Push-Type Retainer
16000	Push-Type Retainer
16858	Push-Type Retainer
17632	Push-Type Retainer
18206	Push-Type Retainer
18458	Hood Insulation Clip
18692	Weatherstrip Retainer
18824	Trim Panel Retainer
19315	Push-Type Retainer
19481	Weatherstrip Retainer
19747	Push-Type Retainer
20465	Push-Type Retainer
20755	Push-Type Retainer
20923	Push-Type Retainer
20932	Trim Panel Retainer
20983	Trim Panel Retainer
21024	Push-Type Retainer
21171	Moulding Clip
21307	Retaining Clip

6648BHM

Mitsubishi Clips & Fasteners
24 Varieties - 520 Pieces



Auveco Part No.	Description
13932	Nylon Nut
14255	Nylon Nut
14275	Screw Grommet
14695	Screw Grommet
17195	Grille Clip
17351	Push-Type Retainer
17472	Push-Type Retainer
18951	Push-Type Retainer
19140	Push-Type Retainer
19239	Push-Type Retainer
19320	Retainer
19323	Retainer
19325	Retainer
19334	Retainer
19485	Nylon Nut
20247	Push-Type Retainer
20556	Tapping Screw
20557	Tapping Screw
20565	Grommet
20571	Retainer
20580	Push-Type Retainer
21118	Retainer
21140	Push-Type Retainer
21658	Push-Type Retainer

SMALL EMPTY DRAWERS AND CABINETS

Small cabinet and drawers with plastic inserts are made of sturdy heavy gauge steel. The kits are designed with scoop compartments and slide easily onto the cabinet slide. All items are available in unit packages. For refills, order by Auveco number on lid label.

Empty Drawers

(13-5/16" Wide x 9-1/4" Deep x 2" High)
With Locking Latch:

- 2-608: 8 Compartment
- 2-612: 12 Compartment
- 2-616: 16 Compartment
- 2-620: 20 Compartment
- 2-621: 21 Compartment
- 2-624: 24 Compartment



4-60

Empty Cabinet. Holds 4 Small Drawers.
15-1/4" Wide x 11-3/4" Deep x 11-1/4" High
Finish: Light Green Enamel
Drawer Size: 13-5/16" Wide x 9-1/4" Deep x 2" High



6-60

Cabinet & 6 Empty Small Drawers
24 Compartment Drawers with Locking Latches
15-1/4" W x 11-3/4" D x 16-3/8" H
Finish: Light Green Enamel
Drawer Size: 13-5/16" Wide x 9-1/4" Deep x 2" High

3-60

Empty Cabinet. Holds 6 Small Drawers

LARGE EMPTY DRAWERS AND CABINETS

Photos not actual size

Sec. 15



3-96

Empty Cabinet. Holds 2 Large Drawers.
20" Wide x 15-3/4" Deep x 8" High
Finish: Light Green Enamel
Drawer Size: 18" Wide x 12" Deep x 3" High



4-96

Cabinet & 4 Empty Large Drawers
24 Compartment Drawers with Locking Latches
20" Wide x 15-3/4" Deep x 14-1/2" High
Finish: Light Green Enamel
Drawer Size: 18" Wide x 12" Deep x 3" High

2-96

Empty Cabinet. Holds 4 Large Drawers
Base B-3 for cabinets 3-96, 4-96 and 2-96 is pictured on page 352



1-900

Steel with Locking Latch

18 x 12 x 3
Adjustable
Compartment
Empty Drawer with
3 Vertical &
3 Horizontal
Dividers

UNIT PACKAGE: 1

Empty Drawers

(18" Wide x 12" Deep x 3" High)

With Locking Latches:

1-912: 12 Compartment

1-916: 16 Compartment

1-920: 20 Compartment

1-924: 24 Compartment

1-932: 32 Compartment



Empty Plastic Tray Inserts

1-916INSERT: 16 Compartment for Drawer 1-916

1-920INSERT: 20 Compartment for Drawer 1-920

1-924INSERT: 24 Compartment for Drawer 1-924

UNIT PACKAGE: 1 case per insert

Only available in Master Case of 4 - Not sold separately.



1-901

Steel with Locking Latch

18 x 12 x 3
Adjustable
Compartment
Empty Drawer
with 9 dividers

UNIT PACKAGE: 1



1-901 DIVIDERS

2-15/16" x 4-5/16"
Divider
for 1-901 Drawer



1-902

Steel with Locking Latch

18 x 12 x 3
Adjustable
Compartment
Empty Drawer with
6 fixed horizontal
compartments and
12 movable
dividers adjustable
on 1" centers.

UNIT PACKAGE: 1

Photos not actual size

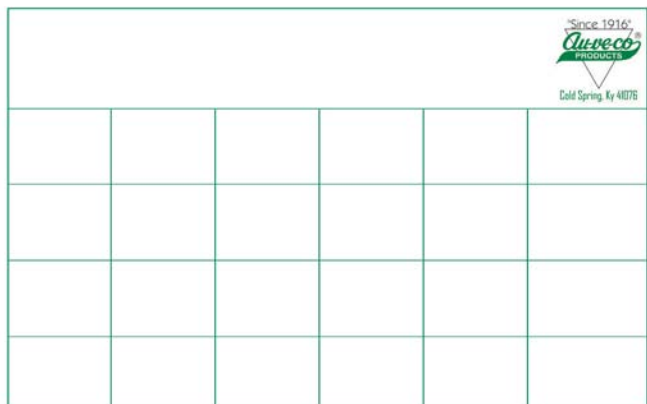

Printed lid labels in 12, 16, 20 and 24 compartment layouts (small and large drawer sizes). Same size and layout as Fix-Kit lid labels. Labels have a peel-away liner and self-adhesive backing for permanent adhesion.

Large Drawer Lid Labels

1-900L

Assortment of 1 each of 1-912L, 1-916L, 1-920L & 1-924L.

UNIT PACKAGE: 1 Set

1-912L

Large Drawer 12 Compartment Lid Label

UNIT PACKAGE: 5

1-916L

Large Drawer 16 Compartment Lid Label

UNIT PACKAGE: 5

1-920L

Large Drawer 20 Compartment Lid Label

UNIT PACKAGE: 5

1-924L

Large Drawer 24 Compartment Lid Label

UNIT PACKAGE: 5

Small Drawer Lid Labels

2-600L

Assortment of 1 each of 2-612L, 2-616L, 2-620L & 2-624L

UNIT PACKAGE: 1 Set

2-612L

Small Drawer 12 Compartment Lid Label

UNIT PACKAGE: 5

2-616L

Small Drawer 16 Compartment Lid Label

UNIT PACKAGE: 5

2-620L

Small Drawer 20 Compartment Lid Label

UNIT PACKAGE: 5

2-624L

Small Drawer 24 Compartment Lid Label

UNIT PACKAGE: 5



1-MBC

Miniature Bulb Cabinet

19" Wide x 4" Deep x 26-3/4" High
Ideal for the storage and organization of automotive miniature bulbs, fuses, etc. Features 4 durable plastic tilt-out trays with 28 adjustable dividers allowing for the creation of 4 to 32 compartments. Back-up storage shelves are located behind the hinged cover. Can be hung on wall using keyholes punched in the back. Constructed of prime cold rolled steel with gray powder coat finish.

Can be shipped via UPS



1-HTWD

Hose, Tubing and Wire Dispenser

19-9/16" Wide x 7-1/2" Deep x 11-15/16" High (front), 13-3/32" High (back)
Holds up to 6 reels of hose, tubing or wire. 1" diameter grommets in the front assure smooth, tangle free dispensing. Can be hung on wall using keyholes punched in the back. Constructed of prime cold rolled steel with gray powder coat finish.

Can be shipped via UPS

RACKS

Photos not actual size



1-WSR
Wire Spool Rack

26-1/8" Wide x 6" Deep x
37-1/8" High
Four sturdy steel rods
provide secure and
convenient storage for reels
as large as 11" in diameter.
Heavy duty steel with
enamel finish.
Does not include wire.
Weight: 20 lbs.



Can be shipped via UPS



2-WSR
Wire Spool Rack

26" Wide x 5-3/4" Deep x 18" High
Two sturdy steel rods for storing and
dispensing spools of wire.
May be counter, wall or vehicle mounted.
Shipping Weight 15 lbs.

Can be shipped via UPS



1-TR
Threaded Rod Rack

24" Wide x 6-7/8" Deep x
24-3/8" High
Separates and protects threaded rods,
in 18 separate compartments,
2-1/8" (54.0mm) in diameter.
Does not include threaded rod stock.
Heavy duty steel with enamel finish
Weight: 14 lbs.

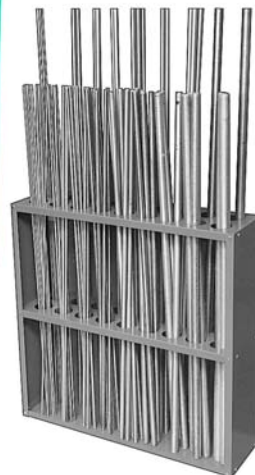

Can be shipped via UPS

Photos not actual size

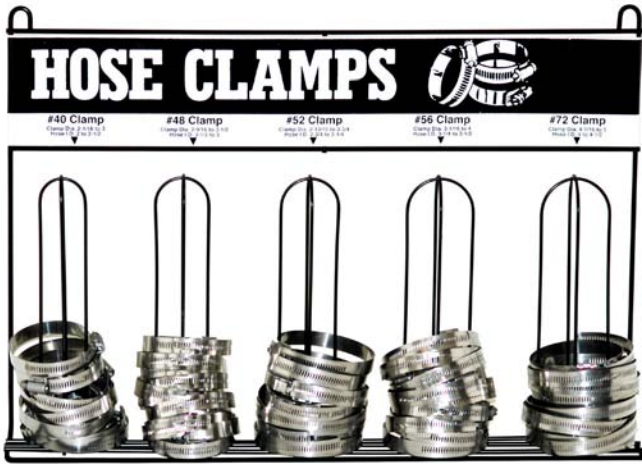

5-HCR

5 Loop Hose Clamp Rack

23-1/4" Wide x 5-3/8" Deep x 16-1/8" High
 Holds 5 sizes of clamp diameters: #40 (2-1/16" to 3"),
 #48 (2-9/16" to 3-1/2"), #52 (2-13/16" to 3-3/4"),
 #56 (3-1/16" to 4") and #72 (4-1/16" - 5").
 Can be set on counter top or hung on a wall using
 the built-in hanger loops. Durable black powder coat
 finish with black and white sign panel.

Can be shipped via UPS

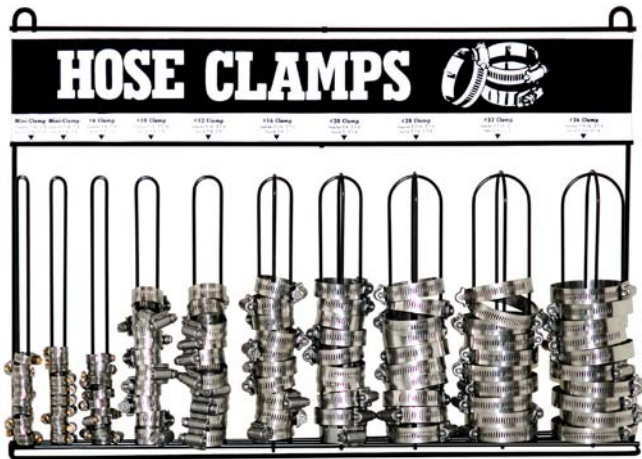

10-HCR

10 Loop Hose Clamp Rack

23-1/4" Wide x 5-3/8" Deep x 16-1/8" High
 Holds 10 sizes of clamp diameters:
 Mini-clamp (7/32" - 5/8"), Mini-clamp (5/16" - 7/8"),
 #6 (3/8" to 7/8"), #10 (9/16" to 1-1/16"),
 #12 (9/16" to 1-1/4"), #16 (11/16" to 1-1/2"),
 #20 (3/4" to 1-3/4"), #28 (1-5/16" to 2-1/4"),
 #32 (1-9/16" to 2-1/2") and #36 (1-13/16" to 2-3/4").
 Can be set on counter top or hung on a wall using
 the built-in hanger loops. Durable black powder coat
 finish with black and white sign panel.

Can be shipped via UPS



P277

40 Compartment Bin

33-3/4" Wide x 12" Deep x 24" High
 Color: green or gray enamel finish
 Packing: 1 set up unit per carton
 Shipping Weight: 47 lbs.

Can be shipped via UPS

P40-S

40 Compartment Bin

33-3/4" Wide x 9" Deep x 24" High
 Color: green enamel finish
 Packing: 1 set up unit per carton
 Shipping Weight: 38 lbs.

Can be shipped via UPS

72B-9

72 Compartment Bin

33-3/4" Wide x 9" Deep x 42" High
 Color: green enamel finish
 Packing: 1 set up in two cartons
 Shipping Weight: 75 lbs.
 (Sold as a set only)

Can be shipped via UPS

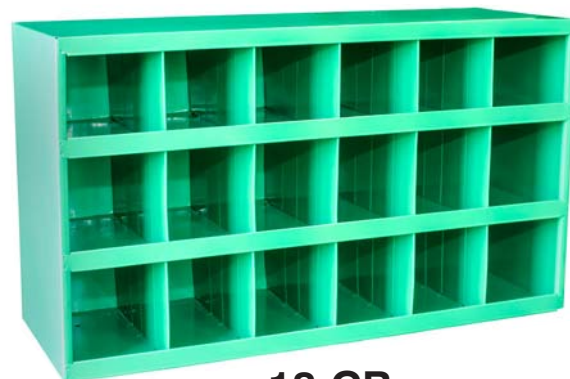

18-CB

18 Compartment Bin
 33-3/4" Wide x 12" Deep x 19-1/4" High
 Shipping Weight: 38 lbs.

Can be shipped via UPS

MB-36
Multi-Purpose Bin



23-5/8" Wide x 4-3/4" Deep x 23-5/8" High.
Removable vertical dividers allow the creation of double-width openings, each with scoops.
Keyhole slots are provided for wall mounting.
Shipping Weight: 25 lbs.

Can be shipped via UPS

Bin Bases



B-1

Base for Bins P277 & 18-D

Raises units 4 or 8 inches off the floor
Color: green enamel finish

UNIT PACKAGE: 1

Can be shipped via UPS

B-2

Base for Bin P40-S & 72B-9

Raises unit 4 or 8 inches off the floor
Color: green enamel finish

UNIT PACKAGE: 1

Can be shipped via UPS



18-D

18 Drawer Cabinet (with 36 Dividers)

34" Wide x 11-1/4" Deep x 11" High
Color: Green enamel finish
Shipping Weight: 47 lbs.

Can be shipped via UPS



9-D

9 Drawer Cabinet
(with 18 Dividers)

17-1/4" Wide x 11-5/8" Deep x 10-7/8" High
Shipping Weight 28 lbs.

Can be shipped via UPS

Dividers

For 18-D and 9-D

Plastic
2-1/2" x 5-3/16"

UNIT PACKAGE: 1



1-ACC

Aerosol Can Caddy

21-1/2" Wide x 3-1/8" Deep x 5-1/4" High
Holds 6 cans with a maximum can diameter of 3"
Holes are provided for wall mounting.

Does not include cans.
Shipping Weight: 2 lbs.

Can be shipped via UPS

Photos not actual size

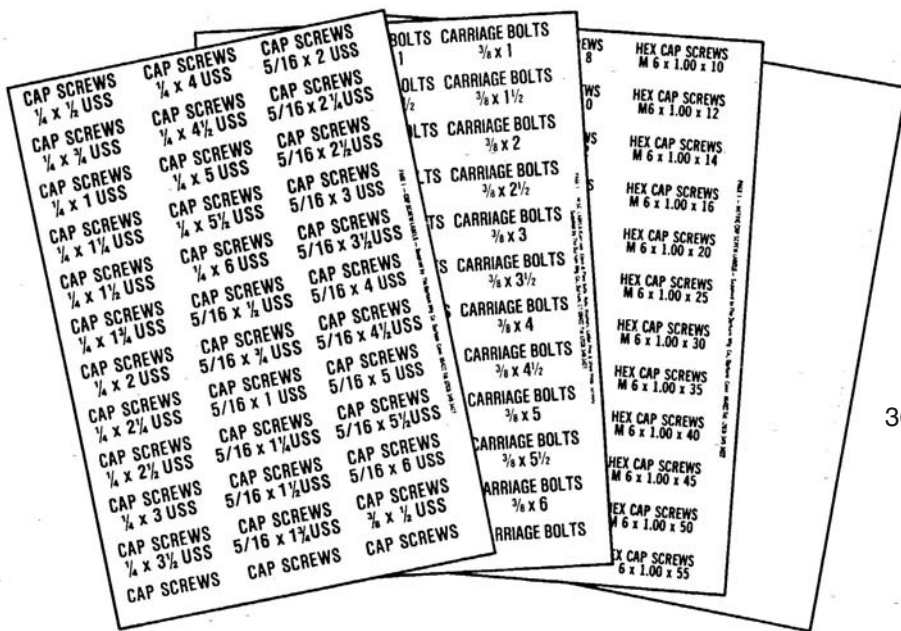

2" x 3/4" Pressure Sensitive
Bin Labels Covering
Popular Size U.S.S., S.A.E. and
Metric Fasteners.
36 Labels per each 6-1/4" x 9" page.

15531

U.S.S. Fastener Labels for Cap Screws, Nuts,
Lock Washers, Flat Washers and Blanks

Diameters: 1/4", 5/16", 3/8", 7/16", 1/2",
9/16", 5/8", 3/4", 7/8", & 1"
Lengths: 1/2" thru 6"
Total of 6 pages

UNIT PACKAGE: 1 Set

15532

S.A.E. Fastener Labels for Cap Screws, Nuts,
Lock Washers, Flat Washers and Blanks

Diameters: 1/4", 5/16", 3/8", 7/16", 1/2",
9/16", 5/8", 3/4", 7/8", & 1"
Lengths: 1/2" thru 6"
Total of 6 pages

UNIT PACKAGE: 1 Set

15533

Bin Labels Assortment
Consists of 1 set each of 15531, 15532,
14774 & 14775

UNIT PACKAGE: 1 Set

14774

Metric Fastener Labels for Hex Cap Screws
(Regular & Fine Thread), Hex Nuts, Nylon Insert
Lock Nuts, Split Lock Washers, Flat Washers, Wave
Washers, Socket Cap Screws and Socket Set Screws

Diameters: 4mm, 5mm, 6mm, 7mm, 8mm, 10mm,
12mm, 14mm, 16mm, 20mm & 24mm.
Total of 9 pages

UNIT PACKAGE: 1 Set

14775

Blank Labels
5 pages of labels to be written on with a ball point pen.

UNIT PACKAGE: 1 Set

DB-428L

Body Shop Bin Labels



Self-adhesive, pre-printed labels for 428 very
popular Auveco body shop items. These
labels are based on the contents of our
DB-428 Display Boards, which are the items
that we recommend everyone stock.

Each label measures 2-13/16" x 1"
and contains an Auveco part number,
description, OEM number, photograph
and unit package quantity. Included are 22
blank labels for future new items.
There are 15 pages in one set.

UNIT PACKAGE: 1 Set

BODY SHOP BIN ASSORTMENTS

Photos not actual size

Sec. 15



Having the right part for the job is easy with our assortments for domestic and import vehicle applications. Each assortment contains 36 of the top selling retainers and clips along with a pre-labeled Auveco MB-36 bin.

This 36 compartment bin measures 23-5/8" wide x 4-3/4" deep x 23-5/8" high. In addition to showing the Auveco part number and bar code, the labels include O.E.M. numbers as well.

Can be shipped via UPS

Domestic Vehicle "Xmas Tree" & Push-Type Retainers



1052

1 box each (1,130 pieces) of the following parts and a MB-36 bin:

10831	12909	16818
11130	13993	17216
11146	13996	17222
11612	14010	17339
12137	14020	17612
12565	14021	17664
12567	14036	18033
12571	14753	18353
12731	14992	19422
12757	15456	19639
12759	15479	20192
12766	15543	20632

1053

Same as 1052 except without MB-36 bin.

Import Vehicle Retaining Clips, Push-Type Retainers & Screw Grommets



1054

1 box each (601 pieces) of the following parts and a MB-36 bin:

14260	18877	19729
14267	18888	20247
14737	19114	20327
16000	19118	20349
16858	19194	20380
17143	19233	20440
17379	19239	20564
17472	19246	20869
17632	19274	20908
18114	19453	20931
18297	19552	20955
18873	19721	20986

1055

Same as 1054 except without MB-36 bin.

FASTENER CABINET ASSORTMENTS

Photos not actual size



Auveco offers one-price package assortments of popular U.S.S. and metric fasteners.

Each assortment contains one box each of 60 different fasteners that are all priced the same.

The assortments come in a sturdy, 5 shelf steel cabinet (15-1/2" x 32-1/2" x 4-1/4") that sits on a bench or can be wall mounted.

The assortments are shipped with the product already placed in the cabinet which is labeled with the fastener part numbers for easy re-stocking. Dimensions are clearly printed on the box labels to aid in quick selection of the proper part. All parts are available individually.

70000

U.S.S. Coarse Thread Fasteners

Contains one box each of the 60 numbers listed below. Includes cabinet.

Part No.	Size	U.P. Qty.	Part No.	Size	U.P. Qty.
GRADE 5 U.S.S. CAP SCREWS			U.S.S. HEX NUTS		
70100	1/4-20 x 1/2	27	70132	1/4-20	42
70101	1/4-20 x 3/4	23	70133	5/16-18	34
70102	1/4-20 x 1	20	70134	3/8-16	26
70103	1/4-20 x 1-1/4	17	70135	7/16-14	15
70104	1/4-20 x 1-1/2	14	70136	1/2-13	10
70105	1/4-20 x 2	10	LOCK WASHERS		
70106	5/16-18 x 3/4	17	70137	1/4"	100
70107	5/16-18 x 1	14	70138	5/16"	85
70108	5/16-18 x 1-1/4	11	70139	3/8"	50
70109	5/16-18 x 1-1/2	10	70140	7/16"	40
70110	5/16-18 x 1-3/4	9	70141	1/2"	23
70111	5/16-18 x 2	7	S.A.E. WASHERS		
70112	5/16-18 x 2-1/2	6	70142	1/4"	90
70113	5/16-18 x 3	5	70143	5/16"	80
70114	3/8-16 x 3/4	11	70144	3/8"	60
70115	3/8-16 x 1	10	70145	7/16"	50
70116	3/8-16 x 1-1/4	9	70146	1/2"	27
70117	3/8-16 x 1-1/2	7	U.S.S. WASHERS		
70118	3/8-16 x 1-3/4	7	70147	1/4"	80
70119	3/8-16 x 2	6	70148	5/16"	50
70120	3/8-16 x 2-1/4	6	70149	3/8"	40
70121	3/8-16 x 2-1/2	5	70150	7/16"	20
70122	3/8-16 x 3	4	70151	1/2"	15
70123	7/16-14 x 1	7	COTTER PINS		
70124	7/16-14 x 1-1/4	6	70152	1/16 x 1	125
70125	7/16-14 x 1-1/2	5	70153	3/32 x 1	100
70126	7/16-14 x 2	4	70154	3/32 x 1-1/2	80
70127	7/16-14 x 2-1/2	4	70155	1/8 x 1-1/2	50
70128	1/2-13 x 1-1/2	4	70156	1/8 x 2	35
70129	1/2-13 x 2	3	70157	5/32 x 1-1/2	30
70130	1/2-13 x 2-1/2	3	70158	5/32 x 2	25
70131	1/2-13 x 3	2	70159	3/16 x 2	20

71000

Metric Standard Pitch & Fine Pitch Fasteners

Contains one box each of the 60 numbers listed below. Includes cabinet.

Part No.	Size	U.P. Qty.	Part No.	Size	U.P. Qty.
STANDARD PITCH CAP SCREWS			LOCK WASHERS		
71101	M5-.80 x 12MM	25	71134	5MM	60
71102	M5-.80 x 25MM	20	71135	6MM	45
71103	M6-1.0 x 10MM	20	71136	8MM	25
71104	M6-1.0 x 12MM	20	71137	10MM	20
71105	M6-1.0 x 16MM	18	FLAT WASHERS		
71106	M6-1.0 x 20MM	17	71138	5MM	60
71107	M6-1.0 x 25MM	16	71139	6MM	50
71108	M6-1.0 x 30MM	14	71140	8MM	42
71109	M6-1.0 x 40MM	13	71141	10MM	24
71110	M6-1.0 x 45MM	11	COTTER PINS		
71111	M8-1.25 x 12MM	12	71142	2MM x 20MM	82
71112	M8-1.25 x 16MM	12	71143	3MM x 25MM	60
71113	M8-1.25 x 20MM	12	71144	5MM x 45MM	20
71114	M8-1.25 x 25MM	11	STUDS		
71115	M8-1.25 x 30MM	10	71145	M8-1.25 x 35MM	3
71116	M8-1.25 x 35MM	9	71146	M8-1.25 x 45MM	3
71117	M8-1.25 x 40MM	8	FINE PITCH CAP SCREWS		
71118	M8-1.25 x 45MM	7	71147	M8-1.0 x 40MM	6
71119	M8-1.25 x 50MM	7	71148	M8-1.0 x 50MM	5
71120	M8-1.25 x 60MM	6	71149	M10-1.0 x 30MM	4
71121	M8-1.25 x 75MM	5	71150	M10-1.0 x 50MM	3
71122	M10-1.5 x 20MM	6	71151	M10-1.25 x 20MM	5
71123	M10-1.5 x 25MM	6	71152	M10-1.25 x 25MM	4
71124	M10-1.5 x 30MM	5	71153	M10-1.25 x 30MM	4
71125	M10-1.5 x 35MM	5	71154	M10-1.25 x 35MM	4
71126	M10-1.5 x 40MM	5	71155	M10-1.25 x 40MM	3
71127	M10-1.5 x 50MM	4	71156	M10-1.25 x 50MM	3
71128	M10-1.5 x 60MM	4	71157	M10-1.25 x 60MM	2
71129	M10-1.5 x 70MM	3	FINE PITCH HEX NUTS		
STANDARD PITCH HEX NUTS			71158	M8-1.00	17
71130	M5-.80	41	71159	M10-1.00	12
71131	M6-1.0	25	71160	M10-1.25	9
71132	M8-1.25	17			
71133	M10-1.5	15			

FASTENER ASSORTMENTS

Photos not actual size

Sec. 15



Bin P40-S

Each assortment includes an Auveco 40 compartment bin P40-S (33-3/4" Wide x 9" Deep x 24" High). The reorder labels contain the fastener part number, size, description and bar code. All parts are certified to meet or exceed the proper S.A.E. specifications both physically and chemically.

Can be shipped via UPS

1020

Grade 5 U.S.S. (Coarse Thread) Fastener Assortment.

Over 2,800 pieces of Grade 5 U.S.S. cap screws, hex nuts, high alloy lock washers and high alloy S.A.E. flat washers.

Diameters: 1/4"-20, 5/16"-18, 3/8"-16, 7/16"-14 and 1/2"-13.

Lengths: 1/2" through 3".

All fasteners are zinc plated.

Refer to contents listing on next page.

1021

Same as 1020 except without P40-S bin. Includes planogram and reorder labels.

1030

Grade 8 U.S.S. (Coarse Thread) Fastener Assortment.

Over 2,000 pieces of Grade 8 U.S.S. cap screws, hex nuts, high alloy lock washers and high alloy S.A.E. flat washers.

Diameters: 1/4"-20, 5/16"-18, 3/8"-16, 7/16"-14, 1/2"-13 and 5/8"-11.

Lengths: 1/2" through 4".

All fasteners are zinc and yellow dichromate plated.

Refer to contents listing on next page.

1031

Same as 1030 except without P40-S bin. Includes planogram and reorder labels.

METRIC FASTENER ASSORTMENTS

1040

Metric Fastener (Regular Pitch) Assortment.

Over 1,200 metric cap screws, hex nuts, lock washers and flat washers.

Assortment comes with a pre-labeled Auveco 40 compartment bin, P40-S (33-3/4" Wide x 9" Deep x 24" High). The reorder labels contain the fastener part number, size, description and bar code.

Diameters: 6mm-1.00, 8mm-1.25, 10mm-1.50 and 12mm-1.75.

Lengths: 10mm through 50mm.

All fasteners are zinc plated.

Refer to contents listing on next page.

Can be shipped via UPS

1041

Same as 1040 except without P40-S Bin. Includes planogram and reorder labels.

1042

Metric Fastener (Regular & Fine Pitch) Assortment.

Over 1,995 metric cap screws, hex nuts, lock washers and flat washers.

Assortment comes with a pre-labeled Auveco 72 compartment bin, 72B-9, (33-3/4" wide x 9" deep x 42" high). The reorder labels contain the fastener part number, size, description and bar code.

Diameters: M5-.8, M6-1.0, M8-1.25, M8-1.0, M10-1.5, M10-1.25, M10-1.0 & M12-1.75.

Lengths: 10mm through 75mm.

All fasteners are zinc plated except fine pitch cap screws which have a black finish.

Refer to contents listing on following pages.

Can be shipped via UPS

1043

Same as 1042 except without 72-9 Bin. Includes planogram and reorder labels.

1020 & 1021

Grade 5 U.S.S. (Coarse Thread) Fastener Assortments. Contains 1 box each of:

5434	1/4"-20 x 1/2" Cap Screw	5480	7/16"-14 x 2" Cap Screw
5436	1/4"-20 x 3/4" Cap Screw	5488	1/2"-13 x 1-1/2" Cap Screw
5438	1/4"-20 x 1" Cap Screw	5490	1/2"-13 x 2" Cap Screw
5439	1/4"-20 x 1-1/4" Cap Screw	5491	1/2"-13 x 2-1/2" Cap Screw
5440	1/4"-20 x 1-1/2" Cap Screw	5492	1/2"-13 x 3" Cap Screw
5442	1/4"-20 x 2" Cap Screw	11925	1/4" High Alloy Lock Washer
5449	5/16"-18 x 3/4" Cap Screw	11926	5/16" High Alloy Lock Washer
5451	5/16"-18 x 1" Cap Screw	11927	3/8" High Alloy Lock Washer
5452	5/16"-18 x 1-1/4" Cap Screw	11928	7/16" High Alloy Lock Washer
5453	5/16"-18 x 1-1/2" Cap Screw	11929	1/2" High Alloy Lock Washer
5455	5/16"-18 x 2" Cap Screw	12781	1/4" High Strength SAE Washer
5463	3/8"-16 x 3/4" Cap Screw	12782	5/16" High Strength SAE Washer
5465	3/8"-16 x 1" Cap Screw	12783	3/8" High Strength SAE Washer
5466	3/8"-16 x 1-1/4" Cap Screw	12784	7/16" High Strength SAE Washer
5467	3/8"-16 x 1-1/2" Cap Screw	12785	1/2" High Strength SAE Washer
5468	3/8"-16 x 1-3/4" Cap Screw	15586	1/4"-20 Grade 5 Hex Nut
5469	3/8"-16 x 2" Cap Screw	15587	5/16"-18 Grade 5 Hex Nut
5471	3/8"-16 x 2-1/2" Cap Screw	15588	3/8"-16 Grade 5 Hex Nut
5476	7/16"-14 x 1" Cap Screw	15589	7/16"-14 Grade 5 Hex Nut
5478	7/16"-14 x 1-1/2" Cap Screw		1/2"-13 Grade 5 Hex Nut

1030 & 1031

Grade 8 U.S.S. (Coarse Thread) Fastener Assortments. Contains 1 box each of:

9118	1/4"-20 x 1/2" Cap Screw	17499	5/8"-11 x 3-1/2" Cap Screw
9119	1/4"-20 x 3/4" Cap Screw	9164	5/8"-11 x 4" Cap Screw
9120	1/4"-20 x 1" Cap Screw	11925	1/4" High Alloy Lock Washer
9122	1/4"-20 x 1-1/2" Cap Screw	11926	5/16" High Alloy Lock Washer
9128	5/16"-18 x 3/4" Cap Screw	11927	3/8" High Alloy Lock Washer
9129	5/16"-18 x 1" Cap Screw	11928	7/16" High Alloy Lock Washer
9131	5/16"-18 x 1-1/2" Cap Screw	11929	1/2" High Alloy Lock Washer
9137	3/8"-16 x 1" Cap Screw	11931	5/8" High Alloy Lock Washer
9138	3/8"-16 x 1-1/4" Cap Screw	12781	1/4" High Strength SAE Washer
9139	3/8"-16 x 1-1/2" Cap Screw	12782	5/16" High Strength SAE Washer
9140	3/8"-16 x 2" Cap Screw	12783	3/8" High Strength SAE Washer
9141	3/8"-16 x 2-1/2" Cap Screw	12784	7/16" High Strength SAE Washer
9146	7/16"-14 x 1-1/2" Cap Screw	12785	1/2" High Strength SAE Washer
9147	7/16"-14 x 2" Cap Screw	12787	5/8" High Strength SAE Washer
9153	1/2"-13 x 1-1/2" Cap Screw	15640	1/4"-20 Grade 8 Hex Nut
9155	1/2"-13 x 2" Cap Screw	15641	5/16"-18 Grade 8 Hex Nut
9156	1/2"-13 x 2-1/2" Cap Screw	15642	3/8"-16 Grade 8 Hex Nut
9157	1/2"-13 x 3" Cap Screw	15643	7/16"-14 Grade 8 Hex Nut
9161	5/8"-11 x 2" Cap Screw	15644	1/2"-13 Grade 8 Hex Nut
9163	5/8"-11 x 3" Cap Screw	15645	5/8"-11 Grade 8 Hex Nut

1040 & 1041

Metric Fastener (Regular Pitch) Assortments. Contains 1 box each of:

14584	6mm-1.00 x 10mm Cap Screw (DIN 933)	14434	10mm-1.50 x 40mm Cap Screw (DIN 931)
14407	6mm-1.00 x 12mm Cap Screw (DIN 933)	14435	10mm-1.50 x 45mm Cap Screw (DIN 931)
14408	6mm-1.00 x 16mm Cap Screw (DIN 933)	14436	10mm-1.50 x 50mm Cap Screw (DIN 931)
14409	6mm-1.00 x 20mm Cap Screw (DIN 933)	14440	12mm-1.75 x 25mm Cap Screw (DIN 933)
14410	6mm-1.00 x 25mm Cap Screw (DIN 933)	14441	12mm-1.75 x 30mm Cap Screw (DIN 933)
14411	6mm-1.00 x 30mm Cap Screw (DIN 931)	14442	12mm-1.75 x 35mm Cap Screw (DIN 933)
14412	6mm-1.00 x 35mm Cap Screw (DIN 931)	14443	12mm-1.75 x 40mm Cap Screw (DIN 933)
14413	6mm-1.00 x 40mm Cap Screw (DIN 931)	14445	12mm-1.75 x 50mm Cap Screw (DIN 931)
14419	8mm-1.25 x 16mm Cap Screw (DIN 933)	14450	6mm-1.00 Hex Nut (DIN 934)
14420	8mm-1.25 x 20mm Cap Screw (DIN 933)	14452	8mm-1.25 Hex Nut (DIN 934)
14421	8mm-1.25 x 25mm Cap Screw (DIN 933)	14454	10mm-1.50 Hex Nut (DIN 934)
14422	8mm-1.25 x 30mm Cap Screw (DIN 933)	14455	12mm-1.75 Hex Nut (DIN 934)
14423	8mm-1.25 x 35mm Cap Screw (DIN 931)	10579	6mm Flat Washer (DIN 125)
14424	8mm-1.25 x 40mm Cap Screw (DIN 931)	10581	8mm Flat Washer (DIN 125)
14425	8mm-1.25 x 45mm Cap Screw (DIN 931)	10582	10mm Flat Washer (DIN 125)
14426	8mm-1.25 x 50mm Cap Screw (DIN 931)	10583	12mm Flat Washer (DIN 125)
14430	10mm-1.50 x 20mm Cap Screw (DIN 933)	10586	6mm Lock Washer (DIN 127)
14431	10mm-1.50 x 25mm Cap Screw (DIN 933)	10588	8mm Lock Washer (DIN 127)
14432	10mm-1.50 x 30mm Cap Screw (DIN 933)	10589	10mm Lock Washer (DIN 127)
14433	10mm-1.50 x 35mm Cap Screw (DIN 933)	10590	12mm Lock Washer (DIN 127)

1042 & 1043

Metric Fastener (Regular Pitch & Fine Pitch) Assortments. Contains 1 box each of:

Cap Screw

14583	5mm-.8 x 12mm	(DIN 933)
14403	5mm-.8 x 16mm	(DIN 933)
14404	5mm-.8 x 20mm	(DIN 933)
14405	5mm-.8 x 25mm	(DIN 933)
14406	5mm-.8 x 30mm	(DIN 933)
15512	5mm-.8 x 40mm	(DIN 933)
14584	6mm-1.0 x 10mm	(DIN 933)
14407	6mm-1.0 x 12mm	(DIN 933)
14408	6mm-1.0 x 16mm	(DIN 933)
14409	6mm-1.0 x 20mm	(DIN 933)
14410	6mm-1.0 x 25mm	(DIN 933)
14411	6mm-1.0 x 30mm	(DIN 931)
14412	6mm-1.0 x 35mm	(DIN 931)
14413	6mm-1.0 x 40mm	(DIN 931)
14585	6mm-1.0 x 50mm	(DIN 931)
14588	8mm-1.25 x 12mm	(DIN 933)
14419	8mm-1.25 x 16mm	(DIN 933)
14420	8mm-1.25 x 20mm	(DIN 933)
14421	8mm-1.25 x 25mm	(DIN 933)
14422	8mm-1.25 x 30mm	(DIN 933)
14423	8mm-1.25 x 35mm	(DIN 931)
14424	8mm-1.25 x 40mm	(DIN 931)
14425	8mm-1.25 x 45mm	(DIN 931)
14426	8mm-1.25 x 50mm	(DIN 931)
14428	8mm-1.25 x 60mm	(DIN 931)
14429	8mm-1.25 x 70mm	(DIN 933)
14589	8mm-1.25 x 75mm	(DIN 931)
14430	10mm-1.5 x 20mm	(DIN 933)
14431	10mm-1.5 x 25mm	(DIN 933)
14432	10mm-1.5 x 30mm	(DIN 933)
14433	10mm-1.5 x 35mm	(DIN 933)
14434	10mm-1.5 x 40mm	(DIN 931)
14435	10mm-1.5 x 45mm	(DIN 931)
14436	10mm-1.5 x 50mm	(DIN 931)
14438	10mm-1.5 x 60mm	(DIN 931)
14439	10mm-1.5 x 70mm	(DIN 931)
14440	12mm-1.75 x 25mm	(DIN 933)
14441	12mm-1.75 x 30mm	(DIN 933)
14442	12mm-1.75 x 35mm	(DIN 933)
14443	12mm-1.75 x 40mm	(DIN 933)
14445	12mm-1.75 x 50mm	(DIN 931)
14446	12mm-1.75 x 60mm	(DIN 931)
14447	12mm-1.75 x 70mm	(DIN 931)

Hex Nut

14449	5mm-.8	(DIN 934)
14450	6mm-1.0	(DIN 934)
14452	8mm-1.25	(DIN 934)
14454	10mm-1.5	(DIN 934)
14455	12mm-1.75	(DIN 934)

Flat Washer

10578	5mm	(DIN 125)
10579	6mm	(DIN 125)
10581	8mm	(DIN 125)
10582	10mm	(DIN 125)
10583	12mm	(DIN 125)

Lock Washer

10585	5mm	(DIN 127)
10586	6mm	(DIN 127)
10588	8mm	(DIN 127)
10589	10mm	(DIN 127)
10590	12mm	(DIN 127)

Fine Cap Screw

11257	8mm-1.0 x 25mm	(DIN 961)
14604	8mm-1.0 x 50mm	(DIN 960)
14605	10mm-1.25 x 20mm	(DIN 961)
11265	10mm-1.25 x 25mm	(DIN 961)
11266	10mm-1.25 x 30mm	(DIN 961)
11267	10mm-1.25 x 35mm	(DIN 961)
11268	10mm-1.25 x 40mm	(DIN 961)
11269	10mm-1.25 x 50mm	(DIN 961)
14606	10mm-1.25 x 60mm	(DIN 961)
11262	10mm-1.0 x 30mm	(DIN 961)
11264	10mm-1.0 x 50mm	(DIN 961)

Fine Pitch Hex Nut

14453	8mm-1.0	(DIN 934)
14457	10mm-1.25	(DIN 934)
14456	10mm-1.0	(DIN 934)

Photos not actual size



Auveco offers more than 40 prepackaged Fix-Kits in the 6000 series small drawer. Each drawer measures 13-5/16" wide x 9-1/4" deep x 2" high.

Printed lid labels identify the correct Auveco part number for ordering refills.

“6000” Series Small Drawer Fix-Kit Numeric Listing

Refer to contents listing on following pages

Auveco Part No.	Description
6003	Phillips Oval Head Tapping Screws
6004	Special Tapping Screws
6007	Tubular, Flat, U & J-Nuts
6011	Round Head Machine Screws & Nuts
6038	Phillips Pan Head Tapping Screws
6043	Thread Cutting & Washer Lock Nuts
6051	Cotter Pins
6062	Plug Buttons
6065	Woodruff Keys
6070	Internal & External Lock Washers
6073	Socket Head Set Screws
6085	O-Rings
6086	Throttle Rod Clips & E-Clips
6112	Cotter Pins
6116	Internal & External Retaining Rings
6123	E-Rings
6124	Spring Pins
6125	Spring Pins

Auveco Part No.	Description
6128	Grease Fittings
6133	Insulated Closed Clamps
6144	Teks® Tapping Screws
6158	Metric Cotter Pins
6160	Metric Cap Screws & Nuts
6162	“Xmas Tree” Retainers
6164	Pushnut Bolt Retainers
6166	Body & Fender Shims
6167	Tee Connectors
6168	Hose Connectors
6172	Metric Pushnut Bolt & Push-On Retainers
6173	Solderless Terminals
6175	Solderless Terminals
6176	Thread Repair Inserts
6178	O.E.M. Electrical Terminals
6182	Phillips Washer Head Tapping Screws
6186	Oil Drain Plugs & Gaskets
6187	Metric Grease Fittings

“6000” Series/ “6500” Series Kit Cross Reference

The 6600 Series Body Hardware Master Assortments are listed on pages 324-331

6000 Kit	6500 Kit
6003	6501
6007	6502
6011	6503
6065	6504
6085	6505
6112	6506
6116	6507
6123	6058

6000 Kit	6500 Kit
6124	6509
6125	6510
6128	6511
6144	6536
6160	6513
6178	6543
6182	6530
6186	6534

"6000" SERIES SMALL DRAWER FIX-KITS

Photos not actual size

Sec. 15



6003 Fix-Kit

Phillips Oval Head Tapping Screws
Zinc & Chrome Plated
24 Varieties - 540 Pieces

Auveco Part No.	Size	Head
3069	#4 x 3/4"	
1793	#6 x 5/8"	
1794	#6 x 3/4"	
1796	#6 x 1"	
1797	#6 x 1-1/4"	
2024	#8 x 3/8"	No.6
2358	#8 x 1/2"	
2027	#8 x 1/2"	No. 6
1421	#8 x 5/8"	No. 6
1799	#8 x 3/4"	No. 6
2359	#8 x 3/4"	
1801	#8 x 1"	No. 6
1802	#8 x 1-1/8"	No. 6
2361	#8 x 1-1/4"	
1803	#8 x 1-1/4"	No. 6
2362	#8 x 1-1/2"	
1932	#8 x 1-1/2"	No. 6
1933	#8 x 1-3/4"	No. 6
1717	#10 x 3/4"	No. 8
2728	#10 x 3/4"	
1804	#10 x 1"	No. 6
1807	#10 x 1-1/8"	
2046	#10 x 1-1/2"	No. 6
2665	#10 x 2"	No. 8



6038 Fix-Kit

Phillips Pan Head Tapping Screws
Zinc Plated
20 Varieties - 1385 Pieces

Auveco Part No.	Size
3071	#4 x 1/4"
3072	#4 x 3/8"
3073	#4 x 1/2"
3074	#4 x 3/4"
3075	#4 x 1"
1935	#6 x 1/4"
1936	#6 x 3/8"
1937	#6 x 1/2"
5621	#6 x 5/8"
2364	#6 x 3/4"
3076	#6 x 1"
3077	#6 x 1-1/4"
3078	#6 x 1-1/2"
1939	#8 x 3/8"
1940	#8 x 1/2"
5625	#8 x 5/8"
2365	#8 x 3/4"
3079	#8 x 1"
3080	#8 x 1-1/4"
3081	#8 x 1-1/2"



6004 Fix-Kit

Phillips Specialty Tapping Screws
Zinc Plated
24 Varieties - 795 Pieces



Auveco Part No.	Size	Head
1936	#6 x 3/8"	
1937	#6 x 1/2"	
2364	#6 x 3/4"	
1939	#8 x 3/8"	
10642	#8 x 3/8"	
2805	#8 x 7/16"	
1940	#8 x 1/2"	
12095	#8 x 1/2"	
14859	#8 x 1/2"	
15171	#8 x 1/2"	
15172	#8 x 1/2"	
1712	#8 x 3/4"	No. 6
2365	#8 x 3/4"	
3079	#8 x 1"	
2178	#10 x 3/8"	
1943	#10 x 1/2"	
2808	#10 x 5/8"	
13709	#10 x 3/4"	
2366	#10 x 3/4"	
3082	#10 x 1"	
2367	#12 x 3/4"	
3086	#12 x 1"	
3089	#14 x 1/2"	
3090	#14 x 3/4"	



6182 Fix-Kit

Phillips Flat Top Washer Head
Tapping Screws
Black E-Coat & Zinc Plated
12 Varieties - 1790 Pieces

Auveco Part No.	Size	Plating
12950	#6 x 1/2"	Black E-Coat
12951	#6 x 3/4"	Black E-Coat
12213	#8 x 1/2"	Black E-Coat
12214	#8 x 5/8"	Black E-Coat
12215	#8 x 3/4"	Black E-Coat
12216	#8 x 1"	Black E-Coat
12217	#8 x 1-1/4"	Black E-Coat
12218	#8 x 1-1/2"	Black E-Coat
12953	#10 x 3/4"	Black E-Coat
12954	#10 x 1"	Black E-Coat
14859	#8 x 1/2"	Zinc
14861	#8 x 3/4"	Zinc

Photos not actual size

6144 Fix-Kit

Teks® Self-Drilling Screws
Phillips Pan Head
Hex Washer Head
Zinc Plated
16 Sizes - 365 Pieces



Auveco Part No.	Size	Head
9605	#8 x 1/2"	Pan
9606	#8 x 3/4"	Pan
9607	#10 x 1/2"	Pan
9608	#10 x 3/4"	Pan
11905	#12 x 1"	Pan
9611	#8 x 1/2"	Hex
9612	#8 x 3/4"	Hex
9613	#10 x 1/2"	Hex
9614	#10 x 5/8"	Hex
9615	#10 x 3/4"	Hex
9616	#10 x 1"	Hex
11911	#12 x 1"	Hex
9620	#14 x 3/4"	Hex
11914	#14 x 1"	Hex
11915	#14 x 1-1/4"	Hex
11916	#14 x 1-1/2"	Hex

6011 Fix-Kit

Slotted Round Head
Machine Screws
Zinc Plated
19 Varieties of Screws
5 Varieties of Nuts - 1110 Pieces



Auveco Part No.	Size
Nut	
727	6-32
728	8-32
729	10-32
730	10-24
731	12-24
Screw	
2530	6-32 x 1/2"
2531	6-32 x 3/4"
2532	6-32 x 1"
2533	8-32 x 1/2"
2534	8-32 x 3/4"
2535	8-32 x 1"
2536	10-32 x 1/2"
2537	10-32 x 3/4"
2538	10-32 x 1"
2539	10-32 x 1-1/4"
2540	10-32 x 1-1/2"
2541	10-24 x 1/2"
2542	10-24 x 3/4"
2543	10-24 x 1"
2544	10-24 x 1-1/4"
2545	10-24 x 1-1/2"
2546	12-24 x 1/2"
2548	12-24 x 1"
2550	12-24 x 1-1/2"

6160 Fix-Kit

Metric Regular Pitch • DIN 933
Cap Screws & Nuts
Zinc Plated
12 Varieties of Screws
4 Varieties of Nuts - 236 Pieces



Auveco Part No.	Size
Screw	
14400	M4-.7 x 16mm
14401	M4-.7 x 20mm
14402	M5-.8 x 10mm
14403	M5-.8 x 16mm
14404	M5-.8 x 20mm
14405	M5-.8 x 25mm
14408	M6-1.0 x 16mm
14409	M6-1.0 x 20mm
14410	M6-1.0 x 25mm
14420	M8-1.25 x 20mm
14421	M8-1.25 x 25mm
14422	M8-1.25 x 30mm
Nut	
14448	M4-.7
14449	M5-.8
14450	M6-1.0
14452	M8-1.25

6073 Fix-Kit

Socket Head Set Screws
47 Varieties Screws - 540 Pieces



Auveco Part No.	Size	
5366	6-32 x 1/4"	
5367	6-32 x 5/16"	
5368	6-32 x 3/8"	
5370	8-32 x 1/4"	
5371	8-32 x 5/16"	
5372	8-32 x 3/8"	
5373	8-32 x 1/2"	
Auveco Part No.	Size	
USS	SAE	Size
5374	5394	10 x 3/16"
5375	5395	10 x 1/4"
5376	5396	10 x 5/16"
5377	5397	10 x 3/8"
5378	5398	10 x 1/2"
5379	5399	1/4 x 1/4"
5380	5400	1/4 x 5/16"
5381	5401	1/4 x 3/8"
5382	5402	1/4 x 7/16"
5383	5403	1/4 x 1/2"
5384	5404	5/16 x 1/4"
5385	5405	5/16 x 5/16"
5386	5406	5/16 x 3/8"
5387	5407	5/16 x 7/16"
5388	5408	5/16 x 1/2"
5389	5409	3/8 x 5/16"
5390	5410	3/8 x 3/8"
5391	5411	3/8 x 7/16"
5392	5412	3/8 x 1/2"
5393	5413	3/8 x 5/8"

"6000" SERIES SMALL DRAWER FIX-KITS

Sec. 15

Photos not actual size



6007 Fix-Kit

Tubular, Flat, U & J Nuts
24 Varieties - 515 Pieces

Auveco Part No.	Size	Type
1903	1/4"-20	Flat
2089	#6-32	Flat
2092	#10-24	Flat
2099	1/8" Stud	Flat
2103	3/16" Stud	Flat
2105	1/4" Stud	Flat
2293	1/4"-20	U-Nut
2346	#8	J-Nut
2422	#10	U-Nut
2595	1/8" Stud	Tubular
2611	1/8" Stud	Tubular
5170	3/8"-16	J Cage
5197	#10-24	U-Nut
5586	1/4"-20	J Cage
5589	5/16"-18	J Cage
9879	#8	Spring U
9880	#8	Spring U
10064	#6	Spring U
10065	#8	Spring U
10066	#10	Spring U
10067	#14	Spring U
10666	#8	U-Nut
11292	#8	U-Nut
11429	#10	U-Nut



6186 Fix-Kit

Oil Drain Plugs & Gaskets
12 Varieties - 80 Pieces



Auveco Part No.	Size
14196	1/2"-20
18373	1/2"-20
18121	1/2"-20
	Double Oversize
15527	M12-1.25
14677	M12-1.75
18374	M12-1.75
21047	M12-1.75
14678	M14-1.5
16308	M14-1.5
19279	M14-1.5
19773	M14-1.5
15529	M18-1.5



6070 Fix-Kit

Shakeproof
Lock Washers
(External,
Internal & Countersunk)
Zinc Plated
24 Varieties - 1450 Pieces



Auveco Part No.	Size	Type
5249	#4	External
5259	#4	Internal
5250	#6	External
5260	#6	Internal
5270	#6	Countersunk
5251	#8	External
5261	#8	Internal
5271	#8	Countersunk
5252	#10	External
5262	#10	Internal
5272	#10	Countersunk
5253	#12	External
5263	#12	Internal
5254	1/4"	External
5264	1/4"	Internal
5255	5/16"	External
5265	5/16"	Internal
5256	3/8"	External
5266	3/8"	Internal
5257	7/16"	External
5267	7/16"	Internal
5258	1/2"	External
5268	1/2"	Internal
5274	1/4"	Countersunk



6043 Fix-Kit

Washer Lock Nuts
& Thread Cutting Nuts
16 Varieties - 1235 Pieces



Auveco Part No.	Size
2554	#6-32
2555	#8-32
2556	#10-32
2557	#10-24
2560	#12-24
2561	1/4"-20
2562	1/4"-20
2895	1/8" Stud
2896	3/16" Stud
2897	1/4" Stud
3403	1/8" Stud
3404	3/16" Stud
3405	1/4" Stud
8855	5/32" Stud
10733	5/16" Stud
12253	5mm Stud



6164 Fix-Kit

Pushnut Bolt Retainer
8 Sizes - 1350 Pieces

Auveco Part No.	For Bolt Diameter
16851	9/64" (#6)
10085	5/32" (#8)
16852	3/16" (#10)
10086	1/4"
10087	5/16"
9297	3/8"
9298	7/16"
9299	1/2"

Photos not actual size



6172 Fix-Kit

Metric Pushnut Bolt Retainers & Push-On Retainers
10 Sizes - 745 Pieces



Auveco Part No.	Bolt or Stud Size
12119	4.0mm Stud
12122	M5-.8
12123	M6-1.0
14980	M6-1.0
12124	M6.3-1.0
12125	M8-1.25
12259	M8-1.25
12126	M10-1.50
12260	M10-1.50
12127	M12-1.75



6086 Fix-Kit

Rod End Clips & E-Clips
16 Varieties - 560 Pieces

Auveco Part No.	Shaft Diameter	
Rod End Clips		
3609	5/32"	Right Side
3610	5/32"	Left Side
3611	3/16"	Right Side
3612	3/16"	Left Side
3613	1/4"	Right Side
3614	1/4"	Left Side
E-Clips		
3165	1/8"	
3166	3/16"	
3167	1/4"	
3824	5/16"	Small O.D.
3628	5/16"	Large O.D.
5600	3/8"	
2672	7/16"	
5602	1/2"	
5601	9/16"	
5603	5/8"	

FasTrack Web recently underwent a complete renovation.

One of it's newest features includes several pre-loaded kits used for collision repairs.

FasTrack is Auveco's body cost recovery system.

Go to www.auveco.com to learn more and start saving your body shop money



6123 Fix-Kit

E & Reinforced E-Rings
Groove Required
24 Varieties - 1500 Pieces



Auveco Part No.	Shaft Diameter	Type
8824	1/16"	E-Type
8825	3/32"	E-Type
8836	3/32"	Reinforced E
3165	1/8"	Reinforced E
8826	1/8"	E-Type
3166	3/16"	Reinforced E
8827	3/16"	E-Type
3167	1/4"	Reinforced E
8828	1/4"	E-Type
3628	5/16"	Reinforced E
3824	5/16"	E-Type
5600	3/8"	Reinforced E
8829	3/8"	E-Type
2672	7/16"	Reinforced E
8830	7/16"	E-Type
8837	1/2"	Reinforced E
5602	1/2"	E-Type
5601	9/16"	Reinforced E
5603	5/8"	E-Type
8831	3/4"	E-Type
8832	7/8"	E-Type
8833	1"	E-Type
8834	1-3/16"	E-Type
8835	1-3/8"	E-Type

6112 Fix-Kit

Hammer-lock Cotter Pins
Bright Zinc Chromate
16 Varieties - 1500 Pieces

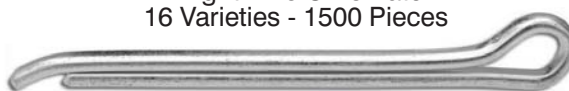

Auveco Part No.	Size
8477	1/16" x 1/2"
8478	1/16" x 3/4"
8479	1/16" x 1"
8480	1/16" x 1-1/2"
8481	3/32" x 3/4"
8482	3/32" x 1"
8484	3/32" x 1-1/2"
8485	3/32" x 2"
8486	1/8" x 1"
8487	1/8" x 1-1/4"
8488	1/8" x 1-1/2"
8490	1/8" x 2"
8491	1/8" x 1-1/2"
8492	5/32" x 1"
8493	5/32" x 1-1/2"
8494	5/32" x 2"

"6000" SERIES SMALL DRAWER FIX-KITS

Photos not actual size

Sec. 15

6051 Fix-Kit

Hammer-lock Cotter Pins
Plain Steel
18 Varieties - 2790 Pieces

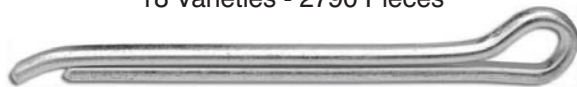

Auveco Part No.	Size
3502	1/16" x 1/2"
3503	1/16" x 3/4"
3504	1/16" x 1"
3505	1/16" x 1-1/4"
3506	1/16" x 1-1/2"
3508	1/16" x 2"
3509	3/32" x 1/2"
8481*	3/32" x 3/4"
3511	3/32" x 1"
3512	3/32" x 1-1/4"
3513	3/32" x 1-1/2"
3515	3/32" x 2"
3519	1/8" x 3/4"
3520	1/8" x 1"
3521	1/8" x 1-1/4"
3522	1/8" x 1-1/2"
8489*	1/8" x 1-3/4"
3524	1/8" x 2"

*Plated

6158 Fix-Kit

Metric Cotter Pins
12 Sizes - 580 Pieces



Auveco Part No.	Size
10553	2 x 18mm
10554	2 x 20mm
10556	2 x 25mm
10558	3 x 25mm
10559	3 x 30mm
10560	3 x 35mm
10562	4 x 30mm
10563	4 x 35mm
10564	4 x 40mm
10566	5 x 35mm
10567	5 x 40mm
10568	5 x 45mm



6116 Fix-Kit

Basic Internal &
External Rings
Zinc Plated
24 Varieties -
1000 Pieces



Auveco Part No.	Shaft Diameter
Internal Type	
8688	1/4"
8689	5/16"
8690	3/8"
8691	7/16"
8692	1/2"
8693	9/16"
8694	5/8"
8695	3/4"
8696	7/8"
8697	1"
8698	1-1/8"
8699	1-1/4"
External Type	
8701	1/4"
8702	5/16"
8703	3/8"
8704	7/16"
8705	1/2"
8706	9/16"
8707	5/8"
8708	3/4"
8709	7/8"
8710	1"
8711	1-1/8"
8712	1-1/4"



6085 Fix-Kit

Rubber O-Rings
20 Varieties - 300 Pieces

Auveco Part No.	Inside Diameter	Outside Diameter
4305	1/8"	1/4"
4306	5/32"	9/32"
4307	3/16"	5/16"
4308	7/32"	11/32"
4309	1/4"	3/8"
4310	5/16"	7/16"
4311	3/8"	1/2"
4312	3/8"	9/16"
4313	7/16"	5/8"
4314	1/2"	11/16"
4315	9/16"	3/4"
4316	5/8"	13/16"
4317	11/16"	7/8"
4318	3/4"	15/16"
4319	3/4"	1"
4320	13/16"	1-1/16"
4321	7/8"	1-1/8"
4322	15/16"	1-3/16"
4323	1"	1-1/4"
4324	1-1/16"	1-5/16"

Photos not actual size

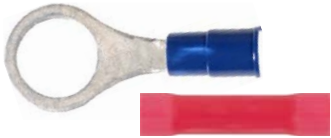

6175 Fix-Kit
Vinyl Insulated
Solderless Terminals
24 Varieties - 164 Pieces

Auveco Part No.	Gauge	Wire Size	Stud Type
5023	22-18	#8 - #10	Ring
5026	16-14	#8 - #10	Ring
5027	16-14	#12 - 1/4"	Ring
5028	12-10	#8 - #10	Ring
5029	12-10	#12 - 1/4"	Ring
5030	12-10	1/4" - 5/16"	Ring
5031	12-10	5/16" - 3/8"	Ring
5047	22-18		Butt Connector
5048	16-14		Butt Connector
5049	12-10		Butt Connector
5067	16-14		Male Quick-Connect
5068	16-14		Female Quick-Connect
8781	16-14		Female Quick-Connect
9481	18-14		Electrical Connector
10719	16-14		Female Bullet Plug
11602	16-14		Female Bullet Plug
11605	16-14		Male Quick-Connect
11606	16-14		Female Quick-Connect
12144	16-14	5/16" - 3/8"	Ring
12154	22-18		Male Quick-Connect
12155	22-18		Female Quick-Connect
12156	12-10		Male Quick-Connect
12157	12-10		Female Quick-Connect
12161	18-14		Tap Connector



6173 Fix-Kit
Insulated Solderless Terminals
24 Varieties - 128 Pieces

Auveco Part No.	Gauge	Wire Size	Stud Type
5791	22-16		Butt Connector
5792	16-14		Butt Connector
5793	12-10		Butt Connector
9052	16-14	#4 - #6	Nylon Insulated Ring
9055	16-14	#8 - #10	Nylon Insulated Ring
9056	16-14	#12 - 1/4"	Nylon Insulated Ring
9057	16-14	1/4" - 5/16"	Nylon Insulated Ring
9060	16-14	#8 - #10	Nylon Insulated Spade
9481	18-14		Electrical Connector
10719	16-14		Female Snap Plug
11602	16-14		Female Snap Plug
11605	16-14		Male Quick Slide
11606	16-14		Female Quick Slide
12145	16-14		Nylon Bullet Connector
12146	16-14		Nylon Bullet Connector
12147	18-14		Nylon Male Quick Connect
12148	16-14		Nylon Female Quick Connect
12149	22-18	#6	Nylon Insulated Ring
12150	22-18	#10	Nylon Insulated Ring
12151	12-10	#10	Nylon Insulated Ring
12152	12-10	1/4"	Nylon Insulated Ring
12153	12-10	3/8"	Nylon Insulated Ring
12161	18-14		Tap Connector
12791	22-18		Tap Connector

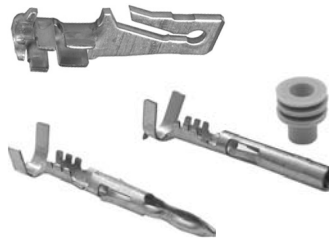

6178 Fix-Kit
O.E.M. Electrical
Terminals & Tools
GM, Ford & Chrysler
24 Varieties - 149 Pieces

Contains the following Auveco Part Numbers:
**8774, 8776, 11948, 14153, 14154 14462, 14880,
14881, 14882, 14883, 14884, 14885, 14887,
14888, 14889, 14892, 15497, 15498, 15499, 15504,
15935, 16004, 20815 & 20816**

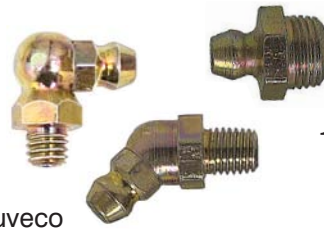

6128 Fix-Kit
Grease Fittings
12 Varieties - 145 Pieces

Auveco Part No.	Size	Type
9257	1/4" -28	Thread, Straight (Short)
9258	1/4" -28	Thread, Straight (Long)
9259	1/4" -28	Thread, Straight (Extra Long)
9260	1/4" -28	Thread, 45°
9261	1/4" -28	Thread, 90°
9262	1/8" Pipe	Thread, Straight
9264	1/8" Pipe	Thread, 45°
9265	1/8" Pipe	Thread, 65°-1/2
9266	1/8" Pipe	Thread, 90°
9267	1/8" Pipe	Thread, Straight (Extra Long)
15060	3/16"	Drive Fit, Straight
15066	1/8" Pipe	Thread, Straight (Self-Tapping)

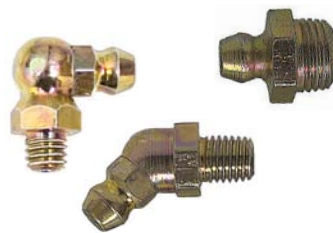

6187 Fix-Kit
Metric Grease Fittings
12 Varieties - 165 Pieces

Auveco Part No.	Size
11097	6mm-1.00, Straight
11775	6mm-1.00, 45°
11776	6mm-1.00, 90°
11098	8mm-1.00, Straight
11777	8mm-1.00, 45°
11099	8mm-1.00, 90°
11778	8mm-1.25, Straight
11779	8mm-1.25, 45°
11780	8mm-1.25, 90°
11100	10mm-1.00, Straight
15067	10mm-1.00, 45°
11101	10mm-1.00, 90°

"6000" SERIES SMALL DRAWER FIX-KITS

Sec. 15

Photos not actual size

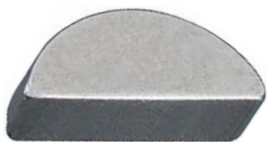

6065 Fix-Kit

Woodruff Keys
1035 Carbon Steel
20 Varieties - 383 Pieces

Auveco Part No.	Size	Key No.
3877	1/8" x 1/2"	No. 3
3878	1/8" x 5/8"	No. 5
3879	1/8" x 3/4"	No. 7
3880	3/32" x 5/8"	No. 4
3881	5/32" x 5/8"	No. 6
3882	5/32" x 3/4"	No. 8
3883	5/32" x 7/8"	No. 10
3884	3/16" x 3/4"	No. 9
3885	3/16" x 7/8"	No. 11
3886	3/16" x 1"	No. 13
3887	3/16" x 1-1/8"	No. 16
3888	7/32" x 7/8"	No. 12
3889	7/32" x 1"	No. 14
3890	7/32" x 1-1/8"	No. 17
3891	1/4" x 7/8"	No. A
3892	1/4" x 1"	No. 15
3893	1/4" x 1-1/8"	No. 18
3894	1/4" x 1-1/4"	No. 21
3895	5/16" x 1"	No. B
3896	5/16" x 1-1/8"	No. C



6125 Fix-Kit

Spring Pins
Zinc Plated
20 Varieties - 600 Pieces

Auveco Part No.	Size
9013	5/32" x 1/2"
9015	5/32" x 3/4"
9016	5/32" x 1"
9017	5/32" x 1-1/4"
9018	5/32" x 1-1/2"
9019	3/16" x 1/2"
9021	3/16" x 3/4"
9022	3/16" x 1"
9023	3/16" x 1-1/4"
9024	3/16" x 1-1/2"
9025	3/16" x 1-3/4"
9026	3/16" x 2"
9030	1/4" x 5/8"
9031	1/4" x 3/4"
9033	1/4" x 1"
9034	1/4" x 1-1/4"
9035	1/4" x 1-1/2"
9036	1/4" x 1-3/4"
9037	1/4" x 2"
9038	1/4" x 2-1/4"



6124 Fix-Kit

Spring Pins
Zinc Plated
24 Varieties - 1475 Pieces

Auveco Part No.	Size
8981	1/16" x 3/16"
8983	1/16" x 1/2"
8985	1/16" x 3/4"
8987	1/16" x 1"
8988	5/64" x 1/4"
8989	5/64" x 1/2"
8991	5/64" x 3/4"
8992	5/64" x 1"
8993	5/64" x 1-1/4"
8994	5/64" x 1-1/2"
8995	3/32" x 5/16"
8996	3/32" x 1/2"
8998	3/32" x 3/4"
9000	3/32" x 1"
9001	3/32" x 1-1/4"
9002	3/32" x 1-1/2"
9003	1/8" x 3/8"
9004	1/8" x 1/2"
9006	1/8" x 3/4"
9008	1/8" x 1"
9009	1/8" x 1-1/4"
9010	1/8" x 1-1/2"
9011	1/8" x 1-3/4"
9012	1/8" x 2"

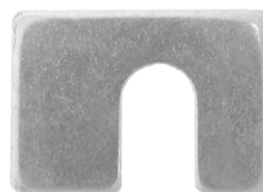

6166 Fix-Kit

Body and Fender Shims
Zinc Plated
4 Varieties - 400 Pieces

Auveco Part No.	Size	Slot
2452	1-3/4" x 1-1/4" x 1/16" Thick	1/2"
2453	1-3/4" x 1-1/4" x 1/8" Thick	1/2"
3155	1-1/4" x 1-1/8" x 1/16" Thick	3/8"
3156	1-1/4" x 1-1/8" x 1/8" Thick	3/8"



6162 Fix-Kit

"Xmas Tree" Retainers
GM-Ford-Chrysler
8 Varieties - 320 Pieces



Contains the following
Auveco Part Numbers:

10621, 11146, 11351, 11678, 11721,
11797, 12137 & 12565

Photos not actual size



6062 Fix-Kit
 Plug Buttons
 Nickel Plated
 9 Varieties - 270 Pieces

Auveco Part No.	Hole Size
3750	1/4"
3751	3/8"
3752	1/2"
3753	5/8"
3754	3/4"
3755	7/8"
3756	1"
10231	1-1/4"
10232	1-1/2"



6168 Fix-Kit
 Hose Connectors
 Barbed on all sides
 8 Sizes - 155 Pieces

Auveco Part No.	Size
10101	1/8" x 1/8"
10102	3/16" x 3/16"
10103	1/4" x 1/4"
10104	5/16" x 5/16"
10105	3/8" x 3/8"
10106	1/4" x 3/16"
10107	3/8" x 1/4"
16961	1/2" x 1/2"



6133 Fix-Kit
 Steel Tubing Clamps
 Vinyl Coated
 Galvanized
 8 Varieties - 200 Pieces

Auveco Part No.	Tube Diameter	Hole Diameter	Width
9381	1/4"	9/32"	1/2"
9382	5/16"	9/32"	1/2"
9383	3/8"	9/32"	1/2"
9384	1/2"	9/32"	1/2"
9385	5/8"	9/32"	1/2"
9386	3/4"	9/32"	1/2"
9387	7/8"	9/32"	1/2"
9388	1"	9/32"	1/2"



6167 Fix-Kit
 Tee Connectors
 Barbed on all sides
 7 Sizes - 84 Pieces

Auveco Part No.	Hose Size
10697	1/8"
10108	5/32"
10109	3/16"
10110	1/4"
14813	5/16"
11228	3/8"
11229	1/2"



6176 Fix-Kit
 Thread Repair Inserts & Installation Tool
 12 Varieties - 40 Pieces

Auveco Part No.	Internal Thread Size
12374	#10-24
12375	#10-32
12376	1/4"-20
12377	1/4"-28
12378	5/16"-18
12379	5/16"-24
12380	3/8"-16
12381	3/8"-24
12382	7/16"-14
12383	7/16"-20
12384	1/2"-13
12385	1/2"-20
12404	Installation Tools

STAY UP TO DATE WITH US

For the most up to date information on all Auveco items, including new items, stock availability and online ordering please visit www.auveco.com

LARGE DRAWER FIX-KIT

Photos not actual size

Sec. 15



3-96

Empty Cabinet. Holds 2 Large Drawers.
20" Wide x 15-3/4" Deep x 8" High
Finish: Light Green Enamel
Drawer Size: 18" Wide x 12" Deep x 3" High



Empty Plastic Tray Inserts

1-916INSERT: 16 Compartment for Drawer 1-916
1-920INSERT: 20 Compartment for Drawer 1-920
1-924INSERT: 24 Compartment for Drawer 1-924

UNIT PACKAGE: 1 case per insert
Only available in Master Case of 4 - Not sold separately.



4-96

Cabinet & 4 Empty Large Drawers
24 Compartment Drawers with Locking Latches
20" Wide x 15-3/4" Deep x 14-1/2" High
Finish: Light Green Enamel
Drawer Size: 18" Wide x 12" Deep x 3" High



1-900
Steel with Locking Latch

18 x 12 x 3 Adjustable Compartment Empty Drawer with 3 Vertical & 3 Horizontal Dividers

UNIT PACKAGE: 1

2-96

Empty Cabinet. Holds 4 Large Drawers



B-3

Base for 2-96, 3-96 & 4-96
Raises unit 15" off floor for easier bottom drawer use
Finish: Light Green Enamel

UNIT PACKAGE: 1

Empty Drawers

(18" Wide x 12" Deep x 3" High)
With Locking Latches:
1-912: 12 Compartment
1-916: 16 Compartment
1-920: 20 Compartment
1-924: 24 Compartment
1-932: 32 Compartment



1-901
Steel with Locking Latch

18 x 12 x 3 Adjustable Compartment Empty Drawer with 9 dividers

UNIT PACKAGE: 1



1-902
Steel with Locking Latch

18 x 12 x 3 Adjustable Compartment Empty Drawer with 6 fixed horizontal compartments and 12 movable dividers adjustable on 1" centers.

UNIT PACKAGE: 1

“6500” SERIES LARGE DRAWER FIX-KITS

Photos not actual size



Auveco offers more than 46 prepackaged Fix-Kits in the 6500 series large drawer.

Each drawer measures 18” wide x 12” deep x 3” high.

Each drawer’s compartment is designed to hold the entire contents of one or more standard Auveco unit packages.

Printed lid labels identify the correct Auveco part number for ordering refills.

“6500” Series Large Drawer Fix-Kit Numeric Listing

Refer to contents listing on following pages

Auveco Part No.	Description
6501	Phillips Oval Head Tapping Screws
6502	Tubular, Flat, U & J-Nuts
6503	Round Head Machine Screws & Nuts
6504	Woodruff Keys
6505	O-Rings
6506	Cotter Pins
6507	Internal & External Retaining Rings
6508	E-Rings
6509	Spring Pins
6510	Spring Pins
6511	Grease Fittings
6513	Metric Cap Screws & Nuts
6514	Metric Cap Screws & Nuts
6517	Nylon Nuts
6519	GM “Xmas Tree” Retainers
6520	Ford “Xmas Tree” Retainers
6522	“Xmas Tree” Retainers
6523	Tee Connectors & Rubber Caps
6524	Well-Nuts® & Jack Nuts®
6525	Nylon Rivets
6530	Phillips Washer Head Tapping Screws
6532	Stainless Steel Screws, Nuts & Washers
6533	Stainless Steel Tapping Screws
6534	Oil Drain Plugs
6535	Extension Springs
6536	Teks® Tapping Screws

Auveco Part No.	Description
6537	Door Hinge Pins & Bushings
6538	Cylinder Head & Manifold Studs
6539	Phillips Pan Head Machine Screws & Nuts
6540	Metric Body Bolts & Nuts
6541	Small Size U.S.S. Grade 5 Cap Screws & Nuts
6542	GM Ford & Chrysler Push-Type Retainers
6543	O.E.M. Terminals & Tools
6544	Krimp & Seal Terminals
6545	GM Moulding Clips
6546	Hyundai & Kia Clips & Fasteners
6547	Volkswagen & Audi Clips & Fasteners
6548	Honda & Acura Retainers & Retaining Clips
6549	Honda & Acura Push-Type Retainers
6550	Nissan & Infiniti Retainers & Push-Type Retainers
6551	Toyota & Lexus Retainers & Retaining Clips
6552	Toyota & Lexus Push-Type Retainers
6553	Oil Drain Plugs & Gaskets
6554	J.I.S. Hex Flange Bolts & Spin Lock Nuts
6555	Mercedes-Benz Clips & Fasteners
6556	BMW Clips & Fasteners
6557	Metal Rivets
6558	Cable Ties & Harness Straps

“6500” Series/ “6000” Series Kit Cross Reference

The 6600 Series Body Hardware Master Assortments are listed on pages 324-331

6500 Kit	6000 Kit
6501	6003
6502	6007
6503	6011
6504	6065
6505	6085
6506	6112
6507	6116
6058	6123

6500 Kit	6000 Kit
6509	6124
6510	6125
6511	6128
6513	6160
6530	6182
6534	6186
6536	6144
6543	6178

"6500" SERIES LARGE DRAWER FIX-KITS

Photos not actual size

Sec. 15



6501 Fix-Kit

Phillips Oval Head Tapping Screws
Zinc & Chrome Plated
24 Varieties - 540 Pieces

Auveco Part No.	Size	Head
3069	#4 x 3/4"	
1793	#6 x 5/8"	
1794	#6 x 3/4"	
1796	#6 x 1"	
1797	#6 x 1-1/4"	
2024	#8 x 3/8"	No.6
2358	#8 x 1/2"	
2027	#8 x 1/2"	No. 6
1421	#8 x 5/8"	No. 6
1799	#8 x 3/4"	No. 6
2359	#8 x 3/4"	
1801	#8 x 1"	No. 6
1802	#8 x 1-1/8"	No. 6
2361	#8 x 1-1/4"	
1803	#8 x 1-1/4"	No. 6
2362	#8 x 1-1/2"	
1932	#8 x 1-1/2"	No. 6
1933	#8 x 1-3/4"	No. 6
1717	#10 x 3/4"	No. 8
2728	#10 x 3/4"	
1804	#10 x 1"	No. 6
1807	#10 x 1-1/8"	
2046	#10 x 1-1/2"	No. 6
2665	#10 x 2"	No. 8



6530 Fix-Kit

Phillips Flat Top Washer
Head Tapping Screws
Black E-Coat Plated
12 Varieties - 1790 Pieces

Auveco Part No.	Size	Plating
12950	#6 x 1/2"	Black E-Coat
12951	#6 x 3/4"	Black E-Coat
12213	#8 x 1/2"	Black E-Coat
12214	#8 x 5/8"	Black E-Coat
12215	#8 x 3/4"	Black E-Coat
12216	#8 x 1"	Black E-Coat
12217	#8 x 1-1/4"	Black E-Coat
12218	#8 x 1-1/2"	Black E-Coat
12953	#10 x 3/4"	Black E-Coat
12954	#10 x 1"	Black E-Coat
14859	#8 x 1/2"	Zinc
14861	#8 x 3/4"	Zinc



6539 Fix-Kit

Phillips Pan Head
Machine Screws & Nuts
Zinc Plated
12 Varieties of Screws
4 Varieties of Nuts
2160 Pieces

Auveco Part No.	Size
Hex Nut	
728	#8-32
729	#10-32
730	#10-24
733	1/4"-20
Screw	
15381	#8-32 x 1/2"
15382	#8-32 x 3/4"
15383	#8-32 x 1"
15387	#10-24 x 1/2"
15388	#10-24 x 3/4"
15389	#10-24 x 1"
15393	#10-32 x 1/2"
15394	#10-32 x 3/4"
15395	#10-32 x 1"
15398	1/4"-20 x 1/2"
15399	1/4"-20 x 3/4"
15400	1/4"-20 x 1"

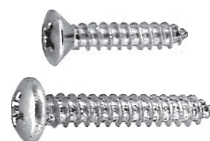

6533 Fix-Kit

Stainless Steel Phillips Head
Tapping Screws
24 Varieties - 1600 Pieces

Auveco Part No.	Size	Head
9399	#6 x 1/2"	Oval
9400	#6 x 3/4"	Oval
9401	#6 x 1"	Oval
9403	#8 x 1/2"	Oval
9404	#8 x 3/4"	Oval
9405	#8 x 1"	Oval
9406	#8 x 1-1/4"	Oval
9407	#8 x 1-1/2"	Oval
9409	#10 x 3/4"	Oval
9410	#10 x 1"	Oval
9412	#10 x 1-1/2"	Oval
13265	#6 x 1/2"	Pan
13266	#6 x 3/4"	Pan
13267	#6 x 1"	Pan
13269	#8 x 1/2"	Pan
13270	#8 x 3/4"	Pan
13271	#8 x 1"	Pan
13272	#8 x 1-1/4"	Pan
13273	#8 x 1-1/2"	Pan
13274	#10 x 1/2"	Pan
13275	#10 x 3/4"	Pan
13276	#10 x 1"	Pan
13277	#10 x 1-1/4"	Pan
13278	#10 x 1-1/2"	Pan

Photos not actual size



6503 Fix-Kit

Slotted Round Head
Machine Screws
Zinc Plated
19 Varieties of Screws
5 Varieties of Nuts
1110 Pieces

Auveco Part No.	Size
Nut	
727	#6-32
728	#8-32
729	#10-32
730	#10-24
731	#12-24
Screw	
2530	#6-32 x 1/2"
2531	#6-32 x 3/4"
2532	#6-32 x 1"
2533	#8-32 x 1/2"
2534	#8-32 x 3/4"
2535	#8-32 x 1"
2536	#10-32 x 1/2"
2537	#10-32 x 3/4"
2538	#10-32 x 1"
2539	#10-32 x 1-1/4"
2540	#10-32 x 1-1/2"
2541	#10-24 x 1/2"
2542	#10-24 x 3/4"
2543	#10-24 x 1"
2544	#10-24 x 1-1/4"
2545	#10-24 x 1-1/2"
2546	#12-24 x 1/2"
2548	#12-24 x 1"
2550	#12-24 x 1-1/2"

6536 Fix-Kit

Teks® Self-Drilling Screws
Phillips Pan Head
Hex Washer Head
Zinc Plated
16 Varieties - 365 Pieces



Auveco Part No.	Size	Head
9605	#8 x 1/2"	Pan
9606	#8 x 3/4"	Pan
9607	#10 x 1/2"	Pan
9608	#10 x 3/4"	Pan
11905	#12 x 1"	Pan
9611	#8 x 1/2"	Hex
9612	#8 x 3/4"	Hex
9613	#10 x 1/2"	Hex
9614	#10 x 5/8"	Hex
9615	#10 x 3/4"	Hex
9616	#10 x 1"	Hex
11911	#12 x 1"	Hex
9620	#14 x 3/4"	Hex
11914	#14 x 1"	Hex
11915	#14 x 1-1/4"	Hex
11916	#14 x 1-1/2"	Hex

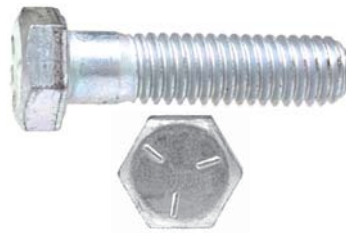

6541 Fix-Kit

U.S.S. Grade 5
Cap Screws with Nuts
Zinc Plated
12 Varieties of Screws
3 Varieties of Nuts
540 Pieces

Auveco Part No.	Size
Screw	
5434	1/4"-20 x 1/2"
5436	1/4"-20 x 3/4"
5438	1/4"-20 x 1"
5440	1/4"-20 x 1-1/2"
5449	5/16"-18 x 3/4"
5451	5/16"-18 x 1"
5453	5/16"-18 x 1-1/2"
5455	5/16"-18 x 2"
5465	3/8"-16 x 1"
5466	3/8"-16 x 1-1/4"
5467	3/8"-16 x 1-1/2"
5469	3/8"-16 x 2"
Hex Nut	
15586	1/4"-20
15587	5/16"-18
15588	3/8"-16



6514 Fix-Kit

DIN 931 & DIN 933
Metric Regular Pitch
Cap Screws & Nuts
Zinc Plated
15 Varieties - 128 Pieces

Auveco Part No.	Size
Screw	
14424	M8-1.25 x 40mm
14425	M8-1.25 x 45mm
14426	M8-1.25 x 50mm
14431	M10-1.50 x 25mm
14432	M10-1.50 x 30mm
14433	M10-1.50 x 35mm
14434	M10-1.50 x 40mm
14436	M10-1.50 x 50mm
14440	M12-1.75 x 25mm
14441	M12-1.75 x 30mm
14442	M12-1.75 x 35mm
14443	M12-1.75 x 40mm
Nut	
14452	M8-1.25
14454	M10-1.50
14455	M12-1.75

"6500" SERIES LARGE DRAWER FIX-KITS

Photos not actual size

Sec. 15



6540 Fix-Kit

Metric Body Bolts & Nuts
10 Varieties of Bolts
5 Varieties of Extruded U-Nuts
3 Varieties of Free Spinning Washer Nuts
2 Varieties of Hex Flange Nuts
254 Pieces

Auveco Part No.	Size	Type
12693	M6-1.0 x 20mm	Bolt
12324	M6-1.0 x 20mm	Bolt
12160	M6-1.0 x 22mm	Bolt
12065	M6-1.0 x 25mm	Bolt
12066	M6-1.0 x 25mm	Bolt
12335	M6-1.0 x 28mm	Bolt
17388	M8-1.25 x 20mm	Bolt
13613	M8-1.25 x 25mm	Bolt
13614	M8-1.25 x 30mm	Bolt
11641	M10-1.50 x 40mm	Bolt
11644	M8-1.25	Hex Flange Nut
11645	M10-1.5	Hex Flange Nut
12595	M6-1.0	Free Spin Washer Nut
15329	M6-1.0	Free Spin Washer Nut
15335	M8-1.25	Free Spin Washer Nut
12669	M6-1.0	Extruded U-Nut
12575	M6-1.0	Extruded U-Nut
11630	M8-1.25	Extruded U-Nut
11629	M8-1.25	Extruded U-Nut
11631	M10-1.5	Extruded U-Nut



6513 Fix-Kit

DIN 933
Metric Regular Pitch
Cap Screws & Nuts
Zinc Plated
16 Varieties - 236 Pieces

Auveco Part No.	Size
Screws	
14400	M4-.7 x 16mm
14401	M4-.7 x 20mm
14402	M5-.8 x 10mm
14403	M5-.8 x 16mm
14404	M5-.8 x 20mm
14405	M5-.8 x 25mm
14408	M6-1.0 x 16mm
14409	M6-1.0 x 20mm
14410	M6-.10 x 25mm
14420	M8-1.25 x 20mm
14421	M8-1.25 x 25mm
14422	M8-1.25 x 30mm
Nut	
14448	M4-.7
14449	M5-.8
14450	M6-1.0
14452	M8-1.25



6532 Fix-Kit

Stainless Steel Cap Screws,
Nuts & Washers
24 Varieties - 660 Pieces

Auveco Part No.	Size	Type
13346	1/4"-20 x 1/2"	Screw
13347	1/4"-20 x 3/4"	Screw
13348	1/4"-20 x 1"	Screw
13349	1/4"-20 x 1-1/4"	Screw
13350	1/4"-20 x 1-1/2"	Screw
13352	1/4"-20 x 2"	Screw
13354	5/16"-18 x 3/4"	Screw
13355	5/16"-18 x 1"	Screw
13356	5/16"-18 x 1-1/4"	Screw
13357	5/16"-18 x 1-1/2"	Screw
13359	5/16"-18 x 2"	Screw
13364	3/8"-16 x 1"	Screw
13365	3/8"-16 x 1-1/4"	Screw
13366	3/8"-16 x 1-1/2"	Screw
13368	3/8"-16 x 2"	Screw
13234	1/4"-20	Hex Nut
13235	5/16"-18	Hex Nut
13236	3/8"-16	Hex Nut
13395	Bolt Size: 1/4"	Flat Washer
13396	Bolt Size: 5/16"	Flat Washer
13397	Bolt Size: 3/8"	Flat Washer
13403	Bolt Size: 1/4"	Lock Washer
13404	Bolt Size: 5/16"	Lock Washer
13405	Bolt Size: 3/8"	Lock Washer



6554 Fix-Kit

J.I.S. Hex Flange Bolts
& Spin Lock Nuts
21 Varieties - 322 Pieces

Auveco Part No.	Size
Bolts	
17315	M6-1.0 x 12mm
17316	M6-1.0 x 16mm
18807	M6-1.0 x 20mm
21048	M6-1.0 x 25mm
18808	M6-1.0 x 30mm
18809	M6-1.0 x 40mm
18980	M8-1.25 x 12mm
17387	M8-1.25 x 16mm
17388	M8-1.25 x 20mm
21051	M8-1.25 x 25mm
17389	M8-1.25 x 30mm
21052	M8-1.25 x 35mm
17390	M8-1.25 x 40mm
21053	M8-1.25 x 45mm
17188	M10-1.25 x 16mm
17189	M10-1.25 x 20mm
21054	M10-1.25 x 25mm
17190	M10-1.25 x 30mm
21055	M10-1.25 x 35mm
17191	M10-1.25 x 40mm
21056	M10-1.25 x 45mm
Nut	
16769	M6-1.0
16830	M8-1.25
16470	M10-1.25

Photos not actual size

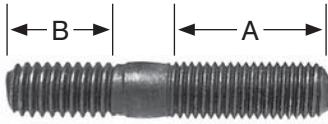

6538 Fix-Kit
Cylinder Head & Manifold Studs
24 Varieties - 120 Pieces

Auveco Part No.	Dimensions A B
9667	A: 1/4"-28 x 7/16" B: 1/4"-20 x 7/16"
9669	A: 1/4"-28 x 3/4" B: 1/4"-20 x 1/2"
9674	A: 5/16"-24 x 5/8" B: 5/16"-18 x 1/2"
9675	A: 5/16"-24 x 5/8" B: 5/16"-18 x 3/4"
9676	A: 5/16"-24 x 7/8" B: 5/16"-18 x 9/16"
9677	A: 5/16"-24 x 1" B: 5/16"-18 x 9/16"
9679	A: 5/16"-18 x 7/8" B: 5/16"-18 x 7/16"
9683	A: 3/8"-24 x 3/4" B: 3/8"-16 x 1/2"
9684	A: 3/8"-24 x 3/4" B: 3/8"-16 x 1/2"
9686	A: 3/8"-24 x 1" B: 3/8"-16 x 5/8"
9687	A: 3/8"-16 x 1-1/8" B: 3/8"-16 x 5/8"
14827	A: 3/8"-16 x 1-1/2" B: 3/8"-16 x 7/16"
9689	A: 3/8"-24 x 1" B: 3/8"-16 x 3/4"
9690	A: 3/8"-24 x 2" B: 3/8"-16 x 5/8"
9699	A: 7/16"-20 x 3/4" B: 7/16"-14 x 9/16"
9701	A: 7/16"-20 x 7/8" B: 7/16"-14 x 3/4"
9705	A: 7/16"-20 x 3/4" B: 7/16"-14 x 3/4"
9711	A: 7/16"-14 x 1-1/4" B: 7/16"-14 x 3/4"
9715	A: 7/16"-20 x 1-13/16" B: 7/16"-14 x 3/4"
9728	A: 1/2"-20 x 15/16" B: 1/2"-13 x 13/16"
9731	A: 1/2"-20 x 1" B: 1/2"-13 x 3/4"
9732	A: 1/2"-20 x 2" B: 1/2"-13 x 3/4"
11982	A: M8-1.25 x 22mm B: M8-1.25 x 10mm 40mm Overall
11983	A: M8-1.25 x 22mm B: M8-1.25 x 10mm 45mm Overall



6524 Fix-Kit
Special Purpose
Well Nuts® & Jack Nuts®
(O.E.M. Application)
GM, Ford, Chrysler & AMC
12 Varieties - 170 Pieces



Contains the following Auveco Part Numbers:
12995, 12999, 13004, 13007, 13008, 13009, 13010,
13014, 13016, 13017, 13231 & 16253



6502 Fix-Kit
Tubular, Flat, U & J-Nuts
24 Varieties - 515 Pieces

Auveco Part No.	Size	Type
1903	1/4"-20	Flat
2089	#6-32	Flat
2092	#10-24	Flat
2099	1/8" Stud	Flat
2103	3/16" Stud	Flat
2105	1/4" Stud	Flat
2293	1/4"-20	U-Nut
2346	#8	J-Nut
2422	#10	U-Nut
2595	1/8" Stud	Tubular
2611	1/8" Stud	Tubular
5170	3/8"-16	J Cage
5197	#10-24	U-Nut
5586	1/4"-20	J Cage
5589	5/16"-18	J Cage
9879	#8	Spring U
9880	#8	Spring U
10064	#6	Spring U
10065	#8	Spring U
10066	#10	Spring U
10067	#14	Spring U
10666	#8	U-Nut
11292	#8	U-Nut
11429	#10	U-Nut



6507 Fix-Kit
Basic Internal & External
Retaining Rings
Zinc Plated
24 Varieties - 1000 Pieces



Auveco Part No.	Shaft Diameter
Internal Type	
8688	1/4"
8689	5/16"
8690	3/8"
8691	7/16"
8692	1/2"
8693	9/16"
8694	5/8"
8695	3/4"
8696	7/8"
8697	1"
8698	1-1/8"
8699	1-1/4"
External Type	
8701	1/4"
8702	5/16"
8703	3/8"
8704	7/16"
8705	1/2"
8706	9/16"
8707	5/8"
8708	3/4"
8709	7/8"
8710	1"
8711	1-1/8"
8712	1-1/4"

"6500" SERIES LARGE DRAWER FIX-KITS

Photos not actual size

Sec. 15



6508 Fix-Kit
E & Reinforced E-Rings
Groove Required
24 Varieties - 1500 Pieces



Auveco Part No.	Shaft Diameter	Type
8824	1/16"	E-Type
8825	3/32"	E-Type
8836	3/32"	Reinforced E
3165	1/8"	Reinforced E
8826	1/8"	E-Type
3166	3/16"	Reinforced E
8827	3/16"	E-Type
3167	1/4"	Reinforced E
8828	1/4"	E-Type
3628	5/16"	Reinforced E
3824	5/16"	E-Type
5600	3/8"	Reinforced E
8829	3/8"	E-Type
2672	7/16"	Reinforced E
8830	7/16"	E-Type
8837	1/2"	Reinforced E
5602	1/2"	E-Type
5601	9/16"	Reinforced E
5603	5/8"	E-Type
8831	3/4"	E-Type
8832	7/8"	E-Type
8833	1"	E-Type
8834	1-3/16"	E-Type
8835	1-3/8"	E-Type

6535 Fix-Kit

Extension & Compression Springs
12 Varieties - 94 Pieces



Auveco Part No.	Length
14074	1-1/4"
14072	1-7/16"
14096	2-1/2"
14070	2-21/32"
14063	3-1/4"
14064	4"
14067	4"
14066	4-1/16"
14065	4-1/2"
14068	5-1/4"
14059	6-7/16"
14060	6-1/2"

6506 Fix-Kit

Hammer-lock Cotter Pins
Bright Zinc Chromate
16 Varieties - 1500 Pieces

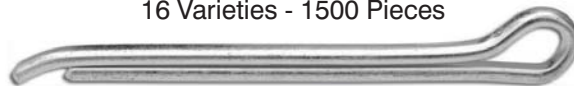

Auveco Part No.	Size
8477	1/16" x 1/2"
8478	1/16" x 3/4"
8479	1/16" x 1"
8480	1/16" x 1-1/2"
8481	3/32" x 3/4"
8482	3/32" x 1"
8484	3/32" x 1-1/2"
8485	3/32" x 2"
8486	1/8" x 1"
8487	1/8" x 1-1/4"
8488	1/8" x 1-1/2"
8490	1/8" x 2"
8491	1/8" x 2-1/2"
8492	5/32" x 1"
8493	5/32" x 1-1/2"
8494	5/32" x 2"

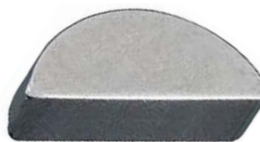

6504 Fix-Kit

Woodruff Keys
1035 Carbon Steel
20 Varieties - 383 Pieces

Auveco Part No.	Size	Key No.
3877	1/8" x 1/2"	No. 3
3878	1/8" x 5/8"	No. 5
3879	1/8" x 3/4"	No. 7
3880	3/32" x 5/8"	No. 4
3881	5/32" x 5/8"	No. 6
3882	5/32" x 3/4"	No. 8
3883	5/32" x 7/8"	No. 10
3884	3/16" x 3/4"	No. 9
3885	3/16" x 7/8"	No. 11
3886	3/16" x 1"	No. 13
3887	3/16" x 1-1/8"	No. 16
3888	7/32" x 7/8"	No. 12
3889	7/32" x 1"	No. 14
3890	7/32" x 1-1/8"	No. 17
3891	1/4" x 7/8"	No. A
3892	1/4" x 1"	No. 15
3893	1/4" x 1-1/8"	No. 18
3894	1/4" x 1-1/4"	No. 21
3895	5/16" x 1"	No. B
3896	5/16" x 1-1/8"	No. C

Photos not actual size



6510 Fix-Kit
Spring Pins
Zinc Plated
20 Varieties - 600 Pieces

Auveco Part No.	Size
9013	5/32" x 1/2"
9015	5/32" x 3/4"
9016	5/32" x 1"
9017	5/32" x 1-1/4"
9018	5/32" x 1-1/2"
9019	3/16" x 1/2"
9021	3/16" x 3/4"
9022	3/16" x 1"
9023	3/16" x 1-1/4"
9024	3/16" x 1-1/2"
9025	3/16" x 1-3/4"
9026	3/16" x 2"
9030	1/4" x 5/8"
9031	1/4" x 3/4"
9033	1/4" x 1"
9034	1/4" x 1-1/4"
9035	1/4" x 1-1/2"
9036	1/4" x 1-3/4"
9037	1/4" x 2"
9038	1/4" x 2-1/4"



6509 Fix-Kit
Spring Pins
Zinc Plated
24 Varieties - 1475 Pieces

Auveco Part No.	Size
8981	1/16" x 3/16"
8983	1/16" x 1/2"
8985	1/16" x 3/4"
8987	1/16" x 1"
8988	5/64" x 1/4"
8989	5/64" x 1/2"
8991	5/64" x 3/4"
8992	5/64" x 1"
8993	5/64" x 1-1/4"
8994	5/64" x 1-1/2"
8995	3/32" x 5/16"
8996	3/32" x 1/2"
8998	3/32" x 3/4"
9000	3/32" x 1"
9001	3/32" x 1-1/4"
9002	3/32" x 1-1/2"
9003	1/8" x 3/8"
9004	1/8" x 1/2"
9006	1/8" x 3/4"
9008	1/8" x 1"
9009	1/8" x 1-1/4"
9010	1/8" x 1-1/2"
9011	1/8" x 1-3/4"
9012	1/8" x 2"



6523 Fix-Kit
Nylon Connectors &
Rubber Caps
24 Varieties - 320 Sizes

Auveco Part No.	Size	Type
Nylon Connectors		
12929	1/8" x 1/8"	Straight
12930	1/8" x 3/16"	Straight
12936	1/8" x 1/4"	Straight
12937	3/16" x 3/16"	Straight
12935	1/4" x 3/16"	Straight
12931	1/4" x 1/4"	Straight
12946	5/16" x 5/16"	Straight
12923	1/8" x 1/8" x 1/8"	Tee
12916	1/8" x 1/8" x 3/16"	Tee
12926	3/16" x 1/8" x 3/16"	Tee
12918	3/16" x 3/16" x 3/16"	Tee
12919	1/4" x 3/16" x 3/16"	Tee
11738	1/4" x 3/16" x 1/4"	Tee
12921	3/8" x 1/4" x 3/8"	Tee
12920	5/16" x 5/16" x 5/16"	Tee
12927	3/16" x 3/16" x 3/16"	Y
12943	1/4" x 1/4" x 1/4"	Y
12932	3/16" x 3/16"	Elbow
12939	3/16"	Cross
Rubber Caps		
12209	For 1/8" O.D. Tube	
4440	For 3/16" O.D. Tube	
4439	For 1/4" O.D. Tube	
12907	For 5/16" O.D. Tube	
12210	For 3/8" O.D. Tube	



6544 Fix-Kit
Krimp & Seal Terminals
Featuring 3 - 1 Ratio
Heat Shrink Tubing
24 Varieties - 204 Pieces

Auveco Part No.	Description
13656	Ring Type, 22-18 Gauge
13657	Ring Type, 22-18 Gauge
13658	Spade Type, 22-18 Gauge
13659	Butt Conn., 22-18 Gauge
13660	Female Q.C., 22-18 Gauge
13661	Male Q.C., 22-18 Gauge
13662	Ring Type, 16-14 Gauge
13663	Ring Type, 16-14 Gauge
13664	Ring Type, 16-14 Gauge
13665	Ring Type, 16-14 Gauge
13666	Ring Type, 16-14 Gauge
13669	Butt Conn., 16-14 Gauge
13670	Female Q.C., 16-14 Gauge
13671	Male Q.C., 16-14 Gauge
13672	Female Q.C., 16-14 Gauge
13673	Male, Q.C., 16-14 Gauge
13674	Ring Type, 12-10 Gauge
13675	Ring Type, 12-10 Gauge
13676	Ring Type, 12-10 Gauge
13678	Butt Conn., 12-10 Gauge
13679	Female Q.C., 12-10 Gauge
13680	Male Q.C., 12-10 Gauge
13681	Female Plug, 16-14 Gauge
13682	Male Plug, 16-14 Gauge

"6500" SERIES LARGE DRAWER FIX-KITS

Photos not actual size

Sec. 15



6543 Fix-Kit

O.E.M. Electrical
Terminals & Tools
GM, Ford & Chrysler
24 Varieties - 263 Pieces

Contains the following Auveco Part Numbers:
**8774, 8776, 14150, 14151, 14152, 14462, 14880,
14881, 14883, 14884, 14885, 14892, 15497, 15498,
15499, 15504, 15937, 15948, 15955, 18324,
18325, 18326, 20583 & 20618**



6558 Fix-Kit

Cable Ties & Straps
10 Varieties - 339 Pieces

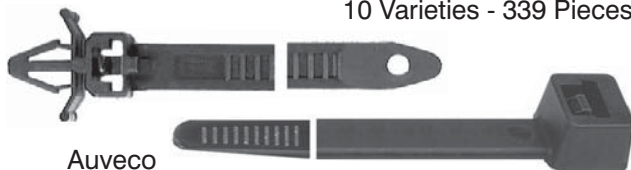

Auveco
Part No.

Size

Auveco Part No.	Size
8550	2-1/4" Long, 7/16" Wide
14298	140mm Long, 8mm Wide
15144	4" Long, 3/32" Wide
15145	5-1/2" Long, 1/8" Wide
15146	7" Long, 3/16" Wide
15147	11" Long, 3/16" Wide
15148	14" Long, 5/16" Wide
15753	14" Long, 3/16" Wide
20380	200mm Long, 5mm Wide
21203	155mm Long, 5mm Wide



6534 Fix-Kit

Oil Drain Plugs & Gaskets
12 Varieties - 86 Pieces

Auveco
Part No.

Size

Auveco Part No.	Size
14196	1/2"-20
18373	1/2"-20
18121	1/2"-20 Double Oversize
15527	M12-1.25
14677	M12-1.75
18374	M12-1.75
21047	M12-1.75
14678	M14-1.5
16308	M14-1.5
19279	M14-1.5
19773	M14-1.5
15529	M18-1.5



6553 Fix-Kit

Oil Drain Plugs &
Gaskets
24 Varieties
55 Pieces

Auveco
Part No.

Size

Auveco Part No.	Size
14196	1/2"-20
18373	1/2"-20
19130	1/2"-20
19365	1/2"-20, Magnetic
15527	M12-1.25
19588	M12-1.25
14677	M12-1.75
18023	M12-1.75
18374	M12-1.75
20347	M12-1.75
21047	M12-1.75
18024	M14-1.25
14678	M14-1.5
16308	M14-1.5
18025	M14-1.5
18375	M14-1.5
19141	M14-1.5
19279	M14-1.5
19620	M14-1.5 Single Oversize
19773	M14-1.5
20426	M14-1.5
15528	M16.4-1.33
15529	M18-1.5
15530	M20-1.5



6511 Fix-Kit

Grease Fittings
12 Varieties - 145 Pieces



Auveco
Part No.

Type

Auveco Part No.	Type
9257	1/4" - 28 Thread, Straight (Short)
9258	1/4" - 28 Thread, Straight (Long)
9259	1/4" - 28 Thread, Straight (Extra Long)
9260	1/4" - 28 Thread - 45°
9261	1/4" - 28 Thread - 90°
9262	1/8" Pipe Thread - Straight
9264	1/8" Pipe Thread - 45°
9265	1/8" Pipe Thread - 65°
9266	1/8" Pipe Thread - 90°
9267	1/8" Pipe Thread, Straight (Extra Long)
15060	3/16" Drive Fit, Straight
15066	1/8" Pipe, Straight (Self-Tapping)

Photos not actual size



6525 Fix-Kit

Black Nylon Blind Rivets
16 Varieties - 400 Pieces

Auveco Part No.	Diameter	Grip
13746	3/16"	1/16"-9/64"
13747	13/64"	1/16"-11/64"
14005	13/64"	1/8"-5/32"
13748	13/64"	1/8"-15/64"
13755	13/64"	15/64"-25/64"
14004	15/64"	11/64"-11/32"
14023	15/64"	5/32"-5/16"
18502	1/4"	5/32"-1/4"
18108	1/4"	5/32"-3/8"
13751	1/4"	5/32"-13/32"
13750	1/4"	5/32"-13/32"
15491	1/4"	19/64"-27/64"
17101	1/4"	5/16"-15/32"
13752	17/64"	3/32"-3/16"
13753	17/64"	3/32"-3/16"
15490	9/32"	3/32"-15/64"



6557 Fix-Kit

Metal Specialty Rivets
24 Varieties - 624 Pieces

Auveco Part No.	Grip
1/8" (3.2mm) Diameter	
20788	3/64" - 1/8"
20627	3/64" - 3/16"
16834	1/8" - 3/16"
8931	3/16" - 1/4"
17615	3/16" - 3/8"
5/32" (4mm) Diameter	
18461	3/64" - 1/4"
20629	3/64" - 1/4"
20971	3/64" - 9/32"
19376	1/8" - 11/32"
17006	1/4" - 3/8"
3/16" (4.8mm) Diameter	
16864	3/64" - 11/32"
20741	3/64" - 23/64"
17121	5/64" - 15/64"
8311	1/8" - 1/4"
17410	3/8" - 1/2"
14127	3/8" - 1/2"
1/4" (6.4mm) Diameter	
16837	1/32" - 9/64"
12653	3/32" - 1/8"
18167	3/32" - 9/64"
12652	1/8" - 1/4"
12655	9/64" - 3/16"
17639	3/16" - 3/8"
8313	1/4" - 3/8"
16838	33/64" - 19/32"



6505 Fix-Kit

Rubber O-Rings
20 Varieties - 300 Pieces

Auveco Part No.	Inner Diameter	Outer Diameter
4305	1/8"	1/4"
4306	5/32"	9/32"
4307	3/16"	5/16"
4308	7/32"	11/32"
4309	1/4"	3/8"
4310	5/16"	7/16"
4311	3/8"	1/2"
4312	3/8"	9/16"
4313	7/16"	5/8"
4314	1/2"	11/16"
4315	9/16"	3/4"
4316	5/8"	13/16"
4317	11/16"	7/8"
4318	3/4"	15/16"
4319	3/4"	1"
4320	13/16"	1-1/16"
4321	7/8"	1-1/8"
4322	15/16"	1-3/16"
4323	1"	1-1/4"
4324	1-1/16"	1-5/16"



6519 Fix-Kit

"Xmas Tree" Retainers
GM
12 Varieties - 500 Pieces

Contains the following
Auveco Part Numbers:

10621, 10831, 11146, 11678,
11796, 12137, 12731, 12737,
12766, 15970, 16818 & 17664



6522 Fix-Kit

"Xmas Tree" Retainers
GM, Ford & Chrysler
12 Varieties - 550 Pieces

Contains the following
Auveco Part Numbers:

10831, 11146, 11796, 12137,
12565, 12737, 12766, 12909,
16818, 17339, 17612 & 17664



6520 Fix-Kit

"Xmas Tree" Retainers
Ford
12 Varieties - 465 Pieces

Contains the following
Auveco Part Numbers:

10831, 11136, 11146, 11351,
11671, 12565, 12571, 12909,
14757, 17339, 17664 & 20192

"6500" SERIES LARGE DRAWER FIX-KITS

Photos not actual size

Sec. 15



6517 Fix-Kit

Nylon Nuts
16 Varieties - 850 Pieces

Contains the following Auveco Part Numbers:
2625, 3682, 5228, 8435, 9829, 9851, 9862,
10330, 11368, 11691, 11719, 11838, 11855,
13450, 13933 & 18816



6545 Fix-Kit

GM Moulding Clips
24 Varieties
234 Pieces

Contains the following Auveco Part Numbers:
10617, 14642, 19757, 19800, 19820, 19821, 19822,
20280, 20318, 20328, 20353, 20377, 20607, 20756,
20774, 20808, 20865, 20884, 20934, 20952,
20972, 20976, 21128 & 21374



6556 Fix-Kit

BMW Clips &
Fasteners
14 Varieties
416 Pieces

Auveco
Part No.

Description

13158	Moulding Clip
13162	U-Nut
13215	U-Nut
13216	U-Nut
13218	U-Nut
13223	U-Nut
18156	M4.8-1.59 x 16mm L.P. Screw
20186	Grommet
20234	Push-Type Retainer
20248	Push-Type Retainer
20253	Trim Panel Retainer
20270	Push-Type Retainer
20734	Push-Type Retainer
20754	Nylon Rivet



6542 Fix-Kit

GM, Ford & Chrysler
Push-Type Retainers
11 Varieties - 325 Pieces

Contains the following
Auveco Part Numbers:
20826, 20880, 20888, 20889, 20988, 20989,
20990, 20991, 20992, 20993 & 20994



6548 Fix-Kit

Honda & Acura
Retainers & Retaining Clips
24 Varieties - 404 Pieces

Contains the following Auveco part numbers:
14289, 14291, 14328, 15998, 16775, 16776, 16779,
17205, 18114, 18294, 18746, 18877, 19114, 19116,
19145, 19171, 19470, 19506, 19682, 20334,
20609, 20610, 20882 & 21107



6549 Fix-Kit

Honda & Acura
Push-Type Retainers
24 Varieties - 254 Pieces

Contains the following
Auveco part numbers:
14696, 14697, 16000, 16782, 17057,
17143, 17144, 17267, 17379, 18119, 19118,
19140, 19231, 19233, 19239, 19416, 19453, 20247,
20352, 20564, 20608, 20986, 21173 & 21297

6537 Fix-Kit

Door Hinge Pins & Bushings
15 Varieties - 221 Pieces



Bushings
14548, 14549, 14550, 14551,
14552, 14553, 16936, 16937, 17167 & 17434



Pins
14559, 19183, 19424 & 19781



6546 Fix-Kit

Hyundai & Kia
Clips & Fasteners
20 Varieties
375 Pieces

Auveco
Part No.

Description

20543	Hood Insulation Retainer
20566	Moulding Clip
20567	Moulding Clip
20568	Moulding Clip
20680	M6-1.0 L.P. Screw
21064	Moulding Clip
21067	Bumper & Grille Retainer
21068	Nylon Nut
21070	Trim Panel Retainer
21136	Moulding Clip
21146	Push-Type Retainer
21188	Trim Panel Retainer
21244	Moulding Clip
21312	Moulding Clip
21321	Moulding Clip
21328	Push-Type Retainer
21360	Trim Panel Retainer
21378	Nylon U-Nut
21381	Hood Seal Retainer
21382	Cowl Vent & Grille Retainer

Photos not actual size



6555 Fix-Kit

Mercedes-Benz
Clips & Fasteners
24 Varieties - 488 Pieces

Auveco Part No.	Description
13215	U-Nut
13216	U-Nut
13218	U-Nut
13220	U-Nut
13223	U-Nut
13224	U-Nut
13230	Push-Type Retainer
16124	Tubular Type Nut
20187	Push-Type Retainer
20188	Trim Panel Retainer
20203	Push-Type Retainer
20205	Moulding Insert
20314	Push-Type Retainer
20636	Push-Type Retainer
20637	Push-Type Retainer
20638	Push-Type Retainer
20642	Door Panel Retainer Clip
20645	Carpet Retainer
20650	U-Nut
20735	Door Panel Retainer
20897	Moulding Clip
20909	Push-Type Retainer
20971	Rivet
21105	Hood Insulation Retainer



6550 Fix-Kit

Nissan & Infiniti
Retainers &
Push-Type Retainers
24 Varieties - 369 Pieces

Contains the following
Auveco part numbers:

14355, 14696, 14737, 16000, 16776, 16782, 16784,
16858, 16859, 17237, 17347, 17452, 17472, 18166,
18948, 19246, 19274, 19684, 20327, 20348,
20349, 20672, 20953 & 21192



6551 Fix-Kit

Toyota & Lexus
Retainers
& Retaining Clips
24 Varieties - 361 Pieces

Contains the following
Auveco part numbers:

14269, 14736, 14737, 14738, 15709, 18297, 18692,
18842, 18844, 18876, 18878, 19112, 19113, 19210,
19257, 19729, 19749, 19842, 20437, 20443,
20633, 20757, 20758 & 21102



6552 Fix-Kit

Toyota & Lexus
Push-Type Retainers
24 Varieties - 229 Pieces

Contains the following
Auveco part numbers:

14260, 16784, 17162, 17439,
18270, 18873, 18888, 19140, 19416, 19552,
19739, 20335, 20349, 20577, 20869, 20908, 20931,
20955, 21010, 21011, 21103, 21123, 21201 & 21294



6547 Fix-Kit

Volkswagen & Audi
Clips &
Fasteners
24 Varieties
385 Pieces

Auveco Part No.	Description
13173	Door Panel Clip
13475	Trim Panel Retainer
17006	Moulding Rivet
19195	Push-Type Retainer
20341	Trim Panel Retainer
20924	Screw Grommet
20925	Screw Grommet
21144	Trim Panel Retainer
21145	Hood Insulation Retainer
21251	Push-Type Retainer
21392	Cowl Vent & Grille Retainer
21393	Trim Retainer
21394	Moulding Clip
21395	Moulding Clip
21396	Moulding Clip
21397	Moulding Clip Grommet
21398	Trim Panel Retainer
21399	Screw Grommet
21449	Moulding Clip
21478	Moulding Clip
21479	Push-Type Retainer
21512	Moulding Clip
21513	Push-On Retainer
21515	Fender & Bumper Retainer

Photos not actual size



A Great Marketing Concept for New or Existing Accounts

Looking to provide more variety of coverage and be sure that there is enough product to finish the job, Quik-Select II is your answer.

Auveco's Quik-Select II features a polypropylene box that's larger than our 6800 series Quik-Select assortments. It also has a larger variety of parts in each assortment and a greater number of each part per compartment.

The assortments come in 12, 18 and 24 compartment, translucent, durable polypropylene boxes. Box lid labels have O.E.M. numbers, sizes, product pictures, code 128 barcodes and Auveco part numbers for ordering refills.

"6900" Series Quik-Select II Numeric Listing

Refer to contents listing on following pages

Auveco Part No.	Description
6901	GM Retainers
6902	Ford Retainers
6903	Chrysler Retainers
6904	GM Push-Type Retainers
6905	Ford Push-Type Retainers
6906	Chrysler Push-Type Retainers
6907	GM Nylon Nuts
6908	Ford Nylon Nuts
6910	Toyota & Lexus Retainers & Retaining Clips
6911	Honda & Acura Retainers & Retaining Clips
6912	Nissan & Infiniti Retainers & Retaining Clips
6913	Toyota & Lexus Push-Type Retainers
6914	Honda & Acura Push-Type Retainers
6915	Nissan & Infiniti Push-Type Retainers
6916	Toyota & Lexus Nylon Nuts & Screw Grommets
6917	Honda & Acura Nylon Nuts & Screw Grommets
6918	Nissan & Infiniti Nylon Nuts & Screw Grommets

Auveco Part No.	Description
6919	GM, Ford & Chrysler Push-Type Retainers
6920	Black Tapping Screws
6921	Teks® Screws
6923	Extruded U-Nuts
6924	Washer Lock Nuts, Thread Cutting Nuts, Push-On & Pushnut Retainers
6929	Rubber & Vinyl Vacuum Caps
6930	Nylon Connectors
6931	Oil Drain Plug Gaskets
6933	Rubber Grommets
6934	Door Lock Rod Clips
6935	BMW Clips & Fasteners
6936	Mercedes-Benz Clips & Fasteners
6937	Hyundai & Kia Clips & Fasteners
6938	Weatherstrip & Trim Panel Retainers
6939	Rocker Panel & Moulding Clips
6940	Asian Bumper Retainers
6941	Import Fender Retainers
6942	Ford F-150 Clips & Fasteners

Empty Compartment Boxes



Translucent Durable Polypropylene Boxes with Locking Tabs
13-1/16" Wide x 8-13/16" Deep x 2-1/4" High

12 Compartment Box

69-12: UNIT PACKAGE: 1
69-112: UNIT PACKAGE: 10

18 Compartment Box

69-18: UNIT PACKAGE: 1
69-118: UNIT PACKAGE: 10

24 Compartment Box

69-24: UNIT PACKAGE: 1
69-124: UNIT PACKAGE: 10

Quik-Select II Rack



69-RACK

Empty Cabinet: Holds 5 Quik-Select II Assortments.
13-1/2" Wide x 9-1/8" Deep x 13-1/4" High
Finish: Gray Enamel
Keyhole slots are furnished for wall mounting.
A handle is provided and bolt holes permits stacking.

UNIT PACKAGE: 1

Photos not actual size



6920
Black Tapping Screws
24 Varieties - 490 Pieces

Auveco
Part No.

Size

Black Oxide Phillips Oval Head

12897	#4 x 1"
12796	#6 x 3/4"
10162	#8 x 1/2" with #6 HD
10164	#8 x 3/4" with #6 HD
10165	#8 x 3/4"
10166	#8 x 1" with #6 HD
10167	#8 x 1"

Black Oxide Phillips Pan Head

11917	#6 x 1/2"
10180	#8 x 1/2"
10181	#8 x 3/4"
10182	#8 x 1"
12799	#8 x 1-1/2"
11921	#10 x 1/2"
11922	#10 x 3/4"
11923	#10 x 1"

Black E-Coat Phillips Flat Washer Head

12213	#8 x 1/2"
12214	#8 x 5/8"
12215	#8 x 3/4"
12216	#8 x 1"
12217	#8 x 1-1/4"
12218	#8 x 1-1/2"
12953	#10 x 3/4"
12954	#10 x 1"

Black Phosphate Phillips Pan Head Sems®

12820	#8 x 3/4"
-------	-----------



6923
Extruded U-Nuts
18 Varieties - 125 Pieces

Auveco
Part No.

Size

Center of
Hole to Edge

10048	#8-32	3/8"
15677	#10-24	15/32"
8359	1/4"-20	17/32"
10051	1/4"-20	25/32"
10053	5/16"-18	9/16"
8814	5/16"-18	27/32"
10054	3/8"-16	3/4"
10055	3/8"-16	1-1/8"
11625	M4-7	13.5mm
11626	M5-8	15.8mm
16846	M6-1.0	12mm
16842	M6-1.0	13.5mm
12669	M6-1.0	13.5mm
12575	M6-1.0	19.5mm
11628	M6.3-1.0	13.5mm
11629	M8-1.25	14.5mm
11630	M8-1.25	20mm
11631	M10-1.5	19mm



6921
Teks® Screws
18 Varieties - 520 Pieces



Auveco
Part No.

Size

Phillips Pan Head

9605	#8 x 1/2"
9606	#8 x 3/4"
9608	#10 x 3/4"

Hex Washer Head

9611	#8 x 1/2"
9612	#8 x 3/4"
9613	#10 x 1/2"
9615	#10 x 3/4"
9616	#10 x 1"
11911	#12 x 1"
11914	#14 x 1"

Specialty Screws

12095	#8 x 1/2"
15172	#8 x 1/2"
15774	#8 x 1/2"
17460	#8 x 3/4"
17650	#8 x 3/4"
18261	M4.2-1.41 x 16mm
15775	M4.2-1.41 x 20mm
19006	M4.2-1.41 x 25mm



6929
Vacuum Caps
12 Varieties - 332 Pieces



Auveco
Part No.

Size

Rubber Vacuum Caps

12209	Fits 1/8" O.D. Tube
4440	Fits 3/16" O.D. Tube
4439	Fits 1/4" O.D. Tube
19001	Fits 1/4" O.D. Tube
12907	Fits 5/16" O.D. Tube
19002	Fits 5/16" O.D. Tube
12210	Fits 3/8" O.D. Tube
12908	Fits 1/2" O.D. Tube

Vinyl Vacuum Caps

18202	Fits 3/16" O.D. Tube
18203	Fits 1/4" O.D. Tube
18204	Fits 5/16" O.D. Tube
18205	Fits 3/8" O.D. Tube

"6900" SERIES QUIK-SELECT II ASSORTMENTS

Sec. 15

Photos not actual size



6924
Washer Lock Nuts,
Thread Cutting Nuts,
Push-On Retainers &
Pushnut Bolt Retainers
24 Varieties - 489 Pieces

Auveco Part No.	Size
Thread Cutting Nuts	
12253	5mm Stud Size
3403	1/8" Stud Size
3404	3/16" Stud Size
2896	3/16" Stud Size
2897	1/4" Stud Size
3405	1/4" Stud Size
10733	5/16" Stud Size
Washer Lock Nuts	
2557	#10-24 1/2 O.D.
2558	#10-24 3/4 O.D.
Push-On Retainers	
8863	1/8" Stud Size
8864	5/32" Stud Size
8865	3/16" Stud Size
8868	1/4" Stud Size
8869	5/16" Stud Size
10374	3/8" Stud Size
Pushnut Bolt Retainers	
10086	1/4" Bolt Size
10087	5/16" Bolt Size
9297	3/8" Bolt Size
9299	1/2" Bolt Size
12122	M5-.8 Bolt Size
12123	M6-1.0 Bolt Size
12125	M8-1.25 Bolt Size
12127	M12-1.75 Bolt Size
14980	M14-2.0 Bolt Size



6931
Oil Drain Plug Gaskets
18 Varieties
153 Pieces



Auveco Part No.	Size	Type
8277	1/2"	Nylon
15918	1/2"	Copper
15919	9/16"	Copper
16026	1/2"	Steel & Rubber
16682	14mm	Black Fibre
16955	18mm	Aluminum
16956	14mm	Aluminum
16996	1/2"	Nylon
17261	12mm	Copper
17262	14mm	Copper
17264	18mm	Copper
17265	20mm	Copper
18299	14mm	Steel & Rubber
18665	11mm	Rubber
18726	12mm	Black Fibre
19601	12mm	Aluminum
19630	11mm	Rubber
20453	13mm	Rubber

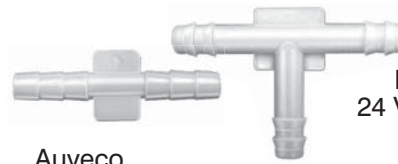

6930
Nylon Connectors
24 Varieties - 215 Pieces

Auveco Part No.	Size	Type
10101	1/8" x 1/8"	Straight
12929	1/8" x 1/8"	Straight
12930	1/8" x 3/16"	Straight
12936	1/8" x 1/4"	Straight
10102	3/16" x 3/16"	Straight
12937	3/16" x 3/16"	Straight
10103	1/4" x 1/4"	Straight
12935	3/16" x 1/4"	Straight
12931	1/4" x 1/4"	Straight
10104	5/16" x 5/16"	Straight
12946	5/16" x 5/16"	Straight
10105	3/8" x 3/8"	Straight
12923	1/8" x 1/8" x 1/8"	Tee
10108	5/32" x 5/32" x 5/32"	Tee
12926	3/16" x 1/8" x 3/16"	Tee
10109	3/16" x 3/16" x 3/16"	Tee
12918	3/16" x 3/16" x 3/16"	Tee
12919	1/4" x 3/16" x 3/16"	Tee
10110	1/4" x 1/4" x 1/4"	Tee
12921	3/8" x 1/4" x 3/8"	Tee
12920	5/16" x 5/16" x 5/16"	Tee
11228	3/8" x 3/8" x 3/8"	Tee
12927	3/16" x 3/16" x 3/16"	Y
12932	3/16" x 3/16"	Elbow



6933
Rubber Grommets
24 Varieties - 252 Pieces

Auveco Part No.	Bore Diameter	Width
4408	1/8"	3/32"
4410	5/32"	1/16"
4413	3/16"	1/16"
4414	3/16"	3/32"
4415	3/16"	1/4"
16454	1/4"	1/16"
4417	1/4"	1/16"
4419	5/16"	1/16"
4420	5/16"	1/16"
4421	5/16"	1/8"
4422	5/16"	1/4"
4423	3/8"	1/16"
16456	3/8"	1/16"
4425	3/8"	1/16"
4426	3/8"	1/4"
4428	1/2"	3/32"
4429	1/2"	3/32"
16458	1/2"	1/8"
4430	1/2"	1/4"
4431	5/8"	1/8"
4432	5/8"	1/16"
4433	3/4"	1/16"
4434	3/4"	1/16"
4436	3/4"	1/4"

Photos not actual size



6901

GM Retainers
18 Varieties - 373 Pieces

Contains the following
Auveco part numbers:

10831, 11130, 11146, 11612, 11796, 12137,
12731, 12737, 12759, 12766, 12992, 14036, 15456,
15543, 15970, 16818, 17664 & 17975



6904

GM Push-Type Retainers
18 Varieties - 233 Pieces

Contains the following
Auveco part numbers:

12567, 12757, 13993, 13994, 13996,
14010, 14011, 14020, 14753, 14997, 15044,
16622, 16835, 17216, 17222, 18353, 19639 & 19801



6902

Ford Retainers
18 Varieties - 350 Pieces

Contains the following
Auveco part numbers:

10831, 11136, 11146, 11351,
11612, 11671, 12565, 12571,
12909, 13470, 14021, 14163, 15479,
17339, 17612, 17664, 19655 & 20192



6903

Chrysler Retainers
18 Varieties - 338 Pieces

Contains the following
Auveco part numbers:

10831, 11129, 11136, 11146, 11351, 11678,
14921, 15481, 15543, 16818, 17004, 17612,
17664, 17975, 18033, 18862, 18915 & 19386



6905

Ford Push-Type Retainers
12 Varieties - 219 Pieces

Contains the following
Auveco part numbers:

13994, 14018, 14019, 14020,
14753, 14953, 14991, 14992,
14994, 17103, 17216 & 18894



6906

Chrysler Push-Type Retainers
12 Varieties - 205 Pieces

Contains the following
Auveco part numbers:

11699, 11704, 12567, 13993,
14016, 14019, 14992, 16835,
17216, 18030, 18269 & 19422



6919

GM, Ford & Chrysler
Push-Type Retainers
11 Varieties - 215 Pieces

Contains the following
Auveco part numbers:

20826, 20880, 20888, 20889,
20988, 20989, 20990, 20991,
20992, 20993 & 20994



6942

Ford F-150 (Aluminum Body)
Clips & Fasteners
17 Varieties - 167 Pieces



Contains the following
Auveco part numbers:

11146, 17664, 19338, 19801, 20530, 20766,
20880, 20889, 21169, 21286, 21703, 22023,
22058, 22066, 22067, 22154 & 22180



6934

Door Lock Rod Clips
18 Varieties - 152 Pieces



Contains the following Auveco part numbers:
10262, 14359, 14365, 14967, 15518, 15673, 15674,
15675, 15759, 17122, 18392, 18393, 18926, 19658,
20469, 20470, 20534 & 20535



6914

Honda & Acura
Push-Type Retainers
18 Varieties - 163 Pieces



Contains the following
Auveco part numbers:

14696, 14697, 14698, 16000, 16782,
17057, 17143, 17144, 17267, 17379, 18119,
19118, 19140, 19233, 19239, 19453, 20247 & 20564



6907

GM Nylon Nuts
12 Varieties - 480 Pieces



Contains the following Auveco part numbers:
3682, 8435, 9829, 11424, 11691, 11719, 11838,
12735, 13450, 13933, 13960 & 14031

"6900" SERIES QUIK-SELECT II ASSORTMENTS

Photos not actual size

Sec. 15



6935
BMW Clips & Fasteners
12 Varieties
212 Pieces

Auveco Part No.	Description
13158	Moulding Clip
13162	U-Nut
13215	U-Nut
13218	U-Nut
13223	U-Nut
18156	License Plate Screw M4.8 X 16mm
20234	Nylon Rivet
20248	Push -Type Retainer
20253	Trim Panel Retainer
20270	Push -Type Retainer
20734	Push -Type Retainer
20754	Nylon Rivet



6917
Honda & Acura
Nylon Nuts & Screw Grommets
12 Varieties - 224 Pieces



Contains the following Auveco part numbers:
**14255, 14268, 14274, 14281, 14288, 14313, 14695,
17058, 18415, 19454, 19734 & 19741**



6908
Ford Nylon Nuts
12 Varieties - 310 Pieces



Contains the following Auveco part numbers:
**9862, 11368, 11841, 12569, 14754, 14755, 14756,
18816, 19277, 19326, 19783 & 20245**



6911
Honda & Acura
Retainers & Retaining Clips
24 Varieties - 334 Pieces



Contains the following Auveco part numbers:
**14282, 14289, 14291, 14328, 15998, 16775, 16776,
16779, 17205, 18114, 18294, 18746, 18818, 18877,
19114, 19116, 19145, 19171, 19470, 19483,
19506, 19682, 20334 & 20609**



6937
Hyundai & Kia
Clips & Fasteners
18 Varieties
114 Pieces

Auveco Part No.	Description
20543	Hood Insulation Retainer
20566	Moulding Clip
20567	Moulding Clip
20568	Moulding Clip
20680	M6-1.0 L. P. Screw
21064	Moulding Clip
21067	Bumper & Grille Retainer
21068	Nylon Nut
21070	Trim Panel Retainer
21136	Moulding Clip
21146	Push-Type Retainer
21188	Trim Panel Retainer
21244	Moulding Clip
21312	Moulding Clip
21321	Moulding Clip
21328	Push-Type Retainer
21378	Nylon U-Nut
21382	Cowl Vent & Grille Retainer



6936
Mercedes-Benz
Clips & Fasteners
24 Varieties
106 Pieces

Auveco Part No.	Description
13215	U-Nut
13216	U-Nut
13218	U-Nut
13220	U-Nut
13223	U-Nut
13224	U-Nut
13230	Push-Type Retainer
16124	Tubular Type Nut
20187	Push-Type Retainer
20188	Trim Panel Retainer
20203	Push-Type Retainer
20205	Moulding Insert
20314	Push-Type Retainer
20636	Push-Type Retainer
20637	Push-Type Retainer
20638	Push-Type Retainer
20642	Door Panel Retainer Clip
20645	Carpet Retainer
20650	U-Nut
20735	Door Panel Retainer
20897	Moulding Clip
20909	Push-Type Retainer
20971	Rivet
21105	Hood Insulation Retainer

Photos not actual size



6910
Toyota & Lexus
Retainers & Retaining Clips
24 Varieties - 280 Pieces

Contains the following Auveco part numbers:
14144, 14269, 14270, 14736, 14737, 14738, 15707,
15709, 16779, 18297, 18692, 18842, 18844, 18876,
18878, 19112, 19113, 19124, 19210, 19257,
19729, 19749, 19842 & 20443



6938
Weatherstrip &
Trim Panel Retainers
23 Varieties - 315 Pieces

Contains the following Auveco part numbers:
11796, 12565, 12992, 14269, 14328, 14921, 17669,
18033, 18353, 18848, 18877, 19171, 19386, 19850,
20563, 21102, 21334, 21705, 21707, 21795,
21822, 22027 & 22107



6912
Nissan & Infiniti
Retainers & Retaining Clips
12 Varieties - 335 Pieces

Contains the following Auveco part numbers:
14349, 14352, 14353, 14355, 14356, 14723,
14737, 16775, 16776, 17237, 17452 & 18166



6939
Rocker Panel &
Moulding Clips
23 Varieties
171 Pieces

Contains the following Auveco part numbers:
15695, 17612, 19820, 19821, 19822, 20318, 20353,
20568, 20607, 20756, 20757, 20774, 20865, 20926,
21158, 21226, 21241, 21244, 21285, 21683,
21793, 22015 & 22068



6913
Toyota & Lexus
Push-Type Retainers
18 Varieties - 149 Pieces

Contains the following Auveco part numbers:
14260, 16784, 17162, 17206, 17439, 17988, 17992,
18270, 18873, 18888, 18939, 19013, 19128,
19140, 19219, 19416, 19739 & 20335



6915
Nissan & Infiniti
Push-Type Retainers
18 Varieties - 179 Pieces

Contains the following Auveco part numbers:
14696, 14727, 16000, 16725, 16782, 16783, 16784,
16843, 16858, 16859, 17347, 17472, 18265,
19246, 19274, 20327, 20348 & 20349



6940
Asian Bumper Retainers
24 Varieties - 179 Pieces

Contains the following Auveco part numbers:
17206, 18119, 18873, 19233,
19246, 19470, 20184, 20349, 20564, 20608, 20878,
20931, 20953, 20986, 21173, 21682, 21706, 21836,
21856, 22042, 22077, 22096, 22125 & 22160



6918
Nissan & Infiniti
Nylon Nuts & Screw Grommets
12 Varieties - 235 Pieces

Contains the following Auveco part numbers:
13930, 13931, 14274, 14275, 14313, 14331, 14335,
14695, 14724, 17196, 17342 & 19293



6941
Import Fender Retainers
24 Varieties - 199 Pieces

Contains the following Auveco part numbers:
16000, 17379, 17385, 19118, 19239, 19721, 20390,
20391, 20429, 20688, 20757, 20764, 20869, 20954,
21017, 21111, 21685, 21687, 21706, 21780,
22014, 22017, 22054 & 22141



6916
Toyota & Lexus
Nylon Nuts & Screw Grommets
18 Varieties - 230 Pieces

Contains the following Auveco part numbers:
13932, 14256, 14258, 14265, 14267, 14268, 14271,
14273, 14274, 14275, 14277, 14281, 14695,
19194, 19721, 19756, 19783 & 20440

"6800" SERIES QUIK-SELECT ASSORTMENTS

Sec. 15



Photos not actual size

Fast moving body hardware and specialty fasteners in convenient, translucent, durable polypropylene boxes.

Our Quik-Select Assortments offer popular coverage in an economical package that makes choosing the correct part fast and easy.

Assortments come in 6, 12 and 18 compartment layouts complete with O.E.M. numbers, sizes, specifications and the proper Auveco part number for ordering refills.

"6800" Series Quik-Select Numeric Listing

Refer to contents listing on following pages

Auveco Part No.	Description	Auveco Part No.	Description	Auveco Part No.	Description
6801	GM "Xmas Tree" Retainers	6826	Rubber Vacuum Caps	6852	Stainless Steel Tapping Screws
6802	Ford "Xmas Tree" Retainers	6827	Rubber Grommets	6853	Specialty Screws
6803	Chrysler "Xmas Tree" Retainers	6829	Honda Body Hardware	6854	Metric Specialty Screws
6804	GM Push-Type Retainers	6830	Hair Pin Cotter	6856	External & Internal Lock Washers
6805	Ford Push-Type Retainers	6831	Plastic Plug Buttons	6857	Thread Cutting & Washer Lock Nuts
6806	Nylon Rivets	6834	Toyota Body Hardware	6858	Pushnut Bolt Retainers
6807	Nylon Nuts	6835	Rubber O-Rings	6859	Hose Connectors
6808	License Plate Hardware	6836	Nylon Connectors	6861	Spring Pins
6809	Window Reveal Moulding Clips	6837	Honda Body Hardware	6862	E-Type Retaining Rings
6810	Sems® Screws	6838	Nissan Body Hardware	6863	External & Internal Retaining Rings
6811	Specialty Screws	6839	Toyota Body Hardware	6864	Door Lock Rod Clips
6812	Black Tapping Screws	6840	Pan'l Blind Rivets	6865	Weatherstrip Retainers
6813	Teks® Screws	6841	Specialty Rivets	6866	Rubber Bumpers
6814	Body Bolts	6842	Nylon Insulated Terminals	6867	Wire Loom Clips
6815	Tubular, Flat, U & J-Nuts	6843	Vinyl Insulated Terminals	6868	Shims
6816	Extruded U-Nuts	6845	GM "Xmas Tree" Retainers	6869	Fender Washers
6817	Washer Type Nuts & Push-On Retainers	6846	Ford "Xmas Tree" Retainers	6870	GM, Ford & Chrysler Push-Type Retainers
6818	Cotter Pins	6847	Chrysler "Xmas Tree" Retainers	6871	Hyundai & Kia Clips & Fasteners
6820	Oil Drain Plug Gaskets	6848	Chrome Phillips Oval Head Tapping Screws		
6821	Glass Shop Rivets	6850	Black Phillips Oval Head Tapping Screws		
6822	GM Window Guides	6851	Zinc & Black Phillips Pan Head Tapping Screws		
6825	Oil Drain Plug Gaskets				

Empty Compartment Boxes



Translucent Durable Polypropylene Boxes with Locking Tabs
6-3/4" Wide x 11" Deep x 1-3/4" High

6 Compartment Box
68-6: UNIT PACKAGE: 1

12 Compartment Box
68-12: UNIT PACKAGE: 1
68-112: UNIT PACKAGE: 10

18 Compartment Box
68-18: UNIT PACKAGE: 1
68-118: UNIT PACKAGE: 10

Quik-Select Rack



68-RACK

Empty Cabinet: Holds 5 Quik-Select Assortments.
11-1/4" Wide x 6-3/4" Deep x 10-3/4" High
Finish: Gray Enamel
Keyhole slots are furnished for wall mounting.
A handle is provided and bolt holes permits stacking.

UNIT PACKAGE: 1

Photos not actual size



6848

Phillips Oval Head Tapping Screws
Chrome Plated
18 Varieties - 200 Pieces

Auveco Part No.	Size
2698	#6 x 1/2"
1794	#6 x 3/4"
1796	#6 x 1"
2707	#8 x 1/2"
2027	#8 x 1/2" with #6 Head
2710	#8 x 3/4"
1799	#8 x 3/4" with #6 Head
2713	#8 x 1"
1483	#8 x 1" with #6 Head
2716	#8 x 1-1/4"
1423	#8 x 1-1/4" with #6 Head
2718	#8 x 1-1/2"
1932	#8 x 1-1/2" with #6 Head
1933	#8 x 1-3/4" with #6 Head
2728	#10 x 3/4"
1717	#10 x 3/4" with #8 Head
2731	#10 x 1"
2730	#10 x 1" with #8 Head



6850

Phillips Oval Head Tapping Screws
Black Oxide Plated
18 Varieties - 339 Pieces

Auveco Part No.	Size
12795	#6 x 1/2"
12796	#6 x 3/4"
12797	#6 x 1"
10163	#8 x 1/2"
10162	#8 x 1/2" with #6 Head
10165	#8 x 3/4"
10164	#8 x 3/4" with #6 Head
10167	#8 x 1"
10166	#8 x 1" with #6 Head
10169	#8 x 1-1/4"
10168	#8 x 1-1/4" with #6 Head
10171	#8 x 1-1/2"
10170	#8 x 1-1/2" with #6 Head
11086	#10 x 3/4"
11087	#10 x 3/4" with #8 Head
11088	#10 x 1"
11089	#10 x 1" with #8 Head
11092	#10 x 1-1/2"



6812

Black Tapping Screws
18 Varieties - 312 Pieces

Auveco Part No.	Size
Black E-Coat Phillips Flat Washer Head	
12213	#8 x 1/2"
12214	#8 x 5/8"
12215	#8 x 3/4"
12216	#8 x 1"
12217	#8 x 1-1/4"
12218	#8 x 1-1/2"
12953	#10 x 3/4"
12954	#10 x 1"

**Black Oxide
Phillips Oval Head**

10162	#8 x 1/2" with #6 Hd.
10163	#8 x 1/2"
10164	#8 x 3/4" with #6 Hd.
10165	#8 x 3/4"
10166	#8 x 1" with #6 Hd.
10167	#8 x 1"
10168	#8 x 1-1/4" with #6 Hd.
10169	#8 x 1-1/4"
10170	#8 x 1-1/2" with #6 Hd.
10171	#8 x 1-1/2"

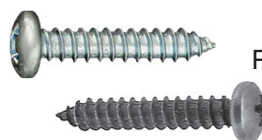

6851

Phillips Pan Head Tapping Screws
Plated
18 Varieties - 457 Pieces

Auveco Part No.	Size
Zinc	
1940	#8 x 1/2"
2365	#8 x 3/4"
3079	#8 x 1"
1943	#10 x 1/2"
2366	#10 x 3/4"
3082	#10 x 1"
2367	#12 x 3/4"
3090	#14 x 3/4"

Black Oxide

11917	#6 x 1/2"
11918	#6 x 3/4"
10180	#8 x 1/2"
10181	#8 x 3/4"
10182	#8 x 1"
10183	#8 x 1-1/4"
12799	#8 x 1-1/2"
11921	#10 x 1/2"
11922	#10 x 3/4"
11923	#10 x 1"

"6800" SERIES QUIK-SELECT ASSORTMENTS

Photos not actual size

Sec. 15



6810
Sems® Screws
Plated
18 Varieties - 140 Pieces

Auveco Part No.	Size
Chrome	
3538	#6 x 3/4"
2771	#8 x 5/8" with #6 Hd.
2751	#8 x 3/4" with #6 Hd.
11450	#8 x 3/4", Teks
2775	#8 x 7/8" with #6 Hd., with Flush Washer
2772	#8 x 1" with #6 Hd.
2773	#8 x 1-1/4" with #6 Hd.
3465	#10 x 5/8" with #8 Hd.
3466	#10 x 3/4" with #8 Hd.
3467	#10 x 1" with #8 Hd.
Black	
11787	#8 x 5/8" with #6 Hd.
11454	#8 x 5/8", Teks
11788	#8 x 3/4" with #6 Hd.
11455	#8 x 3/4", Teks
11789	#8 x 1" with #6 Hd.
12957	#8 x 1" with #6 Hd. with Flush Washer
11791	#10 x 3/4" with #8 Hd.
11792	#10 x 1" with #8 Hd.



6813
Pan Head & Hex Washer
Head Teks® Screws
Zinc Plated
18 Varieties - 127 Pieces



Auveco Part No.	Size
Pan Head	
12095	#8 x 1/2"
9605	#8 x 1/2"
9606	#8 x 3/4"
9607	#10 x 1/2"
9608	#10 x 3/4"
9609	#10 x 1"
Hex Washer Head	
9611	#8 x 1/2"
9612	#8 x 3/4"
9613	#10 x 1/2"
9614	#10 x 5/8"
9615	#10 x 3/4"
9616	#10 x 1"
11911	#12 x 1"
11913	#12 x 1-1/2"
9620	#14 x 3/4"
11914	#14 x 1"
11915	#14 x 1-1/4"
11916	#14 x 1-1/2"



6852
Stainless Steel Tapping Screws
12 Varieties - 216 Pieces



Auveco Part No.	Size	Head
9400	#6 x 3/4"	Oval
9404	#8 x 3/4"	Oval
9405	#8 x 1"	Oval
9407	#8 x 1-1/2"	Oval
9409	#10 x 3/4"	Oval
9410	#10 x 1"	Oval
13269	#8 x 1/2"	Pan
13270	#8 x 3/4"	Pan
13271	#8 x 1"	Pan
13274	#10 x 1/2"	Pan
13275	#10 x 3/4"	Pan
13276	#10 x 1"	Pan



6811
Specialty Screws
12 Varieties - 332 Pieces

Auveco Part No.	Size
10642	#8 x 3/8"
2805	#8 x 7/16"
13025	#8 x 1/2"
12095	#8 x 1/2" Teks®
2806	#8 x 5/8"
13026	#8 x 3/4"
12739	M4.2-1.41 x 12mm
13712	M4.2-1.41 x 13mm
18340	M4.8-1.61 x 15mm
17459	M4.8-1.61 x 16mm
20259	M4.8-1.61 x 19mm
20455	M4.8-2.12 x 20mm



6808
License Plate Hardware
12 Varieties - 171 Pieces



Contains the following Auveco part numbers:
1313, 2472, 2625, 3182, 5228, 5278, 8250, 8427,
8435, 9603, 11370, 11719 & 14473.



6814
Body Bolts
12 Varieties - 101 Pieces

Auveco Part No.	Size
11320	5/16"-18 x 1"
12693	M6-1.0 x 20mm
12324	M6-1.0 x 20mm
12160	M6-1.0 x 22mm
12065	M6-1.0 x 25mm
12066	M6-1.0 x 25mm
12323	M6-1.0 x 25mm
12335	M6-1.0 x 28mm
12351	M6.3-1.81 x 20mm
13613	M8-1.25 x 25mm
13614	M8-1.25 x 30mm
11640	M8-1.25 x 30mm

Photos not actual size



6854

Metric Specialty Screws
18 Varieties - 145 Pieces

Auveco Part No.	Size
12062	M4.2-1.41 x 10mm
12739	M4.2-1.41 x 12mm
13712	M4.2-1.41 x 13mm
12741	M4.2-1.41 x 16mm
12060	M4.2-1.41 x 20mm
12738	M4.2-1.41 x 20mm
12742	M4.2-1.41 x 20mm
15373	M4.2-1.41 x 20mm
15775	M4.2-1.41 x 20mm
17459	M4.8-1.81 x 16mm
12057	M6.3-1.81 x 16mm
15962	M6.3-1.81 x 18mm
12351	M6.3-1.81 x 20mm
16828	M6.3-1.81 x 20mm
12339	M6.3-1.81 x 25mm
12068	M6.3-1.81 x 30mm
12354	M6.3-1.81 x 30mm
12350	M8-2.12 x 20mm



6853

Specialty Screws
12 Varieties - 198 Pieces

Auveco Part No.	Size
10642	#8 x 3/8"
15037	#8 x 7/16"
2805	#8 x 7/16"
12095	#8 x 1/2"
15172	#8 x 1/2"
15774	#8 x 1/2"
2806	#8 x 5/8"
12820	#8 x 3/4"
13026	#8 x 3/4"
17650	#8 x 3/4"
13709	#10 x 3/4"
16589	#10 x 3/4"



6858

Pushnut Bolt Retainers
18 Varieties - 314 Pieces

Auveco Part No.	Size
16851	#6 (9/64")
10085	#8 (5/32")
16852	#10 (3/16")
10086	1/4"
10087	5/16"
9297	3/8"
9298	7/16"
9299	1/2"
12122	M5-0.8
12123	M6-1.0
14980	M6-1.0
12124	M6.3-1.0
12125	M8-1.25
12259	M8-1.25
12126	M10-1.50
12260	M10-1.50
12127	M12-1.75
16980	M14-2.0



6817

Washer Type
Thread Cutting Nuts
& Push-on Retainers
18 Varieties - 385 Pieces

Auveco Part No.	Size
Thread Cutting Nuts	
12253	5mm Stud Size
3403	1/8" Stud Size
3404	3/16" Stud Size
2896	3/16" Stud Size
2897	1/4" Stud Size
3405	1/4" Stud Size
10733	5/16" Stud Size
Push-On Retainers	
8863	1/8" Stud Size
8864	5/32" Stud Size
8865	3/16" Stud Size
8868	1/4" Stud Size
Bolt Retainers	
10086	1/4" Bolt Size
10087	5/16" Bolt Size
9297	3/8" Bolt Size
12123	6mm Bolt Size
12125	8mm Bolt Size
12259	8mm Bolt Size
12126	10mm Bolt Size

DON'T SEE THE ASSORTMENT YOU WANT?

Although we offer over 100 different assortments, we know you have some great ideas for new ones.

Send us those ideas so we make sure our customers get the best we can offer.

Email suggestions to mail@auveco.com

"6800" SERIES QUIK-SELECT ASSORTMENTS

Photos not actual size

Sec. 15



6816

Extruded U-Nuts (Foldover Nuts)
12 Varieties - 70 Pieces

Auveco Part No.	Size	Center of Hole to Edge
8359	1/4" - 20	17/32"
10051	1/4" - 20	25/32"
10053	5/16" - 18	9/16"
8814	5/16" - 18	27/32"
10054	3/8" - 16	3/4"
10055	3/8" - 16	1-1/8"
12669	M6 - 1.0	13.5mm
12575	M6 - 1.0	19.5mm
11628	M6.3 - 1.0	13.5mm
11629	M8 - 1.25	14.5mm
11630	M8 - 1.25	20mm
11631	M10 - 1.5	19mm



6857

Thread Cutting &
Washer Lock Nuts
18 Varieties - 227 Pieces



Auveco Part No.	Size
-----------------	------

Thread Cutting Nuts

2895	1/8" Stud Size
3403	1/8" Stud Size
8855	5/32" Stud Size
2896	3/16" Stud Size
3404	3/16" Stud Size
3405	1/4" Stud Size
2897	1/4" Stud Size
10733	5/16" Stud Size
12253	5mm Stud Size
12255	6.3mm Stud Size
15711	8mm Stud Size

Washer Lock Nuts

2554	#6-32 Thread
2555	#8-32 Thread
2557	#10-24 Thread
2558	#10-24 Thread
2560	#12-24 Thread
2561	1/4"-20 Thread
2562	1/4"-20 Thread



6869

Fender Washers
12 Varieties - 155 Pieces

Auveco Part No.	Bolt Size	Outer Diameter
2007	3/16"	1/2"
1183	3/16"	3/4"
16018	3/16"	1"
16020	1/4"	1"
2333	1/4"	1-1/4"
768	5/16"	1-1/4"
17095	5/16"	1-1/4"
1700	5/16"	1-1/2"
3553	3/8"	1-1/4"
2227	3/8"	1-1/2"
1294	3/8"	1-3/4"
17094	3/8"	1-3/4"



6815

Nuts: Tubular, Flat, J & U
18 Varieties - 148 Pieces

Auveco Part No.	Size	Type
2595	1/8"	Tubular
10073	3/16"	Tubular
2099	1/8"	Flat
2092	#10-24	Flat
1903	1/4"-20	Flat
5586	1/4"-20	J-Nut
5589	5/16"-18	J-Nut
5170	3/8"-16	J-Nut
10666	#8	U-Nut
11292	#8	U-Nut
5197	#10-24	U-Nut
2293	1/4"-20	U-Nut
9879	#8	U-Nut
9880	#8	U-Nut
10064	#6	U-Nut
10065	#8	U-Nut
10066	#10	U-Nut
10067	#14	U-Nut



6856

External & Internal
Lock Washers
12 Varieties - 685 Pieces



Auveco Part No.	Size
External	
5251	#8 (5/32")
5252	#10 (3/16")
5254	#14 (1/4")
5255	5/16"
5256	3/8"
5257	7/16"
Internal	
5261	#8 (5/32")
5262	#10 (3/16")
5264	#14 (1/4")
5265	5/16"
5266	3/8"
5267	7/16"



6868

Shims - Zinc Plated
6 Varieties - 100 Pieces

Auveco Part No.	Size	Thickness
2453	1-3/4" x 1-1/4"	1/8"
3000	2" x 1-1/2"	1/8"
3155	1-1/4" x 1-1/8"	1/16"
3156	1-1/4" x 1-1/8"	1/8"
5076	1-1/8" x 1-1/8"	1/16"
5077	1-1/8" x 1-1/8"	1/8"

Photos not actual size



6830
Hair Pin Cotter
6 Varieties - 73 Pieces

Auveco Part No.	Overall Length
10397	3-15/16"
11872	1-9/16"
10398	4"
10395	2-1/2"
10396	3-3/4"
10394	2-5/16"



6818
Cotter Pins
Zinc Plated
18 Varieties - 570 Pieces

Auveco Part No.	Size
8477	1/16" x 1/2"
8478	1/16" x 3/4"
8479	1/16" x 1"
8480	1/16" x 1-1/2"
8481	3/32" x 3/4"
8482	3/32" x 1"
8484	3/32" x 1-1/2"
8485	3/32" x 2"
8486	1/8" x 1"
8487	1/8" x 1-1/4"
8488	1/8" x 1-1/2"
8489	1/8" x 1-3/4"
8490	1/8" x 2"
8492	5/32" x 1"
8493	5/32" x 1-1/2"
8494	5/32" x 2"
8495	3/16" x 1-1/2"
8496	3/16" x 2"



6863
External & Internal Retaining Rings
Zinc Plated
18 Varieties - 151 Pieces



Auveco Part No.	Shaft Diameter
Internal Type	
8688	1/4"
8689	5/16"
8690	3/8"
8691	7/16"
8693	9/16"
8694	5/8"
External Type	
8701	1/4"
8702	5/16"
8703	3/8"
8704	7/16"
8705	1/2"
8706	9/16"
8707	5/8"
8708	3/4"
8709	7/8"
8710	1"
8712	1-1/4"
10125	1-1/2"



6831
Plastic Plug Buttons
6 Varieties - 305 Pieces



Auveco Part No.	Size
Depressed Center Type	
9288	1/2"
9289	3/4"
Flush Type	
14923	3/8"
11746	1/2"
11747	3/4"
11749	1"



6862
E-Type Retaining Rings
12 Varieties - 343 Pieces

Auveco Part No.	Shaft Diameter
8825	3/32"
8826	1/8"
10131	5/32"
8827	3/16"
10133	7/32"
8828	1/4"
3824	5/16"
8829	3/8"
8830	7/16"
5602	1/2"
5603	5/8"
8831	3/4"



6861
Spring Pins
Zinc Plated
12 Varieties - 174 Pieces

Auveco Part No.	Size
9006	1/8" x 3/4"
9008	1/8" x 1"
9010	1/8" x 1-1/2"
9016	5/32" x 1"
9018	5/32" x 1-1/2"
9022	3/16" x 1"
9024	3/16" x 1-1/2"
9026	3/16" x 2"
9033	1/4" x 1"
9035	1/4" x 1-1/2"
9037	1/4" x 2"
9045	5/16" x 2"



6826
Rubber Vacuum Caps
6 Varieties - 121 Pieces



Auveco Part No.	Size
12209	Fits 1/8" O.D. Tube
4440	Fits 3/16" O.D. Tube
4439	Fits 1/4" O.D. Tube
12907	Fits 5/16" O.D. Tube
12210	Fits 3/8" O.D. Tube
12908	Fits 1/2" O.D. Tube

"6800" SERIES QUIK-SELECT ASSORTMENTS

Photos not actual size

Sec. 15

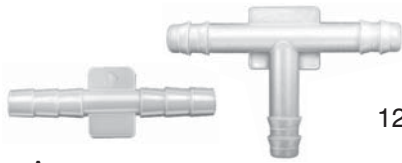

6836
Nylon Connectors
12 Varieties - 83 Pieces

Auveco Part No.	Size	Type
11738	1/4" x 1/4" x 3/16"	Tee
12918	3/16 x 3/16" x 3/16"	Tee
12919	1/4" x 3/16" x 3/16"	Tee
12920	5/16" x 5/16" x 5/16"	Tee
12921	3/8" x 3/8" x 1/4"	Tee
12923	1/8" x 1/8" x 1/8"	Tee
12926	3/16" x 3/16" x 1/8"	Tee
12929	1/8" x 1/8"	Straight
12930	1/8" x 3/16"	Straight
12931	1/4" x 1/4"	Straight
12935	1/4" x 3/16"	Straight
12937	3/16" x 3/16"	Straight



6867
Wire Loom Routing Clips
6 Varieties - 42 Pieces

Auveco Part No.	For Loom Size
14544	11/32" I.D., 1/2" O.D.
14545	13/32" I.D., 19/32" O.D.
14546	1/2" I.D., 11/16" O.D.
14547	3/4" I.D., 1" O.D.
16941	1" I.D., 1-9/32" O.D.
19440	1/4" I.D., 3/8" O.D.



6825
Oil Drain Plug Gaskets
12 Varieties
84 Pieces



Auveco Part No.	Size	Type
8277	1/2"	Nylon
15918	1/2"	Copper
15919	9/16"	Copper
16026	1/2"	Steel & Rubber
16682	14mm	Fibre
16955	18mm	Aluminum
16956	14mm	Aluminum
16996	1/2"	Nylon
18299	14mm	Steel & Rubber
18665	11mm	Rubber
18726	12mm	Fibre
19630	11mm	Rubber



6820
Oil Drain Plug Gaskets
12 Varieties - 120 Pieces



Auveco Part No.	Size	Type
8277	1/2"	Nylon
8278	5/8"	Nylon
8279	3/4"	Nylon
8281	9/16"	Nylon
16680	12mm	Nylon
16681	14mm	Nylon
16682	14mm	Fibre
16685	20mm	Nylon
16996	1/2"	Nylon
21647	20mm	Fibre
18019	1/2"	Fibre
18726	12mm	Fibre



6859
Hose Connectors
12 Varieties - 61 Pieces

Auveco Part No.	Size	Type
10101	1/8" x 1/8"	Straight
10102	3/16" x 3/16"	Straight
10103	1/4" x 1/4"	Straight
10104	5/16" x 5/16"	Straight
10105	3/8" x 3/8"	Straight
10106	1/4" x 3/16"	Straight
10107	3/8" x 1/4"	Straight
10697	1/8" x 1/8" x 1/8"	Tee
10108	5/32" x 5/32" x 5/32"	Tee
10109	3/16" x 3/16" x 3/16"	Tee
10110	1/4" x 1/4" x 1/4"	Tee
11228	3/8" x 3/8" x 3/8"	Tee



6843
Vinyl Insulated
Solderless Terminals
12 Varieties - 125 Pieces

Auveco Part No.	Description
5023	Ring Type, 22-18 Gauge
5026	Ring Type, 16-14 Gauge
5027	Ring Type, 16-14 Gauge
5028	Ring Type, 12-10 Gauge
5029	Ring Type, 12-10 Gauge
5031	Ring Type, 12-10 Gauge
5036	Spade Type, 16-14 Gauge
5047	Butt Conn., 22-18 Gauge
5048	Butt Conn., 16-14 Gauge
5049	Butt Conn., 12-10 Gauge
12144	Ring Type, 16-14 Gauge
17037	Butt Connector, 8 Gauge

Photos not actual size

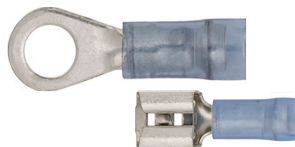

6842
Nylon Insulated
Solderless Terminals
12 Varieties - 100 Pieces

Auveco Part No.	Description
5791	Butt Conn., 22-18 Gauge
5792	Butt Conn., 16-14 Gauge
5793	Butt Conn., 12-10 Gauge
9055	Ring Type, 16-14 Gauge
9056	Ring Type, 16-14 Gauge
9060	Spade Type, 16-14 Gauge
12147	Male Q. C. 16-14 Gauge
12148	Female Q.C., 16-14 Gauge
12150	Ring Type, 22-18 Gauge
12151	Ring Type, 12-10 Gauge
12152	Ring Type, 12-10 Gauge
12153	Ring Type, 12-10 Gauge



6840
Pan'l Blind Rivets
12 Varieties - 291 Pieces

Auveco Part No.	Grip	Type
1/8" Diameter		
8309	1/16"-1/8"	Aluminum
5753	3/16"-1/4"	Steel
8925	3/16"-1/4"	Aluminum
8931	3/16"-1/4"	Aluminum Large Flange
5/16"-3/8"		
8880	5/16"-3/8"	Steel
16031	5/16"-3/8"	Aluminum
16032	3/8"-1/2"	Aluminum
3/16" Diameter		
5755	1/16"-1/8"	Aluminum
8311	1/8"-1/4"	Aluminum
8301	1/4"-3/8"	Aluminum
8313	1/4"-3/8"	Aluminum Large Flange
8938	3/8"-1/2"	Aluminum



6841
Specialty Rivets
12 Varieties - 66 Pieces

Auveco Part No.	Grip	Type
1/8" Diameter		
16834	1/8"-3/16"	
17615	3/16"-3/8"	
3/16" Diameter		
16864	3/64"-11/32"	
17121	5/64"-15/64"	
14127	3/8"-1/2"	
1/4" Diameter		
11620	1/32"-9/64"	Peel-Type
12653	3/32"-1/8"	Peel-Type
18167	3/32"-9/64"	Peel-Type
12652	1/8"-1/4"	
12655	9/64"-3/16"	Peel-Type
17639	3/16"-3/8"	
11621	33/64"-19/32"	Peel-Type



6806
Nylon Rivets
12 Varieties
74 Pieces

Auveco Part No.	Diameter	Grip
13746	3/16"	1/16"-9/64"
13747	13/64"	1/16"-11/64"
13748	13/64"	1/8"-15/64"
13755	13/64"	15/64"-25/64"
14004	15/64"	11/64"-11/32"
14023	15/64"	5/32"-5/16"
18108	1/4"	5/32"-3/8"
13750	1/4"	5/32"-13/32"
13751	1/4"	5/32"-13/32"
17101	1/4"	5/16"-15/32"
13752	17/64"	3/32"-3/16"
13753	17/64"	3/32"-3/16"



6827
Rubber Grommets
18 Varieties - 99 Pieces

Auveco Part No.	Bore Diameter	Width
4408	1/8"	3/32"
4410	5/32"	1/16"
4413	3/16"	1/16"
4414	3/16"	3/32"
4415	3/16"	1/4"
4417	1/4"	1/16"
4419	5/16"	1/16"
4421	5/16"	1/8"
4422	5/16"	1/4"
4423	3/8"	1/16"
4425	3/8"	1/16"
4426	3/8"	1/4"
4428	1/2"	3/32"
4430	1/2"	1/4"
4431	5/8"	1/8"
4432	5/8"	1/16"
4434	3/4"	1/16"
4436	3/4"	1/4"



6821
Glass Shop Rivets
6 Varieties - 63 Pieces

Auveco Part No.	Diameter	Grip
11620	1/4"	1/32"-9/64"
11621	1/4"	33/64"-19/32"
11852	1/4"	5/64"-7/64"
12653	1/4"	3/32"-1/8"
12655	1/4"	9/64"-3/16"
16834	1/8"	1/8"-3/16"

"6800" SERIES QUIK-SELECT ASSORTMENTS

Sec. 15

Photos not actual size



6835
Rubber O-Rings
Buna-N
18 Varieties - 770 Pieces

Auveco Part No.	Industry Standard	Inner Diameter	Outer Diameter
4305	006	1/8"	1/4"
4306	007	5/32"	9/32"
4307	008	3/16"	5/16"
4308	009	7/32"	11/32"
4309	010	1/4"	3/8"
4310	011	5/16"	7/16"
4311	012	3/8"	1/2"
4312	110	3/8"	9/16"
4313	111	7/16"	5/8"
4314	112	1/2"	11/16"
4315	113	9/16"	3/4"
4316	114	5/8"	13/16"
4317	115	11/16"	7/8"
4318	116	3/4"	15/16"
4319	210	3/4"	1"
4320	211	13/16"	1-1/16"
4321	212	7/8"	1-1/8"
4323	214	1"	1-1/4"



6866
Rubber Bumpers
12 Varieties
105 Pieces

Auveco Part No.

Application

4155	General Purpose
4188	Door & Quarter Glass
4233	General Purpose
4235	Hood & Fender
4237	General Purpose
4240	Door
4242	Hood, Trunk & Deck Lid
4244	General Purpose
4246	Gas Tank Lid
4249	General Purpose
4250	Glove Box Door
4280	License Plate



6809
Window Reveal Moulding Clips
GM & Ford
12 Varieties - 132 Pieces

Contains the following Auveco part numbers:
8583, 8941, 9633 9639, 9882, 10243, 10630, 10631
11067, 11152, 11345 & 13564.



6801
GM "Xmas Tree" Retainers
12 Varieties - 118 Pieces

Contains the following Auveco part numbers:
10621, 10831, 10832, 11146, 11612,
11678, 11796, 12137, 12731,
12737, 12766 & 12992.



6802
Ford "Xmas Tree" Retainers
12 Varieties - 112 Pieces

Contains the following Auveco part numbers:
10831, 11136, 11351, 11671, 11797, 12565,
12571, 12909, 14021, 14163, 17612 & 19655



6803
Chrysler "Xmas Tree Retainers"
6 Varieties - 113 Pieces

Contains the following Auveco part numbers:
10831, 11136, 11146, 11351, 11678 & 17004



6822
GM Window Guides
6 Varieties - 30 Pieces

Auveco Part No.

O.E.M. No.

15462	20478733
15463	20487630, 20712176
15466	20160591
15467	20123070, 20328600
17159	20747509
17176	20162174, 22543363



6845
GM "Xmas Tree" Retainers
11 Varieties - 118 Pieces

Contains the following Auveco part numbers:
11120, 12759, 13461, 14032, 14036, 15367,
15456, 15669, 15970, 16818 & 17664



6846
Ford "Xmas Tree" Retainers
12 Varieties - 112 Pieces

Contains the following Auveco part numbers:
8853, 11136, 11672, 13470, 14757, 15478,
15479, 15480, 17102, 17339, 19655 & 20316



6847
Chrysler "Xmas Tree" Retainers
12 Varieties - 113 Pieces

Contains the following Auveco part numbers:
11129, 11136, 11675, 11679, 14921, 15481,
15543, 16818, 17004, 17975, 18033 & 20316

Photos not actual size



6864

Door Lock Rod Clips
12 Varieties - 59 Pieces



Contains the following Auveco part numbers:
14967, 15518, 15673, 15674, 15675, 15759, 17069,
17122, 18392, 18393, 18926 & 20675



6807

Nylon Nuts & Grommets
18 Varieties - 251 Pieces



Contains the following Auveco part numbers:
2625, 3682, 8435, 9829, 9862, 10330, 11368, 11691,
11719, 11838, 11841, 11855, 12735, 13450,
13933, 13960, 14009 & 14031



6865

Weatherstrip Retainers
12 Varieties - 245 Pieces

Auveco
Part No.

Application

8853	Ford
10744	GM
11120	GM
11129	Chrysler
11612	Ford & GM
14328	Honda
14921	Chrysler & GM
17339	Ford
18033	Chrysler
18692	Mazda & Toyota
18877	Honda
19171	Honda



6804

GM Push-type Retainers
12 Varieties - 76 Pieces

Contains the following
Auveco part numbers:
12567, 12757, 13993, 14010, 14011,
14020, 14753, 15044, 15045, 17216,
17222 & 18353.



6829

Honda Body Hardware
12 Varieties - 92 Pieces

Auveco
Part No.

Description

14268	Screw Grommet
14274	Nylon Nut
14282	Retaining Clip
14313	Nylon Nut
14695	Screw Grommet
14696	Push-Type Retainer
14697	Push-Type Retainer
14698	Push-Type Retainer
16000	Push-Type Retainer
17143	Push-Type Retainer
17144	Push-Type Retainer
20564	Push-Type Retainer



6805

Ford Push-Type Retainers
6 Varieties - 68 Pieces

Contains the following
Auveco part numbers:
11705, 14018, 14019, 14020,
14753 & 18894.



6837

Honda Body Hardware
12 Varieties - 61 Pieces

Auveco
Part No.

Description

14289	Panel Retainer
14291	Retaining Clip
14328	Weatherstrip Clip
16779	Retaining Clip
16782	Push-Type Retainer
17057	Push-Type Retainer
17192	Push-Type Retainer
17205	Retaining Clip
17379	Push-Type Retainer
18114	Insulation Retainer
18119	Push-Type Retainer
19233	Push-Type Retainer



6870

GM, Ford & Chrysler Push-Type Retainers
11 Varieties - 116 Pieces

Contains the following
Auveco part numbers:
20826, 20880, 20888, 20889, 20988, 20989,
20990, 20991, 20992, 20993 & 20994.



6871

Hyundai & Kia
Clips & Fasteners
18 Varieties - 76 Pieces

Auveco
Part No.

Description

20543	Hood Insulation Retainer
20566	Moulding Clip
20567	Moulding Clip
20568	Moulding Clip
20680	M6-1.0 L. P. Screw
21064	Moulding Clip
21067	Bumper & Grille Retainer
21068	Nylon Nut
21070	Trim Panel Retainer
21136	Moulding Clip
21146	Push-Type Retainer
21188	Trim Panel Retainer
21244	Moulding Clip
21312	Moulding Clip
21321	Moulding Clip
21328	Push-Type Retainer
21378	Nylon U-Nut
21382	Cowl Vent & Grille Retainer

"6800" SERIES QUIK-SELECT ASSORTMENTS

Sec. 15

Photos not actual size



6838

Nissan
Body Hardware
12 Varieties
58 Pieces

Auveco Part No. Description

14352	Retaining Clip
14355	Retaining Clip
16775	Trim Panel Retainer
16776	Trim Panel Retainer
16782	Push-Type Retainer
16783	Push-Type Retainer
16843	Push-Type Retainer
17347	Push-Type Retainer
17452	Retaining Clip
17472	Push-Type Retainer
20327	Push-Type Retainer
20348	Push-Type Retainer



6839

Toyota Body Hardware
12 Varieties - 73 Pieces

Auveco Part No. Description

14144	Trim Panel Retainer
14271	Nylon Nut
15695	Retainer
16779	Retaining Clip
17206	Push-Type Retainer
17438	Grille Clip
18297	Retaining Clip
18873	Push-Type Retainer
18888	Push-Type Retainer
19739	Push-Type Retainer
20390	Moulding Clip
20391	Moulding Clip



6834

Toyota
Body Hardware
18 Varieties - 72 Pieces

Auveco Part No. Description

13932	Nylon Nut
14260	Push-Type Retainer
14265	Nylon Nut
14267	Screw Grommet
14268	Screw Grommet
14269	Panel Retainer
14274	Nylon Nut
14275	Screw Grommet
14276	Nylon U-Nut
14695	Screw Grommet
14736	Retaining Clip
14737	Retaining Clip
14738	Retaining Clip
14750	Nylon U-Nut
16306	Bumper Cushion Clip
16784	Push-Type Retainer
19194	Screw Grommet
19721	Screw Grommet

**Please place orders in
Unit Package quantities,
not based on pieces needed**

ASSORTMENTS

*All assortments come in durable translucent polypropylene boxes
Photos not actual size*



19442
Extension Springs
Zinc Plated
6 Varieties - 38 Pieces



Contains the following Auveco part numbers:
14063, 14064, 14065 14067, 14070 & 14072



19445
GM O.E.M. Electrical Terminals
12 Varieties
223 Pieces

Contains the following Auveco part numbers:
8774, 8776, 14150, 14151, 14152, 14880, 14881,
14883, 15497, 15498, 15937 & 15948.

Sec. 15

ASSORTMENTS

All assortments come in durable translucent polypropylene boxes
Photos not actual size



21534
Krimp and Seal Terminals
& Connectors
24 Varieties - 159 Pieces

Auveco Part No.	Description
13656	Ring Type, 22-18 Gauge
13657	Ring Type, 22-18 Gauge
13658	Spade Type, 22-18 Gauge
13659	Butt Conn., 22-18 Gauge
13660	Female Q.C. 22-18 Gauge
13661	Male Q.C., 22-18 Gauge
13662	Ring Type, 16-14 Gauge
13663	Ring Type, 16-14 Gauge
13664	Ring Type, 16-14 Gauge
13665	Ring Type, 16-14 Gauge
13666	Ring Type, 16-14 Gauge
13669	Butt Conn., 16-14 Gauge
13670	Female Q.C., 16-14 Gauge
13671	Male Q.C., 16-14 Gauge
13672	Female Q.C., 16-14 Gauge
13673	Male, Q.C., 16-14 Gauge
13674	Ring Type, 12-10 Gauge
13675	Ring Type, 12-10 Gauge
13676	Ring Type, 12-10 Gauge
13678	Butt Conn., 12-10 Gauge
13679	Female Q.C., 12-10 Gauge
13680	Male Q.C., 12-10 Gauge
13681	Female Plug, 16-14 Gauge
13682	Male Plug, 16-14 Gauge



21471
Oil Drain Plugs & Gaskets
12 Varieties - 24 Pieces



Auveco Part No.	Size
14196	1/2"-20 x 1/2"
18373	1/2"-20 x 13/16"
18374	M12-1.75 x 21mm
21047	M12-1.75 x 25mm
14677	M12-1.75 x 26mm
16308	M14-1.5 x 11mm
18375	M14-1.5 x 18mm
14678	M14-1.5 x 20mm
19141	M14-1.5 x 20mm
19279	M14-1.5 x 20mm
19773	M14-1.5 x 20mm
15529	M18-1.5 x 12mm



19444
Metric Grease Fittings
Plated
12 Varieties - 89 Pieces



Auveco Part No.	Type
11097	6mm-1.00, Straight
11775	6mm-1.00, 45 Degree
11776	6mm-1.00, 90 Degree
11098	8mm-1.00, Straight
11777	8mm-1.00, 45 Degree
11099	8mm-1.00, 90 Degree
11778	8mm-1.25, Straight
11779	8mm-1.25, 45 Degree
11780	8mm-1.25, 90 Degree
11100	10mm-1.00, Straight
15067	10mm-1.00, 45 Degree
11101	10mm-1.00, 90 Degree



19443
U.S. Grease Fittings
Plated
12 Varieties - 92 Pieces



Auveco Part No.	Type
9257	1/4"-28, Straight (Short)
9258	1/4"-28, Straight (Long)
9259	1/4"-28, Straight (Extra-Long)
9260	1/4"-28, 45 Degree
9261	1/4"-28, 90 Degree
9262	1/8" Pipe, Straight (Short)
9267	1/8" Pipe, Straight (Long)
15066	1/8" Pipe, Straight (Self-Tapping)
9264	1/8" Pipe, 45 Degree
9265	1/8" Pipe, 65 Degree
9266	1/8" Pipe, 90 Degree
15059	1/4" Pipe, Straight



17359
Door Hinge Bushings
8 Varieties - 136 Pieces



Auveco Part No.	Application
14548	GM
14549	GM
14550	GM, Ford
14551	Ford
14552	Chrysler
14553	GM
16936	GM
16937	GM



19927
Copper Washers
6 Varieties - 150 Pieces

Auveco Part No.	Bolt Size	Outer Diameter
15915	1/4"	11/16"
15913	5/16"	9/16"
15916	5/16"	3/4"
15917	3/8"	13/16"
15918	7/16"	7/8"
15919	1/2"	13/16"



17358
GM Door Hinge Pins
5 Varieties - 27 Pieces

Contains the following Auveco part numbers:
14559, 17437, 19183, 19424 & 19781

"FP" 4 PACK ASSORTMENTS

Photos not actual size



The Auveco "FP" 4 pack assortments are packed in a four compartment easy open translucent polypropylene box. Each assortment contains four carefully selected items designed for the customer that requires maximum coverage for minimum investment.

"FP" 4 Pack Numeric Listing

Refer to contents listing on following pages

Auveco Part No.	Description
FP-100	Phillips Oval Head Tapping Screws, Chrome
FP-102	Phillips Oval Head Tapping Screws, Chrome
FP-104	Phillips Oval Head Tapping Screws, Chrome
FP-108	Phillips Oval Head Tapping Screws, Chrome
FP-123	Phillips Oval Head Sems® Screws, Chrome
FP-131	Hex Washer Head Tapping Screws
FP-132	Hex Washer Head Tapping Screws
FP-159	Washer Lock Nuts
FP-160	Thread Cutting Nuts
FP-163	Tubular Nuts
FP-164	Tubular Nuts
FP-168	J & U Nuts
FP-169	J-Type Cage Nuts
FP-171	Flat Washers

Auveco Part No.	Description
FP-178	Shims
FP-179	Shims
FP-183	Cotter Pins
FP-188	Plug Buttons
FP-193	Grease Fittings
FP-194	Grease Fittings
FP-210	Universal Moulding Fasteners
FP-224	Phillips Oval Head Tapping Screws, B. Oxide
FP-232	Phillips Oval Head Sems® Screws, Phos.
FP-233	Phillips Flat Washer Head Tapping Screws, Black E-Coat
FP-243	Push-On Retainers
FP-247	Spring Type U-Nuts

FP-100	
Phillips Oval Head Tapping Screws Chrome 150 Pieces	
Auveco Part No.	Size
1794	6 x 3/4"
2698	6 x 1/2"
1796	6 x 1"
1797	6 x 1-1/4"

FP-108	
Phillips Oval Head Tapping Screws No. 8 Head - Chrome 115 Pieces	
Auveco Part No.	Size
2724	10 x 5/8"
1717	10 x 3/4"
2730	10 x 1"
2734	10 x 1-1/4"

FP-102	
Phillips Oval Head Tapping Screws Chrome 140 Pieces	
Auveco Part No.	Size
2707	8 x 1/2"
2710	8 x 3/4"
2713	8 x 1"
2716	8 x 1-1/4"

FP-224	
Phillips Oval Head Tapping Screws Black Oxide 245 Pieces	
Auveco Part No.	Size
10163	8 x 1/2"
10165	8 x 3/4"
10167	8 x 1"
10169	8 x 1-1/4"

FP-104	
Phillips Oval Head Tapping Screws No. 6 Head - Chrome 130 Pieces	
Auveco Part No.	Size
2027	8 x 1/2"
1799	8 x 3/4"
1483	8 x 1"
1423	8 x 1-1/4"

FP-123	
Phillips Oval Head Sems® Tapping Screws Chrome 90 Pieces	
Auveco Part No.	Size
2771	8 x 5/8"
2751	8 x 3/4"
2772	8 x 1"
3466	10 x 3/4"

Photos not actual size



FP-232

Phillips Oval Head Sems® Tapping Screws
Black Phosphate
100 Pieces

Auveco Part No. Size

11788	8 x 3/4"
11789	8 x 1"
11791	10 x 3/4"
11792	10 x 1"



FP-233

Phillips Flat Washer Head Tapping Screws
Black E-Coat
220 Pieces

Auveco Part No. Size

12213	8 x 1/2"
12214	8 x 5/8"
12215	8 x 3/4"
12216	8 x 1"



FP-131

Hex Washer Head Tapping Screws
Zinc
165 Pieces

Auveco Part No. Size

2369	10 x 1/2"
2809	10 x 5/8"
2967	12 x 5/8"
2968	12 x 3/4"



FP-132

Hex Washer Head Tapping Screws
Zinc
75 Pieces

Auveco Part No. Size

2370	14 x 5/8"
2330	14 x 3/4"
2974	14 x 1"
2978	5/16" x 3/4"



FP-243

Push-On Retainers
Zinc
260 Pieces

Auveco Part No. Stud Size Outer Diameter

8863	1/8"	3/8"
8865	3/16"	7/16"
8868	1/4"	17/32"
8869	5/16"	5/8"



FP-159

Washer Lock Nuts
Zinc
240 Pieces

Auveco Part No. Thread Size Outer Diameter

2555	8-32	15/32"
2556	10-32	1/2"
2557	10-24	1/2"
2558	10-24	3/4"



FP-160

Thread Cutting Nuts
Zinc
125 Pieces

Auveco Part No. Stud Size O.D.

3403	1/8"	7/16"
2895	1/8"	17/32"
2896	3/16"	5/8"
2897	1/4"	19/32"



FP-168

J and U-Type Nuts
48 Pieces

Auveco Part No. Screw Size

1907	5/16"-10
2057	#14
2420	#14
2293	1/4"-20



FP-169

J-Type Cage Nuts
28 Pieces

Auveco Part No. Thread Size

5589	5/16"-18
5170	3/8"-16
5586	1/4"-20



FP-163

Tubular Nuts
80 Pieces

Auveco Part No. Stud Size

2611	1/8"
11293	1/8"
3776	3/32"
2565	3/16"

"FP" 4 PACK ASSORTMENTS

Photos not actual size

Sec. 15



FP-164

Tubular Nuts
75 Pieces

Auveco Part No.	Stud Size
2595	1/8"
3137	3/32"
10073	3/16"
5196	1/4"



FP-247

Spring Type U-Nuts
Phosphate
70 Pieces

Auveco Part No.	Screw Size
10064	#6
10065	#8
10066	#10
10067	#14



FP-171

Fender Washers
Zinc Plated
200 Pieces

Auveco Part No.	Bolt Size	Outer Diameter
1183	3/16"	3/4"
2333	1/4"	1-1/4"
768	5/16"	1-1/4"
3553	3/8"	1-1/4"



FP-210

Universal Moulding
Fasteners with Nuts
18 Moulding Fasteners

Contains the following Auveco Part Numbers:
2818, 2619, 2752 & 19626.



FP-178

Shims - Plated
75 Pieces

Auveco Part No.	Size	Thickness	Slot
3155	1-1/4" x 1-1/8"	1/16"	3/8"
3156	1-1/4" x 1-1/8"	1/8"	3/8"
2452	1-3/4" x 1-1/4"	1/16"	1/2"
2453	1-3/4" x 1-1/4"	1/8"	1/2"



FP-179

Caster & Camber Shims
Plated
65 Pieces

Auveco Part No.	Thickness	Size
5074	1/64"	1-1/8" x 1-1/8"
5075	1/32"	1-1/8" x 1-1/8"
5076	1/16"	1-1/8" x 1-1/8"
5077	1/8"	1-1/8" x 1-1/8"



FP-183

Hammer Lock
Cotter Pins
Plated
240 Pieces

Auveco Part No.	Size
8482	3/32" x 1"
8484	3/32" x 1-1/2"
8488	1/8" x 1-1/2"
8490	1/8" x 2"



FP-188

Plug Buttons
Nickel Plated
37 Pieces

Auveco Part No.	Hole Size
3751	3/8"
3752	1/2"
3753	5/8"
3755	7/8"



FP-193

Ball Check Grease Fittings
34 Pieces

Auveco Part No.	Size
9257	1/4"-28 Short
9258	1/4"-28 Long
9259	1/4"-28 Extra Long
9262	1/8" Pipe Thread



FP-194

Ball Check
Grease Fittings
22 Pieces

Auveco Part No.	Size	Type
9260	1/4"-28	45°
9261	1/4"-28	90°
9264	1/8" Pipe	45°
9265	1/8" Pipe	65°

O-RING ASSORTMENTS

Photos not actual size



18885

Air Conditioning Nitrile O-Rings
For use with R134A & R12 refrigerant
 18 Varieties - 203 Pieces

Auveco Part No.	Inner Diameter	Outer Diameter	Thickness
17604	.290"	.432"	.071"
18646	3/8"	1/2"	1/16"
17605	.400"	.546"	.073"
17606	.509"	.655"	.073"
17607	.617"	.769"	.076"
18647	11/16"	13/16"	1/16"
18134	4.5mm	7.3mm	1.4mm
18135	6mm	9.6mm	1.8mm
18136	6.5mm	9.5mm	1.5mm
18137	6.6mm	10.2mm	1.8mm
18138	7.7mm	11.3mm	1.8mm
18140	10.7mm	15.5mm	2.4mm
18139	10.8mm	14.4mm	1.8mm
18141	13.3mm	18.1mm	2.4mm
18143	13.4mm	17.2mm	1.9mm
18142	14mm	17.6mm	1.8mm
18144	14.8mm	19.6mm	2.4mm
19235	13/16"	1-1/16"	1/8"



21845

Air Conditioning O-Rings
 Blue Neoprene (Teflon Coated)
For use with R134A & R12 Refrigerant
 6 Varieties - 325 Pieces

Auveco Part No.	Industry Standard	Inner Diameter	Outer Diameter	Thickness
18533	108	1/4"	7/16"	3/32"
18534	011	5/16"	7/16"	1/16"
18536	110	3/8"	9/16"	3/32"
18537	013	7/16"	9/16"	1/16"
18539	112	1/2"	11/16"	3/32"
18543	017	11/16"	13/16"	1/16"

BUNA-N RUBBER O-RINGS

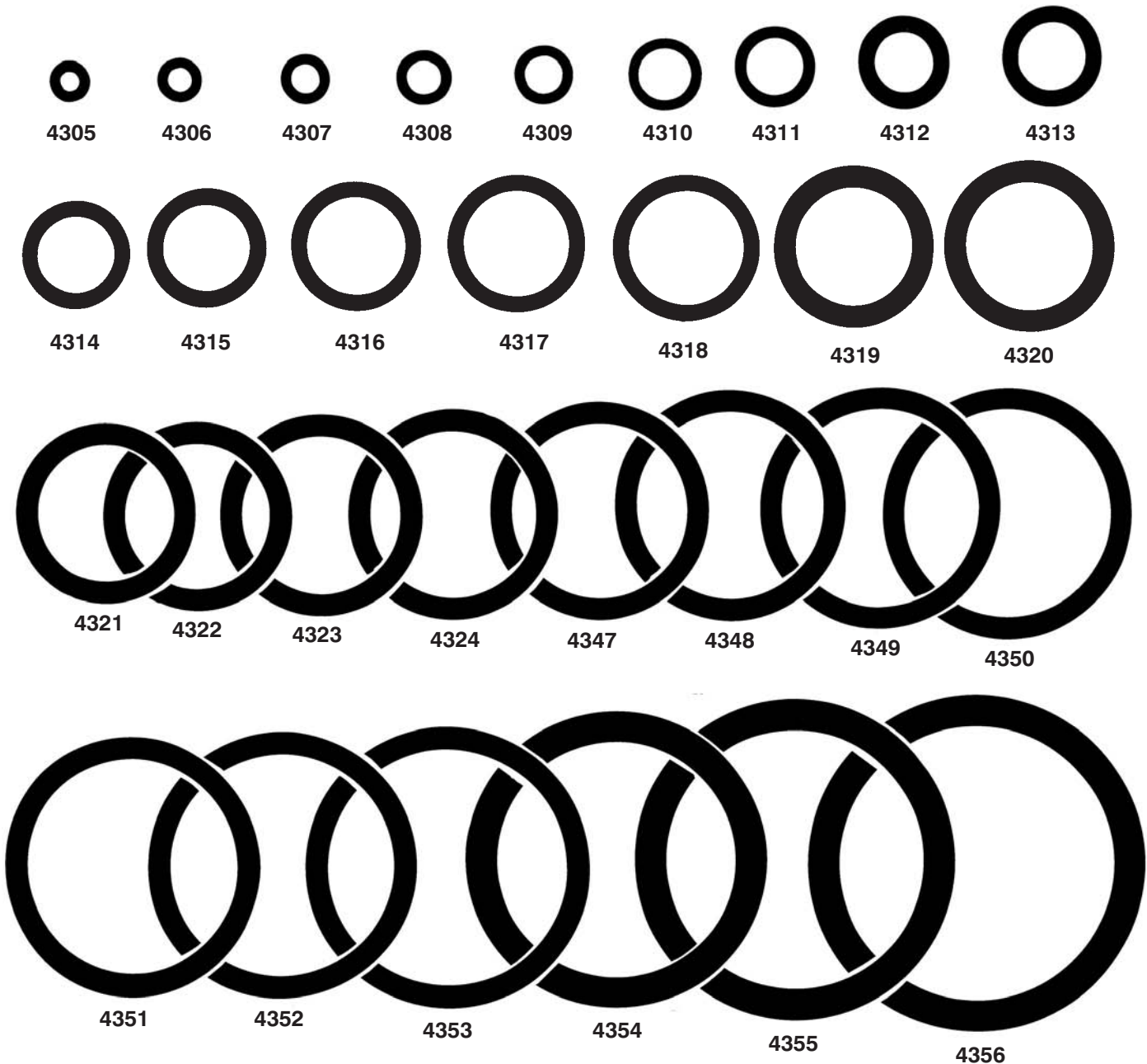

Auveco Part No.	Thickness
4305 thru 4311	1/16"
4312 thru 4318	3/32"
4319 thru 4353	1/8"
4354 thru 4356	13/64"

Temperature Rating: 70 hours at 100°C

Auveco Part No.	Ind. Std.	I.D.	O.D.	Unit Pkg.
4305	006	1/8"	1/4"	50
4306	007	5/32"	9/32"	50
4307	008	3/16"	5/16"	50
4308	009	7/32"	11/32"	50
4309	010	1/4"	3/8"	50
4310	011	5/16"	7/16"	50
4311	012	3/8"	1/2"	50
4312	110	3/8"	9/16"	50
4313	111	7/16"	5/8"	50
4314	112	1/2"	11/16"	50
4315	113	9/16"	3/4"	50

Auveco Part No.	Ind. Std.	I.D.	O.D.	Unit Pkg.
4316	114	5/8"	13/16"	50
4317	115	11/16"	7/8"	50
4318	116	3/4"	15/16"	50
4319	210	3/4"	1"	50
4320	211	13/16"	1-1/16"	50
4321	212	7/8"	1-1/8"	50
4322	213	15/16"	1-3/16"	50
4323	214	1"	1-1/4"	50
4324	215	1-1/16"	1-5/16"	50
4347	216	1-1/8"	1-3/8"	25
4348	217	1-3/16"	1-7/16"	25
4349	218	1-1/4"	1-1/2"	25
4350	219	1-5/16"	1-9/16"	25
4351	220	1-3/8"	1-5/8"	25
4352	221	1-7/16"	1-11/16"	25
4353	222	1-1/2"	1-3/4"	25
4354	325	1-1/2"	1-7/8"	25
4355	326	1-5/8"	2"	25
4356	327	1-3/4"	2-1/8"	25

Sec. 16

METRIC BUNA-N RUBBER O-RINGS

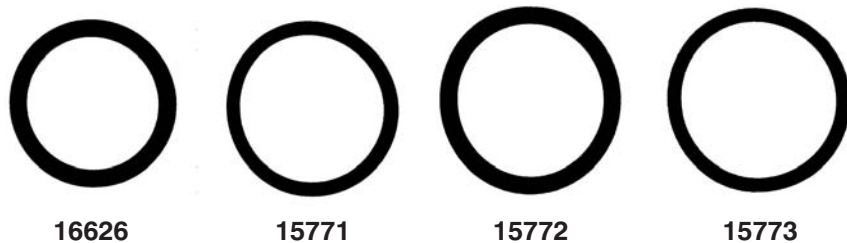
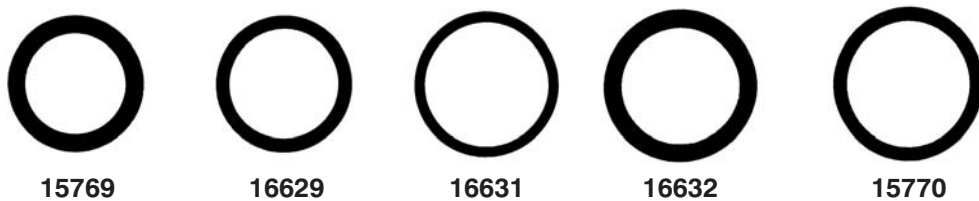
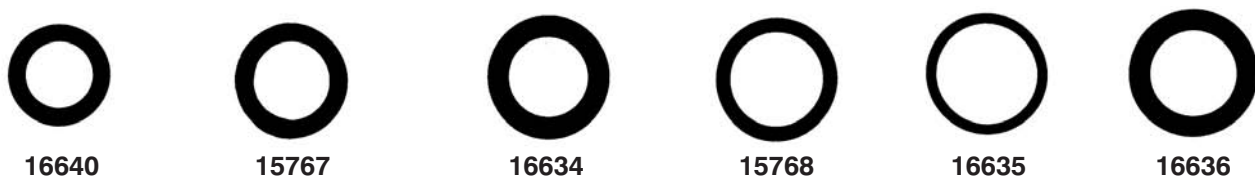
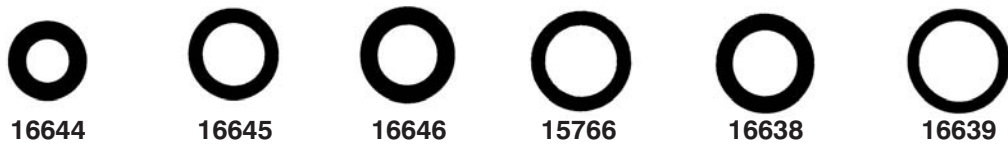
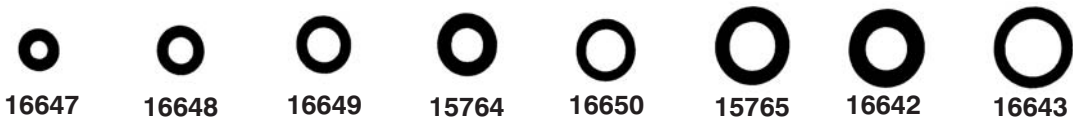

Auveco Part No.	Inner Diameter	Outer Diameter	Thickness	Unit Pkg.
16647	2.2mm	5.4mm	1.6mm	50
16648	3.1mm	6.3mm	1.6mm	50
16649	4.1mm	7.3mm	1.6mm	50
15764	4mm	8mm	2mm	100
16650	5mm	8mm	1.5mm	50
15765	6mm	10mm	2mm	100
16642	5.3mm	10.1mm	2.4mm	50
16643	7.1mm	10.3mm	1.6mm	50
16644	5.6mm	10.4mm	2.4mm	50
16645	8mm	12mm	2mm	50
16646	7.6mm	12.4mm	2.4mm	50
15766	9mm	13mm	2mm	100
16638	8.3mm	13.1mm	2.4mm	50
16639	10.1mm	13.3mm	1.6mm	50
16640	8.6mm	13.4mm	2.4mm	50

Auveco Part No.	Inner Diameter	Outer Diameter	Thickness	Unit Pkg.
15767	10mm	15mm	2.5mm	100
16634	10mm	16mm	3mm	50
15768	12mm	16mm	2mm	100
16635	13mm	16mm	1.5mm	50
16636	11mm	17mm	3mm	50
15769	13mm	18mm	2.5mm	100
16629	14mm	18mm	2mm	50
16631	16mm	19mm	1.5mm	50
16632	15mm	20mm	2.5mm	50
15770	16mm	20mm	2mm	50
16626	17mm	22mm	2.5mm	25
15771	19mm	23mm	2mm	50
15772	19mm	24mm	2.5mm	50
15773	20mm	24mm	2mm	50

O-RINGS

Air Conditioning O-Rings

For use with R12 Refrigerant only

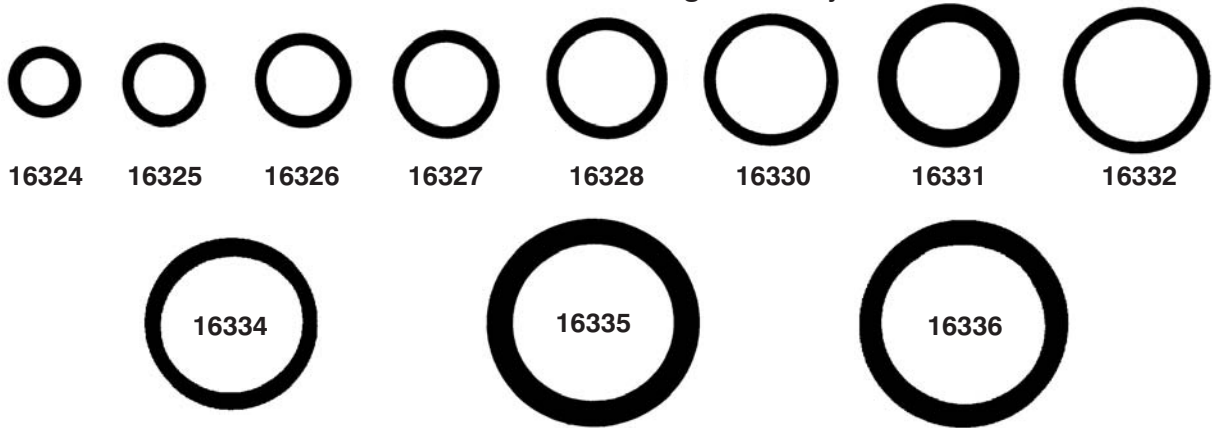

For original air conditioning systems. Not for use with R134A refrigerant.

Auveco Part No.	Ind. Std.	I.D.	O.D.	Thick-ness	Unit Pkg.	Auveco Part No.	Ind. Std.	I.D.	O.D.	Thick-ness	Unit Pkg.
16324	010	1/4"	3/8"	1/16"	50	16331	113	9/16"	3/4"	3/32"	25
16325	011	5/16"	7/16"	1/16"	50	16332	016	5/8"	3/4"	1/16"	50
16326	012	3/8"	1/2"	1/16"	50	16334	018	3/4"	7/8"	1/16"	25
16327	013	7/16"	9/16"	1/16"	50	16335	211	13/16"	1-1/16"	1/8"	10
16328	014	1/2"	5/8"	1/16"	50	16336	118	7/8"	1-1/16"	3/32"	25
16330	015	9/16"	11/16"	1/16"	50						

Nitrile Air Conditioning O-Rings

For use with R12 & R134A Refrigerant

These O-Rings are either green or black with an orange dot.

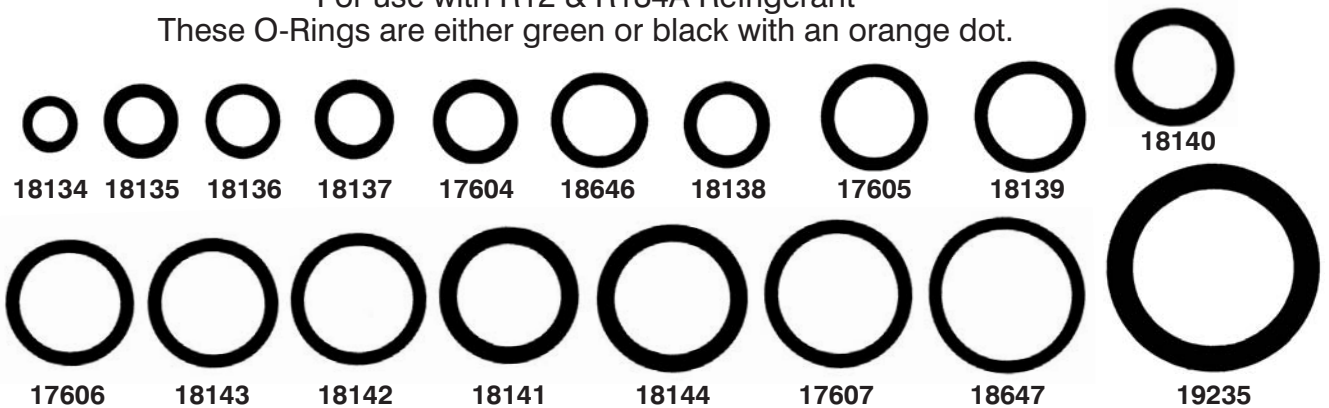

Auveco Part No.	I.D.	O.D.	Thickness	OEM No.	Unit Pkg.
18134	4.5mm	7.3mm	1.4mm	Nissan: 92472-N8200	25
18135	6mm	9.6mm	1.8mm	Nissan: 92470-N8200	25
18136	6.5mm	9.5mm	1.5mm	Toyota: 90099-14044	25
18137	6.6mm	10.2mm	1.8mm	Acura: 80873-ST7-000	25
17604	.290"	.432"	.071"	Ford: 391396	25
18138	7.7mm	11.3mm	1.8mm	Nissan: 92474-N8200	25
18646	.375"	.500"	.063"		25
17605	.400"	.546"	.073"	Ford: 391397	25
18139	10.8mm	14.4mm	1.8mm	Nissan: 92471-N8200	25
18140	10.7mm	15.5mm	2.4mm	Acura: 80872-ST7-000 Nissan: 92475-W1000	25
17606	.509"	.655"	.073"	Ford: 391304	25
18143	13.4mm	17.2mm	1.9mm	Toyota: 90099-14045	15
18142	14mm	17.6mm	1.8mm	Nissan: 92473-N8200	25
18141	13.3mm	18.1mm	2.4mm	Acura: 80871-ST7-000	25
18144	14.8mm	19.6mm	2.4mm	Nissan: 92475-W2100	15
17607	.617"	.769"	.076"	Ford: 391305	15
18647	.688"	.813"	.063"		25
19235	13/16"	1-1/16"	1/8"		10

Blue Neoprene Air Conditioning O-Rings

Teflon Coated • For use with R134A & R12 Refrigerant



18533



18534



18535



18536



18537



18539



18540



18543



19666

Auveco Part No.	Industry Standard	Inner Diameter	Outer Diameter	Thickness	Unit Pkg.
18533	108	1/4"	7/16"	3/32"	25
18534	011	5/16"	7/16"	1/16"	25
18536	110	3/8"	9/16"	3/32"	25
18537	013	7/16"	9/16"	1/16"	25
18539	112	1/2"	11/16"	3/32"	25
18540	015	9/16"	11/16"	1/16"	25
18543	017	11/16"	13/16"	1/16"	25
19666	115	11/16"	7/8"	3/32"	25

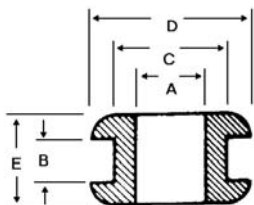

Rubber Grommet

Made of SBR Material • Durometer Hardness 60



UNIT PACKAGE: 25

Auveco Part No.	A Bore Dia.	B Groove Width	C Groove Dia.	D Outside Dia.	E Overall Thickness
4408	1/8"	3/32"	3/8"	1/2"	5/16"
4410	5/32"	1/16"	1/4"	3/8"	3/16"
4411	5/32"	3/32"	1/4"	7/16"	3/8"
4413	3/16"	1/16"	5/16"	1/2"	1/4"
4414	3/16"	3/32"	9/32"	3/8"	5/16"
4415	3/16"	1/4"	5/16"	7/16"	3/8"
16454	1/4"	1/16"	3/8"	1/2"	3/16"
4417	1/4"	1/16"	7/16"	5/8"	3/16"
4418	1/4"	1/16"	1"	1-1/4"	1/4"
4419	5/16"	1/16"	7/16"	9/16"	3/16"
4420	5/16"	1/16"	9/16"	13/16"	5/16"
16455	5/16"	1/16"	3/4"	1"	5/16"
4421	5/16"	1/8"	9/16"	13/16"	3/8"
4422	5/16"	1/4"	9/16"	13/16"	1/2"
4423	3/8"	1/16"	1/2"	11/16"	9/32"

Auveco Part No.	A Bore Dia.	B Groove Width	C Groove Dia.	D Outside Dia.	E Overall Thickness
16456	3/8"	1/16"	5/8"	7/8"	11/32"
4425	3/8"	1/16"	1"	1-1/4"	1/4"
4426	3/8"	1/4"	5/8"	7/8"	1/2"
16457	7/16"	1/16"	9/16"	3/4"	1/4"
4428	1/2"	3/32"	3/4"	31/32"	9/32"
4429	1/2"	3/32"	25/32"	1"	11/32"
16458	1/2"	1/8"	3/4"	1"	1/2"
4430	1/2"	1/4"	13/16"	1-1/16"	1/2"
4431	5/8"	1/8"	7/8"	1-1/8"	3/8"
4432	5/8"	1/16"	7/8"	1-1/8"	5/16"
4433	3/4"	1/16"	15/16"	1-1/8"	1/4"
4434	3/4"	1/16"	1-1/16"	1-3/8"	3/8"
4435	3/4"	1/16"	1-1/4"	1-5/8"	1/4"
4436	3/4"	1/4"	1-1/4"	1-5/8"	7/16"

Vinyl Grommet

- Black Vinflex 163
- Exceptional Aging Qualities
- High Dielectric Properties
- Oil Resistant
- Non-Conductive
- Durometer Hardness 60
- Excellent Resistance to
- Ozone and Sunlight

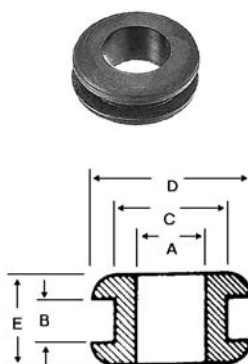

14765

- “A” Bore Diameter: 5/16”
- “B” Groove Width: 1/16”
- “C” Groove Diameter: 7/16”
- “D” Outside Diameter: 5/8”
- “E” Overall Thickness: 1/4”

UNIT PACKAGE: 50

Tubeless Tire Valves



Length: 1-1/4”
Rim Hole: 29/64”
(TR413)

10184
UNIT PACKAGE: 5

10191
UNIT PACKAGE: 25

10192
UNIT PACKAGE: 100

PICKUP TRUCK CAP WEATHERSTRIP TAPE

Photo not actual size



Closed-cell foam weatherstrip tape. Used on the bottom lip of the cap or the truck’s flange to form a moisture, dust and vibration resistant seal. Features an aggressive acrylic adhesive.

Exact Size Profile



20922
Light Gray

1-1/4” Width x 30 Ft. Length
Thickness: 3/16”

UNIT PACKAGE: 1 Roll

Sec. 16

SPONGE WEATHERSTRIPS

Peel-Bak Adhesive Neoprene Sponge Weatherstrip

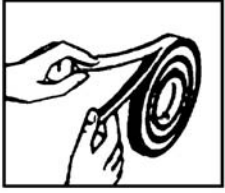

Peel back liner.



Press on clean dry surface

Peel-Bak is a light-weight closed cell sponge material. It is an easy to apply weatherstrip for auto and household use. Can also be used on boats, refrigerators or any place a weatherproof, permanent seal is required. Simple to use: Peel back the liner tape and press into place. No cement or tacking required. Surface must be clean and dry.



Photo not actual size

Thickness	Width	10 Ft. Roll Auveco Part No.	50 Ft. Roll Auveco Part No.
5/32"	3/8"	4800	4850
5/32"	1/2"	4801	4851
5/32"	5/8"	4802	4852
5/32"	3/4"	4803	4853
5/32"	1"	4804	4853
5/16"	3/8"	4805	4854
5/16"	1/2"	4806	4855
5/16"	5/8"	4807	4856
5/16"	3/4"	4808	4856
5/16"	1"	4809	4857
7/16"	3/8"	4810	4858
7/16"	1/2"	4811	4859
7/16"	3/4"	4812	4860
7/16"	1"	4813	4861

Exact Size Profile

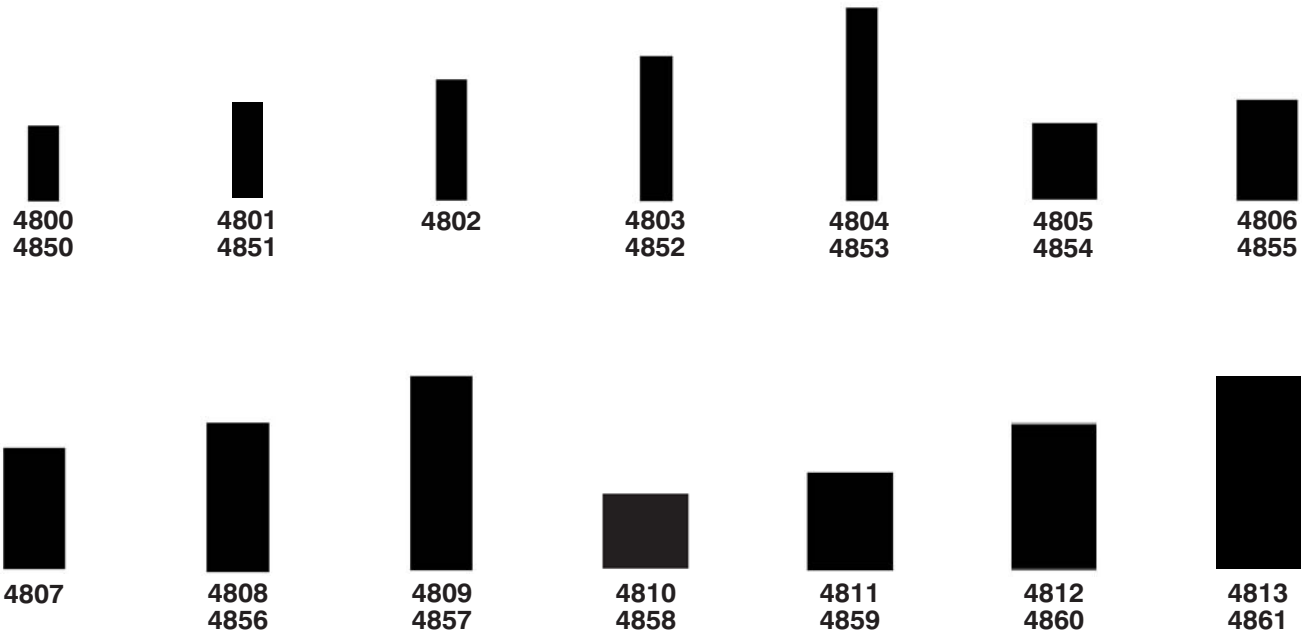

PVC Foam Adhesive Weatherstrips



Peel back liner.



Press on clean dry surface

Low density, PVC (polyvinyl chloride) foam weatherstrip with a permanent acrylic adhesive for easy application even on irregular or curved surfaces. Seals out air, moisture, dust and light. It is also cushioning against vibration and noise. Remains flexible at -20° C to 80° C (-4° F to 176° F).

Color: Light Gray

Photo not actual size



Thickness	Width	10 Ft. Roll Auveco Part No.	50 Ft. Roll Auveco Part No.
3/16"	1/2"	20912	
5/16"	3/4"	20914	20915
5/16"	1"	20916	20917
7/16"	3/4"	20918	20919
7/16"	1"	20920	

Exact Size Profile



Sponge Rubber Weatherstrips

EPDM Closed Cell • Light Weight • Weather Resistant



16390

Door Flange Weatherstrip
GM, Ford & Chrysler
Cars & Trucks

UNIT PACKAGE: 15 Ft.



16395

Trunk & Rear
Deck Gutter
Weatherstrip
GM

UNIT PACKAGE: 15 Ft.



4675

Same as 16390 except for unit package quantity

UNIT PACKAGE: 50 Ft.

4703

Same as 16395 except for unit package quantity

UNIT PACKAGE: 50 Ft.



4707

Door Flange Weatherstrip
Chrysler 1954-50
Ford 1958-50

UNIT PACKAGE: 50 Ft.



4731

Door Flange Weatherstrip
GM 1954-53
Universal

UNIT PACKAGE: 50 Ft.



4747

Door Inner Belt
Weatherstrip
All Cars 1970-55

UNIT PACKAGE: 50 Ft.



16392

Door Flange
Weatherstrip
Ford 1955-On

UNIT PACKAGE: 15 Ft.



4745

Same as 16392 except for unit package quantity

UNIT PACKAGE: 50 Ft.

SPONGE RUBBER WEATHERSTRIPS

EPDM Closed Cell • Light Weight • Weather Resistant



4742

Trunk & Lid
Weatherstrip
GM 1959 - On
Ford 1949 - On
Studebaker 1967 - 55



UNIT PACKAGE: 50 Ft.



16394

Deck Lid
Weatherstrip
GM 1956 - On



UNIT PACKAGE: 15 Ft.

4749

Same as 16394 except for unit package quantity.

UNIT PACKAGE: 50 Ft.



16391

Door Flange Weatherstrip
GM: 1955 - On



UNIT PACKAGE: 15 Ft.

4744

Same as 16391 except for unit package quantity.

UNIT PACKAGE: 50 Ft.



16393

Door Flange
Weatherstrip
Chrysler 1958 - On



UNIT PACKAGE: 15 Ft.

4746

Same as 16393 except for unit package quantity.

UNIT PACKAGE: 50 Ft.



16890

Door Flange
Weatherstrip
Ford 1956 - 53



UNIT PACKAGE: 25 Ft.

16891

Same as 16890 except for unit package quantity.

UNIT PACKAGE: 50 Ft.



4743

Trunk
Weatherstrip
Universal



UNIT PACKAGE: 35 Ft.



16892

Roof Rail Weatherstrip
GM 1977 - 68



UNIT PACKAGE: 25 Ft.



4750

(C5AZ-6243720-B)

Deck Lid
Weatherstrip
Ford 1956 - On



UNIT PACKAGE: 50 Ft.

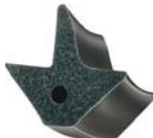

20928

Door Flange,
Trunk & Tail Gate
Weatherstrip
Hole Diameter: 3/32"
Universal



UNIT PACKAGE: 25 Ft.

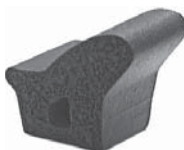

16525

Door Seal Weatherstrip
GM 1963 - 55



UNIT PACKAGE: 50 Ft.

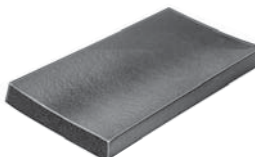

**Extruded Closed Cell
Sponge Rubber**

Will not absorb water or moisture.
Without Cement.

19341

Exact Size Profile

1/8" Thick -3/4" Wide

UNIT PACKAGE: 25 Ft.

4740

Exact Size Profile

1/8" Thick -1-1/2" Wide

UNIT PACKAGE: 25 Ft.

SPONGE RUBBER WEATHERSTRIPS

EPDM Closed Cell • Light Weight • Weather Resistant

Sec. 16



Closed Cell Half Round Sponge Rubber

UNIT PACKAGE: 50 Ft.



4736

1/4" Half Round



4737

3/8" Half Round



4738

1/2" Half Round



Closed Cell Sponge Rubber Windlace Cord

Flexible filler for cloth covered
windlace on door, windshield
pillars and door bottoms.

UNIT PACKAGE: 50 Ft.



4654

1/4" Diameter



4655

3/8" Diameter



4656

1/2" Diameter

RUBBER BUMPERS & GROMMETS



4280

(3745361, 3762180)

License Plate Bumper
GM

UNIT PACKAGE: 25



4260

(17562)

Windshield Wiper Rubber Grommet
Inner Diameter: 11/32"
Outer Diameter: 5/8"
Thickness: 3/16"
Ford

UNIT PACKAGE: 25



4246

(357811)

Gas Tank Lid Rubber Bumper
Ford

UNIT PACKAGE: 25



4242

(4137121)

Trunk, Rear Deck Lid, &
Hood Bumper
GM

UNIT PACKAGE: 25



4243

(513388)

Hood to Ledge Bumper
GM

UNIT PACKAGE: 25



4265

(3711168)

Door Lock Striker Plate, Window Glass
Stop & License Plate Bumper
GM

UNIT PACKAGE: 25



4188

(4081765)

Door & Quarter Glass and
Door Opening Header Bumper
GM

UNIT PACKAGE: 25



4237

(3664645)

General Purpose
GM

UNIT PACKAGE: 25



4235

(3688811)

Hood Top Panel Side
Bumper to Fender
GM

UNIT PACKAGE: 25



4248

(16758)

General Purpose
Ford

UNIT PACKAGE: 25



4258
(352839)

General Purpose
Ford

UNIT PACKAGE: 25



4233
(3655015)

General Purpose
GM

UNIT PACKAGE: 25



4447
(7724826)

Trunk Lid Bumper
GM

UNIT PACKAGE: 10



4273
(B7A-16758-A)

Hood Bumper
Ford

UNIT PACKAGE: 25



13967

General Purpose
Outer Diameter: 1/2"
Head Height: 5/16"
Fits into 1/4" Hole
Durometer: 55-65

UNIT PACKAGE: 25



4369
(3900684, 15029828)

Pillar Bumper
GM Trucks

UNIT PACKAGE: 25



4446
(4872948)

Trunk Lid Bumper
GM

UNIT PACKAGE: 25



4249
(1304225)

General Purpose
GM

UNIT PACKAGE: 25



4264
(4564974)

Front Door Bumper
GM

UNIT PACKAGE: 25



4250
(3693292)

Glove Box Door Bumper
GM

UNIT PACKAGE: 25



4441
(4565591, 7637192)

Front Door Bumper
GM

UNIT PACKAGE: 25



4155
(16758A)

General Purpose
Ford

UNIT PACKAGE: 25



4357
(C60Z-16758-A)

Hood to Fender Bumper
Ford

UNIT PACKAGE: 25



4244
(972724)

General Purpose
Chrysler

UNIT PACKAGE: 25



4204
(4023030)

General Purpose
Ford & Chrysler

UNIT PACKAGE: 25



4240
(4563173, 4565415)

Door Bumper
GM

UNIT PACKAGE: 25



4236
(3689084)

General Purpose
GM

UNIT PACKAGE: 25



4281
(4721222)

Trunk Lid Bumper
GM

UNIT PACKAGE: 25



20698
Black Rubber

Cigarette Lighter Safety Plug
Used to replace unwanted
cigarette lighters. Prevents
accidental shocks and burns.
Discourages smoking in the car.
The tight fit deters removal.

UNIT PACKAGE: 2



15453
(472450, 12338034)

Hood Bumper
Across the Flats: 1"
Diameter: 15/16"
Overall Length: 1-29/32"
GM X Cars 1980 - On

UNIT PACKAGE: 10



4474
(400764, 400765)

5/16-18 x 2-1/8"
Hood Adjusting Bolt & Bumper
GM

UNIT PACKAGE: 5

4473
Same as 4474 except for unit package quantity

UNIT PACKAGE: 10



16849
(Not Supplied by O.E.M.)
Nylon

Hood Adjustment Nut
Threaded Insert: M6-1.0
Ford 1989 - On

UNIT PACKAGE: 10

16850
(Not Supplied by O.E.M.)
Zinc

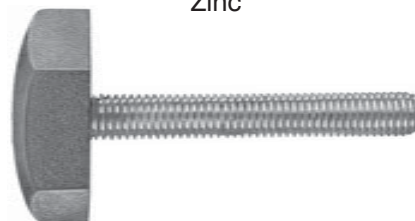

M6-1.0 x 44mm
Hood Adjustment Bumper
Hex: 23mm
Ford 1989 - On

UNIT PACKAGE: 5

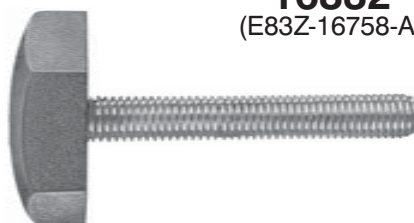

16832
(E83Z-16758-A)

Hood Adjustment Nut & Bumper
Ford 1989 - On

UNIT PACKAGE: 2 Sets

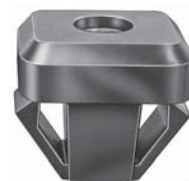



Door Seals

Years	Vehicle	Application	O.E.M. Number	Auveco Part No.
1991-73	Blazer, Jimmy & Suburban	Driver & Passenger Rear Side	15606409, 15227654, 15227655	20792
1987-73	Pickup	Driver & Passenger Side	15606409, 15227654, 15227655	20792



Window Channels



Years	Vehicle	Application	O.E.M. Number	Auveco Part No.
1991-73	Blazer, Jimmy & Suburban	Complete Glass Run with metal clip Front – Driver Side	14027777	20793
1991-73	Blazer, Jimmy & Suburban	Complete Glass Run with metal clip Front-Passenger Side	14027778	20794
1987-73	Pickup	Complete Glass Run with metal clip Front-Driver Side	14027777	20793
1987-73	Pickup	Complete Glass Run with metal clip Front-Passenger Side	14027778	20794

Belt Weatherstrips



Years	Vehicle	Application	O.E.M. Number	Auveco Part No.
1991-81	Blazer, Jimmy & Suburban	Inner-Driver Side	15569071	20797
1991-81	Blazer, Jimmy & Suburban	Inner-Passenger Side	15569072	20798
1991-73	Blazer, Jimmy & Suburban	Outer-Driver Side	14027775	20799
1991-73	Blazer, Jimmy & Suburban	Outer-Passenger Side	14027776	20800
1987-81	Pickup	Inner-Driver Side	15569071	20797
1987-81	Pickup	Inner-Passenger Side	15569072	20798
1987-73	Pickup	Outer-Driver Side	14027775	20799
1987-73	Pickup	Outer-Passenger Side	14027776	20800
1980-73	Pickup, Jimmy, Blazer & Suburban	Inner-Driver Side	470433	20795
1980-73	Pickup, Jimmy, Blazer & Suburban	Inner-Passenger Side	470434	20796



Vent Window Seals

Years	Vehicle	Application	O.E.M. Number	Auveco Part No.
1980-73	Pickup, Jimmy, Blazer & Suburban	Front Driver Side (Vertical sold separately)	6271903	20801
1980-73	Pickup, Jimmy, Blazer & Suburban	Front Passenger Side (Vertical sold separately)	6271904	20803
1980-73	Pickup, Jimmy, Blazer & Suburban	Rear Vertical-Driver Side	6271905	20802
1980-73	Pickup, Jimmy, Blazer & Suburban	Rear Vertical-Pass. Side	6271906	20804

GLASS SETTING CHANNELS

EPDM Dense Rubber

Sec. 16



4511

For 1/8" Glass
Glass Setting Channel
Height: 11/32"
Width at Base: 1/4"
Inside Base: 1/8"

UNIT PACKAGE: 50 Ft.



4513

For 1/4" Glass
Windshield and Rear Window
Glass Setting Channel
Height: 7/16"
Width at Base: 31/64"
Inside Base: 1/4"

UNIT PACKAGE: 50 Ft.



4512

For 3/16" Glass
Windshield and Rear Window
Glass Setting Channel
Height: 7/16"
Width at Base: 27/64"
Inside Base: 3/16"

UNIT PACKAGE: 50 Ft.



4688

For 1/4" Glass
Rear Window Glass
Setting Channel
Chrysler Early Models

UNIT PACKAGE: 50 Ft.



4670

For 1/4" Glass
Windshield &
Rear Window Glass Setting
Channel and Weatherstrip
Ford, Mercury Early Models

UNIT PACKAGE: 50 Ft.



4588

For 1/4" Glass
Windshield and Rear Window
Glass Setting Channel
Height: 9/16"
Width at Base: 7/16"
Inside Base: 1/4"

UNIT PACKAGE: 50 Ft.



4515

For 1/4" Glass
Glass Setting Channel
Height: 9/16"
Width at Base: 25/64"
Inside Base: 1/4"

UNIT PACKAGE: 50 Ft.



4671

For 1/4" Glass
Rear Window Glass
Setting Channel and
Weatherstrip
Chrysler Early Models

UNIT PACKAGE: 50 Ft.

Molded Dense Rubber Tee Rubber Concave Head

UNIT PACKAGE: 50 Ft.



4530

Head: 9/32"
Height: 3/4"

4531

Head: 9/32"
Height: 1"



4581

For 1/4" glass
Windshield Glass Weatherstrip

UNIT PACKAGE: 50 Ft.

Universal Windshield & Rear Window Flex-Fit Rubber Moulding



Photo not actual size

20342

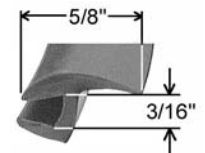

A universal windshield rubber moulding for domestic and import vehicles. Made of EPDM rubber, this moulding contains a butyl bead that adheres to the glass during installation. The profile design allows for the moulding to attach easily to the glass edge and lay evenly on the vehicle body along straight areas and around corners. Extruded with a metal filament to prevent stretching and shrinkage.

UNIT PACKAGE: 15 Feet

Sec. 16

EPDM RUBBER WEATHERSTRIP FOR GLASS

Photos not actual size



17509

Glass Thickness: 1/4"
Body Thickness: 1/16"
Self-Locking Type

UNIT PACKAGE: 50 Ft.



17513

Glass Thickness: 1/4"
Body Thickness: 1/8"
Bead Lock Type
Use with
Auveco 17514

UNIT PACKAGE: 50 Ft.



17510

Glass Thickness: 1/4"
Body Thickness: 1/8"
Self-Locking Type

UNIT PACKAGE: 50 Ft.



17514

Glass Thickness 1/4"
Locking Bead
Use with Auveco 17513

UNIT PACKAGE: 50 Ft.

Caps & Hooks

Rubber Caps

Special Heat Resistant EPDM Rubber
Can be used for capping lines and hoses while testing carburetors, emission control systems, vacuum lines, etc

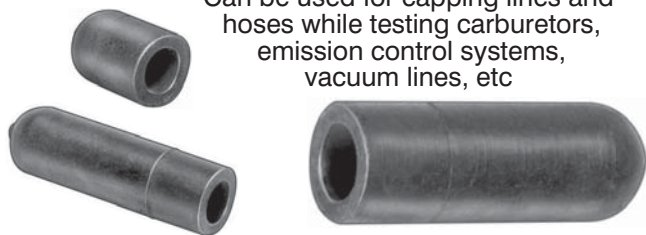

Auveco Part No.	Fits Tube O.D.	Inside Length	Unit Pkg.
12209	1/8"	9/16"	25
4440	3/16"	9/16"	25
16264	3/16"	9/16"	100
19000	3/16"	1-1/4"	25
4439	1/4"	9/16"	25
19001	1/4"	1-1/4"	25
19002	5/16"	9/16"	25
12907	5/16"	1-1/4"	25
12210	3/8"	31/32"	25
19003	3/8"	1-1/2"	25
12908	1/2"	11/16"	10

Vinyl Vacuum Caps

Can be used for capping lines and hoses while testing carburetors, emission control systems, vacuum lines, etc. Color coded for size identification.



Auveco Part No.	I.D.	Fits Tube O.D.	Color	Length	Unit Pkg.
18202	1/8"	3/16"	Blue	5/8"	50
18203	3/16"	1/4"	Red	5/8"	50
18204	1/4"	5/16"	White	5/8"	50
18205	5/16"	3/8"	Black	5/8"	50

Rubber Hold Down Straps with Hooks

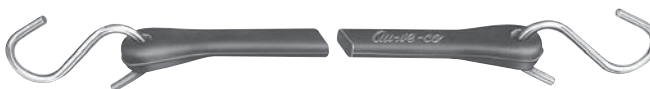

Auveco Part No.	Length	Span Range	Unit Pkg.
4448	9"	15" to 20"	10
4449	15"	20" to 30"	10
4450	20"	30" to 40"	10
4451	31"	40" to 55"	10



11298

Galvanized

3/16" x 3"
"S" Hook
Used with Auveco
Rubber Hold Down
Straps 4448, 4449,
4450 and 4451

UNIT PACKAGE: 50

11299

Same as 11298 except
for unit package quantity

UNIT PACKAGE: 100



18979
(3767196)

Windshield Setting Block
Lower Spacer
Chrysler Caravan,
Voyager and Town & Country
1984 - On

UNIT PACKAGE: 15

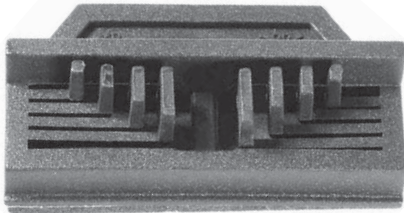

21195
(15061964)
Black Nylon

Windshield Glass
Setting Block with
Adhesive Backing

Overall Length: 51mm
Buick Rainier; Cadillac Escalade; Chevrolet
Avalanche, Colorado, Silverado, Suburban, Tahoe
& Trailblazer; GMC Canyon, Envoy, Sierra & Yukon;
Hummer H2 & H3 Oldsmobile Bravada and Saab 9-7
1999 - On

UNIT PACKAGE: 10



20836
(4L3Z-1503296-AB)
Black Nylon

Windshield Setting Block
Ford Pick-Up Trucks
2004 - On

UNIT PACKAGE: 5



19816
(55256967AC)
Black & Natural
Nylon

Windshield Glass
Adjustable Setting Block
NAGS Numbers:
DW0999 & DW1295
Dodge Dakota & Durango 1997 - On

UNIT PACKAGE: 10



20942
(F6DZ-5403296-A)
Black Nylon

Windshield Setting Block
Width: 1-5/32"
Length: 1-1/8"
Height: 13/16"
Fits into 9/32" Square Hole
Ford Sable & Taurus 1996 - On

UNIT PACKAGE: 10



19817
Black Nylon

Universal Glass Setting Block
Width: 1-3/16"
Height: 7/16"
Length: 15/16"

UNIT PACKAGE: 25



3135

Window Regulator
Roller Assembly
Ford

UNIT PACKAGE: 25



10843
(3696693)
Nylon

Front Door Glass Lift to Stabilizer Bushing
Chrysler

UNIT PACKAGE: 50



21423
(BMW: 51321-938-884)
White Nylon

Window Regulator Guide
BMW 3 & 5 Series 1989 - On

UNIT PACKAGE: 2



2598
(353745-S)

Window Regulator Arm to Plate
Assembly Clip
Ford

UNIT PACKAGE: 100



1267

Lacquered

Inside Door Handle &
Quarter Regulator
Handle Escutcheon
Tension Spring

UNIT PACKAGE: 25



2288
Zinc

Door & Window Crank Handle
Retaining Clip
GM, Ford & Toyota

UNIT PACKAGE: 100



9886

Door & Window Crank Handle Retaining Clip

UNIT PACKAGE: 100



11

Coppered Spring Steel

Door & Window Crank Handle Retaining Clip
GM

UNIT PACKAGE: 100



16340

(54229-0201P)

Window Crank Handle Retaining Clip
Nissan

UNIT PACKAGE: 100



11152

(GM: 9731301; AMC: 4005540)
White Nylon

Windshield to Panel (Lower) Side Moulding Clip
GM 1975 - On
AMC 1975 - On

UNIT PACKAGE: 100



15813

(4005714)
Nylon

Window Glass Retainer
AMC Eagle 1988 - On

UNIT PACKAGE: 25



9633

(7698976)

Windshield Upper & Lower Moulding Clip
GM 1967 - On

UNIT PACKAGE: 100



9749

(7730788)

Windshield, Skylight, Quarter & Rear Window Reveal Moulding Clip
GM 1968 - On

UNIT PACKAGE: 50



8583

(4533699)

Rear Window Reveal Moulding Clip
GM 1965 - On

UNIT PACKAGE: 100



9275

(7634583, 8734067)

Rear Window Reveal Moulding Clip
GM 1966 - On

UNIT PACKAGE: 50

10242

Same as 9275 except for unit package quantity

UNIT PACKAGE: 100



9639

(7693140)

Windshield, Skylight, Rear & Quarter Window Reveal Moulding Clip
GM 1966 - On

UNIT PACKAGE: 50



11066

(9624520)

Window Reveal Moulding Clip
GM 1973 - On

UNIT PACKAGE: 50



11067

(9606232, 9662950, 20603072)

Windshield & Rear Window Reveal Moulding Clip
GM 1973 - On

UNIT PACKAGE: 100



10243

(8717859)

Rear Window Reveal Moulding Clip
GM 1969 - On

UNIT PACKAGE: 100



10701

(9895598)

Windshield Reveal Moulding Clip
GM 1971 - On

UNIT PACKAGE: 50



10630
(9808241)

Windshield & Rear Window Reveal
Moulding Clip
GM 1970 - On

UNIT PACKAGE: 50



10631
(9854717)

Windshield Reveal Moulding Clip
GM 1970 - On

UNIT PACKAGE: 50



11345
(1654047)
Nylon

Windshield & Rear Window Reveal
Moulding Clip
GM 1974 - On

UNIT PACKAGE: 100



12135
(20169887)
Nylon

Windshield Reveal Moulding Clip
GM 1979 - On

UNIT PACKAGE: 50



11152
(GM: 9731301; AMC: 4005540)
White Nylon

Windshield to Panel (Lower)
Side Moulding Clip
GM 1975 - On
AMC 1975 - On

UNIT PACKAGE: 100



20232
(10287926)
Yellow Nylon

Front & Rear Door
Window Moulding Clip
Overall Length: 1-9/16"
Buick Century & Regal
and Oldsmobile Intrigue 1997 - On

UNIT PACKAGE: 25



17355
(GM: 94467458;
Isuzu: 8944674584)
Nylon

Windshield Reveal Moulding Clip
Geo Storm 1992 - On

UNIT PACKAGE: 10



20263
(22599312)
Black Nylon

Front & Rear Door
Window Moulding Clip
Chevrolet Malibu, Oldsmobile
Achieva & Cutlass 1997 - On

UNIT PACKAGE: 25



2628
(4657731)

Windshield & Rear Window
Reveal Moulding Fastener
GM

UNIT PACKAGE: 100



20276
(6003409, 6003752)

Windshield & Rear Window
Reveal Moulding Clip
Replaces Auveco 11177 & 13569
Chrysler 1974 - On

UNIT PACKAGE: 25



10622
(6002893)

Rear Window Reveal Moulding Clip
Chrysler 1971 - On

UNIT PACKAGE: 50



17151
(6004036)
Nylon

Window Reveal Moulding Clip
Chrysler LeBaron & Maserati
1987 - On

UNIT PACKAGE: 15



9882
(C8AZ-63642413-A,
D1AZ-6542413-B,
D1AB-6542413-AB)

Windshield & Rear Window
Reveal Moulding Clip
Ford 1968 - On

UNIT PACKAGE: 100



9353
(C6AB-6242413-A)

Rear Window
Reveal Moulding Clip
Ford 1967 - On

UNIT PACKAGE: 100



8941
(C5ZZ-6543413-B)

Windshield & Rear Window
Reveal Moulding Clip
Ford 1966 - On

UNIT PACKAGE: 100



13564
(E3SB-6342413-AB)

Windshield & Bakelite
Reveal Moulding Clip
Ford 1983 - On

UNIT PACKAGE: 50



21526
(Not Available from O.E.M.)
White Nylon

Windshield Moulding Clip
Head Size: 14.5mm x 30mm
Bottom Leg Width: 26mm
Ford Flex 2009 - On

UNIT PACKAGE: 25



20424
(Not Available from O.E.M.)
White Nylon

Front Door Window Guide
Overall Length: 1-13/32"
Buick Electra, Park Ave. & Skylark; Chevrolet Malibu;
Oldsmobile Achieva, Alero, Cutlass & 98 Regency
and Pontiac Grand Am 1985 - On

UNIT PACKAGE: 5



21022
(4339372)
Black Nylon

Window Guide
with Rivets
Chrysler Acclaim,
GTS, Lancer, LeBaron,
Shadow, Spirit &
Sundance 1989 - On

UNIT PACKAGE: 25



15462
(20478733,
22539533)
Nylon

Front Door Window
Guide Rear of Glass
Buick Skylark & Somerset 1991 - 85
Chevrolet Lumina APV 1990 - On
Olds Calais 1991 - 85
Olds Silhouette 1990 - On
Pontiac Grand Am 1991 - 85
Pontiac Trans Sport 1990 - On

UNIT PACKAGE: 15

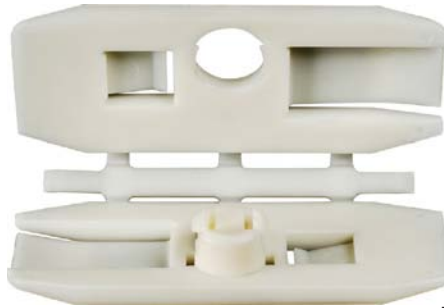

19397
(21098967)
Nylon

Front &
Rear Door
Window Guide
Saturn Sedan &
Wagon
1996 - On

UNIT PACKAGE: 5



15463
(12353912, 20487630, 20712176)
Nylon

Front Door Window Guide
Front of Glass (4mm Thick)
Buick Skylark & Somerset 1991-85
Chevrolet Lumina APV 1990-On; Olds Calais 1991-85;
Olds Silhouette 1990-On; Pontiac Grand Am 1991-85
Pontiac Trans Sport 1990-On

UNIT PACKAGE: 15



15466
(20160591)
Nylon

Front Door
Window Guide
Upper Part of Glass
LeSabre 90-80 &
Electra 84-On; Fleetwood Brougham & DeVille 83-On;
Impala & Caprice 90-80 & Cavalier 87; Delta 88 &
Custom Cruiser 90-80 & 98 Regency 84-80;
Parisienne & Safari 89-81 & Sunbird 87

UNIT PACKAGE: 25



15467

(10051034, 20123070, 20328600)
Nylon

Front & Rear Door Window Guide Electra, Estate Wagon, LeSabre & Skylark; DeVille; Impala Wagon, Caprice & Citation; Delta 88, Custom Cruiser, 98 Regency & Omega; Catalina, Safari & Phoenix 81 - 80

UNIT PACKAGE: 25

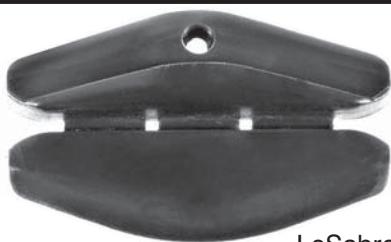

17159

(20747509)
Nylon

Front Door Window Guide Rear of Glass Buick Electra & LeSabre Cadillac Fleetwood/DeVille Olds Delta & Regency Pontiac Bonneville 1985 - On

UNIT PACKAGE: 15

Photo not actual size



19819

(10274778)
Nylon

Front Side Door Window Guide Chevrolet Venture APV, Oldsmobile Silhouette APV, Pontiac Montana & Trans Sport APV 1997 - On

UNIT PACKAGE: 10



17176

(20162174, 22543363)
Nylon

Front Door Window Guide Buick Skyhawk, Cadillac Cimarron, Chevrolet Cavalier, Olds Firenza & Pontiac Sunbird 1982-On

UNIT PACKAGE: 25



17341

(12337898, 20747508)
Nylon

Front Door Window Guide Front of Glass Buick Electra, LeSabre & Park Ave., Cadillac Fleetwood & DeVille, Olds 88 Royal & 98 Regency, Pontiac Bonneville 1985-On

Photo not actual size

UNIT PACKAGE: 15



17455

(20493450)
Nylon

Rear Door Window Guide Upper Glass Chevrolet Corsica 1987 - On

UNIT PACKAGE: 15



18113

(69951-12180)

Nylon with Steel Treaded Insert

Glass Mount Thread: M6-1.0 Nissan, Ford & Imports

UNIT PACKAGE: 5



19393

(F1TZ-17698A)

Rear View Mirror Bracket (Windshield Mounted) NAGS numbers DW 1256, 1099 1169 & 1170

Fits Ford Mirrors F0TZ-17700-A & F7AZ-17700-A on Ford & L-M Continental, Contour, Escort, Mustang, Mystique, Sable, Taurus & Tracer 1991 - On

UNIT PACKAGE: 10



19394

(20626174)

Rear View Mirror Bracket (Windshield Mounted) NAGS numbers 1168, 1191, 1192, 1193, 1194, 1195, 1265, 1288 & 1299 GM 1987-On

UNIT PACKAGE: 10



19498

Black Nylon

Rear View Mirror Adapter Bracket

This adapter bracket allows you to reuse the original mirror when a windshield is replaced. If the new windshield comes with a steel mirror button attached, this adapter fits over the button. Then the original mirror can be fitted onto the bracket.

GM & Chrysler 1981 - On

UNIT PACKAGE: 3

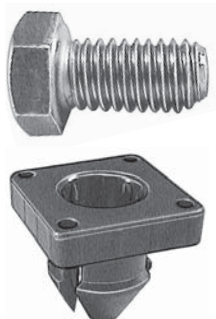

19281
(F5RZ-5421416B)

Door Window Glass to
Regulator Fastener Assembly
3/8"-16 x 3/4"
Grade 8 Cap Screw
Ford Contour & Mystique
1995 - On

UNIT PACKAGE: 2 Sets



20309
(5008055AA)
Natural Nylon

Window to
Regulator
Grommet

Screw Size: #14 (M6.3)
Overall Length: 57mm
Stem Length: 10mm
Fits into 13mm Hole
Dodge Neon 2000 - On

UNIT PACKAGE: 15



17073
(20085729)
Nylon

Window Regulator Drive Block
used with Window
Regulator Tape
GM 1980 - On

UNIT PACKAGE: 25

16959

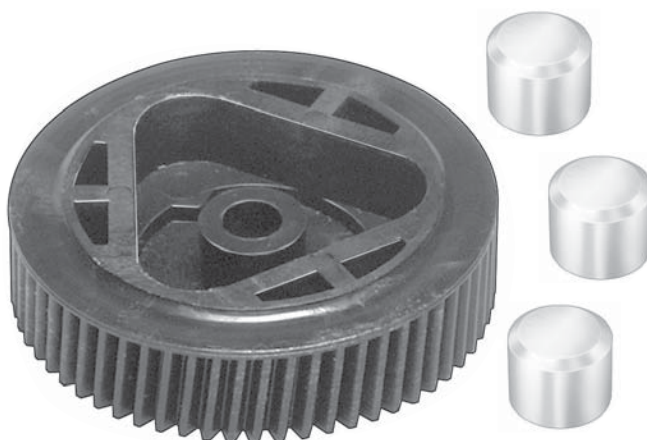

Photo not actual size

Piano Wire
For Cutting through Sealant on
Windshields without Gaskets
Solid not Braided Wire
1/4 Pound (approx. 160 Ft.)
Wire Diameter: .025"

UNIT PACKAGE: 1 Roll

18947



Power Window Regulator Gear & Rollers
Splines: 62
Ford 1989 - On

UNIT PACKAGE: 1



19786

(Not Available from O.E.M.)
Natural Nylon

Torque Pin Kit for
Window Regulator Gear
Pin Diameter: 1/2"
Pin Length: 13/32"
Ford 1964 - On

UNIT PACKAGE: 15

17974

(D0AZ-62234A24)



Power Window
Regulator Gear
Tooth: 9
Splines: 45
Ford 1964 - On

UNIT PACKAGE: 1

HORNS

Photos not actual size

O.E.M. Replacement Horns

19017



Domestic Vehicles - Low Note
Terminals: One/Two
Frequency (Hz): 400
Decibel Rating at 4": 125
Current Draw (Amps): 6
Power Source Volts: 12

UNIT PACKAGE: 1

19019



Import Vehicles - Low Note
Terminals: One/Two
Frequency (Hz): 340
Decibel Rating at 4": 130
Current Draw (Amps): 5
Power Source Volts: 12

UNIT PACKAGE: 1

19018



Domestic Vehicles - High Note
Terminals: One/Two
Frequency (Hz): 500
Decibel Rating at 4": 125
Current Draw (Amps): 6
Power Source Volts: 12

UNIT PACKAGE: 1

19020



Import Vehicles - High Note
Terminals: One/Two
Frequency (Hz): 425
Decibel Rating at 4": 130
Current Draw (Amps): 5
Power Source Volts: 12

UNIT PACKAGE: 1

Freeway Blaster Horns ("Big Rig" Sound)

19021



Low Note
Terminals: One/Two
Frequency (Hz): 400
Decibel Rating at 4": 130
Current Draw (Amps): 6
Power Source Volts: 12

UNIT PACKAGE: 1

19022



High Note
Terminals: One/Two
Frequency (Hz): 500
Decibel Rating at 4": 130
Current Draw (Amps): 6
Power Source Volts: 12

UNIT PACKAGE: 1

Riviera Air Horns & Compressor Kit



19023

Photo not actual size

The Riviera air-powered dual horns sound simultaneously and have the "European" sound. Comes complete with a 12 volt compressor, relay, tubing and mounting hardware.

UNIT PACKAGE: 1 Set

19024

Photo not actual size



Horn Relay
12 Volt

UNIT PACKAGE: 1

Horn Application Guide

Year	Make & Model	Original Equipment Replacement	Freeway Blaster (Optional)
ACURA			
12-90	All Models	*19022 & 19021	
AMC			
90-79	Alliance, Encore, Talon	19019 & 19020	19022 & 19021
90-74	All Other Models	19018 & 19017	19022 & 19021
AUDI			
12-73	All Models	*19018	*19022
BMW			
12-95	5, 7, & 9 Models	19018 & 19017	19022 & 19021
12-74	All Other Models	19019 & 19020	19022 & 19021
BUICK			
12-86	All Other Models	19022 & 19021	
96-75	Skyhawk & Skylark	*19018	*19022
CADILLAC			
12-75	All Other Models	19022 & 19021	
83-81	Cimarron	*19018	*19022
CHEVROLET			
12-76	Aveo, Beretta, Cavalier, Celebrity, Chevette, Citation, Corsica, Spectrum, Sprint & Nova	*19018	*19022
12-71	Corvette	19022 & 19021	
12-71	All Other Models	19018 & 19017	19022 & 19021
CHEVROLET LIGHT DUTY TRUCKS & VANS			
12-75	S-10	19018 & 19017	19022 & 19021
12-75	All Other Models	19022 & 19021	
CHRYSLER			
12-77	All Other Models	19018 & 19017	19022 & 19021
10-95	Sebring	19019 & 19020	19022 & 19021
97-87	LeBaron & GTS	19018	*19021
DODGE			
12-74	All Other Models	19018 & 19017	19022 & 19021
05-95	Neon	*19020	*19022

Year	Make & Model	Original Equipment Replacement	Freeway Blaster (Optional)
DODGE			
99-87	Charger, Lancer, Omni, Shadow, Spirit	*19018	*19022
98-74	Challenger, Colt	*19020	*19022
DODGE LIGHT DUTY TRUCKS & VANS			
12-87	Dakota, Ram, Pickup, Caravan	*19021	
12-75	All Other Models	19022 & 19021	
FORD			
12-07	Edge	19018 & 19017	19022 & 19021
12-01	Escape	19018 & 19017	19022 & 19021
12-71	Escort, Fairmont, Festiva, Focus, Maverick Mustang II, Pinto, Tempo, Contour	*19018	*19022
12-70	All Other Models	19022 & 19021	
97-77	Fiesta	19020	19022
FORD LIGHT DUTY TRUCKS & VANS			
12-85	All Other Models	19022 & 19021	
90-75	Ranger, E 150/350 Vans, Aerostar, Economize	*19022	
GEO			
12-90	All Other Models	*19019	*19021
99-90	Storm	19019 & 19020	19022 & 19021
GMC LIGHT DUTY TRUCKS & VANS			
12-75	All Other Models	19018 & 19017	19022 & 19021
92-91	Jimmy, Sonoma	*19021	
HONDA			
12-80	Civic, Civic Del Sol	*19020	*19022
12-73	All Other Models	19019 & 19020	19022 & 19021
HYUNDAI			
12-86	All Other Models	19019 & 19020	19022 & 19021
87-84	Pony	19020	19022

Year	Make & Model	Original Equipment Replacement	Freeway Blaster (Optional)	Year	Make & Model	Original Equipment Replacement	Freeway Blaster (Optional)
INFINITI				PLYMOUTH TRUCKS & VANS			
12-90	All Models	19022 & 19021		01-74	All Models	*19017	*19021
ISUZU				PONTIAC			
12-83	Impulse, Stylus, Trooper	19019 & 19020	19022 & 19021	10-95	Trans Sport Montana	19018 & 19017	19022 & 19021
12-81	I Mark, Amigo, Pickup, Rodeo	*19020	*19022	10-75	All Other Models	19018 & 19017	19022 & 19021
JAGUAR				94-93	Trans Sport	*19017	*19021
12-72	All Models	19022	19021	94-82	Astre, J-2000, T-1000, LeMans, Sunbird	19019	*19021
JEEP				87-84	Fiero	19019 & 19020	19022 & 19021
12-74	Cherokee, Grand Cherokee	19022 & 19021		PORSCHE			
12-70	CJ, DJ, Scrambler, Wrangler	*19018	*19022	12-70	All Models	19018 & 19017	19022 & 19021
LEXUS				RANGE ROVER			
12-90	All Models	19022 & 19021		12-01	All Models	19022 & 19021	
LINCOLN-MERCURY				SAAB			
12-74	All Other Models	19022 & 19021		12-79	All Models	19019 & 19020	19022 & 19021
99-71	Capri & Capri II	*19020	*19022	SATURN			
99-71	Bobcat, Lynx, Zephyr, Tracer, Mystique, Topaz	*19018	*19022	10-07	Outlook	19018 & 19017	19022 & 19021
MAZDA				10-90	All Other Models	*19019	*19021
12-91	Navajo	19018 & 19017	19022 & 19021	SUBARU			
12-75	All Other Models	19019 & 19020	19022 & 19021	12-78	All Other Models	19019 & 19020	19022 & 19021
12-71	RX-2, RX-3, Mizer, MX-3, MX-5, Protege, GLC Wagon, B2200, B2601	*19020	*19022	94-87	Justy, Samurai	*19019	*19021
MAZDA TRUCK				SUZUKI SUV			
12-78	All Models	*19019	*19021	12-88	All Models	*19019	*19021
MERCEDES				TOYOTA			
12-73	All Models	19022 & 19021		12-91	Avalon, Camry	19018 & 19017	19022 & 19021
MITSUBISHI				12-80	Starlet, Tercel Sedan, Corolla Coupe, Sedan, Liftback	*19021	*19022
12-83	All Models	19019 & 19020	19022 & 19021	12-72	All Other Models	19018 & 19017	19022 & 19021
NISSAN				TOYOTA TRUCK			
12-97	All Models	19018 & 19017	19022 & 19021	12-81	Land Cruiser & Other Models	19022 & 19021	
96-74	All Other Models	19019 & 19020	19022 & 19021	12-70	4-Runner, Pickup, Van, Paseo	*19020	*19022
90-87	Pulsar	*19020	19022	80-69	Land Cruiser	*19020	*19022
NISSAN TRUCK				VOLKSWAGEN			
12-93	Quest	19018 & 19017	19022 & 19021	12-80	Jetta, Quantum, Fox, Golf, Passat	19019 & 19020	19022 & 19021
12-82	All Other Models	19019	*19021	12-74	All Other Models	*19019	*19021
OLDSMOBILE				VOLVO			
04-91	Bravada	*19017	*19021	12-70	All Other Models	19019 & 19020	19022 & 19021
04-98	Alero	19018 & 19017	19022 & 19021	97-84	240-740-760 Series	*19020	*19022
04-74	All Other Models	19022 & 19021	*19021				
89-88	Firenza	19018	19022				
PLYMOUTH							
01-75	All Other Models	*19018	*19022				
89-71	Arrow, Champ, Colt, Laser	*19020	*19022				

*One horn is standard; however, vehicle may be equipped with optional second horn for better sound. Add another horn of opposite note (high or low).



1720

Door and Quarter Trim
Panel Fastener
Chrysler

UNIT PACKAGE: 100



2385

Door Trim
Panel Fastener
Chrysler

UNIT PACKAGE: 100



2309

Door Trim Panel Fastener
All cars with .125 Panels
Ford

UNIT PACKAGE: 100



808

General Purpose
Head Diameter: 1/2"
Chrysler

UNIT PACKAGE: 100



8206

Door Trim
Panel Fastener
Ford

UNIT PACKAGE: 100



2310

Door Trim
Panel Fastener
Chrysler

UNIT PACKAGE: 100



11863

(383033-S101)
Phosphate

Door Trim
Panel Fastener
Ford

UNIT PACKAGE: 50

10780

Same as 11863 except for unit packaging quantity

UNIT PACKAGE: 100



807

General Purpose
Head Diameter: 1/2"
Chrysler

UNIT PACKAGE: 100



9361

(Ford: 358470; Chry: 1900654)

Door Trim Panel Fastener
Ford & Chrysler

UNIT PACKAGE: 100



2272

(358107)

Body Belt Moulding &
Hood Side Moulding Fastener
Ford

UNIT PACKAGE: 100



1256

(353123)

Rear Quarter Strip (Inside),
Instrument Panel Moulding & Hood
Side Moulding Fastener
Ford & Chrysler

UNIT PACKAGE: 50



11406

Trim Clip Fastener
Head Diameter: 1/2"
Fits into 1/4" Hole

UNIT PACKAGE: 100



18402

Phosphate & Green

Weatherstrip Clip
GM

UNIT PACKAGE: 25



18395

Black Phosphate

Weatherstrip Clip
GM

UNIT PACKAGE: 50



12134

(4114785)
Zinc

Trim Panel Fastener
Fits into 5/16" Hole
Chrysler

UNIT PACKAGE: 50

Bulk Quantities

The items listed below are available in bulk quantities of 25,000 or more. Quotation on Request

- A = Head O.D.
- B = Prong Length
- C = Hole Size
- D = Width of Diamond



5961

Brown

General Purpose

- A: 17/32"
- B: 7/8"
- C: 9/32"
- D: 1/2"

UNIT PACKAGE: 100



1202

Sandstone

General Purpose

- A: 17/32"
- B: 1-17/64"
- C: 9/32"
- D: 7/16"

UNIT PACKAGE: 100



V-875

Fender Welt

1-3/8 inch (3/16" Bead)
Bright Smooth Vinyl Bead

UNIT PACKAGE: 50 Feet

Footman Loops



Auveco Part No.	Size	Hole Size	Hole to Hole Ctr.	Overall Length	Unit Pkg.
7771	For 1" Strap	7/32"	2-1/8"	2-5/8"	25
7772	For 1-1/4" Strap	1/4"	2-1/4"	2-3/4"	25
7773	For 1-1/2" Strap	1/4"	2-5/8"	3-1/8"	25
19401	For 2" Strap	1/4"	3-1/8"	3-21/32"	25

Steel-Nickel Plated

7771	For 1" Strap	7/32"	2-1/8"	2-5/8"	25
7772	For 1-1/4" Strap	1/4"	2-1/4"	2-3/4"	25
7773	For 1-1/2" Strap	1/4"	2-5/8"	3-1/8"	25
19401	For 2" Strap	1/4"	3-1/8"	3-21/32"	25

Steel • Black E • Coat Plated (168 Hrs. Salt Spray)

19404	For 1-1/2" Strap	1/4"	2-5/8"	3-1/8"	25
-------	------------------	------	--------	--------	----

Hog Rings

To attach seat covers to cushions and seat bottoms, as well as, cushion spring clips.



7595

Medium

.080" Wire Diameter

UNIT PACKAGE: 500



7644

Large

.088" Wire Diameter

UNIT PACKAGE: 500



12671

3/4" Nail (.750)

"Nail On" Door Panel Repair Clip
Slips on Door Panel Fastener Strip for repairs to replace broken Nails in Panel Edging

Replaces Auveco No. 7585
GM

UNIT PACKAGE: 50



12069

(416629)

Zinc

Upholstery Clips
GM 1979-On

UNIT PACKAGE: 50



9417

Snap-On Trim Clip
Panel Range: .105"-.115"

UNIT PACKAGE: 100



9416

Snap-On Trim Clip
Panel Range: .060"-.090"

UNIT PACKAGE: 100



7578

Seat Cushion Upholstery Clip
Can be used to repair drooping headliners in Honda.

UNIT PACKAGE: 500



7707

Cloth Lined Cushion Spring Clip
to fasten Springs to each
other or to border Wire.
Length: 7/8"
For 1/4" or two 8 Gauge Wires.

UNIT PACKAGE: 100



11795

Zinc

Seat Cover Clip
GM 1978-On

UNIT PACKAGE: 100



2850

Front Seat
Self-Locking Clip
Ford

UNIT PACKAGE: 100



8665

Front Seat
Rod End Nut
Outer Diameter: 15/16"
Stud Size 1/2"
Chrysler

UNIT PACKAGE: 100



8719

(4000155)
Nickel

Front Seat Inner Bracket Nut
Outer Diameter: 11/16"
Stud Size: 3/8"
Rambler

UNIT PACKAGE: 100



2672

Front Seat
Hinge Arm Clip
GM

UNIT PACKAGE: 100



Grommets and Washers
Solid Brass

7347	3/8" Hole	Size No. 2
7348	7/16" Hole	Size No. 3
7349	1/2" Hole	Size No. 4
7350	5/8" Hole	Size No. 5

NOTE: Grommets and Washers bagged separately.

UNIT PACKAGE: 144 Grommets & 144 Washers



**Grommet
Setting Dies**



7342 - For Grommet 7348	7/16" Hole-Size No. 3
7343 - For Grommet 7349	1/2" Hole-Size No. 4
7344 - For Grommet 7350	5/8" Hole-Size No. 5

UNIT PACKAGE: 1 SET



**Flanged Type
Countersunk Washers**

Screw Size	I.D.	O.D.	Nickel on Brass Part No.	Black Zinc on Brass Part No.	Stainless Steel Part No.	Unit Pkg.
#6	5/32"	1/2"	3469		3470	100
#8	13/64"	5/8"	2515	16009	2597	100
#10	1/4"	11/16"	3471		3472	100



Flush Type Washers
Nickel Plated on Brass

Unit Pkg.	Unit Pkg.	Unit Pkg.	Screw Size	I.D.	O.D.
100	144	1000			
602	7137	7624	#6	5/32"	11/32"
604	7138	7625	#8	3/16"	3/8"
16015		16016	#10	13/64"	15/32"



Countersunk Type Washers

Screw Size	I.D.	O.D.	Nickel Plated Brass			Black Zinc Plated Brass		Plain Brass	
			Unit Pkg. 100	Unit Pkg. 144	Unit Pkg. 1000	Part No.	Unit Pkg.	Part No.	Unit Pkg.
#4	9/64"	3/8"	612		7613				
#6	11/64"	7/16"	614	7143	7615	16011	100		
#8	13/64"	1/2"	616	7145	7616	16012	100		
#10	1/4"	19/32"	618	7147	7618	16013	100	16593	100
#12	9/32"	11/16"	619	7148					

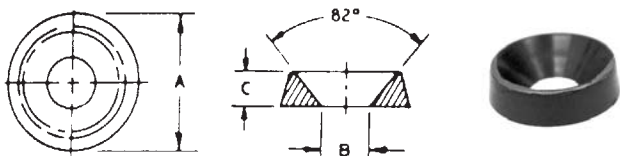

Nylon Finishing Washers

Available in natural or black nylon, these molded washers protect cabinets from scratching, cover misaligned holes, etc. May also be used as guides, bumpers and spacers.

Auveco Part No.	Screw Size	O.D. (A)	I.D. (B)	Thickness (C)	Color	Unit Pkg.
13717	#6	.437" (11.10mm)	.143" (3.63mm)	.100" (2.54mm)	Black	50
13718	#8	.515" (13.08mm)	.171" (4.34mm)	.115" (2.92mm)	Natural	50
13719	#8	.515" (13.08mm)	.171" (4.34mm)	.115" (2.92mm)	Black	50
13720	#10	.580" (14.73mm)	.191" (4.85mm)	.152" (3.86mm)	Natural	50
13721	#10	.580" (14.73mm)	.191" (4.85mm)	.152" (3.86mm)	Black	50
13723	#12	.609" (15.47mm)	.225" (5.72mm)	.160" (4.06mm)	Black	50
13724	#14	.683" (17.35mm)	.251" (6.38mm)	.183" (4.65mm)	Natural	50
13725	#14	.683" (17.35mm)	.251" (6.38mm)	.183" (4.65mm)	Black	50

Pop on Screw Covers & Bases

Covers: Matte Finish



Ultra Violet Stabilized Polypropylene covers and bases help shield screws from corrosive environments.

Their smooth finish forms a protective barrier against rough-edges.

For use with flat head and oval head tap ping screws and round head machine screws.

They're simple to use:

1. Place washer over pilot or starting hole for screw, nail or rivet.
2. Install fastener
3. Place Snap Cap over washer at slight angle.
4. Simply push Snap Cap down firmly.

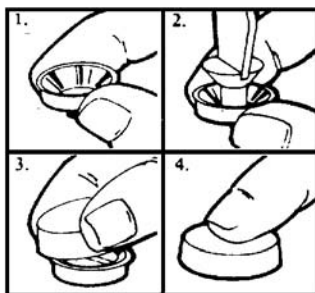

Screw Cover Bases

Auveco Part No.	Unit Pkg.	Screw Size
13839	50	#4
13840	50	#6
13841	50	#8
13842	50	#10

Screw Covers

Auveco Part No.	Unit Pkg.	Color
13831*	50	Black
13832*	50	White
13833*	50	Black
13834*	50	White
13835•	50	Black
13836•	50	White
13837•	50	Black
13838•	50	White

* 1/2" O.D.

• 5/8" O.D.



19413

(F7UZ-15238A32)
Black Nylon

Door Panel Screw Cover
Head Diameter: 3/4" (19mm)
Fits into 5/8" (16mm) Hole
Ford Econoline E150 1997-On

UNIT PACKAGE: 25

Accessories for use on Landau Tops



9877

Stainless Steel

#4-24 x 3/8"

Head Diameter: 7/32"

Type AB

Used in place of Welded Studs on Landau Tops

UNIT PACKAGE: 100



9850

(7731589)

Natural Nylon

Landau Top Moulding Clip
Use with Auveco Screw 9877

UNIT PACKAGE: 100



10632

Nylon

Landau Top Moulding Clip
Use with Auveco Screw 9877

UNIT PACKAGE: 100



11485

(1729250)

Nylon

Roof Transverse Moulding Clip
GM 1976-On

UNIT PACKAGE: 25



9342

(4459049)
Nylon

Door Trim Pad Grommet
Screw Size: #8 or #10
Stem Length: 9/16"
Buick & Oldsmobile

UNIT PACKAGE: 50



3617

(6280765)
Nylon

Door Trim Pad Grommet
Screw Size: #4
Stem Length: 7/16"
Chevrolet & Oldsmobile

UNIT PACKAGE: 100



18398

(20058837)
Nylon

Windshield Upper
Garnish Clip
GM A & G Models
1988-78

UNIT PACKAGE: 10

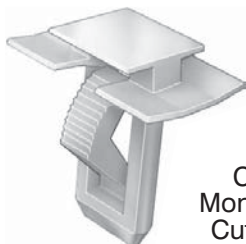

16865

(20462090)
Nylon

Garnish Moulding Clip
Buick Century & Regal,
Chevrolet Camaro, Celebrity,
Monte Carlo & Malibu, Oldsmobile
Cutlass & Ciera, Pontiac Firebird
Grand Prix & 6000 1978-On

UNIT PACKAGE: 25



11118

(9617200)
Nylon

Headliner Clip
Inner Side Front, Center & Rear
GM 1973-On

UNIT PACKAGE: 10

11119

Same as 11118 except for unit package quantity

UNIT PACKAGE: 100



17666

(20632190)
Nylon

Garnish Moulding Clip
Back Window Upper & Side
Moulding Garnish

Buick LeSabre, Cadillac, Fleetwood Brougham,
Chevrolet Caprice & Impala, Olds Delta 88 & 98,
Pontiac Bonneville & Parisienne 1989-80

UNIT PACKAGE: 10

HAVE YOU VISITED US ONLINE?

Auveco's website has been completely renovated.

Our new design is user friendly with easy navigation and ordering.

Product is searchable by car make, OEM number and category, as well as, several attribute drop downs within individual categories. All product also has stock availability listed.

Make sure to head over to

www.auveco.com

to receive up to date information on all our products.



Button
Nickel on Brass
11/64" Barrel Length

14830 - Black Delrin Cap
UNIT PACKAGE: 50

7677 - Nickel Cap
UNIT PACKAGE: 100



Socket
Nickel on Brass

7678 - Normal Action
UNIT PACKAGE: 100



Stud
Nickel on Brass

7679 - Clinch Type
UNIT PACKAGE: 100



Eyelet
Nickel on Brass

7682 - 1/4" Barrel Length
UNIT PACKAGE: 100

Buttons 7677 and 14830 assemble with socket 7678.

You can use hand tools 7690 and 7691 or hand press tool 14835 to complete this step.

Stud 7679 assembles with eyelet 7682.

You can use hand tools 7691 and 7692 or hand press tool 14835 to perform this step.

The two assembled units then snap together.

An assembled button (7677, 14830) and socket (7678) unit can be used with fasteners listed below.



Phillips Wood Screw
Nickel on Brass

9814 - #8 x 3/8"
7680 - #8 x 5/8"
UNIT PACKAGE: 100



Phillips Head
Stainless Steel Screw

14833 - #8 x 3/8"
14834 - #8 x 5/8"
15687 - #10 x 5/8"
UNIT PACKAGE: 50



Phillips Head
16418 - #8 x 1/2"
Nickel on Brass

16419 - #8 x 3/4"
Stainless Steel Screw

UNIT PACKAGE: 25



Wood Screw Stud
Nickel on Brass

7688 - #7 x 1/2"
UNIT PACKAGE: 100



7690

Height: 5/8"
Diameter: 1-3/8"
Die for assembling buttons 7677 & 14830 with socket 7678. The button sets in the die. Then the material and socket are placed over the button barrel. Tool 7691 is used to swedge over the barrel.
UNIT PACKAGE: 1



7692

Height: 5/8"
Diameter: 1-3/8"
Die for assembling stud 7679 and eyelet 7682. The eyelet sets in the die. Then the material and stud are placed over the eyelet barrel. Tool 7691 is used to swedge over the barrel.
UNIT PACKAGE: 1

7691



Length: 3-1/4"
Tool for assembling buttons 7677 & 14830 with socket 7678 and stud 7679 with eyelet 7682.

UNIT PACKAGE: 1

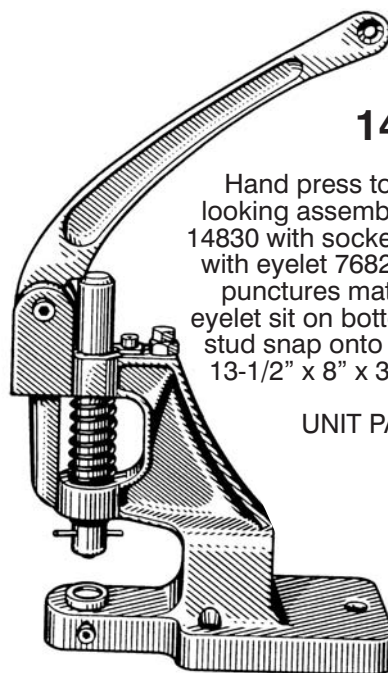

14835

Hand press tool for professional looking assembly of buttons 7677 & 14830 with socket 7678 and stud 7679 with eyelet 7682. Tool automatically punctures material. Buttons and eyelet sit on bottom dies. Socket and stud snap onto dies on the plunger. 13-1/2" x 8" x 3-1/2". Weighs 8 lbs.

UNIT PACKAGE: 1

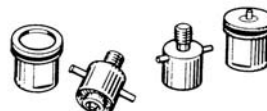

CURTAIN FASTENERS

Nickel on Brass



7417

Backplate
Single curtain to
clinch with backplate

UNIT PACKAGE: 100



7409

Eyelets & washers
**Use with Auveco Fasteners
7417 and 7419**

UNIT PACKAGE: 100 Sets



7419

Single curtain
Use with #4 stainless steel,
chrome or brass screws
(screws sold separately)

UNIT PACKAGE: 100



7432

Photo not actual size
Tool for cutting holes in material when
installing 7409 eyelet and washer.
Overall Length: 6-11/16"

UNIT PACKAGE: 1

TRIMMING SUNDRIES & FASTENERS

Refer to Retainer Specification Chart on pages 415 - 489



19746

(91652-SZ3-003)
White Nylon

Door Lining Retainer
Acura 3.5RL 1996 - On

UNIT PACKAGE: 10



21548

(67869-20030)
Black Nylon

Weatherstrip Retainer
Lexus IS 300 & SC 430 and Toyota Camry,
Celica, Corolla, Highlander, Matrix, MR-2, Prius,
RAV-4, Scion, Solara & Supra 1990 - On

UNIT PACKAGE: 25



18684

(10262036)
Black Nylon

Control Panel Trim Retainer
Chevrolet Lumina & Monte Carlo 1995-On

UNIT PACKAGE: 100



14367

(9924-90-512B)
Black Nylon

Retainer
Mazda

UNIT PACKAGE: 50



21627

(67868-30030)
Black Nylon

Door & Roof Rail Retainer
Lexus 2006 - On & Toyota 1974 - On

UNIT PACKAGE: 25



21984

(VW: 6Y0-823-717)
Black Nylon

Trim Panel Retainer
VW, Audi, SEAT & Skoda

UNIT PACKAGE: 15



21458

(91567-S3M-000)
Black Nylon

Weatherstrip Retainer
Honda Accord, Civic & Odyssey 2003 - On

UNIT PACKAGE: 25



18683

(10063599)
Black Nylon

Remote Control Door
Lock Receiver Retainer
Chevrolet Lumina & Monte Carlo,
Oldsmobile Cutlass and Pontiac
Bonneville & Grand Prix 1991 - On

UNIT PACKAGE: 100



19686

(90467-05045-22)
Black Nylon

Weatherstrip Retainer
Toyota Solara 1998 - On

UNIT PACKAGE: 25

TRIMMING SUNDRIES & FASTENERS

Sec. 19

Refer to Retainer Specification Chart on pages 475-489



18770

(3759944)
Black Nylon

Cowl & Dash Panel Retainer
Dodge Shadow & Plymouth Sundance
1988 - On

UNIT PACKAGE: 50



20344

(10169777)
Black Nylon

Weatherstrip Retainer
Replaces Auveco 18322
Chevrolet Impala, Lumina & Monte Carlo
and Pontiac Aztek 1995 - On

UNIT PACKAGE: 25



14921

(GM: 20699808; Chry: 6502328)
Black Nylon

Door Weatherstrip Retainer
GM 1974 - On
Dodge Ram 1994 - On

UNIT PACKAGE: 50



18389

(25603960)
Black Nylon

Radiator Baffle
Retainer
Olds 98 Regency 1994 - On

UNIT PACKAGE: 25



20165

(4658887)
Black Nylon

Trim Panel Retainer
Chrysler LH & LHS Series 1997 - On

UNIT PACKAGE: 50



14021

(N803170-S)
Black Nylon

Fascia Retainer
Ford Mustang & Capri 1984 - On

UNIT PACKAGE: 25



20528

(24205245)
Black Nylon

Rear Bumper Cover Retainer
Chevrolet Cavalier & Pontiac Sunfire
1995 - On

UNIT PACKAGE: 50



21936

(Peugeot & Citroen: 6992.07)
Black Nylon

Trim Panel Retainer
Peugeot & Citroen

UNIT PACKAGE: 25



11129

(2964547)
Black Nylon

Weatherstrip Retainer
Chrysler 1977 - On

UNIT PACKAGE: 25



11120

(8731909)
Black Nylon

Door Weatherstrip Retainer
GM 1963 - On

UNIT PACKAGE: 100



21808

(Peugeot & Citroen: 6992.31)
White Nylon

Interior Trim Retainer
Peugeot & Citroen

UNIT PACKAGE: 25



18302

(GM: 20538173; Chry: 6104908-AA;
Mercedes: 002-997-33-86-67)
Black Nylon

Weatherstrip Retainer
Buick Century & Riviera, Chevrolet Lumina, Olds
Aurora & Regency and Pontiac Grand Prix 1989 - On
Chrysler 2008 - On
Mercedes-Benz

UNIT PACKAGE: 50

Sec. 19

TRIMMING SUNDRIES & FASTENERS

Refer to Retainer Specification Chart on pages 475-489



21855
(Land Rover: MXC1800)
Black Nylon
Door Panel Retainer
Defender & Discovery Series 1997 - On
UNIT PACKAGE: 15



21770
(Land Rover: MWC9134)
Black Nylon
Side Door Trim Panel Retainer
Use with Auveco 22085
Defender Series, Discovery Series,
Freelander & Range Rover 2006 - 1989
UNIT PACKAGE: 25



14006
(20455900)
Black Nylon
Moulding Retainer
GM 1984 - On
UNIT PACKAGE: 25



21519
(01553-01A50)
Black Nylon
Bumper & Trim Retainer
Infiniti FX35, G35, G37, M35, M45 & Q45
and Nissan 350Z & 370Z 1997 - On
UNIT PACKAGE: 25



17634
(01553-01781)
Black Nylon
Cowl Grille Retainer
Nissan 240SX 1990 - On
UNIT PACKAGE: 25



20893
(GM: 10293193;
Ford: N811040-S)
Black Nylon
Hood Insulation &
Door Weatherstrip Retainer
Chevrolet Cobalt &
Ford Mustang 2005 - On
UNIT PACKAGE: 50



18298
(22536642)
Black Nylon
Rear Bumper Fascia Retainer
Chevy Cavalier, Olds Calais, Pontiac
Grand Prix, Sunbird & 6000 1988 - On
UNIT PACKAGE: 50



19673
(72311-S10-003)
Black Nylon
Weatherstrip Retainer
Honda CRV 1997 - On
UNIT PACKAGE: 15



20311
(N803857S)
Black Nylon
Front End Fascia Retainer
Replaces Auveco 15483
Ford Aerostar, LTD & Marquis 1985 - On
UNIT PACKAGE: 50



11721
(411700)
Black Nylon
Trim Panel Retainer
GM 1968-On
UNIT PACKAGE: 50



19149
(4658673)
Black Nylon
Weatherstrip Retainer
Front & Rear Doors
Chrysler Neon 1996-On
UNIT PACKAGE: 50



18948
(GM: 1644290; Nissan: 01553-0075U)
Black Nylon
Hood Insulation, Rear Bumper Fascia
& Door Trim Plate Retainer
GM 1991 - On
Nissan: 2002 - On
UNIT PACKAGE: 25



18897
(10078274)
Black Nylon
Side Roof Rail
Weatherstrip Retainer
Chevrolet Corsica & Beretta 1989 - 87
UNIT PACKAGE: 25

TRIMMING SUNDRIES & FASTENERS

Sec. 19

Refer to Retainer Specification Chart on pages 475-489



11680

(25016383)
Black Nylon

Dash Panel Retainer
GM 1977 - On

UNIT PACKAGE: 50



11612

(GM: 20413107;
Ford: 388246S
AMC: 4006516)
Black Nylon

Weatherstrip Retainer
GM, Ford & AMC

UNIT PACKAGE: 50



14289

(90666-SA0-003)
Black Nylon

Retainer
Honda

UNIT PACKAGE: 25



19836

(6505417AA)
Black Nylon

Trim Panel Retainer
Chrysler

UNIT PACKAGE: 50



21800

(Renault: 77-03-077-080)
Black Nylon

Retainer
Renault and Dacia

UNIT PACKAGE: 25



21801

(Not Available from O.E.M.)
White Nylon

Retainer
Renault and Dacia

UNIT PACKAGE: 25



12993

(7703-077-066)
Black Nylon

Rear Window Moulding
AMC Renault & Alliance 1983 - On

UNIT PACKAGE: 25



21802

(Renault: 77-03-077-231;
Fiat: 14591787)
Black Nylon

Retainer
Renault, Dacia
and Fiat

UNIT PACKAGE: 25



21803

(Fiat: 14592087)
Black Nylon

Retainer
Renault, Dacia and Fiat

UNIT PACKAGE: 25



21804

(Fiat: 14592086)
Gray Nylon

Retainer
Renault, Dacia and Fiat

UNIT PACKAGE: 25



14017

(390126-S)
Black Nylon

Fascia Retainer
Ford Mustang &
Capri 1984 - On

UNIT PACKAGE: 25

14857

Same as 14017 except for unit package quantity

UNIT PACKAGE: 50

All items available in bulk quantities.

**Call customer service 1-800-354-9816
for a price quote**

Sec. 19**TRIMMING SUNDRIES & FASTENERS**

Refer to Retainer Specification Chart on pages 475-489

**21878**(Peugeot & Citroen: 8964.57)
Black NylonTrunk Lining Retainer
Peugeot & Citroen

UNIT PACKAGE: 25

**21693**(Lexus: 90467-05125)
Black NylonFront Bumper Bracket Retainer
Lexus GS 300, GS 450h
& LS 400 1995 - On

UNIT PACKAGE: 25

**18682**(10098645)
Black NylonFront Door Lower Moulding Retainer
Pontiac Grand Prix with
Sport Performance Package 1994 - On

UNIT PACKAGE: 50

**21303**(90671-S0D-003ZK)
Black NylonTrunk Lid &
Interior Trim Retainer
Honda Accord 2010 - On

UNIT PACKAGE: 25

**20256**(01553-01182)
Black NylonSplash Shield Retainer
Nissan Frontier Truck 1997 - On

UNIT PACKAGE: 50

**21877**(Peugeot & Citroen: 6992.C6)
Black NylonRadiator Panel Retainer
Peugeot & Citroen

UNIT PACKAGE: 25

**17453**(B003-68-865-96)
Gray NylonRear Compartment
Interior Trim Retainer
Ford Probe 1988 - On
Mazda MX6 1988 - On

UNIT PACKAGE: 50

**21589**(99045AE03AMA)
Black NylonTrim Panel Retainer
Subaru B9 Tribeca, Impreza,
Legacy & Outback 2005 - On

UNIT PACKAGE: 25

**21755**(Mazda: B003-68-865-00)
Black NylonTrim Panel Retainer
MPV 1998 - 89

UNIT PACKAGE: 50

**18815**(6502381)
Black NylonRadiator Grille
Sight Shield Retainer
Dodge Caravan &
Plymouth Voyager 1993 - On

UNIT PACKAGE: 50

**19312**(90467-05096-22)
Black NylonLuggage Compartment
Trim Panel Retainer
Toyota Tercel & Paseo 1994 - On

UNIT PACKAGE: 25

**21910**(Renault & Dacia: 77-03-077-487)
Black NylonTrim Panel Retainer
Renault & Dacia

UNIT PACKAGE: 25

TRIMMING SUNDRIES & FASTENERS

Sec. 19

Refer to Retainer Specification Chart on pages 475-489



21911

(Renault & Dacia: 77-03-077-464)
Gray Nylon

Trim Panel Retainer
Renault & Dacia

UNIT PACKAGE: 15



21912

(Renault & Dacia: 77-03-077-153)
Black Nylon

Trim Panel Retainer
Renault & Dacia

UNIT PACKAGE: 15



21913

(Renault & Dacia: 77-03-077-107)
Dark Gray Nylon

Trim Panel Retainer
Renault & Dacia

UNIT PACKAGE: 25



19506

(90666-SA7-003ZW)
Black Nylon

Trunk Lining Retainer
Acura 2.5TL, 3.2TL, 3.5, Integra &
Legend, Honda Accord Wagon
& Prelude 1987 - On

UNIT PACKAGE: 15



21938

(Peugeot & Citroen: 7588.VX)
Black Nylon

Trim Panel Retainer
Peugeot & Citroen

UNIT PACKAGE: 25



21349

(85746-06000LX)
Gray Nylon

Headliner Retainer
Kia Rio 2010 - On

UNIT PACKAGE: 25



21350

(85746-06000RU)
Tan Nylon

Headliner Retainer
Kia Rio 2010 - On

UNIT PACKAGE: 25



15050

Black Nylon

Shroud Retainer
High Retention Capability
GM, Ford & Chrysler

UNIT PACKAGE: 50



15367

(20514862)
Black Nylon

Screen Shroud Vent
Grille to Panel Retainer
GM 1985 - On

UNIT PACKAGE: 50



21940

(Peugeot & Citroen: 6992.95)
Black Nylon

Trim Panel Retainer
Peugeot & Citroen

UNIT PACKAGE: 25



11675

(GM: 25514221;
Chry: 6003587)
Black Nylon

Roof Headliner Retainer
GM & Chrysler 1982 - On

UNIT PACKAGE: 50



21199

(Ford: W711687-S300;
GM: 11589181)
Black Nylon

Bumper and Fender Apron Retainer
Ford Focus and GM Full-Size
Pick-Up Trucks 2007 - On

UNIT PACKAGE: 25



14709

(Mazda: G030-68-885-B-38;
Ford: F22Z-16774-A, GA2A-56694)
Nylon

Hood Insulation Retainer
Mazda & Ford Probe

UNIT PACKAGE: 25

Sec. 19**TRIMMING SUNDRIES & FASTENERS**

Refer to Retainer Specification Chart on pages 475-489

**21661**
(TD11-56-694)
Black NylonHood Insulation Retainer
Mazda 3, 5, 6, CX7, CX9,
MX5 Miata & RX8 2004 - On

UNIT PACKAGE: 25

**13198**
(4-29-29-06)
Black NylonInterior Trim Retainer
Fiat

UNIT PACKAGE: 50

**20399**
(W701374-S)
Black NylonHood Insulation Retainer
Ford Escape 2001 - On

UNIT PACKAGE: 25

**18820**
(N807951S)
Black NylonAccess Hole Cover Retainer
Ford Mustang 1994 - On

UNIT PACKAGE: 100

**11679**
(GM: 20032850; Ford: 387258-S;
Chry: 3861577)
Black NylonMud Shield Retainer
GM, Ford & Chrysler 1976 - On

UNIT PACKAGE: 100

**19667**
(N801994-S100)
Black NylonTrim Panel Retainer
Ford 1982 - On

UNIT PACKAGE: 25

**13454**
(20511451)
Black NylonCowl Vent Retainer
GM 1984 - On

UNIT PACKAGE: 25

**21941**
(Peugeot & Citroen: 9128.S1)
Light Gray NylonTrim Panel Retainer
Peugeot & Citroen

UNIT PACKAGE: 10

**11347**
(3861577)
Black NylonFront Seat Adjuster Cover Retainer
Chrysler 1975 - On

UNIT PACKAGE: 25

**21937**
(Peugeot & Citroen: 6992.W9)
Black NylonTrim Panel Retainer
Peugeot & Citroen

UNIT PACKAGE: 25

**19643**
(90467-06175)
Black NylonLuggage Compartment
Retainer
Toyota Solara 1998 - On

UNIT PACKAGE: 15

**21939**
(Peugeot & Citroen: 7589.V4)
Tan NylonTrim Panel Retainer
Peugeot & Citroen

UNIT PACKAGE: 15

**20184**
(90467-08186)
Black NylonLuggage Compartment
Trim Retainer
Toyota Camry 1999 - On

UNIT PACKAGE: 25

TRIMMING SUNDRIES & FASTENERS

Sec. 19

Refer to Retainer Specification Chart on pages 475-489



21253

(90467-05164-B6)
Gray Nylon

Headliner Retainer
Toyota Yaris 2009 - On

UNIT PACKAGE: 25



21332

(90467-05164-E2)
Tan Nylon

Headliner Retainer
Toyota Corolla & Yaris 2009 - On

UNIT PACKAGE: 25



21560

(G032-68-865A-00)
Black Nylon

Trunk & Carpet Retainer
Mazda B2000, B2600, CX-7, CX-9, Miata,
Millenia, MX-3, MX-5, MX-6, Protege, RX-7,
RX-8, 3, 5, 6, 626 & 929 1987 - On

UNIT PACKAGE: 25



21673

(W715926-S300)
Black Nylon

Fender, Bumper, Trunk
& Interior Trim Retainer
Ford Escape & Focus 2012 - On

UNIT PACKAGE: 25



21630

(95022AC040ML)
Black Nylon

Headliner & Trim
Space Retainer
Subaru Forester, Impreza,
Legacy & Outback 1998 - On

UNIT PACKAGE: 25



14757

(N804448)
Black Nylon

Engine Mount Heat Shield Retainer
Ford Taurus & Sable 1986 - On

UNIT PACKAGE: 25



19470

(90108-SW3-003)
Black Nylon

Use with Auvenco 19650
Honda Accord,
Odyssey & Prelude 1995 - On

UNIT PACKAGE: 15



19744

(90669-SP0-003ZA)
Black Nylon

Trunk Trim Retainer
Honda Civic 1998 - On

UNIT PACKAGE: 10



21947

(Peugeot & Citroen: 7437.10)
Black Nylon

Trim Panel Retainer
Peugeot & Citroen

UNIT PACKAGE: 10



19893

(6501948)
Black Nylon

Fender & Bumper Shield Retainer
Chrysler 1995 - 89

UNIT PACKAGE: 50



20334

(90667-SOD-003ZC)
Black Nylon

Trunk Garnish Retainer
Honda Civic 1998 - On

UNIT PACKAGE: 15



22075

(Nissan: 01553-06451)
Black Nylon

Upper Quarter Trim &
Rear Trunk Seal Retainer
Infiniti G35, J30, JX60, M35, M37, M56,
Q45, Q50 & QX60 and Nissan Altima,
Pathfinder & Quest 1996 - On

UNIT PACKAGE: 25



16776

(Honda: 90667-SAO-0030;
Nissan: 76996-01P02)
Black Nylon

Trim Panel Retainer
Honda & Nissan

UNIT PACKAGE: 25

Sec. 19

TRIMMING SUNDRIES & FASTENERS

Refer to Retainer Specification Chart on pages 475-489



19842
(75867-30110)
Black Nylon
Rocker Panel Clip
Toyota Corolla 1997 - On
UNIT PACKAGE: 15



15040
(Chry: 5208743; AMC: 4006529)
Black Nylon
Trim Panel Retainer
Chrysler 1988 - 84
AMC 1988 - 84
UNIT PACKAGE: 50



18379
(W701380SSW)
Black Nylon
Retainer
Trunk Liner, Rear Seat Carpet,
& Radiator Side Shield
Ford Contour &
Mercury Mystique 1995 - On
UNIT PACKAGE: 25



19774
Black Nylon
Bumper Cover Retainer
Replaces Auveco 18106
Postal Vehicles &
General Purpose
UNIT PACKAGE: 25



18174
(25601491)
Black Nylon
Radiator Air Side Baffle
& Door Trim Panel Retainer
Buick LeSabre &
Olds Delta 88 Royale 1992 - On
UNIT PACKAGE: 50



20624
(Ford: W709002-SAA)
Black Nylon
Fender Flare Retainer
Ford Expedition &
Navigator 2003 - On
UNIT PACKAGE: 25



20531
(W708035-S300)
Black Nylon
Rear Bumper Cover Retainer
Use with Auveco 20532
Ford Expedition 2003 - On
UNIT PACKAGE: 25



18301
(GM: 10185925; Chry: 6503768)
Black Nylon
Bumper Fascia Retainer
Chevy Lumina APV, Olds Silhouette
& Pontiac Trans Sport 1993 - On
UNIT PACKAGE: 25



21679
(Chrysler: 6509590-AA)
Black Nylon
Bumper Retainer
Chrysler 300 & Charger 2011 - On
UNIT PACKAGE: 25



20177
(W705955-S300)
Charcoal Gray
Nylon
Wheel Opening Moulding Retainer
Ford Explorer 1998 - On
UNIT PACKAGE: 50



16818
(GM: 21094146, 21110201;
Chry: 6501301)
Black Nylon
Trim Panel Retainer
GM Saturn 1991 - On
Sliding Door & Lift Gate
Trim Panel Retainer
Chrysler Mini Vans 1987 - On
UNIT PACKAGE: 25



18859
(10119816)
Black Nylon
Panel Retainer Air Intake
Grille Panel Retainer
Chevrolet Camaro
1991 - On
UNIT PACKAGE: 25

TRIMMING SUNDRIES & FASTENERS

Sec. 19

Refer to Retainer Specification Chart on pages 475-489



20761
(W710312-S300)
Black Nylon

Cowl Vent Retainer
Ford Trucks
2004 - On

UNIT PACKAGE: 25



18371
(15986343)
Gray Nylon

Door Trim
Panel Retainer
Chevrolet Astro & GMC Safari
Mini Vans 1994 - On

UNIT PACKAGE: 25



20366
(W701855-S300)
Black Nylon

Fender Liner &
Mud Flap Retainer
Ford Explorer &
Mountaineer 2002 - On

UNIT PACKAGE: 25



20192
(Ford: W707889-S300)
Black Nylon

Mud Flap Retainer
Ford Expedition &
F-150 1997 - On

UNIT PACKAGE: 25



14032
(15588078)
Black Nylon

Pillar Cover Retainer
GM Truck 1985 - On

UNIT PACKAGE: 10



20926
(W710532-S300)
Black Nylon

Rocker Moulding Retainer
Ford Mustang
2005 - On

UNIT PACKAGE: 25



22180
(Ford: W714076-SS3JA)
Black Nylon

Cowl, Interior Trim &
Splash Shield Retainer
Ford F150 & Mustang 2015 - On

UNIT PACKAGE: 25



14036
(14074081)
Black Nylon

Rear Hood Seal Retainer
GM 1983 - On

UNIT PACKAGE: 25



14035
(22527720)
Natural Nylon

Hood Seal Retainer
GM 1981-On

UNIT PACKAGE: 25

Sec. 19

TRIMMING SUNDRIES & FASTENERS

Refer to Retainer Specification Chart on pages 475-489

Roof Trim & Garnish Retainer
Ford Explorer 1992-On



19352

(N807155-S)
Medium Mist Gray

UNIT PACKAGE: 25

19354

(N807155-S)
Medium Camel Tan

UNIT PACKAGE: 25



19855

(4717224)
Black Nylon

Trim Panel Retainer
Chrysler Concorde, Intrepid, LHS,
New Yorker, Vans & Vision 1993 - On

UNIT PACKAGE: 50



10831

(GM: 332364, 14093311, 20732399;
Ford: 389358, W701259-S300;
Chry: 3691590, 6031321, 6505411-AA,
AMC: 4004569)
Black Nylon

Fender & Bumper Shield Retainer
GM, Ford, Chrysler & AMC

UNIT PACKAGE: 50

16259

Same as 10831 except for unit package quantity

UNIT PACKAGE: 100



10832

(GM: 6270163;
Chry: 6030538)
Gray Nylon

Fender & Bumper Shield Retainer
GM 1973 - On
Chrysler

UNIT PACKAGE: 50



15664

White Nylon

Fender & Bumper Shield Retainer
White version of Auveco 10831
GM, Ford, Chrysler & AMC

UNIT PACKAGE: 100



11146

(GM: 11569768, 15958694, 1605396;
Chry: 6030441;
Ford: 388577S, W705589-S300)
Black Nylon

Radiator Yoke, Fender &
Bumper Shield Retainer
GM, Ford & Chrysler

UNIT PACKAGE: 25

15414

Same as 11146 except for unit package quantity

UNIT PACKAGE: 100



19790

(Not Available from O.E.M.)
Gray Nylon

Trim Panel Retainer
Gray version of Auveco 11146
GM, Ford & Chrysler

UNIT PACKAGE: 50



19250

(Not Supplied by O.E.M.)
White Nylon

Trim Panel Retainer
White version of Auveco 11146

UNIT PACKAGE: 25



21756

(Not Available from O.E.M.)
Clear Nylon

Trim Panel Retainer
Clear version of Auveco 11146
Universal

UNIT PACKAGE: 50



17664

(GM: 10121502; Chry: 6033082,
6033840; Ford: 390018-S)
Black Nylon

Shield Retainer
Battery Post Cable Shield,
Engine Splash Shield
Radiator Side Air Baffle
GM 1989-On

UNIT PACKAGE: 50

TRIMMING SUNDRIES & FASTENERS

Sec. 19

Refer to Retainer Specification Chart on pages 475-489



17612

(Chry: 6504043; Ford: N807721-S)
Black Nylon

Trim Panel Retainer
Ford Explorer 1993 - On
Trunk Lid Latch
Chrysler 1996 - On

UNIT PACKAGE: 50

Trim Panel Retainer Ford Explorer, Mountaineer,
Windstar & Ranger 1991-On



19371

(N807154-S)
Dark Denim (Blue) Nylon

UNIT PACKAGE: 50



19373

(N807154-S)
Zuca Granite (Light Gray)
Nylon

UNIT PACKAGE: 50



19374

(N807154-S)
Medium Prairie Tan Nylon

UNIT PACKAGE: 50



20878

(90467-A0008)
Black Nylon

Bumper Cover Retainer
Toyota, Lexus & Scion 1995 - On

UNIT PACKAGE: 50



16775

(Honda: 90667-SA7-0030;
Nissan: 89427-98070)
Black Nylon

Trim Panel Retainer
Honda & Nissan

UNIT PACKAGE: 25



19121

(90467-08104)
Gray Nylon

Roof Headliner Retainer
Toyota MR2 1990 - On

UNIT PACKAGE: 15



21026

(4860379-AA)
Black Nylon

Door Trim Panel Retainer
Dodge 300 Series, Magnum
& Charger 2005 - On

UNIT PACKAGE: 25



16132

Black Nylon

Trim Panel Retainer
Universal

UNIT PACKAGE: 25



15543

(GM: 22547243, 11610086,
Chry: 6501916)
Black Nylon

Splash Shield &
Wheel Well Cover Retainer
Chrysler 1988 - On
Hood Seal Retainer
GM 1989 - On

UNIT PACKAGE: 50



21392

(1H0-819-055-B01C)
Black Nylon

Instrumental Panel, Cowl Vent,
Defroster Grille & Ducts Retainer
Phillips Drive
Audi and Volkswagen Cabrio,
Golf & Jetta 2002 - 1993

UNIT PACKAGE: 25



21257

(Chry: 6508727-AA;
Ford: W706815-S300)
Black Nylon

Trunk Trim and Insulator Retainer
Ford Focus, Fusion, Milan,
MKZ & Zephyr 2006 - On

UNIT PACKAGE: 25

Sec. 19

TRIMMING SUNDRIES & FASTENERS

Refer to Retainer Specification Chart on pages 475-489



21906
(Renault & Dacia: 77-03-077-090)
Black Nylon

Trim Panel Retainer
Renault & Dacia

UNIT PACKAGE: 10



21868
(Peugeot & Citroen: 6999.R1;
Renault & Dacia: 77-03-077-174)
Black Nylon

Trim Panel Retainer
Peugeot, Citroen,
Renault & Dacia

UNIT PACKAGE: 25



17076
(GM: 94145515;
Isuzu: 8941455150)
Black Nylon

Inner Fender Shield &
Bumper Fascia Retainer
Geo Storm & Isuzu 1990 - On

UNIT PACKAGE: 25



19834
(15975244)
Black Nylon

Wiring Harness &
Headliner Retainer
Engine Wiring Harness,
Tailgate, Headliner & Air Cleaner
GM C, E, K, S & T Trucks 1994 - On

UNIT PACKAGE: 50



19837
(Not Available from O.E.M.)
Black Nylon

Trim Panel Retainer
Chrysler

UNIT PACKAGE: 50



19127
(N808370-S)
Black Nylon

Carpet Retainer
Ford Taurus & Sable 1996 - On

UNIT PACKAGE: 25



18685
(3548804)
Black Nylon

License Plate Bracket &
Bumper Fascia Retainer
Cadillac Eldorado & Seville 1995 - On

UNIT PACKAGE: 25



20189
(GM: 16674629;
Ford: N806113-S; Chry: 6503943)
Black Nylon

Trim Panel Retainer
Cadillac Concours, DeVille & Seville;
Chevrolet Impala, Lumina & Monte Carlo;
Dodge Ram & Dakota; Ford and Pontiac
Grand Prix 1995 - On

UNIT PACKAGE: 50



21905
(Renault & Dacia: 82-00-721-200)
Gray Nylon

Trim Panel Retainer
Renault & Dacia

UNIT PACKAGE: 25



20319
(W700671-S300)
Black Nylon

Hood Insulation Retainer
Ford Contour & Mystique 1995 - On

UNIT PACKAGE: 25



21900
(Renault & Dacia: 77-03-077-453)
Black Nylon

Trim Panel Retainer
Renault & Dacia

UNIT PACKAGE: 15



20360
(GM: 22189414;
Chry: 6505667-AA)
Black Nylon

Engine Compartment &
Front End Retainer
Buick LeSabre, Park Ave.,
Rendezvous, & Riviera;
Cadillac DeVille & Seville;
Chevrolet Venture, Oldsmobile
Silhouette and Pontiac Aztek,
Bonneville & Montana 2000 - On
Chrysler 2010 - On

UNIT PACKAGE: 25

TRIMMING SUNDRIES & FASTENERS

Sec. 19

Refer to Retainer Specification Chart on pages 475-489



21248

(15944588)
Tan Nylon

Headliner Retainer
Chevrolet Malibu 2004 - On

UNIT PACKAGE: 25



19760

(N807535-S)
Black Nylon

Kick Plate Retainer
Ford Ranger 1993 - On

UNIT PACKAGE: 50



21301

(11610747)
Black Nylon

Grille Retainer
Use with Auveco 21302
Cadillac SRS & SRX and Chevrolet
Camaro 2010 - On

UNIT PACKAGE: 25



21338

(15802005)
Black Nylon

Fender & Headliner Retainer
GM Acadia, Camaro, Enclave, Traverse,
& Saturn Outlook 2008 - On

UNIT PACKAGE: 25



15523

(E9SB-6302354-ACW)
Black Nylon

Cowl Side Trim Retainer
Ford T-Bird & Cougar
1989 - On

UNIT PACKAGE: 25



19541

(6504135)
Black Nylon

Hood Insulation Retainer
Chrysler Mini-Vans & Durango 1997 - On

UNIT PACKAGE: 50



21691

(Suzuki: 09409-06309-5ES)
Black Nylon

Hood Insulation
Retainer
Grand Vitara, Swift &
XL7 1990 - On

UNIT PACKAGE: 25



10332

(2998430)
Black Nylon

Radiator Grille Retainer
Chrysler

UNIT PACKAGE: 25



21090

(24501057)
Black Nylon

Fender Apron &
Radiator Baffle Retainer
Cadillac Escalade,
Chevrolet Denali & Tahoe,
GMC Yukon and
Hummer H3 2006 - On

UNIT PACKAGE: 25



15481

(6501067)
Black Nylon

Fascia Retainer
Chrysler 1985-On

UNIT PACKAGE: 50



21809

(Peugeot & Citroen: 6983.17)
Black Nylon

Retainer
Peugeot & Citroen

UNIT PACKAGE: 25

Refer to Retainer Specification Chart on pages 475-489

**15480**(Ford: N802734S; GM: 22718305)
Black NylonTrim Panel & Hood
Insulation Retainer
Ford 1983 - On
GM 1997 - On

UNIT PACKAGE: 50

19197(N802734-S)
Medium Opal (Gray) Nylon

UNIT PACKAGE: 50

**12731**(20319841)
Black NylonSeat Back Retainer
GM Camaro & Firebird 1982 - On

UNIT PACKAGE: 25

**20281**(11518201)
Black NylonBumper Fascia Retainer
Pontiac Grand Am 1999 - On

UNIT PACKAGE: 15

**11673**(GM: 2048248; Chry: 6003423)
Natural NylonInterior Trim Panel Retainer
GM & Chrysler 1977 - On

UNIT PACKAGE: 50

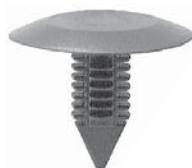
**11351**(Ford: 385661-S;
Chry: 6032363; VW: N989022)
Black NylonDoor Trim Panel Retainer
Ford, Chrysler & VW 1975 - On

UNIT PACKAGE: 25

**21907**(Renault & Dacia: 82-00-321-368)
Gray NylonTrim Panel Retainer
Renault & Dacia

UNIT PACKAGE: 10

**12571**(389443-S)
Black NylonFascia to Bumper Retainer
Ford 1981 - On

UNIT PACKAGE: 25

**21805**(Renault: 77-03-077-435)
Black NylonRetainer
Renault and Dacia

UNIT PACKAGE: 25

**21806**(Renault: 77-03-077-225)
Black NylonRetainer
Renault and Dacia

UNIT PACKAGE: 25

**21914**(Renault & Dacia:
77-03-074-315)
Black NylonTrim Panel Retainer
Head Diameter: 40mm
Stem Diameter: 10.5mm
Stem Length: 26mm
Renault & Dacia

UNIT PACKAGE: 10

Email your product suggestions to**mail@auveco.com**

TRIMMING SUNDRIES & FASTENERS

Sec. 19

Refer to Retainer Specification Chart on pages 475-489



20316

(Ford: 388904-S;
Chry: 4381395, 6501086)
Black Nylon

Door Frame Spacer Retainer
Replaces Auveco 14042
Chrysler 1985 - On
Bumper Retainer
Ford 1981 - On

UNIT PACKAGE: 50



20262

(22642756)
Black Nylon

Trunk Trim Retainer
Chevrolet Cavalier &
Pontiac Sunfire 1995 - On

UNIT PACKAGE: 25



20362

(15056810)
Black Nylon

Bumper Fascia Retainer
GM S & T Trucks 2002 - On

UNIT PACKAGE: 25



21789

(VW: 1H0-867-199-01C)
Black Nylon

Radiator Grille, Scuff Plate,
Sill & Trim Panel Retainer
Volkswagen & Audi 1997 - On

UNIT PACKAGE: 25



12766

(22512276)
Black Nylon

Front End Stone Shield Retainer
GM 1981 - On

UNIT PACKAGE: 25

16262

Same as 12766 except for unit package quantity

UNIT PACKAGE: 50



12137

(1619321)
Black Nylon

Radiator Apron Panel Retainer
GM 1977 - On

UNIT PACKAGE: 25

16263

Same as 12137 except for unit package quantity

UNIT PACKAGE: 50



18679

(20652520)
Gray Nylon

Compensator Panel to
Quarter Panel Retainer
Buick Century & Skylark, Cadillac
Fleetwood and Olds Calais 1992 - 83

UNIT PACKAGE: 25



15478

(GM: 1631564;
Ford: N804379S, W706358-S300)
Black Nylon

Bumper Fascia Retainer
Buick, Cadillac & Olds 1981 - On
Taurus & Sable 1986 - On

UNIT PACKAGE: 50



18771

(6502104)
Black Nylon

Headlight Mounting Panel to Cross
Member Sight Shield Retainer
Dodge Daytona 1993

UNIT PACKAGE: 25



18680

(10229437, 10242316)
Black Nylon

Headliner Trim Finish Panel Retainer
Buick Skylark, Chevrolet Camaro,
Cavalier, Lumina & Monte Carlo,
Oldsmobile Cutlass and Pontiac Firebird,
Grand Am, Grand Prix & Sunfire 1992 - On

UNIT PACKAGE: 25

Sec. 19

TRIMMING SUNDRIES & FASTENERS

Refer to Retainer Specification Chart on pages 475-489



19501
(10249241)
Tan Nylon

Headliner Trim Panel Retainer
Buick Century, Regal & Skylark;
Chevrolet Camaro, Cavalier, Lumina,
Monte Carlo & Venture; Oldsmobile
Silhouette and Pontiac Firebird,
Grand Am, Sunfire &
Trans Sport 1995 - On

UNIT PACKAGE: 25



18688
(10220168, 10241518)
Gray Nylon

Headliner Trim Finish Panel Retainer
Buick Century & Regal, Chevrolet
Caprice, Camaro, Lumina & Monte Carlo,
Olds Cutlass Ciera and Pontiac Firebird &
Grand Prix 1992 - On

UNIT PACKAGE: 50



20345
(15006827)
Gray Nylon

Headliner Retainer
GM C & K Trucks 2000 - On

UNIT PACKAGE: 25



22338
(VW: 3C0-863-559)
Black Nylon

Wheel House Cover Mount &
Interior Trim Retainer
Volkswagen Passat &
CC 2012 - 2006

UNIT PACKAGE: 25



20625
(Ford: XW7Z-6302354-AAB)
Tan Nylon

Headliner Retainer
Ford Expedition & Navigator
2003 - On

UNIT PACKAGE: 25



12759
(14027471)
Black Nylon

Trim Panel Retainer
GM Trucks 1981 - On

UNIT PACKAGE: 25



12909
(388930-S)
Black Nylon

Trim Panel Retainer
Ford 1980 - On

UNIT PACKAGE: 50



20874
(90467-07049-CO)
Black Nylon

Trim Panel Retainer
Lexus 2000 - On

UNIT PACKAGE: 25



15479
(N804349S)
Black Nylon

Interior Trim Retainer
Ford 1986-On

UNIT PACKAGE: 25



21241
(W706635-SSW)
Black Nylon

Rocker, Pillar &
Fender Liner Retainer
Ford Fusion & Taurus 2009 - On

UNIT PACKAGE: 50



22053
(Ford: W715951-S300)
Black Nylon

Rear Body &
Interior Trim Retainer
Ford Escape 2013 - On

UNIT PACKAGE: 15

TRIMMING SUNDRIES & FASTENERS

Sec. 19

Refer to Retainer Specification Chart on pages 475-489

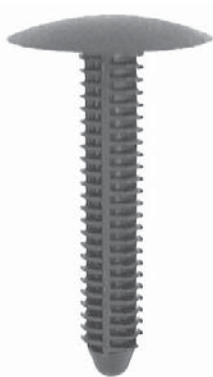

Trim & Garnish Retainer
Ford Vans 1992 - On

19845

(E8FZ-5802354A)
Medium Graphite Nylon

UNIT PACKAGE: 25

19846

(F2UZ-1602354AAA)
Black Nylon

UNIT PACKAGE: 25



18277

(N806344-S)
Gray

Roof Trim Panel &
Garnish Moulding Retainers
Ford Ranger 1992-On

UNIT PACKAGE: 25



21228

(10444839)
Tan Nylon

Headliner Retainer
Chevrolet Express Van &
GMC Savana Van 2004 - On

UNIT PACKAGE: 25

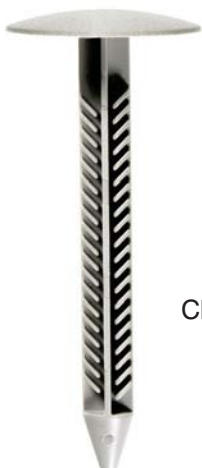

21287

(25822063)
Opal Gray Nylon

Headliner Retainer
Chevrolet Silverado Hybrid 2010 - On

UNIT PACKAGE: 25



21288

(65846-4Z000)
Black Nylon

Hood Insulation Retainer
Nissan Altima 2010 - On

UNIT PACKAGE: 15



19468

(65846-40F00)
Black Nylon

Hood Insulation Retainer
Infiniti J30, M30 & Q45 1989 - On

UNIT PACKAGE: 15



21380

(15989431)
Black Nylon

Hood Insulation Retainer
Chevrolet Traverse 2010 - On

UNIT PACKAGE: 25



22211

(Subaru: 909207031)
Black Nylon

Hood Insulation Retainer
Subaru BRZ, Forester, Impreza,
WRX & XV Crosstrek 2012 - On

UNIT PACKAGE: 50



15998

(90700-SB2-003)
Black Nylon

Hood Insulation Retainer
Honda Prelude 1985 - On

UNIT PACKAGE: 15



21421

(909130074)
Black Nylon

Hood Insulation Retainer
Subaru Baja, Forester, Impreza,
Legacy, Outback & Tribeca 1998 - On

UNIT PACKAGE: 15



21443

(11571159)
Black Nylon

Hood Insulation Retainer
Chevrolet Cruze 2011 - On

UNIT PACKAGE: 25

Sec. 19

TRIMMING SUNDRIES & FASTENERS

Refer to Retainer Specification Chart on pages 475-489



21313
(W708633-S300)
Black Nylon

Hood Insulation Retainer
Ford Fusion 2010 - On

UNIT PACKAGE: 25



11842
(N-800387-S)
Black Nylon

Dashboard Retainer
Ford 1979 - On

UNIT PACKAGE: 25



11350
(4005250)
White Nylon

Door Panel Retainer
American Motors 1976 - On

UNIT PACKAGE: 25



17381
(N805315)
Gray Nylon

Headliner Retainer
Ford Aerostar 1986 - On

UNIT PACKAGE: 10



19338
(Chry: 6504098;
Ford: N808842-S)
Black Nylon

Hood Insulation Retainer
Chrysler Sebring 1996 - On
Ford Taurus, Sable & Mark VIII 1996 - On

UNIT PACKAGE: 50



22233
(GM: 11611677)
Black Nylon

Hood Insulation Retainer
Cadillac ELR, Chevrolet Colorado &
Volt and GMC Canyon 2011 - On

UNIT PACKAGE: 10



20615
(11517992)
Black Nylon

Fender Liner Retainer
Pontiac Bonneville 2000 - On

UNIT PACKAGE: 25

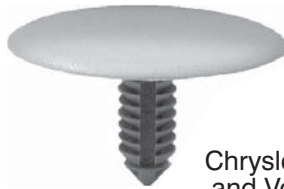

20541
(TY98TL2-AA)
Tan Nylon

Headliner Retainer
Chrysler Caravan, Town & Country
and Voyager Mini-Vans 2001 - On

UNIT PACKAGE: 25



15457
(20030401)
Black Polypropylene

Hood Insulation Retainer
GM 1980 - On

UNIT PACKAGE: 25



21385
(89026634)
Light Gray Nylon

Headliner Retainer
Chevrolet Impala 2010 - On

UNIT PACKAGE: 25



21386
(89026635)
Tan Nylon

Headliner Retainer
Chevrolet Impala 2010 - On

UNIT PACKAGE: 25

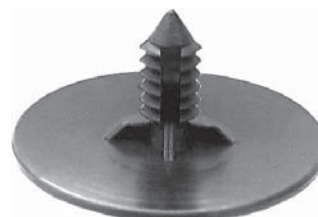

15456
(20064875)
Black Nylon

Hood Insulation Retainer
GM 1980 - On

UNIT PACKAGE: 25

TRIMMING SUNDRIES & FASTENERS

Sec. 19

Refer to Retainer Specification Chart on pages 475-489



11130
(3078511, 3977775)
Black Nylon

Hood Insulation
Retainer
GM 1964 - On

UNIT PACKAGE: 25



16863
(N803613S)
Black Nylon

Hood Insulation Retainer
Ford Bronco, Explorer &
Ranger 1988 - On

UNIT PACKAGE: 25



15668
(N803387)
Black Nylon

Trim Panel Retainer
Ford

UNIT PACKAGE: 25



17215
(21039141)
Black Nylon

Hood Insulation Retainer
GM Saturn 1991 - On

UNIT PACKAGE: 25



21227
(25749564)
Tan Nylon

Headliner Retainer
Chevrolet Express Van
& GMC Savana Van 2004 - On

UNIT PACKAGE: 15



21891
(VW: N905-333-01)
Black Nylon

Hood Insulation Retainer
VW, Audi, SEAT & Skoda

UNIT PACKAGE: 15



18827
(6503892)
Black Nylon

Hood Insulation Retainer
Chrysler Cirrus & Stratus 1995 - On

UNIT PACKAGE: 50



19655
(386553-S)
Black Nylon

Hood Insulation Retainer
Replaces Auveco 13571
Ford 1975 - On

UNIT PACKAGE: 25



14163
(388908-S)
Black Nylon

Hood Insulation
Retainer
Ford 1975- On

UNIT PACKAGE: 50



17975
(Chry: 6502842,
GM: 21039129)
Black Nylon

Hood Insulation Retainer
Chrysler Concorde, Dodge Intrepid
& Eagle Vision 1993 - On
GM Corvette, Equinox & Saturn 1992 - On

UNIT PACKAGE: 50



21211
(53326-08010)
Black Nylon

Hood Insulation Retaining Clip
Toyota Sienna 2009 - On

UNIT PACKAGE: 25



20164
(4878883AA)
Black Nylon

Hood Insulation Retainer
Chrysler LH & LHS Series 1997 - On

UNIT PACKAGE: 50

Sec. 19**TRIMMING SUNDRIES & FASTENERS**

Refer to Retainer Specification Chart on pages 475-489

**21652**(91501-SWA-003)
Black NylonHood Insulation Retainer
Honda Civic 2012 - On

UNIT PACKAGE: 25

**17004**(4341060)
Black NylonHood Insulation &
Fender Shield Retainer
Chrysler 1985- On

UNIT PACKAGE: 25

**19155**(4428987)
Black NylonHood Insulation Retainer
Dodge Ram 1994 - On

UNIT PACKAGE: 25

**17237**(Nissan: 65832-F5000
65846-30F00)
Black NylonHood Insulation Retainer
Mercury Villager 1999 - On
Nissan 1981 - On

UNIT PACKAGE: 15

**18746**(90700-SJ4-000)
Black NylonHood Insulation Retainer
Head Diameter: 30mm
Stem Diameter: 15mm x 18mm
Stem Length: 6mm
Acura Legend 1991 - On
Honda 1998 - On

UNIT PACKAGE: 15

**20609**(91501-S1K-003, 91501-STK-003)
Black NylonHood Insulation Retainer
Acura 3.5RL & RSX and
Honda Civic & CR-V 2000 - On

UNIT PACKAGE: 25

**22168**(GM: 13265959)
Black NylonHood Insulation Retainer
Cadillac Catera 2001 - 1997 &
Buick Regal 2011 - On

UNIT PACKAGE: 25

**22103**(Toyota: 53857-47011)
Black NylonFront Fender Retainer with Sealer
Lexus CT 200h and Toyota Camry, Prius,
RAV4, Yaris & 4-Runner 2010 - On

UNIT PACKAGE: 15

**13467**(GM: 7642589;
AMC: 4001934)
Black NylonFirewall Insulation Retainer
GM & AMC

UNIT PACKAGE: 25

**21776**(BMW: 51-77-7-171-003)
Black NylonRocker Panel & Wheel Housing
Retainer with Rubber O-Ring
X Series 2006 - On

UNIT PACKAGE: 25

**13757**(389809)
Black NylonHood Insulation Retainer
2" Square
GM 1980 - On

UNIT PACKAGE: 25

TRIMMING SUNDRIES & FASTENERS

Sec. 19

Refer to Retainer Specification Chart on pages 475-489



17072
(15659161)
Black Nylon

Front Door
Frame Hole Plug
GM Blazer, Jimmy &
Pickup 1989 - On

UNIT PACKAGE: 25



14985
(2664040)
White Nylon

Door Weatherstrip Retainer
Chrysler 1966 - On

UNIT PACKAGE: 100



21982
(VW: 251-823-717)
Black Nylon

Weatherstrip Retainer
VW, Audi, SEAT & Skoda

UNIT PACKAGE: 25



21981
(VW: 1H0-823-717)
Black Nylon

Weatherstrip Retainer
VW, Audi, SEAT & Skoda

UNIT PACKAGE: 25



14299
(73862-672-003)
White Nylon

Weatherstrip Retainer
Honda

UNIT PACKAGE: 50



20182
(Not Available from O.E.M.)
White Nylon

Weatherstrip Retainer
Chrysler LH &LHS Series 1997 - On

UNIT PACKAGE: 100



18510
(20200750)
Natural Nylon

Hood Seal Retainer
Buick, Cadillac, Chevrolet,
GMC & Oldsmobile 1970 - On

UNIT PACKAGE: 100



22321
(Hyundai: 86438-2T000)
Black Nylon

Hood & Bumper Seal Retainer
Hyundai Elantra &
Genesis 2013 - On
Kia K900 & Optima 2011 - On

UNIT PACKAGE: 50



21382
(86434-4A000)
Black Nylon

Hood Seal Retainer
Hyundai Elantra, Sonata & Tucson
and Kia Sportage 2009 - On

UNIT PACKAGE: 50



22320
(Hyundai: 86438-1R000)
Black Nylon

Hood Seal Retainer
Hyundai Accent 2011 - On

UNIT PACKAGE: 50



22107
(Nissan: 80850-JM01A)
Black Nylon

Weatherstrip Retainer
Nissan Rogue 2008 - On

UNIT PACKAGE: 25



14328
(90664-671-003, 91530-SE0-003)
White Nylon

Weatherstrip Retainer
Honda

UNIT PACKAGE: 50

Sec. 19**TRIMMING SUNDRIES & FASTENERS**

Refer to Retainer Specification Chart on pages 475-489

**20180**(Not Available from O.E.M.)
Black NylonWeatherstrip Retainer
Chrysler LH & LHS Series 1997 - On

UNIT PACKAGE: 100

**8853**(C5AB-6220586A)
Natural NylonDoor Weatherstrip Retainer
Ford

UNIT PACKAGE: 50

**10744**(4876498)
Black NylonWeatherstrip Retainer
GM

UNIT PACKAGE: 100

**21143**(51-71-1-496-621)
Black NylonRocker Moulding Retainer
Mini-Cooper 2002 - On

UNIT PACKAGE: 25

**19678**(Not Available from O.E.M.)
White NylonWeatherstrip Retainer
Ford Windstar 1995 - On

UNIT PACKAGE: 50

**19449**(10403591)
Black NylonRear Bumper Fascia Retainer
Oldsmobile Intrigue &
Pontiac Grand Prix 1998 - On

UNIT PACKAGE: 25

**18509**(4040732)
Black NylonWeatherstrip Retainer Hood Inner
Panel to Cowl & Door Weatherstrip
Dodge F.W.D. Pick-Up 1989 - 82

UNIT PACKAGE: 100

**22310**(Mercedes: 001-988-97-81)
White NylonScuff Plate Retainer
Mercedes-Benz C230, C280, C350,
C55, CLK350, CLK500, CLK55, CLK63,
S350 & S430 2009 - 2006

UNIT PACKAGE: 25

**21381**(86438-4A100)
Black NylonHood Seal Retainer
Hyundai Elantra & Tucson and
Kia Forte & Sportage 2009 - On

UNIT PACKAGE: 50

**19418**(GM: 480534;
Ford: 384051-S)
Black NylonCowl Insulation Retainer
GM
Splash Shield and Wire Retainer
Ford

UNIT PACKAGE: 25

**19425**(385677)
Natural NylonWeatherstrip Retainer
Ford

UNIT PACKAGE: 50

**21125**(Not Available from O.E.M.)
Black NylonFront Bumper Retainer
Cadillac STS 2005 - On

UNIT PACKAGE: 15

TRIMMING SUNDRIES & FASTENERS

Sec. 19

Refer to Retainer Specification Chart on pages 475-489



21694

(Lexus: 67867-50020)
Black Nylon

Weatherstrip Retaining Clip
Lexus GS 300 &
LS 400 2005 - 1990

UNIT PACKAGE: 25



19325

(MU481027)
Brown Nylon

Hood Weatherstrip Retainer
Mitsubishi Eclipse & Diamante 1991 - On

UNIT PACKAGE: 25



21552

(90467-04034)
White Nylon

Weatherstrip Retainer
Lexus CT 200h, HS 250h, IS F, IS 250, IS 350, LS 460,
LS 600h, RX 350, RX 400h & RX 450h and Toyota
Avalon, Corolla, Highlander, Matrix, Prius,
RAV-4, Scion & Venza 2003 - On

UNIT PACKAGE: 25



20760

(Not Available from O.E.M.)
Natural Nylon

Weatherstrip Retainer
Chrysler 300 & Dodge Magnum 2005 - On

UNIT PACKAGE: 100



19850

(N806340-S)
Natural Nylon

Weatherstrip Retainer
Ford F150 1999 - On

UNIT PACKAGE: 100



21565

(90331AA050)
White Nylon

Weatherstrip Retaining Clip
Subaru Forester 2008 - 03

UNIT PACKAGE: 25



21334

(W711858-S300)
White Nylon

Weatherstrip Retainer
Ford Edge & MKX 2007 - On

UNIT PACKAGE: 100



22162

(Not Available From O.E.M.)
Orange Nylon

Weatherstrip Retainer
Ford Explorer 2014 - On

UNIT PACKAGE: 100



19481

(GA2A-58-762)
Blue Nylon

Front & Rear Door
and Hood Weatherstrip
Mazda 626 & Millenia 1995 - On

UNIT PACKAGE: 50



22355

(Not Available From O.E.M.)
Green Nylon

Fender Seal &
Weatherstrip Retainer
Overall Height: 13.5mm
Ford Mustang 2015 - On

UNIT PACKAGE: 50



22356

(Not Available From O.E.M.)
Pink Nylon

Fender Seal &
Weatherstrip Retainer
Overall Height: 13.5mm
Ford Mustang 2015 - On

UNIT PACKAGE: 50



20181

(Not Available from O.E.M.)
White Nylon

Weatherstrip Retainer
Chrysler LH &
LHS Series 1997 - On

UNIT PACKAGE: 100



19368

(10283414, 10405030)
Natural Nylon

Door Weatherstrip Retainer
Buick Century & Regal and
Oldsmobile Intrigue 1997 - On

UNIT PACKAGE: 100

Refer to Retainer Specification Chart on pages 475-489



21980

(VW: 1Z0-837-732A)
Yellow Nylon

Weatherstrip Retainer
VW, Audi, SEAT & Skoda

UNIT PACKAGE: 25



22325

(Hyundai: 87756-2W000)
Red Nylon

Weatherstrip Retainer
Hyundai Santa Fe &
Kia Sorento 2013 - On

UNIT PACKAGE: 100



22302

(Not Available from O.E.M.)
Yellow Nylon

Weatherstrip Retainer
Overall Height: 12.5mm
Ford F-150 & Super Duty Trucks and
Lincoln Mark LT 2003 - On

UNIT PACKAGE: 50



20831

(Not Available from O.E.M.)
Blue Nylon

Weatherstrip Retainer
Ford Explorer 2005 - On

UNIT PACKAGE: 100



22060

(Nissan: 65810-K2002)
Black Nylon

Hood Seal Retaining Clip
Infiniti 2003 - 1997
Nissan 2003 - 1996

UNIT PACKAGE: 25



18692

(Ford: E7GZ-6120586-B;
Hyundai: 86438-2B000;
Mazda: G031-58-762;
Toyota: 67868-89101,
67867-28030, 67867-89103)
Natural Nylon

Weatherstrip Retainer
Toyota 4-Runner 1989-83
Mazda 1996 - On; Ford 1996 - On
Hyundai 2007- On; Kia 2009 - On

UNIT PACKAGE: 50



21229

(65810-K2000)
Black Nylon

Hood Seal Retaining Clip
Infiniti 130, 135, Q45 &
QX4 and Nissan Maxima &
Pathfinder 2004 - 1996

UNIT PACKAGE: 25



19171

(91568-SR2-003)
Green Nylon

Weatherstrip Retainer
Honda Odyssey 1995 - On

UNIT PACKAGE: 100



19749

(67867-12150)
White Nylon

Weatherstrip Retainer
Toyota Avalon 1995 - On

UNIT PACKAGE: 15



20443

(67867-0C010)
Black Nylon

Weatherstrip Retainer
Toyota Tundra 1999 - On

UNIT PACKAGE: 25

**Please place orders in
Unit Package quantities,
not based on pieces needed**

TRIMMING SUNDRIES & FASTENERS

Sec. 19

Refer to Retainer Specification Chart on pages 475-489



21773

(Honda: 91530-S0A-003)
Black Nylon

Roof Rail & Side Sill
Weatherstrip Retainer
Acura Legend, MDX, RDX, RL,
TL & ZDX 1998 - On
Honda Accord, Civic, CRV, Element
& Odyssey 2001 - On

UNIT PACKAGE: 25



21705

(Honda: 90651-TP8-003,
91568-TR0-003)
Yellow Nylon

Weatherstrip Retainer
Acura ILX & RDX and
Honda Civic & CR-V 2012 - On

UNIT PACKAGE: 25



21707

(Honda: 91563-SCV-003)
(Toyota: 67867-52010,
67867-0D060)
White Nylon

Weatherstrip Retainer
Acura TL and Honda Element
Odyssey & Pilot 2003 - On
Toyota Echo, Land Cruiser,
Prius, Tacoma & Yaris and
Lexus GS 450, GX 460 & LX 430
and Scion xA & xD 2000 - On

UNIT PACKAGE: 25



21704

(Honda: 72311-S5S-003)
Green Nylon

Weatherstrip Retaining Clip
Acura RDX and Honda Civic,
CR-V & Fit 2003 - On

UNIT PACKAGE: 25



18877

(91530-SP1-003)
Nylon

Weatherstrip Retainer
Acura 3.5 RL & Honda Accord,
Civic, & Odyssey 1992 - On

UNIT PACKAGE: 25



22337

(Hyundai: 82132-27100)
White Nylon

Door Weatherstrip Retainer
Hyundai Azera, Santa Fe &
Sonata 2001 - On

UNIT PACKAGE: 25



19116

(91530-ST5-003)
Natural Nylon

Weatherstrip Retainer
Honda Civic 1995 - On

UNIT PACKAGE: 10



17339

(N806289-S)
Black Nylon

Weatherstrip Retainer
Lincoln 1989 - On

UNIT PACKAGE: 50



19684

(01553-09311)
Blue Nylon

Weatherstrip Retainer
Nissan Altima & Sentra 1994 - On

UNIT PACKAGE: 25



21949

Black Nylon

Weatherstrip Retainer
Peugeot & Citroen

UNIT PACKAGE: 25



18033

(Chry: 4696129;
GM: 21077575)
White Nylon

Weatherstrip Retainer
Chrysler Concorde & LHS
Dodge Intrepid & Eagle Vision 1993 - On
Oldsmobile Alero &
Pontiac Grand Am 1999 - On

UNIT PACKAGE: 50

Sec. 19**TRIMMING SUNDRIES & FASTENERS**

Refer to Retainer Specification Chart on pages 475-489

**21633**
(80850-89900)
White NylonWeatherstrip Retainer
Infiniti 130, 135 & M45 and
Nissan Maxima 2004 - 2000

UNIT PACKAGE: 25

**19683**
(91502-S84-A11)
Black NylonCowl Vent Retaining Clip
Honda Odyssey 1999 - On

UNIT PACKAGE: 15

**17991**
(90467-06092)
Black NylonRetaining Clip
Lexus 1990 - On

UNIT PACKAGE: 10

**18330**
(94848189, 94848192)
White NylonFront Door Weatherstrip Retainer
Geo Prizm 1992 - 89

UNIT PACKAGE: 25

**19728**
(90467-10146)
Black NylonCowl Panel Retainer
Toyota Sienna Van 1997 - On

UNIT PACKAGE: 25

**19724**
(65810-K2009)
White NylonHood to Cowl Seal Retainer
Infiniti & Nissan Pathfinder 1992 - On

UNIT PACKAGE: 25

**19483**
(91515-SR3-000)
Black NylonRear Hood Cowl
Weatherstrip Retaining Clip
Acura Integra, Honda Civic, CR-V
& Del Sol 1992 - On

UNIT PACKAGE: 25

**19720**
(90467-06138)
Black & White NylonHood to Cowl Seal Retainer
Toyota Avalon & Camry 1994 - On

UNIT PACKAGE: 10

**18508**
(4001916)
Black NylonWeatherstrip Retainer
Jeep Wrangler 1991 - On

UNIT PACKAGE: 50

**11136**
(Ford: 385330-S,
D30Z-16776-A;
Chry: 6003351)
Black NylonHood Insulation Retainer
Chrysler 1972 - On
Grille to Radiator Retainer
Ford 1973 - On

UNIT PACKAGE: 25

**18166**
(80875-85E00)
Black NylonTrim Panel Retainer
Nissan Maxima 1989 - On

UNIT PACKAGE: 25

**18818**
(91513-SE0-003)
Natural NylonHood Seal Retainer
Honda Accord & Prelude 1983 - On

UNIT PACKAGE: 25

**21919**
Black NylonWeatherstrip Retaining Clip
Peugeot, Citroen, Renault & Dacia

UNIT PACKAGE: 25

TRIMMING SUNDRIES & FASTENERS

Sec. 19

Refer to Retainer Specification Chart on pages 475-489



21918

(Peugeot & Citroen: 9025.J8)
Black Nylon

Weatherstrip Retaining Clip
Peugeot, Citroen, Renault & Dacia

UNIT PACKAGE: 25



21920

Black Nylon

Weatherstrip Retaining Clip
Peugeot, Citroen, Renault & Dacia

UNIT PACKAGE: 25



21295

(01553-08961)
Black Nylon

Weatherstrip Retaining Clip
Nissan Altima 2009 - On

UNIT PACKAGE: 25



3639

(C1AB-6220807-A)
White Nylon

Door Flange Weatherstrip Retainer
Ford

UNIT PACKAGE: 100



3620

(4801268)
Black Nylon

Door Flange Weatherstrip Retainer
GM

UNIT PACKAGE: 100



18248

(55055098)
Black Nylon

Headlight Grille Retaining Clip
Dodge Ram 1994 - On

UNIT PACKAGE: 25



21573

(90331GA090)
Black Nylon

Weatherstrip Retaining Clip
Subaru Forester & Legacy 2008 - 1990

UNIT PACKAGE: 25



21942

(Peugeot & Citroen: 6983.24)
Black Nylon

Trim Retaining Clip
Peugeot & Citroen

UNIT PACKAGE: 25



21943

(Peugeot & Citroen: 8749.Q5)
Gray Nylon

Trim Retaining Clip
Peugeot & Citroen

UNIT PACKAGE: 25



14355

(01533-00401)
Black Nylon

Retaining Clip
Nissan

UNIT PACKAGE: 50



14291

(66435-648-000)
Black Nylon

Retaining Clip
Honda

UNIT PACKAGE: 50



14349

(Mazda: 9926-40-543;
Nissan: 01553-00291)
Black Nylon

Retaining Clip
Mazda & Nissan

UNIT PACKAGE: 50



19014

(90467-10123)
Natural Nylon

Trim Panel Retainer
Toyota Celica 1993 - On

UNIT PACKAGE: 10



5592

(375372-S)
Black Nylon

Radiator Top Shield Retainer
Ford

UNIT PACKAGE: 100

Refer to Retainer Specification Chart on pages 475-489

**19467**(91501-SL4-003)
Black NylonFront Cowl Retaining Clip
Acura 3.5 RL 1996 - On

UNIT PACKAGE: 25

**22214**(Lexus: 90467-06015-C0)
Black NylonFront & Rear Bumper
Retaining Clip
Lexus GS 300, GS 400 &
GS 430 2005 - 1998

UNIT PACKAGE: 25

**21626**(90467-06128)
Black NylonWeatherstrip
Retaining Clip
Toyota Camry &
RAV-4 1992 - On

UNIT PACKAGE: 25

**21296**(90080-46010)
Black NylonHood Seal Retaining Clip
Toyota Camry 2010 - On

UNIT PACKAGE: 50

**18297**(Toyota: 90467-08004, 90467-08011;
GM: 94842841, 94849113)
Black NylonHood Seal Retaining Clip
Lexus, Toyota, Geo Prizm
& Nova 1985 - On

UNIT PACKAGE: 50

**21695**(Toyota: 90467-08045,
90467-08063)
Black NylonHood & Weatherstrip
Retaining Clip
Toyota Yaris 2007 - On

UNIT PACKAGE: 25

**For the most up to date
information on all Auveco items,
including new items, inventory
and online ordering please visit
www.auveco.com**

**14352**(76876-W5000)
Black NylonRetaining Clip
Nissan

UNIT PACKAGE: 50

**14737**(Nissan: 01553-00172;
Toyota: 90467-07050, 90467-08008)
Black NylonRetaining Clip
Nissan & Toyota

UNIT PACKAGE: 25

**14282**(90687-SA5-003)
Black NylonRetaining Clip
Honda

UNIT PACKAGE: 50

**17452**(01553-00545)
Black NylonBumper Fascia Retainer
Nissan Sentra 1990 - On

UNIT PACKAGE: 25

**21692**(Lexus: 90467-07137)
Black NylonFender Panel Retaining Clip
Lexus ES 350, GS 300,
GS 450h & IS 250 2006 - On

UNIT PACKAGE: 25

TRIMMING SUNDRIES & FASTENERS

Sec. 19

Refer to Retainer Specification Chart on pages 475-489



22212

(Toyota: 53145-60030)
Black Nylon

Front Bumper, Grille &
Hood Seal Retaining Clip
Toyota Avalon, Camry, Highlander,
Land Cruiser, Prius & Venza and Lexus
GS 350, GS 450h, IS 250, IS 350, LX 570,
NX 200t, NX 300h, RX 350 & RX 450h
and Scion iQ & tC 2008 - On

UNIT PACKAGE: 100



22001

(Toyota: 90467-08030)
Black Nylon

Trim Retaining Clip
Toyota

UNIT PACKAGE: 25



21643

(90467-08101)
Black Nylon

Hood to Cowl Top Seal
Retaining Clip
Lexus ES 300 and Toyota Camry,
Sequoia, Solara & Tundra 2006 - 1997

UNIT PACKAGE: 25



18157

(90672-671-003)
Gray Nylon

Headliner & Cowl Grille
Retaining Clip
Honda Accord 1986 - On

UNIT PACKAGE: 25



14736

(90467-06161-01)
Black Nylon

Retaining Clip
Toyota

UNIT PACKAGE: 25



19331

(MB869072)
Black Nylon

Headliner & Trunk Trim Retaining Clip
Mitsubishi Diamante 1995 - 91

UNIT PACKAGE: 15



18271

(9926-40-531B)
Black Nylon

Hood Insulation Retainer
Mazda

UNIT PACKAGE: 25



17990

(90467-09138)
Black Nylon

Retaining Clip
Lexus 1990 - On

UNIT PACKAGE: 5



16781

(Honda: 90670-692-003;
Toyota: 90467-09065)
Black Nylon

Retaining Clip
Honda & Toyota

UNIT PACKAGE: 25



14348

(27948-M7002)
Black Nylon

Retaining Clip
Nissan

UNIT PACKAGE: 25



20381

(Honda: 90667-671-013ZA;
Mitsubishi: MC440901;
Nissan: 62660-48600-1)
Black Nylon

Trim Panel Retaining Clip
Honda, Mitsubishi & Nissan

UNIT PACKAGE: 25



19123

(90467-10107)
Black Nylon

Fender Apron Seal Clip
Toyota 2WD & 4WD Truck
1988 - On

UNIT PACKAGE: 10

Sec. 19**TRIMMING SUNDRIES & FASTENERS**

Refer to Retainer Specification Chart on pages 475-489

**21634**
(90467-10186)
Black NylonDash & Fender Apron Seal
Retainer
Lexus and Toyota 1996 - On

UNIT PACKAGE: 25

**22221**
(Toyota: 90080-46327)
Black NylonFender Apron Seal Retainer
Toyota Sequoia, Tacoma
& Tundra 2000 - On

UNIT PACKAGE: 50

**22286**
(Nissan: 80287-37F00)
Natural NylonFront Door, Garnish &
Interior Trim Retaining Clip
Overall Height: 11.5mm
Infiniti FX35, FX45, G35, G37 &
Q60 and Nissan Murano 2015 - 2003

UNIT PACKAGE: 25

**22263**
(Honda: 91504-TBA-A01)
Black NylonGrille Retaining Clip
Honda Civic 2016 - On

UNIT PACKAGE: 25

**20882**
(91501-SEA-003)
Black NylonCowl & Garnish Retainer
Honda Civic 2006 - On

UNIT PACKAGE: 10

**22054**
(Honda: 91501-SNA-003)
Black NylonFront Fender, Cowl &
Dash Retainer
Honda Civic & CR-V 2014 - 06

UNIT PACKAGE: 15

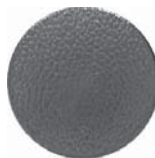
**20671**
(01553-0052U)
Black NylonTrim Panel Retaining Clip
Nissan Frontier &
Xterra 2000 - On

UNIT PACKAGE: 25

**21757**
(BMW: 51-48-8-181-420)
Black NylonTrim Panel & Trunk Lining Retainer
3 Series & 5 Series 2004 - 1988

UNIT PACKAGE: 25

**19729**
(90467-09050, 90467-A0003)
Black NylonHood Insulation Retainer
Lexus, Toyota Camry &
Solara 1998 - On

UNIT PACKAGE: 15

**19113**
(90467-08124)
Black NylonHood Insulation Retainer
Toyota Supra 1993 - On
Lexus 1994 - 89

UNIT PACKAGE: 15

**19323**
(MU481187)
Black NylonHood Insulation Retainer
Mitsubishi Diamante 1993 - On

UNIT PACKAGE: 15

**19385**
(MB020923)
Gray NylonHood Insulation Retainer
Jeep Eagle &
Mitsubishi Eclipse 1992 - On

UNIT PACKAGE: 10

**22082**
(Mitsubishi: MB655630)
Black NylonHood Insulation Retainer
Mitsubishi Diamante &
Montero 2004 - 1992

UNIT PACKAGE: 15

TRIMMING SUNDRIES & FASTENERS

Sec. 19

Refer to Retainer Specification Chart on pages 475-489



18878

(90467-08081)
Black Nylon

Hood Insulation Retainer
Toyota Celica 1993 - 89

UNIT PACKAGE: 15



19112

(90467-09004)
Black Nylon

Hood Insulation Retainer
Toyota Tacoma 1995 - On

UNIT PACKAGE: 15



14738

(90467-09008)
Black Nylon

Retaining Clip
Toyota

UNIT PACKAGE: 25



18842

(90467-09006)
Black Nylon

Hood Insulation Retainer
Toyota Avalon, Camry &
Lexus 1988 - On

UNIT PACKAGE: 15



21588

(80850-CA003)
Black Nylon

Weatherstrip Retainer
Nissan Murano & Rouge 2003 - On

UNIT PACKAGE: 25



21307

(BP4K-58-762)
Black Nylon

Weatherstrip Retaining Clip
Mazda 2007 - On

UNIT PACKAGE: 25



18114

(91520-SM4-C01)
Black Nylon

Hood Insulation Retaining Clip
Honda & Acura 1990 - On

UNIT PACKAGE: 25



20770

(Not Available from O.E.M.)
Yellow Nylon

Weatherstrip Retainer
Ford F Series Pick-Ups 2004 - On

UNIT PACKAGE: 100



19682

(91518-S10-003)
Black Nylon

Hood Seal Retaining Clip
Honda Odyssey 1999 - On

UNIT PACKAGE: 25



19114

(91518-SM4-003)
Black Nylon

Hood & Trunk
Moulding Retaining Clip
Acura Integra &
Honda Civic 1994 - On

UNIT PACKAGE: 10



21880

(Peugeot & Citroen: 6999.T4)
Black Nylon

Weatherstrip Retaining Clip
Peugeot & Citroen

UNIT PACKAGE: 50



21879

(Peugeot & Citroen: 6995.V6)
Black Nylon

Hood Insulation Retainer
Peugeot & Citroen

UNIT PACKAGE: 25



21520

(J001-56-741)
Black Nylon

Weatherstrip Retaining Clip
Mazda CX-7, Millenia,
MPV, 3, 6 & 626 1995 - On

UNIT PACKAGE: 25



18458

(Ford: F1CZ-16774-A;
Mazda: B455-56-741)
Black Nylon

Hood Insulation Retaining Clip
Ford Probe &
Mazda MX6 1992 - 88

UNIT PACKAGE: 25

Sec. 19**TRIMMING SUNDRIES & FASTENERS**

Refer to Retainer Specification Chart on pages 475-489

**21497**
(1H0-837-719)
Black NylonWeatherstrip Retainer
with Clear Grommet
Audi A3 and VW Golf, Sharan,
Transporter & Corsa

UNIT PACKAGE: 25

**14723**
(62869-N4700)
Black NylonRetaining Clip
Nissan

UNIT PACKAGE: 25

**17205**
(91501-SM4-003)
Black NylonCowl Top Retaining Clip
Honda Accord 1990 - On

UNIT PACKAGE: 15

**16777**
(Mazda: B001-68-302-00;
Toyota: 90950-01248)
Black NylonRetaining Clip
Mazda & Toyota

UNIT PACKAGE: 25

**14353**
(76906-T3000)
Black NylonRetaining Clip
Nissan

UNIT PACKAGE: 50

**22046**
(Subaru: 91167FA010)
Black NylonFront Hood Cowl Retaining Clip
Impreza 2001 - 1993

UNIT PACKAGE: 25

**19124**
(90467-07096)
Black NylonSide Trim Panel Retaining Clip
Toyota 4WD Truck 1989 - On

UNIT PACKAGE: 10

**21908**
(Renault & Dacia: 77-03-077-449)
Black NylonTrim Panel Retaining Clip
Renault & Dacia

UNIT PACKAGE: 25

**21909**
(Renault & Dacia: 82-00-110-307)
Gray NylonTrim Panel Retaining Clip
Renault & Dacia

UNIT PACKAGE: 25

**21870**
(Renault & Dacia: 77-03-077-457)
Light Gray NylonTrim Retaining Clip
Renault & Dacia

UNIT PACKAGE: 25

**14347**
(Nissan: 01553-00202;
Toyota: 90467-10018)
Black NylonRetaining Clip
Nissan & Toyota

UNIT PACKAGE: 50

**14323**
(38529-689A-6300)
Black NylonRetaining Clip
Honda

UNIT PACKAGE: 25

**21758**
(VW: 801-867-299-01C)
Black NylonDoor Side Panel,
Luggage Compartment
and Armrest Tray Trim
Retaining Clip
Golf, GTI, Jetta & Rabbit 2005 - 1999

UNIT PACKAGE: 25

TRIMMING SUNDRIES & FASTENERS

Sec. 19

Refer to Retainer Specification Chart on pages 475-489



16779

(Honda: 74842-659-0030;
Toyota: 90467-12078)
Black Nylon

Retaining Clip
Honda & Toyota

UNIT PACKAGE: 25



14720

(HB-121467)
Black Nylon

Retaining Clip
Mitsubishi

UNIT PACKAGE: 25



14380

(8133-50-022)
Black Nylon

Retaining Clip
Mazda

UNIT PACKAGE: 25



22071

(GM: 11546805)
Black Nylon

Front Fender Retainer
Chevrolet Colorado 2015 - On

UNIT PACKAGE: 50



21105

(001-988-03-25)
Black Nylon

Hood Insulation Retainer
Mercedes 2002 - On

UNIT PACKAGE: 15



21254

(90467-08136)
Black Nylon

Fender Seal Retaining Clip
Toyota Yaris 2009 - On

UNIT PACKAGE: 25



14356

(01553-00051)
Black Nylon

Retaining Clip
Nissan

UNIT PACKAGE: 50



14319

(90687-671-003)
Black Nylon

Retaining Clip
Honda

UNIT PACKAGE: 25



22209

(Chrysler: 68033045AA)
Black Nylon

Front & Rear Fender Flare
Retainer
Jeep Wrangler 2007 - On

UNIT PACKAGE: 15



20543

(81126-37010)
Black Nylon

Hood Insulation Retainer
Hyundai Elantra & Sonata
and Kia Optima 1995 - On

UNIT PACKAGE: 15



22254

(Mercedes-Benz: 000-991-74-98)
Black Nylon

Rocker Moulding Retaining Clip
Mercedes-Benz C, Cla, Cls, E,
Gla & S Class 2015 - On

UNIT PACKAGE: 15



22073

(Toyota: 76924-47020)
Black Nylon

Moulding Retainer
Lexus CT 200h &
Toyota Prius 2011 - On

UNIT PACKAGE: 15

Sec. 19**TRIMMING SUNDRIES & FASTENERS**

Refer to Retainer Specification Chart on pages 475-489

**21551**(67869-12050)
Black NylonWeatherstrip Retainer
Toyota Corolla &
Prius 2007 - 01

UNIT PACKAGE: 25

**21991**(VW: 6L6-853-575A)
Black NylonRetaining Clip
VW, Audi, SEAT & Skoda

UNIT PACKAGE: 10

**21509**(357-853-575)
White NylonRetainer
With Gray Grommet
VW Golf, Jetta,
Passat & Scirocco

UNIT PACKAGE: 25

**20611**(90602-S7S-003)
Blue NylonCowl Vent Retainer
Use with Auveco 20612
Honda Accord 2003 - On

UNIT PACKAGE: 25

**21696**(Honda: 90602-S2A-003)
Pale Yellow NylonCowl Retainer
Honda Civic, Element, Fit,
Insight & S2000 2001 - On

UNIT PACKAGE: 25

**20576**(GM: 88969790;
Toyota: 75867-21010)
Yellow NylonFender Flare Retainer
Pontiac Vibe &
Toyota Echo 2002 - On

UNIT PACKAGE: 25

**21975**(Peugeot & Citroen: 6991.43;
Renault & Dacia: 77-03-077-059)
White NylonTrim Panel Retainer
Peugeot, Citroen,
Renault & Dacia

UNIT PACKAGE: 25

**21871**(Peugeot & Citroen: 6995.A3;
Renault & Dacia: 77-03-077-111)
White NylonTrim Panel
Retainer with Sealer
Peugeot, Citroen,
Renault & Dacia

UNIT PACKAGE: 25

**22153**(Land Rover: LR032984)
White NylonFront Door Louver Exterior Trim
Retainer with Sealer
Land Rover Evoque, HSE &
Range Rover 2014 - 2012

UNIT PACKAGE: 15

**20571**(MR435918)
White NylonRocker Panel
Retainer
Mitsubishi Montero 2001 - On

UNIT PACKAGE: 15

**20642**(000-990-57-92)
Gray NylonDoor Panel Retaining Clip
Mercedes-Benz

UNIT PACKAGE: 10

**19320**(MB696120)
White NylonSide Garnish &
Moulding Trim Retainer
Mitsubishi Eclipse 1994 - On

UNIT PACKAGE: 15

TRIMMING SUNDRIES & FASTENERS

Sec. 19

Refer to Retainer Specification Chart on pages 475-489



21496

(357-853-585-A)
White Nylon

Trim Panel Retainer
With Nylon Grommet
VW Golf & Passat and Audi B3

UNIT PACKAGE: 15



21783

(VW: 6Q0-868-297)
Black Nylon

Trim Panel Retainer
Golf, GTI, R32 &
Rabbit 2006 - On

UNIT PACKAGE: 15



18861

(90467-10162)
White Nylon

Scuff Plate Retainer
Toyota Celica 1993 - On

UNIT PACKAGE: 15



22243

(Honda: 91560-S04-003)
White Nylon

Side Panel Moulding Retainer
Honda Accord 2015 - 1998
Honda Civic 2011 - 2007

UNIT PACKAGE: 25



22057

(BMW: 51498123832;
51490151605; 5149810579)
Black Nylon

Trim Panel Retainer
BMW 3, 5, 6, 7, 8, X &
Z Series 2012 - 1989

UNIT PACKAGE: 25



21488

(11610605)
Gray Nylon

Door Trim Panel Retainer
Chevrolet Cruze 2011 - On

UNIT PACKAGE: 25



22240

(GM: 11546588)
Yellow Nylon

Trim Panel Retainer
With Sealer
Chevrolet Colorado &
GMC Canyon 2015 - On

UNIT PACKAGE: 15



21365

(13252118)
Blue Nylon

Door Panel Retainer
Cadillac, Chevrolet &
GMC 2010 - On

UNIT PACKAGE: 25



21896

Gray Nylon

Trim Panel Retainer
Renault & Dacia

UNIT PACKAGE: 25



19719

(67921-32010)
White Nylon

Scuff Plate Retainer
Toyota Avalon, Camry
& Corolla 1997 - On

UNIT PACKAGE: 15



21977

(Renault & Dacia: 77-01-049-008)
White Nylon

Trim Panel Retainer
Peugeot, Citroen,
Renault & Dacia

UNIT PACKAGE: 25



20881

(5482103)
White Nylon

Cowl Vent Retainer
with Sealer
Chevrolet Equinox &
Pontiac Torrent 2005 - On

UNIT PACKAGE: 10

Sec. 19**TRIMMING SUNDRIES & FASTENERS**

Refer to Retainer Specification Chart on pages 475-489

**22252**(Mercedes-Benz: 000-991-63-98;
000-991-63-98-M22)
Yellow NylonDoor Garnish Moulding
Retainer with Sealer
Mercedes-Benz G1450, G1550,
M1320, M1550, R63, R320,
R350 & R500 2010 - 2006

UNIT PACKAGE: 15

**21567**(909130007)
Gray NylonPillar & Door Moulding
Trim & Rear Light
Retainer with Sealer
Subaru B9 Tribeca, Forester, Impreza,
Legacy & Outback 2005 - On

UNIT PACKAGE: 25

**22236**(Mercedes: 006-988-43-78)
White NylonTailgate Garnish
Retainer with Sealer
Mercedes-Benz C Class,
CLK Class, E Class, SL Class
& SLK Class 1996 - On

UNIT PACKAGE: 25

**21591**(909130109)
Black NylonFront & Rear Door, Fender,
Quarter Panel and Rocker Panel
Moulding Clip
Subaru B9 Tribeca, Forester, Impreza,
Legacy & Outback 2003 - On

UNIT PACKAGE: 25

**21495**(7L5-853-994)
Blue NylonTrim Panel Retainer
VW, Audi & Renault

UNIT PACKAGE: 25

**22133**(Not Available from O.E.M.)
Red NylonFender & Pillar Moulding
Retainer with Sealer
Ford Edge & Lincoln MKX 2007 - On

UNIT PACKAGE: 10

**21450**(703-867-299)
Black NylonSide Panel &
Interior Trim Retainer
VW 2003 - 1993

UNIT PACKAGE: 25

**22207**(Subaru: 909130088)
Black NylonFender, Rocker, Garnish, Pillar,
Floor & Exterior Trim
Retainer with Sealer
Subaru Forester, Impreza,
Legacy, Outback, B9 Tribeca
& WRX 2005 - On

UNIT PACKAGE: 25

**22179**(Ford: W718033-S300)
Black NylonRear Bumper
Retainer with Sealer
Ford Edge 2015 - On

UNIT PACKAGE: 10

**21107**(90602-SX0-003)
White NylonCowl Vent Retainer
Acura MDX, Honda Civic, Insight,
Odyssey & Prelude 1995 - On

UNIT PACKAGE: 10

TRIMMING SUNDRIES & FASTENERS

Sec. 19

Refer to Retainer Specification Chart on pages 475-489



20672

(66820-3S500-C1)
White Nylon

Cowl Vent Retainer
Nissan Frontier & Xterra 1998 - On

UNIT PACKAGE: 25



22063

(Nissan: 01553-02903)
White Nylon

Front Side Lower Fender
Panel Bracket Retainer
Overall Length: 21mm
Infiniti Qx4 & Qx56 and Nissan Pathfinder,
Frontier & Xterra 2010 - 1997

UNIT PACKAGE: 25



19464

(90667-SD4-003)
Natural Nylon

Roof Lining Retainer
Acura NSX, 2.2CL & 2.3CL 1991 - On

UNIT PACKAGE: 15



21226

(75867-02010)
Black Nylon

Overall Length: 15.5mm
Corolla 2009 - On

UNIT PACKAGE: 25



21012

(75867-AA010)
Black Nylon

Rocker Panel &
Scuff Plate Retainer
Lexus ES300 & ES330 2002 - On
Toyota Avalon, Camry, Scion & Solara 2004 - On

UNIT PACKAGE: 15



21538

(75867-33030)
Charcoal Nylon

Overall Length: 18.5mm
Avalon, Camry, Prius, Scion, Sienna,
Solara & Venza 2000 - On

UNIT PACKAGE: 25



21088

(90321122)
White Nylon

Door Panel Retainer
Saturn Ion 2003 - On

UNIT PACKAGE: 50



22056

(Toyota: 75867-30130)
White Nylon

Rocker Moulding Retainer
with Sealer
Lexus CT 200h, ES 300h, ES 350,
GS 300, GS 350, GS 430, GS 460,
GS 450h, HS 250h, IS 250, IS 350,
IS F, LS 460, LS 600h & LX 570 and
Toyota Land Cruiser 2006 - On

UNIT PACKAGE: 25



20932

(G18K-51-SJ3)
White Nylon

Door Trim Panel
Retainer with Sealer
Mazda 3, 5, 6, CX-7,
Miata & Protege 2001 - On

UNIT PACKAGE: 10



21678

(Mazda: NE51-51-SJ3A)
Black Nylon

Moulding Retainer
With Sealer
CX-9 & Miata 2006 - On

UNIT PACKAGE: 10

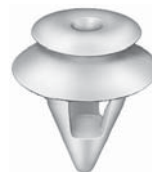

18875

(67771-16170)
White Nylon

Door Trim Panel Retainer
Toyota Tercel 1991 - On

UNIT PACKAGE: 25

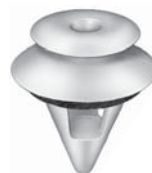

20473

(67771-12070)
White Nylon

Door Panel & Rocker Moulding
Retainer with Sealer
Lexus SC300/400 and
Toyota Avalon &
Corolla 1992 - On

UNIT PACKAGE: 15

Refer to Retainer Specification Chart on pages 475-489



21690
(Mitsubishi: MR322000)
White Nylon
Trim Panel Retainer with Sealer
Diamante, Eclipse, Galant, Montero &
Outlander 2000 - On
UNIT PACKAGE: 25



21489
(11610606)
Yellow Nylon
Door Trim Panel Retainer
Chevrolet Cruze 2011 - On
UNIT PACKAGE: 25



19334
(MB566720)
Natural Nylon
Rear Pillar Trim &
Air Inlet Grille Retainer
Mitsubishi Eclipse 1994 - On
UNIT PACKAGE: 15



21364
(13252119)
Green Nylon
Door Panel Retainer
Buick, Cadillac, Chevrolet
& GMC 2010 - On
UNIT PACKAGE: 25



22251
(Land Rover: LR013135)
White Nylon
Trim Panel, Tail Gate & Luggage
Compartment Retainer with Sealer
Land Rover LR3, Range Rover Sport &
Range Rover Sport Supercharge 2009 - 2005
UNIT PACKAGE: 15



22278
(GM: 11546963; 11547601)
Gray Nylon
Door Panel Retainer
Cadillac Escalade, Chevrolet Silverado,
Suburban & Tahoe and GMC Sierra &
Yukon 2015 - On
UNIT PACKAGE: 25

AN IMPROVED FASTRACK WEB

FasTrack is an easy-to-use, web based system designed to assist body shops and dealerships in recovering the cost of body repair clips and fasteners used in daily collision repairs.

Features:

- **New Look:** User-friendly design and intuitive functions with over 10,000 of our collision repair fasteners
- **Repair Kits:** Simple to build your own kits or choose one of the other preloaded kits
- **Add Part Numbers with Ease:** Add non-auveco items. Add new numbers on the fly during invoicing
- **OEM Numbers:** Available with the latest OEM pricing and ability to use during invoicing
- **Reports:** Page by page user selected printing to gather usage information
- **Inventory Management:** Allows shop and/or the distributor to track inventory
- **Labeling:** End user can print individual bar code labels and lid labels
- **Barcode Scanning:** Done with our app using any smart phone or with our wedge scanner
- **Online Catalog & OEM Crossover**
- **Repair Type:** Requested by many insurance companies you can now add Repair Type during invoice processing (Front Bumper, Front Fender, Door, etc.)
- **CCC® Integration:** Enables users to import FasTrack invoices into CCC's Estimating system
- **Tutorial Videos:** Found in the Help Menu, videos demonstrating all FasTrack features
- **Security:** Site protected by Verisign Internet Security.

Questions or concerns.

Call 1-800-354-9816 or email fastrack.support@auveco.com

TRIMMING SUNDRIES & FASTENERS

Sec. 19

Refer to Retainer Specification Chart on pages 475-489



22279

(GM: 11546964; 11547602)
Yellow Nylon

Door Panel Retainer
Cadillac Escalade, Chevrolet Suburban,
Tahoe and GMC Yukon 2015 - On

UNIT PACKAGE: 25



21819

Yellow Nylon

Retainer
VW, Audi, SEAT, Skoda & Ford

UNIT PACKAGE: 25



21853

(VW: 7M0-867-299-K, 7M3-867-299;
Land Rover: DYC500020;
Ford: 1008068)
Yellow Nylon

Door Trim Panel
Retainer with Sealer
Land Rover 1997 - On
VW & Audi 1999 - On

UNIT PACKAGE: 25



21787

(BMW: 51-77-7-171-002)
White Nylon

Wheel Arch Cover &
Footboard Retainer with Sealer
BMW X Series 2006 - On
Mini-Cooper S & SX Series 2011 - On

UNIT PACKAGE: 25



21412

(TD12-51-SJ3A)
Gray Nylon

Rocker Moulding
Retainer with Sealer
Mazda 6 GT 2010 - On

UNIT PACKAGE: 15



21893

(VW: 5J0-867-276)
White Nylon

Trim Panel Retainer With Sealer
VW, Audi, SEAT & Skoda

UNIT PACKAGE: 15



21996

(VW: 8P0-868-243)
Yellow & White Nylon

Trim Panel Retainer with Sealer
VW, Audi, SEAT & Skoda

UNIT PACKAGE: 10



21995

(VW: 8Z0-867-646)
White Nylon

Trim Panel Retainer with Sealer
VW, Audi, SEAT & Skoda

UNIT PACKAGE: 10



22244

(Land Rover: LR034389; LR053837)
White Nylon

Pillar Retainer with Sealer
Land Rover Discovery &
Range Rover Sport 2010 - On

UNIT PACKAGE: 15



21795

(Toyota: 67773-0E020)
White Nylon

Door Panel Retainer with Sealer
Overall Length: 20mm
Lexus RX350 2009 and Toyota Camry 2012 - On

UNIT PACKAGE: 25



22132

(Toyota: 53813-48011)
Gray Nylon

Front Fender Retainer with Sealer
Lexus HS 250h, RX 350 & RX 450h and
Toyota Prius & Sienna 2010 - On

UNIT PACKAGE: 10



20829

(6505534-AA)
Black Nylon

Door Trim Panel Retainer
Chrysler Concorde, Intrepid,
LHS & 300M 1998 - On

UNIT PACKAGE: 50



22093

(Land Rover: DKP5279L)
Black Nylon

Trim Panel Retainer
Land Rover Discovery &
Defender 2004 - 1989

UNIT PACKAGE: 25

Sec. 19

TRIMMING SUNDRIES & FASTENERS

Refer to Retainer Specification Chart on pages 475-489



19810

(N807943-S)
Black Nylon

Trim Panel Retainer
Ford Mustang 1995 - On

UNIT PACKAGE: 50



19213

(6503709)
Natural Nylon

Trim Panel Retainer
Dodge Ram 1994 - On

UNIT PACKAGE: 50



12565

(N801925-S)
Black Nylon

Door Trim Panel Retainer
Ford 1981 - On

UNIT PACKAGE: 25



17124

(N805155-S)
Black Nylon

Trim Panel Retainer
Ford 1985 - On

UNIT PACKAGE: 50



22259

(GM: 11547047)
Black Nylon

Headliner Retainer
Cadillac CT6 & ELR and
Chevrolet Impala 2015 - On

UNIT PACKAGE: 25



13470

(N802900)
White Nylon

Door Trim Panel Retainer
Ford

UNIT PACKAGE: 25



18848

(F58Z-16237A02-A)
Yellow Nylon

Door Trim Panel Retainer
Ford Windstar 1995 - On

UNIT PACKAGE: 25



17218

(21042045, 21042053,
21042058, 21042104)
Natural Nylon

Door Trim Panel Retainer
GM Saturn 1991 - On

UNIT PACKAGE: 50



21777

(BMW: 51-47-1-945-266)
Black Nylon

Trunk Luggage Compartment
& Sill Trim Retainer
3, 5 & M Series 1983 - On

UNIT PACKAGE: 25



21091

(22691056)
Black Nylon

Tailgate Moulding
Retainer with Sealer
Cadillac Escalade EXT
and Chevrolet Avalanche 2007 - On

UNIT PACKAGE: 15



20274

(Not Supplied by O.E.M.)
White Nylon

Door Panel Retainer
Use with Auveco 20275
Chrysler LH Series 2000 - On

UNIT PACKAGE: 25



19802

(MB566719)
White Nylon

Door Moulding Retainer
Chrysler Concorde, Eagle Talon
& Sebring 1996 - On

UNIT PACKAGE: 15



17102

(GM: 10143422;
Ford: N805612-S100;
AMC: 8934-202-599)
White Nylon

Trim Panel Retainer
Ford Tempo & Topaz, Jeep Eagle
& Premier and Pontiac 1988 - On

UNIT PACKAGE: 50

TRIMMING SUNDRIES & FASTENERS

Sec. 19

Refer to Retainer Specification Chart on pages 475-489



20944

(11588863)
Green Nylon

Door Trim Panel Retainer
Buick Terraza, Chevrolet
Uplander, Pontiac Montana
& Saturn Relay 2005 - On

UNIT PACKAGE: 25



18175

(10158124)
Natural Nylon

Trim Panel Retainer
GM, Chrysler 1992 - On

UNIT PACKAGE: 50



21346

(10350983)
White Nylon

Trim Panel Retainer with Sealer
Mates with Auveco 21347
Cadillac, Chevrolet
& Pontiac 2004 - On

UNIT PACKAGE: 15



21532

(Not Available from O.E.M.)
White Nylon

Front Bumper Cover Retainer
GM Trucks 2008 - On

UNIT PACKAGE: 25



11671

(387182-S)
Black Nylon

Seat Back Panel Retainer
Ford 1977 - On

UNIT PACKAGE: 25



18391

(15694099)
Natural Nylon

Rear Door Trim Panel Retainer
Chevrolet Astro &
GMC Safari Mini Vans 1993 - On

UNIT PACKAGE: 15



21516

(357-853-585)
White Nylon

Retainer with
Black Nylon Grommet
VW Golf A2 & A3 and Audi

UNIT PACKAGE: 25



21794

(Ford: W713579-S300)
White Nylon

Tail Light Mounting
Retainer with Sealer
Ford Escape, Explorer, Focus
MKZ & Zephyr 2006 - On

UNIT PACKAGE: 10



20634

(GM: 10363811; 22722859)
White Nylon

Door Panel Retainer
Use with Auveco 20635
Oldsmobile Alero &
Pontiac Grand Am 2002 - On

UNIT PACKAGE: 25



21383

(11561499)
White Nylon

Trim Panel Retainer
Use with Auveco 21384
Chevrolet Traverse 2010 - On

UNIT PACKAGE: 25



20995

(11562043)
White Nylon

Door Panel
Retainer with Sealer
Cadillac SRX & STS,
Chevrolet Cobalt & HHR and
Hummer H3 2004 - On

UNIT PACKAGE: 15



20996

(11562044)
Yellow Nylon

Door Panel
Retainer with Sealer
Cadillac SRX & STS, Chevrolet
Cobalt & HHR and
Hummer H3 2004 - On

UNIT PACKAGE: 15

Sec. 19

TRIMMING SUNDRIES & FASTENERS

Refer to Retainer Specification Chart on pages 475-489



20998
(11562256)
Black Nylon Pin
& White Nylon Grommet

Door Panel
Retainer with Sealer
Chevrolet Cobalt, HHR
& Full-Size Van 2005 - On

UNIT PACKAGE: 15



20999
(11562257)
Green Nylon Pin &
Yellow Nylon Grommet

Door Panel
Retainer with Sealer
Chevrolet Cobalt &
HHR 2006 - On

UNIT PACKAGE: 15



21535
(11571118)
White Nylon
Door Panel Retainer
& Grommet
Buick Enclave & Lucerne,
Cadillac DTS, Chevrolet
Traverse, GM "G" Vans,
GMC Acadia and
Hummer H2 2008 - On

UNIT PACKAGE: 15



21536
(11571119)
Yellow Nylon
Door Panel Retainer
& Grommet
Buick Enclave & Lucerne,
Cadillac DTS, Chevrolet
Cobalt, Colorado, Traverse,
GM "G" Vans, GMC Acadia
& Canyon and Pontiac G5 &
Pursuit 2008 - On

UNIT PACKAGE: 15



19527
(10408480)
Yellow Nylon
Door Garnish Moulding &
Pillar Trim Panel Retainer
Overall Length: 25/32"
Buick Century & Regal, Chevrolet Venture,
Olds Intrigue & Silhouette, Pontiac Grand Prix
and Trans Sport 1997 - On

UNIT PACKAGE: 25



19275
(10287971)
White Nylon
Door Trim Panel Retainer
Overall Length: 25/32"
Buick Century & Regal, Chevrolet Venture, Olds
Silhouette and Pontiac Trans Sport 1997 - On

UNIT PACKAGE: 50



16938
(15638413, 15963179)
Black Nylon
Trim Panel Retainer
Overall Length: 29/32"
GM Trucks 1991 - On

UNIT PACKAGE: 50



11797
(387477-S)
White Nylon
Interior Trim Panel
Overall Length: 15/16"
Ford 1977 - On

UNIT PACKAGE: 50



19356
(15986673)
White Nylon
Front & Rear Door
Trim Panel Retainer
Overall Length: 1-3/32"
GM Trucks S10 & S15 1996 - On

UNIT PACKAGE: 50



17075
(389144-S)
White Nylon
Trim Panel Retainer
Overall Length: 1-5/32"
Ford 1981 - On

UNIT PACKAGE: 50



19270
(10285935)
White Nylon
Trim Panel Retainer
Overall Length: 1-3/16"
Buick Century & Regal,
Chevrolet Venture, GM Truck
Express/Savana, Olds Silhouette &
Pontiac Trans Sport 1997 - On

UNIT PACKAGE: 50

TRIMMING SUNDRIES & FASTENERS

Sec. 19

Refer to Retainer Specification Chart on pages 475-489



20814

(10305191)
White Nylon

Door Panel Retainer
Overall Length: 1-3/16"
Chevrolet Impala, Lumina
& Monte Carlo 2000 - On

UNIT PACKAGE: 50



16695

(10153057)
White Nylon

Door Trim Panel Retainer
Overall Length: 1-1/4"
GM 1982 - On

UNIT PACKAGE: 25



20338

(10421018)
White Nylon

Door Trim
Panel Retainer
Overall Length: 1-9/16"
GM 1997 - On

UNIT PACKAGE: 25



22231

(VW: 1K6-837-200B)
Black Nylon

Door Panel Retainer
Overall Length: 13mm
VW Golf V, GTI, Jetta &
R32 2010 - 1999

UNIT PACKAGE: 25



21137

(07-13-0-702-516)
Black Nylon

Rear Quarter Wheel Opening
Moulding Retaining Clip
Overall Length: 14mm
Mini-Cooper 2002 - On

UNIT PACKAGE: 25



21785

(Volvo: 30624192)
Black & Yellow Nylon

Rocker Panel Moulding Retainer
Overall Length: 15mm
S60 & V60 2011 - On

UNIT PACKAGE: 25



21786

(Volvo: 30653441)
Black & White Nylon

Door Trim, Luggage Compartment
& Armrest Tray Trim Retainer
Overall Length: 15.5mm
C30, S40, V50, V60 & XC60 2004 - On

UNIT PACKAGE: 25



22008

(Hyundai: 85495-2E050)
Black Nylon

Headliner Retainer
Overall Length: 15.5mm
Hyundai & Kia

UNIT PACKAGE: 50



22336

(GM: 90560163)
White Nylon

Interior Trim Panel Retainer
Overall Length: 16mm
Saturn Astra, L100, L200, L300, LW2,
LW200, & LW300 2009 - 2000

UNIT PACKAGE: 25



18824

(G350-68-AB1)
White Nylon

Trim Panel Retainer
Overall Length: 16mm
Mazda 626, MX-6, Millenia, MX3, 929,
Protégé, MPV Ford Probe 1990 - On

UNIT PACKAGE: 50



21584

(693005370)
White Nylon

Front Door & Lift Gate
Trim Panel Retainer
Overall Length: 16mm
Subaru Impreza, Justy, Legacy &
Outback 2007 - 1987

UNIT PACKAGE: 25

Sec. 19

TRIMMING SUNDRIES & FASTENERS

Refer to Retainer Specification Chart on pages 475-489



20670
(01553-02821)
Gray Nylon

Trim Panel Retainer
Overall Length: 16mm
Nissan Maxima 1988 - On

UNIT PACKAGE: 15



21410
(90467-09212)
White Nylon

Cowl Trim Retainer
Overall Length: 16mm
Toyota Camry 2010 - On

UNIT PACKAGE: 25



21686
(Toyota: 67771-32120)
Green Nylon

Trim Panel Retainer with Sealer
Overall Length: 16.5mm
Lexus ES 300, GS 300, GS 450h,
IS F, IS 250, LS 460, LS 600hL, RX 350,
Scion XA and Toyota Prius 2001 - On

UNIT PACKAGE: 25



22048
(Subaru: 94078FA080)
White Nylon

Trim Panel Retainer
Overall Length: 16.5mm
Forester, Impreza & XV Crosstrek 1994 - On

UNIT PACKAGE: 25



22152
(Land Rover: LR028939)
White Nylon

Front Lower Fender &
Exterior Trim Retainer
Overall Length: 16.5mm
Land Rover Evoque, HSE &
Range Rover 2014 - 2012

UNIT PACKAGE: 25



20558
(62217-13010)
White Nylon

Garnish Moulding Retainer
Overall Length: 17mm
Lexus and Toyota Corolla,
Matrix & 4 Runner 2003 - On

UNIT PACKAGE: 25



22343
(Subaru: 909130096)
Green Nylon

Cowl, Garnish, Headliner,
Rocker, Pillar & Interior Trim Retainer
Overall Length: 17mm
Subaru B9 Tribeca, BRZ, Forester, Impreza, Legacy,
Outback, WRX & XV Crosstrek 2005 - On

UNIT PACKAGE: 25



21701
(Nissan: 85284-4J500)
Black Nylon

Retainer with Sealer
Overall Length: 17mm
Infiniti I35 and Nissan Altima,
Cube & Maxima 2011 - 02

UNIT PACKAGE: 10



21188
(82315-27000)
Pink Nylon

Trim Panel Retainer
Overall Length: 17mm
Hyundai & Kia 2003 - On

UNIT PACKAGE: 15



22313
(Hyundai: 82315-2W000)
Green Nylon

Door Panel, Interior Trim
& Garnish Retainer
Overall Length: 17mm
Hyundai Santa Fe & Sonata 2013 - On
Kia Forte & K900 2014 - On

UNIT PACKAGE: 25



21149
(91560-S84-A01)
White Nylon

Trim Panel Retainer
Overall Length: 17.5mm
Honda Accord & Element 2003 - On

UNIT PACKAGE: 25



20559
(GM: 88970345;
Toyota: 90467-10167)
Blue Nylon

Garnish Moulding Retainer
Overall Length: 17.5mm
Pontiac Vibe, Lexus and Toyota 2000 - On

UNIT PACKAGE: 25

TRIMMING SUNDRIES & FASTENERS

Sec. 19

Refer to Retainer Specification Chart on pages 475-489



21240

(10369649)
Green Nylon

Door Panel Retainer with Sealer
Overall Length: 17.5mm
Pontiac Torrent 2006 - On

UNIT PACKAGE: 25



22269

(Ford: W716507-S300)
White Nylon

Front & Rear Door,
Body Side and Wheel Opening
Moulding Retainer with Sealer
Overall Length: 17.5mm
Ford Transit Cargo & Passenger Van 2015 - On

UNIT PACKAGE: 15



19109

(67771-30070)
Natural Nylon

Door Trim Panel
& Garnish Retainer
Overall Length: 18mm
Toyota Corolla Wagon, Tercel
T-100 & Tacoma 2WD 1992 - On

UNIT PACKAGE: 25



21574

(909130034)
White Nylon

Door, Pillar, Rocker, Floor
& Interior Trim Retainer
Overall Length: 18mm
Subaru Baja, Forester, Legacy &
Outback 2008 - 03

UNIT PACKAGE: 25



21139

(07-14-7-145-753)
White Nylon

Body Side Moulding
Retainer with Sealer
Overall Length: 18mm
Mini-Cooper 2002 - On

UNIT PACKAGE: 25



21638

(91560-S0X-A01)
White Nylon

Trim Panel Retainer with Sealer
Overall Length: 18mm
Honda Accord, CR-V, Fit
& Odyssey 1999 - On

UNIT PACKAGE: 15



21675

(91560-SZW-003)
Green Nylon

Door Panel & Interior Trim Retainer
Overall Length: 18mm
Honda Civic 2012 - On

UNIT PACKAGE: 25



19466

(91560-SZ3-003)
White Nylon

Door Trim Panel Retainer
Overall Length: 18mm
Acura 3.5RL 1996 - On

UNIT PACKAGE: 15



21070

(Hyundai: 82315-38000
GM: 94530565)
White Nylon

Trim Panel Retainer
Overall Length: 18mm
Chevrolet Aveo 2004 - On
Hyundai Accent, Santa Fe, Sonata
Tiburon & XG300/350 1999 - On
and Kia Optima, Rio & Sorento 2001 - On

UNIT PACKAGE: 25



22312

(Kia: 0K95-A-68401)
Gray Nylon

Exterior & Interior Moulding Retainer
Overall Length: 18mm
Kia Soul, Sedona & Sportage 2010 - On

UNIT PACKAGE: 50



20983

(GJ6R-68-ABX)
White Nylon

Trim Panel Retainer with Sealer
Overall Length: 18mm
Mazda 3, 5, 6, Miata & RX-8 2003 - On

UNIT PACKAGE: 15



22305

(Mercedes: 001-991-26-98)
Yellow Nylon

Door Trim Panel Retainer with Sealer
Overall Length: 18mm
Mercedes-Benz CLS400, CLS550, CLS63,
S500, S600 & S63 2012 - On

UNIT PACKAGE: 15

Refer to Retainer Specification Chart on pages 475-489



22309

(Mercedes: 000-991-01-98; 011-988-76-78)
White Nylon

Door Upper Pillar Trim &
Trunk Lining Retainer with Sealer
Overall Length: 18mm
Mercedes-Benz C250, C300, C350,
C63, GLA250, GLA45, GLK250
& GLK350 2013 - On

UNIT PACKAGE: 15



19203

(67771-89104)
Natural Nylon

Quarter Board
Inside Trim Panel Retainer
Overall Length: 18.5mm
Toyota Truck 2WD 1997 - 91

UNIT PACKAGE: 15



21208

(91560-SLJ-J01)
Gray Nylon

Door Trim Panel Retainer
Overall Length: 18mm
Acura RDX and Honda
Civic, CR-V & Pilot 2009 - On

UNIT PACKAGE: 10



20411

(91560-S84-A11)
Black Nylon

Windshield Garnish Pillar
Retainer
Overall Length: 18.5mm
Acura 3.2CL, Honda Accord,
Insight & Odyssey 1998 - On

UNIT PACKAGE: 15



19731

(84915-0W000)
White Nylon

Trim Panel Retainer
Overall Length: 18.5mm
Nissan Pathfinder 1995 - On

UNIT PACKAGE: 15



21814

(Peugeot: 6991.S6;
Renault: 77-03-077-468)
White Nylon

Door Panel Retainer
Overall Length: 18.5mm
Renault, Dacia,
Peugeot and Citroen

UNIT PACKAGE: 25



21998

(Nissan: 01553-08101)
Yellow & White Nylon

Trim Panel Retainer
Overall Length: 18.5mm
Nissan

UNIT PACKAGE: 10



21554

(91560-S7A-003)
Black Nylon

Trim Panel Retainer
With Sealer
Overall Length: 18.5mm
Honda Crosstour, Fit &
Odyssey 2010 - 05

UNIT PACKAGE: 25



19145

(91560-SP0-003)
Gray Nylon

Front & Rear Door
Trim Panel Retainer
Overall Length: 18.5mm
Acura Integra & Legend and Honda
Accord, Civic, Prelude, Odyssey &
Del Sol 1991 - On

UNIT PACKAGE: 25

HAVE YOU VISITED US ONLINE?

Auveco's website has been completely renovated. Our new design is user friendly with easy navigation and ordering.

Product is searchable by car make, OEM number and category, as well as, several attribute drop downs within individual categories. All product also has stock availability listed.

Make sure to head over to www.auveco.com to receive up to date information on all our products.

TRIMMING SUNDRIES & FASTENERS

Sec. 19

Refer to Retainer Specification Chart on pages 475-489



21974

(Peugeot & Citroen: 6992.82)
White Nylon

Trim Panel Retainer with Sealer
Overall Length: 18.5mm
Peugeot & Citroen

UNIT PACKAGE: 25



21978

(Peugeot & Citroen: 6992.J4)
White Nylon

Trim Panel Retainer
Overall Length: 18.5mm
Peugeot & Citroen

UNIT PACKAGE: 25



22005

(Hyundai: 82315-33020)
White Nylon

Trim Panel Retainer
Overall Length: 18.5mm
Hyundai & Kia 1995 - On

UNIT PACKAGE: 50



20959

(91560-S9A-A01)
Blue Nylon

Door Panel Retainer
Overall Length: 19mm
Acura TL & TSX and Honda Accord,
Civic, CRV & Odyssey 2002 - On

UNIT PACKAGE: 25



21676

(91560-SZW-J01)
Yellow Nylon

Windshield Moulding
& Interior Trim Retainer
Overall Length: 19mm
Honda Civic 2012 - On

UNIT PACKAGE: 25



21916

(Peugeot & Citroen: 8335.TE;
Renault & Dacia: 82-00-700-969)
Yellow Nylon

Trim Panel Retainer
Overall Length: 19mm
Peugeot, Citroen, Renault & Dacia

UNIT PACKAGE: 25



21895

(Peugeot & Citroen: 6991.Z1;
Renault & Dacia: 82-00-909-084)
Blue Nylon

Trim Panel Retainer
Overall Length: 19mm
Peugeot, Citroen, Renault & Dacia

UNIT PACKAGE: 25



21917

Yellow Nylon

Trim Panel Retainer with Sealer
Overall Length: 19mm
Renault & Dacia

UNIT PACKAGE: 15



22285

(Mini-Cooper: 07-14-6-962-771)
Red Nylon

Rocker Moulding &
Pillar Retainer with Sealer
Overall Length: 19mm
Mini-Cooper 2006 - On

UNIT PACKAGE: 15



22156

(Land Rover: IPN500050)
White Nylon

Windshield Glass Side Moulding
Retainer with Sealer
Overall Length: 19mm
Land Rover HSE & Range Rover Sport 2012 - 2006

UNIT PACKAGE: 15



22003

(Hyundai: 82315-2P000)
White Nylon

Trim Panel Retainer
Overall Length: 19mm
Hyundai & Kia 1999 - On

UNIT PACKAGE: 50



21944

(Peugeot & Citroen: 8742.G2)
Green & White Nylon

Trim Panel Retainer
Overall Length: 19.3mm
Peugeot, Citroen, Renault & Dacia

UNIT PACKAGE: 10

Sec. 19

TRIMMING SUNDRIES & FASTENERS

Refer to Retainer Specification Chart on pages 475-489



21360
(85849-3B000)
White Nylon

Headliner & Trim Panel Retainer
Overall Length: 19.5mm
Hyundai 2001 - On

UNIT PACKAGE: 25



20668
(01553-09791)
White Nylon

Trim Panel Retainer
Overall Length: 20mm
Nissan & Infiniti 1999 - On

UNIT PACKAGE: 15



21414
(80999-VE000)
White Nylon

Trim Panel Retainer with Sealer
Overall Length: 19.5mm
Infiniti & Nissan 1993 - On

UNIT PACKAGE: 25



20437
(90467-09206)
White Nylon

Trim Panel Retainer with Sealer
Overall Length: 20mm
Toyota RAV 4 & Tundra 2000 - On

UNIT PACKAGE: 15



20575
(Toyota: 67771-12080;
GM: 88970656)
Yellow & White Nylon

Door Panel & Rocker
Moulding Retainer
Overall Length: 19.5mm
Toyota & Lexus 1998 - On
Pontiac Vibe 2003 - On

UNIT PACKAGE: 15



21102
(90467-A0005)
White Nylon

Door Trim Panel Retainer with Sealer
Overall Length: 20mm
Lexus ES 350, GX 470, IS 250, IS 350, IS
F, LS 460 & LS 600HL and Toyota Camry,
FJ Cruiser, Highlander, RAV4 & 4-Runner
2001 - On

UNIT PACKAGE: 15



21206
(91560-S6A-003)
Orange Nylon

Rear Liftgate Retainer
Overall Length: 19.5mm
Honda Fit 2009 - On

UNIT PACKAGE: 15



18844
(67771-06010, 67771-32090)
White Nylon

Trim Panel Retainer
Overall Length: 20mm
Cowl Side & Garnish
Center Pillar Retainer
Toyota Camry 1991 - On

UNIT PACKAGE: 10



20879
(007-988-99-78, 007-988-34-78)
Green Nylon

Door Trim Panel Retainer
Overall Length: 19.5mm
Mercedes-Benz 1996 - On

UNIT PACKAGE: 10



21654
(Not Available from O.E.M.)
White Nylon

Trim Panel Retainer
Overall Length: 20mm
Lincoln MTX 2012 - On

UNIT PACKAGE: 25



22237
(Nissan: 01553-30001)
White Nylon

Trim Panel Retainer
Overall Length: 20mm
Nissan Altima, Cube, GT-R, Murano,
Pathfinder, Quest, Rogue, Sentra,
Versa & Versa Note 2007 - On

UNIT PACKAGE: 25



18950
(90467-10168)
Black & White Nylon

Garnish Retainer
Overall Length: 20mm
Toyota Avalon & Camry 1991 - On

UNIT PACKAGE: 5

TRIMMING SUNDRIES & FASTENERS

Sec. 19

Refer to Retainer Specification Chart on pages 475-489



21329

Black Nylon
(68061648-AA)

Tail Light Retainer
Overall Length: 20mm
Dodge Ram 2009 - On

UNIT PACKAGE: 15



21976

(Peugeot & Citroen: 6966.39)
White Nylon

Trim Panel Retainer
Overall Length: 20mm
Peugeot & Citroen

UNIT PACKAGE: 15



14728

(67771-22020)
Natural & Yellow Nylon

Door Panel Retainer
Overall Length: 20mm
Toyota

UNIT PACKAGE: 25



21822

(Peugeot & Citroen: 6822.LL)
White Nylon

Door Panel Retainer
Overall Length: 20mm
Peugeot, Citroen & Toyota

UNIT PACKAGE: 25



22009

(Hyundai: 85506-4A000)
White Nylon

Trim Panel &
Window Garnish Retainer
Overall Length: 20mm
Hyundai Tucson & Kia Sorento 2003 - On

UNIT PACKAGE: 50



22004

(Hyundai: 82315-22000)
White Nylon

Trim Panel Retainer
Overall Length: 20mm
Hyundai Accent 1999 - 95

UNIT PACKAGE: 50



21289

(84953-JA00A)
Yellow Nylon

Trim Panel Retainer
Overall Length: 20mm
Nissan Altima 2010 - On

UNIT PACKAGE: 25



14269

(Isuzu: 8942264920;
Mazda: 9927-40-825;
Toyota: 67771-01010, 67771-12010)
White Nylon

Door Panel Retainer
Overall Length: 20.5mm
Isuzu, Mazda & Toyota

UNIT PACKAGE: 25



22157

(Jaguar: C2D5807)
Yellow Nylon

Rocker Moulding Retainer
Overall Length: 20mm
Jaguar XJ & XJ-L 2011 - On

UNIT PACKAGE: 15



21138

(51-43-7-001-491-2)
White Nylon

Headliner Retainer
Overall Length: 20.5mm
Mini-Cooper 2005 - On

UNIT PACKAGE: 25



20633

(90467-10188)
Turquoise Nylon

Trim Panel Retainer
Overall Length: 20mm
Toyota Sienna 2004 - On

UNIT PACKAGE: 25



15709

(67771-02030)
Natural Nylon

Door Trim Retainer
Overall Length: 20.5mm
Toyota Corolla 1990 - On

UNIT PACKAGE: 50

Sec. 19

TRIMMING SUNDRIES & FASTENERS

Refer to Retainer Specification Chart on pages 475-489



18876

(Toyota: 90467-10161;
GM: 94858299)
White Nylon

Trim Board Retainer
Overall Length: 20.5mm
Sienna, Solara & Tercel 1990 - On
Geo Prizm & Pontiac Vibe 1998 - On

UNIT PACKAGE: 25



21640

(84953-AU100)
Black Nylon

Door Trim Panel Retainer with Sealer
Overall Length: 20.5mm
Infiniti FX35, FX45, G35 & G37
2008 - 03

UNIT PACKAGE: 15



21502

(909130213)
White Nylon

Door Trim Panel Retainer with Sealer
Overall Length: 20.5mm
Subaru Legacy & Outback 2010 - On

UNIT PACKAGE: 10



15707

(67771-03030)
Gray Nylon

Door Trim Retainer
Overall Length: 20.5mm
Toyota Camry 1988 - On

UNIT PACKAGE: 50



21118

(MB374270, MB374271)
White Nylon

Trim Panel Retainer
Overall Length: 20.5mm
Chrysler Laser, Stealth,
Jeep Eagle & Talon and
Mitsubishi Eclipse &
Montero 1989 - On

UNIT PACKAGE: 15



19898

(67771-02030)
Yellow Nylon

Trim Panel Retainer
Overall Length: 20.5mm
Toyota Corolla 1990 - On

UNIT PACKAGE: 50



14270

(67771-22010)
Blue & Natural Nylon

Door Panel Retainer
Overall Length: 20.5mm
Toyota

UNIT PACKAGE: 25



22267

(GM: 11546850)
White Nylon

Front Fender &
Exterior Trim Moulding Retainer
Overall Length: 20.5mm
GMC Sierra 2015 - On

UNIT PACKAGE: 50



14144

(GM: 95005064;
Toyota: 67771-01010)
Black Nylon

Trim Panel Retainer
Overall Length: 20.5mm
Toyota & GM

UNIT PACKAGE: 25



19910

(90467-08179)
Yellow Nylon

Garnish Retainer
Overall Length: 20.5mm
Toyota Tundra 1999 - On

UNIT PACKAGE: 25



20669

(01553-07111)
Black Nylon

Trim Panel Retainer
Overall Length: 20.5mm
Nissan Altima and
Infiniti G35 & Q45 1997 - On

UNIT PACKAGE: 25



21087

(90602-SAA-003)
Orange Nylon

Cowl Vent & Radiator Support Retainer
Overall Length: 20.5mm
Honda Fit & CRV 2003 - On

UNIT PACKAGE: 15

TRIMMING SUNDRIES & FASTENERS

Sec. 19

Refer to Retainer Specification Chart on pages 475-489



19257

(GM: 30006620;
Toyota: 67771-12050;
Suzuki: 09409-08320)
Nylon

Cowl Vent Screen &
Door Trim Panel Retainer
Overall Length: 20.5mm

Chevrolet Geo, Metro & Tracker, Lexus and Toyota
Celica, Corolla & Previa 1989 - On

UNIT PACKAGE: 15



19108

(67771-16080)
Natural Nylon

Door Trim Panel & Back Panel
Upper Garnish Retainer
Overall Length: 21mm
Toyota Truck 1988 - On

UNIT PACKAGE: 10



20610

(Honda: 91560-SM4-003)
White Nylon

Door Trim Panel Retainer
Overall Length: 21mm
Honda Accord 1990 - On

UNIT PACKAGE: 25



19386

(6505292AA)
Natural Nylon

Door Trim Panel Retainer
Overall Length: 21mm
Chrysler Vans 1998 - On

UNIT PACKAGE: 25



20515

(6505918-AA)
Yellow & White Nylon

Trim Panel Retainer
Overall Length: 21mm
Chrysler Caravan,
Town & Country and Voyager
Mini-Vans 2001 - On

UNIT PACKAGE: 25



22315

(Hyundai: 85849-3L000)
Gray Nylon

Garnish & Interior Moulding Retainer
Overall Length: 21mm
Hyundai Azera, Sonata &
Tuscon 2006 - On
Kia Forte 2010 - On

UNIT PACKAGE: 50



18874

(67771-16120)
Gray Nylon

Front & Rear Door
Trim Panel Retainer
Overall Length: 21mm
Toyota Tercel 1994 - On

UNIT PACKAGE: 15



19016

(67771-12040)
Dark Gray Nylon

Door Trim Panel Retainer
Overall Length: 21mm
Toyota Cressida 1992 - 88

UNIT PACKAGE: 15



21788

(BMW: 51-41-8-224-768,
51-41-0-407-984)
White Nylon

Door Panel Lining &
Rear Window Retainer with Sealer
Overall Length: 21mm
BMW X Series 2006 - On
Mini-Cooper 2002 - On

UNIT PACKAGE: 25



21873

(BMW: 51-43-7-001-491)
White Nylon

Trim Panel Retainer
Overall Length: 21mm
Renault, Dacia & BMW

UNIT PACKAGE: 25



22229

(BMW: 51418224781;
51410407983; 51430141025)
Gray Nylon

Door Trim Panel Retainer with Sealer
Overall length: 21mm
BMW 1, 3, 4, 5, 6, X & Z Series 1992 - On

UNIT PACKAGE: 25



21247

(W709995-S300)
Green Nylon

Lift Gate Trim Retainer
Overall Length: 21mm
Ford Flex 2009 - On

UNIT PACKAGE: 25

Sec. 19

TRIMMING SUNDRIES & FASTENERS

Refer to Retainer Specification Chart on pages 475-489



22206

(Subaru: 909130105)
White Nylon

Front & Rear Door, Headliner, Interior Trim,
Liftgate & Quarter Panel Retainer

Overall Length: 21mm

Subaru BRZ, Forester, Impreza, Legacy, Outback, B9
Tribeca, WRX & XV Crosstrek 2002 - On

UNIT PACKAGE: 50



22220

(GM: 92138811)
White Nylon

Front & Rear Door Sill and
Rocker Panel Moulding Retainer

Overall Length: 21.6mm

Chevrolet Caprice & SS 2011 - On
Pontiac G8 2009 - 2008

UNIT PACKAGE: 25



22006

(Hyundai: 82315-36000, 92552-36000)
White Nylon

Trim Panel Retainer with Sealer

Overall Length: 21mm

Hyundai Accent & Elantra 2000 - 1995

UNIT PACKAGE: 25



19210

(67771-04040)
Natural Nylon

Front Door Trim Panel Retainer

Overall Length: 22mm

Toyota Tacoma 1995 - On

UNIT PACKAGE: 50



21059

(90602-S5A-003)
Blue Nylon

Cowl Vent Retainer

Overall Length: 21mm

Acura RSX and Honda Civic & CR-V
2001 - On

UNIT PACKAGE: 15



18294

(91566-SP0-003)
White Nylon

Trim Panel Retainer

Overall Length: 22mm

Honda 1990 - On

UNIT PACKAGE: 15



21884

(Peugeot & Citroen: 6990.50)
White Nylon

Trim Panel Retainer

Overall Length: 21.3mm

Peugeot & Citroen

UNIT PACKAGE: 25



19628

(5012874-AA, 6505539-AA)
White Nylon

Door Trim Panel Retainer

Overall Length: 22mm

Jeep Grand Cherokee 1999 - On

UNIT PACKAGE: 25



18915

(6504014)
White Nylon

Door Trim Panel Retainer

Overall Length: 21.5mm

Chrysler Caravan Cirrus, Neon, Ram
Truck, Stratus & Voyager 1995 - On

UNIT PACKAGE: 50



21333

(11561654)
Blue Nylon

Cowl, Pillar, Trim Panel
& Windshield Retainer

Overall Length: 22mm

GM 2006 - On

UNIT PACKAGE: 15



17669

(6502907, 6504452)
Yellow Nylon

Trim Panel Retainer

Overall Length: 21.5mm

Jeep Grand Cherokee
& Dodge Truck 1993 - On

UNIT PACKAGE: 50



22288

(Infiniti: 01553-10641)
Green Nylon

Door & Interior Trim Panel Retainer

Overall Length: 22mm

Infiniti FX35, FX 37, FX50 & QX70
2009 - On

UNIT PACKAGE: 25

TRIMMING SUNDRIES & FASTENERS

Sec. 19

Refer to Retainer Specification Chart on pages 475-489



18862
(6503204)
Green Nylon

Trim Panel Retainer
Overall Length: 23mm
Chrysler Cirrus & Stratus 1995 - On

UNIT PACKAGE: 50



20428
(5028438-AA)
Green & White Nylon

Door Trim Panel Retainer
Overall Length: 24.5mm
Chrysler Vans 2001 - On

UNIT PACKAGE: 25



21250
(Not Available from O.E.M.)
Black Nylon

Seat Back & Trim Panel Retainer
Overall Length: 23mm
Jeep Commander 2006 - On

UNIT PACKAGE: 25



20190
(W708621-S300)
Caramel & Natural Nylon

Trim Panel Retainer
Overall Length: 25mm
Ford Taurus & Sable
2000 - On

UNIT PACKAGE: 25



20765
(6507055-AA, 6507686-AA)
Yellow Nylon

Door Panel Retainer
Overall Length: 23mm
Jeep Grand Cherokee
2003 - On

UNIT PACKAGE: 50



20949
(W711037-S300)
Black & Blue Nylon

Door Trim Panel Retainer
Overall Length: 25mm
Ford Edge, Escape, Freestyle
Mariner, Montego & 500 2005 - On

UNIT PACKAGE: 25



22149
(Land Rover: LR027255)
Blue Nylon

Wheel Arch Moulding Retainer
Overall Length: 23mm
Land Rover Evoque 2012 - 2004

UNIT PACKAGE: 15



21131
(90602-SEP-A00)
Black Nylon

Trim Panel Retainer
Overall Length: 25.5mm
Acura TL 2007 - On

UNIT PACKAGE: 15



19129
(GM: 95008221;
Toyota: 67771-30090;
Chrysler & Mitsubishi: MB608104)
Yellow Nylon

Door Trim Panel &
Back Panel Lower Garnish Retainer
Overall Length: 23.5mm
Toyota Land Cruiser & 2WD Truck 1991 - On
Geo Prism 1997 - 93

UNIT PACKAGE: 15



20444
(15076791)
White Nylon

Trim Panel Retainer
Overall Length: 26mm
GM Trucks: Rendezvous, S & T 2002 - On

UNIT PACKAGE: 15



22031
(GM: 11569700)
Gray Nylon

Trim Panel Retainer
Overall Length: 24mm
Cadillac SRX; Chevrolet Equinox &
Tahoe and GMC Denali & Yukon 2010 - On

UNIT PACKAGE: 15



20616
(GM: 11519031;
Ford: W711521-S300)
White Nylon

Door Panel Retainer
with Sealer
Overall Length: 26mm
Hummer H2 2003 - On
Lincoln 2007 - On

UNIT PACKAGE: 15

Sec. 19

TRIMMING SUNDRIES & FASTENERS

Refer to Retainer Specification Chart on pages 475-489



20427

(6505759-AA)

Gray & White Nylon

Door Trim Panel Retainer

Overall Length: 26mm

Chrysler Vans 2001 - On

UNIT PACKAGE: 25



21379

(15931605)

Black Nylon

Cowl Grille Retainer with Sealer

Overall Length: 26mm

Chevrolet Traverse 2010 - On

UNIT PACKAGE: 10



21169

(W713297-S300)

White Nylon

Door Trim Panel Retainer with Sealer

Overall Length: 28mm

Ford Flex 2009

UNIT PACKAGE: 25



21189

(11519032)

Black Nylon

Trim Panel Retainer

Overall Length: 28mm

Buick Lucerne & Rainier, Cadillac DTS, Escalade & SPX, Chevrolet Avalanche, Malibu, Silverado, Tahoe & Trailblazer, GMC Envoy, Sierra, Suburban & Yukon, Hummer H2, H3 & H3T, Oldsmobile Bravada and Pontiac G6 2002 - On

UNIT PACKAGE: 10



18930

(22600612, 22651066)

Yellow Nylon

Trim Panel Retainer

Overall Length: 28mm

GM 1996 - On

UNIT PACKAGE: 25



22034

(GM: 11562568)

White Nylon

Windshield Garnish & Interior Trim Retainer

Overall Length: 29mm

Buick Enclave, Lucerne & Verano; Cadillac ATS, CTS, SRX & XTS; Chevrolet Cruze, Equinox & Traverse and GMC Acadia & Terrain 2008 - On

UNIT PACKAGE: 10



20563

(5023173-AA)

White Nylon

Door Trim Panel Retainer

Overall Length: 30mm

Jeep Liberty 2002 - On

UNIT PACKAGE: 15



22090

(BMW: 51477117532)

Brown Nylon

Scuff Plate Retainer with Sealer Top

Overall Length: 30mm

Fits into 10mm Hole

BMW 1, 3, 5, 6 & X Series 2012 - 02

UNIT PACKAGE: 15



17685

(6502991)

Yellow Nylon

Trim Panel & Tail Gate Retainer

Overall Length: 31.5mm

Jeep Cherokee 1993 - On

UNIT PACKAGE: 25



22012

(Hyundai: 87378-3N000)

Blue Nylon

License Plate Panel Retainer with Sealer

Overall Length: 44.5mm

Hyundai Equus 2011 - On

UNIT PACKAGE: 25



19775

(55350747AB)

White Nylon

Door Trim Panel Retainer with Sealer

Chrysler Mini-Vans 1999 - On

UNIT PACKAGE: 15



19428

(22646099)

White Nylon

Trim Panel Retainer with Sealer

Chevrolet Cavalier &

Pontiac Sunfire 1995 - On

UNIT PACKAGE: 25

TRIMMING SUNDRIES & FASTENERS

Sec. 19

Refer to Retainer Specification Chart on pages 475-489



19758
(25704141)
Green Nylon

Trim Panel Retainer
with Sealer
Buick LeSabre &
Pontiac Bonneville 2000 - On

UNIT PACKAGE: 10



19804
(5023111AA)
White Nylon

Trim Panel Retainer
with Sealer
Dodge Neon 2000 - On

UNIT PACKAGE: 15



22250
(Jaguar: C2C14628)
Black Nylon

Trim Panel Retainer
With Sealer
Jaguar 2015 - On

UNIT PACKAGE: 15



20188
(003-988-41-78)
White Nylon

Trim Panel Retainer
Mercedes-Benz Body Styles
107, 108, 109, 114, 115,
123 & 124 1995 - 68

UNIT PACKAGE: 10



21494
(VW: 171-807-249-A)
Natural Nylon

Trim Panel Retainer
VW Golf & Audi 1978 - On

UNIT PACKAGE: 25



20735
(463-988-02-78)
Black Nylon

Door Panel Retainer
Mercedes-Benz
G55 & G500
2002 - On

UNIT PACKAGE: 25



14363
(9927-40-821)
Natural Nylon

Door Panel Retainer
Mazda

UNIT PACKAGE: 25



13179
(BMW: 51-41-8-172-050;
VW: 481-867-197)
Black Nylon

Trim Panel Retainer
VW & BMW

UNIT PACKAGE: 50



16778
(Mazda: 9927-40-822;
Toyota: 62581-14020)
Natural Nylon

Trim Panel Retainer
Mazda & Toyota

UNIT PACKAGE: 25



20252
(823-867-299)
Black Nylon

Trim Panel Retainer
VW Corrado, Eurovan, Jetta,
Rabbit & Vanagon 1979 - On

UNIT PACKAGE: 25

Sec. 19**TRIMMING SUNDRIES & FASTENERS**

Refer to Retainer Specification Chart on pages 475-489

**11349**(AMC: 4005099; GM: 796255;
Chry: 6033862)
Black NylonDoor Panel Retainer
American Motors 1976 - On
GM 1988 - 81
Jeep Wrangler 1991 - On

UNIT PACKAGE: 25

**13475**(Renault: 8934-201-681;
VW: 175-867-299)
White NylonTrim Panel Retainer
AMC-Renault 1984 - On
VW 1982 - On

UNIT PACKAGE: 50

**13945**(01553-S3500)
White NylonDoor Trim Panel Retainer
Nissan Trucks

UNIT PACKAGE: 50

**16017**(363137)
White NylonTrim Panel Retainer
Chevrolet Truck & GMC 1976 - On

UNIT PACKAGE: 100

15461

Same as 16017 except for unit package quantity

UNIT PACKAGE: 50

**11678**(Chry: 6003349; GM: 9685057;
AMC: 4005470; VW: N98905101)
White NylonDoor Trim Panel Retainer
Chrysler, GM, AMC & VW 1976 - On

UNIT PACKAGE: 25

**13453**(20480475)
White NylonRear Quarter Panel Retainer
GM

UNIT PACKAGE: 50

**13461**(20451401)
White NylonRetains Conduit to Sheet Metal in Doors
GM

UNIT PACKAGE: 25

**11672**(387496-S)
White NylonTrim Panel Retainer
Ford 1976 - On

UNIT PACKAGE: 25

**15669**(10126901)
White NylonTrim Panel Retainer
GM 1987-On

UNIT PACKAGE: 50

**20253**(51-41-1-973-500)
White NylonTrim Panel Retainer
BMW Series 3, 5 & 7 1987 - On

UNIT PACKAGE: 50

**10621**(2064891, 9818648, 9883583)
White NylonDoor Trim Panel &
Headliner Retainer
GM 1971 - On

UNIT PACKAGE: 50

16260

Same as 10621 except for unit package quantity

UNIT PACKAGE: 100

**11774**(9883583)
White NylonDoor Trim Panel Retainer
GM 1971 - On

UNIT PACKAGE: 50

TRIMMING SUNDRIES & FASTENERS

Sec. 19

Refer to Retainer Specification Chart on pages 475-489



12737

(12337920, 20374473)
White Nylon

Door Panel Retainer
Camaro & Firebird 1982-On
GM Truck 1989-On

UNIT PACKAGE: 50

14524

Same as 12737 except for unit package quantity

UNIT PACKAGE: 25



11796

(3065575)
White Nylon

Door Trim Panel Retainer
GM 1978-On

UNIT PACKAGE: 50

16261

Same as 11796 except for unit package quantity

UNIT PACKAGE: 100



13992

(20429451)
White Nylon

Door Trim Panel Retainer
GM 1984-On

UNIT PACKAGE: 25



11677

(GM: 20298365; Chry: 6013122)
Natural Nylon

Trim Panel Retainer
Chrysler 1976-On
GM 1982-On

UNIT PACKAGE: 50



17649

(15953247)
White Nylon

Trim Panel Retainer
GM C & K Trucks 1993-On

UNIT PACKAGE: 50



20279

(25672428)
White Nylon

Trim Panel Retainer
with Sealer
Buick LeSabre & Park Ave., Cadillac
DeVille & Seville, Oldsmobile Aurora
& Pontiac Bonneville 1998 - On

UNIT PACKAGE: 10



15670

(15545202)
White Nylon

Door Trim Panel Retainer
GM Trucks 1988-On

UNIT PACKAGE: 50



12992

(10073833, 15600382, 20421800)
White Nylon

Door Trim Panel Retainer
GM 1983 - On

UNIT PACKAGE: 25



13946

(15588024, 15596301)
Yellow Nylon

Side & Rear Door Trim Retainer
GM Astro & Safari Mini-Vans 1985 - On

UNIT PACKAGE: 25



17092

(20734005)
Yellow Nylon

Door Trim Panel Retainer
GM 1982 - On

UNIT PACKAGE: 50



15970

(15607165, 15612948)
White Nylon

Trim Panel Retainer
GM Trucks 1976 - On

UNIT PACKAGE: 25

Sec. 19

TRIMMING SUNDRIES & FASTENERS

Refer to Retainer Specification Chart on pages 475-489



18936

(N811006-S)
Natural Nylon

Trim Panel Retainer
Ford 1995-On

UNIT PACKAGE: 25



14758

(D9AB-74519B18-AA)
White Nylon

Roof Liner
Moulding Retainer
Ford Taurus &
Sable 1986-On

UNIT PACKAGE: 25



20341

(3B0-868-243)
Black Nylon

Door Trim Panel Retainer
VW Beetle, Golf, Jetta &
Passat 1998 - On

UNIT PACKAGE: 25



21398

(VW: 6K0-868-243-C)
Black Nylon

Trim Panel Retainer
Audi and
Volkswagen Touareg 2004 - On

UNIT PACKAGE: 25



21144

(VW: 8E0-868-243)
Black Nylon

Interior Trim Panel
Retainer with Sealer
Audi A4 & S4, Avant, Sedan Wagon,
Cabriolet & Quattro 2005 - On

UNIT PACKAGE: 25



21894

(VW: 5X0-867-299)
Black Nylon

Trim Panel Retainer
VW, Audi, SEAT & Skoda

UNIT PACKAGE: 15



21708

(VW: 7L6-868-243)
Black Nylon

Door Trim Panel
Audi A5, A6, A7, S5, S6
& S7 And VW Beetle,
Cabrio, Golf, Gti, Jetta,
Passat & Touareg 2004 - On

UNIT PACKAGE: 15



21393

(VW: 1H0-868-243)
Blue & Black Nylon

Trim Retainer
Audi and Volkswagen Cabrio
Golf & Jetta 1999 - 1993

UNIT PACKAGE: 25



21415

(VW: 1H0-868-243-B)
Tan and White Nylon

Adjustable Door
Trim Panel Retainer
VW Golf 2002 - 1993

UNIT PACKAGE: 25



21997

(VW: 6N0-868-243A)
Black & White Nylon

Trim Panel Retainer
VW, Audi, SEAT & Skoda

UNIT PACKAGE: 10



22091

(BMW: 51717066299)
Black Nylon

Door Sill Cover Retainer
T27 Drive
BMW 5 & 6 Series 2011 - 02

UNIT PACKAGE: 15

TRIMMING SUNDRIES & FASTENERS

Sec. 19

Refer to Retainer Specification Chart on pages 475-489



21854

(BMW: 07-14-7-122-913)
Black Nylon

Rocker Trim
Wheelhouse Retainer
T10 Torx® Drive
1, 3, 6 & X Series 2004 - On

UNIT PACKAGE: 15



21851

(BMW: 51-47-8-116-564,
51-47-2-499-935,
51-47-8-183-031
51-47-1-881-521)
Black Nylon

Floor Mat Lock
Retainer with Washer
3, 5, 7 & 8 Series 1997 - On

UNIT PACKAGE: 10



22245

(Land Rover: LR012844)
Black Nylon

Body Liner Twist to Lock Retainer
Land Rover Discovery,
Range Rover &
Range Rover Sport 2004 - On

UNIT PACKAGE: 15



22092

(BMW: 51717066226)
Black Nylon

Rocker Moulding &
Door Sill Spacer Cover Retainer
Overall Length: 27mm
BMW 5 & 6 Series 2011 - 02

UNIT PACKAGE: 15



22086

(BMW: 07147122912)
Black Nylon

Rocker Panel &
Wheelhouse Trim Retainer
Overall Length: 32mm
BMW 1, 3, 6 & X Series 2012 - 04

UNIT PACKAGE: 15



19524

(N807875-S)
Green Nylon

Door Trim Panel Retainer
Lincoln Continental 1995 - On

UNIT PACKAGE: 25



21023

(6503336)
Black Nylon

Cowl Screen Retainer
Use with Auveco 18249
Dodge Ram 1994 - On

UNIT PACKAGE: 25



20866

White Nylon

Double End Retainer
Marine & Automotive Trim Shops

UNIT PACKAGE: 25



17599

(15672328)
Black Nylon

Radiator Grille Retainer
GM S-10 & S-15 Pick-Ups 1991-On

UNIT PACKAGE: 25

**Auveco releases new items biweekly.
Our Hot New Items bulletins can keep you
up to date on all new product.**

**To receive these bulletins please
contact customer service:
mail@auveco.com or 1-800-354-9816**

**We also have all previous and current
bulletins posted on www.auveco.com.**

Sec. 19

RETAINER SPECIFICATION CHART

Recommended Hole Size: .030" - .060" smaller than stem diameter

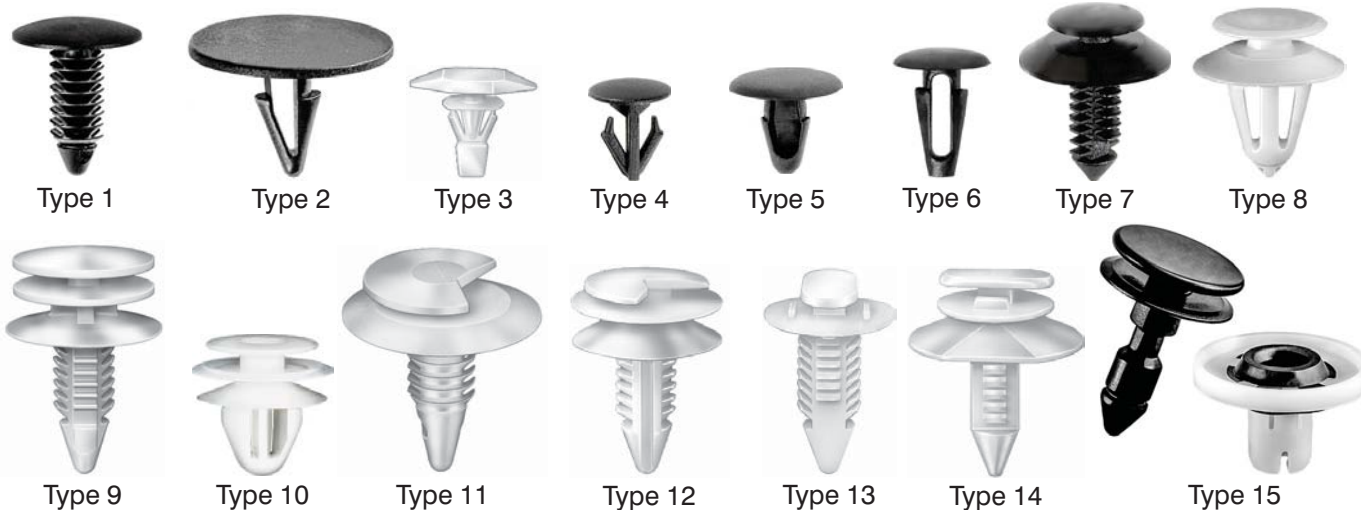

Auveco Part No.	Type	Color	Bottom Head Diameter	Top Head Diameter	Stem Diameter	Stem Length	Page No.
3620	5	Black	13/32"		9/64"	7/16"	442
3639	5	White	3/8"		7/32"	7/16"	442
5592	5	Black	1/2"		9/32"	5/8"	442
8853	3	Natural	3/16" x 1/2"		3/16"	5/8"	437
10332	1	Black	1-1/4"		5/16"	1/2"	428
10621	12	White	3/4"	11/16"	5/16"	1/2"	471
10744	3	Black	3/16" x 1/2"		3/16"	7/16"	437
10831	1	Black	11/16"		5/16"	5/8"	425
10832	1	Gray	11/16"		5/16"	5/8"	425
11120	1	Black	13/32"		5/32"	3/8"	416
11129	1	Black	3/8"		7/32"	3/8"	416
11130	1	Black	2"		5/16"	3/4"	434
11136	2	Black	1/2" x 1-1/2"		9/32"	5/8"	441
11146	1	Black	11/16"		5/16"	13/16"	425
11347	1	Black	3/4"		9/32"	1/2"	421
11349	11	Black	3/4"	19/32"	5/16"	11/16"	471
11350	1	White	1-7/32"		5/16"	1-1/16"	433
11351	1	Black	15/16"		5/16"	11/16"	429
11612	1	Black	7/16"		3/16"	5/8"	418
11671	7	Black	5/8"	1/2"	11/32"	1-1/8"	456
11672	11	White	15/16"	29/32"	5/16"	15/16"	471
11673	1	Natural	15/16"		5/16"	11/16"	429
11675	1	Black	5/8"		5/16"	11/16"	420
11677	13	Natural	9/16"	3/8" x 9/16"	11/32"	11/16"	472
11678	11	White	15/16"	29/32"	5/16"	11/16"	471
11679	1	Black	3/4"		9/32"	1/2"	421
11680	1	Black	7/16"		3/16"	5/8"	418
11721	1	Black	1/2"		9/32"	3/4"	417
11774	12	White	3/4"	11/16"	5/16"	1/2"	471
11796	12	White	7/8"	29/32"	5/16"	3/4"	472
11797	10	White	3/4"	1/2"	11/32"	9/16"	457
11842	1	Black	1-1/4"		5/16"	1-3/16"	433
12137	1	Black	1"		7/16"	13/16"	430
12565	7	Black	25/32"	1/2"	5/16"	5/8"	455
12571	1	Black	1"		5/16"	13/16"	429
12731	1	Black	25/32"		5/16"	15/16"	429
12737	12	White	3/4"	21/32"	5/16"	3/4"	472
12759	1	Black	1"		9/32"	1-7/16"	431
12766	1	Black	7/8"		7/16"	13/16"	430
12909	1	Black	1"		9/32"	1-1/16"	431
12992	14	White	3/4" x 7/8"	9/32" x 19/32"	5/16"	3/4"	472
12993	1	Black	1/2"		9/32"	11/16"	418
13179	11	Black	17mm	14mm	11mm	14mm	470
13198	1	Black	16mm		9mm	18mm	421
13453	11	White	15/16"	29/32"	5/16"	11/16"	471
13454	1	Black	21/32"		7/32"	15/32"	421
13461	11	White	15/16"	29/32"	5/16"	1-1/8"	471
13467	1	Black	1"		7/16"	1-7/16"	435

RETAINER SPECIFICATION CHART

Recommended Hole Size: .030" - .060" smaller than stem diameter

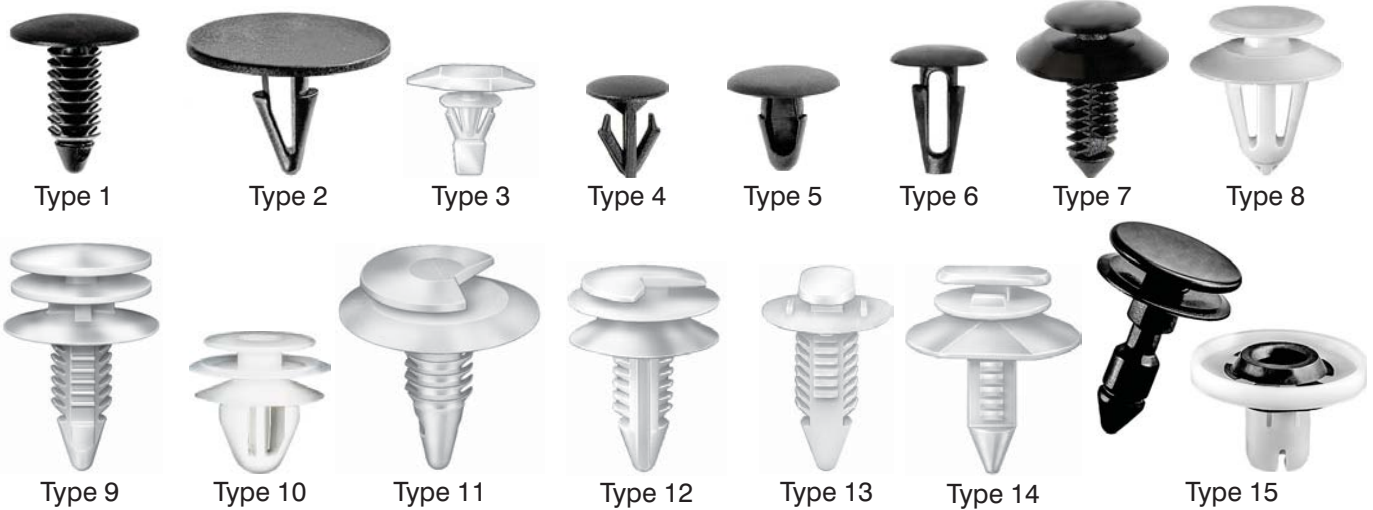

Auveco Part No.	Type	Color	Bottom Head Diameter	Top Head Diameter	Stem Diameter	Stem Length	Page No.
13470	7	White	3/4"	1/2"	5/16"	5/8"	455
13475	11	White	19mm	15mm	9mm	18mm	471
13757	Misc.	Black	2" Square		1/4"	9/16"	435
13945	11	White	19mm	15mm	9mm	18mm	471
13946	14	Yellow	3/4" x 7/8"	9/32" x 19/32"	5/16"	3/4"	472
13992	12	White	23/32"	23/32"	5/16"	5/8"	472
14006	1	Black	3/8"		9/32"	1/2"	417
14017	1	Black	1/2"		9/32"	5/8"	418
14021	1	Black	7/16"		7/32"	1/2"	416
14032	1	Black	3/4"		5/16"	1-1/4"	424
14035	1	Natural	19/32"		5/16"	2"	424
14036	1	Black	3/4"		5/16"	1-3/8"	424
14144	10	Black	18mm	13mm	9.5mm	14mm	465
14163	2	Black	1-3/4"		3/8"	3/4"	434
14269	10	White	18mm	13mm	9.5mm	14mm	464
14270	10	Blue/Natural	18mm	13mm	9.5mm	14mm	465
14282	6	Black	13mm		7.5mm	15mm	443
14289	1	Black	13mm		5mm	16mm	418
14291	5	Black	11mm		5.5mm	13mm	442
14299	3	White	7mm x 16mm		6.5mm	5mm	436
14319	4	Black	20mm		18mm	20mm	448
14323	4	Black	18mm		10mm	15mm	447
14328	3	White	7mm x 16mm		6mm	10mm	436
14347	4	Black	18mm		9mm	12mm	447
14348	6	Black	16mm		6.5mm	15mm	444
14349	5	Black	11mm		7mm	15mm	442
14352	6	Black	13mm		6mm	13mm	443
14353	4	Black	14mm		10mm	16mm	447
14355	6	Black	11mm		6mm	13mm	442
14356	4	Black	20mm		11mm	16mm	448
14363	11	White	17mm	15mm	10mm	14mm	470
14367	1	Black	12mm		5mm	12mm	415
14380	4	Black	18mm		12mm	18mm	448
14524	12	White	3/4"	21/32"	5/16"	3/4"	472
14709	1	Black	20mm		5.5mm	9mm	420
14720	4	Black	18mm		12.5mm	15mm	448
14723	4	Black	14mm		9mm	11mm	447
14728	10	Natural/Yellow	16mm	12.5mm	8.5mm	11mm	464
14736	5	Black	14mm		6mm	10mm	444
14737	6	Black	13mm		7mm	15mm	443
14738	6	Black	30mm		8mm	17mm	446
14757	1	Black	1/2"		1/4"	15/16"	422
14758	13	White	7/8" x 7/8"	3/8" x 7/8"	5/16"	19/32"	473
14857	1	Black	1/2"		9/32"	5/8"	418
14921	1	Black	10mm		6mm	12mm	416
14985	3	White	3/16" x 9/16"		1/8" x 3/8"	5/16"	436
15040	1	Black	3/4"		7/32"	11/16"	423
15050	1	Black	15mm		5.5mm	19mm	420

Sec. 19

RETAINER SPECIFICATION CHART

Recommended Hole Size: .030" - .060" smaller than stem diameter

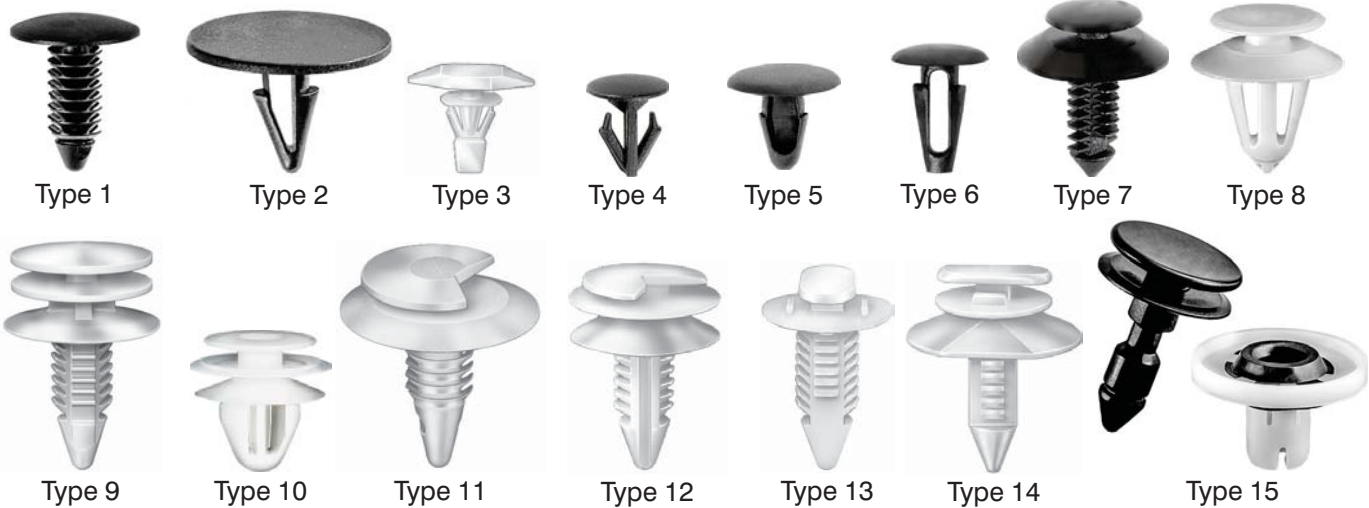

Auveco Part No.	Type	Color	Bottom Head Diameter	Top Head Diameter	Stem Diameter	Stem Length	Page No.
15367	1	Black	19/32"		7/32"	3/4"	420
15414	1	Black	11/16"		5/16"	13/16"	425
15456	1	Black	1-21/32"		5/16"	3/4"	433
15457	1	Black	1-3/8"		5/16"	15/16"	433
15461	11	White	3/4"	5/8"	5/16"	1"	471
15478	1	Black	22mm		11mm	28mm	430
15479	1	Black	26mm		8mm	38mm	431
15480	1	Black	25mm		8mm	20mm	429
15481	1	Black	25mm		7.5mm	20mm	428
15523	1	Black	1"		1/4" x 5/16"	1-1/8"	428
15543	1	Black	7/8"		5/16"	1-3/32"	426
15664	1	White	11/16"		5/16"	5/8"	425
15668	1	Black	1-3/4"		9/32"	1"	434
15669	11	White	15/16"	29/32"	5/16"	1-1/4"	471
15670	14	White	1/2"	1/4" x 29/64"	5/16"	3/4"	472
15707	10	Gray	17.5mm	13mm	10mm	14mm	465
15709	7	Natural	17.5mm	13mm	9.5mm	13mm	464
15970	14	White	9/16" x 11/16"	9/32" x 1/2"	5/16"	3/4"	472
15998	1	Black	30mm		6.5mm	9mm	432
16017	11	White	3/4"	5/8"	5/16"	1"	471
16132	1	Black	19mm		9mm	20mm	426
16259	1	Black	11/16"		5/16"	5/8"	425
16260	12	White	3/4"	11/16"	5/16"	1/2"	471
16261	12	White	7/8"	29/32"	5/16"	3/4"	472
16262	1	Black	7/8"		7/16"	13/16"	430
16263	1	Black	1"		7/16"	13/16"	430
16695	9	White	20mm	18mm	8mm	23mm	458
16775	1	Black	20mm		4.5mm	15mm	426
16776	1	Black	18mm		7.5mm	20mm	422
16777	4	Black	15mm		12mm	15mm	447
16778	11	Natural	18.5mm	14mm	11.5mm	14mm	470
16779	4	Black	18mm		11mm	15mm	448
16781	6	Black	15mm		8.5mm	20mm	444
16818	1	Black	3/4"		11/32"	7/8"	423
16863	1	Black	1-3/4"		5/16"	29/32"	434
16938	9	Black	8mm	14mm	8mm	15mm	457
17004	2	Black	1-5/16"		3/8"	3/4"	435
17072	Misc.	Black	1-1/2"		1-1/4"	5/16"	436
17075	9	White	3/4"	33/64"	5/16"	13/16"	457
17076	1	Black	18mm		7mm	23mm	427
17092	14	Yellow	13/16" x 29/32"	5/8"	5/16"	3/4"	472
17102	7	White	3/4"	1/2"	5/16"	1"	455
17124	7	Black	3/4"	1/2"	11/32"	3/4"	455
17205	4	Black	14mm		8mm	15mm	447
17215	1	Black	40mm		8mm	13mm	434
17218	7	Natural	20mm	13mm	8mm	18mm	455
17237	Misc.	Black	29.5mm		7mm	9mm	435
17339	3	Black	5mm x 15mm		4mm	12mm	440

RETAINER SPECIFICATION CHART

Recommended Hole Size: .030" - .060" smaller than stem diameter

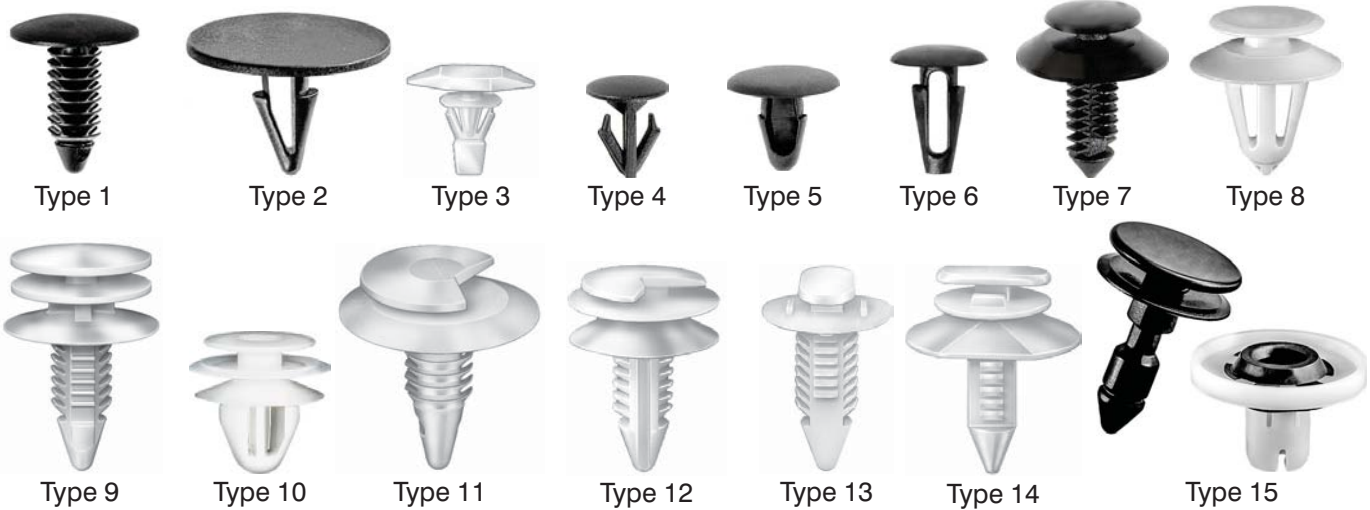

Auveco Part No.	Type	Color	Bottom Head Diameter	Top Head Diameter	Stem Diameter	Stem Length	Page No.
17381	1	Gray	32mm		8mm	20mm	433
17452	5	Black	13mm		5mm	15mm	443
17453	1	Gray	15mm		6.5mm	14mm	419
17599	Misc.	Black	3/4"		9/32" x 11/32"	11/16"	474
17612	1	Black	5/8"		3/8"	3/4"	426
17634	1	Black	12mm		6mm	16mm	417
17649	13	White	1/2" x 5/8"	9/32" x 1/2"	5/16"	7/8"	472
17664	1	Black	11/16"		5/16"	1-1/16"	425
17669	10	Yellow	23/32"	1/2"	5/16"	9/16"	467
17685	10	Yellow	18mm	13mm	8mm	25mm	469
17975	2	Black	1-3/16"		5/16"	1/2"	434
17990	6	Black	14mm x 15mm		7mm	19mm	444
17991	3	Black	8mm x 17mm		8mm	14mm	441
18033	3	White	1/4" x 21/32"		1/4"	15/32"	440
18114	4	Black	10mm		7.5mm	10mm	446
18157	6	Gray	13mm		5mm	16mm	444
18166	Misc.	Black	10mm		4mm	10mm	441
18174	1	Black	3/4"		5/16"	13/16"	423
18175	7	Natural	15/16"	1/2"	5/16"	15/16"	456
18248	2	Black	7/16"		11/64"	3/8"	442
18271	5	Black	14mm		6mm	15mm	444
18277	1	Gray	1"		5/16"	1-1/2"	432
18294	10	White	18mm	13mm	10.5mm	14mm	467
18297	6	Black	13mm		7.5mm	11mm	443
18298	1	Black	1/2"		5/16"	11/16"	417
18301	1	Black	3/4"		11/32"	1-3/16"	423
18302	1	Black	7/16"		7/32"	15/32"	416
18330	3	White	3/16" x 37/64"		11/64"	9/16"	441
18371	1	Gray	3/4"		5/16"	1-1/4"	424
18379	1	Black	23/32"		5/16"	7/8"	423
18389	1	Black	1/2"		9/32"	7/16"	416
18391	7	Natural	3/4"	1/2"	5/16"	1-5/32"	456
18458	4	Black	14mm		6mm	10mm	446
18508	3	Black	3/16" x 19/32"		15/32"	5/16"	441
18509	3	Natural	9/32" x 35/64"		9/32"	1/2"	437
18510	3	Natural	3/16" x 1/2"		13/64"	13/32"	436
18679	1	Gray	1"		7/16"	13/16"	430
18680	1	Black	1-1/32"		9/32"	1-3/32"	430
18682	1	Black	1/2"		1/4"	3/4"	419
18683	1	Black	23/64"		3/16"	7/16"	415
18684	1	Black	3/8"		5/32"	3/8"	415
18685	1	Black	31/32"		9/32"	3/4"	427
18688	1	Gray	1-1/32"		9/32"	1-3/32"	431
18692	3	Natural	5mm x 15mm		5mm Hole	10mm	439
18746	Misc.	Black	30mm		15mm x 18mm	10mm	435
18770	1	Black	3/8"		7/32"	5/8"	416
18771	1	Black	1"		19/64"	1-1/16"	430

Sec. 19

RETAINER SPECIFICATION CHART

Recommended Hole Size: .030" - .060" smaller than stem diameter

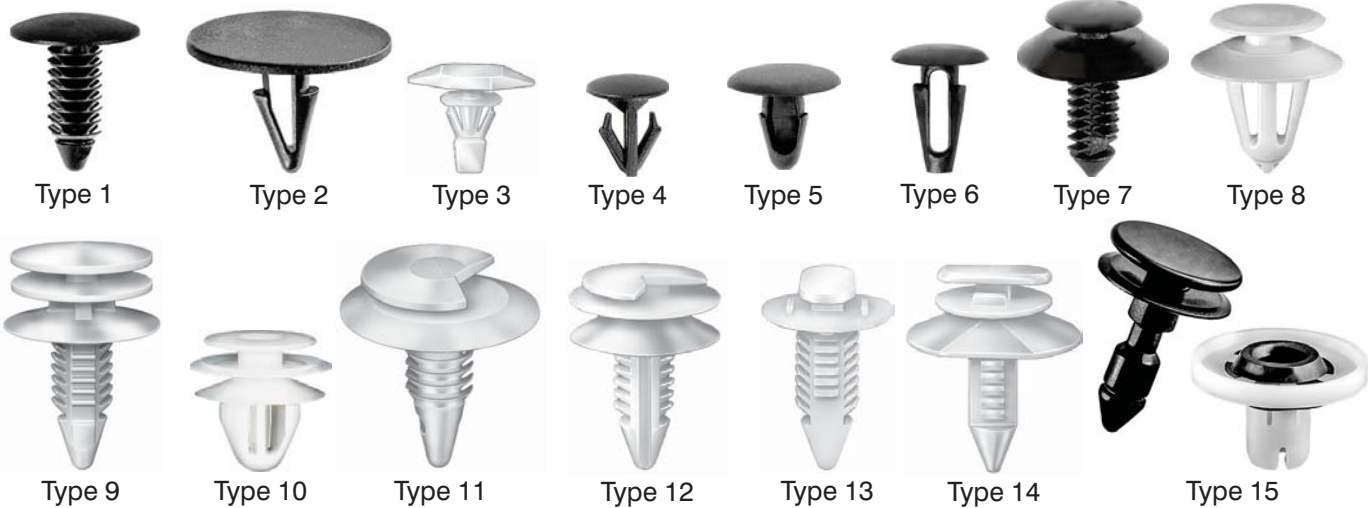

Auveco Part No.	Type	Color	Bottom Head Diameter	Top Head Diameter	Stem Diameter	Stem Length	Page No.
18815	1	Black	9/16"		5/16"	3/4"	419
18818	6	Natural	7mm x 16mm		5mm	12mm	441
18820	1	Black	3/4"		7/32"	1/2"	421
18824	10	White	15mm	13mm	9mm	9.5mm	458
18827	2	Black	25/32"		5/16"	7/16"	434
18842	6	Black	30mm		8.5mm	17mm	446
18844	10	White	18mm	13mm	10mm	13mm	463
18848	7	Yellow	3/4"	1/2"	3/8"	11/16"	455
18859	1	Black	19/32"		5/16"	1-3/8"	423
18861	8	White	18mm	13mm	8.5mm x 8.5mm	12mm	450
18862	10	Green	23/32"	19/32"	5/16"	5/8"	468
18874	10	Gray	18mm	13mm	9.5mm	15mm	466
18875	8	White	19mm	13mm	11mm	15mm	452
18876	10	White	18mm	13mm	9mm x 9mm	14mm	465
18877	3	Orange	5mm x 15mm		6mm	10mm	440
18878	6	Black	30mm		6mm	16mm	446
18897	1	Black	13/32"		13/64"	7/8"	417
18915	10	White	23/32"	1/2"	5/16"	9/16"	467
18930	10	Yellow	18mm	13mm	9mm	18mm	469
18936	14	White	19/32"	39/64" x 7/16"	5/16"	1/2"	473
18948	1	Black	7/16"		7/32"	11/16"	417
18950	10	Black/White	18mm	13mm	10mm	13mm	463
19014	Misc.	Natural	11mm x 12mm		9.5mm	16mm	442
19016	10	Dark Gray	18mm	13mm	9.5mm	15mm	466
19108	10	Natural	18mm	13mm	9.5mm	14mm	466
19109	10	Natural	15mm	13mm	9.5mm	11mm	460
19112	6	Black	30mm		8mm	16mm	446
19113	6	Black	25mm		8mm	12mm	445
19114	4	Black	12mm		8.5mm	9mm	446
19116	3	Natural	5mm x 15mm		6mm	10mm	440
19121	1	Gray	20mm		8mm	20mm	426
19123	Misc.	Black	17mm		7mm	12mm	444
19124	4	Black	16mm		10mm	10mm	447
19127	1	Black	1"		1/4"	25/32"	427
19129	10	Yellow	18mm	13mm	9.5mm	17mm	468
19145	10	Gray	17mm	13mm	9mm	12mm	461
19149	1	Black	3/8"		7/32"	5/8"	417
19155	2	Black	1-9/32"		3/8"	3/4"	435
19171	3	Green	5mm x 15mm		5mm Hole	10mm	439
19197	1	Gray	25mm		8mm	20mm	429
19203	10	Natural	18mm	13mm	11mm	11mm	461
19210	10	Natural	18mm	13mm	10mm	14mm	467
19213	7	Natural	3/4"	1/2"	11/32"	3/4"	455
19250	1	White	11/16"		5/16"	13/16"	425
19257	9	Maroon	18mm	13mm	9.5mm	14mm	466
19270	9	White	20mm	18mm	8mm	24mm	457
19275	9	White	20mm	18mm	8mm	13mm	457
19312	1	Black	16mm		5mm	13mm	419

RETAINER SPECIFICATION CHART

Recommended Hole Size: .030" - .060" smaller than stem diameter

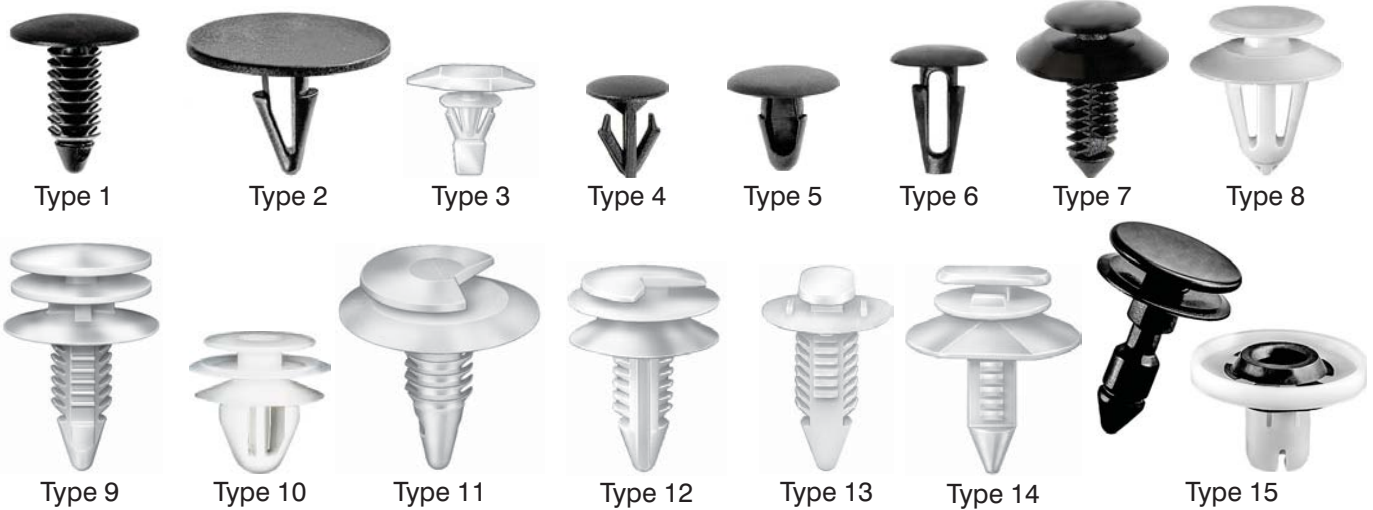

Auveco Part No.	Type	Color	Bottom Head Diameter	Top Head Diameter	Stem Diameter	Stem Length	Page No.
19320	8	White	16mm	12mm	9mm	11mm	449
19323	6	Black	26mm		10mm	8mm	445
19325	3	Brown	5mm x 13mm		7mm	6mm	438
19331	6	Black	14mm		7mm	11mm	444
19334	8	Natural	16mm	12mm	9mm	15mm	453
19338	1	Black	1-1/4"		5/16"	11/16"	433
19352	1	Gray	3/4"		5/16"	1-7/16"	425
19354	1	Tan	3/4"		5/16"	1-7/16"	425
19356	9	White	20mm	18mm	8mm	20mm	457
19368	3	Natural	5mm x 15mm		5mm Hole	9mm	438
19371	1	Blue	19/32"		9/32"	27/32"	426
19373	1	Light Gray	19/32"		9/32"	27/32"	426
19374	1	Tan	19/32"		9/32"	27/32"	426
19385	6	Gray	26mm		10mm	8mm	445
19386	10	Natural	20mm	15mm	9mm	15mm	466
19418	1	Black	13/32" x 1"		9/32"	9/16"	437
19425	3	Natural	9/32" x 1/2"		7/32"	21/32"	437
19428	Misc.	White	20mm	18mm	8mm	19mm	469
19449	1	Black	13/64" x 7/8"		7/32"	5/8"	437
19464	7	Natural	16mm	13mm	7mm	13mm	452
19466	10	White	17mm	13mm	9.5mm	12mm	460
19467	6	Black	13mm		6mm	10mm	443
19468	1	Black	28mm		6mm	10mm	432
19470	1	Black	16mm		4mm	21mm	422
19481	3	Blue	5mm x 15mm		6mm Hole	8mm	438
19483	3	Black	8mm x 18mm		7mm	15mm	441
19501	1	Tan	1-1/32"		9/32"	1-1/32"	431
19506	1	Black	16mm		5mm	16mm	420
19524	Misc.	Green	15mm		8mm	13mm	474
19527	10	Yellow	20mm	18mm	8mm	13mm	457
19541	1	Black	1"		9/32"	5/8"	428
19628	10	White	18mm	15mm	8.5mm	14mm	467
19643	1	Black	16mm		6mm	16mm	421
19655	2	Black	1-3/16"		3/8"	3/4"	434
19667	1	Black	3/4"		7/32"	11/16"	421
19673	1	Black	10mm x 15mm		5mm	10mm	417
19678	3	White	5mm x 15mm		6mm	10mm	437
19682	4	Black	11mm		7mm	8mm	446
19683	3	Black	6mm x 16mm		7mm	14mm	441
19684	3	Blue	7mm x 16mm		6mm Hole	12mm	440
19686	1	Black	12mm		5mm Sq.	6mm	415
19719	8	White	18mm	13mm	10mm	11mm	450
19720	3	Black/White	8mm x 17mm		7mm Hole	16mm	441
19724	3	White	6mm x 16mm			15mm	441
19728	3	Black	8mm x 17mm		7mm Hole	14mm	441
19729	4	Black	25mm		9mm	10mm	445
19731	10	White	17mm	13mm	9.5mm	13mm	461
19744	1	Black	16mm		6mm	27mm	422

Sec. 19

RETAINER SPECIFICATION CHART

Recommended Hole Size: .030" - .060" smaller than stem diameter

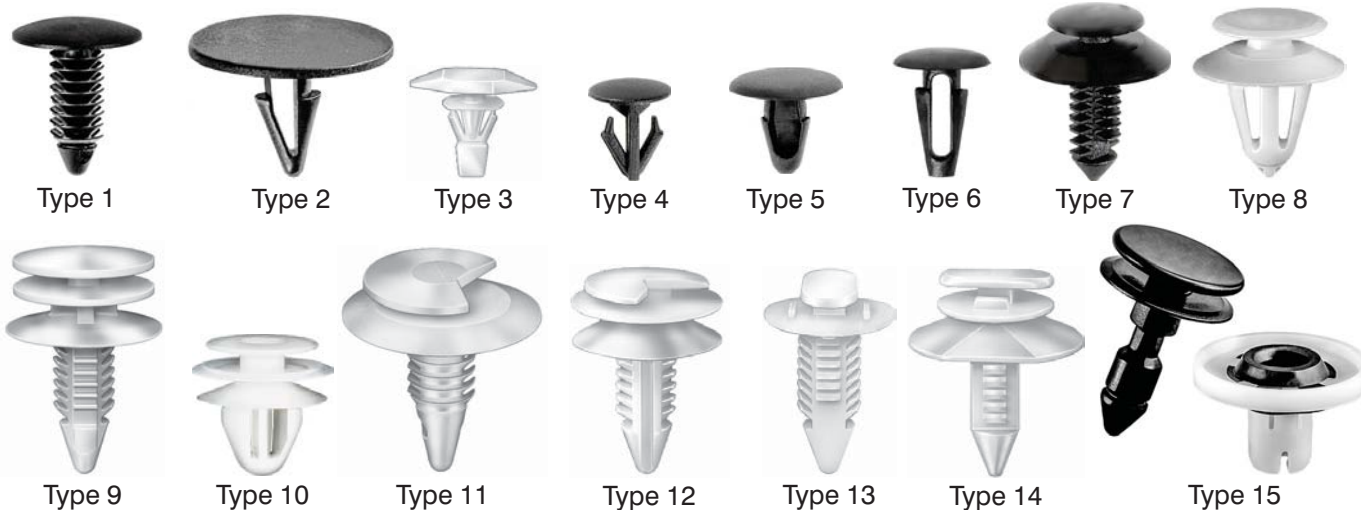

Auveco Part No.	Type	Color	Bottom Head Diameter	Top Head Diameter	Stem Diameter	Stem Length	Page No.
19746	Misc.	White	10.5mm		3.5mm, 5mm	15mm	415
19749	3	White	5mm x 15mm		6mm Hole	10mm	439
19758	Misc.	Green	19mm	19mm	8mm	20mm	470
19760	1	Black	25mm		8mm	24mm	428
19774	1	Black	13/32"		5/16"	1-5/16"	469
19775	Misc.	White	18mm	13mm	8mm	18mm	469
19790	1	Gray	11/16"		5/16"	13/16"	425
19802	10	White	16mm	12mm	8mm	24mm	455
19804	Misc.	White	22mm	16mm	9mm	15mm	470
19810	7	Black	13mm	12mm	8mm	19mm	455
19834	1	Black	3/4"		5/16"	1-1/16"	427
19836	1	Black	7/16"		7/32"	11/16"	418
19837	1	Black	3/4"		11/32"	13/16"	427
19842	Misc.	Black	18mm		11mm	22mm	423
19845	1	Med. Graphite	1"		5/16"	1-3/4"	432
19846	1	Black	1"		5/16"	1-3/4"	432
19850	3	Natural	5mm x 15mm		5mm	8mm	438
19855	1	Black	23/32"		15/64" x 9/32"	3/4"	425
19893	1	Black	5/8"		1/4"	3/4"	422
19898	10	Yellow	18mm	13mm	9.5mm	13mm	465
19910	10	Yellow	18mm	13mm	9mm x 9mm	14mm	465
20164	2	Black	30mm		8mm	12mm	434
20165	1	Black	10mm		6mm	12mm	416
20177	1	Gray	11/16"		5/16"	1-3/8"	423
20180	3	Black	6.5mm x 11mm		5.5mm	12mm	437
20181	3	White	6.5mm x 16mm		6mm	8mm	438
20182	3	White	6.5mm x 16mm		6mm	6mm	436
20184	1	Black	16mm		8mm	16mm	421
20188	11	White	18mm	13mm	8.5mm	11mm	470
20189	1	Black	1"		5/16"	5/8"	427
20190	Misc.	Carmel/White	20mm	13mm	8.5mm	16mm	468
20192	1	Black	11/16"		5/16"	1-3/4"	424
20252	11	Black	18mm	14mm	9mm	14mm	470
20253	12	White	18mm	14mm	9mm	15mm	471
20256	1	Black	15mm		4.5mm	14mm	419
20262	1	Black	1"		7/16"	9/16"	430
20274	7	White	23mm	13mm	6.5mm	20mm	455
20279	Misc.	White	13/16" x 1-7/16"	5/16" x 3/4"	5/16"	7/8"	472
20281	1	Black	21mm		13mm	27mm	429
20311	1	Black	14mm		7mm	9mm	417
20316	1	Black	1"		5/16"	13/16"	430
20319	1	Black	25mm		9mm	12mm	427
20334	1	Black	18mm		7.5mm	20mm	422
20338	9	White	25/32"	11/16"	5/16"	1-1/4"	458
20341	Misc.	Black	22mm		10.5mm	10mm	473
20344	1	Black	7/16"		7/32"	5/16"	416

RETAINER SPECIFICATION CHART

Recommended Hole Size: .030" - .060" smaller than stem diameter

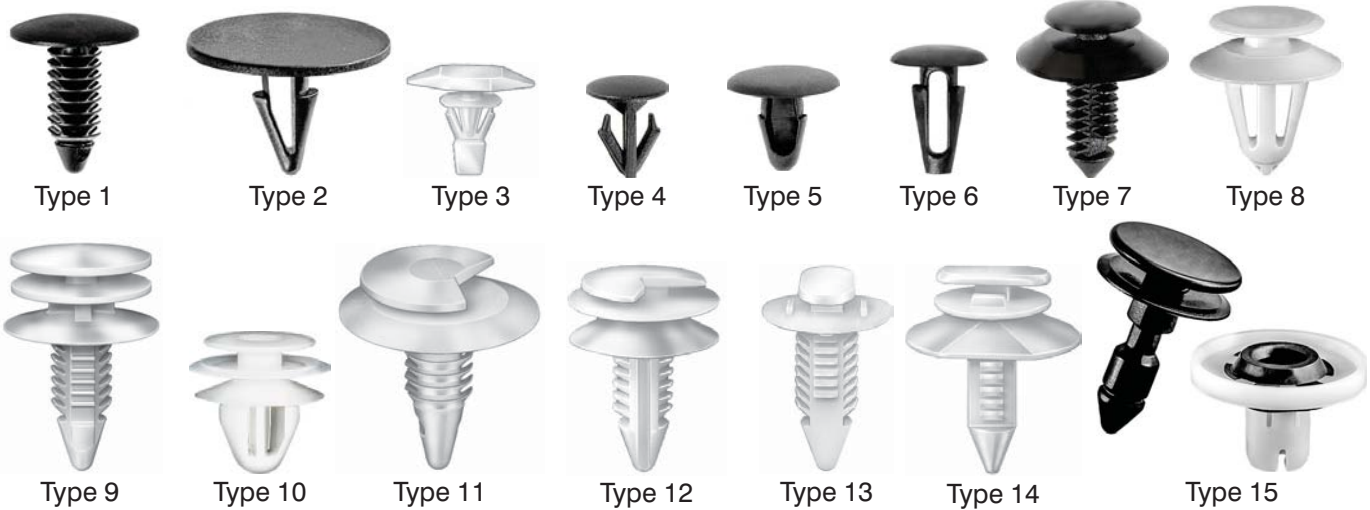

Auveco Part No.	Type	Color	Bottom Head Diameter	Top Head Diameter	Stem Diameter	Stem Length	Page No.
20345	1	Gray	1"		1/4" x 5/16"	1-1/8"	431
20360	1	Black	15/16"		3/8"	3/4"	427
20362	1	Black	25mm		13mm	15mm	430
20366	1	Black	22mm		7.5mm	35mm	424
20381	6	Black	16mm		7mm	16mm	444
20399	1	Black	3/4"		7/32"	15/32"	421
20411	10	Black	14.5mm	13mm	9.5mm	12mm	461
20427	10	Gray/White	20mm	15mm	9mm	18mm	469
20428	10	Green/White	20mm	15mm	9mm	18mm	468
20437	10	White	18mm	13mm	8.5mm x 8.5mm	15mm	463
20443	3	Black	5mm x 15mm		7mm	10mm	439
20444	10	White	19mm	20mm	11mm	17mm	468
20473	8	White	18mm	13mm	11mm	14mm	452
20515	10	Yellow/White	20mm	15mm	9mm	14mm	466
20528	1	Black	9mm		6mm	14mm	416
20531	1	Black	21mm		7.5mm	25mm	423
20541	1	Tan	35mm		7.5mm	20mm	433
20543	4	Black	26mm		12mm	14mm	448
20558	10	White	15mm	13mm	8.5mm x 9.5mm	11mm	459
20559	10	Blue	18mm	13mm	9mm x 9mm	11mm	459
20563	10	White	22mm	16mm	9mm	15mm	469
20571	8	White	18mm	13mm	9mm	9mm	449
20575	10	Yellow/White	18mm	13mm	10mm	13mm	463
20576	8	Yellow	14mm x 18mm	10mm x 13mm	8.5mm x 8.5mm	9mm	449
20609	1	Black	30mm		15mm x 20mm	14mm	435
20610	10	White	16mm	13mm	9mm	15mm	466
20611	8	Blue	16mm	12mm	3mm	7mm	449
20615	1	Black	35mm		8mm	20mm	433
20616	10	White	18.5mm	19.5mm	11mm	17mm	468
20624	1	Black	18mm		7.5mm	33mm	423
20625	1	Tan	25mm		8mm	29mm	431
20633	10	Turquoise	18mm	13mm	8.5mm x 9mm	14mm	464
20634	7	White	16mm	13mm	7mm	26mm	456
20642	8	Gray	16mm	13mm	9mm	13mm	449
20668	10	White	18mm	13mm	9mm	14mm	463
20669	10	Black	18mm	13mm	9mm	15mm	465
20670	10	Gray	18mm	13mm	8.5mm	12mm	459
20671	5	Black	20mm		9.5mm	15mm	445
20672	7	White	16mm	13mm	4mm	13mm	452
20735	11	Black	18mm	11.5mm	9mm	14mm	470
20760	3	Natural	5mm x 15mm		8mm	7mm	438
20761	1	Black	18mm		8.5mm	32mm	424
20765	10	Yellow	18mm	15mm	10mm	15mm	468
20770	4	Yellow	10mm		9mm	14.5mm	446
20814	9	White	25/32"	11/16"	5/16"	13/16"	458
20829	7	Black	18mm	14mm	8mm	15mm	454
20831	3	Blue	5mm x 14mm		6.5mm	10mm	439
20866	Misc.	White	1/2"		11/32"	7/16" & 7/8"	474

Sec. 19

RETAINER SPECIFICATION CHART

Recommended Hole Size: .030" - .060" smaller than stem diameter

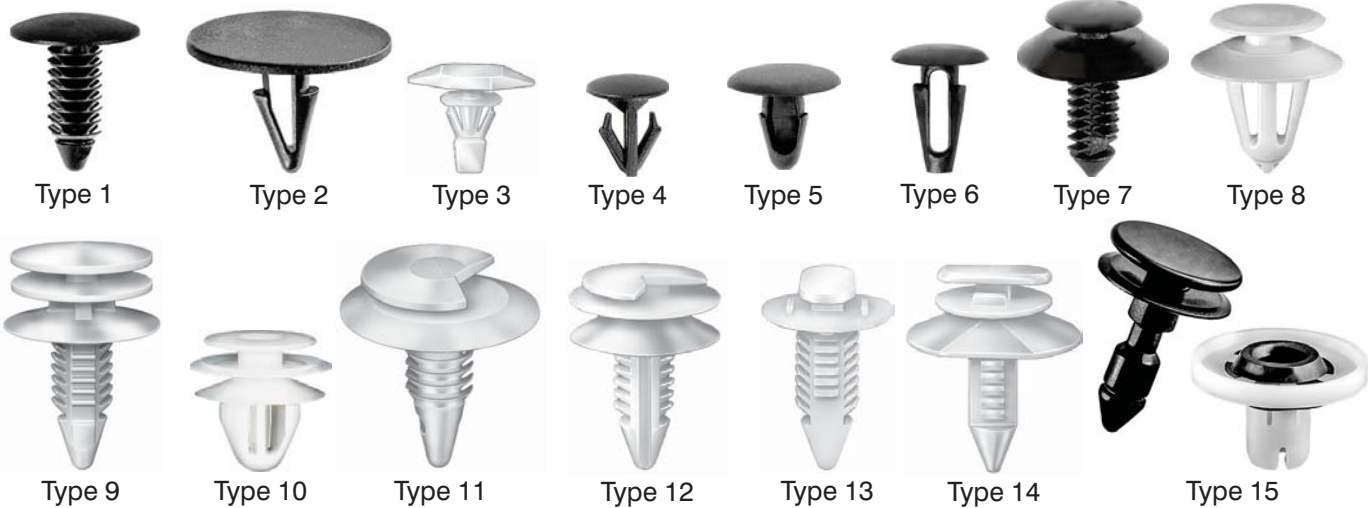

Auveco Part No.	Type	Color	Bottom Head Diameter	Top Head Diameter	Stem Diameter	Stem Length	Page No.	
20874	1	Black	25mm		7mm	23mm	431	
20878	1	Black	19mm		7.5mm	16mm	426	
20879	10	Green	17mm	13mm	9mm	14mm	463	
20881	8	White	16mm	13mm	8mm	13mm	450	
20882	6	Black	20mm		7mm	15mm	445	
20893	1	Black	12.5mm		7.5mm	15mm	417	
20926	1	Black	18mm		7.5mm	44mm	424	
20932	8	White	18mm	14mm	12mm	14mm	452	
20944	7	Green	25mm	18mm	8mm	24mm	456	
20949	10	Black & Blue	16mm	13mm	8mm	12mm	468	
20959	10	Blue	15mm	13mm	9.5mm	13mm	462	
20983	10	White	18mm	13mm	9mm	13mm	460	
20995	15	White	19.5mm	19mm		22mm	456	
			Grommet Flange: 24mm; Grommet Stem Length: 12mm; Fits into 9mm Hole					
20996	15	Yellow	19.5mm	19mm		22mm	456	
			Grommet Flange: 24mm; Grommet Stem Length: 12mm; Fits into 9mm Hole					
20998	15	Black & White	19.5mm	19mm		22mm	457	
			Grommet Flange: 24mm; Grommet Stem Length: 12mm; Fits into 9mm Hole					
20999	15	Green & Yellow	19.5mm	19mm		22mm	457	
			Grommet Flange: 24mm; Grommet Stem Length: 12mm; Fits into 9mm Hole					
21012	8	Black	18mm		9.5mm	14mm	452	
21023	Misc.	Black	9/16"		19/64"	13/32"	474	
21026	1	Black	20mm		8.5mm	20mm	426	
21059	10	Blue	18mm	12mm x 13mm	8.5mm x 8.5mm	14mm	467	
21070	10	White	16mm	13mm	9.5mm	10mm	460	
21087	10	Orange	18mm	12mm	9.7mm	14mm	465	
21088	8	White	17mm	13mm	9.5mm	14mm	452	
21090	1	Black	1"		11/32"	3/4"	428	
21091	8	Black	25mm	13mm	10.5mm	14mm	455	
21102	10	White	18mm	13mm	8.5mm	14mm	463	
21105	4	Black	20mm		14mm	10mm	448	
21107	7	White	16mm	13mm	4mm	13mm	451	
21118	10	White	18mm	13mm	10mm	14mm	465	
21125	1	Black	20mm x 36mm		17mm	25mm	437	
21131	10	Black	18mm	12mm	9.5mm	13mm	468	
21137	10	Black	15mm	13mm	10mm	8mm	458	
21138	10	White	18mm	14mm	9mm	14mm	464	
21139	10	White	18mm	12mm	9.5mm	11mm	460	
21143	1	Black	8.5mm x 14mm		5mm x 7.5mm	14mm	437	
21144	Misc.	Black	27mm	21.5mm	11mm	19mm	473	
21149	10	White	15mm	13mm	9.5mm	11mm	459	
21169	10	White	22mm	16mm	11mm	17mm	469	
21188	10	Pink	18mm	15mm	10mm	12mm	459	
21189	10	Black	19mm	20mm	11mm	16mm	469	
21199	1	Black	18mm		7.5mm	20mm	420	
21206	10	Orange	18mm	13mm	8.5mm	14mm	463	
21208	10	Gray	18mm	13mm	9mm	12mm	461	
21211	4	Black	24mm		9mm	12mm	434	

RETAINER SPECIFICATION CHART

Recommended Hole Size: .030" - .060" smaller than stem diameter

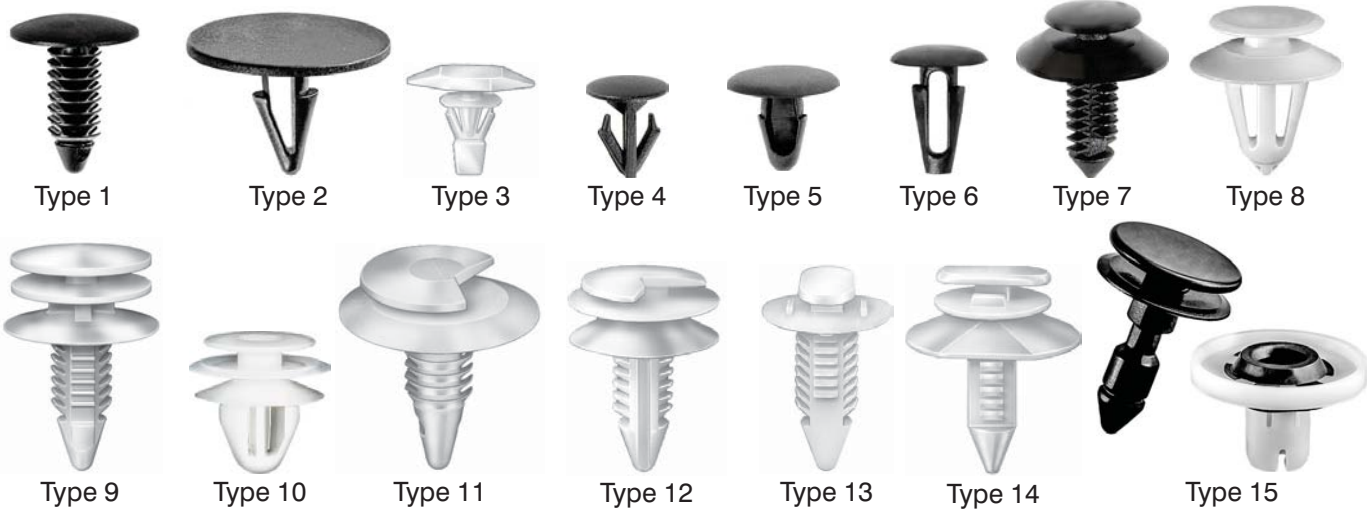

Auveco Part No.	Type	Color	Bottom Head Diameter	Top Head Diameter	Stem Diameter	Stem Length	Page No.
21226	8	Black	18mm	13mm	9mm	10mm	452
21227	1	Tan	45mm		9.5mm	20mm	434
21228	1	Tan	25mm		8.5mm	37mm	432
21229	6	Black	6.4mm x 16mm		3.5mm x 6mm	10mm	439
21240	10	Green	18mm	14mm	9mm	10mm	460
21241	1	Black	26mm		7.5mm	28mm	431
21247	10	Green	18mm	15mm	12mm	14mm	466
21248	1	Tan	25mm		7.5mm	22mm	428
21250	10	Black	16mm	13mm	11mm	14mm	468
21253	1	Gray	20mm		6mm	15mm	422
21254	1	Black	20mm		8mm	8mm	448
21257	1	Black	23mm		8mm	20mm	426
21287	1	Opal Gray	25mm		8mm	58mm	432
21288	1	Black	28mm		6mm	10mm	432
21289	10	Yellow	18mm	12.5mm	9.5mm	14mm	464
21295	6	Black	10mm		6mm	8mm	442
21296	6	Black	13mm		7mm	10mm	443
21301	1	Black	25mm		5.8mm	25.5mm	428
21303	1	Black	18mm		7mm x 7mm	13mm	419
21307	4	Black	9mm		5.5mm	7mm	446
21313	1	Black	31mm		7.6mm	13mm	433
21329	10	Black	18mm	15mm	9mm	13mm	464
21332	1	Tan	20mm		6mm	15mm	422
21333	10	Blue	18mm	13mm	10mm	14mm	467
21334	3	White	5mm x 15mm		8mm	8mm	438
21338	1	Black	25.4mm		8mm	27mm	428
21346	7	White	12mm x 16mm	15mm	5mm	34mm	456
21349	1	Gray	18mm		8mm	16mm	420
21350	1	Tan	18mm		8mm	16mm	420
21360	10	White	16mm	13mm	10mm	12mm	463
21364	8	Green	17mm	15mm	9mm	14mm	453
21365	8	Blue	17mm	13mm	9mm	13mm	450
21379	10	Black	18.5mm	19.5mm	11mm	16mm	469
21380	1	Black	28mm		8mm	17mm	432
21381	1	Black	5mm x 13mm		8mm	11mm	437
21382	1	Black	6mm x 16mm		8mm	14mm	436
21383	7	White	19mm	19mm	7mm	22mm	456
21385	1	Light Gray	33mm		8mm	41mm	433
21386	1	Tan	33mm		8mm	41mm	433
21392	1	Black	23mm		6.5mm	16mm	426
21393	Misc.	Green & Black	19mm	28mm	9mm	9mm	473
21398	Misc.	Black	18mm	22mm	9mm	11mm	473
21410	10	White	18mm	13mm x 18mm	10.7mm	12mm	459
21412	8	Gray	18.5mm	14mm	12mm	13mm	454
21414	10	White	18mm	13mm	9mm	13mm	463
21415	Misc.	Tan & White	28.5mm		9.5mm	11mm	473
21421	1	Black	30mm		7.7mm	13mm	432
21443	1	Black	30mm		7.8mm	15mm	432

Sec. 19

RETAINER SPECIFICATION CHART

Recommended Hole Size: .030" - .060" smaller than stem diameter

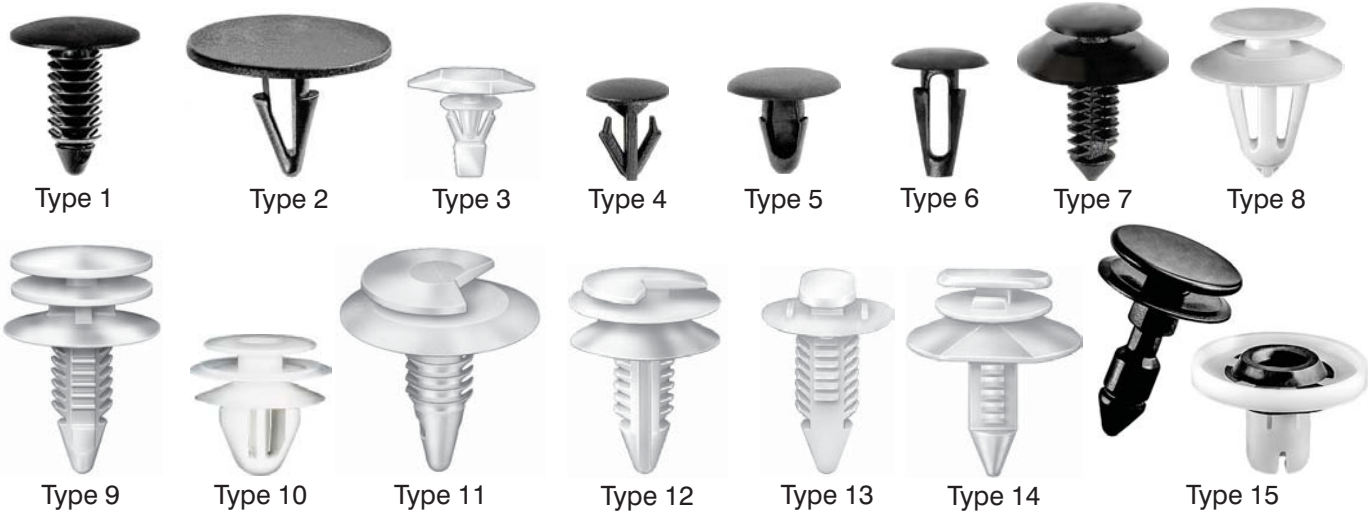

Auveco Part No.	Type	Color	Bottom Head Diameter	Top Head Diameter	Stem Diameter	Stem Length	Page No.	
21450	8	Black	18mm	13.5mm	9mm	14mm	451	
21458	1	Black	10mm		5.5mm	7mm	415	
21488	8	Gray	17mm	13mm	9mm	14mm	450	
21489	8	Yellow	17mm	15mm	9mm	14mm	453	
21494	11	Natural	18mm	12mm	9.5mm	12mm	470	
21495	8	Blue	18mm	13mm	9mm	14mm	451	
21496	8	White	18mm	12mm	10mm	12mm	450	
21497	Misc.	Black	6mm x 15mm		7.5mm	17mm	447	
21502	10	White	15mm	13mm	9.5mm	14mm	465	
21509	Misc.	White	18mm	12mm	10mm	16mm	449	
21516	7	White	18mm	12mm	10mm	20mm	456	
21519	1	Black	12mm		6mm	15mm	417	
21520	4	Black	14mm		6.5mm	10mm	446	
21532	7	White	12mm	13mm	8mm	25mm	456	
21535	15	White	19.5mm	19.5mm		26mm	457	
			Grommet Flange: 24mm; Grommet Stem Length: 12mm; Fits into 9mm Hole					
21536	15	Yellow	19.5mm	19.5mm		26mm	457	
			Grommet Flange: 24mm; Grommet Stem Length: 12mm; Fits into 9mm Hole					
21538	8	Charcoal	18mm	13mm	9.5mm	13mm	452	
21548	1	Black	10mm		6mm	10mm	415	
21551	Misc.	Black	12mm	9mm	7mm	13mm	449	
21552	3	White	9mm	5mm x 15mm	6.5mm	4mm	438	
21554	10	Black	15mm	13mm	9.5mm	11mm	461	
21560	1	Black	20mm		7mm	15mm	422	
21565	3	White	5mm x 14mm		7mm	8.5mm	438	
21567	8	Gray	18mm	11mm x 15mm	9.7mm	12mm	451	
21573	5	Black	9mm		6.5mm	13mm	442	
21574	10	White	15mm	13mm	9.5mm	11mm	460	
21584	10	White	18mm	13mm	9.3mm	10mm	458	
21588	4	Black	8mm		5.3mm	7mm	446	
21589	1	Black	18mm		7.7mm	15mm	419	
21591	8	Black	17mm	11mm x 14mm	9.7mm	12mm	451	
21626	6	Black	12mm		6.5mm	11mm	443	
21627	1	Black	9mm		5.3mm	8mm	415	
21630	1	Black	20mm		6mm	22mm	422	
21633	3	White	6mm x 16mm		6.5mm	12mm	441	
21634	Misc.	Black	16.5mm		9mm	13mm	445	
21638	10	White	15mm	13mm	9.5mm	11mm	460	
21640	10	Black	18mm	13mm	9mm	14mm	465	
21643	6	Black	7mm x 13mm		7.5mm	13mm	444	
21652	Misc.	Black	30mm		15mm x 21mm	14mm	435	
21654	10	White	18mm	13mm	9.5mm	14mm	463	
21661	1	Black	20mm		7mm	10mm	421	
21673	1	Black	20mm		9mm	17mm	422	
21675	10	Green	18mm	13mm	9.5mm	11mm	460	
21676	10	Yellow	18mm	13mm	9.5mm	12mm	462	
21678	8	Black	18.5mm	14mm	12mm	14mm	452	
21679	1	Black	19mm		8mm	26mm	423	

RETAINER SPECIFICATION CHART

Recommended Hole Size: .030" - .060" smaller than stem diameter

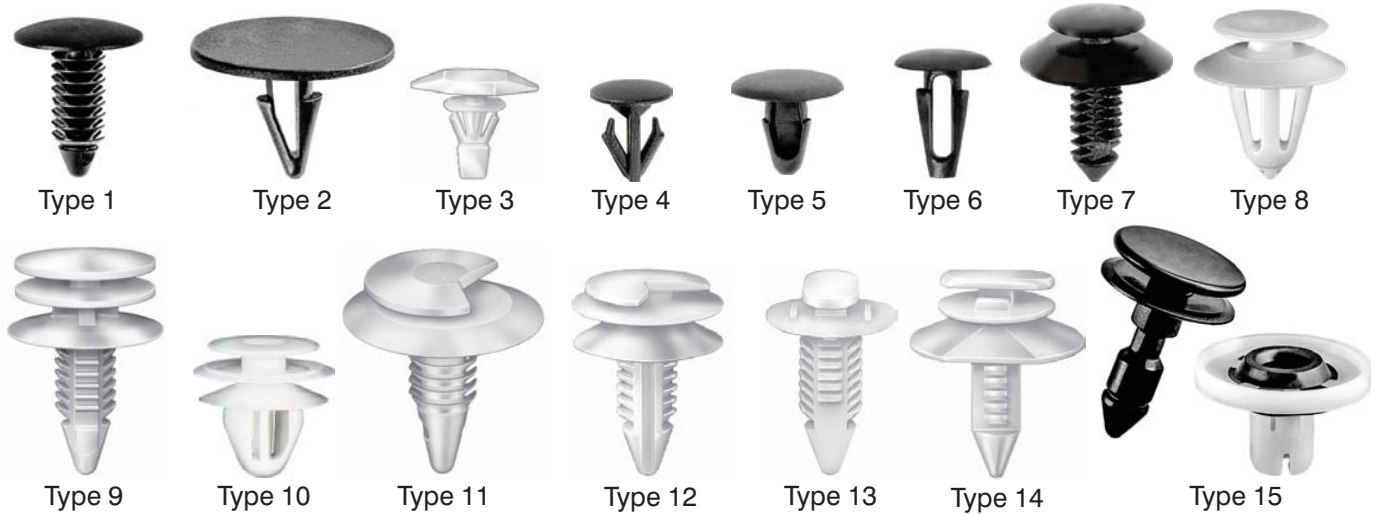

Auveco Part No.	Type	Color	Bottom Head Diameter	Top Head Diameter	Stem Diameter	Stem Length	Page No.
21686	10	Green	18mm	13mm x 16mm	9mm	9mm	459
21690	8	White	16mm	12mm	8mm x 8mm	14mm	453
21691	1	Black	24mm		6mm x 6mm	13mm	428
21692	6	Black	4.5mm x 11mm		6.5mm	9mm	443
21693	1	Black	16mm		4.7mm x 4.7mm	12mm	419
21694	3	Black	8mm	5mm x 14mm	6.3mm	5mm	438
21695	6	Black	4.5mm x 11mm		6.5mm	9mm	443
21696	7	Pale Yellow	16mm	12mm	4mm	6.5mm	449
21701	10	Black	18mm	13mm	10mm	11mm	459
21704	3	Green	9.5mm	5mm x 15mm	7mm	11mm	440
21705	3	Yellow	7.5mm	5mm x 15mm	6.5mm	7mm	440
21706	8	Black	20mm			14mm	486
21707	3	White	6.5mm		7mm	8.5mm	440
21708	Misc.	Black	22.5mm		9mm	12mm	473
21755	1	Black	15mm		6.5mm	14mm	419
21756	1	Clear	11/16"		5/16"	13/16"	425
21757	5	Black	18mm		9mm	15mm	445
21758	4	Black	14mm		7mm x 9mm	18mm	447
21770	1	Black	14mm		6mm	17mm	417
21773	3	Black	8mm	5mm x 11mm	6mm	7mm	440
21776	5	Black	25mm		9.5mm	16mm	435
21777	Misc.	Black	18mm	18mm	5mm x 8mm	18mm	455
21783	Misc.	Black	16mm	16mm	10mm	9mm	450
21785	Misc.	Yellow & Black	17mm	16mm		9mm	458
21786	Misc.	Black & White	17mm	13mm	8mm	9mm	458
21787	8	White	18mm	12mm	9.5mm	16mm	454
21788	10	White	18mm	14mm	9.5mm	14mm	466
21789	1	Black	23mm		11mm	16mm	430
21794	Misc.	White	18mm	15mm		12mm	456
21795	Misc.	White	18mm	13mm			454
21800	1	Black	13mm		7mm	15mm	418
21801	1	White	13mm		7mm	17mm	418
21802	1	Black	15mm		8mm	17mm	418
21803	1	Black	20mm		8mm	23mm	418
21804	1	Gray	20mm		8mm	23mm	418
21805	1	Black	35mm		10mm x 10.5mm	22mm	429
21806	1	Black	35mm		10.5mm	22mm	429
21808	1	White	10mm		8mm	15mm	416
21809	1	Black	21mm		7.5mm	23mm	428
21814	10	White	18mm	13mm	12mm	11mm	461
21819	8	Yellow	17.5mm	13mm	10mm	16mm	454
21822	10	White	18mm	13mm	8.5mm x 9mm	14mm	464
21851	Misc.	White	18.5mm			21mm	474
21853	8	Yellow	17.5mm	13mm	10.5mm	15mm	454
21854	1	Black	20mm		7mm	33mm	474
21855	1	Black	10.7mm		5.8mm	14mm	417
21868	1	Black	20mm		8mm	17mm	427

Sec. 19

RETAINER SPECIFICATION CHART

Recommended Hole Size: .030" - .060" smaller than stem diameter

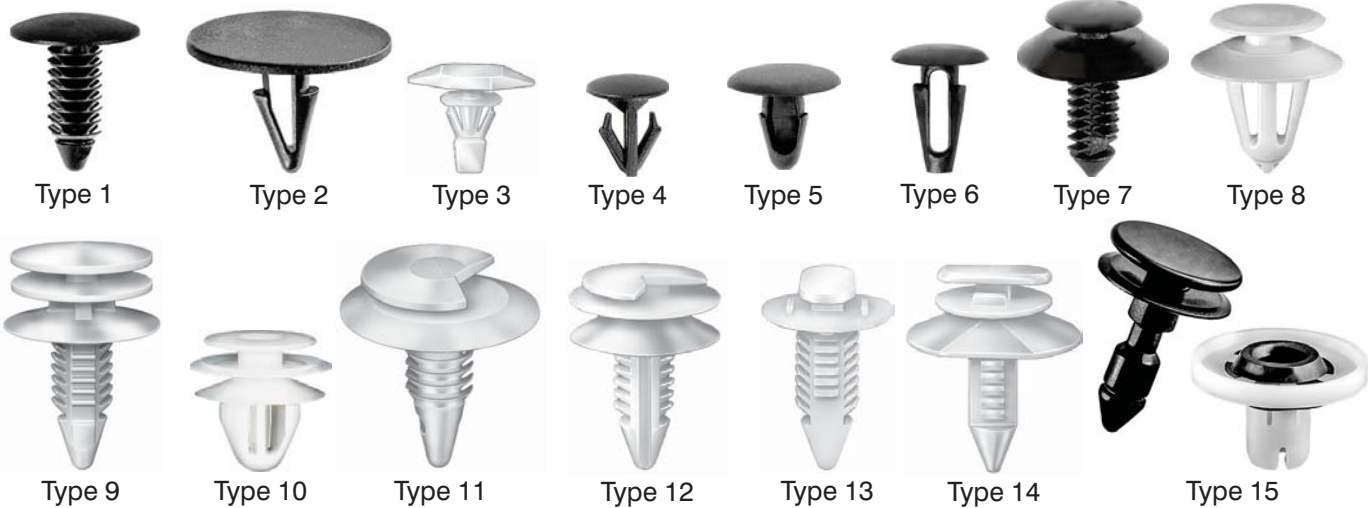

Auveco Part No.	Type	Color	Bottom Head Diameter	Top Head Diameter	Stem Diameter	Stem Length	Page No.
21870	4	Light Gray	18mm		11.5mm	13mm	447
21871	11	White	16.5mm	13mm	8.7mm	11mm	449
21873	10	White	18mm	14mm	9.5mm	14mm	466
21877	1	Black	19.5mm		7mm	13mm	419
21878	1	Black	14mm		7.5mm x 8mm	16mm	419
21879	4	Black	20mm		8mm	10mm	446
21880	4	Black	12mm		7mm	10mm	446
21884	10	White	18mm	11mm	8mm	13mm	467
21891	4	Black	20mm		11mm	7mm	434
21893	7	White	13mm	17mm	12mm	13mm	454
21894	10	Black	22mm	22mm	9.3mm	14mm	473
21895	10	Blue	18mm	13mm	12mm	12mm	462
21896	8	Gray	18mm	13.3mm	9.3mm	13mm	450
21900	6	Black	24mm		7mm	10mm	427
21905	1	Gray	21mm		7.5mm	19mm	427
21906	1	Black	30mm		8mm	18mm	427
21907	1	Gray	30mm		8mm	18mm	429
21908	6	Black	18mm		11mm	12mm	447
21909	6	Gray	18mm		11.3mm	12mm	447
21910	1	Black	16mm		9mm	20mm	419
21911	1	Gray	16mm		9mm	20mm	420
21912	1	Black	16mm		9mm	20mm	420
21913	1	Dark Gray	16mm		12mm	19mm	420
21914	1	Black	40mm		10.5mm	26mm	429
21916	9	Yellow	18mm	12.3mm	12mm	13mm	462
21917	9	Yellow	18mm	12.3mm	12mm	13mm	462
21918	5	Black	7mm x 12mm		8mm	9mm	442
21919	5	Black	7mm x 12mm		7mm	9mm	441
21920	4	Black	9mm x 18mm		8.5mm	10mm	442
21936	1	Black	11.5mm		5.5mm	12mm	416
21937	1	Black	21mm		7.7mm	16mm	421
21938	1	Black	18mm		7mm	17mm	420
21939	1	Tan	21mm		7.7mm	16mm	421
21940	1	Black	18mm		7.3mm	16mm	420
21941	1	Light Gray	21mm		7.7mm	16mm	421
21942	5	Black	9.3mm		6.5mm	13mm	421
21943	5	Gray	12mm		7.5mm	13mm	442
21944	10	Green/White	18mm	12.5mm	10.5mm	12mm	462
21947	1	Black	16mm		5.5mm	26mm	422
21949	3	Black	5mm x 12mm		7mm	10mm	440
21974	10	White	17mm	14mm	8.5mm	11mm	462
21975	11	White	17mm	14mm	9mm	10mm	449
21976	10	White	16.5mm	16mm	8.7mm	13mm	464
21977	7	White	18mm	13mm	11.5mm	12mm	450
21978	12	White	17mm	14mm	9mm	10mm	462
21980	3	Yellow	5mm x 13mm		5.7mm	5mm	439
21981	6	Black	5.5mm x 17mm		5mm	7mm	436
21982	6	Black	5mm x 13mm		5mm	9mm	436

RETAINER SPECIFICATION CHART

Recommended Hole Size: .030" - .060" smaller than stem diameter

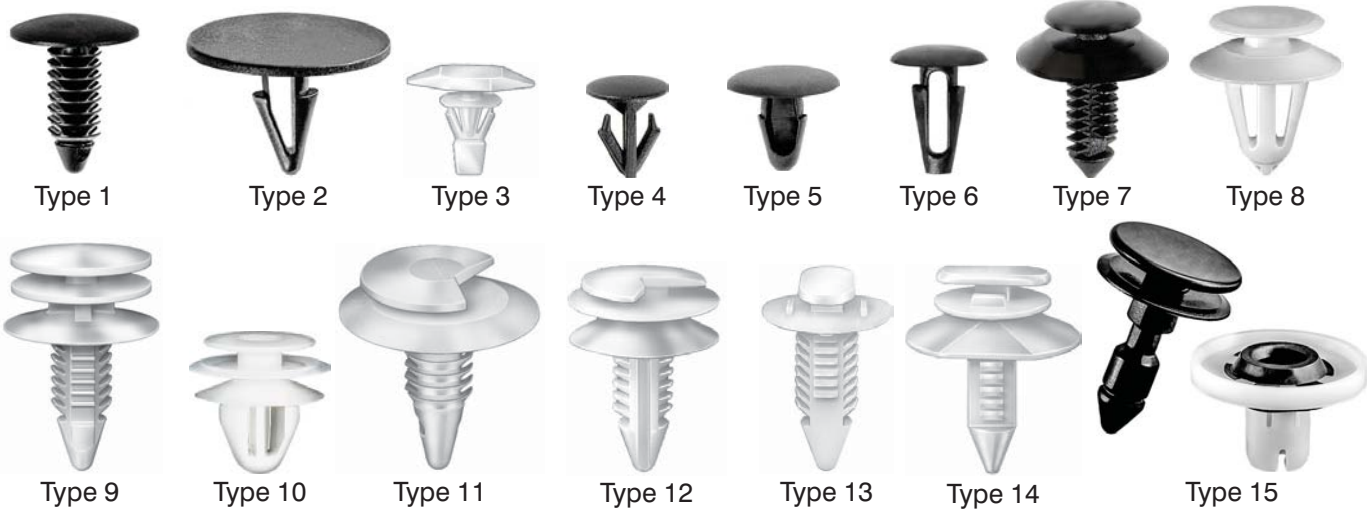

Auveco Part No.	Type	Color	Bottom Head Diameter	Top Head Diameter	Stem Diameter	Stem Length	Page No.
21984	1	Black	10mm		6mm	9mm	415
21991	8	Black	14mm	14mm	10mm	10mm	449
21995	8	White	19mm	17mm	12mm	10mm	454
21996	8	Yellow/White	19mm	17mm	12mm	10mm	454
21997	7	Black/White	28mm	19mm	10mm	12mm	473
21998	9	Yellow/White	17mm	13mm		9mm	461
22001	6	Black	9mm x 13mm		7.5mm	10mm	444
22003	10	White	18mm	13mm	11mm	13mm	462
22004	10	White	18mm	13mm	9mm	15mm	464
22005	10	White	18mm	15mm	10.7mm	12mm	462
22006	10	White	18.5mm	13mm	10.3mm	15mm	467
22008	10	Black	16mm	14mm	10.3mm	10mm	458
22009	10	White	15mm	13mm	9.6mm	13mm	464
22012	10	Blue	18mm	15mm	10.5mm	39mm	469
22031	10	Gray	18mm	16.5mm	10mm	15mm	468
22034	9	White	20mm	19mm	9mm	19mm	469
22046	4	Black	9.3mm x 14.5mm		7mm	16mm	447
22048	10	White	18mm	13mm	9mm x 9.5mm	11mm	459
22053	1	Black	25mm		11mm	45mm	431
22054	6	Black	20mm		7mm	16mm	445
22056	8	White	18mm	13mm	8.5mm x 8.5mm	13mm	452
22057	8	Black	18mm	13mm	9mm	12mm	450
22060	3	Black	6.5mm x 16mm		3.5mm x 5.5mm	8mm	439
22063	Misc.	White	12mm	13mm		14mm	452
22071	Misc.	Black	20mm			15mm	448
22073	Misc.	Black	32mm			12mm	448
22075	1	Black	20mm		8.7mm	16mm	422
22082	6	Black	26mm			14mm	445
22086	Misc.	Black	22mm	30mm		14mm	474
22090	10	Brown	20mm	11.6mm x 15mm		16mm	469
22091	1	Black	20mm		7mm	24mm	473
22092	8	Black	18.5mm	30mm		14mm	474
22093	7	Black	12.3mm	12.3mm	5.5mm	17mm	454
22103	4	Black	20mm		9mm	9mm	435
22107	Misc.	Black	6mm x 15mm		5.6mm x 7mm	12mm	436
22132	Misc.	Gray	22mm	20mm		11mm	454
22133	Misc.	Red	16mm	10mm		7.8mm	451
22149	10	Blue	18mm	14mm	10mm	16mm	468
22152	10	White	18mm	12.5mm	11.5mm	10mm	459
22153	8	White	15mm	8mm x 10mm	12mm	8mm	449
22156	10	White	17mm	13mm		13mm	462
22157	10	Yellow	18mm	13mm	12mm	11mm	464
22162	3	Orange	5mm x 15mm		8mm	8mm	438
22168	Misc.	Black	18mm x 21.5mm			9mm	435
22179	Misc.	Black	18mm	13mm	10.8mm	14.5mm	451
22180	1	Black	23mm		7.6mm	30mm	424
22206	9	White	15mm	13mm	9.6mm x 9.6mm	14mm	467

Sec. 19

RETAINER SPECIFICATION CHART

Recommended Hole Size: .030" - .060" smaller than stem diameter

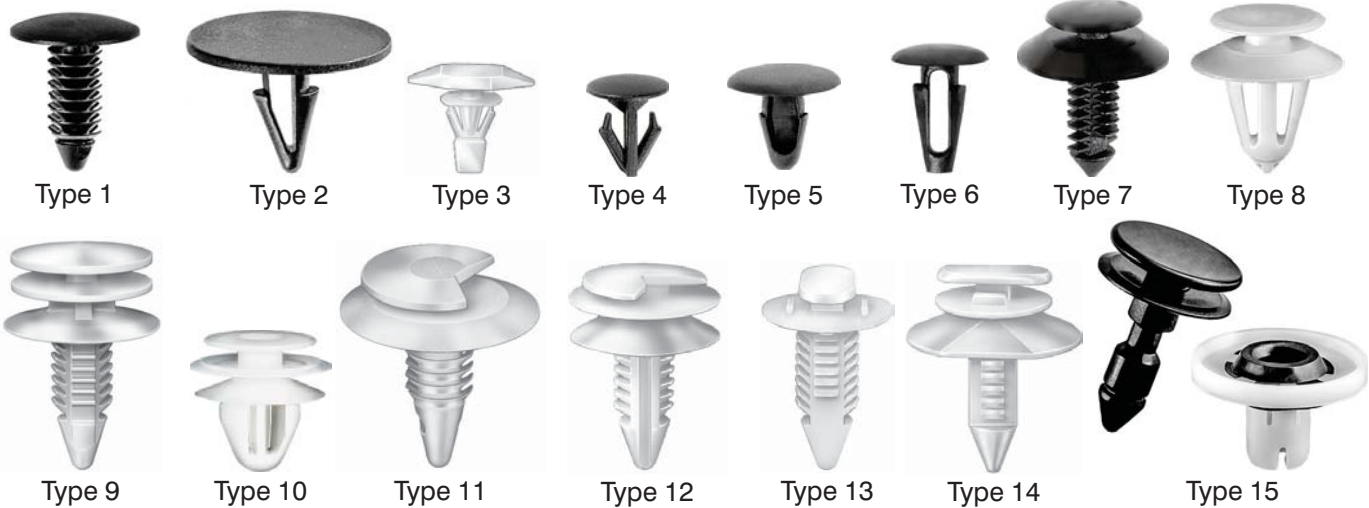

Auveco Part No.	Type	Color	Bottom Head Diameter	Top Head Diameter	Stem Diameter	Stem Length	Page No.
22207	8	Black	17mm	11mm x 14mm	9.7mm	12mm	451
22209	4	Black	20mm			19mm	448
22211	1	Black	23mm		8mm	15mm	432
22212	6	Black	4.3mm x 11mm		6.2mm	10mm	444
22214	6	Black	7.5mm		5.5mm	10mm	443
22220	10	White	19mm	14mm		14mm	467
22221	Misc.	Black	71mm			15mm	445
22229	10	Gray	18mm	14.5mm	9.5mm	14mm	466
22231	10	Black	12mm	10mm	8mm	9mm	458
22233	1	Black		32mm	8.5mm	16mm	433
22236	8	White	18mm	13mm	9.3mm	13mm	451
22237	10	White	18mm	13mm	9mm	13mm	463
22240	8	Yellow	17mm	15mm	9mm	14mm	450
22243	8	White	16mm	13mm	9.5mm	12mm	450
22244	8	White	17mm	14mm	10.8mm	11mm	454
22245	Misc.	Black	19mm			23mm	474
22250	7	Black	18mm	15mm	7.2mm	20mm	470
22251	Misc.	White	15mm	14.5mm	11mm	15mm	453
22252	10	Yellow	18mm	13mm	10.5mm	12mm	451
22254	Misc.	Black	31mm		7mm	12mm	448
22259	7	Black	21mm	13mm	7.4mm	14mm	455
22263	6	Black	16mm		8mm	11mm	445
22267	10	White	18mm	13mm	11mm	14mm	465
22269	Misc.	White	14.5mm	14.5mm	10mm	12mm	460
22278	8	Gray	17mm	13mm	9mm	14mm	453
22279	8	Yellow	17mm	15mm	9mm	15mm	454
22285	10	Red	18mm	14.3mm	9.5mm	13mm	462
22286	Misc.	White	14mm			10mm	445
22288	9	Green	18mm	13mm	9.5mm	15mm	467
22302	3	Yellow	6.5mm	5mm x 15mm	8mm	8mm	439
22305	10	Yellow	17mm	13.3mm	9.3mm	13mm	460
22309	10	White	17mm	13.3mm	9.3mm	13mm	461
22310	3	White	9.5mm x 16.5mm			13.5mm	437
22312	10	Gray	15mm	13mm	9.5mm	12mm	460
22313	10	Green	18mm	13mm	10mm	10mm	459
22315	Misc.	Gray	18mm	13mm	9mm	15mm	466
22320	3	Black	5mm x 13mm		8mm	10mm	436
22321	3	Black	4.5mm x 13mm		7.6mm	7.5mm	436
22325	3	Red	5mm x 15mm		7mm	8mm	439
22336	10	White	12mm	10mm	7.2mm	10mm	458
22337	3	White	9.3mm	5mm x 15mm	7mm	11mm	446
22338	1	Black	26mm		7.6mm	28mm	431
22343	10	Green	15mm	13mm	9.8mm	10mm	459
22355	3	Green	11mm	5mm x 15mm	8mm	9.5mm	438
22356	3	Pink	11mm	5mm x 5mm	8mm	9.5mm	438

PUSH-TYPE RETAINERS

Sec. 19

Refer to Retainer Specification Chart on pages 534-545
Listed smallest to largest by Head Diameter, Stem Length and then by Hole Diameter.



17227
(21077405)
Black Nylon

Door Handle to Door Hardware
Attachment Push-Type Retainer
Head Diameter: 7mm
Stem Length: 10mm
Fits into 5mm Hole
2 Door & 4 Door Models
GM Saturn 1991 - On

UNIT PACKAGE: 25



21780
(BMW: 51-47-8-166-992)
Black Nylon

Trunk Lid Compartment Trim &
Wheel Well Push-Type Retainer
Head Diameter: 9mm
Stem Length: 7mm
Fits into 5mm Hole
3, 5, & M Series 1993 - On

UNIT PACKAGE: 25



19854
(21097229)

Door Handle Push-Type Retainer
Head Diameter: 7mm
Stem Length: 10mm
Fits into 5mm Hole
Saturn 2 Door & 4 Door 1999 - On

UNIT PACKAGE: 25



14016
(GM: 16500308; Chry: 6500787)
Black Nylon

Tail Light Retainer
Large Head Diameter: 3/8" (9.5mm)
Stem Length: 7/16" (11mm)
Fits into 3/16" (4.8mm) Hole
GM & Chrysler

UNIT PACKAGE: 25



21967
(Peugeot & Citroen: 6902.07)
Black Nylon

Push-Type Retainer
Head Diameter: 8mm
Stem Length: 7mm
Fits into 3.5mm Hole
Peugeot & Citroen

UNIT PACKAGE: 100



13999
(20363491)
Black Nylon

Body Side Moulding Push-Type Retainer
Large Head Diameter: 3/8" (9.5mm)
Stem Length: 1/2" (12.7mm)
Fits into 7/32" (5.6mm) Hole
GM 1979 - On

UNIT PACKAGE: 25



21968
(Peugeot & Citroen: 6972.24;
Renault & Dacia: 77-03-072-224)
Black Nylon

Push-Type Retainer
Head Diameter: 8mm
Stem Length: 8mm
Fits into 4mm Hole
Peugeot, Citroen, Renault & Dacia

UNIT PACKAGE: 25



13230
(Mercedes: 000-990-03-92;
Volvo: 947-098)
Black Nylon

Push-Type Retainer
Head Diameter: 10mm
Stem Diameter: 7mm
Fit into 5mm Hole

UNIT PACKAGE: 50



21585
(909130003)
Black Nylon

Upper Grille Push-Type Retainer
Head Diameter: 9mm
Stem Diameter: 7mm
Fits into 4mm Hole
Subaru Baja, Legacy, & Outback
2006 - 2000

UNIT PACKAGE: 25



22230
(Subaru: 909140059)
Black Nylon

Front & Rear Bumper Push-Type Retainer
Head Diameter: 10mm
Stem Length: 8.5mm
Fits into 5mm Hole
Subaru Forester, Impreza, Legacy,
Outback, WRX, XV Crosstrek 2008 - On

UNIT PACKAGE: 15

Sec. 19

PUSH-TYPE RETAINERS

Refer to Retainer Specification Chart on pages 534-545

Listed smallest to largest by Head Diameter, Stem Length and then by Hole Diameter.



21663

(EA01-50-037)
Black Nylon

Push-Type Retainer
Head Diameter: 10mm
Stem Length: 9mm
Fits into 5mm Hole
Mazda 2, 3, CX7, CX9, MX3,
MX5 Miata & RX8 1992 - On

UNIT PACKAGE: 15



21779

(BMW: 51-46-7-002-606)
Black Nylon

Front Bumper, Grille, Trunk Panel
& Rear Window Push-Type Retainer
Head Diameter: 10mm
Stem Length: 11mm
Fits into 6.3mm Hole
3, 5, 7 & Z Series 1997 - On

UNIT PACKAGE: 25



22125

(Toyota: 90467-05170)
Black Nylon

Front Bumper Push-Type Retainer
Head Diameter: 10mm
Stem Length: 10mm
Fits into 5mm Hole
Lexus IS 250, IS 350 & NX 300h and
Toyota Corolla, Highlander, Matrix & RAV4
2012 - On

UNIT PACKAGE: 25



21103

(90467-05090-B1)
Black Nylon

Front Bumper Fascia Push-Type Retainer
Head Diameter: 10mm
Stem Length: 12mm
Fits into 5mm Hole
Toyota Corolla, Matrix & Scion 2008 - On

UNIT PACKAGE: 10



21037

(000-990-84-92)
Black Nylon

Push-Type Retainer
Head Diameter: 10mm
Stem Length: 10mm
Fits into 6mm Hole
Mercedes-Benz 2005-On

UNIT PACKAGE: 25



21881

(Peugeot & Citroen: 6972.11)
Black Nylon

Mud Flap Push-Type Retainer
Head Diameter: 10mm
Stem Length: 12mm
Fits into 6.3mm Hole
Peugeot & Citroen

UNIT PACKAGE: 25



20187

(BMW: 51-16-1-881-149;
Mercedes: 000-990-34-92;
VW: N-102-593-01)
Black Nylon

Radiator Housing Push-Type Retainer
Head Diameter: 10mm
Stem Length: 10mm
Fits into 6mm Hole
Body Styles 116, 123, 124, 136, 129, 140,
170, 201, 208, & 210 1974 - On
BMW & VW

UNIT PACKAGE: 15



21233

(86157-3700)
Black Nylon

Hood Mounting Push-Type Retainer
Head Diameter: 10mm
Stem Length: 13mm
Fits into 5mm Hole
Hyundai Azera 2009 - On

UNIT PACKAGE: 25



22238

(VW: N-905-369-01)
Black Nylon

Bumper, Hood, Interior Trim &
Quarter Panel Push-Type Retainer
Head Diameter: 10mm
Stem Length: 11mm
Fits into 5mm Hole
Audi 90, A4 & S4 and VW Beetle,
Golf & Jetta 1993 - On

UNIT PACKAGE: 25



11702

(D6EA-1A100-AA)
Natural Nylon

Wheel Ornament Push-Type Retainer
Head Diameter: 25/64" (10mm)
Stem Length: 19/32" (15mm)
Fits into 9/32" (7.1mm) Hole
Ford 1976 - On

UNIT PACKAGE: 50

PUSH-TYPE RETAINERS

Sec. 19

Refer to Retainer Specification Chart on pages 534-545
Listed smallest to largest by Head Diameter, Stem Length and then by Hole Diameter.



19242
(15672149)
Black Nylon

Air Inlet Grille Panel Push-Type Retainer
Head Diameter: 13/32" (10.3mm)
Stem Length: 11/16" (17.5mm)
Fits into 7/32" (5/6mm) Hole
GM Jimmy, Blazer, S-10, & Bravada
1994 - On

UNIT PACKAGE: 25



19186
(90657-SB0-003)
Black Nylon

Front Bumper Cover Push-Type Retainer
Head Diameter: 11mm
Stem Length: 10mm
Fits into 8mm Hole
Acura Legend, Honda
Accord & Odyssey 1991 - On

UNIT PACKAGE: 10



21972
(Peugeot & Citroen: 6992.18)
Black Nylon

Push-Type Retainer
Top Head Diameter: 10.5mm
Bottom Head Diameter: 11mm
Stem Length: 6mm
Fits into 6mm Hole
Overall Length: 24.5mm
Peugeot & Citroen

UNIT PACKAGE: 15



21662
(S51S-51-833)
Black Nylon

Push-Type Retainer
Head Diameter: 11mm
Stem Length: 11mm
Fits into 7mm Hole
Mazda 3, MX5 Miata & RX8 2004 - On

UNIT PACKAGE: 15



21989
(VW: 191-867-775A)
Black Nylon

Tailgate Push-Type Retainer
Top Head Diameter: 11mm
Bottom Head Diameter: 12mm
Stem Length: 7mm
Fits into 7mm Hole
Overall Length: 27mm
VW, Audi, SEAT & Skoda

UNIT PACKAGE: 10



14990
(22538102)
Black Nylon

Push-Type Retainer
Head Diameter: 7/16" (11mm)
Stem Length: 15/32" (11.9mm)
Fits into 15/64" (6mm) Hole
GM 1987 - On

UNIT PACKAGE: 50



11854
(14005089)
Natural Nylon

Air Conditioning Vent &
General Purpose Push-Type Retainer
Head Diameter: 7/16" (11mm)
Stem Length: 9/32" (7.1mm)
Fits into 3/16" (4.8mm) Hole
GM 1979 - On

UNIT PACKAGE: 25



17383
(96057847)
Black Nylon

Radiator Grille & Trim Panel
Push-Type Retainer
Head Diameter: 11mm
Stem Length: 14mm
Fits into 7mm Hole
Geo Tracker & Prizm 1992-89

UNIT PACKAGE: 10



21218
(90467-05063-C0)
Black Nylon

Front Bumper Push-Type Retainer
Head Diameter: 11mm
Stem Length: 8mm
Fits into 5mm Hole
Toyota Corolla 2009 - On

UNIT PACKAGE: 15



21249
(90467-07071-22)
Black Nylon

Bumper Cover Push-Type Retainer
Head Diameter: 11mm
Stem Length: 14mm
Fits into 7mm Hole
Toyota Yaris 2009 - On

UNIT PACKAGE: 25

Sec. 19

PUSH-TYPE RETAINERS

Refer to Retainer Specification Chart on pages 534-545

Listed smallest to largest by Head Diameter, Stem Length and then by Hole Diameter.



21711

(Mercedes-Benz: 000-991-59-40)
Black Nylon & Santoprene Rubber

Push-Type Retainer
Head Diameter: 11mm
Stem Length: 16mm
Fits into 6mm Hole
CLS55, CLS500, C Class,
E Class & S1k Class 2006 - On

UNIT PACKAGE: 15



18032

(6502573)
Black Nylon

Cowl Screen Attachment
Push-Type Retainer
Head Size: 15/32" (11.9mm)
Stem Length: 9/16" (14.3mm)
Fits into 1/4" (6.4mm) Square Hole
Chrysler Concorde & LHS, Dodge Intrepid
& Eagle Vision 1993 - On

UNIT PACKAGE: 15



14988

(Ford: N805229S;
GM: 15648833, 22595587)
Black Nylon

Push-Type Retainer
Head Diameter: 7/16" (11mm)
Stem Length: 11/16" (17.5mm)
Fits into 15/64" (6mm) Hole
Ford & GM 1987 - On

UNIT PACKAGE: 25



16783

(66824-01G00)
Black Nylon

Push-Type Retainer
Head Diameter: 12mm
Stem Length: 8mm (Excluding the Pin)
Fits into 6mm Hole
Nissan

UNIT PACKAGE: 25



17214

(GM: 10089262, 21042098;
Chrysler: 55075139)
Black Nylon

Push-Type Retainer
Head Diameter: 11mm (7/16")
Stem Length: 18mm (11/16")
Fits into 6mm (15/64") Hole

GM & Saturn 4 Door & Station Wagon 1987 - On

UNIT PACKAGE: 25



21935

(Renault & Dacia: 77-03-072-361)
Black Nylon

Push-Type Retainer
Head Diameter: 12mm
Stem Length: 10mm
Fits into 6mm Hole
Renault & Dacia

UNIT PACKAGE: 15



20636

(123-990-00-92)
Dark Gray Nylon

Push-Type Retainer
Head Diameter: 12mm
Stem Length: 10mm
Fits into 8.5mm Hole
Mercedes-Benz

UNIT PACKAGE: 15



19788

(10246149; 22657634)
Black Nylon

Rocker Panel Push-Type Retainer
Head Diameter: 11mm
Stem Length: 20mm
Fits into 6mm Hole
GM Achieva, Cutlass, Grand Am
& Malibu 1999 - On

UNIT PACKAGE: 25



21391

(N038-550-1)
Dark Gray Nylon

Bumper, Exterior Trim, Fender,
Quarter Panel & Wheel Opening
Push-Type Retainer
Head Diameter: 12mm
Stem Length: 11mm
Fits into 8mm Hole
Audi and Volkswagen EuroVan,
Golf, Jetta & Passat 2003 - 1985

UNIT PACKAGE: 25

PUSH-TYPE RETAINERS

Sec. 19

Refer to Retainer Specification Chart on pages 534-545
Listed smallest to largest by Head Diameter, Stem Length and then by Hole Diameter.



20639
(000-990-44-92)
Black Nylon

Push-Type Retainer
Head Diameter: 12mm
Stem Length: 11mm
Fits into 5mm x 5mm Hole
Mercedes-Benz

UNIT PACKAGE: 25



21246
(22690838)
Black Nylon

Door Trim Push-Type Retainer
Head Diameter: 12mm
Stem Length: 14mm (Excluding the Pin)
Fits into 6mm Hole
Chevrolet Malibu & Pontiac G6 2004 - On

UNIT PACKAGE: 25



20640
(000-990-40-92, 124-990-05-92-9051)
Black Nylon

Push-Type Retainer
Head Diameter: 12mm
Stem Length: 11mm
Fits into 5mm Hole
Mercedes-Benz

UNIT PACKAGE: 25



19787
(22657634)
Black Nylon

Fender & Rocker Panel
Push-Type Retainer
Head Diameter: 12mm
Stem Length: 17mm
Fits into 6mm Hole
Chevrolet Malibu, Oldsmobile Achieva &
Cutlass and Pontiac Grand Am 1999 - On

UNIT PACKAGE: 25



21882
(Peugeot & Citroen: 6991.F0;
Renault & Dacia: 77-03-072-261)
Black Nylon

Push-Type Retainer
Torx® Drive (T27)
Head Diameter: 12mm
Stem Length: 14mm
Fits into 6mm Hole
Peugeot, Citroen, Renault & Dacia

UNIT PACKAGE: 25



19522
(22644361)
Black Nylon

Door Sill Trim Plate Push-Type Retainer
Head Diameter: 12mm
Stem Length: 18mm
Fits into 6mm Square Hole
Chevrolet Malibu, Olds Achieva
& Cutlass 1997 - On

UNIT PACKAGE: 15



22303
(BMW: 51-16-8-197-908)
Black Nylon

Upper Cover & Spoiler
Push-Type Retainer
Head Diameter: 12mm
Stem Length: 13mm
Fits into 7mm Hole
BMW 1, 3, M3 & Z4 and
Mini-Cooper Base, John Cooper Works,
Countryman & Paceman 2013 - On

UNIT PACKAGE: 15



21875
(Peugeot & Citroen: 6555.LE;
Renault & Dacia: 77-03-072-236)
Black Nylon

Push-Type Retainer
Torx® Drive (T27)
Head Diameter: 12.5mm
Stem Length: 9mm
Fits into 6mm Hole
Peugeot, Citroen, Renault & Dacia

UNIT PACKAGE: 25



20666
(22677979, 22677980)
Gray Nylon

Door Trim
Push-Type Retainer
Head Diameter: 12mm
Stem Length: 14mm (Excluding the Pin)
Fits into 6mm Hole
Chevrolet Malibu 2004 - On

UNIT PACKAGE: 25



22201
(BMW: 51498166702)

Trim Panel Push-Type Retainer
Head Diameter: 12.5mm
Stem Length: 12mm
Fits into 8.5mm Hole
BMW 1, 2, 3, 5, 6, 7, X & Z Series
1995 - On

UNIT PACKAGE: 15

Sec. 19

PUSH-TYPE RETAINERS

Refer to Retainer Specification Chart on pages 534-545

Listed smallest to largest by Head Diameter, Stem Length and then by Hole Diameter.



20163

(25099299)
Black Nylon

Radiator Sight Shield &
Air Filter Housing Push-Type Retainer
Head Diameter: 12.5mm
Stem Length: 17mm
Fits into 6mm Hole
GM 1994 - On

UNIT PACKAGE: 15



21970

(Peugeot & Citroen: 6990.C4)
Black Nylon

Push-Type Retainer
Head Diameter: 13mm
Stem Length: 10mm
Fits into 6mm Hole
Peugeot & Citroen

UNIT PACKAGE: 25



17106

(GM: 22566221;
Chrysler: 6501577)
Black Nylon

Headlight Door Push-Type Retainer
Top Head Diameter: 1/2" (12.7mm)
Stem Length: 7/16" (11mm)
Fits into 3/16" (4.8mm) Hole
GM Blazer & Suburban 1991 - On
Chrysler New Yorker, Landau &
5th Avenue 1988 - On

UNIT PACKAGE: 50



22178

(Ford: W707365-S300)
Black Nylon

Front Fender Push-Type Retainer
Head Diameter: 13mm
Stem Length: 10mm
Fits into 7mm Hole
Ford Edge 2015 - On

UNIT PACKAGE: 10



14995

(GM: 10195515;
Ford: N805026S;
Chrysler: 4696488, 6503163)
Black Nylon

Push-Type Retainer
Head Diameter: 1/2" (12.7mm)
Stem Length: 1-13/64" (30.5mm)
Fits into 9/32" (7mm) Hole
GM, Ford & Chrysler 1987 - On

UNIT PACKAGE: 25



17287

(90687-SB0-003, 90687-SB0-013)
Black Nylon

Cowl Vent Panel Retainer
Head Diameter: 13mm
Stem Length: 11mm
Fits into 6mm Hole
Honda Prelude 1983 - On

UNIT PACKAGE: 25



21769

(Mazda: G14S-50-EA1)
Black Nylon

Push-Type Retainer
Head Diameter: 13mm
Stem Length: 13mm
Fits into 8mm Hole
CX7 & Miata 2004 - On

UNIT PACKAGE: 25



22155

(Land Rover: LR033144)
Black Nylon

Pillar, Rocker & Floor Moulding
Push-Type Retainer
Head Diameter: 13mm
Stem Length: 13mm
Fits into 8mm Hole
Land Rover HSE & Range Rover
2012 - On

UNIT PACKAGE: 15

GET THE KIT THAT FITS

We have several assortments
in the green section. Find the kit
that holds the push-type retainers
you use the most.

PUSH-TYPE RETAINERS

Sec. 19

Refer to Retainer Specification Chart on pages 534-545
Listed smallest to largest by Head Diameter, Stem Length and then by Hole Diameter.



20314
(000-990-37-92)
Black Nylon

Trunk Trim & General Purpose
Push-Type Retainer
Head Diameter: 13mm
Stem Length: 14mm
Fits into 8mm Hole
Mercedes-Benz SL500 &
SL600 Convertible 1999 - On

UNIT PACKAGE: 15



19726
(94858343)
Black Nylon

Door Trim Panel
Push-Type Retainer
Head Diameter: 14mm
Stem Length: 8mm
Fits into 6mm Hole
Geo Prizm 1998 - On

UNIT PACKAGE: 15



21849
(Toyota: 90467-05136)
Black Nylon

Inner Door Lock Plate, Engine Cover &
Outside Air Duct Push-Type Retainer
Head Diameter: 13mm
Stem Length: 15mm
Fits into 5.5mm Hole
Lexus & Toyota 2012 - On

UNIT PACKAGE: 25



19645
(94858864)
Gray Nylon

Door Trim Panel
Push-Type Retainer
Head Diameter: 14mm
Stem Length: 8mm
Fits into 6mm Hole
Geo Prizm 1998 - On

UNIT PACKAGE: 15



21172
(W713202-S300,
W713445-S300)
Black Nylon

Bumper Push-Type Retainer
Head Diameter: 13mm
Stem Length: 18mm
Fits into 8mm Hole
Ford Fusion 2006 - On

UNIT PACKAGE: 15



22058
(Ford: N807673-S)
Black Nylon

Tailgate Push-Type Retainer
Head Diameter: 14mm
Stem Length: 9mm
Fits into 7mm Hole
Ford Explorer Sport Trac 2010 - 2007

UNIT PACKAGE: 10



19355
(15960621)
Black Nylon

Rear Door Radio Speaker
Push-Type Retainer
Head Diameter: 17/32" (13.5mm)
Stem Length: 1-5/64" (27.5mm)
Fits into 1/4" (6.4mm) Hole
GM Trucks C & K 1, 2 1995 - On

UNIT PACKAGE: 25



21451
(333-867-633-4FB)
Black Nylon

Front Lights & Windshield Washer
Push-Type Retainer
Head Diameter: 14mm
Stem Length: 10mm
Fits into 8.5mm Hole
VW 1998 - 95

UNIT PACKAGE: 25



20196
(90467-06133-CO)
Black Nylon

Rocker Panel Push-Type Retainer
Head Diameter: 14mm
Stem Length: 8mm
Fits into 6mm Hole
Toyota 4-Runner 1998 - On

UNIT PACKAGE: 15



14697
(GM: 94198687;
Honda: 90657-SA6-0030;
Mazda: N304-13-356-A)
Black Nylon

Push-Type Retainer
Head Diameter: 14mm
Stem Length: 11mm
Fits into 7mm Hole

UNIT PACKAGE: 25

Sec. 19

PUSH-TYPE RETAINERS

Refer to Retainer Specification Chart on pages 534-545

Listed smallest to largest by Head Diameter, Stem Length and then by Hole Diameter.



16816
(21047094)
Black Nylon

Push-Type Retainer
Top Head Diameter: 14mm
Stem Length: 14mm
Fits into 6mm Hole
GM Saturn 1991 - On

UNIT PACKAGE: 25



21104
(90467-07190-B2)
Black Nylon

Interior Trim Push-Type Retainer
Head Diameter: 14mm
Stem Length: 14mm
Fits into 7mm Hole
Toyota Echo & Scion 2004 - On

UNIT PACKAGE: 10



17478
(B101-68-252-00)
Black Nylon

Interior Trim Push-Type Retainer
Head Diameter: 14mm
Stem Length: 16mm
Fits into 6mm Hole
Ford Probe & Mazda MX6 1988 - On

UNIT PACKAGE: 25



16859
(Nissan: 66860-01W01;
GM: 94051993)
Black Nylon

Cowl Panel to Reinforcement Plate &
Engine Splash Shield Push-Type Retainer
Head Diameter: 14mm (9/16")
Stem Length: 16mm (5/8")
Fits into 6mm (1/4") Hole
Nissan 1980 - On
Geo Storm 1990 - On

UNIT PACKAGE: 25



22349
(Ford: W719367-S300)
Black Nylon

Push-Type Retainer
Head Diameter: 14mm
Stem Length: 18mm
Fits into 8mm x 11mm Hole
Ford

UNIT PACKAGE: 15



19337
(N808908-S)
Black Nylon

Headlight Accessory Push-Type Retainer
Head Diameter: 14mm
Stem Length: 23mm
Fits into 6.3mm (1/4") Hole
Ford Mustang 1996 - On

UNIT PACKAGE: 10



20943
(15014352)
Black Nylon

Cowl Vent Push-Type Retainer
Head Diameter: 14mm
Stem Length: 23mm
Fits into 7mm Hole
Buick Lucerne 2006 - On

UNIT PACKAGE: 15



18353
(15960325)
White Nylon

Door Trim Panel Push-Type Retainer
Head Diameter: 9/16" (14.3mm)
Stem Length: 41/64" (16.3mm)
Fits into 1/4" (6.4mm) Hole
GM Trucks C, K, 1, 2, 3 1995 - On

UNIT PACKAGE: 50



21593
(46064AE000)
Black Nylon

Front Fender, Bumper &
Quarter Panel Push-Type Retainer
Head Diameter: 15mm
Stem Length: 8mm
Fits into 7mm Hole
Subaru Baja, Forester, Impreza,
Legacy & Outback 2003 - On

UNIT PACKAGE: 10



21990
(VW: 6L0-121-136A)
Black Nylon

Push-Type Retainer
Head Diameter: 15mm
Stem Length: 8mm
Fits into 7mm Hole
VW, Audi, SEAT & Skoda

UNIT PACKAGE: 15

PUSH-TYPE RETAINERS

Sec. 19

Refer to Retainer Specification Chart on pages 534-545
Listed smallest to largest by Head Diameter, Stem Length and then by Hole Diameter.



21328

(86155-2H100)
Black Nylon

Cowl & Bumper Push-Type Retainer
Head Diameter: 15mm
Stem Length: 10mm
Fits into 7mm Hole
Hyundai Genesis & Veracruz
and Kia Rio 2009 - On

UNIT PACKAGE: 15



22160

(Subaru: 909140062)
Black Nylon

Front & Rear Bumper
Push-Type Retainer
Head Diameter: 15mm
Stem Length: 10mm
Fits into 7mm Hole
Subaru BRZ, Forester, Impreza &
XV Crosstrek 2008 - On

UNIT PACKAGE: 15



19013

(90467-07059-22)
Black Nylon

Rear Door Trim &
Luggage Compartment Door
Push-Type Retainer
Head Diameter: 15mm
Stem Length: 10mm
Fits into 7mm Hole
Toyota Camry & Celica 1990 - On

UNIT PACKAGE: 15



22280

(VW: 3C0-853-934)
Black Nylon

Splash Shield & Rocker
Moulding Push-Type Retainer
Head Diameter: 15mm
Hex: 8mm (with 4mm Allen Drive)
Stem Length: 10mm
Fits into 8mm Hole
Volkswagen CC 2009 - On
Passat 2010 - 2006

UNIT PACKAGE: 25



14696

(Honda: 90684-SA5-0030;
Isuzu: 8942981190;
Nissan 10998-30880)
Black Nylon

Push-Type Retainer
Head Diameter: 15mm
Stem Length: 11mm
Fits into 6mm Hole

UNIT PACKAGE: 25



21658

(Mitsubishi: MR288150;
Subaru: 909130013)
Black Nylon

Push-Type Retainer
Head Diameter: 15mm
Stem Length: 11mm
Fits into 6mm Hole
Mitsubishi Endeavor, Galant, Lancer,
Mirage, Montero & Outlander 1997 - On
Subaru BRZ, Forester, Impreza, Legacy,
Outback, & XV Crosstrek 2004 - On

UNIT PACKAGE: 10



21140

(MB619582)
Black Nylon

Interior Trim, Bumper & Grille
Push-Type Retainer
Head Diameter: 15mm
Stem Length: 12mm
Fits into 6.3mm Hole
Mitsubishi Eclipse, Endeavor,
Lancer & Outlander 2002 - On

UNIT PACKAGE: 25



22199

(Honda: 90657-SA5-003)
Black Nylon

Bumper & Splash Shield
Push-Type Retainer
Head Diameter: 15mm
Stem Length: 12mm
Fits into 6.3mm Hole
Acura TL 2008 - 04
Honda Accord, CR-V, Insight
& Pilot 2007 - 1997

UNIT PACKAGE: 15



14260

(Toyota: 90467-06017;
Mazda: 9926-50-625;
GM: 20426301)
Black Nylon

Push-Type Retainer
Head Diameter: 15mm
Stem Length: 12mm
Fits into 7mm Hole

UNIT PACKAGE: 15

Sec. 19

PUSH-TYPE RETAINERS

Refer to Retainer Specification Chart on pages 534-545

Listed smallest to largest by Head Diameter, Stem Length and then by Hole Diameter.



20580

(MR478262)
Black Nylon

Bumper Cover & Garnish Moulding
Push-Type Retainer
Top Head Diameter: 15mm
Bottom Head Diameter: 14mm
Stem Length: 12mm
Fits into 7mm Hole

Use with Auveco 20581
Chrysler Sebring & Stratus
and Mitsubishi Eclipse 2000 - On

UNIT PACKAGE: 15



19142

(91550-SH3-003)
Black Nylon

Pillar Garnish, Side and
Trunk Lining Push-Type Retainer
Head Diameter: 15mm
Stem Length: 13mm
Fits into 7mm Square Hole
Honda Civic, Accord Wagon
& Del Sol 1993 - On

UNIT PACKAGE: 5



17206

(90467-09145)
Black Nylon

Bumper Cover Push-Type Retainer
Head Diameter: 15mm
Stem Length: 12mm (Excluding the Pin)
Fits into 9mm Hole
Toyota Camry 1992 - On

UNIT PACKAGE: 15



20169

(W701971-S)
White Nylon

Door Trim Panel Push-Type Retainer
Head Diameter: 15mm
Stem Length: 13mm
Fits into 7mm Hole
Lincoln LS 2000 - On

UNIT PACKAGE: 25



20363

(Not Available from O.E.M.)
White Nylon

Door Trim Panel
Push-Type Retainer
Top Head Diameter: 15mm
Bottom Head Diameter: 20mm
Stem Length: 12mm (Excluding the Pin)
Fits into 9mm Hole
Ford 2001 - On

UNIT PACKAGE: 25



21620

(01553-06071)
Black Nylon

Rear Duct Finishing Panel
Push-Type Retainer
Head Diameter: 15mm
Stem Length: 14mm
Fits into 5mm Hole
Nissan Cube S, SL,
Krom & Leaf 2012 - On

UNIT PACKAGE: 15



17162

(GM: 96057846;
Hyundai: 86155-22000
Toyota: 90467-07041)
Black Nylon

Push-Type Retainer
Head Diameter: 15mm
Stem Length: 13mm
Fits into 6.3mm Hole
Geo Metro & Tracker, Hyundai and Toyota 1989 - On

UNIT PACKAGE: 10



21112

(94530438)
Black Nylon

Fender Liner Push-Type Retainer
Head Diameter: 15mm
Stem Length: 14mm
Fits into 6mm Hole
Chevrolet Aveo 2004 - On

UNIT PACKAGE: 25



19311

(90683-SA5-003)
Black Nylon

Front Fender Skirt Push-Type Retainer
Head Diameter: 15mm
Stem Length: 13mm
Fits into 6mm Hole
Honda Prelude 1996 - 92

UNIT PACKAGE: 15



21120

(90467-07192)
Black Nylon

Cowl Vent Push-Type Retainer
Head Diameter: 15mm
Stem Length: 14mm
Fits into 7mm Hole
Toyota RAV 4 2002 - On

UNIT PACKAGE: 15

PUSH-TYPE RETAINERS

Sec. 19

Refer to Retainer Specification Chart on pages 534-545
Listed smallest to largest by Head Diameter, Stem Length and then by Hole Diameter.



20234

(BMW: 51-11-1-908-077;
Mercedes: 00-990-54-92)
Black Nylon

Scuff Plate Push-Type Retainer
Head Diameter: 15mm
Stem Length: 15mm
Fits into 6.3mm Hole
BMW Series 3, 5 & 7 1984 - On
Mercedes 2014 - 1994

UNIT PACKAGE: 50



17222

(GM: 21075686;
Ford: F3LY-14570-B)
Black Nylon

Rocker Panel, Wheel Liner &
Air Inlet Duct Push-Type Retainer
Head Diameter: 15mm
Stem Length: 20mm
Fits into 8mm Hole
GM Saturn 2 Door & 4 Door Models 1991 - On
Ford

UNIT PACKAGE: 25



21645

(Not Available from O.E.M.)
Black Nylon

Bumper & Wheel Opening
Push-Type Retainer
Head Diameter: 15mm
Stem Length: 15mm
Fits into 6.3mm Hole
BMW 2004 - On

UNIT PACKAGE: 15



22347

(GM: 11561878)
Black Nylon

Bumper, Fender Liner, Cowl, Grille,
Air Inlet Duct, Rocker Panel, Wheel Liner,
Quarter Panel & Upper Deflector
Push-Type Retainer with Sealer
Head Diameter: 15mm
Stem Length: 21mm
Fits into 8mm Hole
Various Buick, Cadillac Chevrolet,
GMC, Hummer, Saab &
Saturn Models 1991 - On

UNIT PACKAGE: 25



11705

(387843-S)
Black Nylon

Fender Shield Retainer
Head Diameter: 19/32" (15mm)
Stem Length: 5/8" (16mm)
Fits into 1/4" (6.4mm) Hole
Ford 1978 - On

UNIT PACKAGE: 50



14997

(10053182)
Black Nylon

Push-Type Retainer
Head Diameter: 19/32" (15mm)
Stem Length: 13/16" (20.6mm)
Fits into 5/16" (8mm) Hole
GM 1987 - On

UNIT PACKAGE: 25



21011

(90467-07188)
Black Nylon

Push-Type Retainer
Head Diameter: 15mm
Stem Length: 17mm
Fits into 7mm Hole
Toyota Camry, Tundra & 4-Runner
2002 - On

UNIT PACKAGE: 15



17103

(GM: 15681408;
Ford: N803709S)
Black Nylon

Fascia Retainer
Head Diameter: 15mm
Stem Length: 23mm
Fits into 6mm Hole
GM & Ford 1986 - On

UNIT PACKAGE: 50



19801

(21077123)
Black Nylon

Wheel Opening Moulding
Push-Type Retainer
Head Diameter: 19/32" (15mm)
Stem Length: 3/4" (19mm)
Fits into 1/4" (6.4mm) Hole
Saturn 1991 - On

UNIT PACKAGE: 25



14992

(Ford: N803946S;
Chrysler: 6502871)
Black Nylon

Push-Type Retainer
Head Diameter: 19/32" (15mm)
Stem Length: 29/32" (23mm)
Fits into 1/4" (6.4mm) Hole
Ford & Chrysler 1987 - On

UNIT PACKAGE: 50

Sec. 19

PUSH-TYPE RETAINERS

Refer to Retainer Specification Chart on pages 534-545

Listed smallest to largest by Head Diameter, Stem Length and then by Hole Diameter.



19511

(W704958-S300)
White Nylon

Rear Door Lower Trim Panel
Push-Type Retainer
Round Head Diameter: 19/32" (15mm)
Wedge Shaped Head
Diameter: 29/32" (23mm)
Stem Length: 11/16" (17.5mm)
Fits into 3/8" (9.5mm)
Lincoln Town Car 1998 - On

UNIT PACKAGE: 25



17439

(90467-09093)
Black Nylon

Bumper Cover
Push-Type Retainer
Head Diameter: 15mm
Stem Length: 27mm
Fits into 9mm Hole
Lexus LS-400

UNIT PACKAGE: 10



19219

(90467-09096)
Black Nylon

Front Bumper Push-Type Retainer
Head Diameter: 15mm
Stem Length: 27mm
Fits into 9mm Hole
Lexus LS400 and Toyota Celica &
Supra 1989 - On

UNIT PACKAGE: 10



17226

(10207146, 21077323)
Black Nylon

Rear Door Rocker
Panel to Underbody Bracket
Push-Type Retainer
Head Diameter: 15mm
Stem Length: 29mm
Fits into 8mm Hole
GM Saturn 4 Door Models 1991 - On

UNIT PACKAGE: 25



19552

(90467-07146)
Black Nylon

Cowl Panel &
Luggage Compartment Retainer
Head Diameter: 16mm
Stem Length: 9mm
Fits into 7mm Hole
Toyota Avalon, Camry, Celica & Solara 1993 - On

UNIT PACKAGE: 15



21969

(Peugeot & Citroen: 8748.C2)
Charcoal Gray Nylon

Push-Type Retainer
Head Diameter: 16mm
Stem Length: 10mm
Fits into 6mm Hole
Peugeot & Citroen

UNIT PACKAGE: 25



21624

(90467-10206)
Black Nylon

Cowl Push-Type Retainer
Head Diameter: 16mm
Stem Length: 10mm
Fits into 8mm Hole
Lexus ES 350, RX350 & RX 450H and Toyota Camry,
Sequoia, Tundra & Yaris 2006 - On

UNIT PACKAGE: 15



22083

(Suzuki: 09409-08327)
Black Nylon

Front Lights, Cowl &
Rear Bumper Push-Type Retainer
Head Diameter: 16mm
Stem Length: 10mm
Fits into 8mm Hole
Suzuki Kizashi, SX4 & XL7 2013 - 02

UNIT PACKAGE: 15



19243

(GM: 30008324; Suzuki: 09409-07325)
Black Nylon

Push-Type Retainer
Head Diameter: 16mm
Stem Length: 10mm (Excluding the Pin)
Fits into 9mm Hole
Front & Rear Bumper Fascia
Geo Metro 1989 - On
Radiator Grille
Suzuki Esteem 1995 - On

UNIT PACKAGE: 15



21570

(909140012)
Black Nylon

Rear Light Reflector & Roof Spoiler
Push-Type Retainer
Head Diameter: 16mm
Stem Length: 11mm
Fits into 6mm Hole
Subaru B9 Tribeca, Impreza,
Legacy & Outback 2005 - On

UNIT PACKAGE: 25

PUSH-TYPE RETAINERS

Sec. 19

Refer to Retainer Specification Chart on pages 534-545
Listed smallest to largest by Head Diameter, Stem Length and then by Hole Diameter.



21044
(123-990-05-92, 126-990-03-92)
Black Nylon

Cowl Screen Cover
Push-Type Retainer
Head Diameter: 16mm
Stem Length: 11mm
Fits into 6.3mm Hole
Mercedes-Benz E, CL & S Class 2000 - On

UNIT PACKAGE: 15



20310
(383142-S)
Black Nylon

Grille to Headlight Bracket
Push-Type Retainer
Head Diameter: 5/8" (16mm)
Stem Length: 7/16" (11mm)
Fits into 1/4" (6.4mm) Hole
Ford

UNIT PACKAGE: 50



21859
(Mercedes-Benz: 000-990-29-92,
000-990-60-92; 001-990-16-92,
114-990-01-92; Opel: 1104882, 1719245;
Volvo: 9133417, 1268642)
Black Nylon

Push-Type Retainer
Head Diameter: 16mm
Stem Length: 11mm
Fits into 8mm Hole
Mercedes-Benz, Opel & Volvo 1985 - On

UNIT PACKAGE: 15



22234
(Ford European: 1257376)
Black Nylon

Door Trim Panel Push-Type
Retainer with Sealer
Top Head Diameter: 16mm
Bottom Head Diameter: 18mm
Stem Length: 11mm
Fits into 8mm Hole
Ford Focus & Focus C-Max 2010 - 1998

UNIT PACKAGE: 15



19306
(GA5R-56-392)
Black Nylon

Shroud Seal Board Push-Type Retainer
Head Diameter: 16mm
Stem Length: 12mm
Fits into 6mm Hole
Mazda 626 1994 - On

UNIT PACKAGE: 10



19297
(21035345)
Black Nylon

Liftgate Upper Window & Lower Garnish
Moulding Push-Type Retainer
Head Diameter: 16mm
Stem Length: 12mm (Excluding the Pin)
Fits into 7mm Hole
GM Saturn 1998 - 93

UNIT PACKAGE: 15



19195
(161-867-299-01C)
Black Nylon

Push-Type Retainer
Head Diameter: 16mm
Stem Length: 12mm
Fits into 8mm Hole
VW Golf & Jetta 1997 - 93

UNIT PACKAGE: 25



19607
(XL3Z-17E971-AA)
Natural Nylon

Front Bumper Cover Push-Type Retainer
Head Diameter: 16mm
Stem Length: 12mm
Fits into 10mm Hole
Ford F150 & F250 Trucks 1999 - On

UNIT PACKAGE: 25



21566
(91085TA030)
Black Nylon

Push-Type Retainer
Head Diameter: 16mm
Stem Length: 13mm
Fits into 7mm Hole
Subaru Baja, Impreza,
Legacy & Outback 2000 - On

UNIT PACKAGE: 25



22177
(Chrysler: 6510766-AA)
Yellow & White Nylon

Door Panel Push-Type
Retainer with Sealer
Top Head Diameter: 16mm
Middle Head Diameter: 18mm
Bottom Head Diameter: 22mm
Stem Length: 13mm
Fits into 9mm Hole
Chrysler 300, Dodge Charger &
Jeep Cherokee 2014 - On

UNIT PACKAGE: 15

Sec. 19

PUSH-TYPE RETAINERS

Refer to Retainer Specification Chart on pages 534-545

Listed smallest to largest by Head Diameter, Stem Length and then by Hole Diameter.



21601

(06509673AA)

White Nylon with Black Rubber Seal

Push-Type Retainer
Top Head Diameter: 16mm
Middle Head Diameter: 18mm
Bottom Head Diameter: 22mm
Stem Length: 16mm
Fits into 9mm Hole

Chrysler 300 & Magnum and Jeep Grand Cherokee & Wrangler 2011 - On

UNIT PACKAGE: 15



21325

(90080-46294)

Black Nylon

Turn Signal Light & General Purpose
Push-Type Retainer
Head Diameter: 16mm
Stem Length: 14mm
Fits into 7mm Hole
Toyota Tundra 2003 - On

UNIT PACKAGE: 10



15522

(N805231S)

Black Nylon

Push-Type Retainer
Head Diameter: 5/8" (16mm)
Stem Length: 17/32" (13.5mm)
Fits into 1/4" (6.4mm) Hole

Ford Taurus, Topaz & Sable 1989 - On

UNIT PACKAGE: 50



19904

(9133417-7)

Black Nylon

Rocker Panel Push-Type Retainer
Head Diameter: 16mm
Stem Length: 14mm
Fits into 9mm Hole

Volvo 850 Series 1994 - On

UNIT PACKAGE: 15



19248

(1268176-3)

Black Nylon

Bumper Cover Push-Type Retainer
Head Diameter: 16mm
Stem Length: 14mm
Fits into 6mm Hole
Volvo 740 & 760 1993 - On

UNIT PACKAGE: 15



21971

(Peugeot & Citroen: 6973.34)

Black Nylon

Push-Type Retainer
Head Diameter: 16mm
Stem Length: 14mm
Fits into 9mm Hole
Peugeot & Citroen

UNIT PACKAGE: 25



21190

(91550-S50-000ZL)

Black Nylon

Interior Trim Push-Type Retainer
Head Diameter: 16mm
Stem Length: 14mm
Fits into 7mm Hole
Honda Civic, CR-V Element
& Insight 2000 - On

UNIT PACKAGE: 15



20909

(124-990-04-92)

Black Nylon

Push-Type Retainer
Head Diameter: 16mm
Stem Length: 18mm
Fits into 7mm Hole
Mercedes-Benz 2003 - On

UNIT PACKAGE: 15



21477

(91550-S50-000ZK)

Gray Nylon

Push-Type Retainer
Head Diameter: 16mm
Stem Length: 14mm
Fits into 7mm Hole
Honda Civic, CR-V Element & Insight
2000 - On

UNIT PACKAGE: 15



18265

(76882-57A00)

Black Nylon

Body Side Moulding Push-Type Retainer
Head Diameter: 16mm
Stem Length: 20mm
Fits into 8mm Hole
Nissan Sentra 1986 - On

UNIT PACKAGE: 25

PUSH-TYPE RETAINERS

Sec. 19

Refer to Retainer Specification Chart on pages 534-545
Listed smallest to largest by Head Diameter, Stem Length and then by Hole Diameter.



20352
(Honda: 91561-S84-A00-M1,
91561-S84-A21ZB)
Black Nylon
Rear Panel Assembly Push-Type Retainer
Head Diameter: 16mm
Stem Length: 21mm
Fits into 8mm Hole
Honda Accord & Civic 2007 - 01
Fit 2014 - 09
UNIT PACKAGE: 10



18165
(91508-SR3-000)
Black Nylon
Cowl Panel
Push-Type Retainer
Head Diameter: 17mm
Stem Length: 9mm
Fits into 8mm Hole
Honda 1990 - On
UNIT PACKAGE: 10



20542
(15994165)
Black Nylon
Bumper & Rear Wheel Apron
Push-Type Retainer
Head Diameter: 16.5mm
Stem Length: 27mm
Fits into 8mm Hole
Saturn L Series 2000 - On
UNIT PACKAGE: 25



17351
(MB-253964)
Black Nylon
Front & Rear Bumper Push-Type Retainer
Head Diameter: 17mm
Stem Length: 10mm
Fits into 7mm Hole
Mitsubishi Tredia 1988 - 83
UNIT PACKAGE: 10



14011
(14019226, 14071289)
Black Nylon
Radiator Overflow Bottle/Windshield
Washer Bottle Retainer
Head Diameter: 21/32" (16.7mm)
Stem Length: 9/16" (14.3mm)
Fits into 5/16" (8mm) Hole
GM 1981 - On
UNIT PACKAGE: 25



20910
(91505-ST7-003ZA)
Black Nylon
Door Panel Push-Type Retainer
Head Diameter: 17mm
Stem Length: 12mm
Fits into 8mm Hole
Honda CR-V and S2000 2000 - On
UNIT PACKAGE: 10



14001
(14039420)
Black Nylon
Push-Type Retainer
Head Diameter: 21/32" (16.7mm)
Stem Length: 19/32" (15mm)
Fits into 5/16" (8mm) Hole
GM (Including Saturn)
UNIT PACKAGE: 25



19232
(91502-SZ5-003)
Black Nylon
Front Fender
Push-Type Retainer
Head Diameter: 17mm
Stem Length: 13mm
Fits into 7mm Hole
Acura 3.5 RL Sedan 1996 - On
UNIT PACKAGE: 10



18270
(90467-07117)
Black Nylon
Push-Type Retainer
Head Diameter: 17mm
Stem Length: 9mm
Fits into 7mm Hole
Lexus 1990 - On
UNIT PACKAGE: 10



19547
(91508-S50-003)
Black Nylon
Cowl Top Retainer
Head Diameter: 17mm
Stem Length: 13mm (Excluding the Pin)
Fits into 9mm Hole
Honda Accord & Odyssey 1998 - On
UNIT PACKAGE: 5

Sec. 19

PUSH-TYPE RETAINERS

Refer to Retainer Specification Chart on pages 534-545

Listed smallest to largest by Head Diameter, Stem Length and then by Hole Diameter.



15672
(8880417)
Black Nylon

Push-Type Retainer
Head Diameter: 17mm
Stem Length: 14mm
Fits into 8mm (5/16") Hole
Chrysler 1987 - On

UNIT PACKAGE: 25



13457
(20451119)
Black Nylon

Front Compartment Spare Tire Retainer
Head Diameter: 43/64" (17mm)
Stem Length: 23/32" (18.3mm)
Fits into 5/16" (8mm) Hole
GM

UNIT PACKAGE: 10



19546
(91570-SK7-003ZF)
Black Nylon

Tailgate Lining Retainer
Head Diameter: 17mm
Stem Length: 16mm
Fits into 7mm Square Hole
Honda Prelude 1997 - On

UNIT PACKAGE: 10



21898
(Renault & Dacia: 77-03-072-352)
Black Nylon

Push-Type Retainer
Head Diameter: 17.5mm
Stem Length: 9mm
Fits into 6mm Hole
Renault & Dacia

UNIT PACKAGE: 10



19639
(GM: 15149708;
Chrysler: 6506008AA)
Black Nylon

Radiator Wheelhouse, Fender &
Front Bumper Cover Push-Type Retainer
Head Diameter: 17mm
Stem Length: 16mm
Fits into 6mm Hole
GM C & K Trucks 1999 - On
Jeep Liberty 2002 - On

UNIT PACKAGE: 25



11704
(6031383)
Black Nylon

Grille Retainer
Head Diameter: 11/16" (17.5mm)
Stem Length: 7/16" (11mm)
Fits into 9/32" (7.1mm) Hole
Chrysler 1978 - On

UNIT PACKAGE: 25



16624
(1636632, 20687704)
Black Nylon

Front Bumper Fascia
Push-Type Retainer
Head Diameter: 17mm
Shoulder Length: 2mm
Stem Length: 18mm
Fits into 9.5mm (3/8") Hole
Buick Riviera/Reatta 1988 - On

UNIT PACKAGE: 25



18893
(N806322-S)
Black Nylon

Trim Panel Push-Type Retainer
Head Diameter: 11/16" (17.5mm)
Stem Length: 1/2" (12.7mm)
Fits into 1/4" (6.4mm) Hole
Ford

UNIT PACKAGE: 15



14726
(63844-01A99)
Black Nylon

Push-Type Retainer
Head Diameter: 17mm
Stem Length: 18mm
Fits into 8mm Hole
Nissan

UNIT PACKAGE: 25



12567
(GM: 14019205, 14019206, 16514113;
Chrysler: 34201621, 6504090)
Black Nylon

Front Fender Mud Skirt
& Fender Liner Push-Type Retainer
Head Diameter: 11/16" (17.5mm)
Stem Length: 9/16" (14.3mm)
Fits into 1/4" (6.4mm) Hole
GM 1981 - On

UNIT PACKAGE: 25

14007

Same as 12567 except unit package quantity

UNIT PACKAGE: 50

PUSH-TYPE RETAINERS

Sec. 19

Refer to Retainer Specification Chart on pages 534-545
Listed smallest to largest by Head Diameter, Stem Length and then by Hole Diameter.



11699

(GM: 472434; Chrysler: 6031390)
Black Nylon

Cowl Ledge Weatherstrip
& Fender Liner Push-Type Retainer
Head Diameter: 11/16" (17.5mm)
Stem Length: 5/8" (16mm)
Fits into 1/4" (6.4mm)
GM 1970 - On
Chrysler 1968 - On

UNIT PACKAGE: 50



18327

(6503454)
Black Nylon

Front Bumper Fascia
Push-Type Retainer
Head Diameter: 11/16" (17.5mm)
Stem Length: 5/8" (16mm)
Fits into 1/4" (6.4mm) Hole
Jeep Grand Cherokee 1994 - On

UNIT PACKAGE: 25



14991

(GM: 10139822, 25680782;
Ford: N808147S)
Black Nylon

Push-Type Retainer
Head Diameter: 11/16" (17.5mm)
Stem Length: 11/16" (17.5mm)
Fits into 1/4" (6.4mm) Hole
GM & Ford 1987 - On

UNIT PACKAGE: 25



18894

(N807578-S, N808332-S)
Black Nylon

Trim Panel
Push-Type Retainer
Head Diameter: 11/16" (17.5mm)
Stem Length: 3/4" (19mm)
Fits into 1/4" (6.4mm) Hole
Ford

UNIT PACKAGE: 15



18030

(Chrysler: 6501925;
GM: 10134407)
Black Nylon

Push-Type Retainer
Head Diameter: 11/16" (17.5mm)
Stem Length: 13/16" (20.6mm)
Fits into 1/4" (6.4mm) Hole
Chrysler Concorde & LHS
Dodge Intrepid & Eagle Vision 1993 - On
Coolant Recovery Reservoir
GM 1992 - On

UNIT PACKAGE: 25



13993

(GM: 20510029; Ford: N803362-S;
Chrysler: 34202672)
Black Nylon

Body Retainer
Head Diameter: 11/16" (17.5mm)
Stem Length: 7/8" (22mm)
Fits into 1/4" (6.4mm) Hole
GM 1984 - On and Ford 1984 - On

UNIT PACKAGE: 25



14753

(GM: 15773445, 20452072, 20664092;
Ford N804570S; Chrysler: 4638136)
Black Nylon

Radiator Shroud & Trim Retainer
Head Diameter: 11/16" (17.5mm)
Stem Length: 7/8" (22mm)
Fits into 1/4" (6.4mm) Hole
GM 1982 - On
Ford 1986 - On
Chrysler 1998 - On



UNIT PACKAGE: 25



14993

(22538004)
Black Nylon

Push-Type Retainer
Head Diameter: 11/16" (17.5mm)
Stem Length: 7/8" (22mm)
Fits into 1/4" (6.4mm) Hole
GM 1987 - On

UNIT PACKAGE: 25



13996

(20452072, 20590899)
Black Nylon

Exterior Body Retainer
Head Diameter: 11/16" (17.5mm)
Stem Length: 7/8" (22mm)
Fits into 9/32" (7.1mm) Hole
GM 1984 - On

UNIT PACKAGE: 25



18895

(N807577-S, N808331-S)
Black Nylon

Trim Panel Push-Type Retainer
Head Diameter: 11/16" (17.5mm)
Stem Length: 1-3/32" (28mm)
Fits into 1/4" (6.4mm) Hole
Ford Aerostar & Windstar

UNIT PACKAGE: 15

Sec. 19

PUSH-TYPE RETAINERS

Refer to Retainer Specification Chart on pages 534-545

Listed smallest to largest by Head Diameter, Stem Length and then by Hole Diameter.



20335
(53879-60010)
Black Nylon

Fender Liner Push-Type Retainer
Head Diameter: 18mm
Stem Length: 7mm
Fits into 7mm Hole
Toyota Land Cruiser & RAV 4 1998 - On

UNIT PACKAGE: 15



21024
(5R3Z-54310D12-AAA)
Black Nylon

Trim Panel
Push-Type Retainer
Head Diameter: 18mm
Stem Length: 10mm
Fits into 6mm Hole
Ford Mustang 2005 - On

UNIT PACKAGE: 15



20869
(GM: 88970767; Toyota: 90467-10183)
Black Nylon

Front Fender Liner Push-Type Retainer
Head Diameter: 18mm
Stem Length: 7.5mm
Fits into 7mm Hole
Toyota Celica, Corolla, Matrix & Solara,
Lexus and Pontiac Vibe 1999 - On

UNIT PACKAGE: 10



21530
(Subaru: 909130067;
Hyundai: 86590-3S000)
Black Nylon

Engine Cover and Fender Liner
Push-Type Retainer
Head Diameter: 18mm
Stem Length: 10mm
Fits into 8mm Hole
B9 Tribeca, Forester, Legacy &
Outback & Tribeca. 2005 - On
Hyundai Azera, Elantra, Genesis & Sonata and
Kia Cadenza & Optima 2011 - On

UNIT PACKAGE: 15



19490
(90467-06150)
Black Nylon

Back Garnish Trim Panel
Push-Type Retainer
Head Diameter: 18mm
Stem Length: 8mm
Fits into 6mm Hole
Toyota Tacoma 1995 - On

UNIT PACKAGE: 10



22181
(Subaru: 909140065)
Black Nylon

Front Fender Liner, Engine Cover,
Hood & Quarter Panel Push-Type Retainer
Head Diameter: 18mm
Stem Length: 10mm
Fits into 8mm Hole
Subaru BRZ, Crosstrek, Forester, Impreza,
Legacy, Outback & WRX 2008 - On

UNIT PACKAGE: 15



20465
(UB39-45-919)
Black Nylon

Front & Rear Fender
Push-Type Retainer
Head Diameter: 18mm
Stem Length: 9mm
Fits into 8mm Hole
Mazda 626 2000 - On

UNIT PACKAGE: 10



21680
(Chrysler: 6509960AA)
Black Nylon

Bumper Push-Type Retainer
Head Diameter: 18mm
Stem Length: 10mm
Fits into 8mm Hole
Chrysler 300 2011 - On

UNIT PACKAGE: 25



22077
(Mitsubishi: MB879499)
Black Nylon

Front Bumper Push-Type Retainer
Head Diameter: 18mm
Stem Length: 9mm
Fits into 9mm Hole
Mitsubishi Montero 2006 - 01

UNIT PACKAGE: 25



19747
(UB39-50-795)
Black Nylon

Stone Guard Push-Type Retainer
Head Diameter: 18mm
Stem Length: 10mm
Fits into 8mm Hole
Mazda MPV 1998 - On

UNIT PACKAGE: 10

PUSH-TYPE RETAINERS

Sec. 19

Refer to Retainer Specification Chart on pages 534-545
Listed smallest to largest by Head Diameter, Stem Length and then by Hole Diameter.



21547

(90467-09185)
Black Nylon

Front Spoiler & Grille
Push-Type Retainer
Head Diameter: 18mm
Stem Length: 10mm
Fits into 9mm Hole
Lexus HS 250h and Toyota Celica,
Sequoia, Sienna & 4-Runner 1994 - On

UNIT PACKAGE: 25



21703

Ford: W716510-S300)
Black Nylon

Lower Radiator Shield
Push-Type Retainer
Head Diameter: 18mm
Stem Length: 12mm
Fits into 7mm Hole
Ford Fusion 2013 - On

UNIT PACKAGE: 10



14698

(90688-SB0-003)
Black Nylon

Push-Type Retainer
Head Diameter: 18mm
Stem Length: 11mm
Fits into 6mm Hole
Acura & Honda

UNIT PACKAGE: 25



17632

(Mazda: B092-51-833;
Ford: MB-455-56143)
Black Nylon

Push-Type Retainer
Head Diameter: 18mm
Stem Length: 12mm
Fits into 8mm Hole
Mazda & Ford Aspire

UNIT PACKAGE: 10



16784

(Nissan: 80999-05N07;
Toyota: 90467-07043)
Black Nylon

Push-Type Retainer
Head Diameter: 18mm
Stem Length: 11mm (Excluding the Pin)
Fits into 7mm Hole

UNIT PACKAGE: 25



21146

(0G032-50037-A)
Black Nylon

Bumper, Fender, Grille, Interior & Exterior
Trim and Pillar Push-Type Retainer
Head Diameter: 18mm
Stem Length: 12mm
Fits into 8mm Hole
Kia Amanti, Magentis, Optima, Rio, Sedona, Sephia,
Sorento, Spectra & Sportage 2000 - On

UNIT PACKAGE: 15



17081

(91524-SE0-003)
Black Nylon

Cowl Push-Type Retainer
Head Diameter: 18mm
Stem Length: 12mm
Fits into 6mm Hole
Honda Accord 1986 - On

UNIT PACKAGE: 25



21311

(01553-0038U)
Gray Nylon

Bumper Push-Type Retainer
Head Diameter: 18mm
Stem Length: 12mm
Fits into 8mm Hole
Nissan Frontier, Pathfinder & Xterra
2005 - On

UNIT PACKAGE: 10



18206

(GJ21-68885-B69)
Gray Nylon

Push-Type Retainer
Head Diameter: 18mm
Stem Length: 12mm
Fits into 6mm Hole
Ford Probe & MX6 1989 - On

UNIT PACKAGE: 25



20349

(01553-09611)
Black Nylon

Bumper Clip
Push-Type Retainer
Head Diameter: 18mm
Stem Length: 12mm
Fits into 8mm Hole
Nissan Maxima 1994 - On

UNIT PACKAGE: 15

Sec. 19

PUSH-TYPE RETAINERS

Refer to Retainer Specification Chart on pages 534-545

Listed smallest to largest by Head Diameter, Stem Length and then by Hole Diameter.



21110
(B100-68-8550)
Black Nylon

Rear Light Access Door
Push-Type Retainer
Head Diameter: 18mm
Stem Length: 12mm
Fits into 8.5mm Hole
Mazda 323 1986 - On

UNIT PACKAGE: 15



21141
(91561-SJD-003)
Black & White Nylon

Pillar, Rocker Panel & Floor Retainer
Top Head Diameter: 15mm
Middle Head Diameter: 16mm
Bottom Head Diameter: 18mm
Stem Length: 13mm
Fits into 8mm Hole
Honda Civic & Pilot 2004 - On

UNIT PACKAGE: 10



20247
(Mitsubishi: MR200300)
Black Nylon

Fender & Bumper Push-Type Retainer
Head Diameter: 18mm
Stem Length: 12mm
Fits into 9mm Hole
Honda & Mitsubishi 1998 - On

UNIT PACKAGE: 15



21858
(Mazda: B467-68-AC3-02)
Black Nylon

Rear Trunk Liner Push-Type Retainer
Head Diameter: 18mm
Stem Length: 14mm
Fits into 6mm Hole
5, CX-7, CX-9, Miata, Millenia, MX-6,
RX-7 & Protégé 1993 - On

UNIT PACKAGE: 25



21702
(Toyota: 90467-10170-C0)
Black Nylon

Cowl Vent, Upper Radiator Cover &
Wheel Apron Push-Type Retainer
Head Diameter: 18mm
Stem Length: 12mm
Fits into 10mm Hole
Lexus LS 460, LS 600, RX 350
& RX 450 and Toyota RAV4 2006 - On

UNIT PACKAGE: 10



21225
(53888-48010)
Black Nylon

Wheel Opening Push-Type Retainer
Head Diameter: 18mm
Stem Length: 14mm
Fits into 7mm Hole
Toyota Highlander 2001 - On

UNIT PACKAGE: 5



20365
(10301966, 10425306)
Black Nylon

Cowl Vent Push-Type Retainer
Head Diameter: 18mm
Stem Length: 13mm
Fits into 7.5mm Square Hole
Pontiac Aztek 2001 - On

UNIT PACKAGE: 10



17192
(91508-SM4-003)
Black Nylon

Cowl Panel Push-Type Retainer
Head Diameter: 18mm
Stem Length: 14mm
Fits into 8mm Hole
Honda Accord 1990 - On

UNIT PACKAGE: 10



21807
(Renault: 77-03-072-360)
Black Nylon

Push-Type Retainer
Head Diameter: 18mm
Stem Length: 14mm
Fits into 8mm Hole
Renault and Dacia

UNIT PACKAGE: 25



22253
(Hyundai: 86595-2T500)
Black Nylon

Fender Liner Push-Type Retainer
Head Diameter: 18mm
Stem Length: 14mm
Fits into 8mm Hole
Hyundai Equus, Genesis, Santa Fe &
Sonata and Kia K900, Optima & Sedona
2013 - On

UNIT PACKAGE: 15

PUSH-TYPE RETAINERS

Sec. 19

Refer to Retainer Specification Chart on pages 534-545
Listed smallest to largest by Head Diameter, Stem Length and then by Hole Diameter.



19453
(90505-SX0-003)
Black Nylon

Garnish Side Protector
Push-Type Retainer
Head Diameter: 18mm
Stem Length: 15mm
(Excluding the Pin)
Fits into 8mm Hole
Honda Odyssey 1995 - On

UNIT PACKAGE: 15



19416
(Toyota: 90467-09139)
Black Nylon

Bumper Cover & Wheel Housing
Push-Type Retainer
Head Diameter: 18mm
Stem Length: 15mm
Fits into 9mm Hole
Honda, Mazda 626 & Toyota Corolla 1992 - On

UNIT PACKAGE: 15



19246
(01553-09241)
Black Nylon

Bumper Push-Type Retainer
Head Diameter: 18mm
Stem Length: 15mm
Fits into 10mm Hole
Nissan 240SX & Maxima 1994 - On

UNIT PACKAGE: 15



19231
(91505-SL0-003)
Black Nylon

Push-Type Retainer
Head Diameter: 18mm
Stem Length: 12mm
Fits into 8mm Hole
Acura NSX 1991 - On

UNIT PACKAGE: 15



20988
(GM: 11589289;
Chrysler: 6508863-AA)
Black Nylon

Air Distributor & Windshield Defroster
Push-Type Retainer
Head Diameter: 18mm
Stem Length: 17.5mm
Panel Range: 2.0mm - 4.5mm
Fits into 6.5mm Hole
Buick Enclave, Chevrolet Equinox,
Chevrolet & GMC S & T Trucks, GMC
Acadia and Pontiac Torrent 2002 - On

UNIT PACKAGE: 25



16726
(N808048S, W705532-S300)
Black Nylon

Front Bumper Stone Deflector Retainer
Head Diameter: 18mm
Stem Length: 18mm
Fits into 6.3mm (1/4") Square Hole
Ford Bronco, Ranger & Explorer 1989 - On

UNIT PACKAGE: 25



20545
(N811283-S)
Black Nylon & Santoprene Rubber

Trim Panel Push-Type Retainer
Head Diameter: 18mm
Stem Length: 18mm
Fits into 6.3mm Hole
Ford Expedition & Navigator 1997 - On

UNIT PACKAGE: 25



21098
(Chrysler: 6508197-AA;
Ford: W706092-S300)
Black Nylon

Front Air Shield, Splash Guard &
Heat Shield Push-Type Retainer
Head Diameter: 18mm
Stem Length: 18mm
Fits into 6.4mm Hole
Dodge Ram 2006 - On
Ford Taurus 2008 - On

UNIT PACKAGE: 25



22354
(Chrysler: 6510139-AA)
Black Nylon

Exterior Trim,
Floor, Pillar &
Quarter Panel Push-Type Retainer
Head Diameter: 18mm
Stem Length: 18mm
Fits into 7mm Hole
Dodge Challenger & Charger 2011 - On

UNIT PACKAGE: 25



21089
(W710250-S300)
Black Nylon

Rear Bumper Push-Type Retainer
Head Diameter: 18mm
Stem Length: 18mm
Fits into 8mm Hole
Ford Edge 2007 - On

UNIT PACKAGE: 25

Sec. 19

PUSH-TYPE RETAINERS

Refer to Retainer Specification Chart on pages 534-545

Listed smallest to largest by Head Diameter, Stem Length and then by Hole Diameter.



20367
(W706713-S300)
Black Nylon

Bumper Cover
Push-Type Retainer
Head Diameter: 18mm
Stem Length: 18mm
Fits into 8mm Hole
Ford Escape 2001 - On

UNIT PACKAGE: 25



19849
(Not Available from O.E.M.)
Black Nylon & Santoprene Rubber

Bumper Push-Type Retainer
Head Diameter: 18mm
Stem Length: 18mm
Fits into 8mm Hole
Ford Taurus & Sable 2000 - On

UNIT PACKAGE: 25



21876
(Renault & Dacia: 05-40-000-1R;
Nissan: 01515-00Q0C)
Black Nylon

Bumper Push-Type Retainer
Head Diameter: 18mm
Stem Length: 18mm
Fits into 9mm Hole
Renault, Dacia & Nissan

UNIT PACKAGE: 15



21123
(75867-30120)
Black Nylon

Rocker Moulding Push-Type Retainer
Head Diameter: 18mm
Stem Length: 19mm
Fits into 8mm Hole
Lexus GS350, GS430, GS460 & LS460
and Toyota Camry 2007 - On

UNIT PACKAGE: 15



21672
(11611110)
Black Nylon

Cowl Vent Push-Type
Retainer with Sealer
Head Diameter: 18mm
Stem Length: 20mm
Fits into 6.3mm Hole
Buick Allure & LaCrosse and
Chevrolet Volt 2010 - On

UNIT PACKAGE: 15



20880
(GM:11589290; Chry.: 6509049AA)
Black Nylon

Air Inlet Grille, Bumper Fascia &
Front Brake Caliper Cooling Duct
Push-Type Retainer
Head Diameter: 18mm
Stem Length: 20mm
Panel Range: 4.5mm - 7.0mm
Fits into 6.5mm Hole

Buick Enclave, Cadillac, CTS & STS,
Chevrolet Cobalt, Equinox & SSR, GM Trucks and
Pontiac G5 & Torrent 2002 - On
Chrysler Charger & 300 2011 - On

UNIT PACKAGE: 50



22227
(Ford: W718088-S300)
Black Nylon

Fender Apron
Push-Type Retainer
Head Diameter: 18mm
Stem Length: 20mm
Fits into 7mm Hole
Ford Fusion 2015 - On

UNIT PACKAGE: 25



20966
(5160260-AA)
Black Nylon

Rear Bumper, Tail Light &
Fender Push-Type Retainer
Bottom Head Diameter: 18mm
Stem Length: 20mm
Fits into 8mm Hole
Dodge Caliber and Jeep
Compass & Patriot 2007 - On

UNIT PACKAGE: 15



20613
(63848-40Y00)
Black Nylon

Front Bumper Push-Type Retainer
Head Diameter: 18mm
Stem Length: 20mm
Fits into 9mm Hole
Nissan Frontier & Xterra 1998 - On

UNIT PACKAGE: 15



22049
(Mazda: B27K-51-PS7)
Black Nylon

Headlight Bracket Push-Type Retainer
Head Diameter: 18mm
Stem Length: 20mm
Fits into 9mm Hole
Mazda 3, CX-7, CX-9, Miata, MPV & RX-8
2000 - On

UNIT PACKAGE: 15

PUSH-TYPE RETAINERS

Sec. 19

Refer to Retainer Specification Chart on pages 534-545
Listed smallest to largest by Head Diameter, Stem Length and then by Hole Diameter.



20888

(GM: 11561368;
Chrysler: 6508712AA)
Black Nylon

Fender, Wheel & Bumper
Push-Type Retainer
Head Diameter: 18mm
Stem Length: 20mm
Panel Range: 3.0mm - 5.8mm
Fits into 9.5mm Hole
Chevrolet Impala & Monte Carlo and
Pontiac Grand Prix & Solstice 2004 - On
Jeep Wrangler 2000 - On

UNIT PACKAGE: 25



17057

(90505-SM4-003)
Black Nylon

Push-Type Retainer
Head Diameter: 18mm
Stem Length: 21mm
Fits into 8mm Hole
Honda Accord 1990 - On

UNIT PACKAGE: 10



20989

(GM: 11589291;
Ford: W713331-S300)
Black Nylon

Air Dam & Grille Push-Type Retainer
Head Diameter: 18mm
Stem Length: 22mm
Panel Range: 7.0mm - 9.5mm
Fits into 6.5mm Hole
Cadillac CTS, SRX, and STS 2003 - On

UNIT PACKAGE: 25



21529

(95230842)
Black Nylon

Cowl Vent Push-Type
Retainer with Sealer
Head Diameter: 18mm
Stem Length: 22mm
Fits into 6.5mm Hole
Chevrolet Cruze 2011 - On

UNIT PACKAGE: 15



20327

(63848-9E001)
Black Nylon

Bumper Fascia Push-Type Retainer
Head Diameter: 18mm
Stem Length: 22mm
Fits into 9mm Hole
Nissan Altima 1997 - On

UNIT PACKAGE: 10



14018

(N803716-S)
Black Nylon

Fascia Retainer
Head Diameter: 18mm
Stem Length: 23mm
Fits into 7mm Hole
Ford Mustang/Capri 1985 - On

UNIT PACKAGE: 25



22219

(GM: 92138636)
Black Nylon

Air Baffle Push-Type Retainer
Head Diameter: 18mm
Stem Length: 23mm
Fits into 7.5mm Hole
Chevrolet Caprice 2013 - 2012
Pontiac G8 and GTO 2009 - 2004

UNIT PACKAGE: 25



18939

(90467-09101)
Black Nylon

Bumper Cover
Push-Type Retainer
Head Diameter: 18mm
Stem Length: 23mm
Fits into 9mm Hole
Lexus ES300 1993 - On

UNIT PACKAGE: 25



16622

(10157900,
11517803, 15993201)
Black Nylon

Front Bumper Fascia Retainer
Head Diameter: 18mm
Stem Length: 23mm
Fits into 9.5mm (3/8") Hole
Olds Cutlass 1990 - On
GM Lt. Truck 1996 - On

UNIT PACKAGE: 25



20631

(11588988)
Black Nylon

Front Bumper Cover Push-Type Retainer
Head Diameter: 18mm
Stem Length: 26mm
Fits into 10mm Hole
Pontiac Grand Prix 2004 - On

UNIT PACKAGE: 25

Sec. 19**PUSH-TYPE RETAINERS**

Refer to Retainer Specification Chart on pages 534-545

Listed smallest to largest by Head Diameter, Stem Length and then by Hole Diameter.

**20359**
(11519444)
Black NylonBumper Cover Push-Type Retainer
Head Diameter: 18mm
Stem Length: 26mm
Fits into 10mm Hole
Oldsmobile Intrigue, Pontiac Aztek &
Grand Prix 1997 - On

UNIT PACKAGE: 25

**20768**
(4806240AA)
Black NylonRear Bumper Push-Type Retainer
Large Head Diameter: 18.5mm
Stem Length: 21mm
Fits into 8mm Hole
Chrysler 300 & Dodge Magnum
2005 - On

UNIT PACKAGE: 10

**18873**
(52161-16010, 52161-02020)
Black NylonRear Bumper Cover
Push-Type Retainer
Head Diameter: 18mm
Stem Length: 28mm
Fits into 9mm Hole
Toyota Tercel 1988 - On

UNIT PACKAGE: 6

**21201**
(90467-07211)
Black NylonBumper, Radiator Cover &
Grille Push-Type Retainer
Head Diameter: 19mm
Stem Length: 8mm
Fits into 7mm Hole
Lexus IS & LS, Scion and Toyota Avalon,
Camry & Highlander 2005 - On

UNIT PACKAGE: 10

**20931**
(52161-20010)
Black NylonBumper Cover & Grille
Push-Type Retainer
Head Diameter: 18mm
Stem Length: 31mm
Fits into 9mm Hole
Toyota 2000 - On

UNIT PACKAGE: 15

**21525**
(53259-0E010)
Black NylonFront Inner Structure Push-Type Retainer
Head Diameter: 19mm
Stem Length: 9mm
Fits into 7mm Hole
Lexus EX 350, IS 250, IS 350, RX 330,
RX350 and RX 400H 2004 - On

UNIT PACKAGE: 15

**19422**
(6504521)
Black NylonFascia Push-Type Retainer
Head Diameter: 23/32" (18.3mm)
Stem Length: 29/32" (23mm)
Fits into 5/16" (8mm) Hole
Chrysler LHS, Concorde, Intrepid &
Eagle Vision 1998 - On

UNIT PACKAGE: 25

**22248**
(Land Rover: DYQ500060)
Black NylonExterior Pillar Moulding
Push-Type Retainer
Top Head Diameter: 19mm
Bottom Head Diameter: 13mm
Stem Length: 12mm
Fits into 8mm Hole
Range Rover Sport 2012 - 2006

UNIT PACKAGE: 25

**21479**
(701-867-299)
Gray NylonFront Bumper & Interior Trim
Push-Type Retainer
With 3mm Allen Head Drive
Head Diameter: 18.5mm
Stem Length: 11mm
Fits into 9mm Hole
VW Jetta & Passat 1999 - On

UNIT PACKAGE: 25

**13469**
(N802737-S)
Black NylonUnder Hood Retainer
Head Diameter: 3/4" (19mm)
Stem Length: 1/2" (12.7mm)
Fits into 1/4" (6.4mm) Hole
Ford Tempo & Topaz

UNIT PACKAGE: 25

PUSH-TYPE RETAINERS

Sec. 19

Refer to Retainer Specification Chart on pages 534-545
Listed smallest to largest by Head Diameter, Stem Length and then by Hole Diameter.



20826
(11609417)
Black Nylon

Fender Apron Push-Type Retainer
Head Diameter: 19mm
Stem Length: 14mm
Panel Range: 2.7mm - 5.3mm
Fits into 8.5mm Hole

Buick Enclave & LaCrosse, Cadillac CTS, SRX & STS,
Chevrolet Cobalt, Equinox & Malibu, GM Trucks and
Pontiac G5, G6 & Torrent 2003 - On

UNIT PACKAGE: 50



20990
(GM: 15296830;
Chrysler: 5116530-AA)
Black Nylon

Fascia & General Purpose
Push-Type Retainer
Head Diameter: 19mm
Stem Length: 16mm
Panel Range: 5.0mm - 7.0mm
Fits into 8mm Hole
GM 2007 - On

UNIT PACKAGE: 25



11706
(387944-S)
Black Nylon

Grille to Metal Stamping Retainer
Head Diameter: 3/4" (19mm)
Shoulder Length: 1/4" (6.4mm)
Stem Length: 11/16" (17.5mm)
Fits into 1/4" (6.4mm) Wide Slot
Ford Truck 1978 - On

UNIT PACKAGE: 50



20273
(Ford: N808791;
Chrysler: 5GC71RC3AA, 5GF92RC3AA)
Gray Nylon

Interior Trim, Dash & Console
Push-Type Retainer
Head Diameter: 19mm
Shoulder Diameter: 10mm
Shoulder Length: 7mm
Stem Length: 22mm
Fits into 9mm Hole
Dodge Durango &
Ford Pick-Ups 1997 - On

UNIT PACKAGE: 25



17988
(90467-09143)
Black Nylon

Push-Type Retainer
Head Diameter: 19mm
Stem Length: 26mm
Fits into 9mm Hole
Lexus 1990 - On

UNIT PACKAGE: 10



22126
(Toyota: 53384-68010)
Black Nylon

Front Grille Push-Type Retainer
Rubber Head Diameter: 19mm
Bottom Head Diameter: 18mm
Stem Length: 28mm
Fits into 9mm Hole
Scion tC & Toyota RAV4 2005 - On

UNIT PACKAGE: 15



19245
(5BB14LX9)
Black Nylon

Fascia to Front Bumper
Push-Type Retainer
Top Head Diameter: 3/4" (19mm)
Stem Length: 1-1/8" (28.5mm)
Fits into 1/4" (6.4mm) Hole
Dodge Dakota 1994 - On

UNIT PACKAGE: 25



18308
(3540858)
Black Nylon

Radiator Air Baffle
Push-Type Retainer
Large Head
Diameter: 3/4" (19mm)
Stem Length: 1-1/8" (28.5mm)
Fits into 1/4" (6.4mm) Hole
Cadillac Eldorado & Seville 1993 - On

UNIT PACKAGE: 25

Sec. 19**PUSH-TYPE RETAINERS**

Refer to Retainer Specification Chart on pages 534-545

Listed smallest to largest by Head Diameter, Stem Length and then by Hole Diameter.

**20244**
(25707329)
Green NylonPush-Type Retainer with Sealer
Head Diameter: 19mm
Stem Length: 32mm
Fits into 8mm Hole
Buick LeSabre, Oldsmobile Aurora
& Pontiac Bonneville 2000 - On

UNIT PACKAGE: 10

**19907**
(90467-07121-B2)
NylonDoor Trim Panel
Push-Type Retainer
Head Diameter: 20mm
Stem Length: 8mm (Excluding the Pin)
Fits into 7mm Hole
Toyota RAV4 1997 - On

UNIT PACKAGE: 10

**20755**
(GD7A-50-EA1)
Black NylonBumper Cover & Grille
Push-Type Retainer
Head Diameter: 19.5mm
Stem Length: 15mm
Fits into 10mm Hole
Mazda 1999 - On

UNIT PACKAGE: 10

**18888**
(90467-07166)
Black NylonFront Fender Liner Push-Type Retainer
Head Diameter: 20mm
Stem Length: 8mm (Excluding the Pin)
Fits into 7mm Hole
Toyota Tercel 1994 - On

UNIT PACKAGE: 15

**21568**
(57160FC000)
Black NylonFront Fender Push-Type Retainer
Top Head Length: 19.5mm
Bottom Head Diameter: 14mm
Stem Length: 15mm
Fits into 10mm Hole
Subaru Forester 2008 - 1998

UNIT PACKAGE: 25

**21631**
(84995-35101)
Black NylonPush-Type Retainer
Head Diameter: 20mm
Stem Length: 8mm (Excluding the Pin)
Fits into 8mm Hole
Nissan Sentra 2007 - On

UNIT PACKAGE: 15

**20577**
(GM: 88970494, 88973676;
Toyota: 90467-07168)
Black NylonRocker Panel & Garnish Moulding
Push-Type Retainer
Head Diameter: 20mm
Stem Length: 8mm (Excluding the Pin)
Fits into 7mm Hole
Pontiac Vibe 2003 - On
Lexus & Toyota 2000 - On

UNIT PACKAGE: 15

**19905**
(01553-10051)
Black NylonPush-Type Retainer
Head Diameter: 20mm
Stem Length: 8mm (Excluding the Pin)
Fits into 8mm Hole
Nissan Maxima 1999 - On

UNIT PACKAGE: 15

**19908**
(90467-07121)
Black NylonDoor Trim Panel
Push-Type Retainer
Head Diameter: 20mm
Stem Length: 8mm (Excluding the Pin)
Fits into 7mm Hole
Toyota RAV4 1997 - On

UNIT PACKAGE: 10

**14369**
(1395-68-676, 9926-50-635)
Black NylonPush-Type Retainer
Head Diameter: 20mm
Stem Length: 9mm
Fits into 6mm Hole
Mazda

UNIT PACKAGE: 15

PUSH-TYPE RETAINERS

Sec. 19

Refer to Retainer Specification Chart on pages 534-545
Listed smallest to largest by Head Diameter, Stem Length and then by Hole Diameter.



19128
(90467-07044)
Black Nylon

Quarter Panel Wheel Opening
Moulding Push-Type Retainer
Head Diameter: 20mm
Stem Length: 9mm
Fits into 7mm Hole
Toyota T-100 1992 - On

UNIT PACKAGE: 10



19315
(BC1D-56-145)
Black Nylon

Mud Guard Push-Type Retainer
Head Diameter: 20mm
Stem Length: 9mm (Excluding the Pin)
Fits into 8mm Hole
Mazda Protege 1996 - On

UNIT PACKAGE: 15



21294
(90467-07214)
Black Nylon

Radiator Splash Shield
Push-Type Retainer
Head Diameter: 20mm
Stem Length: 9mm
Fits into 7mm Hole
Toyota Camry 2007 - On

UNIT PACKAGE: 25



17379
(91512-SM4-003)
Black Nylon

Fender Splash Shield
Push-Type Retainer
Head Diameter: 20mm
Stem Length: 9mm
Fits into 8mm Hole
Honda Accord 1990 - On

UNIT PACKAGE: 10



20270
(51-48-1-938-725)
Black Nylon

Hood & Trunk Insulation
Push-Type Retainer
Head Diameter: 20mm
Stem Length: 9mm
Fits into 7mm Hole
BMW Series 3, 5, & 7 2001 - 84

UNIT PACKAGE: 25



20637
(123-990-02-92)
Black Nylon

Push-Type Retainer
Head Diameter: 20mm
Stem Length: 9mm
Fits into 8mm Hole
Mercedes-Benz

UNIT PACKAGE: 10



21422
(909140051)
Black Nylon

Front Bumper & Quarter Panel
Push-Type Retainer
Head Diameter: 20mm
Stem Length: 9mm (Excluding the Pin)
Fits into 7mm Hole
Subaru Impreza, Legacy,
Outback & Tribeca 2005 - On

UNIT PACKAGE: 15



19274
(01553-09321)
Black Nylon

Push-Type Retainer
Head Diameter: 20mm
Stem Length: 9mm (Excluding the Pin)
Fits into 8mm Hole
Nissan Maxima & 300ZX 1994 - On

UNIT PACKAGE: 15



16000
(Honda: 90675-SB3-003;
Mazda: FB01-56-964;
Nissan: 63876-95596)
Black Nylon

Push-Type Retainer
Head Diameter: 20mm
Stem Length: 9mm
Fits into 8mm Hole
Honda, Mazda & Nissan

UNIT PACKAGE: 25



21010
(90467-09166)
Black Nylon

Push-Type Retainer
Head Diameter: 20mm
Stem Length: 9mm
Fits into 9mm Square Hole
Toyota Camry 2006 - On

UNIT PACKAGE: 15

Sec. 19

PUSH-TYPE RETAINERS

Refer to Retainer Specification Chart on pages 534-545

Listed smallest to largest by Head Diameter, Stem Length and then by Hole Diameter.



21973
(Peugeot & Citroen: 1539.16)
Tan Nylon

Push-Type Retainer
Head Diameter: 20mm
Stem Length: 10mm
Fits into 6mm Hole
Peugeot & Citroen

UNIT PACKAGE: 10



21651
(91501-TR0-003)
Black Nylon

Fender Push-Type Retainer
Head Diameter: 20mm
Stem Length: 10mm
Fits into 8mm Hole
Honda Civic 2012 - On

UNIT PACKAGE: 25



20908
(90467-07164)
Black Nylon

Fender Splash Shield
Push-Type Retainer
Head Diameter: 20mm
Stem Length: 10mm
Fits into 7mm Hole
Toyota Camry, Echo, MR2 &
Sienna 1997 - On

UNIT PACKAGE: 10



21086
(203-990-01-92)
Black Nylon

Hood Insulation Push-Type Retainer
Head Diameter: 20mm
Stem Length: 10mm
Fits into 8mm Hole
Mercedes-Benz GL, M, R, SL & SLK
2005 - On

UNIT PACKAGE: 15



21571
(59122FA010)
Black Nylon

Front Bumper, Fender,
Windshield Washer & Rocker
Moulding Push-Type Retainer
Head Diameter: 20mm
Stem Length: 10mm
Fits into 8mm Hole
Subaru B9 Tribeca, Baja, Forester,
Impreza, Legacy & Outback 1998 - On

UNIT PACKAGE: 25



22306
(Mercedes: 000-991-49-40-M58)
Black Nylon

Lower Engine Cover, Interior Trim &
Trunk Cover Liner Push-Type Retainer
Head Diameter: 20mm
Stem Length: 10mm
Fits into 8mm Hole
Mercedes-Benz C300, C400, C63,
CLS400, CLS550, CLS63, GLK250,
GLK350, S550, S63 & S65 2015 - On

UNIT PACKAGE: 15



22270
(Subaru: 909140068)
Black Nylon

Front Fender Push-Type Retainer
Head Diameter: 20mm
Stem Length: 10mm
Fits into 8mm Hole
Subaru BRZ, Impreza, Legacy,
Outback & XV Crosstrek 2012 - On

UNIT PACKAGE: 15



21811
(Peugeot & Citroen: 8211.WV)
Black Nylon

Push-Type Retainer
Head Diameter: 20mm
Stem Length: 10mm
Fits into 8mm Hole
Peugeot & Citroen

UNIT PACKAGE: 25



19118
(91501-S04-003)
Black Nylon

Front Fender Push-Type Retainer
Head Diameter: 20mm
Stem Length: 10mm
Fits into 8mm Hole
Honda Civic & Del Sol 1993 - On

UNIT PACKAGE: 15



21594
(909130051)
Black Nylon

Fender Liner, Duct & Lower
Moulding Push-Type Retainer
Head Diameter: 20mm
Stem Length: 11mm
Fits into 7mm Hole
Subaru B9 Tribeca, Forester,
Impreza, Legacy & Outback 2005 - On

UNIT PACKAGE: 15

PUSH-TYPE RETAINERS

Sec. 19

Refer to Retainer Specification Chart on pages 534-545
Listed smallest to largest by Head Diameter, Stem Length and then by Hole Diameter.



21592
(909140052)
Black Nylon

Push-Type Retainer
Head Diameter: 20mm
Stem Length: 11mm
Fits into 7mm Hole
Subaru B9 Tribeca, Impreza,
Legacy & Outback 2005 - On

UNIT PACKAGE: 15



21580
(59122AC030)
Black Nylon

Front Fender Push-Type Retainer
Head Diameter: 20mm
Stem Length: 12mm
Fits into 7mm Hole
Subaru B9 Tribeca, Baja, Forester Legacy
& Outback 1995 - On

UNIT PACKAGE: 25



19239
(Honda: 91512-SX0-003;
Mitsubishi: MU000319)
Black Nylon

Front Fender & Bumper Support
Push-Type Retainer
Head Diameter: 20mm
Stem Length: 11mm
Fits into 8mm Hole
Acura 3.5RL, Honda Accord,
Prelude & Odyssey 1994 - On
Mitsubishi Lancer 2002 - On

UNIT PACKAGE: 25



21500
(909140063)
Black Nylon

Cowl Vent Push-Type Retainer
Head Diameter: 20mm
Stem Length: 12mm
Fits into 7mm Hole
Subaru Legacy & Outback 2010 - On

UNIT PACKAGE: 10



17347
(01553-06721)
Black Nylon

Front & Rear Bumper
Cover Push-Type Retainer
Head Diameter: 20mm
Stem Length: 11mm (Excluding the Pin)
Fits into 8mm Hole
Nissan Maxima & Infiniti 1990 - On

UNIT PACKAGE: 15



21192
(Nissan: 01553-05323)
(Mazda: L33X13209)
Black Nylon

Cowl, Bumper & Fender Liner
Push-Type Retainer
Head Diameter: 20mm
Stem Length: 12mm
Fits into 8mm Hole
Infiniti FX35, FX45, G35 and Nissan 2003 - On
Mazda 2, 3, 5, 6, CX-5, CX-7 & CX-9 2007 - On

UNIT PACKAGE: 10



21297
(91503-S7A-003)
Black Nylon

Front Bumper Push-Type Retainer
Head Diameter: 20mm
Stem Length: 11mm
Fits into 10mm Hole
Honda Civic 2010 - On

UNIT PACKAGE: 15



22039
(Nissan: 01553-2DR9A)
Black Nylon

Push-Type Retainer
Top Head Diameter: 16mm x 19mm
Bottom Head Diameter: 20mm
Stem Length: 12mm
Fits into 8mm Hole
Infiniti G20, JX35, Q45 & QX60 and
Nissan Frontier, Maxima, NV, Pathfinder,
Sentra, Versa & Xterra 2002 - On

UNIT PACKAGE: 15



17992
(90467-07138)
Black Nylon

Push-Type Retainer
Head Diameter: 20mm
Stem Length: 12mm
Fits into 7mm Hole
Lexus 1990 - On

UNIT PACKAGE: 10



21856
(Toyota: 51454-48010, 51454-0E010)
Black Nylon

Front Bumper Extension Mounting
Bracket Push-Type Retainer
Head Diameter: 20mm
Stem Length: 12mm
Fits into 10mm Hole
Lexus IS CV, F, RX330 & RX400 Hybrid 2006 - On
Toyota Highlander, Sienna & Venza 2009 - On

UNIT PACKAGE: 15

Sec. 19

PUSH-TYPE RETAINERS

Refer to Retainer Specification Chart on pages 534-545

Listed smallest to largest by Head Diameter, Stem Length and then by Hole Diameter.



22100

(GM: 11612035)
Black Nylon

Front Fender &
Body Side Liner
Push-Type Retainer
Head Diameter: 20mm
Stem Length: 12mm
Fits into 8.5mm Hole
Chevrolet Colorado & SS and
GMC Canyon 2014 - On

UNIT PACKAGE: 25



22112

(Honda: 91512-STK-A01)
Black Nylon

Garnish & Rear Spoiler
Push-Type Retainer with Sealer
Head Diameter: 20mm
Stem Length: 13mm
Fits into 8.5mm Hole
Acura RDX & TSX and Honda Accord,
CR-V & Odyssey 2011 - On

UNIT PACKAGE: 10



20953

(11296-AG000)
Black Nylon

Front Bumper & Radiator Support
Push-Type Retainer
Head Diameter: 20mm
Stem Length: 13mm
Fits into 8mm Hole
Infiniti FX 35/45 and Nissan Altima,
Maxima & Quest 2002 - On

UNIT PACKAGE: 25



22068

(Honda: 91513-SJK-003)
White Nylon

Rocker, Pillars, Spoiler, Garnish & Exterior
Trim Push-Type Retainer with Sealer
Head Diameter: 20mm
Stem Length: 13mm
Fits into 8.5mm Hole
Acura MDX, RLX, TSX & ZDX and Honda
Accord, Civic, CR-V, Element,
Fit, Insight & Pilot 2007 - On

UNIT PACKAGE: 15



22069

(Honda: 91512-SJK-003)
White Nylon

Rocker, Pillars, Garnish & Exterior Trim
Push-Type Retainer with Sealer
Head Diameter: 20mm
Stem Length: 13mm
Fits into 8.5mm Hole
Acura ZDX 2013 - 2010
Honda Odyssey & Pilot 2005 - On

UNIT PACKAGE: 15



20516

(W706182-S300)
Black Nylon

Headlight Mounting &
Deck Lid Push-Type Retainer
Head Diameter: 20mm
Hex: 10mm
Stem Length: 13mm
Fits into 8mm Hole
Ford Expedition, Explorer &
Focus 2000 - On

UNIT PACKAGE: 25



20986

(91505-S9A-003)
Black Nylon

Front Bumper Push-Type Retainer
with Internal Metal Insert
Head Diameter: 20mm
Stem Length: 13mm
Fits into 10mm Hole
Honda Civic 2006 - On

UNIT PACKAGE: 10



21812

(Peugeot & Citroen: 16-092-672-80;
Renault: 77-03-072-416)
Black Nylon

Push-Type Retainer
Rectangular Head Size: 9mm x 20mm
Head Diameter: 20mm
Stem Length: 13mm
Fits into 8mm Hole
Renault, Dacia, Peugeot and Citroen

UNIT PACKAGE: 25



19233

(91503-SZ3-003)
Black Nylon

Front Bumper Push-Type Retainer
Head Diameter: 20mm
Stem Length: 13mm
Fits into 10mm Hole
Acura 3.5RL Sedan & Honda 1996 - On

UNIT PACKAGE: 15

PUSH-TYPE RETAINERS

Sec. 19

Refer to Retainer Specification Chart on pages 534-545
Listed smallest to largest by Head Diameter, Stem Length and then by Hole Diameter.



21454
(91503-SHJ-A01)
Black Nylon

Front Bumper Push-Type Retainer
Head Diameter: 20mm
Stem Length: 13mm
Fits into 10mm Hole
Honda Odyssey 2010 - 05

UNIT PACKAGE: 10



16782
(Honda: 91545-SE0-003-W1;
Nissan: 63848-01G00)
Black Nylon

Push-Type Retainer
Head Diameter: 20mm
Stem Length: 8mm (Excluding the Pin)
Fits into 8mm Hole

UNIT PACKAGE: 25



21134
(01553-09431)
Black Nylon

Front Bumper Push-Type Retainer
Head Diameter: 20mm
Stem Length: 11mm (Excluding the Pin)
Fits into 8mm Hole
Nissan Maxima 2004 - On

UNIT PACKAGE: 15



21883
(Peugeot & Citroen: 6991.X7)
Black Nylon

Bumper Push-Type Retainer
Head Diameter: 20mm
Stem Length: 14mm
Fits into 8mm Hole
Peugeot & Citroen

UNIT PACKAGE: 25



20638
(BMW: 51471911992,
51470146782, 51470390017
Mercedes-Benz: 201-990-02-92)
Black Nylon

Push-Type Retainer
Head Diameter: 20mm
Stem Length: 14mm
Fits into 8.5mm Hole
BMW 1, 2, 3, 4, 5, 6, 7, i3, i8, X &
Z Series 1988 - On
Mercedes-Benz

UNIT PACKAGE: 25



20608
(91503-S0K-A01)
Black Nylon

Grille Mounting Push-Type Retainer
Head Diameter: 20mm
Stem Length: 14mm
Fits into 10mm Hole
Honda Element 2003 - On

UNIT PACKAGE: 15



21706
(Honda: 91505-TM8-003)
Black Nylon

Bumper and Wheel Well Liner
Push-Type Retainer
Head Diameter: 20mm
Stem Length: 14mm
Fits into 10mm Hole
Acura ILX and Honda Insight 2012 - On

UNIT PACKAGE: 15



20734
(51-11-1-944-537)
Black Nylon

Bumper, Wheel Opening, Scuff Plate &
Interior Trim Push-Type Retainer
Head Diameter: 20mm
Stem Length: 15mm
Fits into 6.3mm Hole
BMW Series 3, 5, 7 & X5 1989 - On

UNIT PACKAGE: 50



21545
(01553-08231)
Black Nylon

Front & Rear Bumper and
Grille Push-Type Retainer
Head Diameter: 20mm
Stem Length: 15mm
Fits into 8mm Hole
Infinity FX35, FX45 & Q45 and Nissan
Murano, 240 SX & 350Z 1995 - On

UNIT PACKAGE: 25



17350
(Honda: 91516-SK7-013;
Nissan: 01553-00-344)
Black Nylon

Splash Shield Push-Type Retainer
Phillips Drive
Head Diameter: 20mm
Hex: 10mm
Stem Length: 15mm
Fits into 8mm Hole
Honda Civic 1992 - On
Nissan Xterra, Frontier & Quest 1999 - On

UNIT PACKAGE: 10

Sec. 19

PUSH-TYPE RETAINERS

Refer to Retainer Specification Chart on pages 534-545

Listed smallest to largest by Head Diameter, Stem Length and then by Hole Diameter.



17267

(91503-SP0-003)
Black Nylon

Front & Rear Bumper
Push-Type Retainer
Head Diameter: 20mm
Stem Length: 15mm
Fits into 10mm Hole
Acura Legend 1991 - On

UNIT PACKAGE: 15



21173

(91506-S9A-003)
Black Nylon

Bumper & Splash Shield
Push-Type Retainer with Metal Insert
Head Diameter: 20mm
Stem Length: 16mm
Fits into 10mm Hole
Acura MDX, RDX & TSX and Honda
Accord, Civic CR-V & Fit 2009 - 04

UNIT PACKAGE: 10



21563

(909130059)
Black Nylon

Front Bumper & Fender
Push-Type Retainer
Head Diameter: 20mm
Stem Length: 15mm
Fits into 10mm Hole

Subaru Forester, Impreza & Outback 2006 - 02

UNIT PACKAGE: 25



20766

(6507669-AA)
Black Nylon

Radiator Grille Push-Type Retainer
Head Diameter: 20mm
Stem Length: 16mm
Fits into 10mm Hole
Dodge Durango 2004 - On

UNIT PACKAGE: 25



21781

(BMW: 51-71-8-259-788;
51-71-0-391-077)
Black Nylon

Rocker Panel, Air Duct Compartment
& Wheel Housing Push-Type Retainer
Head Diameter: 20mm
Stem Length: 16mm
Fits into 6.3mm Hole
3, 5, 6, 7 & Z Series 1994 - On

UNIT PACKAGE: 25



20248

(51-11-8-174-185)
Black Nylon

Bumper Trim Push-Type Retainer
Head Diameter: 20mm
Stem Length: 17mm
Fits into 6.3mm Hole
BMW Series 3, 5 & 7 1995 - On

UNIT PACKAGE: 25



20388

(51218-205-295)
Black Nylon

Cowl Vent Push-Type Retainer
Head Diameter: 20mm
Stem Length: 16mm
Fits into 7mm Hole

Use with Auveco 20254
BMW Series 5 1997 - On

UNIT PACKAGE: 50



22052

(BMW: 51471919209)
Black Nylon

Interior Trim & Engine
Intake Duct Push-Type Retainer
Head Diameter: 20mm
Stem Length: 17mm
Fits into 6.3mm Hole
BMW 3, 5, 7, 8, X and Z Series 2012 - 1984

UNIT PACKAGE: 25



21596

(75867-06030)
Black Nylon

Rocker Panel Push-Type Retainer
Head Diameter: 20mm
Stem Length: 16mm
Fits into 8mm Hole
Toyota & Lexus 2007 - On

UNIT PACKAGE: 25



20458

(6506132-AA)
Black Nylon

Side Radiator Shield
Push-Type Retainer
Head Diameter: 20mm
Stem Length: 17mm
Fits into 7mm Hole
Chrysler Sebring & Stratus 2001 - On

UNIT PACKAGE: 25

PUSH-TYPE RETAINERS

Sec. 19

Refer to Retainer Specification Chart on pages 534-545
Listed smallest to largest by Head Diameter, Stem Length and then by Hole Diameter.



16858

(Nissan: 63844-01A00;
Kia: MNA01-56-145;
Mazda: NA01-56-145;
Ford: MNA01-56145, NA01-56145)
Black Nylon

Inner Fender Push-Type Retainer
Head Diameter: 20mm (25/32")
Stem Length: 18mm (23/32")
Fits into 8mm (5/16") Hole
Nissan 1980 - On
Mazda, Kia & Ford

UNIT PACKAGE: 25



20564

(91503-SZ5-003)
Black Nylon

Front & Rear Bumper
Push-Type Retainer
Head Diameter: 20mm
Stem Length: 18mm
Fits into 10mm Hole

Acura 3.5RL and Honda Accord & Odyssey 1996 - On

UNIT PACKAGE: 15



21119

(B100-68-675-69)
Black Nylon

Push-Type Retainer
Head Diameter: 20mm
Stem Length: 19mm
Fits into 6mm Hole

Ford Probe and Mazda MX6 1988 - On

UNIT PACKAGE: 15



17472

(Mitsubishi: MB547806;
Nissan: 63854-01A00)
Black Nylon

Front Bumper Fascia
Push-Type Retainer
Head Diameter: 20mm
Stem Length: 20mm
Fits into 8mm Hole

Mitsubishi & Nissan 300ZX 1990 - On

UNIT PACKAGE: 15



17216

(GM: 21030249;
Ford: N807389S; Chrysler: 6503598)
Black Nylon

Air Baffle to Under Carriage
Push-Type Retainer
Head Diameter: 20mm
Stem Length: 20mm
Fits into 8mm Hole

GM Saturn 2 Door & 4 Door Models 1991 - On
Ford & Chrysler

UNIT PACKAGE: 25



20991

(11589292)
Black Nylon

Bumper Fascia, Flares & Air Dam
Push-Type Retainer
Head Diameter: 20mm
Stem Length: 20mm
Panel Range: 2.0mm - 4.5mm
Fits into 8.5mm Hole

Chevrolet and GMC C & K Trucks 2007 - On

UNIT PACKAGE: 25



16625

(10108746)
Black Nylon

Front Bumper Fascia Retainer
Head Diameter: 20mm
Stem Length: 20mm
Fits into 10mm Square Hole

GM Station Wagons 1991 - On

UNIT PACKAGE: 25



19140

(Acura: 90505-SL0-003;
GM: 94852368;
Mitsubishi: MB888869;
Toyota: 90467-08155)
Black Nylon

Push-Type Retainer
Head Diameter: 20mm
Stem Length: 21mm
Fits into 8mm Hole

Acura, Dodge Avenger, Eagle Talon, Geo Prizm,
Mitsubishi Eclipse & Galant and Toyota 1993 - On

UNIT PACKAGE: 5



21778

(BMW: 51-12-7-004-445)
Black Nylon

Rear Bumper Support Fixture Trim
Push-Type Retainer
Head Diameter: 20mm
Stem Length: 21mm
Fits into 8.5mm Hole

3, 5 & 6 Series 2002 - On

UNIT PACKAGE: 25



19615

(15153415)
Black Nylon

Rear Bumper Cover
Push-Type Retainer
Top Head Diameter: 20mm
Stem Length: 21mm
Fits into 9mm Hole

GM C & K Trucks 1999 - On

UNIT PACKAGE: 25

Sec. 19

PUSH-TYPE RETAINERS

Refer to Retainer Specification Chart on pages 534-545

Listed smallest to largest by Head Diameter, Stem Length and then by Hole Diameter.



20348

(63878-01E10)
Black Nylon

Push-Type Retainer
Head Diameter: 20mm
Stem Length: 22mm
Fits into 8mm Hole
Nissan Maxima 1994 - On

UNIT PACKAGE: 15



18119

(91502-SP0-003)
Black Nylon

Front & Rear Bumper
Push-Type Retainer
Head Diameter: 20mm
Stem Length: 25mm
Fits into 10mm Hole
Honda 1990 - On

UNIT PACKAGE: 10



20889

(GM: 11589293;
Ford: W712196-S300)
Black Nylon

Cowl Vent & Fender
Push-Type Retainer
Head Diameter: 20mm
Stem Length: 22mm
Panel Range: 4.5mm - 7.0mm
Fits into 8.5mm Hole

Buick Century, LaCrosse & Regal, Cadillac, Chevrolet
Equinox, GM Trucks & Hummer H3 and
Pontiac Grand Prix & Torrent 1997 - On
Ford 2006 - On

UNIT PACKAGE: 25



18951

(MR-138807)
Black Nylon

Front Bumper & Support
Push-Type Retainer
Head Diameter: 20mm
Stem Length: 26mm
Fits into 8mm Hole
Mitsubishi Eclipse 1994 - On

UNIT PACKAGE: 5



20992

(11589294)
Black Nylon

Bumper Fascia, Fender and Toe/Floor
Panel Push-Type Retainer
Head Diameter: 20mm
Stem Length: 24mm
Panel Range: 7.0mm - 10.0mm
Fits into 8.5mm Hole
Buick Enclave & LaCrosse, Chevrolet &
GMC C & K Trucks, GMC Acadia, Hummer
H3 and Saturn Outlook 2005 - On

UNIT PACKAGE: 25



20632

(GM: 11518017;
Ford: W708530-S300)
Black Nylon

Bumper Cover & Fender Shield
Push-Type Retainer
Head Diameter: 20mm
Stem Length: 26mm
Fits into 8mm Hole
GM & Ford 1997 - On

UNIT PACKAGE: 15



19739

(90467-09127)
Black Nylon

Bumper Cover Push-Type Retainer
Head Diameter: 20mm
Stem Length: 26mm
Fits into 9mm Hole
Toyota Avalon, Camry,
Corolla & Solara 1998 - On

UNIT PACKAGE: 10



17144

(91504-SM4-000)
Black Nylon

Bumper Fascia Push-Type Retainer
Head Diameter: 20mm
Stem Length: 24mm
Fits into 10mm Hole
Honda Accord 1990 - On

UNIT PACKAGE: 10



19408

Same as 17144 except for unit package quantity

UNIT PACKAGE: 50



22299

(Hyundai: 86590-35000)
Black Nylon

Bumper Cover
Push-Type Retainer
Head Diameter: 20mm
Stem Length: 26mm
Fits into 9.5mm Hole
Hyundai Tucson 2009 - 2005

UNIT PACKAGE: 25

PUSH-TYPE RETAINERS

Sec. 19

Refer to Retainer Specification Chart on pages 534-545
Listed smallest to largest by Head Diameter, Stem Length and then by Hole Diameter.



17143
(Honda: 91502-SM4-000;
Hyundai 86590-35000)
Black Nylon

Bumper Fascia Push-Type Retainer
Head Diameter: 20mm
Stem Length: 27mm
Fits into 10mm Hole
Honda Accord 1990 - On
Hyundai 2005 - On

UNIT PACKAGE: 10

19407

Same as 17143 except unit package quantity

UNIT PACKAGE: 50



18896
(21095797)
Black Nylon

Bumper Fascia
Push-Type Retainer
Head Diameter: 20mm
Stem Length: 28mm
Fits into 8mm Hole
GM Saturn 1996 - On

UNIT PACKAGE: 25



21420
(909140007)
Black Nylon

Bumper, Engine Cover, Fender & Grille
Push-Type Retainer
Head Diameter: 21mm
Stem Length: 15mm (Excluding the Pin)
Fits into 10mm Hole
Subaru Baja, Forester, Impreza, Legacy,
Outback & Tribeca 2000 - On

UNIT PACKAGE: 15



20457
(4857345-AA)
Black Nylon

Tail Light Housing
Push-Type Retainer
Large Head Diameter: 21mm
Stem Length: 23mm
Fits into 9.5mm Hole
Chrysler Caravan, Town & Country and
Voyager Mini Vans 2002 - On

UNIT PACKAGE: 25



16835
(GM: 10140480;
Chrysler: 6502625)
Black Nylon

Rear Bumper Fascia Retainer
Head Diameter: 21mm (27/32")
Shoulder Length: 3mm (1/8")
Stem Length: 25mm (1")
Fits into 12mm (1/2") Hole
GM APV Vans 1990 - On

UNIT PACKAGE: 25



14998
(15672330, 15956470)
Black Nylon

Push-Type Retainer
Head Diameter: 27/32" (21.4mm)
Stem Length: 1" (25.4mm)
Fits into 13/32" (10.3mm) Hole
GM 1987 - On

UNIT PACKAGE: 25



20739
(WX68DX9-AA)
Black Nylon

Door Trim Panel
Push-Type Retainer
Head Diameter: 22mm
Stem Length: 10mm (Excluding the Pin)
Fits into 9mm Hole
Chrysler 300 & Dodge Magnum 2005 - On

UNIT PACKAGE: 25



21021
(0WX68BD5-AA)
Dark Gray Nylon

Door Trim Panel
Push-Type Retainer
Head Diameter: 22mm
Stem Length: 10mm (Excluding the Pin)
Fits into 9mm Hole
Chrysler Charger, Magnum & 300M
2005 - On

UNIT PACKAGE: 25



21427
(0WX68XDB-AA)
Light Gray Nylon

Door Trim Panel
Push-Type Retainer
Head Diameter: 22mm
Stem Length: 10mm (Excluding the Pin)
Fits into 9mm Hole
Chrysler 300M, Charger & Magnum
2005 - On

UNIT PACKAGE: 25

Sec. 19

PUSH-TYPE RETAINERS

Refer to Retainer Specification Chart on pages 534-545

Listed smallest to largest by Head Diameter, Stem Length and then by Hole Diameter.



20948

(0WX68BD1-AA)
Tan Nylon

Door Trim Panel
Push-Type Retainer
Head Diameter: 22mm
Stem Length: 10mm (Excluding the Pin)
Fits into 9mm Hole
Chrysler 300M, Charger & Magnum
2005 - On

UNIT PACKAGE: 25



22101

(Audi: 4D0-807-300)
Black Nylon

Bumper, Fender & Hood
Insulation Push-Type Retainer
Head Diameter: 22mm
Stem Length: 12mm
Fits Into 7.5mm Hole
Audi A4, A5, A8, Q3, Q5 & S8 1997 - On

UNIT PACKAGE: 15



22095

(Audi: N90-229-301)
Black Nylon

Hood Insulation
Push-Type Retainer
Head Diameter: 22mm
Stem Length: 13mm
Fits into 8mm Hole
Audi & Volkswagen 1986 - On

UNIT PACKAGE: 25



20863

(5480772)
Black Nylon

Lower Rocker Moulding
Push-Type Retainer
Head Diameter: 22mm
Stem Length: 13mm (Excluding the Pin)
Fits into 15mm Hole
Chevrolet Equinox 2005 - On

UNIT PACKAGE: 10



21810

(Peugeot & Citroen: 6997.T2)
Black Nylon

Push-Type Retainer
Head Diameter: 22mm
Stem Length: 14mm
Fits into 6.3mm Hole
Peugeot & Citroen

UNIT PACKAGE: 25



17378

(01553-03101)
Black Nylon

Bumper & Fascia
Push-Type Retainer
Head Diameter: 22mm
Stem Length: 14mm (Excluding the Pin)
Fits into 11mm Hole
Nissan 1986 - On

UNIT PACKAGE: 15



21860

(Toyota: 51453-48010, 51453-0E010)
Black Nylon

Front Side Lower Fender Panel
Bracket Push-Type Retainer
Head Diameter: 22mm
Stem Length: 14mm
Fits into 13mm Hole
Lexus RX330 2009 - 2004
Toyota Highlander 2010 - On

UNIT PACKAGE: 15



21366

(90467-09227)
Black Nylon

Bumper & Engine Under Cover
Push-Type Retainer
Head Diameter: 22mm
Stem Length: 15mm (Excluding the Pin)
Fits into 9mm Hole
Toyota 4 Runner, RAV 4 & Scion XB
2006 - On

UNIT PACKAGE: 10



20967

(Not Available from O.E.M.)
Black Nylon

Rear Bumper Mounting Bracket
Push-Type Retainer
Head Diameter: 22mm
Stem Length: 16mm
Fits into 10mm Hole
Jeep Commander 2006 - On

UNIT PACKAGE: 15



19847

(5973823)
Blue Nylon

Fascia Retainer
Head Diameter: 7/8" (22mm)
Shoulder Length: 5/32" (4mm)
Stem Length: 25/32" (20mm)
Fits into 1/2" (12.7mm) Hole
GM 1979 - On

UNIT PACKAGE: 25

PUSH-TYPE RETAINERS

Sec. 19

Refer to Retainer Specification Chart on pages 534-545
Listed smallest to largest by Head Diameter, Stem Length and then by Hole Diameter.



20753

(01553-03201)
Black Nylon

Front & Rear Bumper
Push-Type Retainer
Head Diameter: 22mm
Stem Length: 21mm
Fits into 8mm Hole
Nissan 1982 - On

UNIT PACKAGE: 10



22282

(Mazda: FD01-68-AC3)
Gray Nylon

Bumper Filler & Door Panel
Push-Type Retainer
Head Diameter: 22mm
Stem Length: 25mm
Fits into 8mm Hole
Mazda 2, 3, 5, 6,
CX-5, CX-7 & CX-9
2004 - On

UNIT PACKAGE: 15



18269

(6503106)
Black Nylon

Lower Sill Moulding
Push-Type Retainer
Large Head Diameter: 7/8" (22mm)
Stem Length: 1" (25.4mm)
Fits into 1/4" (6.4mm) Hole
Jeep Grand Cherokee Laredo 1994 - On

UNIT PACKAGE: 15



15043

(14103461)
Black Nylon

Bumper Fascia Retainer
Head Diameter: 7/8" (22mm)
Shoulder Length: 5/32" (4mm)
Stem Length: 1-3/64" (26.5mm)
Fits into 1/2" (12.7mm) Hole
GM 1987 - On

UNIT PACKAGE: 25



21578

(57750AA090)
Black Nylon

Front & Rear Bumper
Push-Type Retainer
Head Diameter: 22mm
Stem Length: 28mm
Fits into 10mm Hole
Subaru Impreza & Legacy 2001 - 1993

UNIT PACKAGE: 25



21251

(6Q0-868-243)
Black & White Nylon

Trim Panel
Push-Type Retainer with Sealer
Head Diameter: 22.5mm
Stem Length: 8mm (Excluding the Pin)
Fits into 8mm Hole
Volkswagen Golf, Jetta, Passat, Phaeton,
Rabbit & Tiguan 2004 - On

UNIT PACKAGE: 15



22256

(Jaguar: XR831159)
Black Nylon

Radiator Support &
Air Deflector Shield
Push-Type Retainer
Head Diameter: 24mm
Stem Length: 12mm
Fits into 12mm Hole
Jaguar X, XF, XJ-L & XK 2012 - On

UNIT PACKAGE: 10



21482

(1H0-867-199-A)
Black Nylon

Push-Type Retainer
Head Diameter: 24mm
Stem Length: 13mm
Fits into 9mm Square Hole
VW Passat 1999 - 90

UNIT PACKAGE: 25



21452

(1H0-819-055-C01C)
Black Nylon

Push-Type Retainer
Top Head Diameter: 23mm
Bottom Head Diameter: 16mm
Stem Length: 15mm
Fits into 8mm x 8mm Square Hole
VW 2002 - 1993

UNIT PACKAGE: 25



20767

(4806110-AA)
Black & White Nylon

Front Bumper Push-Type Retainer
Head Diameter: 24mm
Shoulder Length: 3mm
Stem Length: 20mm
Fits into 11mm Hole
Chrysler 300 & Dodge Magnum 2005 - On

UNIT PACKAGE: 15

Sec. 19

PUSH-TYPE RETAINERS

Refer to Retainer Specification Chart on pages 534-545

Listed smallest to largest by Head Diameter, Stem Length and then by Hole Diameter.



21376

(4389947-AA)

Black and White Nylon

Bumper Cover
Push-Type Retainer with Sealer
Head Diameter: 24mm
Shoulder Length: 3mm
Stem Length: 20mm
Fits into 11mm Hole
Chrysler Avenger, Journey & Sebring
2008 - On

UNIT PACKAGE: 10



20233

(W705956-S300)

Black Nylon

Cowl Push-Type Retainer
Head Diameter: 25mm
Shoulder Diameter: 10mm
Shoulder Length: 3mm
Stem Length: 12mm (Excluding the Pin)
Fits into 9mm Hole
Lincoln LS 1999 - On

UNIT PACKAGE: 15



21176

(10382313)

Black Nylon

Sight Shield & Trim
Push-Type Retainer
Head Diameter: 24.5mm
Stem Length: 13mm (Excluding the Pin)
Fits into 9mm Hole
Cadillac STS, Pontiac Solstice and
Saturn Sky 2005 - On

UNIT PACKAGE: 10



22047

(Subaru: 94415FA000NE)

Gray & Black Nylon

Rear Roof Spoiler Trim
Push-Type Retainer
Top Head Diameter: 25mm
Bottom Head Diameter: 21mm
Stem Length: 9mm (Not including the Pin)
Fits into 8mm Hole
Impreza 2007 - 1998

UNIT PACKAGE: 15



20518

(W705957-S300, W706519-S300)

Black Nylon

Radiator Sight Shield
Push-Type Retainer
Head Diameter: 24.5mm
Stem Length: 14mm
Fits into 9mm Hole
Lincoln LS 2000 - On

UNIT PACKAGE: 10



21501

(909140055)

Black Nylon

Push-Type Retainer with Sealer
Head Diameter: 25mm
Shoulder Length: 3mm
Shoulder Diameter: 16.5mm
Stem Length: 16mm (Excluding the Pin)
Fits into 11mm Hole
Subaru 2006 - On

UNIT PACKAGE: 5



21400

(10426555)

Natural Nylon

Front Bumper
Push-Type Retainer
Top Head Diameter: 24.5mm
Bottom Head Diameter: 23.5mm
Stem Length: 36mm
Fits into 10mm Hole
Buick Allure & LaCrosse
Chevrolet Impala &
Monte Carlo and
Pontiac Grand Prix 2000 - On

UNIT PACKAGE: 15



21576

(909140002)

Black Nylon

Rocker, Pillar, Floor & Exterior Trim
Push-Type Retainer with Sealer
Head Diameter: 25mm
Shoulder Diameter: 17mm
Shoulder Length: 3mm
Stem Length: 16mm (Excluding the Pin)
Fits into 11mm Hole
Subaru B9 Tribeca, Baja, Legacy &
Outback 2000 - On

UNIT PACKAGE: 25

PUSH-TYPE RETAINERS

Sec. 19

Refer to Retainer Specification Chart on pages 534-545
Listed smallest to largest by Head Diameter, Stem Length and then by Hole Diameter.



20993

(GM: 11589295; Ford: W712665-S300)
Black Nylon

Fender, Flare, Gas Tank &
Panel Attachment Push-Type Retainer
Head Diameter: 25mm
Stem Length: 20mm
Panel Range: 3.0mm - 6.0mm
Fits into 10.5mm Hole
Chevrolet Cobalt & HHR,
GM C & K Trucks and
Pontiac G5 2005 - On

UNIT PACKAGE: 25



21361

(GM: 11561874;
Nissan: 622A2-9E000A)
Black Nylon

Bumper Cover Push-Type Retainer
Head Diameter: 25mm
Stem Length: 29mm
Fits into 7mm Hole
Chevrolet Malibu 2008 - On
Saturn Aura 2007 - On
Pontiac G6 2010 - On
Nissan Altima 1997 - On

UNIT PACKAGE: 15



20994

(11589296)
Black Nylon

Panel Attachment &
General Purpose
Push-Type Retainer
Head Diameter: 25mm
Stem Length: 23mm
Panel Range: 6.0mm - 9.00mm
Fits into 10.5mm Hole
Buick Enclave and GMC Acadia
2007 - On

UNIT PACKAGE: 25



19244

(N808847-S)
Black Nylon

Trunk Trim Panel
Push-Type Retainer
Head Diameter: 1" (25.4mm)
Stem Length: 11/16" (17.5mm)
Fits into 1/4" (6.4mm) Square Hole
Ford Taurus & Sable 1996 - On

UNIT PACKAGE: 25



22284

(Ford: W718365-S300)
Black Nylon

Front Fender, Cowl Grille,
Rocker & Mudguard
Push-Type Retainer
Head Diameter: 25mm
Stem Length: 24mm
Fits into 8.5mm Hole
Ford Mustang & Transit
Connect and Lincoln
MKC 2014 - On

UNIT PACKAGE: 10



14010

(14045480)
Black Nylon

Fascia Retainer
Head Diameter: 1" (25.4mm)
Stem Length: 23/32" (18.3mm)
Fits into 3/8" (9.5mm) Hole
GM 1982 - On

UNIT PACKAGE: 25



15701

(N804674-S)
Black Nylon

Push-Type Retainer
Head Diameter: 25mm
Stem Length: 27mm
Fits into 7mm Hole
Ford Mustang & Capri

UNIT PACKAGE: 50



12757

(5973400)
Black Nylon

Fascia Retainer
Head Diameter: 1" (25.4mm)
Shoulder Length: 1/8" (3.2mm)
Stem Length: 3/4" (19mm)
Fits into 1/2" (12.7mm) Hole
GM 1979 - On

UNIT PACKAGE: 15

16265

Same as 12757 except unit package quantity

UNIT PACKAGE: 50

Sec. 19

PUSH-TYPE RETAINERS

Refer to Retainer Specification Chart on pages 534-545

Listed smallest to largest by Head Diameter, Stem Length and then by Hole Diameter.



14147
(20547865)
Black Nylon

Body Retainer
Head Diameter: 1" (25.4mm)
Stem Length: 7/8" (22mm)
Fits into 1/4" (6.4mm) Hole
GM 1984 - On

UNIT PACKAGE: 25



14994
(N804837S)
Black Nylon

Push-Type Retainer
Head Diameter: 1" (25.4mm)
Stem Length: 29/32" (23mm)
Fits into 1/4" (6.4mm) Hole
Ford 1987 - On

UNIT PACKAGE: 50



14020
(Ford: N802781-S; GM: 14093088)
Black Nylon

Splash Shield & Fascia Retainer
Head Diameter: 1" (25.4mm)
Stem Length: 7/8" (22mm)
Fits into 1/4" (6.4mm) Hole
GM & Ford

UNIT PACKAGE: 25



18310
(22587036)
Black Nylon

Rear Bumper Fascia
Push-Type Retainer
Head Diameter: 1" (25.4mm)
Stem Length: 15/16" (24mm)
Fits into 3/8" (9.5mm) Hole
Chevrolet Cavalier & Pontiac Sunfire
1995 - On

UNIT PACKAGE: 25



14019
(Ford: N803421-S, Chrysler: 6501590)
Black Nylon

Splash Shield & Fascia Retainer
Head Diameter: 1" (25.4mm)
Shoulder Length: 1/8" (3.2mm)
Stem Length: 7/8" (22mm)
Fits into 5/16" (8mm) Hole
Ford & Chrysler

UNIT PACKAGE: 25



15702
(14101262)
Black Nylon

Plastic Cover on Engine
Compartment Retainer
Head Diameter: 1" (25.4mm)
Shoulder Length: 1/8" (3.2mm)
Stem Length: 15/16" (24mm)
Fits into 1/2" (12.7mm) Hole
Buick, Oldsmobile & Pontiac 1988 - On

UNIT PACKAGE: 25



13994
(GM: 20570245, 20635065;
Ford: N804614S)
Black Nylon

Splash Shield, Seat Cushion &
Spare Tire Retainer
Head Diameter: 1" (25.4mm)
Stem Length: 7/8" (22mm)
Fits into 5/16" (8mm) Hole
GM 1984 - On
Ford

UNIT PACKAGE: 25



20265
(25663903)
Black Nylon

Radiator Support Sight Shield
Push-Type Retainer
Head Diameter: 1" (25.4mm)
Stem Length: 1" (25.4mm)
Fits into 1/4" (6.4mm) Hole
Cadillac DeVille & Seville 1998 - On

UNIT PACKAGE: 10



12756
(5973996)
Brown Nylon

Fascia Retainer
Head Diameter: 1" (25.4mm)
Shoulder Length: 1/4" (6.4mm)
Stem Length: 7/8" (22mm)
Fits into 1/2" (12.7mm) Hole
GM 1982 - On

UNIT PACKAGE: 15



18503
(W701054-S300)
Black Nylon

Front Bumper Push-Type Retainer
Head Diameter: 1" (25.4mm)
Stem Length: 1" (25.4mm)
Fits into 5/16" (8mm) Hole
Ford Contour & Mystique 1995 - On

UNIT PACKAGE: 25

PUSH-TYPE RETAINERS

Sec. 19

Refer to Retainer Specification Chart on pages 534-545
Listed smallest to largest by Head Diameter, Stem Length and then by Hole Diameter.



15044
(22535007)
Black Nylon

Bumper Fascia Retainer
Head Diameter: 1" (25.4mm)
Shoulder Length: 1/8" (3.2mm)
Stem Length: 1" (25.4mm)
Fits into 1/2" (12.7mm) Hole
GM 1987 - On

UNIT PACKAGE: 25



18268
(15959832)
Black Nylon

Front License Plate Bracket
Push-Type Retainer
Head Diameter: 1" (25.4mm)
Shoulder Length: 9/64" (3.6mm)
Stem Length: 1-5/8" (41.3mm)
Fits into 1/2" (12.7mm) Hole
GM Truck 1994 - On

UNIT PACKAGE: 5



15045
(10053388, 22542705)
Black Nylon

Bumper Fascia Retainer
Head Diameter: 1" (25.4mm)
Shoulder Length: 1/8" (3.2mm)
Stem Length: 1-7/64" (28.2mm)
Fits into 1/2" (12.7mm) Hole
GM 1987 - On

UNIT PACKAGE: 25



18334
(15959833)
Gray Nylon

Front License Plate Bracket
Push-Type Retainer
Head Diameter: 1" (25.4mm)
Stem Length: 1-3/4" (44.5mm)
Fits into 1/2" (12.7mm) Hole
GM S-10 Truck with
Decor Package
1994 - On

UNIT PACKAGE: 5



18394
(6503453)
Black Nylon

Bumper Fascia Retainer
Head Diameter: 1" (25.4mm)
Stem Length: 1-1/8" (28.5mm)
Fits into 1/4" (6.4mm) Hole
Jeep Grand Cherokee 1994 - On

UNIT PACKAGE: 25



21238
(22718369)
Black Nylon

Fuel Tank Shield &
Miscellaneous Push-Type Retainer
Head Diameter: 26mm
Stem Length: 12mm
Fits into 10mm Hole
Chevrolet Malibu & Trail Blazer 2004 - On

UNIT PACKAGE: 25



15042
(10077283)
Black Nylon

Bumper Fascia Retainer
Head Diameter: 1" (25.4mm)
Shoulder Length: 1/4" (6.4mm)
Stem Length: 1-1/8" (28.5mm)
Fits into 1/2" (12.7mm) Hole
GM 1982 - On

UNIT PACKAGE: 25



19892
(25695687)
Black Nylon

Radiator Support Sight Shield
Push-Type Retainer
Head Diameter: 27mm
Shoulder Length: 7mm
Stem Length: 18mm
(Excluding the Pin)
Fits into 10mm Hole
Cadillac DeVille & Seville 2000 - On

UNIT PACKAGE: 15

Sec. 19

PUSH-TYPE RETAINERS

Refer to Retainer Specification Chart on pages 534-545

Listed smallest to largest by Head Diameter, Stem Length and then by Hole Diameter.



17616

(21077131)
Black Nylon

Bumper Fascia
Push-Type Retainer
Head Diameter: 1-3/16" (30mm)
Stem Length: 2" (51mm)
Fits into 7/16" (11mm) Hole
GM Saturn 1991 - On

UNIT PACKAGE: 10



22339

(Mercedes: 001-990-01-92)
Black Nylon

Rocker Panel Moulding
Push-Type Retainer
Head Diameter: 30.5mm
T25 Drive
Stem Length: 17mm
Fits into 8.5mm Hole
Mercedes-Benz CLS550,
CLS63 AMG, SL550, SL600,
SL63 AMG, SLK300, SLK350
and SLK55 AMG 2011 - 2008

UNIT PACKAGE: 25



21348

(6508643-AA)
Black Nylon

Tail Light Push-Type Retainer
Top Head Diameter: 31.5mm
Bottom Head Diameter: 20mm
Stem Length: 23mm
Fits into 10mm Hole
Dodge Nitro and Jeep 2008 - On

UNIT PACKAGE: 15



17080

(OH452KD5)
Nylon Quartz Matte Finish

Headliner Retainer
Head Diameter: 1-1/4" (32mm)
Stem Length: 7/16" (11mm)
Fits into 1/4" (6.4mm) Hole
Dodge Caravan & Plymouth Voyager
1984 - On

UNIT PACKAGE: 15



20963

(4806334-AA)
Black & White Nylon

Rear Bumper Push-Type
Retainer with Sealer
Head Diameter: 34mm
Shoulder Length: 3.5mm
Stem Length: 17mm
Fits into 8.5mm Hole
Dodge Caliber and
Jeep Compass & Patriot
2007 - On

UNIT PACKAGE: 10



19638

(Chrysler: 4805405AA;
Ford: 1L5Z-17K826AA)
Black & White Nylon

Front Bumper Fascia
Push-Type Retainer
Head Diameter: 34mm
Shoulder Length: 3mm
Stem Length: 20mm
Fits into 8mm Hole
Chrysler Concorde, Intrepid, Eagle,
Pacifica & PT Cruiser 1998 - On
Ford Trucks 2005 - On

UNIT PACKAGE: 15



22072

(Toyota: 76923-47010)
Black Nylon

Rocker Moulding
Push-Type Retainer
Head Diameter: 38mm
Stem Length: 32mm
Fits into 22mm Hole
Lexus HS 250h & CT 200h
and Toyota Prius 2010 - On

UNIT PACKAGE: 5

PUSH-TYPE RETAINERS

Sec. 19

Refer to Retainer Specification Chart on pages 534-545
Listed smallest to largest by Head Diameter, Stem Length and then by Hole Diameter.



16115
(5113-885-399)
Black Nylon

Push-Type Retainer
Head Size: 7mm x 15mm
Stem Length: 17mm
Fits into 6mm x 6mm Hole
BMW

UNIT PACKAGE: 25



16725
(66814-01G00)
Black Nylon

Cowl Grille Retainer
Head Size: 8mm x 12mm
Stem Length: 8mm
Fits into 6mm Square Hole
Nissan Pick-Up 1986 - On

UNIT PACKAGE: 25



20923
(Ford: 3M8Z-1502316-A;
Mazda: GJ6E-50-715A)
Black Nylon

Cowl Vent Push-Type Retainer
Head Size: 8.5mm x 12mm
Stem Length: 9mm
Fits into 5mm Hole
Ford Fusion, Milan & Zephyr 2006 - On
Mazda 5 & 6 2003 - On

UNIT PACKAGE: 15



20407
(9133073-8)
Black Nylon

Hood Insulation & Radiator Seal
Push-Type Retainer
Head Size: 8mm x 25mm
Stem Length: 10mm
Fits into 5mm Hole
Volvo 850, 940, 960, S80, S90 & V90 1991 - On

UNIT PACKAGE: 25



20203
(124-990-07-92)
Black Nylon

Push-Type Retainer
Head Size: 11mm x 14mm
Stem Length: 8mm
Fits into 7mm x 8mm Hole
Mercedes-Benz 124, 129, 140, 170, 202,
203, 208, 210, 215 & 220 1986 - On

UNIT PACKAGE: 25



14953
(Ford: N803494S; GM: 15679091)
Black Nylon

Fascia, Trim & Grille Retainer
Head Size: " 15/32" x 15/32"
(12mm x 12mm)
Stem Length: 21/32" (16.7mm)
Fits into 1/4" (6.4mm) Square Hole or Slot
Ford Aerostar, Escort & Lynx 1985 - On
GM 1994 - On

UNIT PACKAGE: 25



14725
(66824-W1000)
Black Nylon

Push-Type Retainer
Head Size: 12mm x 18mm
Stem Length: 10mm
Fits into 6mm Hole
Nissan

UNIT PACKAGE: 15



22041
(GM: 92139147)
Black Nylon

Front & Rear Bumper Fascia
Push-Type Retainer
Head Size: 14mm x 21mm
Stem Length: 16mm
Fits into 8mm Hole
Chevrolet Caprice and
Pontiac G8 & GTO 2011 - 04

UNIT PACKAGE: 25



14727
(Nissan: 63844-D0100;
Isuzu: 8942211500)
Black Nylon

Push-Type Retainer
Head Size: 14mm x 22mm
Stem Length: 9mm
Fits into 7mm Hole
Isuzu & Nissan

UNIT PACKAGE: 25



20892
(12337831)
Black Nylon

Front Bumper Push-Type Retainer
Head Size: 14mm x 26mm
Stem Length: 14mm
Fits into 8mm Hole
Pontiac G6 2005 - On

UNIT PACKAGE: 50

Sec. 19

PUSH-TYPE RETAINERS

Refer to Retainer Specification Chart on pages 534-545

Listed smallest to largest by Head Diameter, Stem Length and then by Hole Diameter.



14008

(14032200)
Black Nylon

Grille Attachment Retainer
Head Size: 19/32" x 3/4"
(15mm x 19mm)
Stem Length: 19/32" (15mm)
Fits into 5/16" (8mm) Hole
GM 1981 - On

UNIT PACKAGE: 25



17104

(6501630, 6501772, 6501878)
Black Nylon

Headlight & Tail Light
Panel Attachment
Push-Type Retainer
Head Size: 15mm x 31mm
Stem Length: 17mm
Fits into 5mm x 6.5mm Hole
Dodge Daytona 1987 - On

UNIT PACKAGE: 10



16843

(Mazda: BF82-50-233;
Nissan: 01553-01393)
Black Nylon

Bumper Cover
Push-Type Retainer
Head Size: 20mm x 30mm
Stem Length: 18mm
Fits into 10mm Hole
Mazda & Nissan

UNIT PACKAGE: 10

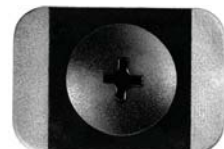

18029

(4630253)
Black Nylon

Rear Fascia
Push-Type Retainer
Head Size: 7/8" x 1-25/32"
(22mm x 45.5mm)
Stem Length: 1-1/16" (27mm)
Fits into 1/2" (12.7mm) Hole
Chrysler Concorde & LHS
Dodge Intrepid & Eagle Vision
1993 - On

UNIT PACKAGE: 15



20890

(55157112-AA, 55157112-AB)
Black & Natural Nylon

Bumper Cover
Push-Type Retainer
Head Size: 25mm x 45mm
Shoulder Length: 3mm
Stem Length: 20mm
Fits into 9.5mm Hole
Jeep Liberty 2005 - On

UNIT PACKAGE: 15

BODY HARDWARE MASTER PROGRAM

The Body Hardware Master Program, 6600BHM is based on Auveco's Display Boards, DB-428.

We have developed 20 large metal drawer assortments, which come in heavy gauge steel, pre-labeled and pre-loaded large drawers and cabinets.

Learn more about the Body Hardware Master Program in the green section of the catalog, online at www.auveco.com or contact customer service at 1-800-354-9816 or mail@auveco.com.

"428" DISPLAY BOARDS

428 of the most popular body hardware and fastener items are shrink-wrapped onto seven different boards. Each board contains product groups, body shops are familiar with and use often.

The back of each board contains each part number, unit package quantity, OEM number and size specification. The backs are protected by a clear plastic liner.

Learn more about the display boards at the front of the catalog, online at www.auveco.com or contact customer service at 1-800-354-9816 or mail@auveco.com

PUSH-TYPE RETAINER SPECIFICATION CHART



Auveco Part No.	Type	Head Diameter	Stem Length	Fits in Hole Size	Shoulder Length	Color	Page No.
11699	7	11/16" (17.5mm)	5/8" (16mm)	1/4" (6.4mm)		Black	506
11702	7	25/64" (10mm)	19/32" (15mm)	9/32" (7.1mm)		Natural	491
11704	7	11/16" (17.5mm)	7/16" (11mm)	9/32" (7.1mm)		Black	505
11705	7	19/32" (15mm)	5/8" (16mm)	1/4" (6.4mm)		Black	500
11706	7	3/4" (19mm)	11/16" (17.5mm)	1/4" x 1/4" (6.4mm x 6.4mm)	1/4" (6.4mm)	Black	514
11854	7	7/16" (11mm)	9/32" (7.1mm)	3/16" (4.8mm)		Natural	492
12567	5	11/16" (17.5mm)	9/16" (14.3mm)	1/4" (6.4mm)		Black	505
12756	5	1" (25.4mm)	7/8" (22mm)	1/2" (12.7mm)	1/4" (6.4mm)	Brown	529
12757	5	1" (25.4mm)	3/4" (19mm)	1/2" (12.7mm)	3/4" (19mm)	Black	528
13230	7	10mm	7mm	5mm		Black	490
13457	1 (Phillips Hex Drive)	43/64" (17mm)	23/64" (18.3mm)	5/16" (8mm)		Black	505
13469	1 (Phillips Hex Drive)	3/4" (19mm)	1/2" (12.7mm)	1/4" (6.4mm)		Black	513
13993	6	11/16" (17.5mm)	7/8" (22mm)	1/4" (6.4mm)		Black	506
13994	6	1" (25.4mm)	7/8" (22mm)	5/16" (8mm)		Black	529
13996	6	11/16" (17.5mm)	7/8" (22mm)	9/32" (7.1mm)		Black	506
13999	3	3/8" (9.5mm)	1/2" (12.7mm)	7/32" (5.6mm)		Black	490
14001	5	21/32" (16.7mm)	19/32" (15mm)	5/16" (8mm)		Black	504
14007	5	11/16" (17.5mm)	9/16" (14.3mm)	1/4" (6.4mm)		Black	505
14008	11	19/32" x 3/4" (15mm x 19mm)	19/32" (15mm)	5/16" (8mm)		Black	533
14010	5	1" (25.4mm)	23/32" (18.3mm)	3/8" (9.5mm)		Black	528
14011	5	21/32" (16.7mm)	9/16" (14.3mm)	5/16" (8mm)		Black	504
14016	3	3/8" (9.5mm)	7/16" (11mm)	3/16" (4.8mm)		Black	490
14018	3	18mm	23mm	7mm		Black	512

Sec. 19

PUSH-TYPE RETAINER SPECIFICATION CHART



Auveco Part No.	Type	Head Diameter	Stem Length	Fits in Hole Size	Shoulder Length	Color	Page No.
14019	6	1" (25.4mm)	7/8" (22mm)	5/16" (8mm)	1/8" (3.2mm)	Black	529
14020	6	1" (25.4mm)	7/8" (22mm)	1/4" (6.4mm)		Black	529
14147	6	1" (25.4mm)	7/8" (22mm)	1/4" (6.4mm)		Black	529
14260	1	15mm	12mm	7mm		Black	498
14369	1	20mm	9mm	6mm		Black	515
14696	1	15mm	11mm	6mm		Black	498
14697	1	14mm	11mm	7mm		Black	496
14698	1	18mm	11mm	6mm		Black	508
14725	10	12mm x 18mm	10mm	6mm		Black	532
14726	1	17mm	18mm	8mm		Black	505
	(Phillips Hex Drive)						
14727	10	14mm x 22mm	9mm	7mm		Black	532
14753	2	11/16" (17.5mm)	7/8" (22mm)	1/4" (6.4mm)		Black	506
14953	10	15/32" x 15/32" (12mm x 12mm)	21/32" (16.7mm)	1/4" x 1/4" (6.4mm x 6.4mm)		Black	532
14987	2	11mm (7/16")	18mm (11/16")	6mm (15/64")		Black	493
14988	2	7/16" (11mm)	11/16" (17.5mm)	15/64" (6mm)		Black	493
14990	2	7/16" (11mm)	15/32" (11.9mm)	15/64" (6mm)		Black	492
	(Torx Drive)						
14991	2	11/16" (17.5mm)	11/16" (17.5mm)	1/4" (6.4mm)		Black	506
14992	2	19/32" (15mm)	29/32" (23mm)	1/4" (6.4mm)		Black	500
14993	2	11/16" (17.5mm)	7/8" (22mm)	1/4" (6.4mm)		Black	506
14994	2	1" (25.4mm)	29/32" (23mm)	1/4" (6.4mm)		Black	529
14995	2	1/2" (12.7mm)	1-13/64" (30.5mm)	9/32" (7mm)		Black	495
14997	2	19/32" (15mm)	13/16" (20.6mm)	5/16" (8mm)		Black	500
14998	2	27/32" (21.4mm)	1" (25.4mm)	13/32" (10.3mm)		Black	524
15042	6	1" (25.4mm)	1-1/8" (28.5mm)	1/2" (12.7mm)	1/4" (6.4mm)	Black	530
15043	6	7/8" (22mm)	1-3/64" (26.5mm)	1/2" (12.7mm)	5/32" (4mm)	Black	526

*Not including the pin

PUSH-TYPE RETAINER SPECIFICATION CHART



Auveco Part No.	Type	Head Diameter	Stem Length	Fits in Hole Size	Shoulder Length	Color	Page No.
15044	6	1" (25.4mm)	1" (25.4mm)	1/2" (12.7mm)	1/8" (3.2mm)	Black	530
15045	6	1" (25.4mm)	1-7/64" (28.2mm)	1/2" (12.7mm)	1/8" (3.2mm)	Black	530
15522	5 (16mm)	5/8" (13.5mm)	17/32" (6.4mm)	1/4"		Black	503
15672	1 (Phillips Hex Drive)	17mm	14mm	8mm (5/16")		Black	505
15701	6	25mm	27mm	7mm		Black	528
15702	6	1" (25.4mm)	15/16" (24mm)	1/2" (12.7mm)	1/8" (3.2mm)	Black	529
16000	1	20mm	9mm	8mm		Black	516
16115	10	7mm x 15mm	17mm	6mm x 6mm		Black	532
16265	5	1" (25.4mm)	3/4" (19mm)	1/2" (12.7mm)	3/4" (19mm)	Black	528
16622	6	18mm	23mm	9.5mm (3/8")		Black	512
16624	3	17mm	18mm	9.5mm (3/8")	2mm	Black	505
16625	6	20mm	20mm	10mm x 10mm		Black	522
16725	11	8mm x 12mm	8mm	6mm x 6mm		Black	532
16726	3	18mm	18mm	6.3mm x 6.3mm		Black	510
16782	8	20mm	8mm*	8mm		Black	520
16783	8	12mm	8mm*	6mm		Black	493
16784	8	18mm	11mm*	7mm		Black	508
16816	3	14mm	14mm	6mm		Black	497
16835	2	27/32" (21mm)	1" (25mm)	1/2" (12mm)	1/8" (3mm)	Black	524
16843	10	20mm x 30mm	18mm	10mm		Black	533
16858	2	25/32" (20mm)	23/32" (18mm)	5/16" (8mm)		Black	522
16859	2	9/16" (14mm)	5/8" (16mm)	1/4" (6mm)		Black	497
17057	2	18mm	21mm	8mm		Black	512
17080	7	1-1/4" (32mm)	7/16" (11mm)	1/4" (6.4mm)		Quartz Matte Finish	531
17081	1	18mm	12mm	6mm		Black	508
17103	3	15mm	23mm	6mm		Black	500
17104	10	15mm x 31mm	17mm	5mm x 6.5mm		Black	533
17106	3	1/2" (12.7mm)	7/16" (11mm)	3/16" (4.8mm)		Black	495
17143	2	20mm	27mm	10mm		Black	524
17144	2	20mm	24mm	10mm		Black	523
17162	8	15mm	8mm*	6.3mm		Black	499

*Not including the pin

Sec. 19

PUSH-TYPE RETAINER SPECIFICATION CHART



Auveco Part No.	Type	Head Diameter	Stem Length	Fits in Hole Size	Shoulder Length	Color	Page No.
17192	4	18mm	14mm	8mm		Black	509
17206	1	15mm	12mm	9mm		Black	499
17214	2 (Torx Drive)	7/16" (11mm)	11/16" (18mm)	15/64" (6mm)		Black	493
17216	3	20mm	20mm	8mm		Black	522
17222	3	15mm	20mm	8mm		Black	500
17226	3	15mm	29mm	8mm		Black	501
17227	7	7mm	10mm	5mm		Black	490
17267	1	20mm	15mm	10mm		Black	521
17287	1	13mm	11mm	6mm		Black	495
17347	8	20mm	11mm*	8mm		Black	518
17350	1 (Phillips Hex Drive)	20mm	15mm	8mm		Black	520
17351	1	17mm	10mm	7mm		Black	504
17378	1	22mm	14mm*	11mm		Black	525
17379	1	20mm	9mm	8mm		Black	516
17383	8	11mm	14mm*	7mm		Black	492
17439	2	15mm	27mm	9mm		Black	501
17472	2	20mm	20mm	8mm		Black	522
17478	3	14mm	16mm	6mm		Black	497
17616	6	1-3/16" (30mm)	2" (51mm)	7/16" (11mm)		Black	531
17632	1	18mm	12mm	8mm		Black	508
17988	2	19mm	26mm	9mm		Black	514
17992	1	20mm	12mm	7mm		Black	518
18029	Misc.	7/8" x 1-25/32" (22mm x 45.5mm)	1-1/16" (27mm)	1/2" (12.7mm)		Black	533
18030	6	11/16" (17.5mm)	13/16" (20.6mm)	1/4" (6.4mm)		Black	506
18032	2	15/32" (11.9mm)	9/16" (14.3mm)	1/4" (6.4mm)		Black	493
18119	1	20mm	25mm	10mm		Black	523
18165	4	17mm	9mm	8mm		Black	504
18206	4	18mm	12mm	6mm		Gray	508
18265	6	16mm	20mm	8mm		Black	503
18268	6	1" (25.4mm)	1-5/8" (41.3mm)	1/2" (12.7mm)	9/64" (3.6mm)	Black	530
18269	5	7/8" (22mm)	1" (25.4mm)	1/4" (6.4mm)		Black	526
18270	8	17mm	9mm	7mm		Black	504
18308	3	3/4" (19mm)	1-1/8" (28.5mm)	1/4" (6.4mm)		Black	514

*Not including the pin

PUSH-TYPE RETAINER SPECIFICATION CHART



Auveco Part No.	Type	Head Diameter	Stem Length	Fits in Hole Size	Shoulder Length	Color	Page No.
18310	6	1" (25.4mm)	15/16" (24mm)	3/8" (9.5mm)		Black	529
18327	5	11/16" (17.5mm)	5/8" (16mm)	1/4" (6.4mm)		Black	506
18334	6	1" (25.4mm)	1-3/4" (44.5mm)	1/2" (12.7mm)		Gray	530
18353	9	9/16" (14.3mm)	41/64" (16.3mm)	1/4" (6.4mm)		White	497
18394	3	1" (25.4mm)	1-1/8" (28.5mm)	1/4" (6.4mm)		Black	530
18503	6	1" (25.4mm)	1" (25.4mm)	5/16" (8mm)		Black	529
18873	3	18mm	28mm	9mm		Black	513
18888	4	20mm	8mm*	7mm		Black	515
18893	1	11/16" (17.5mm)	1/2" (12.7mm)	1/4" (6.4mm)		Black	505
18894	1	11/16" (17.5mm)	3/4" (19mm)	1/4" (6.4mm)		Black	506
18895	1	11/16" (17.5mm)	1-3/32" (28mm)	1/4" (6.4mm)		Black	506
18896	3	20mm	28mm	8mm		Black	524
18939	2	18mm	23mm	9mm		Black	512
18951	1	20mm	26mm	8mm		Black	523
19013	4	15mm	10mm	7mm		Black	498
19118	4	20mm	10mm	8mm		Black	517
19128	1	20mm	9mm	7mm		Black	516
19140	1	20mm	21mm	8mm		Black	522
19142	1	15mm	13mm	7mm x 7mm		Black	499
19186	4	11mm	10mm	8mm		Black	492
19195	7	16mm	12mm	8mm		Black	502
19219	Misc.	15mm	27mm	9mm		Black	501
19231	8	18mm	12mm	8mm		Black	510
19232	1	17mm	13mm	7mm		Black	504
19233	4	20mm	13mm	10mm		Black	519
19239	4	20mm	11mm	8mm		Black	518
19242	2	13/32" (10.3mm)	11/16" (17.5mm)	7/32" (5.6mm)		Black	492
19243	1	16mm	10mm*	9mm		Black	501
19244	6	1" (25.4mm)	11/16" (17.5mm)	1/4" x 1/4" (6.4mm x 6.4mm)		Black	528
19245	3	3/4" (19mm)	1-1/8" (28.5mm)	1/4" (6.4mm)		Black	514

*Not including the pin

Sec. 19

PUSH-TYPE RETAINER SPECIFICATION CHART



Auveco Part No.	Type	Head Diameter	Stem Length	Fits in Hole Size	Shoulder Length	Color	Page No.
19246	4	18mm	15mm	10mm		Black	510
19248	7	16mm	14mm	6mm		Black	503
19274	4	20mm	9mm*	8mm		Black	516
19297	8	16mm	12mm*	7mm		Black	502
19306	1	16mm	12mm	6mm		Black	502
19311	1	15mm	13mm	6mm		Black	499
19315	1	20mm	9mm*	8mm		Black	516
19337	Misc.	14mm	23mm	6.3mm		Black	497
19355	6	17/32" (13.5mm)	1-5/64" (27.5mm)	1/4" (6.4mm)		Black	496
19407	2	20mm	27mm	10mm		Black	524
19408	2	20mm	24mm	10mm		Black	523
19416	8	18mm	12mm*	9mm		Black	510
19422	4	23/32" (18.3mm)	29/32" (23mm)	5/16" (8mm)		Black	513
19453	4	18mm	15mm*	8mm		Black	510
19490	1	18mm	8mm	6mm		Black	507
19511	9	29/32" (23mm)	11/16" (17.5mm)	3/8" (9.5mm)		White	501
19522	3	12mm	18mm	6mm x 6mm		Black	494
19546	1	17mm	16mm	7mm x 7mm		Black	505
19547	4	17mm	13mm*	9mm		Black	504
19552	1	16mm	9mm	7mm		Black	501
19607	7	16mm	12mm	10mm		Natural	502
19615	3	20mm	21mm	9mm		Black	522
19638	Misc.	34mm	20mm	8mm	3mm	Black & White	531
19639	3	17mm	16mm	6mm		Black	505
19645	1	14mm	8mm*	6mm		Gray	496
19726	1	14mm	8mm*	6mm		Black	496
19739	2	20mm	26mm	9mm		Black	523
19747	1	18mm	10mm	8mm		Black	507
19787	2	12mm	17mm	6mm		Black	494
19788	2	11mm	20mm	6mm		Black	493
19801	3	19/32" (15mm)	3/4" (19mm)	1/4" (6.4mm)		Black	500
19847	5	7/8" (22mm)	25/32" (20mm)	1/2" (12.7mm)	5/32" (4mm)	Blue	525
19849	2	18mm	18mm	8mm		Black Nylon & Santoprene Rubber	511
19854	5	7mm	10mm	5mm		Black	490
19892	8	27mm	18mm*	10mm	7mm	Black	530
19904	7	16mm	14mm	9mm		Black	503

*Not including the pin

PUSH-TYPE RETAINER SPECIFICATION CHART



Auveco Part No.	Type	Head Diameter	Stem Length	Fits in Hole Size	Shoulder Length	Color	Page No.
19905	1	20mm	8mm*	8mm		Black	515
19907	1	20mm	8mm*	7mm		Gray	515
19908	1	20mm	8mm*	7mm		Black	515
20163	Misc.	12.5mm	17mm	6mm		Black	495
20169	9	15mm	13mm	7mm		White	499
20187	7	10mm	10mm	6mm		Black	491
20196	1	14mm	8mm	6mm		Black	496
20203	Misc.	11mm x 14mm	8mm	7mm x 8mm		Black	532
20233	8	25mm	12mm*	9mm	3mm	Black	527
20234	5	15mm	15mm	6.3mm		Black	500
20244	9	19mm	32mm	8mm		Green with Sealer	515
20247	4	18mm	12mm	9mm		Black	509
20248	5	20mm	17mm	6.3mm		Black	521
20265	2	1"	1"	1/4"		Black	529
		(25.4mm)	(25.4mm)	(6.4mm)			
20270	5	20mm	9mm	7mm		Black	516
20273	8	19mm	22mm	9mm	7mm	Gray	514
20310	7	5/8"	7/16"	1/4"		Black	502
		(16mm)	(11mm)	(6.4mm)			
20314	7	13mm	14mm	8mm		Black	496
20327	4	18mm	22mm	9mm		Black	512
20335	4	18mm	7mm	7mm		Black	507
20348	2	20mm	22mm	8mm		Black	523
20349	4	18mm	12mm	8mm		Black	508
20352	2	16mm	21mm	8mm		Black	504
	(Slotted Drive)						
20359	6	18mm	26mm	10mm		Black	513
20363	9	20mm	12mm*	9mm		White	499
20365	4	18mm	13mm	7.5mm x 7.5mm		Black	509
20367	2	18mm	18mm	8mm		Black	511
20388	1	20mm	16mm	7mm		Black	521
20407	11	8mm x 25mm	10mm	5mm		Black	532
20457	3	21mm	23mm	9.5mm		Black	524
20458	6	20mm	17mm	7mm		Black	521
20465	1	18mm	9mm	8mm		Black	507
20516	1	20mm	13mm	8mm		Black	519
	(Hex Drive)						
20518	Misc.	24.5mm	14mm*	9mm		Black	527
20542	6	16.5mm	27mm	8mm		Black	504
20545	2	18mm	18mm	6.3mm		Black Nylon & Santoprene Rubber	510
20564	4	20mm	18mm	10mm		Black	522

*Not including the pin

Sec. 19

PUSH-TYPE RETAINER SPECIFICATION CHART



Auveco Part No.	Type	Head Diameter	Stem Length	Fits in Hole Size	Shoulder Length	Color	Page No.
20577	1	20mm	8mm*	7mm		Black	515
20580	4	14mm	12mm	7mm		Black	499
20608	4	20mm	14mm	10mm		Black	520
20613	2	18mm	20mm	9mm		Black	511
20631	6	18mm	26mm	10mm		Black	512
20632	3	20mm	26mm	8mm		Black	523
20636	5	12mm	10mm	8.5mm		Dark Gray	493
20637	5	20mm	9mm	8mm		Black	516
20638	5	20mm	14mm	8.5mm		Black	520
20639	1	12mm	11mm	5mm x 5mm		Black	494
20640	1	12mm	11mm	5mm		Black	494
20666	8	12mm	14mm*	6mm		Gray	494
20734	7	20mm	15mm	6.3mm		Black	520
20739	8	22mm	10mm*	9mm		Black	524
20753	2	22mm	21mm	8mm		Black	526
20755	4	19.5mm	15mm	10mm		Black	515
20766	7	20mm	16mm	10mm		Black	521
20767	Misc.	24mm	20mm	11mm	3mm	Black & White	526
20768	4	18.5mm	21mm	8mm		Black with Sealer	513
20826	3	19mm	14mm	8.5mm		Black	514
20863	4	22mm	13mm*	15mm		Black	525
20869	4	18mm	7.5mm	7mm		Black	507
20880	3	18mm	20mm	6.5mm		Black	511
20888	3	18mm	20mm	9.5mm		Black	512
20889	3	20mm	22mm	8.5mm		Black	523
20890	Misc.	25mm x 45mm	20mm	9.5mm	3mm	Black & Natural	533
20892	10	14mm x 26mm	14mm	8mm		Black	532
20908	4	20mm	10mm	7mm		Black	517
20909	6	16mm	18mm	7mm		Black	503
20910	8	17mm	12mm	8mm		Black	504
20923	10	8.5mm x 12mm	9mm	5mm		Black	532
20931	3	18mm	31mm	9mm		Black	513
20943	2	14mm	23mm	7mm		Black	497
20948	8	22mm	10mm*	9mm		Tan	525
20953	4	20mm	13mm	8mm		Black	519
20963	Misc.	34mm	17mm	8.5mm	3.5mm	Black & White	531
20966	4	18mm	20mm	8mm		Black	511
20967	7	22mm	16mm	10mm		Black	525
20986	4	20mm	13mm	10mm		Black	519
20988	3	18mm	17.5mm	6.5mm		Black	510
20989	3	18mm	22mm	6.5mm		Black	512

*Not including the pin

PUSH-TYPE RETAINER SPECIFICATION CHART

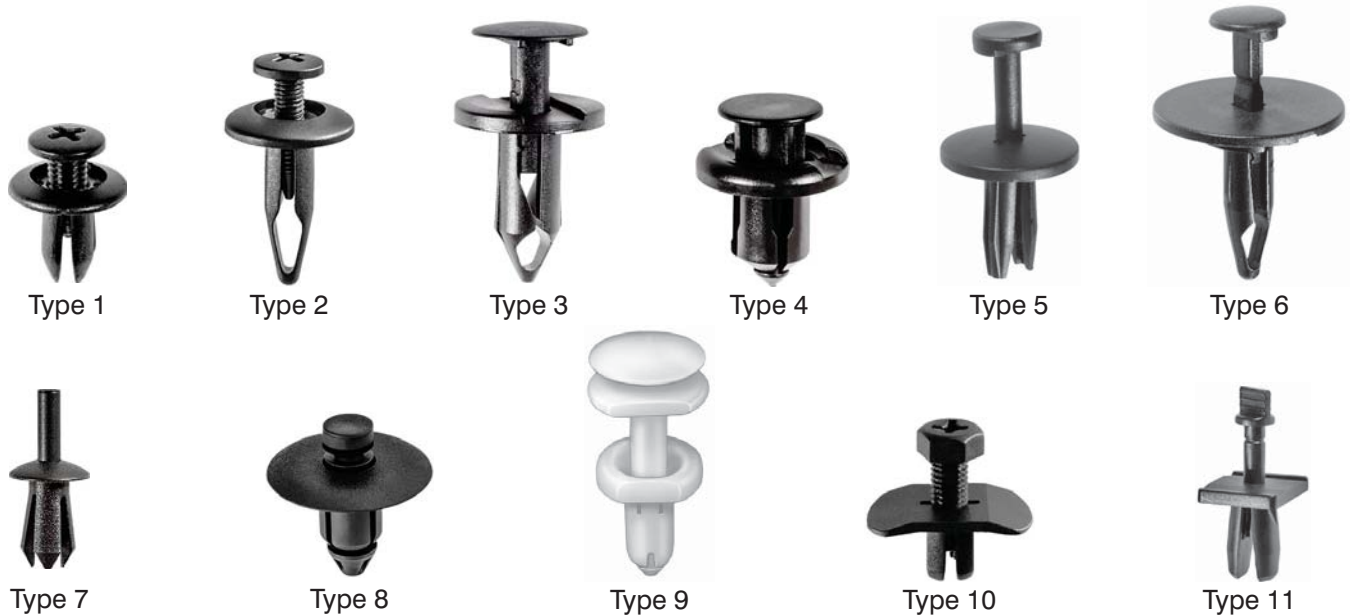

Auveco Part No.	Type	Head Diameter	Stem Length	Fits in Hole Size	Shoulder Length	Color	Page No.
20990	3	19mm	16mm	8mm		Black	514
20991	3	20mm	20mm	8.5mm		Black	522
20992	3	20mm	24mm	8.5mm		Black	523
20993	3	25mm	20mm	10.5mm		Black	528
20994	3	25mm	23mm	10.5mm		Black	528
21010	1	20mm	9mm	9mm x 9mm		Black	516
21011	4	15mm	17mm	7mm		Black	500
21021	8	22mm	10mm*	9mm		Gray	524
21024	4	18mm	10mm	6mm		Black	507
21037	7	10mm	10mm	6mm		Black	491
21044	1	16mm	11mm	6.3mm		Black	502
21086	5	20mm	10mm	8mm		Black	517
21089	1	18mm	18mm	8mm		Black	510
21098	1	18mm	18mm	6.4mm		Black	510
21103	1	10mm	12mm	5mm		Black	491
21104	1	14mm	14mm	7mm		Black	497
21110	8	18mm	12mm	8.5mm		Black	509
21112	2	15mm	14mm	6mm		Black	499
21119	2	20mm	19mm	6mm		Black	522
21120	8	15mm	9mm*	7mm		Black	499
21123	4	18mm	12mm*	8mm		Black	511
21134	8	20mm	11mm*	8mm		Black	520
21140	8	15mm	12mm	6.3mm		Black	498
21141	9	18mm	13mm	8mm		Black & White	509
21146	1	18mm	12mm	8mm		Black	508
21172	1	13mm	18mm	8mm		Black With Sealer	496
21173	4	20mm	16mm	10mm		Black	521
21176	Misc.	24.5mm	13mm*	9mm		Black	527
21190	8	16mm	14mm	7mm		Black	503
21192	4	20mm	12mm	8mm		Black	518
21201	4	19mm	8mm	7mm		Black	513
21218	1	11mm	8mm	5mm		Black	492
21225	5	18mm	14mm	7mm		Black	509
21233	2	10mm	13mm	5mm		Black	491
21238	7	26mm	12mm	10mm		Black	530
21246	8	12mm	14mm*	6mm		Black	494
21249	8	11mm	9mm*	7mm		Black	492
21251	Misc.	22.5mm	8mm*	8mm		Black & White	526
21294	4	20mm	9mm	7mm		Black	516
21297	4	20mm	11mm	10mm		Black	518
21311	1	18mm	12mm	8mm		Gray	508
21325	1	16mm	14mm	7mm		Black	503

*Not including the pin

Sec. 19

PUSH-TYPE RETAINER SPECIFICATION CHART

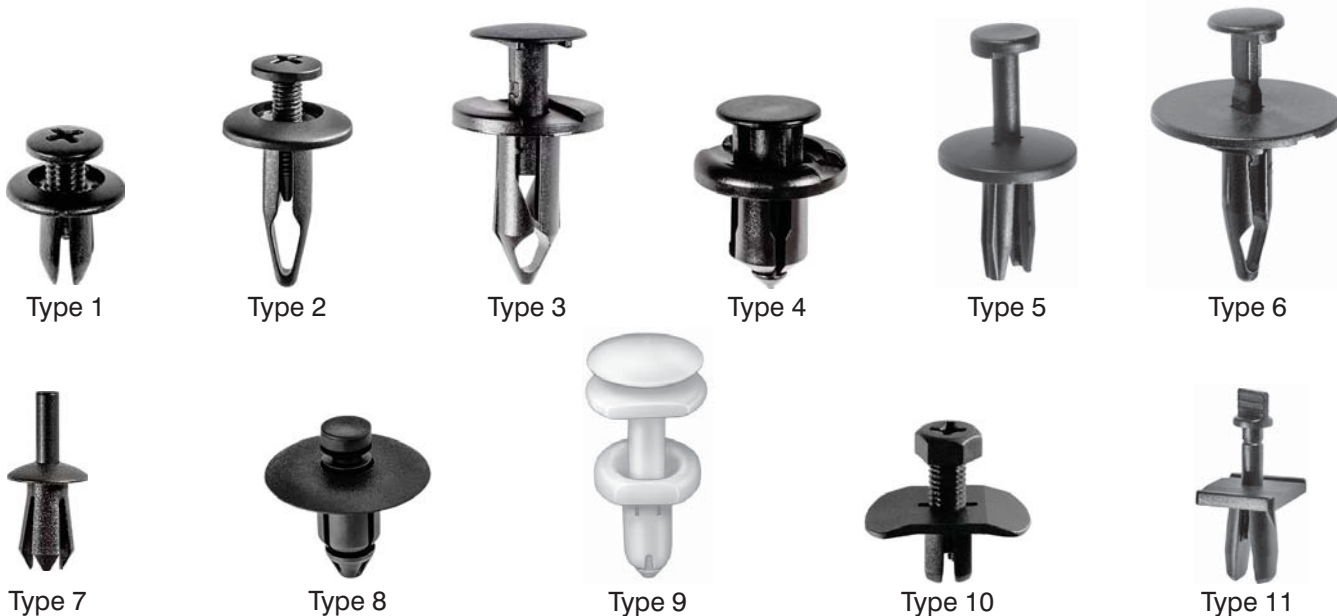

Auveco Part No.	Type	Head Diameter	Stem Length	Fits in Hole Size	Shoulder Length	Color	Page No.
21328	8	15mm	10mm	7mm		Black	498
21348	Misc.	20mm	23mm	10mm		Black	531
21361	6	25mm	29mm	7mm		Black	528
21366	4	22mm	15mm*	9mm		Black	525
21376	Misc.	24mm	20mm	11mm	3mm	Black & White	527
21391	7	12mm	11mm	8mm		Dark Gray	493
21400	Misc.	23.5mm	36mm	10mm		Natural	527
21420	4	21mm	15mm*	10mm		Black	524
21422	4	20mm	9mm*	7mm		Black	516
21427	8	22mm	10mm*	9mm		Gray	524
21451	4	14mm	10mm	8.5mm		Black	496
21452	1	16mm	15mm	8mm x 8mm		Black	526
21454	Misc.	20mm	13mm	10mm		Black	520
21477	8	16mm	14mm	7mm		Gray	503
21479	1	18.5mm	11mm	9mm		Gray	513
	(Allen Drive)						
21482	1	24mm	13mm	9mm x 9mm		Black	526
21500	1	20mm	12mm	7mm		Black	518
	(Slotted Drive)						
21501	4	25mm	12mm*	11mm	3mm	Black with Sealer	527
21525	8	19mm	9mm	7mm		Black	513
21529	3	18mm	22mm	6.5mm		Black with Sealer	512
21530	1	18mm	10mm	8mm		Black	507
21545	1	20mm	15mm	8mm		Black	520
21547	4	18mm	10mm	9mm		Black	508
21563	4	20mm	15mm	10mm		Black	521
21566	1	16mm	13mm	7mm		Black	502
21568	Misc.	14mm	15mm	10mm		Black	515
21570	1	16mm	11mm	6mm		Black	501
21571	1	20mm	10mm	8mm		Black	517
21576	4	25mm	16mm*	11mm	3mm	Black with Sealer	527
21578	2	22mm	28mm	10mm		Black	526
21580	1	20mm	12mm	7mm		Black	518
21585	5	9mm	7mm	4mm		Black	490
21592	1	20mm	11mm	7mm		Black	518
	(Slotted Drive)						
21593	1	15mm	8mm	7mm		Black	497
21594	1	20mm	11mm	7mm		Black	517
21596	4	20mm	16mm	8mm		Black	521
21601	9	22mm	16mm	9mm		White Nylon & Black Rubber Seal	503
21620	2	15mm	14mm	5mm		Black	499

*Not including the pin

PUSH-TYPE RETAINER SPECIFICATION CHART

Sec. 19



Auveco Part No.	Type	Head Diameter	Stem Length	Fits in Hole Size	Shoulder Length	Color	Page No.
21624	1	16mm	10mm	8mm		Black	501
21631	4	20mm	8mm*	8mm		Black	515
21645	7	15mm	15mm	6.3mm		Black	500
21651	4	20mm	10mm	8mm		Black	517
21658	4	15mm	11mm	6mm		Black	498
21662	8	11mm	11mm	7mm		Black	492
21663	1	10mm	9mm	5mm		Black	491
21672	6	18mm	20mm	6.3mm		Black with Sealer	511
21680	4	18mm	10mm	8mm		Black	507
21702	4	18mm	12mm	10mm		Black	509
21703	Misc.	18mm	12mm	7mm		Black	508
21711	6	11mm	16mm	6mm		Black Nylon & Santoprene Rubber	493
21769	1	13mm	13mm	8mm		Black	495
21778	5	20mm	21mm	8.5		Black	522
21779	7	10mm	11mm	6.3mm		Black	491
21780	7	9mm	7mm	5mm		Black	490
21781	5	20mm	16mm	6.3mm		Black	521
21807	1	18mm	14mm	8mm		Black	509
21810	1	22mm	14mm	6.3mm		Black	525
21811	8	20mm	10mm	8mm		Black	517
21812	Misc.	20mm	13mm	8mm		Black	519
21849	4	13mm	15mm	5.5mm		Black	496
21856	4	20mm	12mm	10mm		Black	518
21858	5	18mm	14mm	6mm		Black	509
21859	7	16mm	11mm	8mm		Black	502
21860	4	22mm	14mm	13mm		Black	525
21875	5	12.5mm	9mm	6mm		Black	494
21876	3	18mm	18mm	9mm		Black	511
21881	7	10mm	12mm	6.3mm		Black	491
21882	5	12mm	14mm	6mm		Black	494
21883	5	20mm	14mm	8mm		Black	520
21898	8	17.5mm	9mm	6mm		Black	505
21935	4	12mm	10mm	6mm		Black	493
21967	7	8mm	7mm	3.5mm		Black	490
21968	7	8mm	8mm	4mm		Black	490
21969	7	16mm	10mm	6mm		Black	501
21970	7	13mm	10mm	6mm		Black	495
21971	7	16mm	14mm	9mm		Black	503
21972	7	10.5mm	6mm	6mm		Black	492
21973	Misc.	20mm	10mm	6mm		Tan	517

*Not including the pin

Sec. 19

PUSH-TYPE RETAINER SPECIFICATION CHART



Auveco Part No.	Type	Head Diameter	Stem Length	Fits in Hole Size	Shoulder Length	Color	Page No.
21989	7	11mm	7mm	7mm		Black	492
21990	5	15mm	8mm	7mm		Black	497
22039	4	16mm x 19mm	12mm	8mm		Black	518
22041	3	14mm x 21mm	16mm	8mm		Black	532
22047	4	25mm	9mm*	8mm		Gray & Black	527
22049	2	18mm	20mm	9mm		Black	511
22052	5	20mm	17mm	6.3mm		Black	521
22058	8	14mm	9mm	7mm		Black	496
22068	4	20mm	13mm	8.5mm		White	519
22069	4	20mm	13mm	8.5mm		White	519
22072	4	38mm	32mm	22mm		Black	531
22077	1	18mm	9mm	9mm		Black	507
22083	4	16mm	10mm	8mm		Black	501
22095	7	22mm	13mm	8mm		Black	525
22100	4	20mm	12mm	8.5mm		Black	519
22101	7	22mm	12mm	7.5mm		Black	525
22112	4	20mm	13mm	8.5mm		Black	519
22125	4	10mm	10mm	5mm		Black	491
22126	6	19mm	28mm	9mm		Black	514
22155	7	13mm	13mm	8mm		Black	495
22160	8	15mm	10mm	7mm		Black	498
22177	Misc.	16mm	13mm	9mm		Yellow & White	502
22178	4	13mm	10mm	7mm		Black	495
22181	4	18mm	10mm	8mm		Black	507
22199	1	15mm	12mm	6.3mm		Black	498
22201	5	12.5mm	12mm	8.5mm		Black	494
22219	3	18mm	23mm	7.5mm		Black	512
22227	3	18mm	20mm	7mm		Black	511
22230	8	10mm	8.5mm	5mm		Black	490
22234	Misc.	16mm	11mm	8mm		Black	502
22238	5	10mm	11mm	5mm		Black	491
22248	5	19mm	12mm	8mm		Black	513
22253	5	18mm	14mm	8mm		Black	509
22256	1	24mm	12mm	12mm		Black	526
22270	4	20mm	10mm	8mm		Black	517
22280	10	10mm	11mm	5mm		Black	498
22282	8	22mm	25mm	8mm		Gray	526
22284	6	25mm	24mm	8.5mm		Black	528
22299	2	20mm	26mm	9.5mm		Black	523
22303	1	12mm	13mm	7mm		Black	494
22306	5	20mm	10mm	8mm		Black	517
22339	1	30.5mm	17mm	8.5mm		Black	531
22347	3	15mm	21mm	8mm		Black	500
22349	3	14mm	18mm	8mm x 11mm		Black	497
22354	3	18mm	18mm	7mm		Black	510

*Not including the pin

15301

Clip Removal Tool

Photos not actual size

The right tool for removing clips and retainers quickly and easily. Simply seat the tool on the shaft of the fastener and squeeze the handles together.

Made of high carbon steel and heat treated for strength. Zinc plated with vinyl molded handle grips.



UNIT PACKAGE: 1

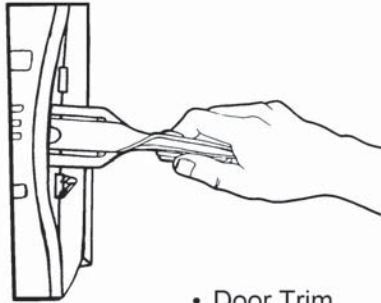

• Door Trim

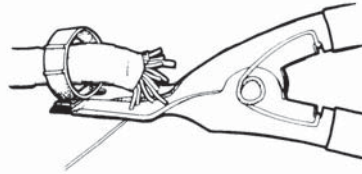

• Wiring Stays

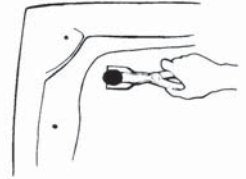

• Hood Insulation

Truck Seat Springs

16213

(E0TB-1063-226AC,
E3TB-1063-226AA)

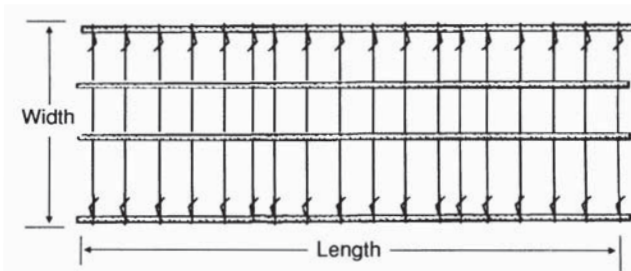

Photo not actual size

Length: 52"
Width: 16-3/4"
Number of Wires: 52
Ford Full Size Pick-Ups &
Light Truck 1980-On

UNIT PACKAGE: 5

Wire Bending Tool

16894



Photo not actual size

For truck seat springs

A tough tool that makes difficult wire repairs easy. You can bend the ends of no sags, edgewise and foam springs right on the spot, making offsets where you need them. Can be readily mounted in a vise for duplicating complex repetitive wire bends. Constructed of heat-hardened steel for long life.

UNIT PACKAGE: 1



17000
(16506582)

Horizontal Headlight Adjuster
Chevrolet Corsica & Lumina (APV),
Olds Silhouette (APV)
and Pontiac Trans Sport (APV)
1987-On

*Photo not
actual size*

UNIT PACKAGE: 2



11243

(343543, 343555,
354076, 362379)

1/4"-28 x 2"
Headlight Adjusting Screw &
Nut Assembly
GM 1962-On

UNIT PACKAGE: 10

11244

Same as 11243 except for
unit package quantity

UNIT PACKAGE: 100



11245

(343543, 343555, 354076, 362379)
Nylon

Headlight Adjusting Nut
GM 1962-On

UNIT PACKAGE: 50



11246

(343543, 354076, 9438150, 15705372)
Zinc

1/4"-28 x 2"
Headlight Adjusting Screw
GM 1962-On

UNIT PACKAGE: 25



10759

(GM: 1600375, 1606642, 1618890;
AMC: SF 400 6204)

1/4"-28 x 1-7/8"
Headlight Adjusting Screw &
Nut Assembly
Cadillac & Oldsmobile 1975-On
AMC

UNIT PACKAGE: 10

11470

Same as 10759 except for
unit package quantity

UNIT PACKAGE: 25

11657

Same as 10759 except for
unit package quantity

UNIT PACKAGE: 100



11826

(365270)
Green Nylon

1/4"-28 x 2"
Headlight Adjusting Screw &
Nut Assembly
Cars with Fiberglass Panels
GM 1976-On

UNIT PACKAGE: 25



11718

(365270)
Green Nylon

Headlight Adjusting Nut
For Cars with Fiberglass Panels
GM 1976-On

UNIT PACKAGE: 50



11665

(556196, 557057)
Nylon

#12-28 x 1-3/4"
Headlight Adjusting Screw
& Nut Assembly
GM 1975-On

UNIT PACKAGE: 25



11655
(557057, 559312)
Nylon

#12-28 x 1-3/4"
Headlight Adjusting Screw &
Nut Assembly
GM 1975-On

UNIT PACKAGE: 25

11656

Same as 11655 except for
unit package quantity

UNIT PACKAGE: 100



11667
(556539)
Nylon

#12-28 x 1-3/4"
Headlight Adjusting Screw &
Nut Assembly
Buick & Oldsmobile 1977-On

UNIT PACKAGE: 25



12605
(22512857, 22513813)
Nylon

#12-28 x 1-3/4"
Headlight Adjusting Screw &
Nut Assembly
Camaro & Firebird 1975-On

UNIT PACKAGE: 10

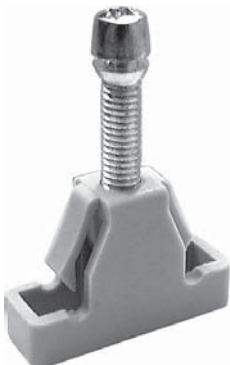

11871
(559312)
Nylon

#12-28 x 1-11/16"
Headlight Adjusting
Screw & Nut Assembly
Chevrolet, Oldsmobile &
Pontiac 1975-On

UNIT PACKAGE: 10



9851
(3921446)
White Nylon

Headlight Adjusting Nut
Use with 1/4"-28 Screw
Chevrolet

UNIT PACKAGE: 50



5788
Nylon

Headlight Adjusting Nut
Chevrolet: All Early Models

UNIT PACKAGE: 50



5789

Headlight Adjusting Screw &
Nut Assembly
Chevrolet

UNIT PACKAGE: 25 Sets



3209
Zinc

1/4"-28 x 1"
Headlight Adjusting Screw

UNIT PACKAGE: 50



3178
(5949838)

Headlight
Adjusting Screw &
Nut Assembly
Chevrolet, Buick &
Pontiac

UNIT PACKAGE: 10 Sets



20378

(Not Supplied by O.E.M.)
White Nylon

Headlight Adjusting Screw Nut
Component of Auveco 3178
Headlight Adjusting
Screw Assembly
Buick, Chevrolet & Pontiac

UNIT PACKAGE: 25



15676

(16510893)
Natural Nylon

Composite Headlight Nut
Screw Size: #6
Square Head: 3/8"
Buick Electra (FWD) 1987-On

UNIT PACKAGE: 50

19486

(10298115)
Natural Nylon



*Photo not
actual size*

Headlight Retainer
Width: 1-1/8"
Length: 4-9/16"
Buick Century & Regal and
Oldsmobile Intrigue 1997-On

UNIT PACKAGE: 10



9829

(380382)
Natural Nylon

Headlight Bezel to Body Nut
Screw Size: #6 or #8
GM

UNIT PACKAGE: 50



14002

(16503329)
Black Nylon

Screw Size: #6
Square Head: 3/8"
Fits 1/4" Square Hole
GM

UNIT PACKAGE: 100

20864

(15281294)
White Nylon



*Photo not
actual size*

Headlight Retainer
Width: 1-1/8"
Length: 5-9/16"
Chevrolet Impala & Monte Carlo 2006 - On

UNIT PACKAGE: 10



11838

(1254815)
Natural Nylon

Screw Size: #6
Panel Range: .060"-.150"
GM 1977-On

UNIT PACKAGE: 50



10090

(3923948)

Headlight
Adjusting Spring
Chevrolet 1968-On

UNIT PACKAGE: 25



13450

(347347)
Natural Nylon

Front Lights
Screw Size: #8
Panel Range: 1/16"-5/32"
GM 1967-On

UNIT PACKAGE: 50



8942

(3863669)
Nylon

Radiator Grille to Headlight Nut
Screw Size: #8 or #10
Chevrolet

UNIT PACKAGE: 25



10330

(3893980)
Natural Nylon

Front End & Instrument Panel Nut
Screw Size: #8
GM 1967-On

UNIT PACKAGE: 100



11691

(3919773)
Natural Nylon

Headlight Bezel Nut
Screw Size: #8
GM 1974-On

UNIT PACKAGE: 100



11424

(3985058)
Natural Nylon

Truck Grille Nut
Screw Size: #6 or #8
GM Trucks 1974-On

UNIT PACKAGE: 25



11855

(GM: 9669486;
Renault: 8934-201-262)
Natural Nylon

Side Marker Nut
GM 1980-On
Rear License Plate Bracket
Screw Size: #8
AMC/Renault

UNIT PACKAGE: 25



13960

(14013246)
Natural Nylon

Headlight Bezel Nut
Screw Size: #8
Fits into 5/16" Hole
GM 1967-On

UNIT PACKAGE: 50



14031

(12337852, 15596279, 21035018)
Black Nylon

Grille Retainer & Cowl Vent Nut
Screw Size: #8 or #10
Astro, Safari & Saturn 1985-On

UNIT PACKAGE: 25



14014

(GM: 20475950, 20624923;
VW: 175-853-674)
Black Nylon

Air Vent Nut
GM & VW

UNIT PACKAGE: 50



13933

Natural Nylon

Grille Nut
Screw Size: #8 or #10
Head Size: 1/2"

UNIT PACKAGE: 50



12735

(GM: 1370853; Chry: 6029501;
VW: 179-813-883)
Natural Nylon

Headlight Bezel Nut
Screw Size: #6
GM, Chrysler & VW 1982-On

UNIT PACKAGE: 50



10305

Natural Nylon

Nylon Nut
Screw Size: #8

UNIT PACKAGE: 50



14145

(16503548)
Nylon &
Stainless Steel

Headlight Glass nut
GM 1983-On

UNIT PACKAGE: 25



9069

(1355003)
Natural Nylon

Headlight Door to
Radiator Grille Anchor Nut
Screw Size: #6 or #8
Buick 1964-On

UNIT PACKAGE: 50



14030

(GM: 3997391; VW: 179-813-881)
Black Nylon

Tail Light Nut
Screw Size: #8
GM Astro & Safari 1985-On
Volkswagen

UNIT PACKAGE: 25



21347
(10351052)
White Nylon

Trim Panel Grommet with Sealer
Head Size: 12mm x 14.5mm
Stem Length: 15mm
Fits into 7mm Hole
Mates with Auveco 21346
Cadillac, Chevrolet Camaro &
Corvette and Pontiac Firebird 2004 - On

UNIT PACKAGE: 15



17271
(94113207)
Natural Nylon

Cowl Cover Retaining Clip
Head Diameter: 23mm
Chevrolet Spectrum 1989-85

UNIT PACKAGE: 15



19247
(10262143)
Black Nylon

Air Intake Grille Panel Grommet
For 5mm Stud
Buick Regal & Century Chevrolet Lumina
& Monte Carlo, Oldsmobile Cutlass,
Pontiac Grand Prix 1996-On

UNIT PACKAGE: 25



19194
(Toyota: 90189-06028; GM: 94854203)
Black Nylon

Front & Rear Wheel
Fender Liner Screw Grommet
Screw Size: #12
Head Diameter: 16mm
Stem Length: 19mm
Fits into 9mm x 9mm Square Hole
Tacoma, T100 & 4 Runner 1992 - On
Chevrolet Nova & Prizm
and Pontiac Vibe 1985 - On

UNIT PACKAGE: 15



19676
(10277480)
Natural Nylon

License Plate Cover
Screw Grommet
Screw Size: M4.2 (#8)
Head Diameter: 9/16"
Stem Length: 9/16"
Fits into 1/4" Square Hole
Oldsmobile Intrigue 1998 - On

UNIT PACKAGE: 15



17230
(10027015)
Natural Nylon

Screw Grommet for
Engine Control Module
Overall Length: 1-3/16"
GM (All Divisions) 1977-On

UNIT PACKAGE: 10



20938
(11561655)
Black Nylon

Tail Light Grommet with Sealer
Head Diameter: 15mm
Stem Length: 17mm
Fits into 11mm Hole
Buick Terraza, Chevrolet Uplander, GMC
Arcadia, Pontiac Montana SV6
and Saturn Relay 2005 - On

UNIT PACKAGE: 5



22026
(GM: 25803643)
Natural Nylon

Door Glass to Regulator Grommet
Head Diameter: 13.5mm
Overall Length: 14mm
Buick Allure, LaCrosse & Verano and
Chevrolet Malibu 2010 - On

UNIT PACKAGE: 25



21674
(11570830)
White Nylon

Fog Light Grommet
Head Diameter: 16mm
Stem Length: 16mm
Overall Length: 20mm
Fits into 11mm Hole
Cadillac Escalade, Chevrolet Avalanche, Camaro,
Colorado, Silverado & Tahoe and GMC
Canyon, Denali, Sierra & Yukon 2005 - On

UNIT PACKAGE: 15



19429

(15954398)
Rubber

Tail Light Screw Grommet
Venture, Silhouette, Transport,
S & T Trucks 1995-On

UNIT PACKAGE: 25



12713

(GM: 10032838, 1264963;
Chry: 6031869; AMC: 8934-201-602)
Nylon

High Torque Screw Grommet
Screw Size: #6
GM, Chrysler & AMC-Renault 1978-On

UNIT PACKAGE: 25



11865

(GM: 1255823; Ford: 389360S)
Natural Nylon

Front End Bezel Nut
Screw Size: #6 or #8
GM 1979-On
Tail Light Nut
Ford 1981-On

UNIT PACKAGE: 50



10365

(1377030)
Natural Nylon

Valance Panel to Rear
Bumper Bar Grommet
Screw Size: #6 or #8
GM 1971-On

UNIT PACKAGE: 100



20452

(11517873)
Natural Nylon

Screw Grommet
Use with #12 Screw
Head Size: 5/8" x 3/4"
Stem Length: 9/16"
Door Handle

Chevrolet Impala & Monte Carlo 2000 - On

UNIT PACKAGE: 15



19435

(25526447)
Natural Nylon

Radiator Screw Grommet
Screw Size: #6
Buick Century 1996 - 86

UNIT PACKAGE: 50



14009

(14032291)
Natural Nylon

Grille Attachment Grommet
Screw Size: #6 or #8

UNIT PACKAGE: 50



21428

(25704358)
White Nylon

Rear Bumper Screw Grommet with Sealer
Screw Size: M6.3 (1/4" or #14)
Head Size: 15mm x 18mm
Stem Length: 23mm
Cadillac CTS & SRX and
Pontiac Grand Prix 2004 - On

UNIT PACKAGE: 10



14220

(25525798, 22537749)
Natural Nylon

Grille Retaining Grommet
Screw Size: #8
GM 1985-On

UNIT PACKAGE: 50



14037

(GM: 15596280; Chry: 6035274)
Black Nylon

Cowl Vent Nut
Screw Size: #6 or #8
GM Astro & Safari 1985-On

UNIT PACKAGE: 25



20466

(GM: 25649667;
Ford: W705590-S300, W710459-S300)
Natural Nylon

Screw Grommet with Sealer
Screw Size: M4.2 (#8)
Head Size: 13mm x 22mm
Stem Length: 18mm
Back Glass Moulding & Interior Trim
Cadillac & Ford Windstar 1998 - On

UNIT PACKAGE: 15



12566
(GM: 25508532; Chry: 6032061)
Black Nylon

Grille Attaching Grommet
Screw Size: #6 or #8
GM & Chrysler 1981-On

UNIT PACKAGE: 25



19732
(22615352)
Black Nylon

Front Bumper Fascia
Hinged Pin Retainer
Assembles with Auveco 19733
Pontiac Grand Am 1999 - On

UNIT PACKAGE: 15



20635
(GM: 22722860)
White Nylon

Trim Panel Grommet with Sealer
Flange Diameter: 24mm
Stem Length: 12mm
Fits into 9mm Hole
Use with Auveco 20634
Oldsmobile Alero &
Pontiac Grand Am 2002 - On

UNIT PACKAGE: 25



21384
(11561500)
Yellow Nylon

Trim Panel Grommet with Sealer
Flange Diameter: 24mm
Stem Length: 12mm
Fits into 9mm Hole
Use with Auveco 21383
Chevrolet Traverse 2010 - On

UNIT PACKAGE: 25



20527
(15745990)
Black Nylon

Rear Light Housing
Lower Grommet
Head Size: 24mm x 24mm
Stem Length: 17mm
Fits into 15mm Hole
GM Bravada, Envoy &
Trailblazer 2002 - On

UNIT PACKAGE: 15



20529
(15745991)
Black Nylon

Rear Light Housing
Upper Grommet
Head Size: 13mm x 20mm
Stem Length: 17mm
Fits into 9mm x 16mm Hole
GM Bravada, Envoy
& Trailblazer 2002 - On

UNIT PACKAGE: 15



21518
(11561987)
Black Nylon

Tail Light Grommet with Sealer
Head Diameter: 24mm
Stem Length: 22mm
Overall Length: 24.5mm
Cadillac Escalade and
Chevrolet Avalanche 2007 - On

UNIT PACKAGE: 15



19613
(15733971)
Black Nylon

Front Air Deflector Retainer
Top Head Diameter: 18mm
Bottom Head Diameter: 26mm
Flange Diameter: 30mm
Stem Length: 24mm
Use with Auveco 19614
C & K Trucks 1999 - On

UNIT PACKAGE: 15



19614
(15733970)
Black Nylon

Front Air Deflector Grommet
Head Diameter: 28mm
Stem Length: 13mm
Use with Auveco 19613
C & K Trucks 1999-On

UNIT PACKAGE: 25



17128
(10119853)
Nylon

Body Side & End Gate
Lower Moulding Clip
Olds Custom Cruiser 1991-On

UNIT PACKAGE: 25

13925

(20338568)
Nylon



Outer Panel Front of Rear
Wheel Opening Moulding Clip
GM 1982-On

UNIT PACKAGE: 10



18911

(22578985)
Nylon

Rocker Panel
Moulding Clip
Buick Skylark 1993-On

UNIT PACKAGE: 10



17545

(22550254)
Nylon

Rocker Panel
Moulding Clip
Pontiac Grand Am SE 1992-On

UNIT PACKAGE: 25



19361
(25554845)
Nylon

Rocker Panel
Moulding Clip
Pontiac Bonneville 1992-On

UNIT PACKAGE: 20



19410

(10261327)
Nylon

Front & Rear Door
Lower Moulding Clip
Buick Century, Regal & Rendezvous
and Pontiac Aztek & Grand Prix 1997-On

UNIT PACKAGE: 15

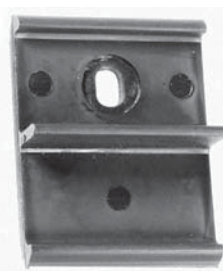

11138

(6263345)
Nylon

Body Side Moulding Clip
Use with 1/8" Pop Rivet
GM Trucks 1968-On

UNIT PACKAGE: 10



11485

(1729250)
Nylon

Roof Transverse Moulding Clip
GM 1976-On

UNIT PACKAGE: 25

**Please place orders in
Unit Package quantities,
not based on pieces needed**



14946

(20606417)
Nylon

Left Outer Panel in Front of Rear
Wheel Opening Moulding Clip
Width: 7/8"
Length: 1-3/16"
Pontiac Bonneville 1989-87

UNIT PACKAGE: 25



10220

(4457595, 4457495)
Nylon

Quarter Belt &
Wheel Opening Moulding Clip
GM 1967 -On

UNIT PACKAGE: 50



11288

(9838109)
Gray Nylon

Body Side Moulding Clip
Buick, Chevrolet & Oldsmobile 1967-On

UNIT PACKAGE: 100



18118
(10135796)
Nylon

Body Side Moulding Clip
Buick Roadmaster 1991-On

UNIT PACKAGE: 15



12563
(20175051, 15633873)
Nylon

Quarter Belt Reveal Moulding Clip
GM 1980-On

UNIT PACKAGE: 50



11425
(1688094)
Nylon

Vinyl Top Clip
Used on narrow Moulding across top of roof
Chevrolet, Cadillac & Oldsmobile 1974-On

UNIT PACKAGE: 50



12594
(20171942)
Nylon

Moulding Clip
GM 1980-On

UNIT PACKAGE: 25



11717
(1660123)
Nylon

Belt Moulding Clip
GM 1975-On

UNIT PACKAGE: 50



12602
(20237057)
Nylon

Moulding Clip
GM 1980-On

UNIT PACKAGE: 25



22228
GM: 11547339)
Pale Green Nylon

Belt Moulding Clip
Width: 26mm
Length: 43mm
Chevrolet Silverado &
Tahoe and GMC Sierra
2014 - On

UNIT PACKAGE: 15



12621
(14022878)
Nylon

Moulding Clip
GM 1980-On

UNIT PACKAGE: 25



9850
(7731589)
Natural Nylon

Quarter Panel Reveal Moulding &
Landau Top Moulding Clip
Use with Auveco 9877
GM

UNIT PACKAGE: 100



14642
(20199675)
Nylon

Quarter Belt Reveal Moulding Clip
Width: 7/16"
Length: 31/32"
GM 1980-On

UNIT PACKAGE: 50



10617
(8799350)
Nylon

Door, Quarter Panel & Rear End Moulding Clip
GM 1970-On

UNIT PACKAGE: 50



12824
(20274997)
Nylon

Rear Quarter Reveal Moulding Clip
GM 1980-On

UNIT PACKAGE: 50



17219
(21093588)
Nylon

Roof Drip
Moulding Clip
2 Door & 4 Door Models
GM Saturn 1991-On

UNIT PACKAGE: 25



20232
(10287926)
Yellow Nylon

Front & Rear Door
Window Moulding Clip
Overall Length: 1-9/16"
Buick Century & Regal
and Oldsmobile Intrigue 1997 - On

UNIT PACKAGE: 25



10318
(8733059
4492962, 9838109)
Nylon

Body Side & Wheel Opening
Moulding Clip
Buick, Chevrolet & Oldsmobile 1968-On

UNIT PACKAGE: 100

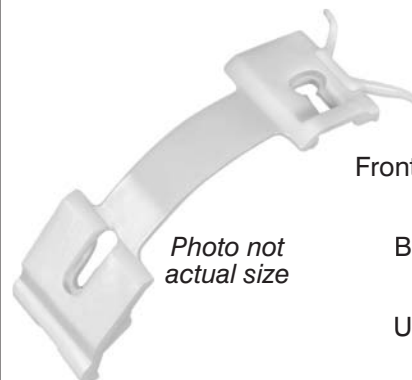

17979
(25552856)
Nylon

Front & Rear Door Center
Moulding Clip
Length: 4-3/8"
Buick LeSabre Ltd.
1992-On

*Photo not
actual size*

UNIT PACKAGE: 5



14033
(20393536)
Nylon

Front/Side Fender
Moulding Clip
GM Truck 1983-On

UNIT PACKAGE: 25



18417
(12519975)
Nylon

Front & Rear Door
Lower Finish Panel
(Lower) Moulding Clip
Use with Auveco 18421
Pontiac Bonneville 1992-On

UNIT PACKAGE: 15



13458
(20444103)
Nylon

Door Moulding Clip
GM 1984-On

UNIT PACKAGE: 15



20578
(GM: 88970495, 88973654;
Toyota: 76924-52021)
Black Nylon

Rocker Moulding Retainer
Head Diameter: 32mm
Stem Length: 10mm
Fits into 22mm Hole
Pontiac Vibe & Toyota Corolla 2003 - On

UNIT PACKAGE: 25



13828
(GM: 1706200)

Quarter Belt Moulding Clip
Cadillac 1976-On

UNIT PACKAGE: 25



20263
(22599312)
Black Nylon

Front & Rear Door
Window Moulding Clip
Chevrolet Malibu, Oldsmobile
Achieva & Cutlass 1997 - On

UNIT PACKAGE: 25



19358
(3526573)
Nylon

Front & Rear Door
Lower Moulding Clip
Cadillac DeVille & Seville 1997-92

UNIT PACKAGE: 10



18418
(16611889)
Nylon

Front Fender, Door
& Rear Quarter Panel
Center Moulding (Lower) Clip
Pontiac Grand Prix 1991-On

UNIT PACKAGE: 10



19411
(25630331)
Nylon

Front Door and
Front & Rear Fender
Moulding Clip
Pontiac Bonneville
1996-On

UNIT PACKAGE: 10



18428
(10167448)
Nylon

Rear Quarter Center Front
Moulding Clip
Excludes Deluxe Extra Trim
Olds Cutlass 1994-92

UNIT PACKAGE: 25

18423
(25552853)
Nylon

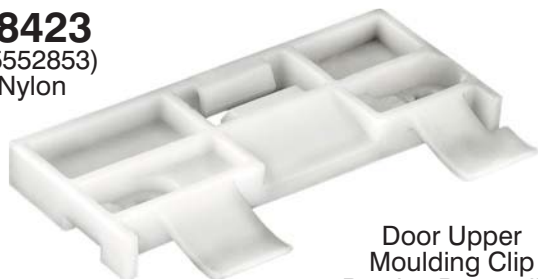

Door Upper
Moulding Clip
Pontiac Bonneville
1992-On

UNIT PACKAGE: 15

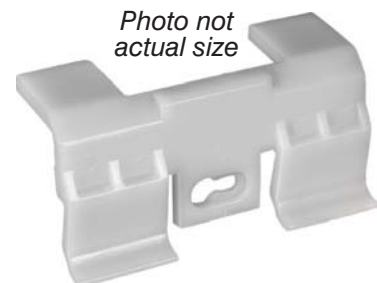

*Photo not
actual size*

19357
(10167445)
Nylon

Rocker Quarter Panel
Moulding Clip
Oldsmobile Cutlass
Supreme 1997-92

UNIT PACKAGE: 15



19370
(16615006)
Nylon

Rocker Panel
Moulding Clip
Oldsmobile Aurora 1995-On

UNIT PACKAGE: 15



20280
(25648693)
Gray Nylon

Rocker Panel Moulding Clip
Width: 7/8"
Length: 2"
Cadillac DeVille &
Seville 1998 - On

UNIT PACKAGE: 10

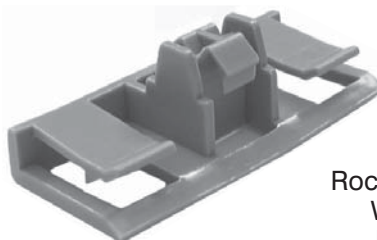

20318
(25722671)
Gray Nylon

Rocker Panel Clip
Width: 7/8"
Length: 2"
Buick LeSabre, Cadillac DeVille &
Seville, Oldsmobile Aurora and
Pontiac Bonneville 2000 - On

UNIT PACKAGE: 10

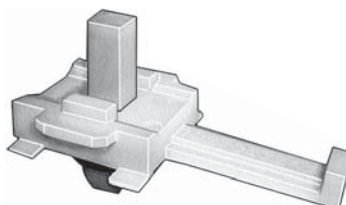

19390
(10270672)
Nylon

Rear Side Door
Lower Moulding Clip
Pontiac Trans Sport,
Montana 1997-On

UNIT PACKAGE: 10



18390
(10082288)
Black Nylon

Front Door
Moulding Retainer
Chevrolet Beretta, Corsica 1987-On

UNIT PACKAGE: 25



22224
(GM: 92139070)
White Nylon

Pillar Trim Moulding Clip
Width from Ear to Ear: 9.3mm
Bottom Width: 10.4mm
Overall Height: 15.5mm
Chevrolet Caprice & SS 2011 - On
Pontiac G8 2009 - 2008

UNIT PACKAGE: 25



22161
(GM: 94748652)
White Nylon

Quarter Panel & Exterior Trim
Moulding Clip
Width from Ear to Ear: 8mm
Overall Height: 15mm
Chevrolet Corvette Stingray
& Z06 2014 - On

UNIT PACKAGE: 25



22021
(Ford: W790225-S900)
Gray Nylon

Fender Corner &
Rocker Moulding Clip
Top Head Size: 16mm x 23mm
Bottom Head Diameter: 17mm
Stem Length: 12mm
Fits into 9mm Hole
Ford Focus 2012 - On

UNIT PACKAGE: 10

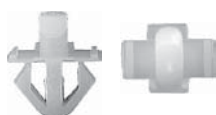

20408
(10287547)
White Nylon

Door & Rocker Panel Moulding Clip
Top Head Size: 3.5mm x 8mm
Bottom Head Size: 8.7mm x 12mm
Stem Length: 8mm
Fits into 8mm Hole
Buick Century, Regal &
Pontiac Grand Prix 1995 - On

UNIT PACKAGE: 25



15695
(Toyota: 62955-20020; GM: 94848834)
Nylon

Retainer with Sealer
Head Diameter: 15mm
Stem Length: 9mm
Fits into 8mm Hole
Toyota Pick-Up Truck, Pontiac Vibe

UNIT PACKAGE: 25



21316
(94530742)
White Nylon

Fender, Wheel, Side & Bumper
Moulding Clip with Sealer
Top Head Size: 11mm x 15mm
Bottom Head Diameter: 16mm
Stem Length: 10mm
Fits into 8mm Hole
Saturn Vue 2008 - On
Chevrolet Captiva & Cruze 2011 - On

UNIT PACKAGE: 15



21158
(11569920)
Green Nylon

Fender Moulding Clip with Sealer
Top Head Size: 7.5mm x 11mm
Bottom Head Size: 15mm x 15mm
Stem Length: 13mm
Fits into 7mm Hole
Buick Enclave, Cadillac CTS, Chevrolet
Traverse & GMC Acadia 2003 - On

UNIT PACKAGE: 10



21825
(GM: 11611375)
White Nylon

Moulding Clip with Sealer
Top Head Size: 8mm x 18mm
Bottom Head Diameter: 15mm
Stem Length: 13mm
Fits into 8mm Hole
Cadillac, Chevrolet & GMC 2014 - 13

UNIT PACKAGE: 15



22222
(GM: 92138865)
White Nylon

Body Side Moulding Clip
Top Head Size: 23mm x 28mm
Bottom Head Diameter: 19mm
Stem Length: 14mm
Fits into 9mm Hole
Chevrolet Caprice & SS 2011 - On
Pontiac G8 2009 - 2008

UNIT PACKAGE: 15



20326

(25718851)
Yellow Nylon

Door Trim Moulding Clip
Head Size: 9/16" x 3/4"
Stem Length: 3/8"
Cadillac DeVille & Seville 1998 - On

UNIT PACKAGE: 25



22022

(GM: 24405740)
Blue Nylon

Windshield Pillar, Interior & Trunk Trim Moulding Clip with Metal Reinforcement
Top Head Size: 17mm x 20mm
Bottom Head Size: 14mm x 28mm
Stem Length: 11mm
Buick Allure, Lacrosse, Regal & Verano, Cadillac XTZ, Chevrolet Camaro, Caprice, Cruze, Malibu, Sonic & Volt, Pontiac G8 and Saturn Astra 2008 - On

UNIT PACKAGE: 15



22024

(GM: 24405739)
Black Nylon

Windshield Pillar & Interior Trim Moulding Clip with Metal Reinforcement
Top Head Size: 17mm x 20mm
Bottom Head Size: 14mm x 28mm
Stem Length: 12mm
Buick Allure, Encore, Lacrosse, Regal & Verano, Cadillac XTZ, Chevrolet Camaro, Caprice, Cruze, Malibu & Sonic 2010 - On

UNIT PACKAGE: 15



22080

(GM: 11611623)
Blue Nylon

Interior Trim & Windshield Pillar Moulding Clip with Metal Reinforcement
Top Head Size: 17mm x 24mm
Bottom Head Size: 14mm x 28mm
Stem Length: 10mm
Cadillac ATS & Escalade, Chevrolet Corvette, Impala & Malibu and GMC Sierra & Yukon 2013 - On

UNIT PACKAGE: 10



22167

(GM: 11547026)
Red Nylon

Interior Trim & Windshield Garnish Moulding Clip with Metal Reinforcement
Top Head Size: 17mm x 24mm
Bottom Head Size: 14mm x 28mm
Stem Length: 10mm
Cadillac ATS & CTS, Chevrolet Impala and GMC Yukon 2013 - On

UNIT PACKAGE: 10



22276

(GM: 11547024)
Red Nylon

Door Sill Plate Moulding Clip with Metal Reinforcement & Sealer
Top Head Size: 17mm x 24mm
Bottom Head Size: 10mm x 24mm
Stem Length: 10mm
Cadillac ELR & XTS 2013 - On
Chevrolet Camaro & Malibu 2016 - On

UNIT PACKAGE: 10



22268

(GM: 11611367)
Blue Nylon

Scuff Plate & Trim Panel Moulding Clip with Sealer & Metal Reinforcement
Top Head Size: 17mm x 24mm
Bottom Head Size: 10mm x 24mm
Stem Length: 10mm
Overall Height: 16mm
Buick Verano, Cadillac ATS, CTS & XTS, Chevrolet Camaro, Impala, Malibu & Volt 2011 - On

UNIT PACKAGE: 10



19757

(10431524)
Black Nylon

Rocker Panel Moulding Clip
Head Size: 11/16" x 1-5/16"
Stem Length: 9/16"
Fits into 5/16" Hole
Chevrolet Impala, Lumina & Monte Carlo 2000 - On

UNIT PACKAGE: 15



19800

(10352803, 10437565)
Black Nylon

Rocker Panel Moulding Clip
Head Size: 15/32" x 1-5/16"
Stem Length: 9/16"
Fits into 5/16" Hole
Chevrolet Impala, Lumina & Monte Carlo 2000 - On

UNIT PACKAGE: 10



20810

(10431523)
Tan Nylon

Rocker Panel Moulding Clip
Head Size: 11/16" x 1-5/16"
Stem Length: 9/16"
Fits into 5/16" Hole
Chevrolet Impala, Lumina & Monte Carlo 2000 - On

UNIT PACKAGE: 15



20811
(10431526)
Red Nylon

Rocker Panel Moulding Clip
Head Size: 11/16" x 1-5/16"
Stem Length: 9/16"
Fits into 5/16" Hole
Chevrolet Impala, Lumina
& Monte Carlo 2000 - On

UNIT PACKAGE: 15



20974
(10352804)
Maroon Nylon

Rocker Panel Moulding Clip
Head Size: 15/32" x 1-9/32"
Stem Length: 11/16"
Fits into 5/16" Hole
Chevrolet Impala, Lumina
& Monte Carlo 2000 - On

UNIT PACKAGE: 10



20775
(10352809)
White Nylon

Rocker Panel Moulding Clip
Head Size: 11/16" x 1-5/16"
Stem Length: 11/16"
Fits into 5/16" Hole
Chevrolet Impala, Lumina &
Monte Carlo 2000 - On

UNIT PACKAGE: 15



20976
(25742293)
Blue Nylon

Rocker Panel Moulding Clip
Top Head Size: 9/16" x 25/32"
Bottom Head Size: 5/8" x 25/32"
Stem Length: 9/16"
Fits into 3/8" Hole
Cadillac DeVille & Seville 2000 - On

UNIT PACKAGE: 15



20809
(10352797)
Gray Nylon

Rocker Panel Moulding Clip
Head Size: 11/16" x 1-5/16"
Stem Length: 11/16"
Fits into 5/16" Hole
Chevrolet Impala, Lumina
& Monte Carlo 2000 - On

UNIT PACKAGE: 15



20972
(11589176)
White Nylon

Rocker Panel Moulding Clip
Top Head Size: 3/4" x 1-1/32"
Bottom Head Size: 19/32" x 1-1/32"
Stem Length: 9/16"
Fits into 3/8" Hole
Chevrolet Malibu 2004 - On

UNIT PACKAGE: 15



20808
(10352799)
Black Nylon

Rocker Panel Moulding Clip
Head Size: 11/16" x 1-5/16"
Stem Length: 11/16"
Fits into 5/16" Hole
Chevrolet Impala, Lumina
& Monte Carlo 2000 - On

UNIT PACKAGE: 15



20865
(15221959)
Gray Nylon

Rocker Panel Moulding Clip
Width: 9/16"
Length: 1-1/8"
Stem Length: 9/16"
Fits into 1/2" Hole
Chevrolet Cobalt & HHR 2005 - On

UNIT PACKAGE: 15



20973
(10352798)
Tan Nylon

Rocker Panel Moulding Clip
Head Size: 11/16" x 1-5/16"
Stem Length: 11/16"
Fits into 5/16" Hole
Chevrolet Impala, Lumina
& Monte Carlo 2000 - On

UNIT PACKAGE: 15



19820
(22603384)
White Nylon

Rocker Panel Moulding Clip
Head Size: 3/4" x 1-3/16"
Stem Length: 19/32"
Fits into 7/16" Hole
Oldsmobile Alero
& Pontiac Grand Am 1999 - On

UNIT PACKAGE: 15



21128
(11562563)
White Nylon

Rocker Moulding Clip
Upper Head Size: 12mm x 20mm
Bottom Head Size: 12mm x 32mm
Stem Length: 15mm
Fits into 10mm Hole
Chevrolet Malibu 2008 - On

UNIT PACKAGE: 15



20607
(10323057)
White Nylon

Rocker Moulding Clip
Top Head Size: 12mm x 20mm
Bottom Head Size: 12mm x 24mm
Stem Length: 14mm
Fits into 9mm Hole
Pontiac Grand Prix 2004 - On

UNIT PACKAGE: 15



20952
(15236894)
White Nylon

Rocker Panel Moulding Clip
Top Head Size: 9/16" x 23/32"
Overall Height: 5/8"
Stem Length: 7/16"
Fits into 3/8" Hole
Buick Lucerne and
Cadillac CTS & STS 2003 - On

UNIT PACKAGE: 15



20377
(11518357)
White Nylon

Rocker Panel Moulding Clip with Sealer
Top Head Size: 9/16" x 13/16"
Bottom Head Size: 13/16" x 13/16"
Stem Length: 9/16"
Fits into 7/16" Hole
Chevrolet Avalanche 2002 - On

UNIT PACKAGE: 15



20417
(91176726)
White Nylon

Side Door, Wheel Opening &
Rocker Panel Moulding Clip with Sealer
Top Head Size: 15/32" x 25/32"
Bottom Head Size: 9/16" x 25/32"
Stem Length: 7/16"
Fits into 7/16" Hole
Geo Tracker 2001 - On

UNIT PACKAGE: 15



20328
(10443956)
White Nylon

Rocker Panel Moulding Clip
Top Head Size: 9/16" x 13/16"
Bottom Head Size: 13/16" x 13/16"
Stem Length: 9/16"
Fits into 7/16" Hole
Chevrolet Impala, Lumina, Monte Carlo
and C & K Trucks 2000 - On

UNIT PACKAGE: 15



19822
(25693852)
Gray Nylon

Rocker Panel Moulding Clip
Top Head: 9/16" x 3/4"
Bottom Head: 5/8" x 3/4"
Stem Length: 9/16"
Fits into 7/16" Hole
Buick LeSabre; Cadillac Concours,
DeVille, Eldorado & Seville; Chevrolet
Impala, Lumina & Monte Carlo;
Oldsmobile Aurora and
Pontiac Bonneville 1995 - On

UNIT PACKAGE: 25



20885
(15288146, 15893516)
Gray Nylon

Windshield Pillar
Moulding Clip with Sealer
Top Head Size: 12mm x 20mm
Bottom Head Size: 14mm x 20mm
Stem Length: 15mm
Fits into 9mm Hole
Chevrolet Equinox &
Pontiac Torrent 2005 - On

UNIT PACKAGE: 15



22258
(GM: 11547211)
White Nylon

Rocker Moulding Clip
with Sealer
Top Head Size: 12mm x 20mm
Bottom Head Size: 12mm x 20mm
Stem Length: 16mm
Fits into 9mm Hole
Cadillac CT6 2016 - On

UNIT PACKAGE: 10



21793
(GM: 11610495)
White Nylon

Rocker Panel
Moulding Clip with Sealer
Top Head Size: 12mm x 20mm
Bottom Head Size: 12mm x 24mm
Stem Length: 14mm
Fits into 9mm Hole
Chevrolet Camaro 2010 and
Pontiac G6 & Grand Prix 2004 - On

UNIT PACKAGE: 15



22036
(GM: 11546635, 11612122)
Yellow Nylon

Rocker Moulding Clip
with Sealer
Top Head Size: 9mm x 20mm
Bottom Head Size: 14mm x 20mm
Stem Length: 14mm
Fits into 9mm Hole
Cadillac ATS & CTS 2013 - On

UNIT PACKAGE: 10



20774
(25724529)
White Nylon

Rocker Moulding &
Grille Moulding Clip
Top Head Size: 9/16" x 13/16"
Bottom Head Size: 5/8" x 13/16"
Stem Length: 9/16"
Fits into 3/8" Hole
Buick LeSabre & Rainier; Cadillac
Concours, CTS, DeVille, Eldorado,
Escalade, Seville, SRX & STS; Chevrolet
Avalanche, Impala, Lumina, Monte Carlo,
SSR, Vans & Trucks; Oldsmobile Aurora &
Bravada and Pontiac Bonneville 1992 - On

UNIT PACKAGE: 15



20756
(5480852)
Yellow Nylon

Rocker Panel
Moulding Clip with Sealer
Top Head Size: 9/16" x 25/32"
Bottom Head Size: 5/8" x 13/16"
Stem Length: 9/16"
Chevrolet Equinox 2005 - On

UNIT PACKAGE: 10



20934
(15127746)
White Nylon

Body Side Moulding Clip
Top Head Size: 12mm x 20mm
Bottom Head Size: 12mm x 20mm
Stem Length: 11mm
Fits into 9mm Hole
Buick Terraza, Chevrolet Uplander, GMC Acadia,
Pontiac Montana SV6 and Saturn Relay 2005 - On

UNIT PACKAGE: 15



21242
(11562250)
White Nylon

Rocker Panel Moulding Clip with Sealer
Top Head Size: 12mm x 20mm
Bottom Head Size: 12mm x 20mm
Stem Length: 11mm
Fits into 9mm Hole
GMC Acadia 2007 - On

UNIT PACKAGE: 15



21374
(GM: 11571175;
Chrysler: 68172491AA)
Gray Nylon

Rocker Moulding Clip with Sealer
Top Head Size: 12mm x 20mm
Bottom Head Size: 12mm x 20mm
Stem Length: 11mm
Fits into 9mm Hole
Chevrolet Traverse 2010 - On
Chrysler 200 2015 - On
Jeep Grand Cherokee 2015 - 2012

UNIT PACKAGE: 15



21156
(11570512)
Yellow Nylon

Side Window Reveal
Moulding Clip with Sealer
Width: 12.5mm
Length: 28mm
Overall Height: 13mm
Fits into 6mm Hole
Buick Lucerne 2006 - On

UNIT PACKAGE: 10



21129
(11569918)
White Nylon

Roof Rail Moulding Clip with Sealer
Top Head Size: 13mm x 30mm
Stem Length: 13mm
Fits into 7mm Hole
Buick Enclave &
GMC Acadia 2007 - On

UNIT PACKAGE: 15



20481

(10423553)
Green Nylon

Side Moulding, Fender &
Rocker Panel Moulding Clip
Top Head Size: 1/2" x 13/16"
Bottom Head Size: 19/32" x 13/16"
Stem Length: 9/16"
Fits into 7/16" Hole
Pontiac Aztek and
GM C & K Trucks 2001 - On

UNIT PACKAGE: 15



20521

(10242285, 10308019, 10297369)
Black Nylon with Sealer

Rocker Panel Moulding Clip
Top Head Size: 15/32" x 25/32"
Bottom Head Size: 5/8" x 25/32"
Stem Length: 9/16"
Fits into 7/16" Hole
Pontiac Aztek, Montana
& Trans Sport 1997 - On

UNIT PACKAGE: 15



20353

(10442914)
White Nylon

Rocker Panel Moulding Clip
Top Head Size: 1/2" x 9/16"
Bottom Head Size: 9/16" x 5/8"
Stem Length: 9/16"
Fits into 7/16" Hole
Buick Rendezvous 2002 - On

UNIT PACKAGE: 15



21504

(GM: 10445899)
Black Nylon

Door Moulding Clip
Top Head Size: 14mm x 20mm
Bottom Head Size: 15.5mm x 20mm
Stem Length: 14mm
Fits into 9mm Hole
GM SUV's 1997 - On

UNIT PACKAGE: 15



22027

(GM: 11570847)
Yellow Nylon

Lower Door Moulding Clip with Sealer
Top Head Size: 12.5mm x 20mm
Bottom Head Diameter: 18mm
Stem Length: 11mm
Fits into 9mm Hole
Cadillac SRX 2010 - On

UNIT PACKAGE: 10



19381

(10297368)
White Nylon

Rear Wheel Opening Moulding Clip
Top Head Size: 15/32" x 25/32"
Bottom Head Size: 1/2" x 25/32"
Stem Length: 9/16"
Fits into 7/16" Hole
Pontiac Trans Sport, Montana
with Short Wheel Base 1997 - On

UNIT PACKAGE: 10



19379

(10297371)
Yellow Nylon

Rear Wheel Opening Moulding Clip
Top Head Size: 19/32" x 25/32"
Stem Length: 9/16"
Fits into 7/16" Hole
Pontiac Trans Sport, Montana
with Long Wheel Base 1997 - On

UNIT PACKAGE: 15



20825

(10297370)
Brown Nylon

Moulding Clip with Sealer
Top Head Size: 12mm x 20mm
Bottom Head Size: 15mm x 20mm
Stem Length: 14mm
Fits into 11mm Hole
Chevrolet Venture, Oldsmobile Silhouette, Pontiac
Trans Sport APV & Montana and Hummer 1997 - On

UNIT PACKAGE: 15



22029

(GM: 11547210)
Green Nylon

Moulding Clip with Sealer
Top Head Size: 12mm x 20mm
Bottom Head Size: 12mm x 20mm
Stem Length: 10mm
Fits into 9mm Hole
Cadillac XTS & Chevrolet Impala 2014 - 2013

UNIT PACKAGE: 10



20935

(15116576, 15282120)
Green Nylon

Body Side Moulding Clip
Head Size: 16mm x 38mm
Stem Length: 15mm
Fits into 10mm Hole
Buick Terraza, Cadillac C & K Truck, Chevrolet C, K
Truck & Uplander, GMC Arcadia, C & K Truck, Pontiac
Montana SV6 and Saturn Relay 2005 - On

UNIT PACKAGE: 15



21036

(11518988)
White Nylon

Fender, Spoiler & Roof Rack
Moulding Clip with Sealer
Top Head: 12mm x 21mm
Bottom Head: 12mm x 20mm
Stem Length: 15mm
Fits into 9mm Hole

Buick Enclave, Chevrolet SSR,
GMC Acadia, Hummer H3, S & T Trucks 2002 - On

UNIT PACKAGE: 15



21667

(11609923)
Gray Nylon

Moulding Clip with Sealer
Top Head Size: 12mm x 20mm
Bottom Head Size: 12mm x 24mm
Stem Length: 16mm

Chevrolet Camaro and Pontiac G6 2005 - On

UNIT PACKAGE: 15



21681

(GM: 25796285)
White Nylon

Moulding Clip with Sealer
Top Head Size: 6.5mm x 15mm
Bottom Head Size: 13mm x 26mm
Stem Length: 8mm
Fits into 7mm Hole

Cadillac CTS & Chevrolet Silverado
2007 - On

UNIT PACKAGE: 15



21013

(Not Available from O.E.M.)
Yellow Nylon

Rocker Panel Moulding Clip
Top Head Size: 15/32" x 13/16"
Bottom Head Size: 15/32" x 25/32"
Stem Length: 9/16"
Fits into 3/8" Hole

Hummer H3 2005 - On

UNIT PACKAGE: 15



21370

(GM: 25922739, 11570846)
Green Nylon

Rocker Moulding Clip with Sealer
Top Head Size: 12mm x 29mm
Bottom Head Size: 12mm x 20mm
Stem Length: 10mm
Fits into 9mm Hole

Buick Enclave, Cadillac SRX, Chevrolet Tahoe,
Traverse & GMC Acadia, Yukon 2009 - On

UNIT PACKAGE: 25



21200

(11588818, 11561329)
Black Nylon

Front Bumper and
Rocker Moulding Clip
Top Head Size: 18mm x 26mm
Bottom Head Size: 14mm x 20mm
Stem Length: 15mm
Fits into 10mm Hole

Cadillac STS and Corvette 2005 - On

UNIT PACKAGE: 10



22225

(GM: 92138808)
Black Nylon

Rocker Moulding Clip
Top Head Size: 15mm x 21mm
Middle Head Size: 15mm x 21mm
Bottom Head Size: 19.3mm x 25.5mm
Stem Length: 14mm
Fits into 9mm Hole

Chevrolet Caprice & SS 2011 - On
Pontiac G8 2009 - 2008

UNIT PACKAGE: 25



20951

(15236893)
Black Nylon

Rocker Panel
Moulding Clip
Top Head Size: 3/4" x 1-9/16"
Overall Height: 11/16"
Stem Length: 7/16"
Fits into 3/8" Hole

Buick Lucerne 2006 - On

UNIT PACKAGE: 15



20868

(11589182)
Black Nylon

Rocker Panel Moulding
Clip with Sealer
Head Size: 11/16" x 2-3/16"
Stem Length: 11/16"
Fits into 5/8" Hole

Hummer 2006 - On

UNIT PACKAGE: 10



20884

(11561491, 15872008)
Black Nylon

Rocker Panel Moulding Clip
with Sealer
Top Head: 20mm x 30mm
Overall Length: 28mm
Fits into 17mm Hole

Chevrolet Equinox & Pontiac Torrent 2005 - On

UNIT PACKAGE: 10



21503
(GM: 25744385)
Green Nylon

Rocker Moulding Clip
Head Size: 22mm x 46mm
Stem Length: 17mm
Fits into 10mm Hole
Cadillac 1998 - On

UNIT PACKAGE: 15



22226
(GM: 92138807)
White Nylon

Rocker Moulding Clip
Width: 31.5mm
Length: 45mm
Bottom Head Diameter: 25mm
Stem Length: 15mm
Fits into 9mm Hole
Chevrolet Caprice & SS 2011 - On
Pontiac G8 2009 - 2008

UNIT PACKAGE: 25



21177
(10363352)
Black Nylon

Rocker, Pillar and
Floor Moulding Clip
Top Head Size: 18mm x 38mm
Bottom Head Size: 22mm x 40mm
Stem Length: 33mm
Fits into 11mm Hole
Saturn Aura 2007 - On

UNIT PACKAGE: 15



19821
(10431761)
Gray Nylon

Rocker Panel Moulding Clip
Top Head Size: 11/16" x 1-1/2"
Bottom Head Size: 7/8 x 1-9/16"
Stem Length: 1-1/4"
Fits into 7/16" Hole
Chevrolet Impala, Lumina &
Monte Carlo 2000 - On

UNIT PACKAGE: 15

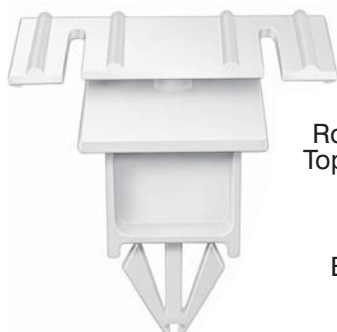

20950
(10384814)
White Nylon

Rocker Panel Moulding Clip
Top Head Size: 3/4" x 1-9/16"
Overall Height: 1-7/16"
Stem Length: 21/32"
Fits into 7/16" Hole
Buick Lucerne 2006 - On

UNIT PACKAGE: 15



20464
(10270517)
White Nylon

Rocker Panel & Fender Flare
Moulding Clip
Overall Length: 41mm
Stem Length: 13mm
Fits into 12mm Hole
Pontiac Trans Sport & Montana 1997 - On

UNIT PACKAGE: 5



21827
(GM: 11611435)
White Nylon

Moulding Clip
with Sealer
Top Head Size: 22mm x 45mm
Bottom Head Size: 25mm x 37mm
Stem Length: 15mm
Fits into 10mm Hole
Cadillac, Chevrolet & GMC 2014 - 13

UNIT PACKAGE: 10



21161
(GM: 11569697)
Green Nylon

Side Window (Rear) Reveal
Moulding Clip with Sealer
Flange Size: 10mm x 17mm
Stem Length: 20mm
Overall Length: 29mm
Fits into 8mm Hole
Buick Lucerne 2006 - On

UNIT PACKAGE: 5



21157
(11610522, 10383817)
White Nylon

Side Window (Rear) Reveal
Moulding Clip with Sealer
Top Head Size: 6mm x 11mm
Bottom Head Size: 10mm x 17mm
Stem Length: 20mm
Fits into 8mm
Buick Lucerne 2006 - On

UNIT PACKAGE: 10



22037
(GM: 15864780; 11569921)
Yellow Nylon

Rocker Moulding Clip with Sealer
Top Head Size: 9.5mm x 20mm
Bottom Head Size: 14mm x 20mm
Stem Length: 20mm
Fits into 9mm Hole
Cadillac ATS & CTS 2013 - On

UNIT PACKAGE: 10



21335
(25775903)
Green Nylon

Rocker Moulding Clip with Sealer
Top Head Size: 12mm x 16mm
Bottom Head Size: 12mm x 20mm
Stem Length: 24mm
Fits into 9mm Hole
Buick Enclave, Chevrolet Traverse,
GMC Acadia & Saturn Outlook 2007 - On

UNIT PACKAGE: 10



21375
(25774893)
Yellow Nylon

Door Moulding Clip
Top Head Size: 12mm x 16mm
Bottom Head Size: 12mm x 20mm
Stem Length: 24mm
Fits into 9mm Hole
Chevrolet Traverse 2010 - On

UNIT PACKAGE: 15



20891
(11589244, 11569973)
Yellow Nylon

Rocker Panel
Moulding Clip with Sealer
Top Head Size: 15/32" x 27/32"
Bottom Head Size: 15/32" x 25/32"
Stem Length: 1-3/8"
Fits into 7/16" Hole
Chevrolet Equinox, Pontiac Torrent
and Trucks 2005 - On

UNIT PACKAGE: 10



21739
(GM: 11611626)
White Nylon

Tailgate Cover Clip
Top Head Size: 12.5mm x 23mm
Bottom Head Size: 12.5mm x 23mm
Stem Length: 11mm
Fits into 9mm Hole
Cadillac Escalade; Chevrolet Avalanche,
Silverado, Suburban & Tahoe and GMC
Sierra 2007 - On

UNIT PACKAGE: 25



11118
(9617200)
Nylon

Roof, Inner Side Front, Rear &
Panel Headlining Clip
GM 1973-On

UNIT PACKAGE: 10

11119

Same as 11118 except for unit package quantity

UNIT PACKAGE: 100



18398
(20058837)
Nylon

Windshield Upper Garnish
Moulding Clip
GM A & G Models 1988-78

UNIT PACKAGE: 10



17666
(20632190)
Nylon

Garnish Moulding Clip
Back Window Upper &
Side Moulding Garnish
Buick LeSabre, Cadillac
Fleetwood Brougham,
Chevrolet Caprice & Impala,
Olds Delta 88 & 98, Pontiac
Bonneville & Parisienne 1989-80

UNIT PACKAGE: 10



16865
(20462090)
Nylon

Garnish Moulding Clip
Buick Century & Regal, Chevrolet
Camaro, Celebrity, Monte Carlo &
Malibu, Oldsmobile Cutlass & Ciera,
Pontiac Firebird Grand Prix & 6000
1978-On

UNIT PACKAGE: 25



9477
(4490167)
Nylon

Tailgate Belt
Moulding Fastener
Chevrolet El Camino

UNIT PACKAGE: 50



17233
(9662548)
Nylon

Headlining Wire Retainer Clip
Also Panel to Rear Bumper Filler Clip
GM 1990 - 73

UNIT PACKAGE: 50



9965
(3944866, 1244839)

Universal Moulding Fastener
GM

UNIT PACKAGE: 25

12971

Same as 9965 except for unit package quantity

UNIT PACKAGE: 10



2943
(4759145, 4761842, 4779348)

Front and Rear Fender and
Door Peak Moulding Fastener
GM

UNIT PACKAGE: 15

12966

Same as 2943 except for unit package quantity

UNIT PACKAGE: 15



19602

Chevrolet Grille Bolt Kit
For installing and attaching Grille on Chevrolet Cars
Consists of: 50 pcs. 10-24 x 1/2" Machine Screws
50 pcs. 10-24 Keps Nuts

UNIT PACKAGE: 50 Sets



14953
(GM: 15679091; Ford: N803494S)
Black Nylon

Fascia, Trim & Grille Retainer
Head Size: 15/32" x 15/32"
Stem Length: 21/32"
Fits into 1/4" Square Hole or Slot
GM 1994 - On
Ford 1985 - On

UNIT PACKAGE: 25



14727

(GM: 94221150;
Isuzu: 8942211500;
Nissan: 63844-D0100)
Black Nylon

Push-Type Retainer
Head Size: 14mm x 22mm
Stem Length: 9mm
Fits into 7mm Hole
Geo Storm 1990 - On

UNIT PACKAGE: 25



20892

(12337831)
Black Nylon

Front Bumper
Push-Type Retainer
Head Size: 14mm x 26mm
Stem Length: 14mm
Fits into 8mm Hole
Pontiac G6 2005 - On

UNIT PACKAGE: 50



14008

(14032200)
Black Nylon

Grille Attachment Retainer
Head Size: 3/4" x 19/32"
Stem Length: 19/32"
Fits into 5/16" Hole
GM 1981-On

UNIT PACKAGE: 25



22041

(GM: 92139147)
Black Nylon

Front & Rear Bumper Fascia
Push-Type Retainer
Head Size: 14mm x 21mm
Stem Length: 16mm
Fits into 8mm Hole
Chevrolet Caprice and
Pontiac G8 & GTO 2011 - 04

UNIT PACKAGE: 25



14001

(14039420)
Black Nylon

Push-Type Retainer
Head Diameter: 21/32"
Stem Length: 19/32"
Fits into 5/16" Hole
GM (Including Saturn)

UNIT PACKAGE: 25



14697

(GM: 94198687;
Honda: 90657-SA6-0030;
Mazda: N304-13-356-A)
Black Nylon

Push-Type Retainer
Head Diameter: 14mm
Stem Length: 11mm
Fits into 7mm Hole

UNIT PACKAGE: 25



19726

(94858343)
Black Nylon

Door Trim Panel Push-Type Retainer
Head Diameter: 14mm
Stem Length: 8mm (Excluding the Pin)
Fits into 6mm Hole
Geo Prizm 1998 - On

UNIT PACKAGE: 15



19645

(94858864)
Nylon

Door Trim Panel
Push-Type Retainer
Head Diameter: 14mm
Stem Length: 8mm (Excluding the Pin)
Fits into 6mm Hole
Geo Prizm 1998 - On

UNIT PACKAGE: 15



14260

(Toyota: 90467-06017;
Mazda: 9926-50-625;
GM: 20426301)
Black Nylon

Push-Type Retainer
Head Diameter: 15mm
Stem Length: 12mm
Fits into 7mm Hole

UNIT PACKAGE: 15



19243

(GM: 30008324; Suzuki: 09409-07325)
Black Nylon

Push-Type Retainer
Head Diameter: 16mm
Stem Length: 10mm (Excluding the Pin)
Fits into 9mm Hole
Front & Rear Bumper Fascia
Geo Metro 1989-On
Radiator Grille
Suzuki Esteem 1995-On

UNIT PACKAGE: 15



13457

(20451119)
Black Nylon

Front Compartment Spare Tire Retainer
Head Diameter: 43/64"
Stem Length: 23/32"
Fits into 5/16" Hole
GM

UNIT PACKAGE: 10



20577

(GM: 88970494, 88973676;
Toyota: 90467-07168)
Black Nylon

Rocker Panel & Garnish
Moulding Push-Type Retainer
Head Diameter: 20mm
Stem Length: 8mm
Fits into 7mm Hole
Pontiac Vibe 2003 - On
Lexus & Toyota 2000 - On

UNIT PACKAGE: 15



19140

(Acura: 90505-SL0-003;
GM: 94852368;
Mitsubishi: MB888869;
Toyota: 90467-08155)
Black Nylon

Push-Type Retainer
Head Diameter: 20mm
Stem Length: 21mm
Fits into 8mm Hole

Acura, Dodge Avenger, Eagle Talon, Geo Prizm
Mitsubishi Eclipse & Galant and Toyota 1993-On

UNIT PACKAGE: 5



19242

(15672149)
Black Nylon

Air Inlet Grille Panel Push-Type Retainer
Head Diameter: 13/32"
Stem Length: 11/16"
Fits into 7/32" Hole
GM Jimmy, Blazer, S-10 & Bravada 1994-On

UNIT PACKAGE: 25



17214

(GM: 10089262, 21042098;
Chry: 55075139)
Black Nylon

Push-Type Retainer
Head Diameter: 11mm (7/16")
Stem Length: 18mm (11/16")
Fits into 6mm (15/64") Hole

GM & Saturn 4 Door & Station Wagon 1987-On

UNIT PACKAGE: 25

14987

Same as 17214 except for unit package quantity

UNIT PACKAGE: 50



14990

(22538102)
Black Nylon

Push-Type Retainer
Head Diameter: 7/16"
Stem Length: 15/32"
Fits into 15/64" Hole
GM 1987 - On

UNIT PACKAGE: 50



19788

(10246149; 22657634)
Black Nylon

Rocker Panel Push-Type Retainer
Head Diameter: 11mm
Stem Length: 20mm
Fits into 6mm Hole

Achieva, Cutlass, Grand Am & Malibu 1999 - On

UNIT PACKAGE: 25



19787

(22657634)
Black Nylon

Fender & Rocker Panel
Push-Type Retainer
Head Diameter: 12mm
Stem Length: 17mm
Fits into 6mm Hole

Achieva, Cutlass, Grand Am & Malibu 1999 - On

UNIT PACKAGE: 25



14995

(GM: 10195515, Ford: N805026S;
Chry: 4696488, 6503163)
Black Nylon

Push-Type Retainer
Head Diameter: 1/2"
Stem Length: 1-13/64"
Fits into 9/32" Hole

GM, Ford & Chrysler 1987 - On

UNIT PACKAGE: 25



16859

(Nissan: 66860-01W01;
GM: 94051993)
Black Nylon

Cowl Panel to Reinforcement
Plate & Engine Splash
Shield Retainer

Head Diameter: 14mm (9/16")
Stem Length: 16mm (5/8")
Fits into 6mm (1/4") Hole

Nissan 1980-On
Geo Storm 1990-On

UNIT PACKAGE: 25



20943

(15014352)
Black Nylon

Cowl Vent
Push-Type Retainer
Head Diameter: 14mm
Stem Length: 23mm
Fits into 7mm Hole
Buick Lucerne 2006 - On

UNIT PACKAGE: 15



21112

(94530438)
Black Nylon

Fender Liner
Push-Type Retainer
Head Diameter: 15mm
Stem Length: 14mm
Fits into 6mm Hole
Chevrolet Aveo 2004 - On

UNIT PACKAGE: 25



14997

(10053182)
Black Nylon

Push-Type Retainer
Head Diameter: 19/32"
Stem Length: 13/16"
Fits into 5/16" Hole
GM 1987 - On

UNIT PACKAGE: 25



14991
(GM: 10139822; 25680782;
Ford: N808147S)
Black Nylon

Push-Type Retainer
Head Diameter: 11/16"
Stem Length: 11/16"
Fits into 1/4" Hole
GM & Ford 1987 - On

UNIT PACKAGE: 25



20265
(25663903)
Black Nylon

Radiator Support Sight Shield
Push-Type Retainer
Head Diameter: 1"
Stem Length: 1"
Fits into 1/4" Hole
Cadillac DeVille & Seville 1998 - On

UNIT PACKAGE: 10



14753
(GM: 15773445, 20452072, 20664092;
Ford: N804570S; Chry: 4638136)
Black Nylon

Radiator Shroud & Trim Retainer
Head Diameter: 11/16"
Stem Length: 7/8"
Fits into 1/4" Hole
GM 1982-On
Ford 1986-On
Chrysler 1998 - On

UNIT PACKAGE: 25



17227
(21077405)
Black Nylon

Door Handle to Door Hardware
Attachment Push-Type Retainer
Head Diameter: 7mm
Stem Length: 10mm
Fits into 5mm Hole
2 Door & 4 Door Models GM Saturn 1991-On

UNIT PACKAGE: 25



14993
(22538004)
Black Nylon

Push-Type Retainer
Head Diameter: 11/16"
Stem Length: 7/8"
Fits into 1/4" Hole
GM 1987 - On

UNIT PACKAGE: 25



17383
(GM: 94847334, 96057847;
Toyota: 90467-07066;
Suzuki: 09409-07313)
Black Nylon

Radiator Grille & Trim Panel
Push-Type Retainer
Head Diameter: 11mm
Stem Length: 14mm (Excluding the Pin)
Fits into 7mm Hole
Geo Tracker & Prizm 1992 - 89

UNIT PACKAGE: 10



16835
(GM: 10140480; Chry: 6502625)
Black Nylon

Rear Bumper Fascia Retainer
Head Diameter: 21mm (27/32")
Shoulder Length: 3mm (1/8")
Stem Length: 25mm (1")
Fits into 12mm (1/2") Hole
APV Vans 1990-On

UNIT PACKAGE: 25



11854
(14005089)
Natural Nylon

Air Conditioning Vent &
General Purpose Push-Type Retainer
Head Diameter: 7/16"
Stem Length: 9/32"
Fits into 3/16" Hole
GM 1979 - On

UNIT PACKAGE: 25



14998
(15672330, 15956470)
Black Nylon

Push-Type Retainer
Head Diameter: 27/32"
Stem Length: 1"
Fits into 13/32" Hole
GM 1987 - On

UNIT PACKAGE: 25



21246
(22690838)
Black Nylon

Door Trim Push-Type Retainer
Head Diameter: 12mm
Stem Length: 14mm (Excluding the Pin)
Fits into 6mm Hole
Chevrolet Malibu & Pontiac G6 2004 - On

UNIT PACKAGE: 25



20666
 (22677979, 22677980)
 Gray Nylon
 Door Trim Push-Type Retainer
 Head Diameter: 12mm
 Stem Length: 14mm (Excluding the Pin)
 Fits into 6mm Hole
 Chevrolet Malibu 2004 - On
 UNIT PACKAGE: 25



17162
 (GM: 96057846; Hyundai: 86155-22000;
 Toyota: 90467-07041)
 Black Nylon
 Push-Type Retainer
 Head Diameter: 15mm
 Stem Length: 8mm (Excluding the Pin)
 Fits into 6.3mm Hole
 Geo Metro & Tracker 1989 - On
 UNIT PACKAGE: 10



19297
 (11517824, 21035345)
 Black Nylon
 Liftgate Upper Window & Lower Garnish
 Moulding Push-Type Retainer
 Head Diameter: 16mm
 Stem Length: 12mm (Excluding the Pin)
 Fits into 7mm Hole
 GM Saturn 1998 - 93
 UNIT PACKAGE: 15



11699
 (GM: 472434; Chry: 6031390)
 Black Nylon
 Cowl Ledge Weatherstrip &
 Fender Liner Push-Type Retainer
 Head Diameter: 11/16"
 Stem Length: 5/8"
 Fits into 1/4" Hole
 GM 1970-On
 Chrysler 1968-On
 UNIT PACKAGE: 50



19892
 (25695687)
 Black Nylon
 Radiator Support Sight Shield
 Push-Type Retainer
 Head Diameter: 27mm
 Shoulder Length: 7mm
 Stem Length: 18mm
 Fits into 10mm Hole
 Cadillac DeVille & Seville 2000 - On
 UNIT PACKAGE: 15



14011
 (14019226, 14071289)
 Black Nylon
 Radiator Overflow Bottle/Windshield
 Washer Bottle Retainer
 Head Diameter: 21/32"
 Stem Length: 9/16"
 Fits into 5/16" Hole
 GM 1981 - On
 UNIT PACKAGE: 25



12567
 (GM: 14019205, 14019206, 16514113;
 Chry: 34201621, 6504090)
 Black Nylon
 Front Fender Mud Skirt &
 Fender Liner Push-Type Retainer
 Head Diameter: 11/16"
 Stem Length: 9/16"
 Fits into 1/4" Hole
 GM 1981 - On
 UNIT PACKAGE: 25

14007
 Same as 12567 except for unit package quantity
 UNIT PACKAGE: 50



21238
 (22718369)
 Black Nylon
 Fuel Tank Shield &
 Miscellaneous Push-Type Retainer
 Head Diameter: 26mm
 Stem Length: 12mm
 Fits into 10mm Hole
 Chevrolet Malibu & Trail Blazer 2004 - On
 UNIT PACKAGE: 25



19847
 (5973823)
 Blue Nylon
 Fascia Retainer
 Head Diameter: 7/8"
 Shoulder Length: 5/32"
 Stem Length: 25/32"
 Fits into 1/2" Hole
 GM 1979-On
 UNIT PACKAGE: 25



14010
 (GM: 14045480; Chry: 6508746-AA)
 Black Nylon
 Fascia Retainer
 Head Diameter: 1"
 Stem Length: 23/32"
 Fits into 3/8" Hole
 GM 1982 - On and Chrysler 2009 - On
 UNIT PACKAGE: 25



12757

(5973400)
Black Nylon

Fascia Retainer
Head Diameter: 1"
Shoulder Length: 1/8"
Stem Length: 3/4"
Fits into 1/2" Hole
GM 1979 - On

UNIT PACKAGE: 15

16265

Same as 12757 except for unit package quantity

UNIT PACKAGE: 50



12756

(5973996)
Brown Nylon

Fascia Retainer
Head Diameter: 1"
Shoulder Length: 1/4"
Stem Length: 7/8"
Fits into 1/2" Hole
GM 1982 - On

UNIT PACKAGE: 15



19854

(21097229)
Black Nylon

Door Handle Push-Type Retainer
Head Diameter: 7mm
Stem Length: 10mm
Fits into 5mm Hole
Saturn 2 Door & 4 Door 1999 - On

UNIT PACKAGE: 25



14016

(GM: 16500308; Chry: 6500787)
Black Nylon

Tail Light Retainer
Top Head Diameter: 3/8"
Stem Length: 7/16"
Fits into 3/16" Hole
GM & Chrysler

UNIT PACKAGE: 25



13999

(20363491)
Black Nylon

Body Side Moulding Push-Type Retainer
Top Head Diameter: 3/8"
Stem Length: 1/2"
Fits into 7/32" Hole
GM 1979 - On

UNIT PACKAGE: 25



19522

(22644361)
Black Nylon

Door Sill Trim Plate
Push-Type Retainer
Head Diameter: 12mm
Stem Length: 18mm
Fits into 6mm Square Hole
Chev. Malibu, Olds Achieva & Cutlass 1997 - On

UNIT PACKAGE: 15



17106

(GM: 22566221; Chry: 6501577)
Black Nylon

Headlight Door Push-Type Retainer
Top Head Diameter: 1/2"
Stem Length: 7/16"
Fits into 3/16" Hole
GM Blazer & Suburban 1991 - On
Chrysler New Yorker Landau & 5th Avenue 1988 - On

UNIT PACKAGE: 50



19355

(15960621)
Black Nylon

Rear Door Radio Speaker
Push-Type Retainer
Head Diameter: 17/32"
Stem Length: 1-5/64"
Fits into 1/4" Hole
GM Trucks C & K 1, 2 1995 - On

UNIT PACKAGE: 25



16816

(21047094)
Black Nylon

Push-Type Retainer
Top Head Diameter: 14mm
Stem Length: 14mm
Fits into 6mm Hole
GM Saturn 1991 - On

UNIT PACKAGE: 25



17222

(GM: 21075686;
Ford: F3LY-14570-B)
Black Nylon

Push-Type Retainer
Head Diameter: 15mm
Stem Length: 20mm
Fits into 8mm Hole
Rocker Panel, Wheel Liner & Air Inlet Duct Applications
GM Saturn 2 Door & 4 Door Models 1991-On
Ford

UNIT PACKAGE: 25



22347
(GM: 11561878)
Black Nylon

Bumper, Fender Liner, Cowl, Grille,
Air Inlet Duct, Rocker Panel, Wheel Liner,
Quarter Panel & Upper Deflector
Push-Type Retainer with Sealer
Head Diameter: 15mm
Stem Length: 21mm
Fits into 8mm Hole
Various Buick, Cadillac Chevrolet,
GMC, Hummer, Saab &
Saturn Models 1991 - On

UNIT PACKAGE: 25



17103
(GM: 15681408;
Ford: N803709S)
Black Nylon

Fascia Retainer
Head Diameter: 15mm
Stem Length: 23mm
Fits into 6mm Hole
GM & Ford 1986 - On

UNIT PACKAGE: 50



17226
(10207146, 21077323)
Black Nylon

Rear Door Rocker Panel to Underbody
Bracket Push-Type Retainer
Head Diameter: 15mm
Stem Length: 29mm
Fits into 8mm Hole
GM Saturn 4 Door Models 1991 - On

UNIT PACKAGE: 25



19801
(GM: 21077123; Chry: 6509103AA
Ford: W705436-S300)
Black Nylon

Wheel Opening Moulding
Push-Type Retainer
Head Diameter: 19/32" (15mm)
Stem Length: 3/4" (19mm)
Fits into 1/4" (6mm) Hole
Saturn 1991 - On
Ford 2002 - On
Chrysler 2010 - On

UNIT PACKAGE: 25



20542
(15994165)
Black Nylon

Bumper & Rear Wheel Apron
Push-Type Retainer
Head Diameter: 16.5mm
Stem Length: 27mm
Fits into 8mm Hole
Saturn L Series 2000 - On

UNIT PACKAGE: 25



19639
(GM: 15149708; Chry: 6506008AA)
Black Nylon

Radiator, Wheelhouse, Fender & Front
Bumper Cover Push-Type Retainer
Head Diameter: 17mm
Stem Length: 16mm
Fits into 6mm Hole
GM C & K Trucks 1999 - On
Jeep Liberty 2002 - On

UNIT PACKAGE: 25



16624
(1636632, 20687704)
Black Nylon

Front Bumper Fascia Retainer
Head Diameter: 17mm
Shoulder Length: 2mm
Stem Length: 18mm
Fits into 9.5mm (3/8") Hole
Buick Riviera/Reatta 1988 - On

UNIT PACKAGE: 25



18030
(Chry: 6501925; GM: 10134407)
Black Nylon

Push-Type Retainer
Head Size: 11/16"
Stem Length: 13/16"
Fits into 1/4" Hole
Chrysler Concorde & LHS
Dodge Intrepid & Eagle Vision 1993-On
Coolant Recovery Reservoir
GM 1992-On

UNIT PACKAGE: 25



13993
(GM: 20510029; Ford: N803362-S;
Chry: 34202672)
Black Nylon

Body Retainer
Head Diameter: 11/16"
Stem Length: 7/8"
Fits into 1/4" Hole
Ford, GM & Chrysler 1984 - On

UNIT PACKAGE: 25



13996

(20452072, 20590899)
Black Nylon

Exterior Body Retainer
Head Diameter: 11/16"
Stem Length: 7/8"
Fits into 9/32" Hole
GM 1984-On

UNIT PACKAGE: 25



20869

(GM: 88970767;
Toyota: 90467-10183)
Black Nylon

Front Fender Liner
Push-Type Retainer
Head Diameter: 18mm
Stem Length: 7.5mm Hole
Fits into 7mm Hole

Pontiac Vibe, Lexus and Toyota 1999 - On

UNIT PACKAGE: 10



20365

(10301966, 10425306)
Black Nylon

Cowl Vent Push-Type Retainer
Head Diameter: 18mm
Stem Length: 13mm
Fits into 7.5mm Square Hole
Pontiac Aztek 2001 - On

UNIT PACKAGE: 10



20988

(GM: 11589289; Chrysler: 6508863-AA)
Black Nylon

Air Distributor & Windshield Defroster
Push-Type Retainer
Head Diameter: 18mm
Stem Length: 17.5mm
Panel Range: 2.0mm - 4.5mm
Fits into 6.5mm Hole
Buick Enclave, Chevrolet Equinox,
Chevrolet & GMC S & T Trucks, GMC
Acadia and Pontiac Torrent 2002 - On

UNIT PACKAGE: 25



20888

(GM: 11561368; Chry: 6508712AA)
Black Nylon

Fender, Wheel & Bumper
Push-Type Retainer
Head Diameter: 18mm
Stem Length: 20mm
Panel Range: 3.0mm - 5.8mm
Fits into 9.5mm Hole
Chevrolet Impala & Monte Carlo and
Pontiac Grand Prix & Solstice 2004 - On
Jeep Wrangler 2000 - On

UNIT PACKAGE: 25



20880

(GM: 11589290
Chry: 6509049-AA;
Ford: W714040-S300)
Black Nylon

Air Inlet Grille, Bumper Fascia &
Front Brake Caliper Cooling Duct
Push-Type Retainer
Head Diameter: 18mm
Stem Length: 20mm
Panel Range: 4.5mm - 7.0mm
Fits into 6.5mm Hole
Buick Enclave, Cadillac CTS & STS,
Chevrolet Cobalt, Equinox & SSR, GM
Trucks and Pontiac G5 & Torrent 2002 - On
Chrysler Charger & 300 2011 - On

UNIT PACKAGE: 50



21672

(11611110)
Black Nylon

Cowl Vent Push-Type
Retainer with Sealer
Head Diameter: 18mm
Stem Length: 20mm
Fits into 6.3mm Hole
Buick Allure & LaCrosse
and Chevrolet Volt 2010 - On

UNIT PACKAGE: 15



20989

(GM: 11589291;
Ford: W713331-S300)
Black Nylon

Air Dam & Grille Push-Type Retainer
Head Diameter: 18mm
Stem Length: 22mm
Panel Range: 7.0mm - 9.5mm
Fits into 6.5mm Hole
Cadillac CTS, SRX and STS 2003 - On

UNIT PACKAGE: 25



21529

(95230842)
Black Nylon

Cowl Vent Push-Type
Retainer with Sealer
Head Diameter: 18mm
Stem Length: 22mm
Fits into 6.5mm Hole
Chevrolet Cruze 2011 - On

UNIT PACKAGE: 15



22219

(GM: 92138636)
Black Nylon

Air Baffle Push-Type Retainer
Head Diameter: 18mm
Stem Length: 23mm
Fits into 7.5mm Hole

Chevrolet Caprice 2013 - 2012
Pontiac G8 and GTO 2009 - 2004

UNIT PACKAGE: 25



16622

(10157900, 11517803, 15993201)
Black Nylon

Front Bumper Fascia Retainer
Head Diameter: 18mm
Stem Length: 23mm
Fits into 9.5mm (3/8") Hole
Olds Cutlass 1990-On
GM Lt. Truck 1996 - On



UNIT PACKAGE: 25



20359

(11519444)
Black Nylon

Bumper Cover Push-Type Retainer
Head Diameter: 18mm
Stem Length: 26mm
Fits into 10mm Hole
Oldsmobile Intrigue, Pontiac
Aztek & Grand Prix 1997 - On

UNIT PACKAGE: 25



20631

(11588988)
Black Nylon

Front Bumper Cover Push-Type Retainer
Head Diameter: 18mm
Stem Length: 26mm
Fits into 10mm Hole
Pontiac Grand Prix 2004 - On

UNIT PACKAGE: 25



20826

(11609417)
Black Nylon

Fender Apron Push-Type Retainer
Head Diameter: 19mm
Stem Length: 14mm
Panel Range: 2.7mm - 5.3mm
Fits into 8.5mm Hole

Buick Enclave & LaCrosse, Cadillac CTS, SRX & STS,
Chevrolet Cobalt, Equinox & Malibu, GM Trucks and
Pontiac G5, G6 & Torrent 2003 - On

UNIT PACKAGE: 50



20990

(GM: 15296830;
Chrysler: 5116530-AA)
Black Nylon

Fascia & General Purpose
Push-Type Retainer
Head Diameter: 19mm
Stem Length: 16mm
Panel Range: 5.0mm - 7.0mm
Fits into 8mm Hole
GM 2007 - On

UNIT PACKAGE: 25



18308

(3540858)
Black Nylon

Radiator Air Baffle
Push-Type Retainer
Large Head Diameter: 3/4"
Stem Length: 1-1/8"
Fits into 1/4" Hole
Cadillac Eldorado &
Seville 1993-On

UNIT PACKAGE: 25



19239

(GM: 11519949;
Honda: 91512-SX0-003;
Mitsubishi: MU000319)
Black Nylon

Fender, Interior Trim & Washer Tank
Push-Type Retainer
Head Diameter: 20mm
Stem Length: 11mm
Fits into 8mm Hole
Buick, Cadillac, Chevrolet &
GMC 1997 - On

UNIT PACKAGE: 25



22100

(GM: 11612035)
Black Nylon

Front Fender & Body Side Liner
Push-Type Retainer
Head Diameter: 20mm
Stem Length: 12mm
Fits into 8.5mm Hole
Chevrolet Colorado & SS and GMC
Canyon 2014 - On

UNIT PACKAGE: 25



17216

(GM: 21030249; Ford: N807389S;
Chry: 6503598)
Black Nylon

Air Baffle to Under Carriage
Push-Type Retainer
Head Diameter: 20mm
Stem Length: 20mm
Fits into 8mm Hole

GM Saturn 2 Door & 4 Door Models 1991 - On

UNIT PACKAGE: 25



16625

(10108746)
Black Nylon

Front Bumper Fascia Retainer
Head Diameter: 20mm
Stem Length: 20mm
Fits into 10mm Hole

GM Station Wagons 1991 - On

UNIT PACKAGE: 25



20991

(11589292)
Black Nylon

Bumper Fascia, Flares & Air Dam
Push-Type Retainer
Head Diameter: 20mm
Stem Length: 20mm
Panel Range: 2.0mm - 4.5mm

Fits into 8.5mm Hole
Chevrolet & GMC, C & K Trucks 2007 - On

UNIT PACKAGE: 25



19615

(15153415)
Black Nylon

Rear Bumper Cover
Push-Type Retainer
Top Head Diameter: 20mm
Stem Length: 21mm
Fits into 9mm Hole

C & K Trucks 1999 - On

UNIT PACKAGE: 25



20889

(GM: 11589293;
Ford: W712196-S300)
Black Nylon

Cowl Vent & Fender Push-Type Retainer
Head Diameter: 20mm
Stem Length: 22mm
Panel Range: 4.5mm - 7.0mm
Fits into 8.5mm Hole

Buick Century, LaCrosse & Regal, Cadillac, Chevrolet
Equinox, GM Trucks, Hummer H3 and
Pontiac Grand Prix & Torrent 1997 - On
Ford 2006 - On

UNIT PACKAGE: 25



20992

(11589294)
Black Nylon

Bumper Fascia, Fender and Toe/Floor
Panel Push-Type Retainer
Head Diameter: 20mm

Stem Length: 24mm
Panel Range: 7.0mm - 10.0mm
Fits into 8.5mm Hole

Buick Enclave & LaCrosse, Chevrolet &
GMC C & K Trucks, GMC Acadia,
Hummer H3 and Saturn Outlook 2005 - On

UNIT PACKAGE: 25



20632

(GM: 11518017)
Ford: W708530-S300)
Black Nylon

Bumper Cover & Fender Shield
Push-Type Retainer

Head Diameter: 20mm
Stem Length: 26mm
Fits into 8mm Hole

GM & Ford 1997 - On

UNIT PACKAGE: 15



18896

(21095797)
Black Nylon

Bumper Fascia
Push-Type Retainer
Large Head Diameter: 20mm
Stem Length: 28mm

Fits into 8mm Hole
GM Saturn 1996 - On

UNIT PACKAGE: 25

HAVE YOU VISITED US ONLINE?

Auveco's website has been completely renovated.
Our new design is user friendly with easy
navigation and ordering.

Product is searchable by car make, OEM number
and category, as well as, several attribute drop
downs within individual categories. All product
also has stock availability listed.

Make sure to head over to

www.auveco.com

to receive up to date information on all our products.



20863

(5480772)
Black Nylon

Lower Rocker Moulding
Push-Type Retainer
Head Diameter: 22mm
Stem Length: 13mm
Fits into 15mm Hole
Chevrolet Equinox 2005 - On

UNIT PACKAGE: 10



15043

(14103461)
Black Nylon

Bumper Fascia Retainer
Head Diameter: 7/8"
Shoulder Length: 5/32"
Stem Length: 1-3/64"
Fits into 1/2" Hole
GM 1987 - On

UNIT PACKAGE: 25



20993

(GM: 11589295;
Ford: W712665-S300)
Black Nylon

Fender, Flare, Gas Tank & Panel
Attachment Push-Type Retainer
Head Diameter: 25mm
Stem Length: 20mm
Panel Range: 3.0mm-6.0mm
Fits into 10.5mm Hole
Chevrolet Cobalt & HHR, GM C & K Trucks
and Pontiac G5 2005 - On

UNIT PACKAGE: 25



20994

(GM: 11589296)
Black Nylon

Panel Attachment &
General Purpose
Push-Type Retainer
Head Diameter: 25mm
Stem Length: 23mm
Panel Range: 6.0mm - 9.0mm
Fits into 10.5mm Hole
Buick Enclave and GMC Acadia 2007 - On

UNIT PACKAGE: 25



14020

(GM: 14093088; Ford: N802781-S)
Black Nylon

Splash Shield & Fascia Retainer
Head Diameter: 1
Stem Length: 7/8"
Fits into 1/4" Hole
GM 1979 - On

UNIT PACKAGE: 25



14147

(20547865)
Black Nylon

Body Retainer
Head Diameter: 1"
Stem Length: 7/8"
Fits into 1/4" Hole
GM 1984 - On

UNIT PACKAGE: 25



13994

(GM: 20570245, 20635065
Ford: N804614S)
Black Nylon

Splash Shield, Seat Cushion &
Spare Tire Retainer
Head Diameter: 1"
Stem Length: 7/8"
Fits into 5/16" Hole
GM 1984 - On

UNIT PACKAGE: 25



18310

(22587036)
Black Nylon

Rear Bumper Fascia
Push-Type Retainer
Head Diameter: 1"
Stem Length: 15/16"
Fits into 3/8" Hole
Chevrolet Cavalier &
Pontiac Sunfire 1995 - On

UNIT PACKAGE: 25



15702

(14101262)
Black Nylon

Plastic Cover on Engine
Compartment Retainer
Head Diameter: 1"
Shoulder Length: 1/8"
Stem Length: 15/16"
Fits into 1/2" Hole
Buick, Olds & Pontiac 1988 - On

UNIT PACKAGE: 25



15044

(22535007)
Black Nylon

Bumper Fascia Retainer
Head Diameter: 1"
Shoulder Length: 1/8"
Stem Length: 1"
Fits into 1/2" Hole
GM 1987 - On

UNIT PACKAGE: 25



15045

(10053388, 22542705)
Black Nylon

Bumper Fascia Retainer
Head Diameter: 1"
Shoulder Length: 1/8"
Stem Length: 1-7/64"
Fits into 1/2" Hole
GM 1987-On

UNIT PACKAGE: 25



15042

(10077283)
Black Nylon

Bumper Fascia Retainer
Head Diameter: 1"
Shoulder Length: 1/4"
Stem Length: 1-1/8"
Fits into 1/2" Hole
GM 1982-On

UNIT PACKAGE: 25



21361

(GM: 11561874;
Nissan: 622A2-9E000A)
Black Nylon

Bumper Cover
Push-Type Retainer
Head Diameter: 25mm
Stem Length: 29mm
Fits into 7mm Hole
Chevrolet Malibu, Pontiac G6
and Saturn Aura 2007 - On
Nissan Altima 1997 - On

UNIT PACKAGE: 15



18268

(15959832)
Black Nylon

Front License Plate Bracket
Push-Type Retainer
Head Diameter: 1"
Shoulder Length: 9/64"
Stem Length: 1-5/8"
Fits into 1/2" Hole
GM Truck 1994-On

UNIT PACKAGE: 5



18334

(15959833)
Gray Nylon

Front License Plate Bracket
Push-Type Retainer
Head Diameter: 1"
Stem Length: 1-3/4"
Fits into 1/2" Hole
GM S-10 Truck
with Decor Package
1994-On

UNIT PACKAGE: 5



17616

(21077131)
Black Nylon

Bumper Fascia
Push-Type Retainer
Head Diameter: 1-3/16"
Stem Length: 2"
Fits into 7/16" Hole
GM Saturn 1991-On

UNIT PACKAGE: 10



21176

(10382313)
Black Nylon

Sight Shield &
Trim Push-Type Retainer
Head Diameter: 24.5mm
Stem Length: 13mm
Fits into 9mm Hole
Cadillac STS, Pontiac Solstice
and Saturn Sky 2005 - On

UNIT PACKAGE: 10



20244

(25707329)
Green Nylon

Push-Type Retainer with Sealer
Head Diameter: 19mm
Stem Length: 32mm
Fits into 8mm Hole
Buick LeSabre, Oldsmobile Aurora
& Pontiac Bonneville 2000 - On

UNIT PACKAGE: 10



20163

(25099299)
Black Nylon

Radiator Sight Shield &
Air Filter Housing
Push-Type Retainer
Head Diameter: 12.5mm
Stem Length: 17mm
Fits into 6mm Hole
1994 - On

UNIT PACKAGE: 15



19417

(Chry: 6503819, 6503401;
GM: 25631448)
Black Nylon

M7.5 x 35mm
Square Drive Truss Head
Head Diameter: 22mm
Shoulder Diameter: 9mm
Foam to Bumper Fascia
Chrysler 1993 - On
GM 1997 - On

UNIT PACKAGE: 15



18353

(15960325)
White Nylon

Door Trim Panel
Push-Type Retainer
Head Diameter: 9/16"
Stem length: 41/64"
Fits into 1/4" Hole
GM Trucks C, K, 1, 2, 3 1995-On

UNIT PACKAGE: 50



21517

(25705182)
Black Nylon

M9.5 x 46mm
Bumper Fascia Nylon Screw
Head Diameter: 22mm
Square Drive
Cadillac Escalade & XLR,
Chevrolet Avalanche & Tahoe and
GMC Suburban, Yukon &
Yukon Denali 2004 - On

UNIT PACKAGE: 25



21400

(10426555)
Natural Nylon

Front Bumper
Push-Type Retainer
Top Head Diameter: 24.5mm
Bottom Head Diameter: 23.5mm
Stem Length: 36mm
Fits into 10mm Hole
Buick Allure & LaCrosse,
Chevrolet Impala & Monte Carlo
and Pontiac Grand Prix 2000 - On

UNIT PACKAGE: 15



20970

(Not Available from O.E.M.)
Black Nylon

M14 x 34mm
Bumper and Door Insulator
Nylon Screw
Head Outer Diameter: 22mm
No. 3 Square Drive
Fits into 12mm Hole
GM, Ford & Chrysler 2005 - On

UNIT PACKAGE: 25



19387

(15989487)
Nylon

Front & Rear Door Trim Panel Retainer
Astro & Safari Mini-Van,
S & T Trucks 1996-On

UNIT PACKAGE: 10



13860
(20478294)
Black Nylon

Carpet Retainer
Head Diameter: 30mm
Fits onto 6mm Stud
GM 1984-On

UNIT PACKAGE: 25



21377
(11609483)
Black Nylon

Rear Hatch Sill Plate Retainer
Top Head Diameter: 12mm
Bottom Head Size: 17mm x 34mm
Stem Length: 15mm
Chevrolet HHR 2006 - On

UNIT PACKAGE: 10



18691
(10186453)
Black Nylon

Dash Sound Barrier Retainer
Flange Diameter: 30mm
Overall Length: 52mm
Chevrolet Lumina APV,
Olds Silhouette and
Pontiac Trans Sport 1990-On

UNIT PACKAGE: 25



21302
(11610748)
Black Nylon

Grille Retainer Nut
Hex: 13mm
Washer Diameter: 25mm
Overall Height: 7mm
Mates with Auveco 21301
Cadillac SRS & SRX and
Chevrolet Camaro 2010 - On

UNIT PACKAGE: 25



16953
(12337900, 14103435)
Nylon

Upper Radiator Shield Retainer
Chevrolet Corsica & Beretta 1987-On

UNIT PACKAGE: 10



13856
(20461373)
Nylon

Rear Speaker Nut
Thread: M6 - 1.0
GM 1984-On

UNIT PACKAGE: 25



21164
(11610049)
Black Nylon

Bumper Cover Turn & Lock Retainer
Overall Length: 24.5mm
Buick Enclave, Cadillac Escalade,
Chevrolet Suburban & Traverse and
GMC Acadia & Yukon 2007 - On

UNIT PACKAGE: 25



13456
(20478295)
Nylon

Carpet Retainer
GM 1985-On

UNIT PACKAGE: 10



19472
(GM: 25535963; Ford: N811772S)
Nylon

Instrument Panel Insulation and
Front Compartment Rear Sight
Shield Turn Retainer
Buick Electra, LeSabre, Park Ave. &
Skylark, Cadillac DeVille, Oldsmobile
Achieva, Cutlass, Delta 88, 88 Royale & 98
Regency And Pontiac Bonneville
& Grand Am 1991 - On
Upper Deflector Shield
Ford

UNIT PACKAGE: 25



19440
(12040984)
Black Nylon

Wire Loom Routing Clip
Inner Diameter: 1/4"
Outer Diameter: 3/8"

UNIT PACKAGE: 15



19795
(12015631)
Black Nylon

Wire Loom Routing Clip
Inner Diameter: 1/4"
Outer Diameter: 3/8"

UNIT PACKAGE: 15



14544
(8911473)
Black Nylon

Wire Loom Routing Clip
Inner Diameter: 1/32"
Outer Diameter: 1/2"

UNIT PACKAGE: 25



20471
(8905794)
Black Nylon

Wire Loom Routing Clip
Inner Diameter: 10mm
Outer Diameter: 13mm

UNIT PACKAGE: 15



20397
(12160858)
Gray Nylon

Wire Loom
Routing Clip
Inner Diameter: 10mm
Outer Diameter: 13mm

UNIT PACKAGE: 15



14545
(8911497)
Black Nylon

Wire Loom Routing Clip
Inner Diameter: 13/32"
Outer Diameter: 19/32"

UNIT PACKAGE: 25



14546
(8911472)
Black Nylon

Wire Loom Routing Clip
Inner Diameter: 1/2"
Outer Diameter: 11/16"

UNIT PACKAGE: 25



19851
(12040983)
Black Nylon

Wire Loom Routing Clip
Inner Diameter: 1/2"
Outer Diameter: 11/16"

UNIT PACKAGE: 15



14547
(3816659, 8917320)
Black Nylon

Wire Loom Routing Clip
Inner Diameter: 3/4"
Outer Diameter: 1"

UNIT PACKAGE: 25



20665
(12160374)
Black Nylon

Wire Loom Routing Clip
Inner Diameter: 19mm
Outer Diameter: 24mm

UNIT PACKAGE: 15



16941
(12015983)
Black Nylon

Wire Loom
Routing Clip
Inner Dia.: 1"
Outer Dia.: 1-9/32"

UNIT PACKAGE: 25



20514
(12160857)
Gray Nylon

Wiring Harness Clip
Head Size: 9mm x 37mm
Fits into 6.3mm (1/4") Hole
GM

UNIT PACKAGE: 50



19853
(12176844)
Gray Nylon

Wiring Harness Clip
Size: 3/8" x 2-1/2"
Stem Length: 1/2"
Fits into 1/4" Hole
GM

UNIT PACKAGE: 25



13858
(20430956)
Nylon

Wire Clip
Models with Sunroof
GM 1984-On

UNIT PACKAGE: 25



14217
(GM: 1257702, 20346654;
Ford: 383207-S; AMC: 3693099)
Nylon

Routing Clip
GM, Ford & AMC

UNIT PACKAGE: 25



21203
(Not Available from O.E.M.)
Gray Nylon

Photo not actual size

Cable Tie
Overall Length: 155mm (6-1/8")
Width: 5mm (3/16")
Maximum Bundle Diameter: 30mm (1-3/16")
Fits into 6.3mm (1/4") Hole
GM and Universal

UNIT PACKAGE: 25



12729
(25512081)
Nylon

Engine Compartment Wire Clip
For 1/4" Diameter Tube
Buick with V-6 Diesel 1985-On

UNIT PACKAGE: 25



21284
(5482087)
White Nylon

Grille Clip
Overall Height: 14mm (9/16")
Chevrolet Equinox 2005 - On

UNIT PACKAGE: 25



18402
Phosphate & Green
Weatherstrip Clip
GM

UNIT PACKAGE: 25



22065
(Not Available from O.E.M.)
Black Phosphate

Door & Quarter Glass Channel Clip
Width: 9mm
Length: 16mm
Overall Height: 13mm
GM

UNIT PACKAGE: 50



18395
Black Phosphate
Weatherstrip Clip
GM

UNIT PACKAGE: 50

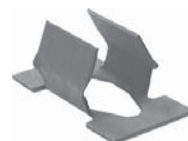

11831
(554343, 562327; 1241972)

Bumper Fastener
GM 1973-On

UNIT PACKAGE: 50



14968
(10005510)

Bumper Impact Strip Retainer
GM 1978-On

UNIT PACKAGE: 50



21187

(Chrysler: 4806226-AA; GM: 11562364)
Zinc

Front & Rear Bumper
and Grille Fastener

Screw Size: #6
Width: 10mm

Overall Height: 18mm

Buick Lucerne and Cadillac CTS & STS 2005 - On
Chrysler 300, Dodge Nitro
and Jeep Commander 2005 - On

UNIT PACKAGE: 15



11352

(3920179,
10013764)

Radiator Shroud Clip
Chevrolet 1968-On

UNIT PACKAGE: 100



21387

(15683327)
Phosphate

Front Door Interior Trim &
Instrument Panel Fastener

Width: 13/16"
Length: 15/16"

Chevrolet & GMC Trucks 2003 - On

UNIT PACKAGE: 10



20860

(15078238)
Black

Radiator Grille &
Bumper Cover Fastener

Width: 5/8"
Length: 1"

Overall Height: 5/8"
GM Trucks & Vans 1999 - On

UNIT PACKAGE: 15



19519

(GM: 16662182;
Chrysler: 6502988)
Zinc Organic

Windshield Garnish Moulding,
Rear Side Door Garnish Moulding
& Liftgate Trim Finish Panel Fastener

Width: 1/2"
Height: 9/16"

Chevrolet Camaro, Corvette, &
Venture; Oldsmobile Silhouette and
Pontiac Firebird, Grand Prix &
Trans Sport 1993 - On
Chrysler 1996 - On

UNIT PACKAGE: 15



20268

(11588650, 15748479)
Black

Garnish Moulding Fastener
Width: 1/2"

Height: 5/8"

GM Cars & Trucks 1994 - On

UNIT PACKAGE: 25



20883

(11588650)
Zinc

Garnish, Interior Trim, Bezel
& Scuff Plate Fastener

Width: 15/32"

Height: 11/16"

GM Cars & Light Trucks 2002 - On

UNIT PACKAGE: 10



21745

(GM: 11609651)
Zinc

Windshield Garnish and Interior
Trim Moulding Fastener

Screw Size: M4.2 (#8)

Stem Width: 13mm

Head Size: 13.5mm x 20.5mm
Overall Length: 22mm

Buick Enclave & Encore; Cadillac CTS, Escalade,
STS & XTS; Chevrolet Avalanche, Camaro, Cobalt,
Corvette, HHR, Impala, Malibu, Monte Carlo,

Silverado, Suburban, Tahoe & Traverse; Dodge Truck;
Ford Flex & Taurus; GMC Sierra & Yukon;

Kia Sorento & Soul; Pontiac G6 & G8;

Saturn Outlook and Suzuki Grand Vitara 2004 - On

UNIT PACKAGE: 15



17356

(96061863)
Nylon

Radiator Grille Clip

Geo Tracker 2 Wheel & 4 Wheel Drive 1989-On

UNIT PACKAGE: 5



22025

(GM: 13365058)
Black Nylon

Engine Under Cover Retainer

Head Size: 18mm x 20mm

Stem Length: 30mm

Overall Length: 32mm

Fits into 10mm x 10.5mm Hole

Buick Lacrosse & Regal, Cadillac XTS and Chevrolet
Impala, Malibu & Spark 2010 - On

UNIT PACKAGE: 15



18262

(15002520, 15682898)
Zinc Organic

Radiator Grille Retainer
GM Pickup, Van, Blazer,
Jimmy 1994-On

UNIT PACKAGE: 25



18748

(22527147)
Black Nylon

Radiator Grille Retaining Clip
Oldsmobile Calais & Delta 88 Royale 1986
Pontiac Bonneville 1991-88

UNIT PACKAGE: 15



21027

(11518531)
Zinc Organic

Fender Bracket Interior Trim, Door,
Bumper & Hood Retainer Nut
Screw Size: #8 (M4.2-1.41)
Buick Enclave & Lucerne, Chevrolet Equinox & Malibu,
Hummer and Pontiac G5, G6, G8 & Solstice 2003 - On

UNIT PACKAGE: 15



18153

(11561448, 15686142)
Zinc Phosphate

Radiator Grille Nut
Screw Size: #8
GM Trucks C & K, 1, 2 & 3 1993-On

UNIT PACKAGE: 25



22289

(GM: 11570654; Chrysler: 6509432AA
Ford: W716529-S900)
Magni-565 Blue Finish

Radiator Grille Nut
Screw Size: M4.2-1.41 (#8)
Head Size: 6mm x 16mm
Overall Height: 7mm

Buick Allure, Enclave, Encore, LaCrosse,
Lesabre, Lucerne, Rainer, Regal & Verano and
Cadillac ATS, CTS, Deville, DTS, ELR,
Escalade, SRX & STS 2000 - On
Chrysler 200, 300, PT Cruiser, Sebring, Town &
Country and Dodge Avenger, Caliber, Charger, Dart,
Grand Caravan, Ram 2500 & Ram 3500 2015 - 2006
Ford 250, 350, 450 & 550 Super Duty Trucks
2015 - 2013

UNIT PACKAGE: 25



21754

(GM: 11609952)
Magni-565 Plating

Front Bumper Specialty Nut
Screw Size: M4.2-1.41 (#8)
Head Size: 6mm x 16mm
Overall Height: 7mm
Cadillac Escalade, Chevrolet Tahoe
and GMC Yukon 2007 - On

UNIT PACKAGE: 25



21524

(11610157)
Zinc Organic

Center Console Door, Front Lights,
Grille, Instrument Panel & Lift Gate
Nut with Silicone Pad
Screw Size: M4.2-1.41 (#8)
Cadillac CTS, Chevrolet Corvette, Equinox,
Malibu & Traverse, Hummer H3, Pontiac
G6 and Saturn Ion 2003 - On

UNIT PACKAGE: 10



21753

(GM: 11562503)
Zinc Organic

Specialty Nut with Plastisol Pad
Screw Size: M6-1.0
Head Size: 13mm x 13mm
Stem Length: 8mm
Chevrolet Truck & GMC 2008 - On

UNIT PACKAGE: 10



14820

(GM: 14083173,
17988488, 17997722,
Ford: N803685S)
Phosphate

Dash Panel Nut
Screw Size: #8 (M4.2-1.41)
GM & Ford 1982-On

UNIT PACKAGE: 25



22040

(GM: 11610544)
Zinc Organic

Front Fender Panel Nut
Screw Size: M6-1.0
Overall Height: 12mm
Buick Allure, LaCrosse & Regal 2012 - On

UNIT PACKAGE: 10



19317

(15707256)
Zinc Organic

Front Fender Extension & License
Plate Bracket Retainer Nut
Screw Size: M6-1.0
GM Express & Savanna 1996-On

UNIT PACKAGE: 10



22117

(GM: 11518937)
Zinc Organic

Radiator Grille & Front End Panel Nut
Thread Size: M6-1.0
Overall Height: 11mm

Buick Allure & LaCrosse, Chevrolet Impala &
Monte Carlo, GMC Sierra & Yukon and
Pontiac Grand Prix 2004 - On

UNIT PACKAGE: 10



17508

(15632790)
Zinc Organic

Grille Clip
GM S-10 & S-15
Pick-Ups 1991-On

UNIT PACKAGE: 5



22277

(GM: 11547446)
Black Finish

Door Panel Clip
Head Size: 16.5mm x 25mm
Stem Length: 13mm

Chevrolet Colorado, Silverado,
Suburban & Tahoe and GMC Canyon,
Sierra & Yukon 2015 - On

UNIT PACKAGE: 10



17382

(14100784)
Phosphate

Bumper Valance Panel Retainer
Cadillac Eldorado & Seville
Chevrolet Lumina & Beretta 1987-On

UNIT PACKAGE: 25



20396

Zinc & Yellow

1/4" - 20 Specialty Insert
Grip: .030" - .165"
Head Diameter: 1/2"
Hex Size: 3/8"

Can be set with Auveco tool 11805

UNIT PACKAGE: 15



20742

Zinc & Yellow

M4-.7 Specialty Insert
Grip: 2mm - 3.3mm
Head Diameter: 9.5mm
Hex Size: 6.2mm

Can be set with Auveco tool 11805

UNIT PACKAGE: 15



20678

Zinc & Yellow

M5-.8 Specialty Insert
Grip: .5mm - 3.3mm
Head Diameter: 10mm
Hex Size: 7mm

Can be set with Auveco tool 11805

UNIT PACKAGE: 15



19220

(10237960)
Zinc & Yellow

M6-1.0 Specialty Insert
Grip: .7mm - 4.2mm
Head Diameter: 12.5mm
Inside Door Handle, Window Regulator &
Air Bag Module Attachment
Chevrolet Lumina, Monte
Carlo & Pontiac Grand Prix 1995-On

Can be set with Auveco tool 11805

UNIT PACKAGE: 25



20415

(GM: 15685099;
Ford: N803763-S100)
Zinc & Yellow

M6-1.0 Specialty Insert with Sealer
Grip: .65mm - 2.0mm
Head Diameter: 12mm
Hex Size: 8mm

Roof Rack, Tailgate & General Purpose GM APV Vans,
C & K Trucks and Ford Explorer 1991 - On

Can be set with Auveco tool 11805

UNIT PACKAGE: 15



20395

(10281487)
Zinc & Yellow

M6-1.0 Specialty Insert
Grip: .7mm-4.2mm
Head Diameter: 13mm
Hex Size: 9.5mm (3/8")
Front Fender

Buick, Cadillac, Corvette, L.D. Truck, Olds
Aurora and Pontiac 1997 - On

Can be set with Auveco tool 11805

UNIT PACKAGE: 15



20422

(11519952)
Zinc

M6-1.0 Specialty Insert
Grip: .7mm-4mm
Head Diameter: 13mm
Hex Size: 9.5mm (3/8")
Front Core Support & General Purpose
GM Envoy & Trailblazer 2002 - On
Can only be set with Pneumatic tool

UNIT PACKAGE: 15



22035

(GM: 11609292)
Zinc

M6-1.0 Specialty Insert with Sealer
Grip: .5mm - 4.2mm
Head Diameter: 13mm
Hex Size: 9.5mm
Roof Rack & Luggage Carrier
Buick, Chevrolet, GMC,
Hummer & Saturn 2012 - 06
Can be set with Auveco tool 11805

UNIT PACKAGE: 10



22121

(GM: 11609836)
Tin-Zinc Finish

Specialty Insert
Thread Size: M8-1.25
Grip Range: .70mm - 3.80mm
Head Diameter: 17mm
Hex Size: 12.5mm
General Purpose
Cadillac XLR &
Chevrolet Corvette 1997 - On
Can only be set with Pneumatic tool

UNIT PACKAGE: 10



20423

(11519960)
Zinc

M8-1.25 Specialty Insert
Grip: .7mm-4mm
Head Diameter: 17mm
Hex Size: 12.5mm (1/2")
Front Core Support & General Purpose
GM Envoy & Trailblazer 2002 - On
Can only be set with Pneumatic tool

UNIT PACKAGE: 15



9367

(4495047)

Front Seat Arm Support
Hinge Pin Retainer
GM

UNIT PACKAGE: 100



15459

(1247872, 15567924)

Throttle Rod Retaining Clip
For 1/4" Rod with 5/32" Groove
Outer Diameter: 19/32"
GM 1975-On

UNIT PACKAGE: 50



21351

(11588441)
Zinc

Fender, Quarter Panel & Grille
Push-On Retainer
Stud Size: 6mm
Outer Diameter: 24mm
GM & Hummer 2002 - On

UNIT PACKAGE: 50

21290

(15769308: Retainer, 15040331: Ring)
Zinc

Photos not actual size

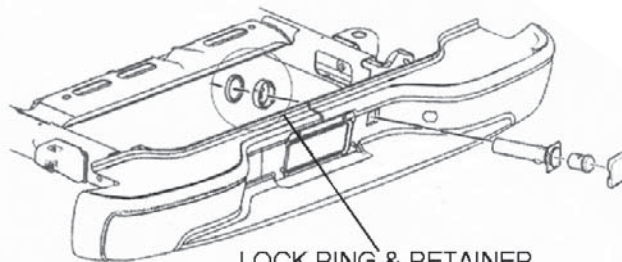

LOCK RING & RETAINER
The retainer and ring are damaged
whenever the bumper is removed.

Spare Tire Lock Cylinder Housing Retainer
& Lock Ring Kit

Retainer Outer Diameter: 72mm
Lock Ring Outer Diameter: 57mm
GM C/K, Denali, Sierra, Silverado, Suburban,
Tahoe and Yukon 1999 - On

UNIT PACKAGE: 5 Kits



20562
(9601750)

Door Lock Striker
Bolt Assembly
with PVC Plastic Bushing
Thread: 1/2" - 13
Overall Length: 2-1/4"
GM Cars &
Trucks 1991 - 73

UNIT PACKAGE: 1



17069
(16606936, 16633853)
White Nylon

Door Lock Rod Clip
Rod Size: 4mm
Head Diameter: 10mm
GM 1982-On

UNIT PACKAGE: 100



Left-Hand Side

10262
Nylon

Door Lock Rod & Hood
Latch Locking Push Rod Clip
Rod Size: 5/32"
Fits into 1/4" Hole
Chrysler, Ford, GM & AMC

UNIT PACKAGE: 20 Pieces
10 Rights - 10 Lefts



Right-Hand Side



20675
(AMC: 4003672R;
Chry: 2945108R, 4658676;
GM: 16627328, Ford: N805350S)
White Nylon

Clip for Right-Hand Side Only

UNIT PACKAGE: 25



14967
(AMC: 4003673L;
Chry: 2945109L, 4658677;
GM: 9815325, 16607593;
Ford: D2VZ-6521952A, N804344S)
Black Nylon

Clip for Left-Hand Side Only

UNIT PACKAGE: 50



18392
(20582532)
Black Nylon

Door Lock Rod Clip
Rod Size: 5/32"
Buick Regal & Roadmaster Chevrolet Caprice,
Olds Custom Cruiser & Cutlass and
Pontiac Grand Prix 1992-On

UNIT PACKAGE: 25



18393
(20582533)
Natural Nylon

Door Lock Rod Clip
Rod Size: 5/32"
Buick Regal & Roadmaster Chevrolet Caprice,
Olds Custom Cruiser & Cutlass and
Pontiac Grand Prix 1992-On

UNIT PACKAGE: 25



15673
(GM: 8891031;
Chrysler: 3454220, 4658676)
Red Nylon

Door Lock Rod Clip
Used on Right-Hand Side
Rod Size: 5/32"
GM C & K Pickups 2007 - 1999
Chrysler 1972 - On

UNIT PACKAGE: 50



15674
(GM: 8891030;
Chrysler: 3454221, 4658677)
Green Nylon

Door Lock Rod Clip
Used on Left-Hand Side
Rod Size: 5/32"
GM C & K Pickups 2007 - 1999
Chrysler 1972 - On

UNIT PACKAGE: 50



21196
(16630688)
White Nylon

Door Lock Rod Clip
Used on Right-Hand Side
Rod Size: 3/16" (5mm)
GM Pick-Up Trucks 1999 - On

UNIT PACKAGE: 25



21197

(16630689)
Black Nylon

Door Lock Rod Clip
Used on Left-Hand Side
Rod Size: 3/16" (5mm)
GM Pick-Up Trucks 1999 - On

UNIT PACKAGE: 25



18926

(14037239, 15545178)
Natural Nylon

Tailgate Rod Clip
Rod Size: 3/16"
GM Trucks C, K 1, 2, 3 1981-On

UNIT PACKAGE: 10



19658

(16629990, 16675980)
Gray Nylon

Door Lock Rod Clip
Rod Size: 5/32"
Buick, Cadillac, Chevrolet, Oldsmobile,
Pontiac & Trucks 1996 - On

UNIT PACKAGE: 15



15518

(4234830, 12337868)

Door Lock Rod Clip
GM 1964-On

UNIT PACKAGE: 25



15759

(3998009, 9711304)

Door Lock Rod Clip
GM 1956-On

UNIT PACKAGE: 50

20872

Stainless Steel
Tailgate
Support Straps



Photo not actual size

2004 - 1999 full size GM Pick-Up Trucks are equipped with galvanized, braided steel tailgate cables that may corrode, weaken and eventually break. Auveco's support straps are the ideal replacement. Our straps are stronger and more durable than cable. It mounts the same as the original cable, uses the same hardware and can be installed in 15 minutes. And can be used for both sides of the tailgate.

UNIT PACKAGE: 1

GM Truck Door Hinge Pin & Bushing Repair Kits

Why bother with the hassle of cutting and grinding off a worn door hinge and welding on a new one when you can repair the bad hinge in a fraction of the time?

With our Door Hinge Pin & Bushing Repair Kits, fixing sagging doors caused by worn hinges due to pin failure is quick. It's easy. It works. And you don't have to repaint the welded heat flash area.

Each kit is designed to repair one hinge and contains all the pins, bushings and related hardware to do the job.

Refer to Kit listings below and on following pages.

Photos not actual size.

Here's how it works:

1. Remove the door from the truck body
2. Remove the original equipment pin and bushings
3. Install the bushings into the hinge holes
4. Install the longer pin into the top hinge hole
5. Thread on the lock nut
6. Install the shorter pin into the bottom hinge hole
7. Place the washer and a nut on the shorter pin
8. Tighten the nut to pull the pin into place.
9. Slowly tighten both upper and lower lock nuts
10. Reattach the door to the truck body

Detailed instructions are included with the kit.



20485

(89025539)

Door Hinge Pin and Bushing Kit
Cadillac Escalade 2006 - 2000
Chevrolet Silverado & GMC Sierra:
1500/2500, HD / 3500, HD
2007 - 1999
Chevrolet Suburban
1500/2500 &
Tahoe 2006 - 2000
GMC Yukon
2006 - 2001

UNIT PACKAGE: 1 Kit



21092

(89025543)

Extended Cab Rear Door Hinge
Pin and Bushing Kit
Chevrolet Silverado & GMC Sierra:
1500/2500/3500
2005 - 1999
1500HD/2500HD/3500HD
2005 - 2001
1500/2500HD
Classic Hybrid LT 2007 - 2006
1500 Classic Hybrid 2007 - 2005

UNIT PACKAGE: 1 Kit

GENERAL MOTORS CLIPS & FASTENERS

Door Hinge Pin & Bushing Repair Kits

Photos not actual size



21740
(GM: 19302122)
Greaseable
Stainless Steel
Door Hinge Pin &
Bushing Kit
Repairs One (Upper or
Lower) Extended Cab,
Rear Door Hinge
GM Full-Size Pickups and
SUV's 2006 - 1999

UNIT PACKAGE: 1 Kit



21741
(GM: 19301966)
Greaseable Stainless
Steel Door Hinge Pin
& Bushing Kit
Repairs One (Upper or
Lower) Right &
Left Rear Door Hinge
Chevrolet & GMC
Full-Size Vans
2014 - 1996

UNIT PACKAGE: 1 Kit



21072
(89025546)
Greaseable
Stainless Steel
Side Cargo Door
Hinge Pin &
Bushing Kit
GM Savana Van &
Express Van
2008 - 1996

UNIT PACKAGE: 1 Kit

21610
(12338074, 15562609, 15562610, 15653790, 15691493,
15964971, 15964972, 16632192 & 16632193)



Door Hinge Pin & Bushing Kit
Repairs one Hinge
Contains one Auveco 19781 pin,
one each of Auveco bushings
16936 & 16937 and one of
17976 pin retainer
GM S & T Trucks 1994 - On

UNIT PACKAGE: 1 Kit

21644
(12338074, 15562609, 15562610, 15591860,
15691493, 15691595, 15964971, 15964972, 15967691,
16632192, 16632193, 88891731)



Door Hinge Pin & Bushing Kit
Repairs One Hinge
Contains one Auveco pin 19424, one each of
Auveco bushings 16936 & 16937 and
one of Auveco 17976 pin retainer
GM C & K Trucks 1988 - On

UNIT PACKAGE: 1 Kit



21403
(19260060)
Greaseable Stainless Steel
Door Hinge Pin, Bushing & Bracket Repair Kit
Repairs One (Upper or Lower)
Driver's Side Hinge
Cadillac Escalade 2006 - 2002
Chevrolet Avalanche 2006 - 2002
Chevrolet Silverado 2006 - 1999
Chevrolet Silverado Classic 2007
Chevrolet Suburban 2006 - 2000
Chevrolet Tahoe 2005 - 2000; GMC Sierra 2006 - 1999
GMC Sierra Classic SLE 2007; GMC Yukon 2002
GMC Yukon Denali 2004 - 2001
GMC Yukon S 2006 - 2005; GMC Yukon SLE 2000

UNIT PACKAGE: 1

**All items available in
bulk quantities.**

**Call customer service
1-800-354-9816
for a price quote**

GENERAL MOTORS CLIPS & FASTENERS

Sec. 20

Door Hinge Pin & Bushing Repair Kits

Photos not actual size



21404
(19260058)

Greaseable Stainless Steel
Door Hinge Pin, Bushing & Bracket Repair Kit
Repairs One (Upper or Lower)
Passenger's Side Hinge

Cadillac Escalade 2006 - 2002
Chevrolet Avalanche 2006 - 2002
Chevrolet Silverado 2006 - 1999
Chevrolet Silverado Classic 2007
Chevrolet Suburban 2006 - 2000
Chevrolet Tahoe 2005 - 2000; GMC Sierra 2006 - 1999
GMC Sierra Classic SLE 2007; GMC Yukon 2002
GMC Yukon Denali 2004 - 2001
GMC Yukon S 2006 - 2005 ; GMC Yukon SLE 2000

UNIT PACKAGE: 1



21406
(19260061)

Greaseable Stainless Steel
Door Hinge Pin & Bushing Repair Kit
Repairs Two Hinges

Cadillac Escalade & Escalade ESV; Chevrolet
Avalanche 4-door pickup/SUV, Silverado, Suburban
4-door extended SUV, & Tahoe 4-door SUV;
GMC Sierra, Yukon & Yukon XL 2013 - 2007

UNIT PACKAGE: 1



21405

Stainless Steel
Door Hinge Pin & Bushing Repair Kit
Repairs Two Hinges

Cadillac Escalade & Escalade ESV; Chevrolet
Avalanche 4-door pickup/SUV, Silverado, Suburban
4-door extended SUV, & Tahoe 4-door SUV;
GMC Sierra, Yukon & Yukon XL 2013 - 2007

UNIT PACKAGE: 1



21582
(GM: 19260663)

Greaseable Stainless Steel
Door Hinge Pin & Bushing Repair Kit
Repairs Two Side Cargo Door Hinges
Chevrolet Express & GMC Savana Van 2013 - 2009

UNIT PACKAGE: 1



21444
(19260063)

Greaseable Stainless Steel
Door Hinge Roller Pin Kit
Repairs one
Driver's or Passenger's Side
Lower Hinge
Chevrolet Silverado
2013 - 2007
GMC Sierra 2013 - 2007
and Related Suv's (T-900)

UNIT PACKAGE: 1



21487
(19260056)

Greaseable Stainless Steel
Door Hinge Pin &
Bushing Repair Kit
Repairs One Front
(Upper or Lower)
Door Hinge
Buick Rainier,
Chevrolet Trailblazer
and GMC Envoy
2011 - 02

UNIT PACKAGE: 1

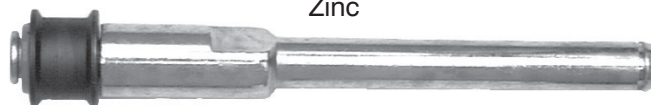

19782

(15672183)
Zinc

Door Hinge Roller Pin Assembly
Pin Diameter: 25/64"
Overall Length: 5-1/16"
Roller Outer Diameter: 3/4"
Roller Groove Diameter: 5/8"

Use with Auveco 8829 E-Type Retaining Ring
Rear Door Upper Hinge S & T Trucks 1994 - On

UNIT PACKAGE: 1



22174
(GM: 19332887)

Greaseable Stainless Steel
Door Hinge Pin and Bushing Repair Kit
Repairs Two Hinges
GMC Full Size Pick-Ups & SUV's 1998 - 1988

UNIT PACKAGE: 1



19781

(15653790)
Zinc & Yellow

Door Hinge Pin
Length: 4-1/8"
Pin Diameter: 11/32"
Shoulder Outer Diameter: 3/8"
Head Outer Diameter: 1/2"
**Use with Auveco Bushings 16936,
16937 & Pin Retainer 17976**
S & T Trucks 1994 - On

UNIT PACKAGE: 2



19725

(Not Available from O.E.M.)
Zinc

Door Hinge Roller Pin Assembly
Diameter: 9/16"
Length: 5-1/2"
Roller Outer Diameter: 3/4"
Roller Groove Diameter: 5/8"
Knurl Diameter: 19/32"
GM C & K Light Duty Trucks 2000 - 88

UNIT PACKAGE: 1

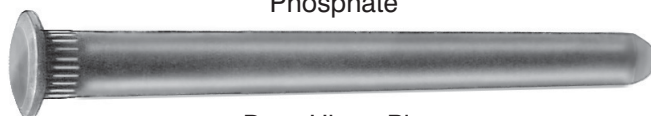

14559

(GM: 6271989, 20046147)
Phosphate

Door Hinge Pin
Length: 4-1/16"
Pin Diameter: 11/32"
Head Outer Diameter: 9/16"

Buick: Estate Wagon & LeSabre Wagon 90-82,
Electra 82, Regal 87-82, Riviera 85-82,
and all exc. Skyhawk 77-76;
Cadillac: Cimarron 88-82, Eldorado & Seville 85-82,
Fleetwood Brougham 92-82;
Chevrolet: Camaro 81-78, C & K Trucks 84 - 73
Monte Carlo, Malibu & El Camino 88-76,
Impala & Caprice 90-82, Nova 79-77;
Oldsmobile: Cutlass Supreme, Calais &
Cruiser 88-76, Delta 88 90-77, Omega 79-77,
Toronado 85-82, 98 Recency 82-77;
Pontiac: Firebird 81-78, Grand Prix 87-77, LeMans &
Grand Am 81-77 Phoenix & Ventura 79-77,
Safari & Parisienne 89-83

UNIT PACKAGE: 10

Photos not actual size

19183

(GM: 20043351)
Phosphate



Door Hinge Pin
Length: 4"
Pin Diameter: 11/32"
Head Outer Diameter: 7/16"

Buick: Skyhawk 88-82, Skylark 85-82;
Chevrolet: Cavalier 94-82, Celebrity 90-82,
Chevette 87-78, and Citation 85-80
Oldsmobile: Cutlass Ciera 95-82,
Firenza 88-82, Omega 84-80,
Pontiac: Phoenix 84-80, Sunbird 94-82,
T-1000 87-82 and 6000 91-82

UNIT PACKAGE: 10

19424

(15591860; 15691595;
5967691; 88891731)
Stainless Steel



Door Hinge Pin
Length: 5-1/4"
Pin Diameter: 11/32"
Shoulder Outer Diameter: 3/8"
Head Outer Diameter: 9/16"
GM Trucks

**Use with Auveco Bushings 16936 & 16937
& Pin Retainer 17976**
C-K Models 1988-On

UNIT PACKAGE: 4



17976

(15562610)
400 Series
Stainless Steel

Photo actual size

Door Hinge Pin Retainer
Inner Diameter: 21/64"
Outer Diameter: 9/16"
Thickness: 1/64"

**Used with 19424 &
19781 Door Hinge Pin**
GM Trucks C-K 1988-On

UNIT PACKAGE: 50

17437

(12338015, 14066728)
Zinc & Yellow



Door Hinge Pin
Length: 4-5/32"
Pin Diameter: 11/32"
Head Outer Diameter: 15/32"
GM Astro Van, Safari Van & S-10 1982-On

UNIT PACKAGE: 5



14548

(9822198)

Photo actual size

Inner Diameter: 3/8"
Outer Diameter: 1/2"
Height: 15/32"

Flange Outer Diameter: 5/8"
Buick 1975-42

Chevrolet: Monza & Vega 1980-76,
All (Exc. Corvette) 1975-62, Olds Starfire 1980-76
Pontiac: Astre & Sunbird 1980-76 and All 1975-49

UNIT PACKAGE: 25



14549

(9716926, 20345137)

Photo actual size

Thick Bushing
Inner Diameter: 11/32"
Outer Diameter: 1/2"
Height: 3/8"

Flange Outer Diameter: 19/32"
Buick 1976-On
Cadillac 1980-On

Chevrolet: All 1976-On, Corvette 1982-73
Olds (Exc. Starfire) 1980-On
Pontiac: Exc. Astre & Sunbird 1980-On

UNIT PACKAGE: 25



14550

(GM: 9721917;
Ford: D1AZ-6522841A)

Photo actual size

Inner Diameter: 11/32"
Outer Diameter: 27/64"
Height: 19/64"

Flange Outer Diameter: 19/32"
Buick (Exc. Skyhawk) 1967-On
Cadillac 1946-On

Chevrolet: Exc. Monza & Vega 1962-On,
Corvette 1956-On, GM C & K Trucks 1993 - 79
Olds Exc. Starfire 1949-On
Pontiac: Exc. Astre & Sunbird 1932-On

UNIT PACKAGE: 25



14553

(20429500)

Inner Diameter: 11/32"
 Outer Diameter: 31/64"
 Height: 23/64"
 Flange Outer Diameter: 19/32"
 Splined Outer Diameter
 All GM (Including Pick-Ups & Vans)
 1968-On

UNIT PACKAGE: 25



16936

(12338074, 15691493,
 15964971 & 16632193)

Inner Diameter: 11/32"
 Outer Diameter: 1/2"
 Height: 23/64"
 Flange Outer Diameter: 43/64"
 Splined Outer Diameter
 Side Door Upper Hinge
 GM Trucks C-K Models 1988-On

UNIT PACKAGE: 25



16937

(15562609, 15964972
 & 16632192)

Inner Diameter: 25/64"
 Outer Diameter: 17/32"
 Height: 23/64"
 Flange Outer Diameter: 11/16"
 Splined Outer Diameter
 Side Door Lower Hinge
 GM Trucks C-K Models 1988-On

UNIT PACKAGE: 25



12314

(20037597)

Photo not actual size
 Clear Knob
 GM 1952-On

UNIT PACKAGE: 1



12315

(1732326)

Photo not actual size
 Black Knob
 GM 1952-On

UNIT PACKAGE: 1



12316

(458030)

Photo not actual size
 GM Trucks 1977-On

UNIT PACKAGE: 1

TIPS FOR NAVIGATING THE CATALOG

• **Color Coded Pages**

- Yellow-** New Items
- Blue-** Metric Items
- Brown-** Electric Accessories
- Green-** Assortments, Cabinets,
 Bins and Racks
- Gray-** Key Blanks & Accessories
- Pink-** Import Car Body Hardware

• **Specification Charts**

- Body Bolts-** Pages: 88 & 121-122
- Special Tapping Screws-** Pages: 91-94 & 128-130
- License Plate Screws-** Pages: 105-106
- Retainers-** Pages: 475-489
- Push-Type Retainers-** Pages: 534-545

• **Indexes. Located in the front**

- Pictorial**
- Alphabetical**
- Numerical**

- Images are actual size unless noted otherwise
- OEM Part Cross Reference: Indexed according to OEM number and Part Number. Located in the back

Located in the front after the numerical index

- Screw Identification charts: head styles, driving recesses, point styles and sizing.
- List of common terminology with brief descriptions
- Plating and finish types with brief descriptions

15968
(E6DZ-13032A)



Adjusting Screw Assembly
Hex & Slotted Drives
Taurus & Sable 1988-86

UNIT PACKAGE: 10

15966
(E7SZ-13032-D)



#12 -28 x 1-1/2"
Adjusting Screw Assembly
R.H. Upper, L.H. Lower
Phillips Drive
T-Bird, Cougar & Continental 1988-87

UNIT PACKAGE: 5



16399
(E9TZ-13032B,
E97B-13A093BA)
Black Screw

Bronco & Ranger 1989-On

UNIT PACKAGE: 5

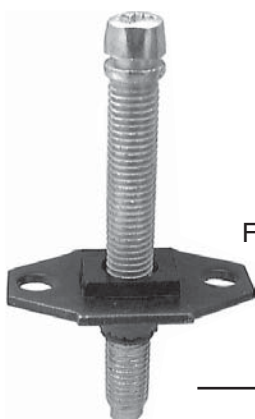

11660
(DOZB-13A-093-AA)
Zinc Screw & Phosphate Plate

1/4"-28 x 2"
Headlight Adjusting Screw
& Nut Assembly
Ford Cars & Medium Duty Trucks
1973-On

UNIT PACKAGE: 10

11661

Same as 11660 except for unit package quantity

UNIT PACKAGE: 25



12228
(FDA13021-A)
Zinc-Nylon Nut

Thread: 1/4"-28
Headlight Adjusting
Nut Mount
Ford 1980-On

UNIT PACKAGE: 10



21185
(W710793-S439)
Zinc Organic

Headlight Mounting Clip
Thread: M6-1.0
Ford Super Duty Pick-Up
2009 - 08

UNIT PACKAGE: 10



18899
(F1CZ-13A147A)
Black Nylon

Headlight Pivot Socket
Escort & Tracer
1991-On

UNIT PACKAGE: 25



15940
(E9DB-13N020AA,
E9DZ-13N129A)

Headlight Component
Pivot Retaining Clip
Ford Taurus & T-Bird and
Mercury Cougar & Sable
1989-On

UNIT PACKAGE: 25



18263
(F37Z-13N129-A)
Black

Headlight Component
Retaining Clip
Mustang & Ranger 1993-On

UNIT PACKAGE: 25



18155

(N803768-S)
Natural Nylon

Door Arm Rest Nut
Screw Size: #8
Mustang & Capri 1987-On

UNIT PACKAGE: 15



10305

White Nylon

Nylon Nut
Screw Size: #8

UNIT PACKAGE: 50



9862

(379830-S)
White Nylon

Headlight Door, Grille & Mirror Nut
Screw Size: #8 or #10
Fits into 1/4" Square Hole
Ford

UNIT PACKAGE: 50



14755

(379830-S)
White Nylon

Screw Size: #8
Width: 3/8"
Length: 3/8"
Fits into 1/4" Square Hole
Ford 1986-On

UNIT PACKAGE: 25



14756

(Ford: 379830-S; Chry: 6033677)
Black Nylon

Screw Size: #8
Width: 3/8"
Length: 3/8"
Fits into 9/32" x 9/32" Hole
Panel Thickness: 1/4"
Ford & Chrysler 1986-On

UNIT PACKAGE: 25



20245

(N806334-S,
W707157-S300)
Natural Nylon

Nylon Nut
Screw Size: M4.2 (#8)
Head Size: 10mm x 10mm
Fits into 6mm Square Hole
Ford 1999 - On

UNIT PACKAGE: 50



18383

(W700566-S300)
Natural Nylon

Screw Size: #12
Back Panel Attachment
Contour & Mystique 1995-On

UNIT PACKAGE: 25



11865

(GM: 1255823; Ford: 389360S)
Natural Nylon

Tail Light Nut
Screw Size: #6 or #8
Ford 1981-On
Front End Bezel Nut
GM 1979-On

UNIT PACKAGE: 50



12569

(Ford: N801706-S; Chry: 6501773)
Black Nylon

Screw Size: #12
Ford 1981-On

UNIT PACKAGE: 25



14754

(N802376-S)
Blue Nylon

Screw Size: #8
Width: 3/8"
Length: 1/4"
Panel Thickness: 5/32"
Fits into 1/4" Square Hole
Ford

UNIT PACKAGE: 25



20927

(N811478-S100)
Black Nylon

License Plate & Rear Bumper
Nylon Nut with Sealer
Screw Size: M6.3 (#14)
Head Size: 16mm x 16mm
Stem Length: 8mm
Fusion & Mustang 2005 - On

UNIT PACKAGE: 15



21368

(W711079-S300)
Black Nylon

Tail Light Grommet
Head Size: 13mm x 17mm
Stem Length: 10mm
Explorer, Mountaineer & Pick-Up Trucks
2006 - On

UNIT PACKAGE: 25



19277

(N804765-S)
Natural Nylon

Wheel Opening Screw Grommet
Screw Size: #8 (M4.2)
Head Size: 3/8" x 3/8"
Stem Length: 7/8"
Mustang, T-Bird, Cougar &
Continental 1993-On



UNIT PACKAGE: 50



20425

(F5RZ-17K657-A)
Natural Nylon

Windshield Washer Reservoir
Mounting Screw Grommet
Screw Size: #12
Head Diameter: 1/2"
Overall Length: 13/16"
Fits into 3/8" Sq. Hole
Ford Contour, Focus & Mystique 1995 - On

UNIT PACKAGE: 25



21362

(W708580-S300)
Black Nylon

Side Marker Tail Light &
Bumper Screw Grommet
Screw Size: M4.2 (#8)
Head Size: 11.5mm x 11.5mm
Stem Length: 18mm
Expedition, Fusion, Milan, MKZ &
Navigator 2006 - On

UNIT PACKAGE: 25



19326

(N807706-S)
Natural Nylon

Front Bumper Fascia Grommet
Escort, Explorer & Mustang 1996-On

UNIT PACKAGE: 25



21239

(W708319-S300)
White Nylon

Front Bumper Screw
Grommet with Sealer
Screw Size: M4.8 (#10)
Head Diameter: 16mm
Stem Length: 24mm
Fusion 2009 - On

UNIT PACKAGE: 25



21826

(Ford: W711031-S300)
Black Nylon

License Plate & Tail Light
Screw Grommet with Sealer
Screw Size: M6.3 - 1.81 (#14)
Head Size: 15mm x 15mm
Stem Length: 22mm
Ford Edge, Explorer, Fiesta,
Flex, Focus, Fusion & Lincoln 2014 - 06

UNIT PACKAGE: 15



20532

(W708045-S300)
Black Rubber

Rear Bumper Cover Grommet
Head Diameter: 15mm
Stem Length: 21mm
Fits into 9.5mm Hole
Use with Auveco 20531
Ford Expedition 2003 - On

UNIT PACKAGE: 25



20393

(W706575-S300)
Natural Nylon

Door Panel Screw Grommet
Screw Size: M4.2 (#8)
Stem Length: 20mm
Fits into 10mm Square Hole
Ford Escape 2001 - On

UNIT PACKAGE: 50



11841

(N-800503S)
Black Nylon

Grille Attachment Nut
Screw Size: #6
Ford 1978-On

UNIT PACKAGE: 50



21165

(W712160-S300)
Black Nylon

Headlight Grommet
Screw Size: M6 (#14, 1/4")
Head Size: 22mm x 23.5mm
Overall Height: 18mm
Expedition, F150 and
Navigator 2003 - On

UNIT PACKAGE: 15



20466

(GM: 25649667;
Ford: W705590-S300,
W710549-S300)
Natural Nylon

Screw Grommet
With Sealer
Screw Size: M4.2 (#8)
Head Size: 13mm x 22mm
Stem Length: 18mm
Back Glass Moulding & Interior Trim
Cadillac & Ford Windstar 1998 - On

UNIT PACKAGE: 15



21300

(Ford: 3M8Z-17C432-A;
Mazda: GK2A-50-798)
White Nylon

Cowl Vent Screw
Grommet with Sealer
Screw Size: M4.8 (#10)
Head Size: 15mm x 27mm
Stem Length: 13mm
Fusion, Milan, MKZ & Zephyr
and Mazda 6 2003 - On

UNIT PACKAGE: 5



21224

(Ford: F50Y-14603-A)
Black Nylon

Headlight and
Tail Light Grommet
Head Size: 18.5mm x 21.5mm
Stem Length: 18mm
Fits into 9.5mm x 21.5mm Hole
Explorer, Navigator and
Super Duty Pick-Up 2003 - On

UNIT PACKAGE: 25



20264

(N806363-S)
White Nylon

Kick Panel Grommet
Head Diameter: 23mm
Overall Length: 24mm
Used with Auveco Retainer 19760
Ford Ranger 1993-On

UNIT PACKAGE: 25



21304

(Ford: 3M8Z-16K262-A;
Mazda: GJ6A-50-ES1)
Black Nylon

Rear Bumper Grommet with Sealer
Head Size: 27mm x 30mm
Stem Length: 32mm
Fits into 17mm x 20mm Hole
Ford Fusion, Milan, MKS, MKZ
& Zephyr and Mazda 6 2003 - On

UNIT PACKAGE: 5



17317

(F1CZ-8A188-A)
Black Nylon

Radiator Grille Spacer
Ford Escort &
Mercury Tracer 1991-On

UNIT PACKAGE: 25



20530

(Not Available from O.E.M.)
Black Nylon

Radiator Shroud
Air Deflector Retainer
Head Diameter: 20mm
Stem Diameter: 13mm
Stem Length: 16mm
Ford Expedition 2003 - On

UNIT PACKAGE: 50



17195

(Isuzu: 8942180270)
Black Nylon

Grille Clip
Width: 13mm
Length: 22mm
Ford Escort, Honda, Isuzu,
Mitsubishi & Plymouth Laser

UNIT PACKAGE: 25



20171
(N807189-S100, N811353-S100)
White Nylon

Cowl Vent Grommet
Screw Size: M4.2 (#8)
Fits into 10mm x 14mm Hole
F150 Pickup, Expedition
& Windstar 1995 - On

UNIT PACKAGE: 10



19138
(Ford: F1CZ-5802316A;
Mazda: BW0A-50-792)
Black Nylon

Cowl Top Vent Grille Retainer
Ford Escort & Tracer and
Mazda 1991-On

UNIT PACKAGE: 15



19238
(F6DZ-5402316-AA)
Natural Nylon

Cowl Top Vent Grille Grommet
Use with Auveco 19237
Ford Taurus & Sable 1996-On



UNIT PACKAGE: 50



19237
(W701649-S, W704881-S300)
Black Nylon

#10 x 1-1/32"
Cowl Top Vent Grille Nylon Screw
Head Outer Diameter: 9/16"
Use with Auveco 19238
Ford Taurus & Sable 1996-On

UNIT PACKAGE: 50



17551
(Mazda: GJ21-50-H81)
Natural Nylon

Cowl Screen Grommet
Ford Probe and
Mazda 626 & MX6 1988-On

UNIT PACKAGE: 25



17552
(Mazda: GJ21-50-H82)
Natural Nylon

Cowl Screen Grommet
Ford Probe and
Mazda 626 & MX6 1988-On

UNIT PACKAGE: 25



17553
(Mazda: KA01-50-H16)
Yellow Nylon

Rear Hatch Grommet
Use with Auveco 17554
Ford Probe and Mazda MX 6 1988-On

UNIT PACKAGE: 25



17554
(Mazda: KA01-50-H15A)
Black Nylon

Rear Hatch Retainer
Use with Auveco 17553
Ford Probe and Mazda MX6 1988-On

UNIT PACKAGE: 25



18816
(N807994-S)
Black Nylon

Grille & Side Marker Light Grommet
Fits into 10mm Hole
Ford 1994-On

UNIT PACKAGE: 50



17667
Green Nylon

Tubular Nut
Hole Size: 3/8"
Lower Body Side Moulding
Lincoln Town Car 1990-On

UNIT PACKAGE: 25



19526
(N807247-S)
Natural Nylon

Rear Door & Back Window
Trim Panel Grommet
Screw Size: #12 - 24
Fits into 1/2" Hole
Lincoln Town Car 1990 - On

UNIT PACKAGE: 25



19783
(N811169S, W705550-S300)
White Nylon

Park & Turn Signal Housing Grommet
Stud Size: 7/32"
Head Diameter: 13mm
Stem Length: 9mm
Fits into 11mm Hole
F250 - F550 Trucks 1999 - On

UNIT PACKAGE: 50



22359

(Ford: W702438-S300)
Black Nylon

Radiator Grille Screw Grommet
Screw Size: M4.8 (#10)
Head Diameter: 20mm
Stem Length: 11mm
Fits into 11.5mm x 7.5mm Slot
Ford C-Max, Escape, Fiesta, Focus,
Fusion, Transit Connect and Lincoln
MKC & MKZ 2015 - 2010

UNIT PACKAGE: 25

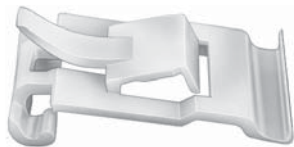

19752

(Not Available from O.E.M.)
White Nylon

Door Belt Moulding Clip
Taurus, Sable Contour &
Mystique 1998 - 95

UNIT PACKAGE: 15



20400

(YF4Z-8194-AA)
Nylon

Radiator Grille Clip
Width: 11/32"
Length: 1-9/32"
Mercury Sable 2000 - On

UNIT PACKAGE: 15



19154

(E2EB-61290C62-AA)
Nylon

Body Side
Moulding Clip
Escort & Lynx 1981-On

UNIT PACKAGE: 25



17451

(Mazda: H001-68-719B)
Nylon

Rocker Scuff
Plate Retainer
Ford Probe and Mazda MX6 1988-On

UNIT PACKAGE: 25



21306

(Not Available from O.E.M.)
White Nylon

Belt Moulding Clip
Width: 18mm
Length: 37mm
Taurus 2010 - On

UNIT PACKAGE: 10



21507

(Not Available from O.E.M.)
White Nylon

Belt Moulding Clip
Width: 25mm
Length: 36mm
Overall Height: 27mm
Edge 2009 - On

UNIT PACKAGE: 15



18377

(W701430-S300)
Black Nylon

Door Trim Retaining Clip
Contour & Mystique 1995-On

UNIT PACKAGE: 10



21790

(Ford: W709688-S300)
Black Nylon

Hood Insulation Retainer
Head Size: 28mm x 30mm
Stem Length: 14mm
Overall Height: 16mm
Ford Focus & Lincoln MKZ
2012 - On

UNIT PACKAGE: 25



20862

(4L3Z-1510182-AA)
Black Nylon

Roof Garnish Moulding Clip
Tip to Tip: 42mm
Front to Back: 12mm
Height: 21mm
Ford F-150 2005 - On

UNIT PACKAGE: 15



21506

(Not Available from O.E.M.)
Black & White Nylon

Windshield Moulding Clip with Sealer
Top Head Size: 13mm x 13.5mm
Bottom Head Size: 12mm x 14mm
Stem Length: 9mm
Explorer 2011 - On

UNIT PACKAGE: 10



22038

(Ford: W716460-S300)
White Nylon

Moulding Clip
Head Size: 11mm x 20mm
Stem length: 11mm
Overall Height: 13.5mm
Ford Fiesta, Fusion & Mustang and
Lincoln MKZ 2010 - On

UNIT PACKAGE: 25



20979

(6G1Z-5410182-C)
Blue Nylon

Wheel Flare & Rocker Panel Moulding Clip
Top Head Size: 14mm x 18mm
Bottom Head Size 14mm x 18mm
Stem Length: 11mm
Fits into 9mm Hole
Ford 500 2005 - On

UNIT PACKAGE: 25



21202

(W790173-S900)
Blue Nylon

Windshield Moulding Clip with Sealer
Top Head Size: 14mm x 18mm
Bottom Head Size: 19mm x 18mm
Stem Length: 10mm
Fits into 9mm Hole
Flex 2009 - On

UNIT PACKAGE: 10



20817

(W710528-S300)
White Nylon

Moulding Clip with Sealer
Top Head Size: 14mm x 20mm
Bottom Head Size: 15mm x 20mm
Stem Length: 12mm
Fits into 9mm Hole
Lincoln Navigator 2003 - On

UNIT PACKAGE: 15



21198

(Not Available from O.E.M.)
White Nylon

Door Cladding
Moulding Clip with Sealer
Top Head Size: 15mm x 20mm
Bottom Head Size: 20mm x 24mm
Stem Length: 11mm
Fits into 9mm Hole
Edge and Lincoln MKX 2007 - On

UNIT PACKAGE: 10



22124

(Ford: W716352-S300)
White Nylon

Rocker Panel & Door
Moulding Clip with Sealer
Top Head Size: 12mm x 20mm
Bottom Head Size: 12mm x 20mm
Stem Length: 14mm
Fits into 9mm Hole
Ford Edge, Mustang &
Mustang G.T. 2015 - On

UNIT PACKAGE: 25



21669

(W716497-S300)
Gray Nylon

Bumper Moulding Clip
with Sealer
Top Head Size: 12mm x 20mm
Bottom Head Size: 12mm x 24mm
Stem Length: 16mm
Escape 2013 - On

UNIT PACKAGE: 10



21668

(W715201-S300)
White Nylon

Rocker Panel
Moulding Clip with Sealer
Top Head Size: 12mm x 20mm
Bottom Head Size: 15mm x 20mm
Stem Length: 15mm
Escape 2013 - On

UNIT PACKAGE: 15



22099

(Ford: W716351-S300)
White Nylon

Wheel Opening &
Rocker Moulding Clip
Top Head Size: 12mm x 20mm
Bottom Head Size: 12mm x 20mm
Stem Length: 14mm
Fits into 9mm Hole
Ford Escape &
Lincoln MKC 2013 - On

UNIT PACKAGE: 25



22033

(Ford: W716503-S300)
White Nylon

Rocker Panel & Deck Lid
Moulding Clip with Sealer
Top Head Size: 15mm x 20mm
Bottom Head Size: 20mm x 20mm
Stem Length: 14mm
Fits into 9mm Hole
Ford Fusion & MKZ 2013 - On

UNIT PACKAGE: 25



21174

(W713590-S300)
White Nylon

Windshield Moulding Clip with Sealer
Top Head Size: 14mm x 18mm
Bottom Head Size: 15mm x 18mm
Stem Length: 11mm
Fits into 9mm Hole
Flex 2009 - On

UNIT PACKAGE: 15



21522

(Not Available from O.E.M.)
Gray Nylon

Fender & Rocker
Moulding Clip with Sealer
Top Head Size: 14mm x 18mm
Bottom Head Size: 18mm x 21mm
Stem Length: 15mm
Fits into 9mm Hole
Explorer 2011 - On

UNIT PACKAGE: 25



21523

(Not Available from O.E.M.)
White Nylon

Rocker Moulding Clip with Sealer
Top Head Size: 14mm x 18mm
Bottom Head Size: 14mm x 18mm
Stem Length: 15mm
Fits into 9mm Hole
Lincoln MKS 2010 - On

UNIT PACKAGE: 10



20981

(Not Available from O.E.M.)
White Nylon

Wheel Flare
Moulding Clip with Sealer
Top Head Size: 14mm x 29mm
Bottom Head Size: 14mm x 29mm
Stem Length: 16mm
Fits into 9mm Hole
Explorer 2006 - On

UNIT PACKAGE: 15



20968

(Not Available from O.E.M.)
Yellow Nylon

Wheel Lip Moulding Clip
Head Size: 15mm x 51mm
Stem Length: 11mm
Fits into 10mm Hole
Expedition & Navigator 1998 - On

UNIT PACKAGE: 15



21230

(Not Available from O.E.M.)
White Nylon

Fender Flare Moulding Clip
Top Head Size: 14mm x 34mm
Bottom Head Size: 14mm x 33mm
Stem Length: 14mm
Fits into 9mm Hole
Explorer 2007 - On

UNIT PACKAGE: 25



21148

(Not Available from O.E.M.)
White Nylon

Drip Rail Moulding Clip with Sealer
Width: 1-11/32"
Overall Height: 11/16"
500, Montego, Sable &
Taurus 2005 - On

UNIT PACKAGE: 15



21000

(F57B-16241-AA)
White Nylon

Fender Moulding Clip
Head Size: 15mm x 51mm
Stem Length: 11mm
Fits into 8mm Hole
Explorer & Others 2005 - On

UNIT PACKAGE: 15



20358

(F6DZ-5410182-AA)
Black Nylon

Rocker Panel Moulding Clip
Head Size: 13mm x 39mm
Stem Length: 14mm
Fits into 9mm Hole
Sable, Taurus & Lincoln LS2000
1996 - On

UNIT PACKAGE: 10



20663
(F57Z-16241-AB,
W709767-S300)
Black Nylon

Rocker Panel Moulding Clip
Head Size: 14mm x 40mm
Stem Length: 11mm
Ford Mustang 2001 - On

UNIT PACKAGE: 15



20977
(6G1Z-5410182-A)
Gray Nylon

Rocker Panel Moulding Clip
Top Head Size: 22mm x 30mm
Overall Height: 18mm
Ford 500 2005 - On

UNIT PACKAGE: 15



19441
(F1TZ-7810182-A)
Black Nylon

Rocker Panel and
Ground Effects Moulding Clip
Explorer, Expedition & F150
1991-On

UNIT PACKAGE: 25



18498
(W700614S300)
Black Nylon

Door Trim Clip
Contour & Mystique 1995-On

UNIT PACKAGE: 10



20965
(F4ZZ-6310182-A)
Black Nylon

Rocker Panel and
Ground Effects Moulding Clip
Head Size: 16mm x 50mm
Stem Length: 14mm
Fits into 9mm Hole
Mustang 1995 - On

UNIT PACKAGE: 15



17602
(F1CZ-61101B04-A)
Natural Nylon

Body Side &
Rocker Panel Moulding Clip
Escort GT 1991-On

UNIT PACKAGE: 15



21319
(Not Available from O.E.M.)
White Nylon

Ground Effect
Moulding Clip
Head Size: 20mm x 40mm
Stem Length: 14mm
Overall Height: 30mm
Fits into 9mm Hole
Ford 2008 - On

UNIT PACKAGE: 10



20392
(Not Supplied by O.E.M.)
White Nylon

Moulding Clip
Head Diameter: 3/4"
Stem Length: 15/32"
Fits into 5/16" Hole
Ford Expedition, Explorer &
Mountaineer 2001 - On

UNIT PACKAGE: 10



21219
(Not Available
from O.E.M.)
Yellow Nylon

Fender Flare Moulding Clip
Top Head Size: 14.5mm x 33.5mm
Bottom Head Size: 15mm x 45mm
Stem Length: 14mm
Fits into 11mm Hole
F-450 & F-550 Truck 2009 - On

UNIT PACKAGE: 10



20355
(W705849-S300)
Nylon

Front End Moulding Clip
Top Head Size: 1/2" x 13/16"
Bottom Head Size: 11/16" x 25/32"
Stem Length: 3/8"
Ford 2000 - On

UNIT PACKAGE: 10



20936

(Ford: W707388-S300;
Mazda: 9XG0-73-88X0)
Black Nylon

Front Bumper Cover Moulding Clip
Bottom Head Size: 18mm x 20mm
Stem Length: 10mm
Fits into 8mm x 12mm Hole
Ford Escape 2001 - On
Mazda Tribute 2006 - 01

UNIT PACKAGE: 10



19345

(W702412-S300)
Nylon

Pillar Trim Clip
Contour & Mystique 1995-On

UNIT PACKAGE: 50



18882

(Ford: KA80-51-PR6;
Mazda: EA01-50-048)
Black Nylon

Body Side Lower
Wide Moulding Grommet
Ford Probe & Mazda MX6 1993-On

UNIT PACKAGE: 10



19413

(F7UZ-15238A32)
Black Nylon

Door Panel Screw Cover
Head Diameter: 3/4" (19mm)
Fits into 5/8" (16mm) Hole
Ford Econoline E150 1997 - On

UNIT PACKAGE: 25



20194

(W701223-S300)
Black Nylon

Cowl Grille Screw Cover
Outer Diameter: 13mm
Use with Auveco Fastener 20193
Contour, Focus & Mystique 1995 - On

UNIT PACKAGE: 50



20193

(W703842-S300,
W703919-S300)
Black Nylon

With Zinc & Yellow Screw

Cowl Grille Fastener Nylon Retainer
Length Under Head: 38mm
Replaces Auveco 18497
Contour, Focus & Mystique 1995 - On

UNIT PACKAGE: 15



14953

(Ford: N803494S; GM: 15679091)
Black Nylon

Fascia, Trim & Grille Retainer
Head Size: 15/32" x 15/32"
Stem Length: 21/32"
Fits into 1/4" Square Hole or Slot
Aerostar, Escort & Lynx 1985-On
GM 1994 - On

UNIT PACKAGE: 25



17450

(Ford: E8BZ-17C756C,
Mazda: BF67-50-235)
Black Nylon

Bumper Cover Retainer
Head Size: 20mm x 30mm
Stem Length: 11mm
Fits into 10mm Hole
Ford Festiva 1988-On
Mazda 323 1986-On

UNIT PACKAGE: 10



15366

(Ford: E7GZ-17A904-B;
Mazda: BF67-50-033)
Nylon

Bumper Retainer
Head Size: 20mm x 30mm
Stem Length: 11mm
Fits into 10mm Hole
Mercury Tracer 1987-On

UNIT PACKAGE: 10



17060

(Ford: E92Z-17C756C;
Mazda: GJ21-50-034)
Black Nylon

Bumper Cover Retainer
Head Size: 20mm x 30mm
Stem Length: 20mm
Fits into 10mm Hole
Ford Probe & Mazda MX6 1989-On

UNIT PACKAGE: 10



20923

(Ford: 3M8Z-1502316-A;
Mazda: GJ6E-50-715A)
Black Nylon

Cowl Vent
Push-Type Retainer
Head Size: 8.5mm x 12mm
Stem Length: 9mm
Fits into 5mm Hole
Fusion, Milan & Zephyr 2006 - On
Mazda 5 & 6 2003 - On

UNIT PACKAGE: 15



21172

(W713202-S300,
W713445-S300)
Black Nylon

Bumper Push-Type Retainer
Head Diameter: 13mm
Stem Length: 18mm
Fits into 8mm Hole
Fusion 2006 - On

UNIT PACKAGE: 15



14988

(N805229S)
Black Nylon

Push-Type Retainer
Head Diameter: 7/16"
Stem Length: 11/16"
Fits into 15/64" Hole
Ford 1987 - On

UNIT PACKAGE: 25



22058

(Ford: N807673-S)
Black Nylon

Tailgate Push-Type
Retainer
Head Diameter: 14mm
Stem Length: 9mm
Fits into 7mm Hole
Ford Explorer Sport Trac 2010 - 2007

UNIT PACKAGE: 10



14995

(GM: 10195515;
Ford: N805026S;
Chry: 4696488, 6503163)
Black Nylon

Push-Type Retainer
Head Diameter: 1/2"
Stem Length: 1-13/64"
Fits into 9/32" Hole
GM, Ford &
Chrysler 1987 - On

UNIT PACKAGE: 25



14992

(Ford: N803946S;
Chry: 6502871)
Black Nylon

Push-Type Retainer
Head Diameter: 19/32"
Stem Length: 29/32"
Fits into 1/4" Hole
Ford & Chrysler 1987 - On

UNIT PACKAGE: 50



20191

(YS4Z-16K262-AA)
Black Nylon

Push-Type Retainer
Head Diameter: 16mm
Stem Length: 18mm
Fits into 6mm Hole
Focus 2000 - On

UNIT PACKAGE: 25



22178

(Ford: W707365-S300)
Black Nylon

Front Fender
Push-Type Retainer
Head Diameter: 13mm
Stem Length: 10mm
Fits into 7mm Hole
Ford Edge 2015 - On

UNIT PACKAGE: 10



18893

(N806322-S)
Black Nylon

Trim Panel Push-Type Retainer
Head Diameter: 11/16"
Stem Length: 1/2"
Fits into 1/4" Hole

UNIT PACKAGE: 15



14991

(GM: 10139822; 25680782;
Ford: N808147S)
Black Nylon

Push-Type Retainer
Head Diameter: 11/16"
Stem Length: 11/16"
Fits into 1/4" Hole
GM & Ford 1987 - On

UNIT PACKAGE: 25



18894

(N807578-S, N808332-S)
Black Nylon

Trim Panel
Push-Type Retainer
Head Diameter: 11/16"
Stem Length: 3/4"
Fits into 1/4" Hole

UNIT PACKAGE: 15



14753

(GM: 20664092;
Ford: N804570S; Chry: 4638136)
Black Nylon

Trim Retainer
Head Diameter: 11/16"
Stem Length: 7/8"
Fits into 1/4" Hole
Ford 1986-On
Chrysler 1998 - On

UNIT PACKAGE: 25



18895

(N807577-S, N808331-S)
Black Nylon

Trim Panel Push-Type Retainer
Head Diameter: 11/16"
Stem Length: 1-3/32"
Fits into 1/4" Hole
Aerostar & Windstar

UNIT PACKAGE: 15



21703

(Ford: W716510-S300)
Black Nylon

Lower Radiator Shield
Push-Type Retainer
Head Diameter: 18mm
Stem Length: 12mm
Fits into 7mm Hole
Ford Fusion 2013 - On

UNIT PACKAGE: 10



17632

(Mazda: B092-51-833;
Ford: MB-455-56143, W705845-S300;
Hyundai: 86590-28000)
Black Nylon

Push-Type Retainer
Head Diameter: 18mm
Stem Length: 12mm
Fits into 8mm Hole
Mazda & Ford Aspire

UNIT PACKAGE: 10



20545

(N811283-S)
Black Nylon & Santoprene Rubber

Trim Panel Push-Type Retainer
Head Diameter: 18mm
Stem Length: 18mm
Fits into 6.3mm Hole
Ford Expedition & Navigator 1997 - On

UNIT PACKAGE: 25



21098

(Ford: W706092-S300;
Chrysler: 6508197-AA)
Black Nylon

Front Air Shield, Splash Guard &
Heat Shield Push-Type Retainer
Head Diameter: 18mm
Stem Length: 18mm
Fits into 6.4mm Hole
Ford Taurus 2008 - On
Dodge Ram 2006 - On

UNIT PACKAGE: 25



20367

(W706713-S300)
Black Nylon

Bumper Cover Push-Type Retainer
Head Diameter: 18mm
Stem Length: 18mm
Fits into 8mm Hole
Ford Escape 2001- On

UNIT PACKAGE: 25



21089

(W710250-S300)
Black Nylon

Rear Bumper Push-Type Retainer
Head Diameter: 18mm
Stem Length: 18mm
Fits into 8mm Hole
Edge 2007 - On

UNIT PACKAGE: 25





19849
 (Not Available from O.E.M.)
 Black Nylon & Santoprene Rubber
 Bumper Push-Type Retainer
 Head Diameter: 18mm
 Stem Length: 18mm
 Fits into 8mm Hole
 Taurus & Sable 2000 - On
 UNIT PACKAGE: 25



13469
 (N802737-S)
 Black Nylon
 Under Hood Retainer
 Head Diameter 3/4"
 Stem Length 1/2"
 Fits into 1/4" Hole
 Tempo & Topaz
 UNIT PACKAGE: 25



16858
 (Nissan: 63844-01A00;
 Ford: MNA01-56145, NA01-56145;
 Kia: MNA01-56-145;
 Mazda: NA01-56-145)
 Black Nylon
 Push-Type Retainer
 Head Diameter: 20mm
 Stem Length: 18mm
 Fits into 8mm Hole
 Nissan 1980-On
 Probe & Aspire 1995-On
 Kia & Mazda
 UNIT PACKAGE: 25



14994
 (N804837S)
 Black Nylon
 Push-Type Retainer
 Head Diameter: 1"
 Stem Length: 29/32"
 Fits into 1/4" Hole
 Ford 1987 - On
 UNIT PACKAGE: 50



11702
 (D6EA-1A100-AA)
 Natural Nylon
 Wheel Ornament Push-Type Retainer
 Head Diameter: 25/64"
 Stem Length: 19/32"
 Fits into 9/32" Hole
 Ford 1976 - On
 UNIT PACKAGE: 50



11705
 (387843-S)
 Black Nylon
 Fender Shield Retainer
 Head Diameter: 19/32"
 Stem Length: 5/8"
 Fits into 1/4" Hole
 Ford 1978-On
 UNIT PACKAGE: 50



20310
 (383142-S)
 Black Nylon
 Grille to Headlight Bracket
 Push-Type Retainer
 Head Diameter: 5/8"
 Stem Length: 7/16"
 Fits into 1/4" Hole
Replaces Auveco 10214
 Ford
 UNIT PACKAGE: 50



20273
 (Ford: N808791;
 Chry: 5GC71RC3AA, 5GF92RC3AA)
 Gray Nylon
 Interior Trim, Dash & Console
 Push-Type Retainer
 Head Diameter: 19mm
 Shoulder Diameter: 10mm
 Shoulder Length: 7mm
 Stem Length: 22mm
 Fits into 9mm Hole
 Dodge Durango &
 Ford Pick-Ups 1997 - On
 UNIT PACKAGE: 25



11706
 (387944-S)
 Black Nylon
 Grille to Metal
 Stamping Retainer
 Head Diameter: 3/4"
 Shoulder Length: 1/4"
 Stem Length: 11/16"
 Fits into 1/4" Wide Slot
 Ford Truck 1978-On
 UNIT PACKAGE: 50



20233
 (W705956-S300)
 Black Nylon
 Cowl Push-Type Retainer
 Head Diameter: 25mm
 Shoulder Diameter: 10mm
 Shoulder Length: 3mm
 Stem Length: 12mm
 Fits into 9mm Hole
 Lincoln LS 1999 - On
 UNIT PACKAGE: 15



15522
(N805231S)
Black Nylon

Push-Type Retainer
Head Diameter: 5/8"
Stem Length: 17/32"
Fits into 1/4" Hole
Taurus, Topaz & Sable 1989-On

UNIT PACKAGE: 50



19607
(XL3Z-17E971-AA)
Natural Nylon

Front Bumper Cover
Push-Type Retainer
Head Diameter: 16mm
Stem Length: 12mm
Fits into 10mm Hole
F150 & F250 Trucks 1999-On

UNIT PACKAGE: 25



20516
(W706182-S300)
Black Nylon

Headlight Mounting &
Deck Lid Push-Type Retainer
Head Diameter: 20mm
Hex: 10mm
Stem Length: 13mm
Fits into 8mm Hole
Ford Expedition, Explorer & Focus 2000 - On

UNIT PACKAGE: 25



19638
(Chry: 4805405AA;
Ford: 1L5Z-17K826AA)
Black & White Nylon

Push-Type Retainer
Head Diameter: 34mm
Stem Length: 20mm
Fits into 8mm Hole
Chrysler 1998-On
Ford Trucks 2005 - On

UNIT PACKAGE: 15



17478
(Mazda: B101-68-252-00)
Black Nylon

Interior Trim Push-Type Retainer
Head Diameter: 14mm
Stem Length: 16mm
Fits into 6mm Hole
Ford Probe and Mazda MX6 1988-On

UNIT PACKAGE: 25



22349
(Ford: W719367-S300)
Black Nylon

Push-Type Retainer
Head Diameter: 14mm
Stem Length: 18mm
Fits into 8mm x 11mm Hole
Ford

UNIT PACKAGE: 15



19801
(GM: 21077123; Chry: 6509103AA,
Ford: W705436-S300)
Black Nylon

Wheel Opening Moulding
Push-Type Retainer
Head Diameter: 19/32" (15mm)
Stem Length: 3/4" (19mm)
Fits into 1/4" (6mm) Hole
Saturn 1991 - On
Ford 2002 - On
Chrysler 2010 - On

UNIT PACKAGE: 25

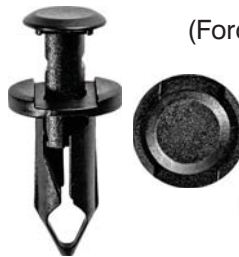

17222
(Ford: F3LY-14570-B; GM: 21075686)
Black Nylon

Push-Type Retainer
Head Diameter: 15mm
Stem Length: 20mm
Fits into 8mm Hole
Rocker Panel, Wheel Liner &
Air Inlet Duct Applications
Ford
GM Saturn 1991 - On

UNIT PACKAGE: 25



17103
(GM: 15681408; Ford: N803709S)
Black Nylon

Fascia Attachment Push-Type Retainer
Head Diameter: 15mm
Stem Length: 23mm
Fits into 6mm Hole
GM & Ford 1986-On

UNIT PACKAGE: 50



13993
(Ford: N803362-S; GM: 20510029,
Chry: 34202672)
Black Nylon

Body Retainer
Head Diameter: 11/16"
Stem Length: 7/8"
Fits into 1/4" Hole
Ford, GM & Chrysler 1984 - On

UNIT PACKAGE: 25



21024

(Ford: 5R3Z-54310D12-AAA,
6E5Z-7850980-AAA;
Mazda: GJ21-68-885B-02)
Black Nylon

Trim Panel Push-Type Retainer
Head Diameter: 18mm
Stem Length: 10mm
Fits into 6mm Hole
Fusion & Mustang 2005 - On
Mazda 1992 - On

UNIT PACKAGE: 15



18206

(GJ21-68885-B69)
Gray Nylon

Push-Type Retainer
Head Diameter: 18mm
Stem Length: 12mm
Fits into 6mm Hole
Probe & Mazda MX6 1989-On

UNIT PACKAGE: 25



16726

(N808048S, W705532-S300)
Black Nylon

Front Bumper Stone
Deflector Retainer
Head Diameter: 18mm
Stem Length: 18mm
Fits into 6.3mm (1/4") Square Hole
Bronco, Ranger & Explorer 1989-On

UNIT PACKAGE: 25



22227

(Ford: W718088-S300)
Black Nylon

Fender Apron
Push-Type Retainer
Head Diameter: 18mm
Stem Length: 20mm
Fits into 7mm Hole
Ford Fusion 2015 - On

UNIT PACKAGE: 25



20989

(GM: 11589291; Ford: W713331-S300)
Black Nylon

Air Dam & Grille Push-Type Retainer
Head Diameter: 18mm
Stem Length: 22mm
Panel Range: 7.0mm - 9.5mm
Fits into 6.5mm Hole
GM 2003 - On
Ford

UNIT PACKAGE: 25



14018

(N803716-S)
Black Nylon

Fascia Retainer
Head Diameter: 18mm
Stem Length: 23mm
Fits into 7mm Hole
Mustang/Capri 1985-On

UNIT PACKAGE: 25



17216

(GM: 21030249; Ford: N807389S;
Chry: 6503598)
Nylon

Air Baffle to Under Carriage
Push-Type Retainer
Head Diameter: 20mm
Stem Length: 20mm
Fits into 8mm Hole

UNIT PACKAGE: 25



20889

(GM: 11589293; Ford: W712196-S300)
Black Nylon

Cowl Vent & Fender
Push-Type Retainer
Head Diameter: 20mm
Stem Length: 22mm
Panel Range: 4.5mm - 7.0mm
Fits into 8.5mm Hole
GM 1997 - On
Edge, Fusion, Lincoln MKX, Milan
and Zephyr 2006 - On

UNIT PACKAGE: 25



20632

(GM: 11518017; Ford: W708530-S300)
Black Nylon

Bumper Cover & Fender Shield
Push-Type Retainer
Head Diameter: 20mm
Stem Length: 26mm
Fits into 8mm Hole
GM & Ford 1997 - On

UNIT PACKAGE: 15



20993

(GM: 11589295;
Ford: W712665-S300)
Black Nylon

Fender, Flare, Gas Tank & Panel
Attachment Push-Type Retainer
Head Diameter: 25mm
Stem Length: 20mm
Panel Range: 3.0mm - 6.0mm
Fits into 10.5mm Hole
GM 2005 - On
Ford

UNIT PACKAGE: 25



22284
(Ford: W718365-S300)
Black Nylon

Front Fender, Cowl Grille,
Rocker & Mudguard
Push-Type Retainer
Head Diameter: 25mm
Stem Length: 24mm
Fits into 8.5mm Hole
Ford Mustang and Transit
Connect and Lincoln
MKC 2014 - On

UNIT PACKAGE: 10



13994
(GM: 20570245; Ford: N804614S)
Black Nylon

Spare Tire Retainer
Head Diameter: 1"
Stem Length: 7/8"
Fits into 5/16" Hole

UNIT PACKAGE: 25



15701
(N804674-S)
Black Nylon

Push-Type Retainer
Head Diameter: 25mm
Stem Length: 27mm
Fits into 7mm Hole
Mustang & Capri

UNIT PACKAGE: 50



18503
(W701054-S300)
Black Nylon

Front Bumper Push-Type Retainer
Head Diameter: 1"
Stem Length: 1"
Fits into 5/16" Hole
Contour & Mystique 1995-On

UNIT PACKAGE: 25



19244
(N808847-S)
Black Nylon

Trunk Trim Panel Push-Type Retainer
Head Diameter: 1"
Stem Length: 11/16"
Fits into 1/4" Square Hole
Taurus & Sable 1996-On

UNIT PACKAGE: 25



19337
(N808908-S)
Black Nylon

Headlight Accessory
Push-Type Retainer
Head Diameter: 14mm
Stem Length: 23mm
Fits into 6.3mm (1/4") Hole
Mustang 1996 - On

UNIT PACKAGE: 10



14020
(Ford: N802781-S; GM: 14093088)
Black Nylon

Splash Shield &
Fascia Retainer
Head Diameter: 1"
Stem Length: 7/8"
Fits into 1/4" Hole

UNIT PACKAGE: 25



20518
(W705957-S300, W706519-S300)
Black Nylon

Radiator Sight Shield
Push-Type Retainer
Head Diameter: 24.5mm
Stem Length: 14mm
Fits into 9mm Hole
Lincoln LS 2000 - On

UNIT PACKAGE: 10



14019
(Ford: N803421-S, Chry: 6501590)
Black Nylon

Splash Shield & Fascia Retainer
Head Diameter: 1"
Shoulder Length: 1/8"
Stem Length: 7/8"
Fits into 5/16" Hole

UNIT PACKAGE: 25



20169
(W701971-S)
White Nylon

Door Trim Panel Push-Type Retainer
Head Diameter: 15mm
Stem Length: 13mm
Fits into 7mm Hole
Lincoln LS 2000 - On

UNIT PACKAGE: 25



20363
 (Not Available from O.E.M.)
 White Nylon
 Door Trim Panel Push-Type Retainer
 Top Head Diameter: 15mm
 Bottom Head Diameter: 20mm
 Overall Length: 32mm
 Fits into 9mm Hole
 Ford 2001 - On

UNIT PACKAGE: 25



19511
 (W704958-S300)
 White Nylon
 Rear Door Lower Trim Panel
 Push-Type Retainer
 Round Head Diameter: 19/32"
 Wedge Shaped Head Diameter: 29/32"
 Stem Length: 11/16"
 Fits into 3/8" Hole
 Lincoln Town Car 1998 - On

UNIT PACKAGE: 25



22234
 (Ford European: 1257376)
 Black Nylon
 Door Trim Panel Push-Type
 Retainer with Sealer
 Top Head Diameter: 16mm
 Bottom Head Diameter: 18mm
 Stem Length: 11mm
 Fits into 8mm Hole
 Ford Focus & Focus C-Max 2010 - 1998

UNIT PACKAGE: 15



20970
 (Not Available from O.E.M.)
 Black Nylon
 M14 x 34mm
 Bumper and Door Insulator
 Nylon Screw
 Head Outer Diameter: 22mm
 No. 3 Square Drive
 Fits into 12mm Hole
 GM, Ford & Chrysler 2005 - On

UNIT PACKAGE: 25



19472
 (GM: 25535963; Ford: N811772S)
 Nylon
 Upper Deflector Shield

UNIT PACKAGE: 25



18386
 (W701133-S300)
 Black Nylon
 Routing Clip
 Contour & Mystique 1995-On
 UNIT PACKAGE: 25



14217
 (GM: 1257702, 20346654;
 Ford: 383207-S
 AMC: 3693099)
 Nylon

Routing Clip
 UNIT PACKAGE: 25



12622
 (D9AB-14A163JC)
 Nylon

Wire Routing Clip
 Stem: 5/16" x 3/4"
 Ford 1980-On

UNIT PACKAGE: 25



17164
 (E0VY-13A506-A)
 Nylon
 Rear Light Wiring Retainer
 Width: 3/8"
 Length: 1-7/16"
 Stem: 9/32" x 7/16"
 Ford 1979-On

UNIT PACKAGE: 50



20483
 (2F1Z-9A317-BA)
 Black Nylon
 Fuel Line Retainer Clip
 For 3/8" Fuel Line
 Ford Taurus & Mercury Sable
 6 Cylinder 3.0 L Engine
 with Fuel Injection 2002 - On

UNIT PACKAGE: 25



20482
(2F1Z-9A317-AA)
Natural Nylon

Fuel Line Retainer Clip
For 5/16" Fuel Line
Ford Taurus & Mercury Sable
6 Cylinder 3.0 L Engine
with Fuel Injection 2002 - On

UNIT PACKAGE: 25



21445
(1R3Z-18D434-BA)
Gray Nylon

Heater Hose Coupler Retainer
Overall Height: 3/4"
For use with 3/4" Heater Hose
Mustang 2004 - 01 and
F250 - F550 Truck 2007 - 03

UNIT PACKAGE: 10



17643
(N802239-S, N806191-S1901)
Natural Nylon

Fuel Line Retainer Clip
For 5/16" Fuel Line
Ford with Fuel Injection 1980-On

UNIT PACKAGE: 25



16954
(386299-S)
Nylon

Hood Prop Rod Clip
Rod Diameter: 5/16"
Ford Cars 1975-On

UNIT PACKAGE: 25



17642
(N802241-S, N806190-S1901)
Black Nylon

Fuel Line Retainer Clip
For 3/8" Fuel Line
Ford with Fuel Injection 1980-On

UNIT PACKAGE: 25



18504
(W702380-S300)
Yellow Nylon

Hood Prop Rod Clip
Fits 6mm Rod
Contour & Mystique 1995-On

UNIT PACKAGE: 5



21127
(7L3Z-9S317-B)
Pink Nylon

Fuel Line Clip
For 3/8" Fuel Line
F Series Pick-Up 2004 - On

UNIT PACKAGE: 5



22304
(Ford: W715544-S300)
Black Nylon

Hood Release Cable Clip
Holds 6.3mm (1/4") Dia. Tube/Cable
Fits into 7mm Hole
Overall Height: 21mm
Ford Edge, F-150, Fusion & Mustang
and Lincoln MKZ 2010 - On

UNIT PACKAGE: 25



21214
(4F1Z-9A317-AA)
White Nylon

Fuel Line Retainer Clip
Head Size: 3/8" x 5/8"
Overall Height: 21/32"
For 5/16" Fuel Line Hose
Taurus 2004 - On

UNIT PACKAGE: 15



19536
(F65Z-15020C34-AA)
Black Nylon

Cowl Vent Plug
Head Diameter: 21/32"
Expedition & F150/250
1996 - On

UNIT PACKAGE: 25



21126
(7L3Z-9S317-A)
Pink Nylon

Fuel Line Clip
For 5/16" Fuel Line
F Series Pick-Up 2004 - On

UNIT PACKAGE: 5



10837
(D3AA-90826-AA)
Nylon

Speed Control Rod to Throttle Pivot
Ford

UNIT PACKAGE: 10



18387
(91GBA611A08BEAW)
Nylon

Headrest Clamp
Contour & Mystique 1995-On
UNIT PACKAGE: 10



18102
(Ford: N806624-S191;
Chry: 6502776)

Rear Light Assembly Retainer
Ford Explorer 1991-On
UNIT PACKAGE: 25



22289
(GM: 11570654; Chrysler: 6509432AA
Ford: W716529-S900)
Magni-565 Blue Finish

Radiator Grille Nut
Screw Size: M4.2-1.41 (#8)
Head Size: 6mm x 16mm
Overall Height: 7mm
Buick Allure, Enclave, Encore, LaCrosse,
Lesabre, Lucerne, Rainer, Regal & Verano and
Cadillac ATS, CTS, Deville, DTS, ELR,
Escalade, SRX & STS 2000 - On
Chrysler 200, 300, PT Cruiser, Sebring, Town &
Country and Dodge Avenger, Caliber, Charger, Dart,
Grand Caravan, Ram 2500 & Ram 3500 2015 - 2006
Ford 250, 350, 450 & 550
Super Duty Trucks 2015 - 2013

UNIT PACKAGE: 25



14820
(N803685S)

Dash Panel Nut
Screw Size: #8 (M4.2-1.41)
Taurus/Sable

UNIT PACKAGE: 25



19823
(N806511-S32)
Phosphate & Olive Drab

Parking Light Retainer Nut
Screw Size: #8 (M4.2 - 1.41)
Ford Vans 1997 - On

UNIT PACKAGE: 25



22272
(Ford: W713617-S439)
Zinc

Specialty Nut with Silicon Rubber Seal
Screw Size: M4.2-1.41
Width: 11.7mm
Length: 16.5mm
Overall Height: 8mm
Ford Escape, Explorer, Flex, Fusion, Mustang,
Ranger & Taurus and Lincoln MKS, MKT, MKZ,
Milan & Zephyr 2009 - On

UNIT PACKAGE: 15



12606
(E1EB-61046A48-BA)

Lower Finish Panel Clip
Ford 1981-On

UNIT PACKAGE: 25

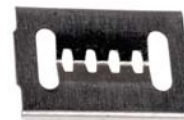

17003
(Ford: F32Z-17C756-S
Mazda: GJ21-50-049)

Bumper Cover Retainer
Front & Rear Bumpers
Ford Festiva and
Mazda 1988 - On

UNIT PACKAGE: 50



20546
(N808342-S307)
Black Phosphate

Air Cabin Filter Fastener
Size: 5/8" x 25/32"
Ford Taurus & Sable 1995 - On

UNIT PACKAGE: 50



19838
(Not Available from O.E.M.)
Dacromet 320

Front Bumper Chrome
Strip Fastener
Size: 5/8" x 1"
Flange Size: 7/32" x 1"
Grip Range: .039" - .098" (1mm - 2.5mm)
Ford Explorer 1999 - On

UNIT PACKAGE: 10



19421
(F7UZ-1513284-BA)
Zinc Organic

Front Door Scuff
Plate Retainer
Econoline Van E150/350 1997-On

UNIT PACKAGE: 25



21745

(GM: 11609651)
Zinc

Windshield Garnish and
Interior Trim Moulding Fastener
Screw Size: M4.2 (#8)
Stem Width: 13mm
Head Size: 13.5mm x 20.5mm
Overall Length: 22mm
Ford Flex & Taurus, Dodge, GM,
Kia & Suzuki 2004 - On

UNIT PACKAGE: 15



14895

(Ford: N803638-S36B)

Top Vent Grille
(Water Deflector)
Mounting Clip
Escort & Lynx 1984 - On

UNIT PACKAGE: 25



13472

(Ford: 386285;
AMC: 3230375)
Nylon

Air Cleaner Wing Nut
Self Threading
Size: 1/4", 6mm
Ford and AMC

UNIT PACKAGE: 10



20396

Zinc & Yellow

1/4" - 20 Specialty Insert
Grip: .030" - .165"
Head Diameter: 1/2"
Hex Size: 3/8"

Can be set with Auveco Tool 11805

UNIT PACKAGE: 15



20421

(N811257-S100)
Zinc & Olive Drab

M5-.8 Specialty Insert with Sealer
Grip: .5mm-2.5mm,
Head Diameter: 10mm
Hex Size: 7mm
General Purpose

Can be set with Auveco Tool 11805

Ford Escape, Excursion,
Expedition, Explorer, Navigator &
Mountaineer 2001 - On

UNIT PACKAGE: 15



20678

Zinc & Yellow

M5-.8 Specialty Insert
Grip: .5mm-3.3mm
Head Diameter: 10mm
Hex Size: 7mm

Can be set with Auveco Tool 11805

UNIT PACKAGE: 15



20401

(W706172-S309,W708384-S309)
Zinc & Yellow

M6-1.0 Specialty Insert with Sealer
Grip: .5mm-4.2mm
Head Diameter: 13mm
Hex Size: 9.5mm (3/8")
Roof Rack

Can be set with Auveco Tool 11805

Ford Escape, Excursion, Expedition, Explorer,
Navigator & Mountaineer 2000 - On

UNIT PACKAGE: 15



21215

(W710791-S437)
Zinc

Quarter Glass & Luggage Rack
Specialty Insert with Sealer
Thread: M6-1.0

Grip: .51mm - 3.18mm
Head Diameter: 13mm
Hex: 9.5mm (3/8")

Can be set with Auveco Tool 11805

Expedition & Navigator 2007 - On

UNIT PACKAGE: 15



20415

(GM: 15685099;
Ford: N803763-S100)
Zinc & Yellow

M6-1.0 Specialty Insert with Sealer
Grip: .65mm - 2.0mm
Head Diameter: 12mm
Hex Size: 8mm

Roof Rack, Tailgate & General Purpose

Can be set with Auveco Tool 11805

GM APV Vans, C & K Trucks & Ford Explorer 1991 - On

UNIT PACKAGE: 15



19436

(N808182-S309)
Zinc & Yellow

Roof Rack Mounting Nut Insert
Thread : M6 - 1.0
Grip: .7mm - 3.17mm
Head Diameter: 13mm

Can be set with Auveco Tool 11805

Explorer & Expedition 1997-On

UNIT PACKAGE: 10



20776
(W708513-S437)
Zinc

M8-1.25 Specialty Insert
Grip: .7mm - 3.8mm
Head Diameter: 22mm
Hex Size: 12.7mm (1/2")
Frame Area
Ford Trucks 2004 - On

UNIT PACKAGE: 15



20153
(YL3Z-1521970-AA)
White Door Lock Pawl
Right-Hand Side

Ford Continental, Contour, Explorer,
Mountaineer, Mystique, Ranger, Sable
& Taurus and Mazda Truck 1996 - On

UNIT PACKAGE: 1



20195
(YL3Z-1521971-AA)
Pink Door Lock Pawl
Left-Hand Side

Ford Continental, Contour, Explorer,
Mountaineer, Mystique, Ranger, Sable
& Taurus and Mazda Truck 1996 - On

UNIT PACKAGE: 1



17118
(E6DZ-5421971-A,
F3LY-6321971A)
Nylon

Door Lock Pawl
Left-Hand Side
Ford Taurus & Sable 1986-On

UNIT PACKAGE: 10



17119
(E6DZ-5421970-A,
F3LY-6321970-A)
Nylon

Door Lock Pawl
Right-Hand Side
Ford Taurus & Sable 1986-On

UNIT PACKAGE: 10



20630
(F8DZ-54265A99-AA)
White Nylon

Door Latch Guide
Width: 23mm
Length: 36mm
Taurus & Sable 1998 - On

UNIT PACKAGE: 15



Left-Hand Side

Door Lock Rod & Hood
Latch Locking Push Rod Clip
Rod Size: 5/32"
Fits into 1/4" Hole
Chrysler, Ford, GM & AMC

UNIT PACKAGE: 20 Pieces
10 Rights - 10 Lefts



Right-Hand Side

20675

(AMC: 4003672R;
Chry: 2945108R, 4658676;
GM: 16627328; Ford: N805350S)
White Nylon

Clip for Right-Hand Side Only

UNIT PACKAGE: 25

14967

(AMC: 4003673L;
Chry: 2945109L, 4658677;
GM: 9815325, 16607593;
Ford: D2VZ-6521952A, N804344S)
Black Nylon

Clip for Left-Hand Side Only

UNIT PACKAGE: 50



15675
(E6AZ-5421952-A, 390523S)
Yellow Nylon

Door Lock Rod Clip
Rod Size: 5/32"
Ford Products 1986-On

UNIT PACKAGE: 25



17122
(E6DZ-5421952A,
E83Z-5421952B)
White Nylon

Door Lock Rod End Clip
Rod Size: 5/32"
Taurus, Sable, Tempo, Topaz,
T-Bird & Cougar, Aerostar, Bronco,
Explorer, Mountaineer, Pick-Up,
Ranger & Windstar 1986-On

UNIT PACKAGE: 10



18914

(Not Supplied by O.E.M.)
PVC Plastic

Door Lock Striker Bushing
Inner Diameter: 1/2"
Outer Diameter: 11/16"
Length: 7/8"
Ford 1972-On

UNIT PACKAGE: 50



18890

(3W7Z-5422008-AA,
6W1Z-5422008-A,
E9FZ-5822008-A,
F67Z-7822008-AA,
XW1Z-5422008-AA)

Door Lock Striker Bolt Assembly
Thread: M10-1.50
Ford, Lincoln & Mercury 1980-On

UNIT PACKAGE: 1

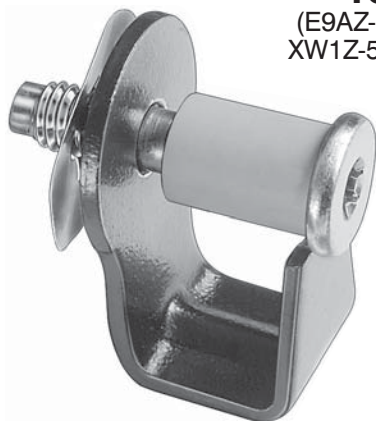

18891

(E9AZ-5422008-A;
XW1Z-5822008-AA)

Door Lock Striker Bolt Assembly
Thread: 7/16-14
Ford, Lincoln & Mercury 1983-On

UNIT PACKAGE: 1

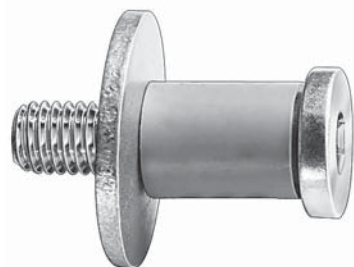

18892

(D2AZ-6522008-A)

Door Lock Striker Bolt Assembly
Thread: 7/16"-14
Cars 1980-73
E100/350 Vans (Back Door) 1986-80

UNIT PACKAGE: 1



14550

(GM: 9721917;
Ford: D1AZ-6522841A)

Inner Diameter: 11/32"
Outer Diameter: 27/64"
Height: 19/64"
Flange Outer Diameter: 19/32"
Buick (Exc. Skyhawk) 1967-On
Cadillac 1946-On
Chevrolet: Exc. Monza & Vega 1962-On,
Corvette 1956-On, GM C & K Trucks 1993 - 79
Olds Exc. Starfire 1949-On
Pontiac: Exc. Astre & Sunbird 1932-On

UNIT PACKAGE: 25



14551

(D90Z-6522841A)

Inner Diameter: 11/32"
Outer Diameter: 31/64"
Height: 19/64"
Flange Outer Diameter: 19/32"
Ford 1973-On

UNIT PACKAGE: 25



Photo not actual size

Door Hinge Pin
Pin Diameter: 11/32"
Length Under Head: 3-3/8"
Head Diameter: 9/16"
Mustang 1993 - 79
Tempo & Topaz 1994 - 90
Capri 1986 - 80

UNIT PACKAGE: 10



Photo not actual size

Door Hinge Pin
Length: 3-1/2"
Pin Diameter: 11/32"
Knurl Diameter: .358"
Head Outer Diameter: 9/16"
Use with Auveco 8829 E-Type Retaining Ring
Ranger, F150, F250 & F350 1998 - 80

UNIT PACKAGE: 5

FORD MOTORS AND CHRYSLER PRODUCTS

CLIPS & FASTENERS

Sec. 20

13030
(E2GZ-6723342A)
Black Nylon



Photo not actual size
Window Crank Handle
UNIT PACKAGE: 1

12470
(D1FZ-6222600-A,
D2FZ-6222600-A)



Photo not actual size
Door Handle
UNIT PACKAGE: 1

CHRYSLER PRODUCTS CLIPS & FASTENERS



11371
(3691599)
#12-28 x 1-1/2"
Headlight Adjusting Screw
& Nut Assembly
Chrysler 1975-On

UNIT PACKAGE: 10



13466
(6032516)
Black Nylon

License Plate Nut
Screw Size: #12
Chrysler

UNIT PACKAGE: 25

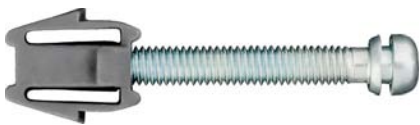

10760
(3574085)
Gray Nylon

#12-28 x 1-1/2"
Headlight Adjusting Screw
& Nut Assembly
Chrysler 1972 - On

UNIT PACKAGE: 10



9377
(Chry: 6000943;
AMC: 8934-201-263)
White Nylon

Radiator Grille Nut
Screw Size: #8
Chrysler & AMC-Renault

UNIT PACKAGE: 100

11653
Same as 10760 except for unit package quantity

UNIT PACKAGE: 25

11654
Same as 10760 except for unit package quantity

UNIT PACKAGE: 100



12735
(GM: 1370853; Chry: 6029501;
VW: 179-813-883)
Natural Nylon

Headlight Bezel Nut
Screw Size: #6

UNIT PACKAGE: 50



8419
(2524525)
Natural Nylon

Headlight Bezel Nut
Screw Size: #8 or #10
Chrysler

UNIT PACKAGE: 50



10305
Nylon

Nylon Nut
Screw Size: #8

UNIT PACKAGE: 50



21632

(Mitsubishi: MU480001)
Natural Nylon

Screw Size: M3.5 (#6)
Head Size: 10mm x 10mm
Stem Length: 7mm
Fits into 6mm x 6mm Hole
Chrysler Avenger, Colt,
Jeep Eagle Talon, Laser & Sebring
and Mitsubishi Eclipse 2000 - 1984

UNIT PACKAGE: 50



14756

(Chry: 6033677;
Ford: 379830-S)
Black Nylon

Screw Size: #8
Width: 3/8"
Length: 3/8"
Panel Thickness: 1/4"
Fits into 9/32" x 9/32" Hole
Chrysler & Ford 1986-On

UNIT PACKAGE: 25



19485

(6027958)
Natural Nylon

License Plate Nut & Door Lock
Remote Control Switch Bracket Nut
Screw Size: #14 (1/4")
Fits into 3/8" x 3/8" Hole
Chrysler 1984 - On

UNIT PACKAGE: 10



19640

(6505161AA)
White Nylon

Bumper Fascia Grommet
Screw Size: M4.2 (#8)
Head Diameter: 14mm x 18mm
Snaps into a 9mm x 11mm Hole
LH & LHS Series 1998-On

UNIT PACKAGE: 25



12569

(Ford: N801706-S;
Chry: 6501773)
Black Nylon

Screw Size: #12
Ford 1981 - On

UNIT PACKAGE: 25



13647

(6031234)
White Nylon

Radiator Grille Nut
Screw Size: #8
Chrysler

UNIT PACKAGE: 25



21236

(6508072-AA)
Black Nylon

Headlight Nylon Nut
Screw Size: M5.5 (#12)
Head Size: 15mm x 15mm
Stem Length: 10mm
Fits into 10.5mm x 11mm Hole
Jeep Grand Cherokee &
Commander 2005 - On

UNIT PACKAGE: 50



20179

(6035401)
Nylon

Door Trim Panel Nylon Nut
Screw Size: M4.2 (#8)
Head Size: 16mm x 16mm
Stem Length: 10mm
Caravan, Town & Country
and Voyager 1996 - On

UNIT PACKAGE: 25



18034

(6503108)
Black Nylon

Luggage Compartment Trim Nylon Nut
Screw Size: #8
Chrysler Concorde & LHS,
Dodge Intrepid & Eagle Vision 1993-On

UNIT PACKAGE: 25



20267

(6505703AA)
Tan Nylon

Tail Light Nylon Nut
Screw Size: #8 (M4.2)
Head Size: 5/8" x 5/8"
Stem Length: 3/8"
Jeep Grand Cherokee 2000 - On

UNIT PACKAGE: 15



14218

(6031183)
Black Nylon

Screw Size: #6 or #8
Chrysler

UNIT PACKAGE: 50



19793

(6504072)
Black Nylon

Tail Light Housing
Grommet
Head Diameter: 16mm
Stem Length: 10mm
Snaps into 12mm Hole
Dakota & Ram Trucks 1997 - On

UNIT PACKAGE: 25



12566

(Chry: 6032061;
GM: 25508532)
Black Nylon

Grille attachment Grommet
Chrysler & GM 1981-On

UNIT PACKAGE: 25



12713

(Chry: 6031869;
GM: 1264963;
AMC: 8934-201-602)
Nylon

High Torque Screw Grommet
Chrysler, GM
& AMC-Renault

UNIT PACKAGE: 25



14037

(GM: 15596280;
Chry: 6035274)
Black Nylon

Cowl Vent Nut
Screw Size: #6 or #8

UNIT PACKAGE: 25



20667

(4860375-AB)
White Nylon

Cowl Vent Grommet
Screw Size: M4.8 (#10)
Head Size: 14mm x 20mm
Caravan, Town & Country and
Voyager Mini-Vans 2004 - On

UNIT PACKAGE: 50



20524

(6035821)
Black Nylon

Door Panel & Fender Shield
Screw Grommet
Screw Size: #8
Head Size: 1/2" x 21/32"
Stem Length: 7/16"
Dodge Vans, Durango & Sebring 1996 - On

UNIT PACKAGE: 25



17354

(6501699)
Black Nylon

Cowl Screen Nut
Screw Size: #8
Chrysler Mini-Vans & Cars 1990-On

UNIT PACKAGE: 25



18825

(6503373)
Black Nylon

Cowl & Dash Panel Screw Grommet
Screw Size: #8
Cirrus & Stratus 1995-On

UNIT PACKAGE: 15



20275

(Not Supplied by O.E.M.)
White Nylon

Door Panel Grommet
Head Diameter: 19mm
Stem Length: 12mm
Fits into 9mm Hole

Use with Auveco 20274
LH Series 2000 - On

UNIT PACKAGE: 25



20468

(6506852-AA)
Green Nylon

Trim Panel Grommet
Head Diameter: 17mm
Stem Length: 12mm
Fits into 8mm Hole
Sebring & Stratus 2001 - On

UNIT PACKAGE: 50



21231
(4784018-AA)
Green Nylon

Door Panel Grommet
Head Diameter: 19mm
Stem Length: 12mm
Fits into 9mm Hole
Use with Auveco 20274
Chrysler LH Series 2000 - On

UNIT PACKAGE: 25



21213
(Not Available from O.E.M.)
Black Nylon

Tail Light Assembly Grommet
Head Diameter: 19mm
Stem Length: 11mm
Fits into 12mm Hole
Dodge Pick-Ups 1500 & 2500 Series
2006 - On

UNIT PACKAGE: 25

**Please place orders in
Unit Package quantities,
not based on pieces needed**



21025
(MB645307)
Black Nylon

Back Glass Lower Moulding,
Quarter Glass Moulding &
Spoiler Grommet with Sealer
Head Size: 12mm x 16mm
Stem Length: 14mm
Dodge Avenger & Stealth and
Chrysler Sebring and Mitsubishi 1991 - On

UNIT PACKAGE: 15



20769
(4857751AA)
Natural Nylon

Tail Light Grommet
Head Size: 17mm x 19mm
Overall Length: 21.5mm
Chrysler Pacifica 2004 - On

UNIT PACKAGE: 25



20525
(Not Available from O.E.M.)
Black Nylon

Headlight Mounting
Panel Grommet
Head Size: 16mm x 22mm
Stem Length: 20mm
Jeep Grand Cherokee 1999 - On

UNIT PACKAGE: 25



20356
(4759514AB)
Black Rubber

Rubber Grommet
Head Diameter: 15mm
Stem Length: 11mm
Fits into 9mm Hole
Floor Pan Plug &
Luggage Compartment Carpet
LH, LHS & Concorde 1997 - On

UNIT PACKAGE: 50



20581
(MR478263)
Black Rubber

Bumper Cover & Garnish Moulding
Grommet with Sealer
Head Diameter: 16mm
Stem Length: 20mm
Fits into 9mm Hole
Use with Auveco 20580
Sebring & Stratus and Mitsubishi Eclipse 2000 - On

UNIT PACKAGE: 15



22028
(Chrysler: 4806271-AA)
Black Rubber

Rear Lamp Mounting, Sensor
Bracket & Interior Trim Grommet
Head Diameter: 15mm
Stem Length: 21mm
Overall Length: 25mm
Fits into 9mm Hole
Chrysler Mini-Van and Jeep 200,
Caliber, Compass & Patriot 2007 - On

UNIT PACKAGE: 15



20962
(55156879-AB)
Black Nylon

Tail Light Grommet
Head Size: 20mm x 31mm
Receives 10mm Ball Stud
Jeep Commander 2006 - On

UNIT PACKAGE: 25



20964

(5159077-AA)
Black Nylon

Rear Bumper Clip
Stem Length: 15/32"
Overall Length: 31/32"
Jeep Grand Cherokee 2005 - On

UNIT PACKAGE: 25



17195

(Isuzu: 8942180270)
Black Nylon

Grille Clip
Width: 13mm
Length: 22mm
Ford Escort, Honda, Isuzu,
Mitsubishi & Plymouth Laser

UNIT PACKAGE: 25



13843

(6003861)
Nylon

Deck Lid Moulding Clip
Chrysler 1984-On

UNIT PACKAGE: 25



12794

(6003609)
Nylon

Roof Side Moulding Clip
Chrysler 1977-On

UNIT PACKAGE: 50



13927

(6003774, 6003965)
Nylon

Body Side Moulding Clip
Chrysler 1981-On

UNIT PACKAGE: 25



13616

(6003219)
Nylon

Moulding Clip
Chrysler 1971-On

UNIT PACKAGE: 25



13847

(6003858)
Nylon

Deck Lid
Moulding Clip
Chrysler Vans 1984-On

UNIT PACKAGE: 25

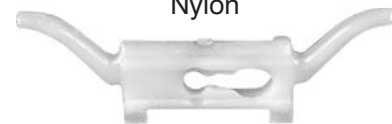

11936

(6003632)
Nylon

Wheel Opening
Moulding Clip
Chrysler 1978-On

UNIT PACKAGE: 50



11354

(6003147)
Nylon

Moulding Clip
Chrysler 1976-On

UNIT PACKAGE: 25



17064

(6004162)
Nylon

Woodgrain Side Moulding Clip
Dodge Caravan & Plymouth Voyager
Mini-Vans 1990-On

UNIT PACKAGE: 25



17151

(6004036)
Nylon

Window Reveal
Moulding Clip
Chrysler LeBaron &
Maserati 1987-On

UNIT PACKAGE: 15



21791
 (Chrysler: 68213168AA)
 Black Nylon

Grille Moulding Clip
 Flange Diameter: 20mm
 Stem Diameter: 13mm
 Stem Length: 12mm
 Overall Length: 31mm
 Dodge Ram 1500 2013 - On

UNIT PACKAGE: 15



20828
 (55157070-AC)
 Black Nylon

Rocker Moulding Clip
 Head Diameter: 25mm
 Overall Length: 31mm
 Fits into 8mm Hole
 Jeep Liberty 2002 - On

UNIT PACKAGE: 10



21835
 (Chrysler: 68225214AA)
 White Nylon

Moulding Clip
 Head Size: 11.5mm x 21mm
 Stem Length: 11mm
 Overall Height: 17mm
 Jeep Cherokee 2014 - On

UNIT PACKAGE: 50



20763
 (1BA41AX1-AA)
 Black Nylon

Rocker Panel
 Moulding Clip
 Head Size: 12mm x 20mm
 Stem Length: 13mm
 Chrysler 300 & Dodge Magnum 2005 - On

UNIT PACKAGE: 15



19894
 (5FR56DX9)
 Black Nylon

Rocker Panel Clip
 Head Size: 7/16" x 25/32"
 Stem Length: 5/8"
 Jeep Grand Cherokee 1999 - On

UNIT PACKAGE: 25



21175
 (1BA41XWG-AA)
 Cream Color Nylon

Rocker Panel Moulding Clip
 Head Size: 12mm x 20mm
 Stem Length: 13mm
 Fits into 9mm Hole
 Chrysler 300 2006 - On

UNIT PACKAGE: 15



20523
 (55156429-AA)
 Black Nylon

Rocker Panel & Bumper Fascia Clip
 Top Head Size: 1/2" x 1-3/16"
 Stem Length: 27/32"
 Jeep Liberty 2002 - On

UNIT PACKAGE: 10



21670
 (4389940-AB)
 Black Nylon

Rocker Panel Moulding Clip
 Head Size: 10mm x 20mm
 Stem Length: 14mm
 Chrysler Sebring &
 Dodge Avenger 2007 - On

UNIT PACKAGE: 10



21154
 (5189180-AA)
 Black Nylon

Front Fender Flare
 Moulding Clip
 Top Head Size: 13mm x 31mm
 Bottom Head Size: 14mm x 22mm
 Stem Length: 22mm
 Jeep Commander 2006 - On

UNIT PACKAGE: 15



22129
 (Not Available from O.E.M.)
 White Nylon

Body Side Moulding Clip
 Top Head Size: 4mm x 10.5mm
 Bottom Head Diameter: 11mm
 Stem Length: 10mm
 Fits into 7mm Hole
 Dodge Dart 2014 - On

UNIT PACKAGE: 25



20870

68092697AA
White Nylon

Rocker Panel Moulding Clip
Top Head Size: 9/16" x 13/16"
Bottom Head Size: 9/16" x 23/32"
Stem Length: 5/8"
Dodge Dakota & Durango
and Jeep Liberty 2000 - On

UNIT PACKAGE: 15



20982

(Not Available from O.E.M.)
White Nylon

Fender & Wheel Flare Moulding Clip
Top Head Size: 14mm x 18mm
Bottom Head Size: 17mm x 21mm
Stem Length: 13mm
Fits into 9mm Hole
Jeep Commander 2006 - On

UNIT PACKAGE: 25



21223

(6509288AA)
Black Nylon

Rocker Moulding Clip with Sealer
Top Head Size: 21mm x 22mm
Bottom Head Size: 22mm x 22mm
Stem Length: 9mm
Chrysler Grand Caravan
and Town & Country 2008 - On

UNIT PACKAGE: 10



21099

(Not Available from O.E.M.)
White Nylon

Lift Gate Moulding Clip with Sealer
Top Head Size: 12mm x 21mm
Bottom Head Size: 16mm x 18mm
Stem Length: 11mm
Magnum 2006 - On

UNIT PACKAGE: 10



21374

(GM: 11571175;
Chrysler: 68172491AA)
Gray Nylon

Rocker Moulding Clip with Sealer
Top Head Size: 12mm x 20mm
Bottom Head Size: 12mm x 20mm
Stem Length: 11mm
Fits into 9mm Hole
Chevrolet Traverse 2010 - On
Chrysler 200 2015 - On
Jeep Grand Cherokee 2015 - 2012

UNIT PACKAGE: 15



21666

(Not Available from O.E.M.)
White Nylon

Liftgate Spoiler
Moulding Clip with Sealer
Top Head Size: 12mm x 23mm
Bottom Head Diameter: 18mm
Stem Length: 11mm
Chrysler and Dodge Mini-Van 2008 - On

UNIT PACKAGE: 15

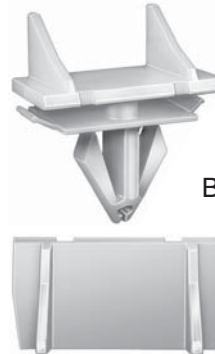

20827

(55157069-AB)
White Nylon

Rocker Moulding Clip
Top Head Size: 14mm x 27mm
Bottom Head Size: 13mm x 26mm
Stem Length: 15mm
Fits into 9mm Hole
Jeep Liberty 2002 - On

UNIT PACKAGE: 25



21153

(6508947-AA)
Black Nylon

Front Bumper Moulding Clip
Top Head Size: 11mm x 32mm
Bottom Head Size: 15mm x 20mm
Stem Length: 20mm
Fits into 15mm Hole
Jeep Patriot 2007 - On

UNIT PACKAGE: 10



20700

(55156447-AB)
Black Nylon

Ground Effects Moulding Clip
Head Width: 1/2"
Head Length: 1-1/2"
Stem Length: 1/2"
Jeep Liberty 2004 - On

UNIT PACKAGE: 25



21528

(68039280-AA)
Black Nylon

Fender Flare &
Rocker Moulding Clip
Top Head Size: 14mm x 38mm
Bottom Head Size: 16mm x 38mm
Stem Length: 14mm
Fits into 10mm Hole
Jeep Wrangler JK & Wrangler Unlimited JK 2007 - On

UNIT PACKAGE: 25



20887

(55157055-AA, 55157065-AA)
Gray Nylon

Fender Flare
Moulding Clip with Sealer
Top Head Size: 14mm x 38mm
Bottom Head Size: 16mm x 38mm
Stem Length: 15mm
Fits into 9mm Hole
Jeep Liberty 2005 - On

UNIT PACKAGE: 15



21738

(Chrysler: 55156655-AA)
Black Nylon

Inner Fender
Moulding Clip with Sealer
Head Size: 12mm x 38mm
Stem Length: 12mm
Fits into 8mm Hole
Chrysler Sebring, Dodge Avenger & Durango and
Jeep Grand Cherokee & Liberty 2007 - 02

UNIT PACKAGE: 25



21155

(5189181-AA)
Black Nylon

Front Fender Flare (Rear)
Moulding Clip with Sealer
Top Head Size: 14mm x 40mm
Bottom Head Size: 14mm x 18mm
Stem Length: 15mm
Jeep Commander 2006 - On

UNIT PACKAGE: 10



20771

(4857699-AA)
Black Nylon

Front Bumper Fascia
to Grille Retainer
Head Size: 10mm x 42mm
Stem Length: 14mm
Fits into 7.5mm Hole
Chrysler Pacifica 2004 - On

UNIT PACKAGE: 25



18029

(4630253)
Black Nylon

Rear Fascia
Push-Type Retainer
Head Size: 7/8" x 1-25/32"
Stem Length: 1-1/16"
Fits into 1/2" Hole
Chrysler Concorde & LHS
Dodge Intrepid & Eagle
Vision 1993-On

UNIT PACKAGE: 15



19131

(Not Available from O.E.M.)
Black Nylon

Cowl Screen Retainer
Chrysler New Yorker, Intrepid,
LHS, Concorde &
Eagle Vision 1993-On

UNIT PACKAGE: 15



18032

(6502573)
Black Nylon

Cowl Screen Attachment
Push-Type Retainer
Head Size: 15/32"
Stem Length: 9/16"
Fits into 1/4" Square Hole
Chrysler Concorde & LHS,
Dodge Intrepid & Eagle Vision 1993-On

UNIT PACKAGE: 15



17214

(GM:10089262, 21042098;
Chry: 55075139)
Black Nylon

Push-Type Retainer
Head Diameter: 11mm (7/16")
Stem Length: 18mm (11/16")
Fits into 6mm (15/64") Hole
GM Saturn 4 Door &
Station Wagon 1991 - On

UNIT PACKAGE: 25

14987

Same as 17214 except for unit package quantity

UNIT PACKAGE: 50



14995

(GM: 10195515;
Ford: N805026S;
Chry: 4696488, 6503163)
Black Nylon

Push-Type Retainer
Head Diameter: 1/2"
Stem Length: 1-13/64"
Fits into 9/32" Hole
Ford, GM & Chrysler 1987 - On

UNIT PACKAGE: 25



14992

(Ford: N803946S; Chry: 6502871)
Black Nylon

Push-Type Retainer
Head Diameter: 19/32"
Stem Length: 29/32"
Fits into 1/4" Hole
Ford & Chrysler 1987 - On

UNIT PACKAGE: 50



15672

(8880417)
Black Nylon

Push-Type Retainer
Head Diameter: 17mm
Stem Length: 14mm
Fits into 8mm (5/16") Hole
Chrysler 1987-On

UNIT PACKAGE: 25



14753

(Chry: 4638136; GM: 20664092;
Ford: N804570S)
Black Nylon

Radiator Shroud & Trim Retainer
Push-Type Retainer
Head Diameter: 11/16"
Stem Length: 7/8"
Fits into 1/4" Hole
Chrysler 1998 - On
GM 1982 - On
Ford 1986 - On

UNIT PACKAGE: 25



21680

(Chrysler: 6509960AA)
Black Nylon

Bumper Push-Type Retainer
Head Diameter: 18mm
Stem Length: 10mm
Fits into 8mm Hole
Chrysler 300 2011 - On

UNIT PACKAGE: 25



21098

(Chrysler: 6508197-AA;
Ford: W706092-S300)
Black Nylon

Front Air Shield, Splash Guard &
Heat Shield Push-Type Retainer
Head Diameter: 18mm
Stem Length: 18mm
Fits into 6.4mm Hole
Dodge Ram 2006 - On
Ford Taurus 2008 - On

UNIT PACKAGE: 25



19140

(Acura: 90505-SL0-003;
GM: 94852368;
Mitsubishi: MB888869;
Toyota: 90467-08155)
Black Nylon

Push-Type Retainer
Head Diameter: 20mm
Stem Length: 21mm
Fits into 8mm Hole

Acura, Dodge Avenger, Eagle Talon, Geo Prizm,
Mitsubishi Eclipse & Galant and Toyota 1993-On

UNIT PACKAGE: 5



16835

(GM: 10140480; Chry: 6502625)
Black Nylon

Push-Type Retainer
Head Diameter: 21mm (27/32")
Shoulder Length: 3mm (1/8")
Stem Length: 25mm (1")
Fits into 12mm (1/2") Hole

UNIT PACKAGE: 25



17104

(6501630, 6501772, 6501878)
Black Nylon

Headlight & Tail Light
Panel Attachment
Push-Type Retainer
Head Size: 15mm x 31mm
Stem Length: 17mm
Fits into 5mm x 6.5mm Hole
Dodge Daytona 1987-On

UNIT PACKAGE: 10



11704

(6031383)
Black Nylon

Grille Retainer
Head Diameter: 11/16"
Stem Length: 7/16"
Fits into 9/32" Hole
Chrysler 1978-On

UNIT PACKAGE: 25



11699

(GM: 472434; Chry: 6031390)
Black Nylon

Cowl Ledge Weatherstrip &
Fender Liner Push-Type Retainer
Head Diameter: 11/16"
Stem Length: 5/8"
Fits into 1/4" Hole
GM 1970-On
Chrysler 1968-On

UNIT PACKAGE: 50



20273

(Ford: N808791;
Chry: 5GC71RC3AA, 5GF92RC3AA)
Gray Nylon

Interior Trim, Dash & Console
Push-Type Retainer
Head Diameter: 19mm
Shoulder Diameter: 10mm
Shoulder Length: 7mm
Stem Length: 22mm
Fits into 9mm Hole
Dodge Durango &
Ford Pick-Ups 1997 - On

UNIT PACKAGE: 25



20739

(WX68DX9-AA)
Black Nylon

Door Trim Panel Push-Type Retainer
Head Diameter: 22mm
Stem Length: 10mm
Fits into 9mm Hole
Chrysler 300 & Dodge Magnum 2005 - On

UNIT PACKAGE: 25



21021

(0WX68BD5-AA)
Dark Gray Nylon

Door Trim Panel Push-Type Retainer
Head Diameter: 22mm
Stem Length: 10mm
Fits into 9mm Hole
Charger, Magnum & 300M 2005 - On

UNIT PACKAGE: 25



21427

(0WX68XDB-AA)
Light Gray Nylon

Door Trim Panel Push-Type Retainer
Head Diameter: 22mm
Stem Length: 10mm
Fits into 9mm Hole
Chrysler 300M, Charger & Magnum 2005 - On

UNIT PACKAGE: 25



20948

(0WX68BD1-AA)
Tan Nylon

Door Trim Panel Push-Type Retainer
Head Diameter: 22mm
Stem Length: 10mm
Fits into 9mm Hole
Chrysler 300M and Dodge
Charger & Magnum 2005 - On

UNIT PACKAGE: 25



17080

(OH452KD5)
Nylon, Quartz
Matte Finish

Headliner Retainer
Head Diameter: 1-1/4"
Stem Length: 7/16"
Fits into 1/4" Hole
Dodge Caravan & Plymouth Voyager 1984-On

UNIT PACKAGE: 15



12567

(GM: 14019205, 14019206, 16514113;
Chry: 34201621, 6504090)
Black Nylon

Front Fender Mud Skirt
& Fender Liner Push-Type Retainer
Head Diameter: 11/16"
Stem Length: 9/16"
Fits into 1/4" Hole
GM 1981 - On
Chrysler

UNIT PACKAGE: 25

14007

Same as 12567 except for unit package quantity

UNIT PACKAGE: 50



18327

(6503454)
Black Nylon

Front Bumper Fascia Push-Type Retainer
Head Diameter: 11/16"
Stem Length: 5/8"
Fits into 1/4" Hole
Jeep Grand Cherokee 1994 - On

UNIT PACKAGE: 25



14010

(GM: 14045480; Chry: 6508746-AA)
Black Nylon

Fascia Retainer
Head Diameter: 1"
Stem Length: 23/32"
Fits into 3/8" Hole
GM 1982 - On
Chrysler 2009 - On

UNIT PACKAGE: 25



14016

(GM: 16500308; Chry: 6500787)
Black Nylon

Tail Light Retainer
Top Head Diameter: 3/8"
Stem Length: 7/16"
Fits into 3/16" Hole
GM & Chrysler

UNIT PACKAGE: 25



20580

(MR478262)
Black Nylon

Bumper Cover & Garnish Moulding
Push-Type Retainer
Top Head Diameter: 15mm
Bottom Head Diameter: 14mm
Stem Length: 12mm
Fits into 7mm Hole
Use with Auveco 20581
Sebring & Stratus and
Mitsubishi Eclipse 2000 - On

UNIT PACKAGE: 15



13993

(GM: 20510029;
Ford: N803362-S;
Chry: 34202672)
Black Nylon

Body Retainer
Head Diameter: 11/16"
Stem Length: 7/8"
Fits into 1/4" Hole
GM 1984-On
Ford 1984 - On
Chrysler 1984 - On

UNIT PACKAGE: 25



19801

(GM: 21077123; Chry: 6509103AA
Ford: W705436-S300)
Black Nylon

Wheel Opening Moulding
Push-Type Retainer
Head Diameter: 19/32" (15mm)
Stem Length: 3/4" (19mm)
Fits into 1/4" (6mm) Hole
Saturn 1991 - On
Ford 2002 - On
Chrysler 2010 - On

UNIT PACKAGE: 25



20988

(GM: 11589289;
Chrysler: 6508863-AA)
Black Nylon

Air Distributor & Windshield Defroster
Push-Type Retainer
Head Diameter: 18mm
Stem Length: 17.5mm
Panel Range: 2.0mm - 4.5mm
Fits into 6.5mm Hole
GM 2002 - On
Chrysler

UNIT PACKAGE: 25



19639

(GM: 15149708; Chry: 6506008AA)
Black Nylon

Radiator, Wheelhouse,
Fender & Front Bumper Cover
Push-Type Retainer
Head Diameter: 17mm
Stem Length: 16mm
Fits into 6mm Hole
GM C & K Trucks 1999 - On
Jeep Liberty 2002 - On

UNIT PACKAGE: 25



22354

(Chrysler: 6510139-AA)
Black Nylon

Exterior Trim, Floor, Pillar &
Quarter Panel Push-Type Retainer
Head Diameter: 18mm
Stem Length: 18mm
Fits into 7mm Hole
Dodge Challenger &
Charger 2011 - On

UNIT PACKAGE: 25



18030

(Chry: 6501925; GM: 10134407)
Black Nylon

Push-Type Retainer
Head Size: 11/16"
Stem Length: 13/16"
Fits into 1/4" Hole
Chrysler Concorde & LHS
Dodge Intrepid & Eagle Vision 1993-On
Coolant Recovery Reservoir
GM 1992-On

UNIT PACKAGE: 25



20966

(5160260-AA)
Black Nylon

Rear Bumper, Tail Light
and Fender Push-Type Retainer
Bottom Head Diameter: 18mm
Stem Length: 20mm
Fits into 8mm Hole
Dodge Caliber and
Jeep Compass & Patriot 2007 - On

UNIT PACKAGE: 15



20888

(GM: 11589290;
Chry: 6509049AA)
Black Nylon

Fender, Wheel & Bumper
Push-Type Retainer
Head Diameter: 18mm
Stem Length: 20mm
Panel Range: 3.0mm - 5.8mm
Fits into 9.5mm Hole
GM 2004 - On
Jeep Wrangler 2000 - On
Chrysler Charger & 300 2011 - On

UNIT PACKAGE: 25



19422

(6504521)
Black Nylon

Fascia Push-Type Retainer
Large Head Diameter: 23/32"
Stem Length: 29/32"
Fits into 5/16" Hole
LHS, Concorde, Intrepid &
Eagle Vision 1998-On

UNIT PACKAGE: 25



20768

(4806240AA)
Black Nylon

Rear Bumper
Push-Type Retainer
Large Head Diameter: 18.5mm
Stem Length: 21mm
Fits into 8mm Hole
Chrysler 300 &
Dodge Magnum 2005 - On

UNIT PACKAGE: 10



20990

(GM: 15296830;
Chrysler: 5116530-AA)
Black Nylon

Fascia & General Purpose
Push-Type Retainer
Head Diameter: 19mm
Stem Length: 16mm
Panel Range: 5.0mm - 7.0mm
Fits into 8mm Hole
GM 2007 - On
Chrysler

UNIT PACKAGE: 25



19245

(5BB14LX9)
Black Nylon

Fascia to Front Bumper
Push-Type Retainer
Top Head Diameter: 3/4"
Stem Length: 1-1/8"
Fits into 1/4" Hole
Dodge Dakota 1994-On

UNIT PACKAGE: 25



21086

(Mercedes-Benz: 230-990-01-92;
Chry: 6104900-A)
Black Nylon

Hood Insulation & Cowl Grille
Push-Type Retainer
Head Diameter: 20mm
Stem Length: 10mm
Fits into 8mm Hole
Mercedes GL, M, R, SL & SLK 2005 - On
Chrysler 2010 - On

UNIT PACKAGE: 15



20766

(6507669-AA)
Black Nylon

Radiator Grille
Push-Type Retainer
Head Diameter: 20mm
Stem Length: 16mm
Fits into 10mm Hole
Dodge Durango 2004 - On

UNIT PACKAGE: 25



20458

(6506132-AA)
Black Nylon

Side Radiator Shield
Push-Type Retainer
Head Diameter: 20mm
Stem Length: 17mm
Fits into 7mm Hole
Sebring & Stratus 2001 - On

UNIT PACKAGE: 25



17216

(GM: 21030249; Ford: N807389S;
Chry: 6503598)
Black Nylon

Air Baffle to Under Carriage
Push-Type Retainer
Head Diameter: 20mm
Stem Length: 20mm
Fits into 8mm Hole

UNIT PACKAGE: 25



20457

(4857345-AA)
Black Nylon

Tail Light Housing
Push-Type Retainer
Large Head
Diameter: 21mm
Stem Length: 23mm
Fits into 9.5mm Hole
Caravan Town & Country and
Voyager Mini Vans 2002 - On

UNIT PACKAGE: 25



18269

(6503106)
Black Nylon

Lower Sill Moulding
Push-Type Retainer
Large Head Diameter: 7/8"
Stem Length: 1"
Fits into 1/4" Hole
Jeep Grand Cherokee Laredo 1994-On

UNIT PACKAGE: 15



20967

(Not Available from O.E.M.)
Black Nylon

Rear Bumper Mounting Bracket
Push-Type Retainer
Head Diameter: 22mm
Stem Length: 16mm
Fits into 10mm Hole
Jeep Commander 2006 - On

UNIT PACKAGE: 15



20767

(4806110-AA)
Black & White Nylon

Front Bumper Push-Type Retainer
Head Diameter: 24mm
Shoulder Length: 3mm
Stem Length: 20mm
Fits into 11mm Hole
Chrysler 300 &
Dodge Magnum 2005 - On

UNIT PACKAGE: 15



22177

(Chrysler: 6510766-AA)
Yellow & White Nylon

Door Panel Push-Type
Retainer with Sealer
Top Head Diameter: 16mm
Middle Head Diameter: 18mm
Bottom Head Diameter: 22mm
Stem Length: 13mm
Fits into 9mm Hole
Chrysler 300, Dodge Charger &
Jeep Cherokee 2014 - On

UNIT PACKAGE: 15



21376

(4389947-AA)
Black & White Nylon

Bumper Cover
Push-Type Retainer with Sealer
Head Diameter: 24mm
Shoulder Length: 3mm
Stem Length: 20mm
Fits into 11mm Hole
Avenger, Journey & Sebring 2008 - On

UNIT PACKAGE: 10



21601

(06509673AA)
White & Black Nylon

Push-Type Retainer with Sealer
Top Head Diameter: 16mm
Middle Head Diameter: 18mm
Bottom Head Diameter: 22mm
Stem Length: 16mm
Fits into 9mm Hole
Chrysler 300 & Magnum and Jeep Grand
Cherokee & Wrangler 2011 - On

UNIT PACKAGE: 15



14019

(Ford: N803421-S; Chry: 6501590)
Black Nylon

Push-Type Retainer
Head Diameter 1"
Shoulder Length: 1/8"
Stem Length: 7/8"
Fits into 5/16" Hole

UNIT PACKAGE: 25



18394

(6503453)
Black Nylon

Fascia to Bumper
Push-Type Retainer
Large Head Diameter: 1"
Stem Length: 1-1/8"
Fits into 1/4" Hole
Jeep Grand Cherokee 1994 - On

UNIT PACKAGE: 25



21348
(6508643-AA)
Black Nylon

Tail Light
Push-Type Retainer
Top Head Diameter: 31.5mm
Small Head Diameter: 20mm
Stem Length: 23mm
Fits into 10mm Hole
Dodge Nitro and
Jeep 2008 - On

UNIT PACKAGE: 15



19417
(Chry: 6503819, 6503401;
GM: 25631448)
Black Nylon

M7.5 x 35mm
Square Drive Truss Head
Head Diameter: 22mm
Shoulder Diameter: 9mm
Foam to Bumper Fascia
Chrysler 1993 - On
GM 1997 - On

UNIT PACKAGE: 15



20963
(4806334-AA)
Black & White Nylon

Rear Bumper Push-Type
Retainer with Sealer
Head Diameter: 34mm
Shoulder Length: 3.5mm
Stem Length: 17mm
Fits into 8.5mm Hole
Dodge Caliber and
Jeep Compass &
Patriot 2007 - On

UNIT PACKAGE: 10



20970
(Not Available from O.E.M.)
Black Nylon

M14 x 34mm
Bumper and Door
Insulator Nylon Screw
Head Diameter: 22mm
No. 3 Square Drive
Fits into 12mm Hole
GM, Ford & Chrysler 2005 - On

UNIT PACKAGE: 25



19638
(Chry: 4805405AA;
Ford: 1L5Z-17K826AA)
Black & White
Nylon

Front Bumper Fascia
Push-Type Retainer
Head Diameter: 34mm
Stem Length: 20mm
Fits into 8mm Hole
Concorde, Intrepid, Eagle
Pacifica & PT Cruiser 1998-On
Ford Trucks 2005-On

UNIT PACKAGE: 15



18237
(6502545)
Nylon

Headlight Side
Shield Retainer
Dodge Daytona 1992-On

UNIT PACKAGE: 25



21442
(68033794-AA; 68034329AA)
Black Nylon

Bumper Retainer
Head Diameter: 35mm
Stem Length: 14mm
Overall Height: 28mm
Jeep Grand Cherokee 2008 - On

UNIT PACKAGE: 15



20890
(55157112-AA, -AB)
Black & Natural
Nylon

Bumper Cover
Push-Type Retainer
Head Size: 25mm x 45mm
Shoulder Length: 3mm
Stem Length: 20mm
Fits into 9.5mm Hole
Jeep Liberty 2005 - On

UNIT PACKAGE: 15



14985
(2664040)
White Nylon

Door Weatherstrip to
Inside Panel Clip
Chrysler Corp. 1966-On

UNIT PACKAGE: 100

21310

(Not Available from O.E.M.)
Black Nylon



Photo not actual size
Cable Strap

Overall Length: 174mm (6-15/16")
Maximum Bundle Diameter: 40mm (1-9/16")
Strap Width: 5mm (3/16")
Chrysler 2007 - On

UNIT PACKAGE: 25

18249

(6503339)
Black Nylon



Cowl Top Stud Retainer Cover
Head Diameter: 13/16"
Dodge Ram 1994-On

UNIT PACKAGE: 25

20623

(Chrysler: 6506306-AA)
Black Nylon



Cowl Screen Retainer
Head Diameter: 25mm
T-30 Torx® Drive
Stem Length: 14mm
Fits on to 1/4" - 20 Bolt
Dodge Dakota 1997 - On

UNIT PACKAGE: 15

14858

(3799089)



Windshield Wiper Linkage Bushing
Replaces worn wiper linkage bushing
thus eliminating wiper lag
Chrysler 1974-On

UNIT PACKAGE: 25

15673

(3454220, 4658676)
Red Nylon



Door Lock Rod Clip
Used on Right-Hand Side
Rod Size: 5/32"
Chrysler 1972 - On

UNIT PACKAGE: 50

15674

(3454221, 4658677)
Green Nylon



Door Lock Rod Clip
Used on Left-Hand Side
Rod Size: 5/32"
Chrysler 1972 - On

UNIT PACKAGE: 50

10262

Nylon



Left-Hand Side

Door Lock Rod & Hood
Latch Locking Push Rod Clip
Rod Size: 5/32"
Fits into 1/4" Hole
Chrysler, Ford, GM & AMC



Right-Hand Side

UNIT PACKAGE: 20 Pieces
10 Rights - 10 Lefts

20675

(AMC: 4003672R;
Chry: 2945108R, 4658676;
GM: 16627328, Ford: N805350S)
White Nylon

Clip for Right-Hand Side Only

UNIT PACKAGE: 25

14967

(AMC: 4003673L;
Chry: 2945109L, 4658677;
GM: 9815325, 16607593;
Ford: D2VZ-6521952A, N804344S)
Black Nylon

Clip for Left-Hand Side Only

UNIT PACKAGE: 50

20308

(Not Supplied by O.E.M.)
Nylon



Sliding Door Lock Rod Clip
Used on Right-Hand Side
Rod Size: 5mm
Fits into 7mm Hole
Full-Size Vans 1997 - On

UNIT PACKAGE: 10



19191

(4658444)

Lavender Nylon

Door Lock Rod Clip
Right-Hand Side
Rod Size: 1/8"

Chrysler Neon, Cirrus, Stratus &
Jeep Cherokee 1995-On

UNIT PACKAGE: 25



10080

(6027924)

Radiator Grille Panel Upper
Support Baffle Retainer
Chrysler

UNIT PACKAGE: 100



19152

(6031875)

Grille Bar Clip
Chrysler 1981-On

UNIT PACKAGE: 50



22289

(GM: 11570654; Chrysler: 6509432AA
Ford: W716529-S900)
Magni-565 Blue Finish

Radiator Grille Nut
Screw Size: M4.2-1.41 (#8)
Head Size: 6mm x 16mm
Overall Height: 7mm

Buick Allure, Enclave, Encore, LaCrosse,
Lesabre, Lucerne, Rainer, Regal & Verano and
Cadillac ATS, CTS, Deville, DTS, ELR,
Escalade, SRX & STS 2000 - On
Chrysler 200, 300, PT Cruiser, Sebring, Town &
Country and Dodge Avenger, Caliber, Charger, Dart,
Grand Caravan, Ram 2500 & Ram 3500 2015 - 2006
Ford 250, 350, 450 & 550 Super Duty Trucks
2015 - 2013

UNIT PACKAGE: 25



19310

(6034336, 6034812, 6035807)
Phosphate

Door Panel Nut
Screw Size: #6
Cirrus, Concorde, Intrepid, LHS,
Stratus & Eagle Vision 1993-On

UNIT PACKAGE: 25



21745

(GM: 11609651)

Zinc

Windshield Garnish and Interior
Trim Moulding Fastener

Screw Size: M4.2 (#8)

Stem Width: 13mm

Head Size: 13.5mm x 20.5mm

Overall Length: 22mm

Buick Enclave & Encore; Cadillac CTS, Escalade,
STS & XTS; Chevrolet Avalanche, Camaro, Cobalt,
Corvette, HHR, Impala, Malibu, Monte Carlo,
Silverado, Suburban, Tahoe & Traverse; Dodge Truck;
Ford Flex & Taurus; GMC Sierra & Yukon;
Kia Sorento & Soul; Pontiac G6 & G8;
Saturn Outlook and Suzuki Grand Vitara 2004 - On

UNIT PACKAGE: 15



19519

(GM: 16662182; Chry: 6502988)

Zinc Organic

Front Bumper, Grille Mounting
& Headlight Cover Fastener

Width: 1/2"

Height: 9/16"

Chrysler Sebring 1996 - On

GM 1993 - On

UNIT PACKAGE: 15



19339

(4676356)

Phosphate

Grille to Fascia Fastener

Width: 1/2"

Height: 23/32"

Town & Country,

Caravan and Voyager 1997-On

UNIT PACKAGE: 15



20526

(4805570-AA)

Black

Radiator Grille
Cover Fastener

Width: 26mm

Length: 26mm

Caravan, Town & Country
and Voyager Mini-Vans 1996 - On

UNIT PACKAGE: 10



18102

(Ford: N806624-S191;

Chry: 6502776)

Rear Light Assembly Retainer

UNIT PACKAGE: 25



19779

(6503812, 6504601)
Tin & Zinc

Wheel Opening Moulding Nutsert
Thread: M5 - .8
Head Diameter: 10mm
Overall Length: 12mm
Can be set with Auveco tool 11805
Jeep 1999 - On
UNIT PACKAGE: 15



20173

(6506104AA)
Zinc & Yellow

Roof Rack Nutsert
with Sealer Under Head
Thread: M6-1.0
Grip: .7mm - 3.2mm
Head Diameter: 17mm
Hex : 9.5mm (3/8")
Can be set with Auveco tool 11805
Jeep 1999 - On
UNIT PACKAGE: 10



21019

(6509106-AA)
Zinc

M6-1.0 Thread Specialty
Insert with Sealer
Grip Range: .70mm - 3.17mm
Head Diameter: 17mm
Hex Size: 9.5mm
Luggage Rack & Bumper Fascia
Can only be set with Pneumatic Tool
Chrysler Jeep & Van
UNIT PACKAGE: 15



17167

(4336115)

Door Hinge Bushing
Front & Rear Doors
Outer Diameter: 3/8"
Inner Diameter: 1/4"
Length: 13/32"
Flange Outer Diameter: 1/2"
Aries, Caravelle, LeBaron, Reliant,
Town & Country and 600 1989-85
UNIT PACKAGE: 25



17434

(2486468)

Door Hinge Bushing
Outer Diameter: 27/64"
Inner Diameter: 11/32"
Length: 7/16"
Flange Outer Diameter: 19/32"
Chrysler Vans 1982-78
UNIT PACKAGE: 25



14552

(4033711)

Door Hinge Bushing
Outer Diameter: 5/16"
Inner Diameter: 17/64"
Length: 23/64"
Flange Outer Diameter: 33/64"
Cargo doors, lift gates, rear doors and
fold-up rear seat floor hinges
Dodge & Plymouth vans,
Ramcharger and Trailduster 1970-On
UNIT PACKAGE: 25

Dodge Truck Door Hinge Pin & Bushing Repair Kits

For 2003 - 1994 Dodge Ram 1500, 2500 & 3500 Pick-Up Trucks

Why bother with the hassle of cutting and grinding off a worn door hinge and welding on a new one when you can repair the bad hinge in a fraction of the time? With our Door Hinge Bolt & Bushing Repair Kit, fixing sagging doors caused by worn hinges due to pin or bushing failure is quick, easy, and works. And you don't have to paint the welded heat flash area.

Each kit is designed to repair one hinge and contains one zinc and yellow dichromate plated grade 8 bolt, two self-lubricating brass alloy bushings, one zinc plated spin lock nut and one zinc plated internal lock washer.

Here's how easy it is:

1. Remove the door from the truck body.
2. Grind or cut off the end of the pin at the peaned end.
3. Remove the old pin and bushings.
4. Install the bushings into the hinge holes.
5. Place the washer on the bolt and install the bolt into the bushings.
6. Thread the nut onto the bolt and tighten.
7. Reattach the door to the truck body.

Detailed instructions are included with the kit.

20544

Photo not actual size



Door Hinge Bolt & Bushing
Repair Kit

UNIT PACKAGE: 1 Kit

Photos not actual size

21408

Greaseable Stainless Steel



Door Hinge Pin & Nut Repair Kit
Repairs Two Hinges

Jeep Wrangler (YJ) with Half Steel Doors 1995 - 1988
Jeep Wrangler (TJ) 2006 - 1997
Jeep Wrangler Unlimited (TJ) 2006 - 2004

UNIT PACKAGE: 1

21407

Greaseable Stainless Steel



Tailgate Hinge Pin & Nut Repair Kit
Repairs Two Hinges

Jeep Wrangler (YJ) with Half Steel Doors 1995 - 1988
Jeep Wrangler (TJ) 2006 - 1997
Jeep Wrangler Unlimited (TJ) 2006 - 2004

UNIT PACKAGE: 1

22062

(Not Available from O.E.M.)



Greaseable Stainless Steel
Door Hinge Roller Pin & Bushing Repair Kit
Repairs One Hinge
Dodge Ram Full Size Pick-Up 2013 - 2009

UNIT PACKAGE: 1

14561

(6500361)
Zinc



Door Hinge Pin
Length: 2-1/4"
Pin Diameter: 1/4"
Chrysler 1980-On

UNIT PACKAGE: 10



**Auveco releases new items every other week.
Our Hot New Items bulletins can keep you up
to date on all new product.**

**To receive these bulletins please
contact customer service:
mail@auveco.com or 1-800-354-9816**

**We also have all previous and current bulletins
posted on www.auveco.com.**



11470

(AMC: SF 400 6204;
GM: 1606642,
1618890)

1/4"-28 x 1-7/8"
Headlight Adjusting
Screw & Nut
AMC & Cadillac 1975-On

UNIT PACKAGE: 25



Left-Hand Side



Right-Hand Side

10262

Nylon

Door Lock Rod & Hood
Latch Locking Push Rod Clip
Rod Size: 5/32"
Fits into 1/4" Hole
Chrysler, Ford, GM & AMC

UNIT PACKAGE: 20 Pieces
10 Rights - 10 Lefts

20675

(AMC: 4003672R;
Chry: 2945108R, 4658676;
GM: 16627328, Ford: N805350S)
White Nylon

Clip for Right-Hand Side Only

UNIT PACKAGE: 25

14967

(AMC: 4003673L;
Chry: 2945109L, 4658677;
GM: 9815325, 16607593;
Ford: D2VZ-6521952A, N804344S)
Black Nylon

Clip for Left-Hand Side Only

UNIT PACKAGE: 50



11697

(4000141)
Nylon

Screw Size: #6 or #8
AMC

UNIT PACKAGE: 50



2272

(3426388)

Front Fender and Door
Quarter Panel Moulding Fastener
Rambler

UNIT PACKAGE: 100



15813

(4005714)
Nylon

Window Glass Retainer
AMC Eagle 1988-On

UNIT PACKAGE: 25



13472

(Ford: 386285,
AMC: 3230375)
Nylon

Air Cleaner Wing Nut
Self Threading
Size: 1/4" (6mm)
Ford and AMC

UNIT PACKAGE: 10



15666

(AMC: 36000148,
36001966, 56001419;
VW: 176 941 1117A)

1/4"-28 x 2-1/4"
Headlight Adjusting Screw
and Nut Assembly
AMC Encore & Alliance 1983-On
VW

UNIT PACKAGE: 10



14217

(GM: 1257702, 20346654;
Ford: 383207-S;
AMC: 3693099)
Nylon

Routing Clip
GM / Ford / AMC

UNIT PACKAGE: 25

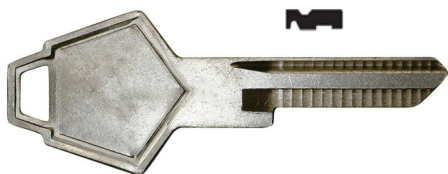

19952

(Strat: 320514)

Groove:61, Y-152
1984-70

UNIT PACKAGE: 25

19947

(Strat: 320433)

Groove: 53, Y-149
1990-70

UNIT PACKAGE: 25

19970

(Strat: 321074)

Groove:
60, RA4
Ram Charger 1990-81

UNIT PACKAGE: 5

20030

(Strat: 594145)

Groove:
73, Y-154
1992-89

UNIT PACKAGE: 10

20110

(Strat: 596504)

Groove:
84, Y-157
Chrysler 1996-94

UNIT PACKAGE: 10

20155

(Chry: 5013809-AA;
Strat: 599013)



Groove: 84

Cut: 10

Chrysler Key Blank
One Key System
Jeep Grand Cherokee 1999 - On

UNIT PACKAGE: 10

20139

(Strat: 597121)



Groove: 84, Y-159
Primary Key Blank
Chrysler Mini-Van 1996-On

UNIT PACKAGE: 10

20090

(Strat: 322235, 322236)



Groove: 85, Code Series L, Y-158
Ignition & Door
Valet Key Blank
Chrysler 1996-94

UNIT PACKAGE: 10

Chrysler Key Blank Chart

Groove	Application
53 & 61	1990-69
60	Ram Charger
73	1992-1989
78 & 78	1993

Larger Quantities Available

FORD KEY BLANKS



19930
(Strat: 32838)

Groove: 40
1964-52

UNIT PACKAGE: 10



20092
(Strat: 596758)

Cut: 10
Groove: H60 & H67
Ignition Key Blank
Ford 1995-93

UNIT PACKAGE: 10

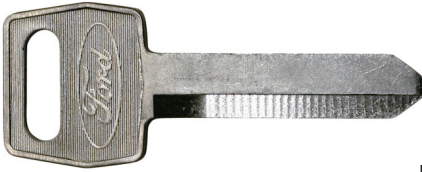

19973
(Strat: 321207)

Groove: 49, H51
1988-65

UNIT PACKAGE: 25

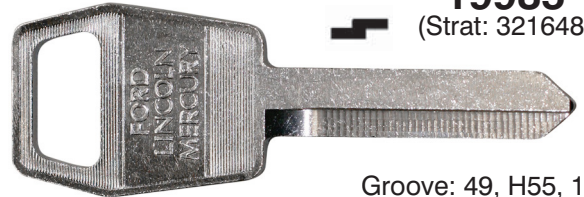

19985
(Strat: 321648)

Groove: 49, H55, 10 Cut
1984-On

UNIT PACKAGE: 15

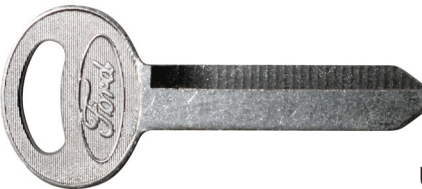

19972
(Strat: 321202)

Groove: 48, H50
1988-65

UNIT PACKAGE: 25

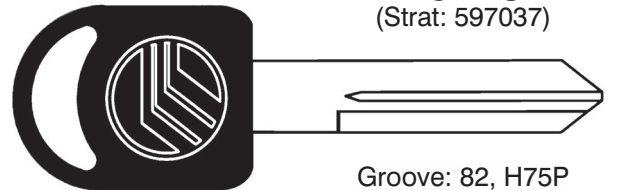

20123
(Strat: 597037)

Groove: 82, H75P
Primary & Secondary Key Blank
Mercury Sable 1996

UNIT PACKAGE: 10

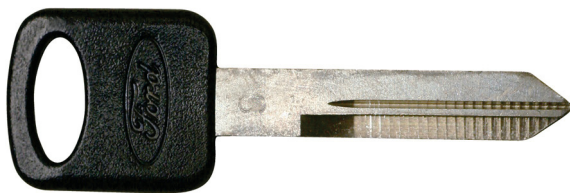

20122
(Strat: 597638)

Groove: 82, H75F
Cut: 8
Primary & Secondary Key Blank
Taurus & Explorer 1996
F-Series, Bronco & Ranger 1997 - On

UNIT PACKAGE: 10

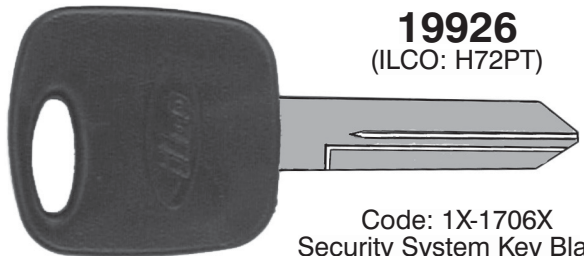

19926
(ILCO: H72PT)

Code: 1X-1706X
Security System Key Blank
Internal Transponder
Ford Crown Victoria,
Excursion, Expedition,
Explorer, F-Series Pick Up,
Mustang, Ranger &
Taurus 2000 - 98

UNIT PACKAGE: 1



19944
(Strat: 320404)
Grove: 56-E,
H98E, B-44

UNIT PACKAGE: 25

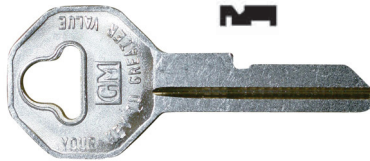

19928
(Strat: 32318)
Grove: 15, B10
1966-36

UNIT PACKAGE: 10



19945
(Strat: 320405)
Grove: 57-H,
H98H, B-45

UNIT PACKAGE: 25

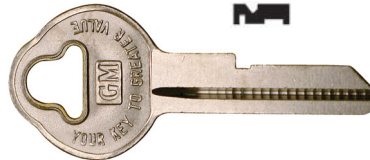

19929
(Strat: 32319)
Grove: 15, B11
1966-36

UNIT PACKAGE: 10

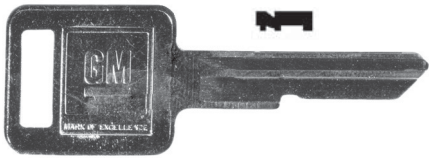

19957
(Strat: 320652)
Grove: 54-C,
H98C, B-50

UNIT PACKAGE: 25

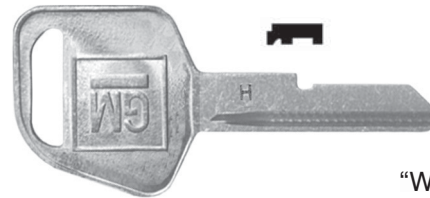

20008
(Strat: 321951)
Grove:
57-H, B-79
"W" Bodies 1991-On

UNIT PACKAGE: 15



19958
(Strat: 320653)
Grove: 55-D,
H98D, B-51

UNIT PACKAGE: 25

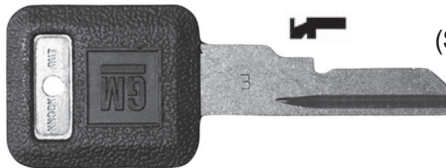

20034
(Strat: 595313)
Groove:
56-E, B-77
Beretta &
Corsica 1991-On

UNIT PACKAGE: 10



19954
(Strat: 320588)
Grove: 50-A,
H98A, B-48

UNIT PACKAGE: 25

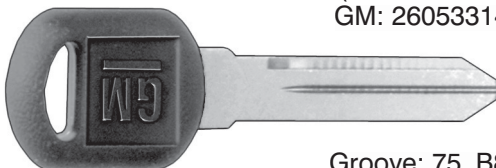

20149
(Strat: 597749;
GM: 26053314)
Groove: 75, B89
Primary Key
GM Achieva, Cavalier, Grand Am,
Skylark & Sunfire 1997-96

UNIT PACKAGE: 10



19955
(Strat: 320589)
Grove: 51-B,
H98B, B-49

UNIT PACKAGE: 25



20089
(Strat: 596222)

Groove: 75, B83
10 Cut
Ignition & Door Key Blank
Blazer, Suburban, Sonoma
S-10 & Vans 1996-95

UNIT PACKAGE: 10



20146
(Strat: 597791; GM: 2852058)

Groove: 75, B91P
One Key System
Chevrolet Malibu 1997

UNIT PACKAGE: 10



20945
(Strat: 692931;
GM: 89024363, 15824471)

Groove: 93
Transponder
For Anti-Theft Security
Chevrolet Impala 2006 - On

UNIT PACKAGE: 1



21168
(Strat: 691222; GM: 89023920)

Groove 93
One Key System
Chevrolet Cobalt 2005-On

UNIT PACKAGE: 5



20147
(Strat: 597796; GM: 2852063)

Groove: 75, B91P
One Key System
Olds Cutlass 1997

UNIT PACKAGE: 10



20324
(ILCO: B96-P)

Code Series: R, T, S.
One Key System
Saturn 2001 - 97

UNIT PACKAGE: 5

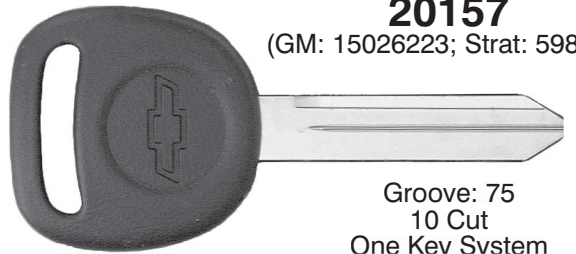

20157
(GM: 15026223; Strat: 598007)

Groove: 75
10 Cut
One Key System
Astro Van, Full Size
Pick-Up, S10 & Blazer 1999-On

UNIT PACKAGE: 10

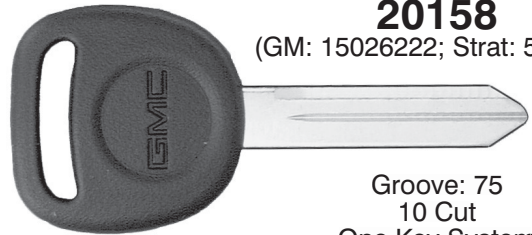

20158
(GM: 15026222; Strat: 598009)

Groove: 75
10 Cut
One Key System
Jimmy, Safari Van, Sonoma P/U,
Vandura Full Size Van 1999-On

UNIT PACKAGE: 10

GM Key Blank Chart

Groove	Application Years
50-A & 50-B	'67, '71, '75, '79, '86-'83
54-C & 55-D	'68, '72, '76, '80, '90-'87
56-E & 57-H	'69, '73, '77, '81, '91-On
58-J & 59-K	'70, '74, '78, '82

HEAVY DUTY TRUCKS



19844
(Strat: 597893;
FrtIn: 22-44567-000)

Groove: 85
Codes: FL001-262
Primary Key Blank
Freightliner Century 1994 - On

UNIT PACKAGE: 10

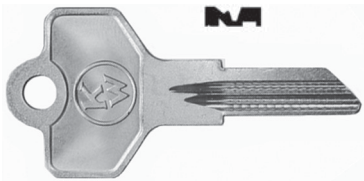

19966
(Strat: 320734)
Kenworth

Groove: 3

UNIT PACKAGE: 10



19976
(Strat: 321490)
Navistar

Groove: 60

UNIT PACKAGE: 10

IMPORTS



20150
(Strat: 597457, Isuzu: 26048001)

Groove: 75
Isuzu Hombre

UNIT PACKAGE: 10



20313
(ILCO: X222 MZ27)

Code Series: 10100-12283
One Key System

Mazda 626, Protege 7 MPV Van 1997- 1993

UNIT PACKAGE: 10

IMPORTS

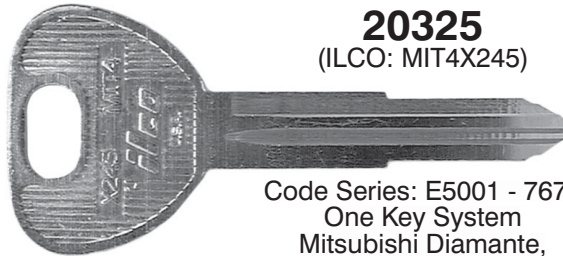

20325
(ILCO: MIT4X245)

Code Series: E5001 - 7679
One Key System
Mitsubishi Diamante,
Galant & Montero 2000 - 97

UNIT PACKAGE: 10



21101
(Strat: 5910834;
Toyota: 89785-08020,
89785-60160, 89785-34020)

Groove: 98
Transponder
For Anti-Theft Security
Toyota Avalon, Camry, Corolla, FJ Cruiser, Highlander,
Land Cruiser, Matrix, RAV4, Scion tC, Sequoia, Sienna,
Solara, Tacoma, Tundra & Yaris 2003 - On

UNIT PACKAGE: 1

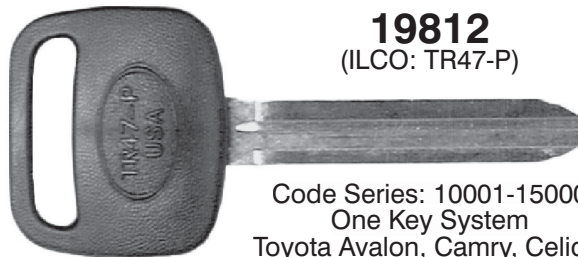

19812
(ILCO: TR47-P)

Code Series: 10001-15000
One Key System
Toyota Avalon, Camry, Celica,
Corolla, RAV4, Sienna, Solara,
Tacoma & Tundra 1992 - On

UNIT PACKAGE: 5



20394
(ILCO: V35-P)

Code Series: AH1-9282
One Key System
VW Cabrio, Corrado, Golf & Jetta 1999 - 88
Passat 1997 - 90
Eurovan 2000 - 99

UNIT PACKAGE: 5

TUMBLERS, SPRINGS & RETAINERS

Photos not actual size

Sec. 21



Type 1



Type 3



Type 5



Type 6



Type 7



Type 8

Auveco Part No.	Strattec No.	Illus. Type	Description	Unit Pkg.
19932	46648	1	GM, Chrysler & AMC Tumbler Spring, 7/16" Long, 5/64" O.D.	100
19933	46890	1	Chrysler Double Bitted Tumbler Spring, 17/64" Long, 1/16" O.D.	100
20115	56028	1	GM Tumbler Spring, 10 Cut, Sidebar Ignition, 5/16" Long, 5/64" O.D.	25
19939	320292	3	GM & Jeep Side Bar Tumbler #2, .025 Depth Charge	50
19941	320294	3	GM & Jeep Side Bar Tumbler #4, .025 Depth Charge	50
20111	322521	5	GM Sidebar Ignition Tumbler, #1 Depth, 10 Cut	25
20112	322522	5	GM Sidebar Ignition Tumbler, #2 Depth, 10 Cut	25
20114	322524	5	GM Sidebar Ignition Tumbler, #4 Depth, 10 Cut	25
20116	322117	6	GM Tumbler Retainer, 10 Cut, Sidebar Ignition	15
20118	322242	7	GM Door & Deck Lock Cylinder Tumbler, #2 Depth, 10 Cut	25
20143	322363	8	Chry./Jeep Wide Body Tumbler, #3 Depth, Double Bitted	25

HARDWARE & ACCESSORIES



19931

(Strat: 46399)

Lock Cylinder Return Spring
Coil Inner Diameter: 5/8"
Coil Outer Diameter: 11/16"
GM

UNIT PACKAGE: 25



19975

(Strat: 321480)

Universal Lock Cylinder
Retainer Clip

UNIT PACKAGE: 10



19977

(Strat: 321963)

Pawl Retainer Clip
GM

UNIT PACKAGE: 10

LOCKS



20038

(Strat: 605533)

Deck & Tailgate Lock
Coded, Chrome Cap
Vertical Clip
GM 1977-On

UNIT PACKAGE: 1

KEY MANUFACTURER NUMBER TO AUECO CROSS REFERENCE

Mfg. Part No.	Auveco Part No.	Page No.	Mfg. Part No.	Auveco Part No.	Page No.
Strattec			Strattec		
32318	19928	637	322522	20112	640
32319	19929	637	322524	20114	640
32838	19930	636	594145	20030	635
46399	19931	640	595313	20034	637
46648	19932	640	596222	20089	639
46890	19933	640	596504	20110	635
56028	20115	640	596758	20092	636
320292	19939	640	597037	20123	636
320294	19941	640	597121	20139	635
320404	19944	637	597457	20150	639
320405	19945	637	597638	20122	636
320433	19947	635	597749	20149	637
320514	19952	635	597791	20146	638
320588	19954	637	597796	20147	638
320589	19955	637	597893	19844	639
320652	19957	637	598007	20157	638
320653	19958	637	598009	20158	638
320734	19966	639	599013	20155	635
321074	19970	635	605533	20038	640
321202	19972	636	691222	21168	638
321207	19973	636	692931	20945	638
321480	19975	640	5910834	21101	639
321490	19976	639			
321648	19985	636			
321951	20008	637			
321963	19977	640			
322117	20116	640			
322235	20090	635			
322236	20090	635			
322242	20118	640			
322363	20143	640			
322521	20111	640			
			ILCO		
			B96P	20324	638
			H72PT	19926	636
			MIT4X245	20325	639
			TR47-P	19812	639
			V35-P	20394	639
			X222 MZ27	20313	639

AN IMPROVED FASTRACK WEB

FasTrack is an easy-to-use, web based system designed to assist body shops and dealerships in recovering the cost of body repair clips and fasteners used in daily collision repairs.

Features:

- **New Look:** User-friendly design and intuitive functions with over 10,000 of our collision repair fasteners
- **Repair Kits:** Simple to build your own kits or choose one of the other preloaded kits
- **Add Part Numbers with Ease:** Add non-auveco items. Add new numbers on the fly during invoicing
- **OEM Numbers:** Available with the latest OEM pricing and ability to use during invoicing
- **Reports:** Page by page user selected printing to gather usage information
- **Inventory Management:** Allows shop and/or the distributor to track inventory
- **Labeling:** End user can print individual bar code labels and lid labels
- **Barcode Scanning:** Done with our app using any smart phone or with our wedge scanner
- **Online Catalog & OEM Crossover**
- **Repair Type:** Requested by many insurance companies you can now add Repair Type during invoice processing (Front Bumper, Front Fender, Door, etc.)
- **CCC® Integration:** Enables users to import FasTrack invoices into CCC's Estimating system
- **Tutorial Videos:** Found in the Help Menu, videos demonstrating all FasTrack features
- **Security:** Site protected by Verisign Internet Security.

Questions or concerns.

Call 1-800-354-9816 or email fastrack.support@auveco.com



17440

(91501-SG0-003)
Nylon

Body Side Moulding Clip Legend
1987-On

UNIT PACKAGE: 15



21557

(75316-S9A-004)
White Nylon

Door Trim Moulding Clip
Head Size: 14mm x 16mm
Stem Length: 12mm
Fits into 10mm Hole
Acura RDX and Honda CR-V 2002 - On

UNIT PACKAGE: 25



21639

(72431-S2X-003)
White Nylon

Moulding Clip
Top Head Size: 8mm x 10.5mm
Bottom Head Size: 11mm x 16mm
Overall Height: 14.6mm
Acura RSX and Honda Civic,
CR-Z & Insight 2006 - 01

UNIT PACKAGE: 25



21559

(91512-SJ6-J01)
Black Nylon

Rocker Panel, Tail Light &
License Plate Housing
Garnish Moulding Clip with Sealer
Top Head Size: 9mm x 12mm
Bottom Head Diameter: 13mm
Stem Diameter: 7.5mm
Stem Length: 9mm
Acura TSX, Honda Civic & CR-V 1997 - On

UNIT PACKAGE: 25



21772

(Honda: 76222-SP1-003)
White Nylon

Body Side, Fender Flare,
Roof Garnish & Side Sill
Moulding Clip with Sealer
Top Head Size: 12.5mm x 14mm
Bottom Head Diameter: 14mm
Stem Diameter: 7mm
Stem Length: 8mm
Acura Legend, MDX, RDX, RL, TL & ZDX 1991 - On
Honda Civic, Element, Odyssey & Pilot 2004 - On

UNIT PACKAGE: 25



21308

(90602-SFA-004)
White Nylon

Cowl & Dash Moulding Clip
Top Head Size: 13mm x 14mm
Bottom Head Diameter: 16mm
Stem Length: 13mm
Acura RL and Honda Civic,
Civic Hybrid & Odyssey 2005 - On

UNIT PACKAGE: 25



19225

(91501-SP1-003)
Nylon

Side Sill Garnish Moulding Clip
Legend Coupe 1991-On

UNIT PACKAGE: 10



21555

(91512-S50-003)
White Nylon

License Plate Garnish &
Trim Moulding Clip with Sealer
Top Head Size: 12mm x 17mm
Bottom Head Size: 16mm x 17mm
Stem Diameter: 13mm
Stem Length: 12mm
Acura TSX & ZDX and Honda Accord, Civic,
Crosstour, Fit, Insight, Odyssey & Pilot 2001 - On

UNIT PACKAGE: 25



21558

(91504-SP1-003)
White Nylon

Rocker Panel & Fender
Moulding Clip with Sealer
Top Head Size: 16mm x 18mm
Bottom Head Size: 18mm x 20mm
Stem Length: 15mm
Fits into 10mm Hole
Acura Legend, MDX, RL & ZDX
and Honda Civic, CR-V & Odyssey 1991 - On

UNIT PACKAGE: 25



21204

(75315-STK-A01)
White Nylon

Front & Rear Door Exterior Trim
Moulding Clip
Top Head Size: 12mm x 15mm
Bottom Head Size: 14mm x 20mm
Stem Length: 9mm
RDX 2009 - 07

UNIT PACKAGE: 15

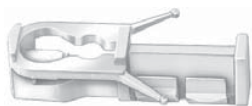

19740
(90666-SSO-003)
White Nylon

Roof Moulding Clip
Acura Integra & Legend
Honda Prelude 1992-On

UNIT PACKAGE: 10



18764
(91514-SP0-003)
Yellow Nylon

Windshield Side
Moulding Clip
Legend 4 Door
1991-On

UNIT PACKAGE: 5



17323
(91513-SP0-003)
Teal Nylon

Windshield Side
Moulding Clip
4 Door Legend 1991-On

UNIT PACKAGE: 10



18754
(91535-SP0-003)
Green Nylon

Windshield Corner
Moulding Clip
Legend 4 Door 1991- On

UNIT PACKAGE: 5



17280
(91505-SG0-003)
Orange Nylon

Windshield Moulding Clip
Honda Prelude and
Acura Legend 1988-On

UNIT PACKAGE: 10



19476
(91577-SV4-003)
Red Nylon

Windshield Left-Hand
Corner Moulding Clip
Acura 2.2CL, 2.3CL & 3.0CL and
Honda Accord & Odyssey 1994 - On

UNIT PACKAGE: 10



18756
(90621-SK7-003)
White Nylon

Windshield Corner
Moulding Clip
Integra 1993-90

UNIT PACKAGE: 5



19477
(91576-SV4-003)
Green Nylon

Windshield Right-Hand
Corner Moulding Clip
Acura 2.2CL, 2.3CL & 3.0CL and
Honda Accord & Odyssey 1994 - On

UNIT PACKAGE: 10



19668
(91533-ST0-003)
Yellow Nylon

Windshield Moulding Clip
Integra 1994-On

UNIT PACKAGE: 10



18760
(91514-SP1-003)
Red Nylon

Windshield Side
Moulding Clip
Legend 2 Door
1991-On

UNIT PACKAGE: 5



18767
(91526-SP1-003)
Blue Nylon

Windshield Side
Moulding Clip
Legend 2 Door
1991-On

UNIT PACKAGE: 5



18456
(90661-ST7-003)
Nylon

Bumper Clip
Integra 1994-On

UNIT PACKAGE: 5



17608
(91568-SL4-003)
Black Nylon

Windshield Side
Moulding Clip
Vigor 1992-On

UNIT PACKAGE: 15



19479
(91561-SW5-003)
White Nylon

Windshield Moulding Clip
TL 2.5 & 3.2 1996 - On

UNIT PACKAGE: 15

21543
(91570-SZA-305)
Blue Nylon



Windshield Moulding Clip
Width: 8mm
Length: 82mm

Acura ZDX and Honda Odyssey & Pilot 2009 - On

UNIT PACKAGE: 5



18236
(91537-SP0-013)
White Nylon

Windshield Clip
Legend
1991-On

UNIT PACKAGE: 10



19734
(90107-SX0-003)
Black Nylon

Bumper Grommet
Screw Size: #10
Head Size: 16mm x 18mm
Stem Length: 6mm
Acura 2.2CL, 2.3CL, 2.5TL, 3.2TL, 3.5RL
Honda Accord & Prelude 1996-On

UNIT PACKAGE: 15



21521
(90107-S0X-A01)
Black Nylon

Screw Grommet
Screw Size: M4.8 (#10)
Head Size: 16mm x 16mm
Stem Length: 7mm
Acura CL, MDX, RL, 3.2 CL & 3.5RI
and Honda Accord,
Pilot, Ridgeline & S2000 1996 - On

UNIT PACKAGE: 25



19465
(91652-SPO-003)
Natural Nylon

Center Pillar Garnish
Screw Grommet
Screw Size: #4
3.5 RL
1996 - On

UNIT PACKAGE: 15



19723
(91503-SK7-013)
Saddle Tan Nylon

Center Pillar Moulding
Screw Grommet
Screw Size: #4
Head Size: 10mm x 14mm
Stem Length: 10mm
Integra 1994 - On

UNIT PACKAGE: 15



20954
(90682-SEA-003)
Black Nylon

Fender Apron Grommet
Screw Size: #8 (M4.2)
Head Diameter: 20mm
Stem Length: 12mm
Fits into 9mm Square Hole
Acura TSX and
Honda Civic & Odyssey 2004 - On

UNIT PACKAGE: 25



21209

(91601-STX-A00)
Gray Nylon

Rear Hatch
Screw Grommet with Sealer
Screw Size: M3.5 (#6)
Top Head Diameter: 12mm
Bottom Head Diameter: 14mm
Stem Length: 10mm
MDX 2009 - On

UNIT PACKAGE: 10



21700

(Acura: 91626-SP0-003)
Yellow Nylon

Front Pillar & Door Lining
Screw Grommet with Metal Insert
Screw Size: M5.5 (#12)
Head Size: 16mm x 22mm
Overall Height: 17mm
Acura Integra, Legend &
RSX 2006 - 1994

UNIT PACKAGE: 15



20472

(91512-SR3-004)
White Nylon

Tubular Nut with
Sealer & Sealed End
Stud Size: 3mm
Head Diameter: 8.5mm
Fits into 6mm Hole
Emblem Nut
Acura Integra and Honda Accord,
Civic, CR-V & Prelude 1994 - On

UNIT PACKAGE: 10



21773

(Honda: 91530-S0A-003)
Black Nylon

Roof Rail & Side Sill
Weatherstrip Retainer
Top Head Size: 5mm x 11mm
Bottom Head Diameter: 8mm
Stem Diameter: 6mm
Stem Length: 7mm
Acura Legend, MDX, RDX, RL, TL & ZDX 1998 - On
Honda Accord, Civic, CRV, Element
& Odyssey 2001 - On

UNIT PACKAGE: 25



21705

(Honda: 90651-TP8-003,
91568-TR0-003)
Yellow Nylon

Weatherstrip Retainer
Top Head Size: 5mm x 15mm
Bottom Head Diameter: 7.5mm
Stem Diameter: 6.5mm
Stem Length: 7mm
Acura ILX & RDX and Honda Civic & CR-V 2012 - On

UNIT PACKAGE: 25



21707

(Honda: 91563-SCV-003)
(Toyota: 67867-52010, 67867-0D060)
White Nylon

Weatherstrip Retainer
Head Size: 5mm x 15mm
Bottom Head Diameter: 6.5mm
Stem Diameter: 7mm
Stem Length: 8.5mm
Acura TL and Honda
Element Odyssey & Pilot 2003 - On
Toyota Echo, Land Cruiser, Prius, Tacoma & Yaris
and Lexus GS 450, GX 460 & LX 430 and
Scion xA & xD 2000 - On

UNIT PACKAGE: 25



21704

(Honda: 72311-S5S-003)
Green Nylon

Weatherstrip Retaining Clip
Top Head Size: 5mm x 15mm
Bottom Head Diameter: 9.5mm
Stem Diameter: 7mm
Stem Length: 11mm
Acura RDX and Honda Civic, CR-V & Fit 2003 - On

UNIT PACKAGE: 25



18877

(91530-SP1-003)
Orange Nylon

Weatherstrip Retainer
Head Size: 5mm x 15mm
Stem Length: 10mm
Fits into 6mm Hole
Acura 3.5 RL and Accord, Civic & Odyssey 1992 - On

UNIT PACKAGE: 25



18114

(91520-SM4-C01)
Black Nylon

Hood Insulation Retaining Clip
Head Diameter: 10mm
Stem Length: 10mm
Panel Thickness: 4mm
Fits into 6mm Hole
Honda & Acura 1990 - On

UNIT PACKAGE: 25



19506

(90666-SA7-003ZW)
Black Nylon

Trunk Lining Retainer
Head Diameter: 16mm
Stem Diameter: 5mm Square
Stem Length: 16mm
Acura 2.5TL, 3.2TL, 3.5,
Integra & Legend and Honda Accord,
Wagon & Prelude 1987 - On

UNIT PACKAGE: 15



19467

(91501-SL4-003)
Black Nylon

Front Cowl Retaining Clip
Head Diameter: 13mm
Stem Diameter: 6mm
Stem Length: 10mm
3.5RL 1996 - On

UNIT PACKAGE: 25



19114

(91518-SM4-003)
Black Nylon

Hood & Trunk Moulding Retaining Clip
Head Diameter: 12mm
Stem Length: 9mm
Fits into 6mm Hole
Acura Integra & Honda Civic 1994 - On

UNIT PACKAGE: 10



19483

(91515-SR3-000)
Black Nylon

Rear Hood Cowl
Weatherstrip Retaining Clip
Head Size: 8mm x 18mm
Stem Length: 15mm
Fits into 7mm Hole
Acura Integra, Honda Civic, CR-V
and Del Sol 1992 - On

UNIT PACKAGE: 25



19746

(91652-SZ3-003)
White Nylon

Door Lining Retainer
Head Diameter: 10.5mm
Stem Length: 15mm
3.5RL 1996 - On

UNIT PACKAGE: 10



18746

(90700-SJ4-000)
Black Nylon

Hood Insulation Retainer
Head Diameter: 30mm
Stem Diameter: 15mm x 18mm
Stem Length: 10mm
Legend 1991-On
Honda 1998-On

UNIT PACKAGE: 15



20609

(91501-S1K-003)
Black Nylon

Hood Insulation Retainer
Head Diameter: 30mm
Stem Diameter: 15mm x 20mm
Stem Length: 14mm
Acura 3.5RL & RSX and
Honda Civic & CR-V 2000 - On

UNIT PACKAGE: 25



19464

(90667-SD4-003)
Natural Nylon

Roof Lining Retainer
Top Head Diameter: 13mm
Bottom Head Diameter: 16mm
Stem Diameter: 7mm
Stem Length: 13mm
NSX, 2.2CL & 2.3CL 1991 - On

UNIT PACKAGE: 15



21107

(90602-SX0-003)
White Nylon

Cowl Vent Retainer
Top Head Diameter: 12mm
Bottom Head Diameter: 16mm
Stem Diameter: 4mm
Stem Length: 13mm
Acura MDX and Honda Civic,
Insight, Odyssey & Prelude 1995 - On

UNIT PACKAGE: 10



21417

(90602-TA0-003)
Blue Nylon

Cowl Vent Retainer
Top Head Size: 10mm x 14mm
Bottom Head Diameter: 16mm
Stem Diameter: 8mm
Stem Length: 13mm
Acura TSX & ZDX and Honda Accord & Fit 2008 - On

UNIT PACKAGE: 10



19466

(91560-SZ3-003)
White Nylon

Door Trim Panel Retainer
Top Head Diameter: 13mm
Bottom Head Diameter: 17mm
Stem Diameter: 9.5mm
Stem Length: 12mm
3.5RL 1996 - On

UNIT PACKAGE: 15



21208

(91560-SLJ-J01)
Gray Nylon

Door Trim Panel Retainer
Top Head Diameter: 13mm
Middle Head Diameter: 16mm
Bottom Head Diameter: 18mm
Stem Diameter: 9mm
Stem Length: 12mm

Acura RDX and Honda Civic, CR-V & Pilot 2009 - On

UNIT PACKAGE: 10



19145

(91560-SP0-003)
Gray Nylon

Front & Rear Door Trim Panel Retainer
Top Head Diameter: 13mm
Bottom Head Diameter: 17mm
Stem Diameter: 9mm
Stem Length: 12mm

Acura Integra & Legend Honda Accord, Civic, Prelude, Odyssey & Del Sol 1991 - On

UNIT PACKAGE: 25



21131

(90602-SEP-A00)
Black Nylon

Trim Panel Retainer
Top Head Diameter: 12mm
Middle Head Diameter: 16mm
Bottom Head Diameter: 18mm
Stem Diameter: 9.5mm
Stem Length: 13mm
TL 2007 - On

UNIT PACKAGE: 15



21059

(90602-S5A-003)
Blue Nylon

Cowl Vent Retainer
Top Head Size: 12mm x 13mm
Middle Head Diameter: 16mm
Bottom Head Diameter: 18mm
Stem Diameter: 8.5mm x 8.5mm
Stem Length: 14mm

Acura RSX and Honda Civic & CR-V 2001 - On

UNIT PACKAGE: 15



20411

(91560-S84-A11)
Black Nylon

Windshield Garnish Pillar Retainer
Top Head Diameter: 13mm
Middle Head Diameter: 16mm
Bottom Head Diameter: 14.5mm
Stem Diameter: 9.5mm
Stem Length: 12mm

Acura 3.2CL, Honda Accord, Insight & Odyssey 1998-On

UNIT PACKAGE: 15



19186

(90657-SB0-003)
Black Nylon

Front Bumper Cover Push-Type Retainer
Head Diameter: 11mm
Stem Length: 10mm



Fits into 8mm Hole
Acura Legend, Honda Accord & Odyssey 1991-On

UNIT PACKAGE: 10



20959

(91560-S9A-A01)
Blue Nylon

Door Panel Retainer
Top Head Diameter: 13mm
Middle Head Diameter: 16mm
Bottom Head Diameter: 15mm
Stem Diameter: 9.5mm
Stem Length: 13mm
Acura TL & TSX and Honda Accord, Civic, CR-V & Odyssey 2002 - On

UNIT PACKAGE: 25



22199

(Honda: 90657-SA5-003)
Black Nylon

Bumper & Splash Shield Push-Type Retainer
Head Diameter: 15mm
Stem Length: 12mm
Fits into 6.3mm Hole
Acura TL 2008 - 04
Honda Accord, CR-V, Insight & Pilot 2007 - 1997

UNIT PACKAGE: 15



19232

(91502-SZ5-003)
Black Nylon

Front Fender
Push-Type Retainer
Head Diameter: 17mm
Stem Length: 13mm
Fits into 7mm Hole
3.5 RL Sedan 1996-On

UNIT PACKAGE: 10



19231

(91505-SL0-003)
Black Nylon

Push-Type Retainer
Head Diameter: 18mm
Stem Length: 12mm
Fits into 8mm Hole
NSX 1991-On

UNIT PACKAGE: 15



22112

(Honda: 91512-STK-A01)
Black Nylon

Garnish & Rear Spoiler Push-Type
Retainer with Sealer
Head Diameter: 20mm
Stem Length: 13mm
Fits into 8.5mm Hole
Acura RDX & TSX and Honda Accord,
CR-V & Odyssey 2011 - On

UNIT PACKAGE: 10



22068

(Honda: 91513-SJK-003)
White Nylon

Rocker, Pillars, Spoiler,
Garnish & Exterior Trim
Push-Type Retainer with Sealer
Head Diameter: 20mm
Stem Length: 13mm
Fits into 8.5mm Hole
Acura MDX, RLX, TSX & ZDX and
Honda Accord, Civic, CR-V, Element, Fit,
Insight & Pilot 2007 - On

UNIT PACKAGE: 15



22069

(Honda: 91512-SJK-003)
White Nylon

Rocker, Pillars, Garnish & Exterior Trim
Push-Type Retainer with Sealer
Head Diameter: 20mm
Stem Length: 13mm
Fits into 8.5mm Hole
Acura ZDX 2013 - 2010
Honda Odyssey & Pilot 2005 - On

UNIT PACKAGE: 15



19233

(Acura: 91503-SZ3-003)
Black Nylon

Front Bumper
Push-Type Retainer
Head Diameter: 20mm
Stem Length: 13mm
Fits into 10mm Hole
Acura 3.5 RL Sedan
& Honda 1996-On

UNIT PACKAGE: 15



19239

(Honda: 91512-SX0-003;
GM: 11519949;
Mitsubishi: MU000319)
Black Nylon

Front Fender
Push-Type Retainer
Head Diameter: 20mm
Stem Length: 11mm
Fits into 8mm Hole
Acura 3.5RL, Honda Accord,
Prelude & Odyssey 1994-On
GM 1997 - On
Mitsubishi Lancer 2002 - On

UNIT PACKAGE: 25



21706

(Honda: 91505-TM8-003)
Black Nylon

Bumper and Wheel Well Liner
Push-Type Retainer
Head Diameter: 20mm
Stem Length: 14mm
Fits into 10mm Hole
Acura ILX and
Honda Insight 2012 - On

UNIT PACKAGE: 15



21173

(91506-S9A-003)
Black Nylon

Bumper & Splash Shield
Push-Type Retainer
with Metal Insert
Head Diameter: 20mm
Stem Length: 16mm
Fits into 10mm Hole
Acura MDX, RDX, TSX and
Honda Accord, Civic CR-V
& Fit 2009 - 04

UNIT PACKAGE: 10



20564

(91503-SZ5-003)
Black Nylon

Front & Rear Bumper
Push-Type Retainer
Head Diameter: 20mm
Stem Length: 18mm
Fits into 10mm Hole
Acura 3.5RL and Honda Accord
& Odyssey 1996 - On

UNIT PACKAGE: 15



19140

(Acura: 90505-SL0-003;
GM: 94852368;
Mitsubishi: MB888869;
Toyota: 90467-08155)
Black Nylon

Push-Type Retainer
Head Diameter: 20mm
Stem Length: 21mm
Fits into 8mm Hole
Acura, Dodge Avenger, Eagle Talon,
Geo Prizm, Mitsubishi Eclipse & Galant
and Toyota 1993-On

UNIT PACKAGE: 5



17267

(91503-SP0-003)
Black Nylon

Front & Rear Bumper
Push-Type Retainer
Head Diameter: 20mm
Stem Length: 15mm
Fits into 10mm Hole
Legend 1991 - On

UNIT PACKAGE: 15



21170

(91591-SJ6-013)
Natural Nylon

Door Lock Rod Clip
Rod Size: 5mm
Fits into 7mm Hole
Overall Height: 17mm
Acura TSX and Honda Accord,
Odyssey & Ridgeline 2003 - On

UNIT PACKAGE: 15



21388

(91558-SE3-003)
Black Nylon

Hood Release Cable,
Fuel Door Release Cable
and Sliding Door Lock Cable Clip
Maximum Cable Diameter: 5mm
Overall Height in Closed
Position: 17mm
Fits into 7mm Hole

Replaces Auveco 19672

Acura CL, Legend, NSX, RL, TL, TL,
TSX & Vigor and Honda Accord,
Civic, CR-V, Insight, Odyssey, Pilot,
Prelude & Ridgeline 1991 - On

UNIT PACKAGE: 25

Photo not actual size



20380

(Not Supplied By O.E.M.)
Black Nylon

Cable Strap
Length: 200mm (8")
Maximum Bundle Diameter:
44mm (1-3/4")
Fits into 6.3mm (1/4") Hole
Import Cars

UNIT PACKAGE: 25

GET THE KIT THAT FITS

**We have several assortments in
the green section.**

**Find the kit that contains your
most used clips and fasteners.**



13158

(5113-1-804-205)
Nylon

Moulding Clip
with Sealer

UNIT PACKAGE: 50

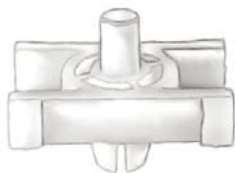

21767

(BMW: 51-13-1-829-904,
51-13-6-440-146)
White Nylon

Rocker Panel Moulding Clip
Width: 21mm
Length: 28mm
Stem Length: 6.5mm
3 Series 1993 - 74
5 Series 1981 - 74
602-2002 & 2002 Ti 1975 - 67

UNIT PACKAGE: 25



21423

(51321-938-884)
White Nylon

Window Regulator Guide
3 & 5 Series 1989 - On

UNIT PACKAGE: 2



21429

(51-13-1-960-054)
White Nylon with
Blue Rubber Boot

Moulding Clip
Width: 22mm
Length: 35mm
Stem Length: 11mm
BMW 1999 - 92

UNIT PACKAGE: 25



21430

(51-13-2-251-394)
White Nylon with
Blue Rubber Boot

Moulding Clip
Width: 18mm
Length: 30.5mm
Stem Length: 10mm
BMW 1999 - 92

UNIT PACKAGE: 25



21432

(51-13-8-166-675)
White Nylon with
Blue Rubber Boot

Moulding Clip
Width: 25.5mm
Length: 34mm
Stem Length: 11mm
BMW 2003 - 1995

UNIT PACKAGE: 25



21766

(BMW: 51-13-8-231-130)
White Nylon with
Blue Rubber Boot

Moulding Clip
Width: 20.5mm
Length: 35mm
Stem Length: 10.5mm
3 Series 2004 - 1997

UNIT PACKAGE: 25



21765

(BMW: 51-71-8-184-574)
White Nylon

Door Sill & Wheel Housing
Rocker Moulding Clip
Width: 20.5mm
Length: 32mm
Stem Length: 9.5mm
3 Series 2009 - 1991

UNIT PACKAGE: 25



22140

(BMW: 51717006757)
Gray Nylon

Door Seal Clip
Width: 14mm
Length: 36mm
Stem Diameter: 6mm
Stem Length: 6mm
BMW 7 Series & X5 2008 - 1998

UNIT PACKAGE: 25



22141

(BMW: 51717066220)
Yellow Nylon

Rocker Panel &
Wheel Housing Trim Cover Clip
Width: 24mm
Length: 22mm
Stem Diameter: 6mm
Stem Length: 10mm
BMW 3, 5 & 6 Series 2004 - On

UNIT PACKAGE: 15



22142

(BMW: 51717066223)
Green Nylon

Rocker Panel & Wheel
Housing Trim Cover Clip
Width: 19mm
Length: 32mm
Stem Diameter: 6mm
Stem Length: 11mm
BMW 5 Series 2010 - 2002

UNIT PACKAGE: 15



21782

(BMW: 51-11-7-160-451)
White Nylon

Door Sill &
Wheel Housing
Rocker Trim Moulding Clip
Width: 30mm
Length: 28mm
Overall Height: 29mm
7 Series 2004 - On

UNIT PACKAGE: 15



13170

(5141-1-802-258)
Natural Nylon

Barrel Nut
For 7mm Stud
Fits into 8mm Hole

UNIT PACKAGE: 50



22202

(BMW: 51131934160)
Natural Nylon

Side Moulding Grommet
Head Diameter: 10.5mm
Overall Length: 7mm
BMW 5, 7 & 8 Series 2009 - 1988

UNIT PACKAGE: 25



20186

(51-14-1-807-495, 51-14-1-902-279)
Natural Nylon

Emblem Grommet
Head Diameter: 12mm
Stem Length: 8mm
Fits into 6.8mm Hole
Series 3, 5, 6 & 7 2001 - 1986

UNIT PACKAGE: 15



22084

(BMW: 07147201307;
51757271848)
Natural Nylon

Heat Shield Screw Grommet
Screw Size: M4.2 (#8)
Head Diameter: 16mm
Stem Length: 13mm
Overall Height: 15mm
BMW 1, 3, 5, 6, 7
& X Series 2012 - 06

UNIT PACKAGE: 15



21763

(BMW: 51-45-8-161-557,
51-45-0-396-330)
Clear Nylon

Interior Trim Instrument Carrier
Mounting Grommet
with Metal Insert
Head Size: 15mm x 17mm
Stem Length: 13mm
Overall Length: 15mm
3, 5 & 7 Series 1994 - On

UNIT PACKAGE: 15



21764

(BMW: 51-41-700-16-29,
51-41-015-44-20,
51-45-030-47-03,
51-45-816-52-60)
Clear Nylon

Interior Trim Carrier Mounting
Grommet with Metal Insert
Top Head Size: 12.5mm x 15mm
Bottom Head Size: 15mm x 17mm
Stem Length: 14mm
Overall Length: 18mm
5 & 7 Series 1995 - On

UNIT PACKAGE: 15



21762

(BMW: 07-14-9-158-194,
51-41-821-58-06)
Clear Nylon

Door Lateral Trim
Grommet with Metal Insert
Head Size: 15mm x 17mm
Stem Length: 7mm
Overall Length: 11mm
3 Series 1997 - On

UNIT PACKAGE: 15



21775

(BMW: 51-45-8-266-814)
Red Nylon

Interior Trim Insert Grommet
Head Size: 17mm x 19mm
Stem Length: 9mm
3, 7 & X Series 1997 - On

UNIT PACKAGE: 25



22298

(BMW: 07-14-6-976-114)
White Nylon

Rear Bumper Trim Panel &
Air Duct Mount Screw Grommet
Screw Size: M4.2 (#8)
Head Diameter: 12mm
Stem Length: 14mm
Overall Height: 15mm

BMW 1, 2, 3, 4, 5, 6, 7 & X Series 1983 - On

UNIT PACKAGE: 25



20254

(51-13-8-124-389)
Black Plastic

Cowl Panel Moulding Insert
Head Diameter: 13mm
Stem Length: 11mm
Stem Diameter: 9mm

Use with Auveco 20388
Series 3 & 5 1989 - On

UNIT PACKAGE: 50



21499

(BMW: 51-44-7-780-135;
Mercedes-Benz: 108-988-00-27)
Natural Nylon

Tubular Nut
Stud Size: 7mm
Head Diameter: 16mm
Stem Length: 16mm
Fits into 8.5mm Hole
BMW, Mercedes-Benz & Universal

UNIT PACKAGE: 25



13167

(5121-6-442-159)
Nylon

Moulding Insert

UNIT PACKAGE: 25



21757

(BMW: 51-48-8-181-420)
Black Nylon

Trim Panel & Trunk Lining Retainer
Head Diameter: 18mm
Stem Diameter: 9mm
Stem Length: 15mm
3 Series & 5 Series 2004 - 1988

UNIT PACKAGE: 25



21776

(BMW: 51-77-7-171-003)
Black Nylon

Rocker Panel & Wheel Housing
Retainer with Rubber O-Ring
Head Diameter: 25mm
Shoulder Diameter: 14mm
Stem Diameter: 9.5mm
Stem Length: 16mm
X Series 2006 - On

UNIT PACKAGE: 25



21854

(BMW: 07-14-7-122-913)
Black Nylon

Rocker Trim Wheelhouse Retainer
T10 Torx® Drive
Head Diameter: 20mm
Stem Diameter: 7mm
Stem Length: 33mm
1, 3, 6 & X Series 2004 - On

UNIT PACKAGE: 15



22091

(BMW: 51717066299)
Black Nylon

Door Sill Cover Retainer
T27 Drive
Head Diameter: 20mm
Stem Diameter: 7mm
Stem Length: 24mm
BMW 5 & 6 Series 2011 - 02

UNIT PACKAGE: 15



21851

(BMW: 51-47-8-116-564,
51-47-2-499-935,
51-47-8-183-031, 51-47-1-881-521)
Black Nylon

Floor Mat Lock Retainer with Washer
Slotted Head Diameter: 18.5mm
Stem Length: 21mm
Washer Diameter: 20.5mm
3, 5, 7 & 8 Series 1997 - On

UNIT PACKAGE: 10



13179
(BMW: 51-41-8-172-050;
VW: 481-867-197)
Black Nylon

Trim Panel Retainer
VW & BMW

UNIT PACKAGE: 50



22057
(BMW: 51498123832;
51490151605; 5149810579)
Black Nylon

Trim Panel Retainer
Top Head Diameter: 13mm
Bottom Head Diameter: 18mm
Stem Diameter: 9mm
Stem Length: 12mm

BMW 3, 5, 6, 7, 8, X & Z Series 2012 - 1989

UNIT PACKAGE: 25



21787
(BMW: 51-77-7-171-002)
White Nylon

Wheel Arch Cover & Footboard
Retainer with Sealer

Top Head Diameter: 12mm
Bottom Head Diameter: 18mm
Stem Diameter: 9.5mm
Stem Length: 16mm

BMW X Series 2006 - On
Mini-Cooper S & SX Series 2011 - On

UNIT PACKAGE: 25



21777
(BMW: 51-47-1-945-266)
Black Nylon

Trunk Luggage Compartment
& Sill Trim Retainer

Top Head Diameter: 18mm
Bottom Head Diameter: 18mm
Stem Diameter: 5mm x 8mm
Stem Length: 18mm

3, 5 & M Series 1983 - On

UNIT PACKAGE: 25



22092
(BMW: 51717066226)
Black Nylon

Rocker Moulding &
Door Sill Spacer Cover Retainer

Top Head Diameter: 30mm
Bottom Head Diameter: 18.5mm
Stem Length: 14mm
Overall Length: 27mm

BMW 5 & 6 Series 2011 - 02

UNIT PACKAGE: 15



22086
(BMW: 07147122912)
Black Nylon

Rocker Panel &
Wheelhouse Trim Retainer
Top Head Diameter: 30mm
Bottom Head Diameter: 22mm
Stem Length: 14mm
Overall Length: 32mm

BMW 1, 3, 6 & X Series 2012 - 04

UNIT PACKAGE: 15



20253
(51-41-1-973-500)
White Nylon

Trim Panel Retainer
Top Head Diameter: 14mm
Middle Head Diameter: 15mm
Bottom Head Diameter: 18mm
Stem Diameter: 9mm
Stem Length: 15mm

Series 3, 5 & 7 1987 - On

UNIT PACKAGE: 50



21788
(BMW: 51-41-8-224-768,
51-41-0-407-984)
White Nylon

Door Panel Lining &
Rear Window Retainer with Sealer

Top Head Diameter: 14mm
Middle Head Diameter: 15.5mm
Bottom Head Diameter: 18mm
Stem Diameter: 9.5mm
Stem Length: 14mm

Overall Length: 21mm
BMW X Series 2006 - On
Mini-Cooper 2002 - On

UNIT PACKAGE: 25



21873
(BMW: 51-43-7-001-491)
White Nylon

Trim Panel Retainer
Top Head Diameter: 14mm
Middle Head Diameter: 15mm
Bottom Head Diameter: 18mm
Stem Diameter: 9.5mm
Stem Length: 14mm
Overall Length: 21mm

Renault, Dacia & BMW

UNIT PACKAGE: 25



22229

(BMW: 51418224781;
51410407983; 51430141025)
Gray Nylon

Door Trim Panel Retainer with Sealer
Top Head Diameter: 14.5mm
Middle Head Diameter: 15.5mm
Bottom Head Diameter: 18mm
Stem Diameter: 9.5mm
Stem Length: 14mm

BMW 1, 3, 4, 5, 6, X & Z Series 1992 - On

UNIT PACKAGE: 25



22090

(BMW: 51477117532)
Brown Nylon

Scuff Plate Retainer with Sealer
Top Head Size: 11.6mm x 15mm
Middle Head Size: 11mm x 15mm
Bottom Head Diameter: 20mm
Stem Length: 16mm
Overall Length: 30mm
Fits into 10mm Hole

BMW 1, 3, 5, 6 & X Series 2012 - 02

UNIT PACKAGE: 15



21780

(BMW: 51-47-8-166-992)
Black Nylon

Trunk Lid Compartment Trim &
Wheel Well Push-Type Retainer
Head Diameter: 9mm
Stem Length: 7mm
Fits into 5mm Hole

3, 5, & M Series 1993 - On

UNIT PACKAGE: 25



21779

(BMW: 51-46-7-002-606)
Black Nylon

Front Bumper, Grille, Trunk Panel
& Rear Window Push-Type Retainer
Head Diameter: 10mm
Stem Length: 11mm
Fits into 6.3mm Hole

3, 5, 7 & Z Series 1997 - On

UNIT PACKAGE: 25



22303

(BMW: 51-16-8-197-908)
Black Nylon

Upper Cover & Spoiler
Push-Type Retainer
Head Diameter: 12mm
Stem Length: 13mm
Fits into 7mm Hole

BMW 1, 3, M3 & Z4 and Mini-Cooper Base, John
Cooper Works, Countryman & Paceman 2013 - On

UNIT PACKAGE: 15



22201

(BMW: 51498166702)

Trim Panel
Push-Type Retainer
Head Diameter: 12.5mm
Stem Length: 12mm
Fits into 8.5mm Hole
BMW 1, 2, 3, 5, 6, 7, X & Z Series
1995 - On

UNIT PACKAGE: 15



21645

(Not Available from O.E.M.)
Black Nylon

Bumper & Wheel Opening
Push-Type Retainer
Head Diameter: 15mm
Stem Length: 15mm
Fits into 6.3mm Hole
BMW 2004 - On

UNIT PACKAGE: 15



20234

(BMW: 51-11-1-908-077;
Mercedes: 000-990-54-92)
Black Nylon

Bumper, Grille, Scuff Plate
& Trim Push-Type Retainer
Head Diameter: 15mm
Stem Length: 15mm
Fits into 6.3mm Hole
BMW Series 3, 5 & 7 1984 - On
Mercedes-Benz 2014 - 1994

UNIT PACKAGE: 50



20638

(BMW: 51471911992,
51470146782, 51470390017
Mercedes-Benz: 201-990-02-92)
Black Nylon

Push-Type Retainer
Head Diameter: 20mm
Stem Length: 14mm
Fits into 8.5mm Hole
BMW 1, 2, 3, 4, 5, 6, 7, i3, i8, X &
Z Series 1988 - On
Mercedes-Benz

UNIT PACKAGE: 25

WE WELCOME INQUIRIES

Email your product suggestions to

mail@auveco.com



20388

(51218-205-295)
Black Nylon

Cowl Vent Push-Type Retainer
Head Diameter: 20mm
Stem Length: 16mm
Use with Auveco 20254
Series 5 1997 - On

UNIT PACKAGE: 50



20270

(51-48-1-915-464, 51-48-1-938-725)
Black Nylon

Hood & Trunk Insulation
Push-Type Retainer
Head Diameter: 20mm
Stem Length: 9mm
Fits into 7mm Hole
Series 3, 5 & 7 2001 - 84

UNIT PACKAGE: 25



20734

(51-11-1-944-537)
Black Nylon

Bumper, Wheel Opening, Scuff Plate &
Interior Trim Push-Type Retainer
Head Diameter: 20mm
Stem Length: 15mm
Fits into 6.3mm Hole
Series 3, 5, 7 & X5 1989 - On

UNIT PACKAGE: 50



21781

(BMW: 51-71-8-259-788;
51-71-0-391-077)
Black Nylon

Rocker Panel, Air Duct Compartment
& Wheel Housing Push-Type Retainer
Head Diameter: 20mm
Stem Length: 16mm
Fits into 6.3mm Hole
3, 5, 6, 7 & Z Series 1994 - On

UNIT PACKAGE: 25



20248

(51-11-8-174-185)
Black Nylon

Bumper Trim
Push-Type Retainer
Head Diameter: 20mm
Stem Length: 17mm
Fits into 6.3mm Hole
Series 3, 5 & 7 1995 - On

UNIT PACKAGE: 25



22052

(BMW: 51471919209)
Black Nylon

Interior Trim & Engine
Intake Duct Push-Type Retainer
Head Diameter: 20mm
Stem Length: 17mm
Fits into 6.3mm Hole
BMW 3, 5, 7, 8, X and Z Series 2012 - 1984

UNIT PACKAGE: 25



21778

(BMW: 51-12-7-004-445)
Black Nylon

Rear Bumper Support Fixture Trim
Push-Type Retainer
Head Diameter: 20mm
Stem Length: 21mm
Fits into 8.5mm Hole
3, 5 & 6 Series 2002 - On

UNIT PACKAGE: 25



16115

(5113-1-885-399)
Black Nylon

Push-Type Retainer
Head Size: 7mm x 15mm
Stem Length: 17mm
Fits into 6mm x 6mm Hole

UNIT PACKAGE: 25



20653

Gray Nylon

Wire Routing Clip
Inside Diameter: 7mm x 10mm
Fits into 6mm Hole
BMW & Mercedes

UNIT PACKAGE: 50

21305

(Not Available from O.E.M.)
Natural Nylon

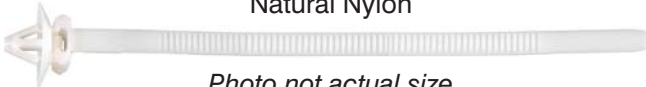

Photo not actual size
Push-Mount Cable Strap
Overall Length: 156mm (6-1/8")
Strap Width: 5mm (3/16")
Snaps into 6.3mm (1/4") Hole
Maximum Bundle Diameter: 40mm (1-9/16")
European Makes & Universal

UNIT PACKAGE: 25



21431

(BMW: 16-13-1-176-747;
Mercedes-Benz: 003-990-02-51)
Black Nylon

Nylon Flange Nut
Stud Size: 5mm
Hex: 10mm
Flange Diameter: 16mm
Overall Height: 11mm
BMW & Mercedes-Benz 1997 - On

UNIT PACKAGE: 25



22087

(BMW: 51711958025)
Black Nylon

Heater & Air Conditioning
Duct Nylon Nut
Screw Size: M4.8 (#10)
Hex Size: 10mm
Flange Diameter: 24mm
Overall Height: 10.3mm

BMW 1, 3, 5, 7, X & Z Series 2012 - 1986

UNIT PACKAGE: 25



22109

(BMW: 51437194187)
Zinc & Yellow

Trim Retaining Clip
Width: 13mm
Overall Height: 15mm
BMW 3, 5, 7, 8, X & Z Series 2012 - 1986

UNIT PACKAGE: 25



13221

(0712-9-929-706)
Plated

U-Type Nut
Screw Size: 2.9mm
Panel Range: .5mm-1.5mm
Center of Hole to Edge: 6mm

UNIT PACKAGE: 50



13223

(BMW:0712-9-925-708;
Mercedes: 000-994-25-45)
Plated

U-Type Nut
Screw Size: 4.2mm (#8)
Panel Range: 3mm -4mm
Center of Hole to Edge: 7mm

UNIT PACKAGE: 50



13216

Zinc

U-Type Nut
Screw Size: 4.8mm (#10)
Panel Range: .9mm -2mm
Center of Hole to Edge: 8mm

UNIT PACKAGE: 25



13218

(BMW: 0712-9-925-737;
Mercedes: 000-994-06-45)
Plated

U-Type Nut
Screw Size: 4.8mm (#10)
Panel Range: .5mm-1.7mm
Center of Hole to Edge: 7mm

UNIT PACKAGE: 50



13215

(BMW: 0711-9-916-945;
Mercedes: 000-994-14-45)
Plated

U-Type Nut
Screw Size: 4.8mm (#10)
Panel Range: .8mm -1.7mm
Center of Hole to Edge: 11mm

UNIT PACKAGE: 50



22114

(BMW: 07129904150)
Zinc Finish

U-Type Nut
Screw Size: M4.8 (#10)
Panel Range: 2.3mm - 3.5mm (.090"-.138")
Center of Hole to Edge: 8.5mm
BMW 2011 - 1992

UNIT PACKAGE: 25



13162

(0712-9-925-720)
Plated

U-Type Nut
Screw Size: 5.6mm
Panel Range: 1.2mm -2.0mm
Center of Hole to Edge: 10mm

UNIT PACKAGE: 50

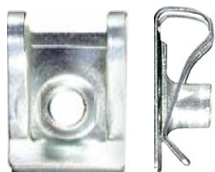

22113

(BMW: 51127070202;
VW: N90168602)
Zinc Finish

Metric Extruded U-Nut
Screw Size: M5-.8
Panel Range: .45mm - 1.5mm
Center of Hole to Edge: 11.5mm
BMW 1999 - 1992
VW 1993 - On

UNIT PACKAGE: 25



21844

BMW: 51-11-8-400-709)
Black Nylon

Front Bumper Nylon Rivet
Diameter: 6mm
Grip: 1mm - 6.5mm
Flange Diameter: 13mm
BMW 1987 - On

UNIT PACKAGE: 25



21861

(BMW: 51-11-1-942-789)
Black Nylon

Nylon Rivet
Diameter: 6mm
Grip: 1mm - 9mm
Flange Diameter: 13mm
BMW 1989 - On

UNIT PACKAGE: 25



22131

(BMW: 7147391324)
White Nylon

Wheel Arch Trim Cover Nylon Rivet
Diameter: 6mm
Grip Range: 1.5mm - 10mm
Flange Diameter: 20mm
BMW X5 2013 - On

UNIT PACKAGE: 25



22147

(BMW: 51777171004)
Black Nylon

Wheel Arch Trim Cover Nylon Rivet
Diameter: 6mm
Grip Range: 1.5mm - 10mm
Flange Diameter: 20mm
BMW X3, X4, X5 & X6 Series 2006 - On

UNIT PACKAGE: 25

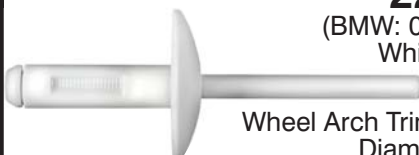

22144

(BMW: 07147391323)
White Nylon

Wheel Arch Trim Cover Nylon Rivet
Diameter: 6mm
Grip Range: 2.5mm - 10.75mm
Flange Diameter: 20mm
BMW X3, X4 & X5 Series 2010 - On

UNIT PACKAGE: 25



22146

(BMW: 07147293278)
Black Nylon

Wheel Arch Trim Cover Nylon Rivet
Diameter: 6mm
Grip Range: 2.5mm - 10.75mm
Flange Diameter: 20mm
BMW X3, X4 & X5 Series 2010 - On

UNIT PACKAGE: 25

FIAT CLIPS & FASTENERS



13198

(4-29-29-06)
Black Nylon

Interior Trim Retainer
Head Diameter: 16mm (41/64")
Stem Diameter: 9mm (11/32")
Stem Length: 18mm (11/16")

UNIT PACKAGE: 50



21802

(Renault: 77-03-077-231;
Fiat: 14591787)
Black Nylon

Retainer
Head Diameter: 15mm
Stem Diameter: 8mm
Stem Length: 17mm
Renault, Dacia and Fiat

UNIT PACKAGE: 25



21803
(Fiat: 14592087)
Black Nylon

Retainer
Head Diameter: 20mm
Stem Diameter: 8mm
Stem Length: 23mm
Renault, Dacia and Fiat

UNIT PACKAGE: 25



21804
(Fiat: 14592086)
Gray Nylon

Retainer
Head Diameter: 20mm
Stem Diameter: 8mm
Stem Length: 23mm
Renault, Dacia and Fiat

UNIT PACKAGE: 25

HONDA CLIPS & FASTENERS



17195
(Isuzu: 8942180270)
Black Nylon

Grille Clip
Width: 13mm
Length: 22mm
Ford Escort, Honda, Isuzu,
Mitsubishi & Plymouth Laser

UNIT PACKAGE: 25



12576
(90665-SA0-9700)
Nylon

Side Protector Moulding Clip
Width: 20mm
Length: 41mm
Snaps into 8mm Hole

UNIT PACKAGE: 10



18457
(91578-SV4-003)
Nylon

Radiator Grille Clip
Accord 1994-On

UNIT PACKAGE: 5



20603
(Honda: 71592-S5D-000)
White Nylon

Bumper Retainer
with Sealer
Head Size:
20mm x 23mm x 15mm
Stem Length: 22mm
2001 - On

UNIT PACKAGE: 15



21836
(Honda: 91578-TOA-003)
Yellow Nylon

Bumper Moulding Clip
Head Size: 19mm x 24mm
Stem Length: 15mm
Overall Length: 40mm
Honda CRV 2012 - On

UNIT PACKAGE: 15



20331
(90108-SS0-003)
Black Nylon

Bumper Clip
Screw Size: #8
Width: 35mm
Height: 38mm
Accord 1998 - On

UNIT PACKAGE: 5



19439
(90116-S82-A01)
Nylon

Left Rear Bumper Fascia Clip
Accord 1998-On

UNIT PACKAGE: 5



20677
(71598-S30-013)
Black Nylon

Rear Bumper
Moulding Clip with Sealer
Width: 34mm
Length: 30mm
Overall Height: 31mm
Accord 1998 - On

UNIT PACKAGE: 5



22262
 (Honda: 90617-TBA-A01)
 Cowl Moulding Clip
 Top Head Size: 18mm x 19mm
 Stem Diameter: 6.6mm
 Stem Length: 13mm
 Honda Civic 2016 - On
 UNIT PACKAGE: 25



15997
 (34355-SD2-003)
 Nylon
 Side Marker Clip
 Accord 1986 - On
 UNIT PACKAGE: 25



22242
 (Honda: 90601-SMG-003)
 Yellow Nylon
 Front Bumper, Fender, Exterior
 Trim & Quarter Panel Moulding Clip
 Width at Bottom: 14mm
 Overall Height: 17.5mm
 Honda CR-V, HR-V & Pilot 2012 - On
 UNIT PACKAGE: 25



21186
 (75305-SHJ-003)
 White Nylon
 Front and Side Door
 Exterior Trim Moulding Clip
 Width: 13mm
 Length: 14mm
 Height: 13mm
 Odyssey 2005 - On
 UNIT PACKAGE: 15



21207
 (91513-SMG-E11)
 White Nylon
 Fender Moulding Clip
 Top Head Size: 7mm x 7mm
 Bottom Head Size: 10mm x 19mm
 Stem Length: 6mm
 CR-V 2009 - On
 UNIT PACKAGE: 25



22241
 (Honda: 91513-SMG-E01)
 White Nylon
 Wheel Arch Garnish Moulding Clip with Sealer
 Top Head Size: 7mm x 7mm
 Bottom Head Size: 10mm x 19.5mm
 Stem Length: 6mm
 Honda CR-V 2007 - On
 Honda Pilot 2016 - On
 UNIT PACKAGE: 25



14306
 (90675-692-0031)
 Nylon
 Body Side Moulding Clip
 Width: 18mm
 Length: 15mm
 Snaps into 10mm Hole
 UNIT PACKAGE: 25



14308
 (90679-692-003)
 Nylon
 Body Side Moulding Clip
 Width: 10mm
 Length: 12mm
 Snaps into 10mm Hole
 UNIT PACKAGE: 25



17443
 (91534-SE0-000)
 Nylon
 Body Side Moulding Clip
 Accord 1986 - On
 UNIT PACKAGE: 25



21470
 (75306-SZA-A01)
 White Nylon
 Moulding Clip
 Top Head Size: 7.5mm x 10mm
 Bottom Head Size: 9.5mm
 Overall Height: 16mm
 Pilot 2009 - On
 UNIT PACKAGE: 15



21557
 (75316-S9A-004)
 White Nylon
 Door Trim Moulding Clip
 Head Size: 14mm x 16mm
 Stem Length: 12mm
 Fits into 10mm Hole
 Acura RDX and Honda CR-V 2002 - On
 UNIT PACKAGE: 25



21559
 (91512-SJ6-J01)
 Black Nylon
 Rocker Panel, Tail Light &
 License Plate Housing Garnish
 Moulding Clip with Sealer
 Top Head Size: 9mm x 12mm
 Bottom Head Diameter: 13mm
 Stem Diameter: 7.5mm
 Stem Length: 9mm
 Acura TSX and Honda Civic & CR-V 1997 - On
 UNIT PACKAGE: 25



20602

(75306-SV1-A01)
White Nylon

Body Side Moulding Clip
Head Size: 14mm x 14mm
Stem Length: 14mm
Accord 1998 - On

UNIT PACKAGE: 25



21556

(75305-SM4-A01)
White Nylon

Fender Trim Moulding Clip
Head Size: 13mm x 15mm
Stem Length: 15mm
Accord & Civic 2000 - 1990

UNIT PACKAGE: 25



21639

(72431-S2X-003)
White Nylon

Moulding Clip
Top Head Size: 8mm x 10.5mm
Bottom Head Size: 11mm x 16mm
Overall Height: 14.6mm
Acura RSX and Honda Civic, CR-Z & Insight 2006 - 01

UNIT PACKAGE: 25



20783

(75305-S0A-003)
White Nylon

Body Side Moulding Clip
Head Size: 6.5mm & 13mm x 18mm
Stem Length: 12mm
Civic, CR-V, Odyssey & Pilot 1999 - On

UNIT PACKAGE: 10



20785

(75305-SH4-003)
Red Nylon

Body Side Moulding Clip
Head Size: 14mm x 15mm
Stem Length: 14mm
Civic 1996 - On

UNIT PACKAGE: 10



20784

(75305-SH2-003)
Blue Nylon

Body Side Moulding Clip
Head Size: 12mm x 15mm
Stem Length: 15mm
Civic & CR-V 1996 - On

UNIT PACKAGE: 10



21109

(75329-SH4-013)
Red Nylon

Door Moulding Clip
Head Size: 10mm x 12mm
Stem Length: 13mm
Accord 1990 - On

UNIT PACKAGE: 15



21308

(90602-SFA-004)
White Nylon

Cowl & Dash Moulding Clip
Top Head Size: 13mm x 14mm
Bottom Head Diameter: 16mm
Stem Length: 13mm
Acura RL and Honda Civic, Civic Hybrid & Odyssey 2005 - On

UNIT PACKAGE: 25



21772

(Honda: 76222-SP1-003)
White Nylon

Body Side, Fender Flare, Roof Garnish & Side Sill Moulding Clip with Sealer
Top Head Size: 12.5mm x 14mm
Bottom Head Diameter: 14mm
Stem Diameter: 7mm
Stem Length: 8mm
Acura Legend, MDX, RDX, RL, TL & ZDX 1991 - On
Honda Civic, Element, Odyssey & Pilot 2004 - On

UNIT PACKAGE: 25



22130

(Not Available from O.E.M.)
White Nylon

Body Side Moulding Clip
Head Size: 14.5mm x 20mm
Stem Length: 14mm
Fits into 8mm Hole
Honda CR-V 2012 - On

UNIT PACKAGE: 25



21555

(91512-S50-003)
White Nylon

License Plate Garnish & Trim Moulding Clip with Sealer
Top Head Size: 12mm x 17mm
Bottom Head Size: 16mm x 17mm
Stem Diameter: 13mm
Stem Length: 12mm
Acura TSX & ZDX and Honda Accord, Civic, Crosstour, Fit, Insight, Odyssey & Pilot 2001 - On

UNIT PACKAGE: 25



22283

(Honda: 91514-SAA-003)
White Nylon

Rocker Panel Moulding
Clip with Sealer
Top Head Size: 18mm x 16mm
Bottom Head Size: 22mm x 20mm
Overall Height: 19mm
Honda Fit 2013 - 2007

UNIT PACKAGE: 15



21419

(91503-S3Y-003)
White Nylon

Rocker, Pillars, Floor & Exterior Trim
Moulding Clip with Sealer
Top Head Size: 11mm x 13mm
Bottom Head Size: 15.5mm x 19mm
Stem Diameter: 12mm
Stem Length: 19mm
Insight 2006 - On

UNIT PACKAGE: 10



21558

(91504-SP1-003)
White Nylon

Rocker Panel & Fender
Moulding Clip with Sealer
Top Head Size: 16mm x 18mm
Bottom Head Size: 18mm x 20mm
Stem Length: 15mm
Fits into 10mm Hole
Acura Legend, MDX, RL & ZDX and
Honda Civic, CR-V & Odyssey 1991 - On

UNIT PACKAGE: 25



21636

(71591-S5A-000)
White Nylon

Moulding Clip with Sealer
Top Head Size: 13mm x 17mm
Bottom Head Size: 19mm x 22mm
Stem Length: 15mm
Civic 2005 - 2000

UNIT PACKAGE: 15



21216

(91502-S9A-003)
White Nylon

Front & Rear Bumper
Moulding Clip with Sealer
Head Size: 14mm x 26mm
Stem Length: 15mm
Height: 28mm
CR-V 2002 - On

UNIT PACKAGE: 10



19737

(91515-SR4-003)
Red Nylon

Side Moulding Clip
Civic 1995 - 92

UNIT PACKAGE: 10



17981

(91510-SR3-003)
Nylon

Belt Moulding Clip
Civic 1992-On

UNIT PACKAGE: 10



20272

(91589-SV4-003)
Red Nylon

Belt Moulding Clip
Width: 20mm
Length: 24mm
Accord 1994 - On

UNIT PACKAGE: 25



20737

(91562-S84-A01)
Yellow Nylon

Belt Moulding Clip
Width: 20mm
Length: 27mm
Accord 1998 - On

UNIT PACKAGE: 10



21796

(Honda: 91503-T2A-A01)
Pink Nylon

Belt Moulding Clip
Width: 20mm
Length: 29mm
Honda Accord 2013 - On

UNIT PACKAGE: 25



17442

(90601-SH3-014)
Nylon

Door Belt Moulding Clip
Civic 1988-On

UNIT PACKAGE: 10



21597
(91519-SCV-A01)
Gray and
Green Nylon
Moulding Clip
Element 2003 - On

UNIT PACKAGE: 10



19359
(91531-ST0-003)
Nylon
Door Moulding Clip
Civic 2, 3 & 4 Door
1995 - On

UNIT PACKAGE: 10



19415
(91527-SM4-003, 91527-SZ3-003,
91561-S84-A01)
White Nylon
Belt Moulding Clip
Accord & Odyssey
1990 - On

UNIT PACKAGE: 10

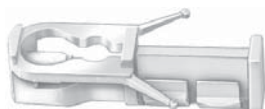

19740
(90666-SSO-003)
White Nylon
Roof Moulding Clip
Acura Integra & Legend
Prelude 1992 - On

UNIT PACKAGE: 10

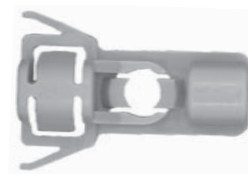

19680
(91501-SM5-A00)
Gray Nylon
Roof Moulding Clip
Odyssey 1995 - On

UNIT PACKAGE: 10



17096
(91513-SM4-000)
Nylon
Rocker Panel Moulding Clip
Width: 20mm
Length: 20mm
Fits into 12mm Hole
Accord 1991 - On

UNIT PACKAGE: 10



17320
(90612-AF1-003)
Nylon
Window Reveal Moulding Clip
Upper Quarter Glass
Prelude 1988 - On

UNIT PACKAGE: 15



20782
(75306-SDA-A01)
White Nylon
Moulding Clip
Head Size: 21mm x 27mm
Stem Length: 11mm
Accord 2003 - On

UNIT PACKAGE: 10

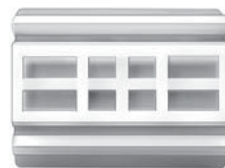

19476
(91577-SV4-003)
Red Nylon
Windshield Left-Hand Corner
Moulding Clip
Acura 2.2CL, 2.3CL & 3.0CL;
Honda Accord & Odyssey 1994 - On

UNIT PACKAGE: 10



19477
(91576-SV4-003)
Green Nylon
Windshield Right-Hand Corner
Moulding Clip
Acura 2.2CL, 2.3CL & 3.0CL;
Honda Accord & Odyssey 1994-On

UNIT PACKAGE: 10



18405
(91562-SV4-003)
Yellow Nylon
Windshield Side
Moulding Clip
Accord 1994 - On

UNIT PACKAGE: 5

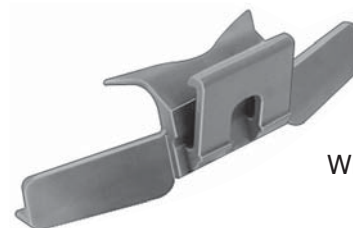

18865
(91529-SS0-003)
Gray Nylon
Windshield Moulding Clip
Prelude 1992 - On

UNIT PACKAGE: 15

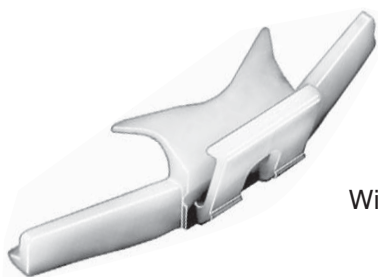

18866
(91528-SS0-003)
White Nylon

Windshield Moulding Clip
Prelude 1992 - On

UNIT PACKAGE: 15



18864
(91530-SS0-003)
Black Nylon

Windshield Moulding Clip
Prelude 1992 - On

UNIT PACKAGE: 15



14701
(90658-SB0-003)
Black Nylon

Windshield Moulding Clip
Width: 17mm
Length: 34mm
Includes Adhesive Mounting Pads

UNIT PACKAGE: 10



14685
(90683-SC6-003;
90683-SA6-003)
Gray Nylon

Windshield Moulding Clip
Width: 14mm
Length: 60mm
Includes Adhesive Mounting Pads

UNIT PACKAGE: 10



21095
(91570-SDA-A01)
Blue Nylon

Windshield Moulding Clip
Width: 15mm
Length: 76mm
Accord 2003 - On

UNIT PACKAGE: 10



21096
(91571-SDA-A01)
White Nylon

Windshield Moulding Clip
Width: 16mm
Length: 75mm
Accord 2003 - On

UNIT PACKAGE: 10



21543
(91570-SZA-305)
Blue Nylon

Windshield Moulding Clip
Width: 8mm
Length: 82mm
Acura ZDX and Honda Odyssey & Pilot 2009 - On

UNIT PACKAGE: 5



20387
(91519-S5A-003)
Black Nylon

Windshield Moulding Clip
Width: 17mm
Length: 50mm
Upper Area of Windshield
Civic Coupe 2001 - On

UNIT PACKAGE: 10

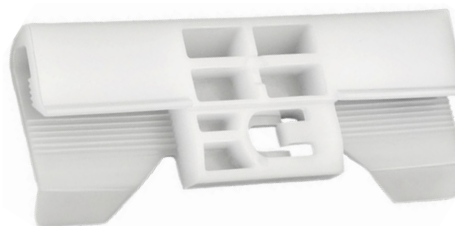

20386
(91520-S5A-003)
White Nylon

Windshield Moulding Clip
Width: 23mm
Length: 63mm
Lower Area of Windshield
Civic Sedan 2001 - On

UNIT PACKAGE: 10

21094
(91572-SDA-A01)
White Nylon



Windshield Moulding Clip
Width: 14mm
Length: 62mm
Accord 2003 - On
Civic 2006 - On

UNIT PACKAGE: 10

22273
(Honda: 73154-TA0-A01)
Blue Nylon



Windshield Moulding Clip
Width: 16mm
Length: 61.3mm
Width across Bottom Legs: 54mm
Honda Accord 2012 - 2008

UNIT PACKAGE: 15

18404
(91572-SV4-003)
Nylon



Windshield Side Moulding Clip
Accord 1994 - On

UNIT PACKAGE: 10



14705
(90713-SB0-003)
Black Nylon

Quarter Window Moulding Clip
Width: 18mm
Length: 18mm
Snaps into 5mm Hole

UNIT PACKAGE: 25

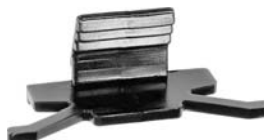

14700
(90672-SA6-003)
Black Nylon

Windshield Moulding Clip
Width: 14mm
Length: 35mm

UNIT PACKAGE: 25



14703
(90673-SC6-003)
White Nylon

Windshield Moulding Clip
Width: 14mm
Length: 35mm

UNIT PACKAGE: 25



15472
(90664-SB0-004)
Black Nylon

Windshield Moulding Clip
Width: 11mm
Length: 35mm
Honda 1983 - On

UNIT PACKAGE: 15



17280
(91505-SG0-003)
Orange Nylon

Windshield Moulding Clip
Honda Prelude and
Acura Legend 1988-On

UNIT PACKAGE: 10



17281
(90694-SB0-003)
Black Nylon

Windshield Moulding Clip
Prelude 1983 - On

UNIT PACKAGE: 15



19115
(91528-S01-A01)
Blue Nylon

Drip Moulding Clip
4 Door Civic 1995 - On

UNIT PACKAGE: 15

22165

(Honda: 73156-T0A-003)
Brown Nylon



Drip Moulding Clip
Length: 61mm
Honda CR-V 2012 - On

UNIT PACKAGE: 25



20350

(90866-SA0-000)
Natural Nylon

Door Trim Nylon Nut
Screw Size: #4
Head Size: 13mm x 13mm
Stem Length: 7mm
Civic 1998 - On

UNIT PACKAGE: 25



16825

(74806-SB6-003)
White Nylon

Back Glass Moulding Clip
Width: 33mm
Length: 30mm
Snaps into 6mm Hole
Civic, Hatchback 1984 - On

UNIT PACKAGE: 25



20351

(90666-SD9-000)
Natural Nylon

Nylon Nut
Screw Size: #14 (M6.3)
Head Size: 16mm x 16mm
Stem Length: 8mm
CR-V 1997 - On

UNIT PACKAGE: 25



14288

(90655-SA0-003)
Natural Nylon

Screw Size: #6
Width: 9.5mm
Length: 9.5mm
Snaps into 6mm x 6mm Hole

UNIT PACKAGE: 50



17058

(90676-SA7-003)
Natural Nylon

Headlight Adjusting Screw Nut
Screw Size: M5-8
Prelude & Accord 1986 - On

UNIT PACKAGE: 25



14317

(34301-692A-0000)
White Nylon

Screw Size: #8
Width: 9.5mm
Length: 9.5mm
Snaps into 6mm x 6mm Hole

UNIT PACKAGE: 50



14287

(90656-671-6310M1)
Natural Nylon

Screw Size: #14 (1/4")
Width: 13mm
Length: 15mm
Snaps into 8.5mm x 10.5mm Hole

UNIT PACKAGE: 50



14255

(Honda: 75522-611-000;
Mazda: 9991-00-412;
Mitsubishi: MS-480001)
Black Nylon

Screw Size: #8
Width: 9.5mm
Length: 9.5mm
Snaps into 7mm x 7mm Hole

UNIT PACKAGE: 50



14294

(90675-SA6-003)
Natural Nylon

Screw Grommet with Sealer
Screw Size: #6
Width: 15mm
Length: 15mm
Stem Length: 12mm
Snaps into 7mm x 7mm Hole

UNIT PACKAGE: 15



14274

(Honda: 75521-611-000;
Mazda: 9991-00-601;
Nissan: 96706-P0105
Toyota: 90189-06010)
Natural Nylon

Screw Size: #10
Width: 13mm
Length: 13mm
Snaps into 8.5mm x 8.5mm Hole

UNIT PACKAGE: 25



19117

(91619-SM4-003,
91619-SM4-0030)
Natural Nylon

Center Pillar Garnish
Moulding (Oval) Screw Grommet
Screw Size: #4
Odyssey & Accord Wagon 1991 - On

UNIT PACKAGE: 25



14313

(Honda: 90662-671-003;
Mazda: 9991-00-503;
Nissan: 62698-V7000, 68425-H5000)
Natural Nylon

Screw Size: #10
Width: 17mm
Length: 17mm
Snaps into 8mm x 8.5mm Hole
Also for Mazda & Nissan

UNIT PACKAGE: 25



21635

(91603-SL0-000)
Natural Nylon

Screw Size: M4.8 (#10)
Head Diameter: 16mm
Stem Length: 7mm
Fits into 8mm x 8mm Hole
Insight 2006 - 2000

UNIT PACKAGE: 25



17609

(91635-SM4-003)
Black Nylon

Headlight to Grille
Spacer Bracket Grommet
Screw Size: #10
Accord 1990 - On

UNIT PACKAGE: 10



20612

(90603-S7S-003)
Blue Nylon with Sealer

Cowl Vent Grommet
Flange Size: 10mm x 24mm
Stem Length: 6mm
Use with Auveco 20611
Accord 2003 - On

UNIT PACKAGE: 15



14690

(Honda: 90683-693-000;
Nissan: 78856-R4301)
White Nylon

Screw Grommet
Screw Size: #10
Width: 12mm
Length: 19mm
Stem Length: 17mm
Fits into 8mm x 15mm Hole

UNIT PACKAGE: 25



19307

(91620-SR2-003)
Natural Nylon

Center Pillar Screw Grommet
Screw Size: #4
Del Sol 1993 - On

UNIT PACKAGE: 10

HOT
NEW ITEMS

Auveco releases new items every other week. Our Hot New Items bulletins can keep you up to date on all new product.

**To receive these bulletins please contact customer service:
mail@auveco.com or 1-800-354-9816**

We also have all previous and current bulletins posted on www.auveco.com.



19646
(90665-SM4-000)
Yellow Nylon

Front Door
Screw Grommet
Screw Size: #6
Head Diameter: 14mm
Stem Length: 10mm
Fits into 7mm x 7mm Hole
Prelude 1997 - On

UNIT PACKAGE: 15



20303
(90664-SB3-003)
Natural Nylon

Trim Panel Screw Grommet
Screw Size: #8 (M4.2)
Head Diameter: 15mm
Stem Length: 15mm
Fits into 8mm x 8mm Hole
Accord 1998 - On

UNIT PACKAGE: 10



14268
(Honda: 90672-671-8110M1;
Toyota: 90189-04013)
White Nylon

Screw Grommet
Screw Size: #6
Head Diameter: 14mm
Stem Length: 15mm
Fits into 7mm x 7mm Hole

UNIT PACKAGE: 25



20954
(90682-SEA-003)
Black Nylon

Fender Apron Screw Grommet
Screw Size: #8 (M4.2)
Head Diameter: 20mm
Stem Length: 12mm
Fits into 9mm Square Hole
Acura TSX and Honda Civic &
Odyssey 2004 - On

UNIT PACKAGE: 25



14281
(Honda: 90662-693-003;
Toyota: 90189-04066)
White Nylon

Screw Grommet
Screw Size: #6
Head Diameter: 14mm
Stem Length: 10mm
Fits into 7mm x 7mm Hole

UNIT PACKAGE: 25



21205
(90682-SDA-A01)
Black Nylon

Rear Bumper Screw Grommet
Screw Size: M4.8 (#10)
Head Size: 14mm x 14mm
Stem Length: 14mm
Civic 2009 - On

UNIT PACKAGE: 15



19741
(90670-SG0-003, 91626-SH3-003)
Natural Nylon

Door Panel Screw Grommet
Screw Size: #8 (M4.2)
Head Diameter: 12mm
Stem Length: 16mm
Fits into 7mm x 7mm Hole
Civic & CR-V 1993 - On

UNIT PACKAGE: 15



19650
(90106-SW3-003)
White Nylon

Bumper Grommet
Head Size: 18mm x 20mm
Stem Length: 19mm
Fits into 8mm x 11mm Hole
Use with Auveco 19470

Accord, Odyssey & Prelude 1995 - On

UNIT PACKAGE: 10



14695
(Honda: 90661-SC7-003;
Mazda: H001-50-841;
Mitsubishi: MS-480012;
Nissan: 01651-00481, 74798-S9000;
Toyota: 90189-06042)
White Nylon

Screw Grommet
Screw Size: #8 (M4.2)
Head Diameter: 16mm
Stem Length: 17mm
Fits into 8mm x 8mm Hole

UNIT PACKAGE: 25



19143
(91623-SM2-003)
Natural Nylon

Door Glass Guide Grommet
Screw Size: #6
Prelude & 2 Door Accord 1990 - On

UNIT PACKAGE: 10



19454

(90651-SL9-013)
Gray Nylon

Rear Bumper Fascia Grommet
Screw Size: #8 (M4.2)
Accord 1996 - 94

UNIT PACKAGE: 15



19734

(90107-SX0-003)
Black Nylon

Bumper Grommet
Screw Size: #10
Acura 2.2CL, 2.3CL, 2.5TL, 3.2TL, & 3.5RL;
Honda Accord & Prelude 1996 - On

UNIT PACKAGE: 15



21521

(90107-S0X-A01)
Black Nylon

Screw Grommet
Screw Size: M4.8 (#10)
Head Size: 16mm x 16mm
Stem Length: 7mm
Acura CL, MDX, RL, 3.2 CL & 3.5RI and Honda
Accord, Pilot, Ridgeline & S2000 1996 - On

UNIT PACKAGE: 25



18415

(71144-SR3-A00)
Natural Nylon

Bumper Grommet
Screw Size: M4.2 (#8)
Civic 1993 - On

UNIT PACKAGE: 25



19533

(90107-S10-003)
Black Nylon

Wheel Well Moulding
Screw Grommet
Screw Size: #10
CR-V 1997 - On

UNIT PACKAGE: 25



21700

(Acura: 91626-SP0-003)
Yellow Nylon

Front Pillar & Door Lining
Screw Grommet with Metal Insert
Screw Size: M5.5 (#12)
Head Size: 16mm x 22mm
Overall Height: 17mm
Acura Integra, Legend & RSX 2006 - 1994

UNIT PACKAGE: 15



20472

(91512-SR3-004)
White Nylon

Tubular Nut with Sealer & Sealed End
Stud Size: 3mm
Head Diameter: 8.5mm
Emblem Nut
Fits into 6mm Hole
Acura Integra, Honda Accord, Civic,
CR-V & Prelude 1994 - On

UNIT PACKAGE: 10



18115

(90676-SR4-003)
Nylon

Reveal Moulding Pin Retainer
Civic 1993 - On

UNIT PACKAGE: 15



14291

(66435-648-000)
Black Nylon

Retaining Clip
Head Diameter: 11mm
Stem Length: 13mm
Panel Thickness: 5mm
Snaps into 5mm Hole

UNIT PACKAGE: 50



14282

(90687-SA5-003)
Black Nylon

Retaining Clip
Head Diameter: 13mm
Stem Length: 15mm
Panel Thickness: 4mm
Snaps into 5mm Hole

UNIT PACKAGE: 50



18157

(90672-671-003)
Gray Nylon

Headliner & Cowl Grille
Retaining Clip
Head Diameter: 13mm
Stem Length: 16mm
Panel Thickness: 5mm
Fits into 5mm Hole
Accord 1986-On

UNIT PACKAGE: 25



20381

(Honda: 90667-671-013ZA;
Mitsubishi: MC440901;
Nissan: 62660-48600-1)
Black Nylon

Trim Panel Retaining Clip
Head Diameter: 16mm
Stem Diameter: 7mm
Stem Length: 16mm
Honda, Mitsubishi & Nissan

UNIT PACKAGE: 25



22263

(Honda: 91504-TBA-A01)
Black Nylon

Grille Retaining Clip
Head Diameter: 16mm
Stem Diameter: 8mm
Stem Length: 11mm
Honda Civic 2016 - On

UNIT PACKAGE: 25



20882

(91501-SEA-003)
Black Nylon

Cowl & Garnish Retainer
Head Diameter: 20mm
Stem Diameter: 7mm
Stem Length: 15mm
Civic 2006 - On

UNIT PACKAGE: 10



22054

(Honda: 91501-SNA-003)
Black Nylon

Front Fender, Cowl & Dash Retainer
Head Diameter: 20mm
Stem Diameter: 7mm
Stem Length: 16mm
Honda Civic & CR-V 2014 - 06

UNIT PACKAGE: 15



21303

(90671-S0D-003ZK)
Black Nylon

Trunk Lid &
Interior Trim Retainer
Head Diameter: 18mm
Stem Diameter: 7mm x 7mm
Stem Length: 13mm
Accord 2010 - On

UNIT PACKAGE: 25



20334

(90667-SOD-003ZC)
Black Nylon

Trunk Garnish Retainer
Head Diameter: 18mm
Stem Diameter: 7.5mm Square
Stem Length: 20mm
Civic 1998 - On

UNIT PACKAGE: 15



16781

(Honda: 90670-692-003;
Toyota: 90467-09065)
Black Nylon

Retaining Clip
Head Diameter: 15mm
Stem Length: 20mm
Panel Thickness: 11mm
Fits into 7mm Hole

UNIT PACKAGE: 25



14289

(90666-SA0-003)
Black Nylon

Retainer
Head Diameter: 13mm
Stem Length: 16mm
Snaps into 5mm Hole

UNIT PACKAGE: 25



19470

(90108-SW3-003)
Black Nylon

Bumper Retainer
Head Diameter: 16mm
Stem Diameter: 4mm
Stem Length: 21mm
Use with Auveco 19650
Accord, Odyssey & Prelude 1995 - On

UNIT PACKAGE: 15



19506

(90666-SA7-003ZW)
Black Nylon

Trunk Lining Retainer
Head Diameter: 16mm
Stem Diameter: 5mm Square
Stem Length: 16mm
Acura 2.5TL, 3.2TL, 3.5, Integra &
Legend, Honda Accord Wagon
& Prelude 1987 - On

UNIT PACKAGE: 15



19744

(90669-SP0-003ZA)
Black Nylon

Trunk Trim Retainer
Head Diameter: 16mm
Stem Diameter: 6mm
Stem Length: 27mm
Civic 1998 - On

UNIT PACKAGE: 10



20609

(91501-S1K-003, 91501-STK-003)
Black Nylon

Hood Insulation Retainer
Head Diameter: 30mm
Stem Diameter: 15mm x 20mm
Stem Length: 14mm
Acura 3.5RL & RSX and
Honda Civic & CR-V 2000 - On

UNIT PACKAGE: 25



16775

(Honda: 90667-SA7-003;
Nissan: 89427-98070)
Black Nylon

Trim Panel Retainer
Head Diameter: 20mm
Stem Length: 15mm
Fits into 5mm Hole

UNIT PACKAGE: 25



21652

(91501-SWA-003)
Black Nylon

Hood Insulation Retainer
Head Diameter: 30mm
Stem Diameter: 21mm
Stem Length: 14mm
Civic 2012 - On

UNIT PACKAGE: 25



16776

(Honda: 90667-SA0-003;
Nissan: 76996-01P02)
Black Nylon

Trim Panel Retainer
Head Diameter: 18mm
Stem Length: 20mm
Fits into 6mm Hole

UNIT PACKAGE: 25



18114

(91520-SM4-C01)
Black Nylon

Hood Insulation Retaining Clip
Head Diameter: 10mm
Stem Length: 10mm
Panel Thickness: 4mm
Fits into 6mm Hole
Honda & Acura 1990 - On

UNIT PACKAGE: 25



15998

(90700-SB2-003)
Black Nylon

Hood Insulation Retainer
Head Diameter: 30mm
Stem Length: 9mm
Fits into 6mm Hole
Honda Prelude 1985-On

UNIT PACKAGE: 15



19682

(91518-S10-003)
Black Nylon

Hood Seal Retaining Clip
Head Diameter: 11mm
Stem Length: 8mm
Fits into 6mm Hole
Odyssey 1999 - On

UNIT PACKAGE: 25



18746

(90700-SJ4-000)
Black Nylon

Hood Insulation Retainer
Head Diameter: 30mm
Stem Diameter: 15mm x 18mm
Stem Length: 10mm
Acura Legend 1991 - On
Honda 1998 - On

UNIT PACKAGE: 15



19114

(91518-SM4-003)
Black Nylon

Hood & Trunk Moulding
Retaining Clip
Head Diameter: 12mm
Stem Length: 9mm
Fits into 6mm Hole
Acura Integra & Honda Civic 1994 - On

UNIT PACKAGE: 10



17205

(91501-SM4-003)
Black Nylon

Cowl Top Retaining Clip
Head Diameter: 14mm
Stem Length: 15mm
Fits into 6mm Hole
Accord 1990 - On

UNIT PACKAGE: 15



14323

(38529-689A-6300)
Black Nylon

Retaining Clip
Head Diameter: 18mm
Stem Length: 15mm
Panel Thickness: 4mm
Snaps into 7mm Hole

UNIT PACKAGE: 25



16779

(Honda: 74842-659-0030;
Toyota: 90467-12078)
Black Nylon

Retaining Clip
Head Diameter: 18mm
Stem Length: 15mm
Panel Thickness: 6mm
Fits into 8mm Hole

UNIT PACKAGE: 25



14319

(90687-671-003)
Black Nylon

Retaining Clip
Head Diameter: 20mm
Stem Length: 20mm
Panel Thickness: 6mm
Snaps into 10mm Hole

UNIT PACKAGE: 25



20611

(90602-S7S-003)
Blue Nylon

Cowl Vent Retainer
Top Head Diameter: 12mm
Bottom Head Diameter: 16mm
Stem Diameter: 3mm
Stem Length: 7mm
Use with Auveco 20612
Accord 2003 - On

UNIT PACKAGE: 25



21696

(Honda: 90602-S2A-003)
Pale Yellow Nylon

Cowl Retainer
Top Head Diameter: 12mm
Bottom Head Diameter: 16mm
Stem Diameter: 4mm
Stem Length: 6.5mm

Honda Civic, Element, Fit, Insight & S2000 2001 - On

UNIT PACKAGE: 25



21107

(90602-SX0-003)
White Nylon

Cowl Vent Retainer
Top Head Diameter: 12mm
Bottom Head Diameter: 16mm
Stem Diameter: 4mm
Stem Length: 13mm
Acura MDX, Honda Civic, Insight,
Odyssey & Prelude 1995 - On

UNIT PACKAGE: 10



21417

(90602-TA0-003)
Blue Nylon

Cowl Vent Retainer
Top Head Size: 10mm x 14mm
Bottom Head Diameter: 16mm
Stem Diameter: 8mm

Acura TSX & ZDX and Honda Accord & Fit 2008 - On

UNIT PACKAGE: 10



22243

(Honda: 91560-S04-003)
White Nylon

Side Panel Moulding Retainer
Top Head Diameter: 13mm
Bottom Head Diameter: 16mm
Stem Diameter: 9.5mm
Stem Length: 12mm
Honda Accord 2015 - 1998
Honda Civic 2011 - 2007

UNIT PACKAGE: 25



19145

(91560-SP0-003)
Gray Nylon

Door Trim Panel Retainer
Top Head Diameter: 13mm
Middle Head Diameter: 17mm
Stem Diameter: 9mm
Stem Length: 12mm
Acura & Honda Accord, Civic,
Prelude, Odyssey & Del Sol 1991 - On

UNIT PACKAGE: 25



20411

(91560-S84-A11)
Black Nylon

Windshield Garnish Pillar Retainer
Top Head Diameter: 13mm
Middle Head Diameter: 16mm
Bottom Head Diameter: 14.5mm
Stem Diameter: 9.5mm
Stem Length: 12mm
Acura 3.2CL, Honda Accord,
Insight & Odyssey 1998 - On

UNIT PACKAGE: 15



21208

(91560-SLJ-J01)
Gray Nylon

Door Trim Panel Retainer
Top Head Diameter: 13mm
Middle Head Diameter: 16mm
Bottom Head Diameter: 18mm
Stem Length: 12mm
Fits into 8.5mm Hole
Acura RDX and Honda Civic,
CR-V & Pilot 2009 - On

UNIT PACKAGE: 10



21554

(91560-S7A-003)
Black Nylon

Trim Panel Retainer with Sealer
Top Head Diameter: 13mm
Middle Head Diameter: 16mm
Bottom Head Diameter: 15mm
Stem Diameter: 9.5mm
Stem Length: 11mm
Crosstour, Fit & Odyssey 2010 - 05

UNIT PACKAGE: 25



21676

(91560-SZW-J01)
Dull Yellow Nylon

Windshield Moulding &
Interior Trim Retainer
Top Head Diameter: 13mm
Middle Head Diameter: 16mm
Bottom Head Diameter: 18mm
Stem Diameter: 9.5mm
Stem Length: 12mm
Civic 2012 - On

UNIT PACKAGE: 25



21149

(91560-S84-A01)
White Nylon

Trim Panel Retainer
Top Head Diameter: 13mm
Middle Head Diameter: 16.5mm
Bottom Head Diameter: 15mm
Stem Diameter: 9.5mm
Stem Length: 11mm
Accord & Element 2003 - On

UNIT PACKAGE: 25



21675

(91560-SZW-003)
Green Nylon

Door Panel &
Interior Trim Retainer
Top Head Diameter: 13mm
Middle Head Diameter: 16mm
Bottom Head Diameter: 18mm
Stem Diameter: 9.5mm
Stem Length: 11mm
Civic 2012 - On

UNIT PACKAGE: 25



21638

(91560-S0X-A01)
White Nylon

Trim Panel Retainer with Sealer
Top Head Diameter: 13mm
Middle Head Diameter: 16.5mm
Bottom Head Diameter: 15mm
Stem Diameter: 9.5mm
Stem Length: 11mm
Accord, CR-V, Fit & Odyssey 1999 - On

UNIT PACKAGE: 15



20959

(91560-S9A-A01)
Blue Nylon

Door Panel Retainer
Top Head Diameter: 13mm
Middle Head Diameter: 16mm
Bottom Head Diameter: 15mm
Stem Diameter: 9.5mm
Stem Length: 13mm
Acura TL & TSX and Honda Accord,
Civic, CR-V & Odyssey 2002 - On

UNIT PACKAGE: 25



21087

(90602-SAA-003)
Orange Nylon

Cowl Vent &
Radiator Support Retainer
Top Head Diameter: 12mm
Middle Head Diameter: 16mm
Bottom Head Diameter: 18mm
Stem Diameter: 9.7mm
Stem Length: 14mm
Fit & CR-V 2003 - On

UNIT PACKAGE: 15



21141

(91561-SJD-003)
Black & White Nylon

Pillar, Rocker Panel &
Floor Retainer
Top Head Diameter: 15mm
Middle Head Diameter: 16mm
Bottom Head Diameter: 18mm
Stem Diameter: 8mm
Stem Length: 13mm
Civic & Pilot 2004 - On

UNIT PACKAGE: 10



21206

(91560-S6A-003)
Orange Nylon

Rear Liftgate Retainer
Top Head Diameter: 13mm
Middle Head Diameter: 16mm
Bottom Head Diameter: 18mm
Stem Length: 14mm
Fits into 8.5mm Hole
Fit 2009 - On

UNIT PACKAGE: 15



21458

(91567-S3M-000)
Black Nylon

Weatherstrip Retainer
Head Diameter: 10mm
Stem Diameter: 5.5mm
Stem Length: 7mm
Accord, Civic &
Odyssey 2003 - On

UNIT PACKAGE: 25



20610

(Honda: 91560-SM4-003)
White Nylon

Door Trim Panel Retainer
Top Head Diameter: 13mm
Middle Head Diameter: 18mm
Bottom Head Diameter: 16mm
Stem Diameter: 9mm
Stem Length: 15mm
Accord 1990 - On

UNIT PACKAGE: 25



14299

(73862-672-003)
White Nylon

Weatherstrip Retainer
Width: 7mm
Length: 16mm
Stem Length: 5mm
Fits into 5mm Hole

UNIT PACKAGE: 50



18294

(91566-SP0-003)
White Nylon

Trim Panel Retainer
Top Head Diameter: 13mm
Middle Head Diameter: 18mm
Stem Length: 14mm
Fits into 9mm Hole
Honda 1990-On

UNIT PACKAGE: 15



14328

(90664-671-003, 91530-SE0-003)
White Nylon

Weatherstrip Retainer
Width: 7mm
Length: 16mm
Stem Length: 10mm
Fits into 5mm Hole

UNIT PACKAGE: 50



21059

(90602-S5A-003)
Blue Nylon

Cowl Vent Retainer
Top Head: 12mm x 13mm
Middle Head Diameter: 16mm
Bottom Head Diameter: 18mm
Stem Diameter: 8.5mm x 8.5mm
Stem Length: 14mm

Acura RSX and Honda Civic & CR-V 2001 - On

UNIT PACKAGE: 15



19673

(72311-S10-003)
Black Nylon

Weatherstrip Retainer
Head Size: 10mm x 15mm
Stem Diameter: 5mm
Stem Length: 10mm
CR-V 1997 - On

UNIT PACKAGE: 15



18818

(91513-SE0-003)
Natural Nylon

Hood Seal Retainer
Head Size: 7mm x 16mm
Stem Length: 12mm
Fits into 5mm Hole
Accord & Prelude 1983 - On

UNIT PACKAGE: 25



21704

(Honda: 72311-S5S-003)
Green Nylon

Weatherstrip Retaining Clip
Top Head Size: 5mm x 15mm
Bottom Head Diameter: 9.5mm
Stem Diameter: 7mm
Stem Length: 11mm
Acura RDX and Honda Civic,
CR-V & Fit 2003 - On

UNIT PACKAGE: 25



21773

(Honda: 91530-S0A-003)
Black Nylon

Roof Rail & Side Sill Weatherstrip Retainer
Top Head Size: 5mm x 11mm
Bottom Head Diameter: 8mm
Stem Diameter: 6mm
Stem Length: 7mm
Acura Legend, MDX, RDX,
RL, TL & ZDX 1998 - On
Honda Accord, Civic, CRV,
Element & Odyssey 2001 - On

UNIT PACKAGE: 25



18877

(91530-SP1-003)
Red Nylon

Weatherstrip Retainer
Head Size: 5mm x 15mm
Stem Length: 10mm
Fits into 6mm Hole
Acura 3.5 RL & Honda Accord,
Civic & Odyssey 1992 - On

UNIT PACKAGE: 25



21705

(Honda: 90651-TP8-003,
91568-TR0-003)
Yellow Nylon

Weatherstrip Retainer
Top Head Size: 5mm x 15mm
Bottom Head Diameter: 7.5mm
Stem Diameter: 6.5mm
Stem Length: 7mm
Acura ILX & RDX and Honda Civic & CR-V 2012 - On

UNIT PACKAGE: 25



19116

(91530-ST5-003)
Natural Nylon

Weatherstrip Retainer
Head Size: 5mm x 15mm
Stem Length: 10mm
Fits into 6mm Hole
Front & Rear Doors
Civic 1995 - On

UNIT PACKAGE: 10



21707

(Honda: 91563-SCV-003)
(Toyota: 67867-52010, 67867-0D060)
White Nylon

Weatherstrip Retainer
Head Size: 5mm x 15mm
Bottom Head Diameter: 6.5mm
Stem Diameter: 7mm
Stem Length: 8.5mm
Acura TL and Honda Element
Odyssey & Pilot 2003 - On
Toyota Echo, Land Cruiser, Prius, Tacoma
& Yaris and Lexus GS 450, GX 460 &
LX 430 and Scion xA & xD 2000 - On

UNIT PACKAGE: 25



19171

(91568-SR2-003)
Green Nylon

Weatherstrip Retainer
Head Size: 5mm x 15mm
Stem Length: 10mm
Fits into 5mm Hole
Odyssey 1995 - On

UNIT PACKAGE: 100



19683

(91502-S84-A11)
Black Nylon

Cowl Vent Retaining Clip
Head Diameter: 6mm x 16mm
Stem Length: 14mm
Fits into 6mm Hole
Odyssey 1999 - On

UNIT PACKAGE: 15



19483

(91515-SR3-000)
Black Nylon

Rear Hood Cowl
Weatherstrip Retaining Clip
Head Size: 8mm x 18mm
Stem Length: 15mm
Fits into 7mm Hole
Acura Integra, Honda Civic,
CR-V & Del Sol 1992 - On

UNIT PACKAGE: 25



22136

(Honda: 75315-S9A-004)
White Nylon

Lower Outer Door Weatherstrip Clip
Top Head Size: 12mm x 15mm
Bottom Head Size: 14mm x 20mm
Stem Length: 10mm
Honda CR-V 2002 - On

UNIT PACKAGE: 15

"428" DISPLAY BOARDS

428 of the most popular body hardware and fastener items are shrink-wrapped onto seven different boards. Each board contains product groups, body shops are familiar with and use often.

The back of each board contains each part number, unit package quantity, OEM number and size specification. The backs are protected by a clear plastic liner.

Learn more about the display boards at the front of the catalog, online at www.auveco.com or contact customer service at 1-800-354-9816 or mail@auveco.com



19186

(90657-SB0-003)
Black Nylon

Front Bumper Cover
Push-Type Retainer
Head Diameter: 11mm
Stem Length: 10mm
Fits into 8mm Hole
Acura Legend, Honda Accord
& Odyssey 1991 - On

UNIT PACKAGE: 10



22199

(Honda: 90657-SA5-003)
Black Nylon

Bumper & Splash Shield
Push-Type Retainer
Head Diameter: 15mm
Stem Length: 12mm
Fits into 6.3mm Hole
Acura TL 2008 - 04
Honda Accord, CR-V, Insight & Pilot 2007 - 1997

UNIT PACKAGE: 15



19547

(91508-S50-003)
Black Nylon

Cowl Top Retainer
Head Diameter: 17mm
Stem Length: 13mm (Excluding the Pin)
Fits into 9mm Hole
Accord & Odyssey 1998 - On

UNIT PACKAGE: 5



18165

(91508-SR3-000)
Black Nylon

Cowl Panel
Push-Type Retainer
Head Diameter: 17mm
Stem Length: 9mm
Fits into 8mm Hole
Honda 1990 - On

UNIT PACKAGE: 10



20247

(Mitsubishi: MR200300)
Black Nylon

Fender & Bumper
Push-Type Retainer
Head Diameter: 18mm
Stem Length: 12mm
Fits into 9mm Hole
Honda & Mitsubishi 1998 - On

UNIT PACKAGE: 15



17192

(91508-SM4-003)
Black Nylon

Cowl Panel Push-Type Retainer
Head Diameter: 18mm
Stem Length: 14mm
Fits into 8mm Hole
Accord 1990-On

UNIT PACKAGE: 10



19453
(90505-SX0-003)
Black Nylon

Garnish Side Protector
Push-Type Retainer
Head Diameter: 18mm
Stem Length: 15mm
(Excluding the Pin)
Fits into 8mm Hole
Odyssey 1995 - On

UNIT PACKAGE: 15



19118
(91501-S04-003)
Black Nylon

Front Fender
Push-Type Retainer
Head Diameter: 20mm
Stem Length: 10mm
Fits into 8mm Hole
Civic & Del Sol 1993-On

UNIT PACKAGE: 15



21651
(91501-TR0-003)
Black Nylon

Fender Push-Type Retainer
Head Diameter: 20mm
Stem Length: 10mm
Fits into 8mm Hole
Civic 2012 - On

UNIT PACKAGE: 25



21297
(91503-S7A-003)
Black Nylon

Front Bumper Push-Type Retainer
Head Diameter: 20mm
Stem Length: 11mm
Fits into 10mm Hole
Civic 2010 - On

UNIT PACKAGE: 15



19233
(Honda: 91503-SZ3-003)
Black Nylon

Front Bumper
Push-Type Retainer
Head Diameter: 20mm
Stem Length: 13mm
Fits into 10mm Hole
Acura 3.5 RL Sedan &
Honda 1996 - On

UNIT PACKAGE: 15



20986
(91505-S9A-003)
Black Nylon

Front Bumper Push-Type Retainer
with Internal Metal Insert
Head Diameter: 20mm
Stem Length: 13mm
Fits into 10mm Hole
Civic 2006 - On

UNIT PACKAGE: 10



19239
(Honda: 91512-SX0-003;
GM: 11519949
Mitsubishi: MU000319)
Black Nylon

Front Fender & Bumper Support Push-Type Retainer
Head Diameter: 20mm
Stem Length: 11mm
Fits into 8mm Hole
Acura, GM, Mitsubishi and Honda Accord,
Prelude & Odyssey 1994 - On

UNIT PACKAGE: 25



20608
(91503-S0K-A01)
Black Nylon

Grille Mounting Push-Type Retainer
Head Diameter: 20mm
Stem Length: 14mm
Fits into 10mm Hole
Element 2003 - On

UNIT PACKAGE: 15



21706
(Honda: 91505-TM8-003)
Black Nylon

Bumper and Wheel Well Liner
Push-Type Retainer
Head Diameter: 20mm
Stem Length: 14mm
Fits into 10mm Hole
Acura ILX and Honda Insight 2012 - On

UNIT PACKAGE: 15



21173
(91506-S9A-003)
Black Nylon

Bumper & Splash Shield
Push-Type Retainer with Metal Insert
Head Diameter: 20mm
Stem Length: 16mm
Fits into 10mm Hole
Acura and Honda Accord, Civic,
CR-V & Fit 2009-04

UNIT PACKAGE: 10



20564

(91503-SZ5-003)
Black Nylon

Front & Rear Bumper Push-Type Retainer
Head Diameter: 20mm
Stem Length: 18mm
Fits into 10mm Hole
Acura 3.5RL and Honda Accord & Odyssey 1996 - On

UNIT PACKAGE: 15



22112

(Honda: 91512-STK-A01)
Black Nylon

Garnish & Rear Spoiler Push-Type Retainer with Sealer
Head Diameter: 20mm
Stem Length: 13mm
Fits into 8.5mm Hole
Acura RDX & TSX and Honda Accord, CR-V & Odyssey 2011 - On

UNIT PACKAGE: 10



22068

(Honda: 91513-SJK-003)
White Nylon

Rocker, Pillars, Spoiler, Garnish & Exterior Trim Push-Type Retainer with Sealer
Head Diameter: 20mm
Stem Length: 13mm
Fits into 8.5mm Hole
Acura MDX, RLX, TSX & ZDX and Honda Accord, Civic, CR-V, Element, Fit, Insight & Pilot 2007 - On

UNIT PACKAGE: 15



22069

(Honda: 91512-SJK-003)
White Nylon

Rocker, Pillars, Garnish & Exterior Trim Push-Type Retainer with Sealer
Head Diameter: 20mm
Stem Length: 13mm
Fits into 8.5mm Hole
Acura ZDX 2013 - 2010
Honda Odyssey & Pilot 2005 - On

UNIT PACKAGE: 15



21190

(91550-S50-000ZL)
Black Nylon

Interior Trim Push-Type Retainer
Head Diameter: 16mm
Stem Length: 14mm
Fits into 7mm Hole
Civic, CR-V, Element & Insight 2006 - 2000

UNIT PACKAGE: 15



21477

(91550-S50-000ZK)
Gray Nylon

Push-Type Retainer
Head Diameter: 16mm
Stem Length: 14mm
Fits into 7mm Hole
Civic, CR-V, Element & Insight 2006 - 2000

UNIT PACKAGE: 15



20910

(91505-ST7-003ZA)
Black Nylon

Door Panel Push-Type Retainer
Head Diameter: 17mm
Stem Length: 12mm
Fits into 8mm Hole
CR-V and S2000 2000 - On

UNIT PACKAGE: 10



19416

(Toyota: 90467-09139)
Black Nylon

Bumper Cover & Wheel Housing Push-Type Retainer
Head Diameter: 18mm
Stem Length: 15mm
Fits into 9mm Hole
Honda, Mazda 626 & Toyota Corolla 1992 - On

UNIT PACKAGE: 15



16782

(Honda: 91545-SE0-003-W1;
Nissan: 63848-01G00)
Black Nylon

Push-Type Retainer
Head Diameter: 20mm
Stem Length: 8mm (Excluding Pin)
Fits into 8mm Hole

UNIT PACKAGE: 25



21454

(91503-SHJ-A01)
Black Nylon

Front Bumper Push-Type Retainer
Head Diameter: 20mm
Stem Length: 13mm
Fits into 10mm Hole
Odyssey 2005 - On

UNIT PACKAGE: 10



17287
(90687-SB0-003, 90687-SB0-013)
Black Nylon

Cowl Vent Panel Retainer
Head Diameter: 13mm
Stem Length: 11mm
Fits into 6mm Hole
Prelude 1983 - On

UNIT PACKAGE: 25



14697
(GM: 94198687;
Honda: 90657-SA6-0030;
Mazda: N304-13-356-A)
Black Nylon



Push-Type Retainer
Head Diameter: 14mm
Stem Length: 11mm
Fits into 7mm Hole

UNIT PACKAGE: 25



14696
(Honda: 90684-SA5-003;
Isuzu: 8942981190;
Nissan: 10998-30880)
Black Nylon



Push-Type Retainer
Head Diameter: 15mm
Stem Length: 11mm
Fits into 6mm Hole

UNIT PACKAGE: 25



19311
(90683-SA5-003)
Black Nylon



Front Fender Skirt
Push-Type Retainer
Head Diameter: 15mm
Stem Length: 13mm
Fits into 6mm Hole
Prelude 1996 - 92

UNIT PACKAGE: 15



19142
(91550-SH3-003)
Black Nylon

Pillar Garnish, Side and
Trunk Lining Push-Type Retainer
Head Diameter: 15mm
Stem Length: 13mm
Fits into 7mm Square Hole
Civic, Accord Wagon & Del Sol 1993-On



UNIT PACKAGE: 5



20352
(Honda: 91561-S84-A00-M1,
91561-S84-A21ZB)
Black Nylon

Rear Panel Assembly Push-Type Retainer
Head Diameter: 16mm
Stem Length: 21mm
Fits into 8mm Hole
Honda Accord & Civic 2007 - 01
Fit 2014 - 09

UNIT PACKAGE: 10



19546
(91570-SK7-003ZF)
Black Nylon

Tailgate Lining Retainer
Head Diameter: 17mm
Stem Length: 16mm
Fits into 7mm Square Hole
Prelude 1997 - On

UNIT PACKAGE: 10



17081
(91524-SE0-003)
Black Nylon



Cowl Push-Type Retainer
Head Diameter: 18mm
Stem Length: 12mm
Fits into 6mm Hole
Accord 1986-On

UNIT PACKAGE: 25



14698
(90688-SB0-003)
Black Nylon



Push-Type Retainer
Head Diameter: 18mm
Stem Length: 11mm
Fits into 6mm Hole

UNIT PACKAGE: 25



17057
(90505-SM4-003)
Black Nylon

Push-Type Retainer
Head Diameter: 18mm
Stem Length: 21mm
Fits into 8mm Hole
Accord 1990 - On

UNIT PACKAGE: 10



16000

(Honda: 90675-SB3-003;
Mazda: FB01-56-964;
Nissan: 63876-95596)
Black Nylon

Push-Type Retainer
Head Diameter: 20mm
Stem Length: 9mm
Fits into 8mm Hole

UNIT PACKAGE: 25



18119

(91502-SP0-003)
Black Nylon

Front & Rear Bumper
Push-Type Retainer
Head Diameter: 20mm
Stem Length: 25mm
Fits into 10mm Hole
Honda 1990 - On

UNIT PACKAGE: 10



17379

(91512-SM4-003)
Black Nylon

Fender Splash Shield
Push-Type Retainer
Head Diameter: 20mm
Stem Length: 9mm
Fits into 8mm Hole
Accord 1990-On

UNIT PACKAGE: 10



17350

(Honda 91516-SK7-013;
Nissan 01553-00344)
Black Nylon

Splash Shield Push-Type Retainer
Phillips Drive
Hex: 10mm
Head Diameter: 20mm
Stem Length: 15mm
Fits into 8mm Hole

Civic 1992 - On

Nissan XTerra, Frontier, & Quest 1999 - On

UNIT PACKAGE: 10



17143

(Honda: 91502-SM4-000;
Hyundai: 85690-35000)
Black Nylon

Push-Type Retainer
Head Diameter: 20mm
Stem Length: 27mm
Fits into 10mm Hole
Bumper Fascia
Accord 1990-On
Hyundai 2005 - On

UNIT PACKAGE: 10

19407

Same as 17143 except for unit package quantity

UNIT PACKAGE: 50



17144

(91504-SM4-000)
Black Nylon

Push-Type Retainer
Head Diameter: 20mm
Stem Length: 24mm
Fits into 10mm Hole
Bumper Fascia
Accord 1990 - On

UNIT PACKAGE: 10



19408

Same as 17144 except for unit package quantity

UNIT PACKAGE: 50



20432

(91504-SR3-003)
Nylon

Windshield Washer
Hose Clip
Width: 15mm
Length: 66mm
Holds 6.3mm (1/4") Hose
Accord, Civic, CR-V & Del Sol 1993 - On

UNIT PACKAGE: 10



18512

(91512-SE0-003)
Gray Nylon

Windshield Washer Hose Clip
Width: 11mm
Length: 42mm
Holds 6.3mm (1/4") Hose
Accord 1986 - On

UNIT PACKAGE: 15



16949

(90652-SB2-023)
Nylon

Windshield Washer Hose Retainer
Holds hose with:
3mm (7/64") Inner Diameter &
5mm (13/64") Outer Diameter
Fits into 7mm (9/32") Square Hole
Honda 1986 - On

UNIT PACKAGE: 15



18454

(91604-SD2-013)
Nylon

Hood Prop Rod Grommet
Civic 1989-On

UNIT PACKAGE: 5



14688

(91547-SE0-003)
Nylon

Hood Prop Rod Clip
Holds 6mm Prop Rod
Snaps into 7mm Hole

UNIT PACKAGE: 25



14687

(90677-671-003)
Nylon

Hood Prop Rod Clip
Holds 8mm Prop Rod
Snaps into 9mm x 9mm Hole

UNIT PACKAGE: 25



16950

(90677-SE0-003)
Nylon

Hood Prop Rod Clip
Holds 8mm Prop Rod
Accord 1986 - On

UNIT PACKAGE: 5



19730

(90654-SA4-003)
Natural Nylon

Wire Routing Clip
Holds 6mm Diameter Wire
Fits into 7mm Hole
Civic 1998 - On

UNIT PACKAGE: 15



21170

(91591-SJ6-013)
Natural Nylon

Door Lock Rod Clip
Rod Size: 5mm
Overall Height: 17mm
Fits into 7mm Hole
Acura TSX and Honda Accord,
Odyssey & Ridgeline 2003 - On

UNIT PACKAGE: 15



21388

(91558-SE3-003)
Black Nylon

Sliding Door Lock and
Hood & Fuel Door Release Cable Clip
Maximum Cable Diameter: 5mm
Closed Height Position: 17mm
Acura and Honda Accord, Civic,
CR-V, Insight, Odyssey, Pilot, Prelude
& Ridgeline 1991 - On

UNIT PACKAGE: 25

14284

(Honda: 90669-671-000, 90669-671-003;
Toyota: 90463-10337)
Nylon

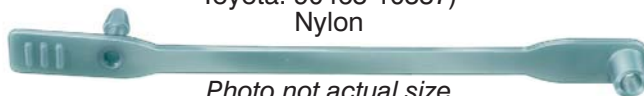

Photo not actual size
Cable Strap

Length: 110mm (5-5/16")
Max. Bundle Diameter.: 23mm
Fits into 6mm Hole

UNIT PACKAGE: 15

14298

(Honda: 90672-SA0-003; Mazda: 9928-91-053)
Nylon

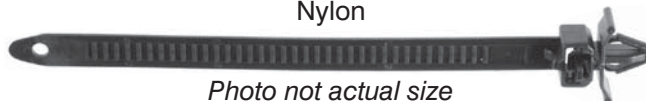

Photo not actual size
Releasable Cable Strap

Overall Length: 140mm (5-1/2")
Max. Bundle Diameter: 30mm
Fits into 7mm Hole

UNIT PACKAGE: 25

20380

(Not Supplied by O.E.M.)
Black Nylon



Photo not actual size
Cable Strap

Width: 5mm (3/16")
Length: 200mm (8")
Max. Bundle Diameter: 44mm (1-3/4")
Fits into 6.3mm (1/4") Hole
Import Cars

UNIT PACKAGE: 25



17289
(60658-SB3-000)
Nylon

Cowl Screen Screw Cover
Head Diameter: 17mm
Fits into 12mm Hole
Civic 1984 - On

UNIT PACKAGE: 25



16470
(90212-SA5-003)
Zinc

M10-1.25
Hex Flange Nut with Serrations
Flange Outer Diameter: 20mm
Hex: 14mm
Class 10
Used on Honda Exhaust Systems

UNIT PACKAGE: 25



20570
(Honda: 75307-SN7-000;
Mini-Cooper: 07-13-0-702-715)
Black Nylon

Nylon Moulding Nut with Brass Insert
Thread: M4-0.7
Flange Outer Diameter: 12mm
Hex: 10mm
Height: 11mm
1994 - On

UNIT PACKAGE: 15



13225
Plated

U-Type Nut
Screw Size: 4.2mm (#8)
Width: 11mm
Length: 16.5mm
Panel Range: .5mm-2.5mm
Center of Hole to Edge: 8mm

UNIT PACKAGE: 50

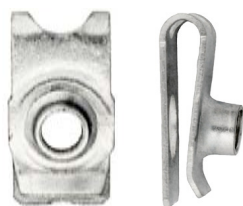

22105
(Honda: 90675-SA5-003)
Zinc

Metric Extruded U-Nut
Screw Size: M6-1.0
Panel Range: 2mm - 4mm
Center of Hole to Edge:
14.5mm (9/16")
Acura 2007 - 1998
Honda 2014 - 1983

UNIT PACKAGE: 25

TIPS FOR NAVIGATING THE CATALOG

• Color Coded Pages

Yellow- New Items

Blue- Metric Items

Brown- Electric Accessories

Green- Assortments, Cabinets,
Bins and Racks

Gray- Key Blanks & Accessories

Pink- Import Car Body Hardware

• Specification Charts

Body Bolts- Pages: 88 & 121-122

Special Tapping Screws- Pages: 91-94 & 128-130

License Plate Screws- Pages: 105-106

Retainers- Pages: 475-489

Push-Type Retainers- Pages: 534-545

• Indexes. Located in the front

Pictorial

Alphabetical

Numerical

• Images are actual size unless noted otherwise

• OEM Part Cross Reference: Indexed
according to OEM number and Part Number.
Located in the back

Located in the front after the numerical index

• Screw Identification charts: head styles,
driving recesses, point styles and sizing.

• List of common terminology with brief
descriptions

• Plating and finish types with brief descriptions



22316

(Hyundai: 85858-3S000)
Black Nylon

Interior Trim Clip
Overall Height: 16mm
Width at Bottom: 11mm
Hyundai Azera & Sonata and
Kia Optima & Soul 2011 - On

UNIT PACKAGE: 50



22317

(Hyundai: 85859-3S100)
Black Nylon

Interior Trim Clip
Overall Height: 19mm
Width at Bottom: 15mm
Hyundai Accent, Azera, Elantra & Sonata
and Kia Optima & Rio 2011 - On

UNIT PACKAGE: 50



22007

(Hyundai: 84747-2L000)
White Nylon

Trim Panel &
Dash Console Clip
Overall Length: 21mm
Hyundai Elantra, Entourage,
Sonata & Veloster 2006 - On
Kia Forte, Sorento & Soul 2010 - On

UNIT PACKAGE: 50



21038

(87719-3D000)
Natural Nylon

Body Side Moulding Clip
Head Size: 6mm x 14mm
Base Diameter: 14mm
Overall Height: 6mm
Elantra & Sonata 2004 - On

UNIT PACKAGE: 15



20567

(87756-38000)
Black Nylon

Body Side Moulding
Clip with Sealer
Top Head Size: 8mm x 9mm
Bottom Head Size: 14mm x 18mm
Stem Length: 10mm
Elantra & Sonata 2002 - On
Kia Rio 2010 - On

UNIT PACKAGE: 15



21312

(87756-2G000)
Black Nylon

Body Side Moulding Clip with Sealer
Head Size: 8mm x 22mm
Stem Length: 10mm
Hyundai Sonata and
Kia Magentis & Optima 2006 - On

UNIT PACKAGE: 15



21064

(87758-35000)
Yellow Nylon

Rocker Moulding Clip with Sealer
Top Head Size: 10mm x 11mm
Bottom Head Size: 14mm x 19mm
Stem Length: 10mm
Accent, Santa Fe & Tiburon 1995 - On

UNIT PACKAGE: 15



22329

(Hyundai: 87758-38000)
White Nylon

Rocker Moulding Clip with Sealer
Top Head Size: 10mm x 13mm
Bottom Head Size: 7mm x 16mm
Stem Length: 9mm
Hyundai Sonata 2001 - 1999
Kia Optima & Sorento 2009 - 2001

UNIT PACKAGE: 50



21863

(Hyundai: 87758-35010)
White Nylon

Moulding Clip with Sealer
Top Head Size: 10mm x 12mm
Bottom Head Size: 14mm x 18mm
Stem Length: 10mm
Hyundai Accent, Kia Soul &
Mitsubishi Outlander 2006 - On

UNIT PACKAGE: 15



22010

(Hyundai: 86360-3L000)
White Nylon

Front Hood Moulding Clip with Sealer
Top Head Size: 10mm x 12mm
Bottom Head Size: 13mm x 15mm
Stem Length: 11mm
Hyundai Azera, Equus & Sonata 2006 - On

UNIT PACKAGE: 25



22015
 (Hyundai: 87756-1F000)
 Blue Nylon
 Fender Flare, Rocker, Door & Exterior
 Moulding Clip with Sealer
 Top Head Size: 10mm x 12mm
 Bottom Head Size: 14mm x 20mm
 Stem Diameter: 14mm
 Stem Length: 10mm
 Hyundai Santa Fe 2013 - On
 Kia Sportage 2011 - On

UNIT PACKAGE: 25



21244
 (87702-H1000)
 White Nylon
 Rocker Moulding Clip with Sealer
 Top Head Size: 11mm x 15.5mm
 Bottom Head Diameter: 16mm
 Stem Length: 12mm
 Hyundai Genesis & Sonata
 and Kia Sorento 2009 - On

UNIT PACKAGE: 15



22020
 (Hyundai: 87770-27000)
 White Nylon
 Rocker Moulding Clip with Sealer
 Top Head Size: 12mm x 15mm
 Bottom Head Size: 14mm x 36mm
 Stem Diameter: 14mm
 Stem Length: 10mm
 Hyundai Tiburon 2001 - 1997

UNIT PACKAGE: 25



22013
 (Hyundai: 87703-H1000)
 Yellow Nylon
 Hood Moulding Clip with Sealer
 Top Head Size: 12mm x 16mm
 Bottom Head Diameter: 16mm
 Stem Diameter: 9.5mm
 Stem Length: 10mm
 Hyundai Elantra 2006 - 01

UNIT PACKAGE: 25



22019
 (Hyundai: 87758-39000)
 White Nylon
 Rocker Moulding Clip with Sealer
 Top Head Size: 16mm x 20mm
 Bottom Head Size: 14mm x 18mm
 Stem Diameter: 13mm
 Stem Length: 10mm
 Hyundai Azera, Tiburon & XG300/350
 2011 - 01

UNIT PACKAGE: 25



22018
 (Hyundai: 87756-37000)
 White Nylon
 Rocker Moulding Clip with Sealer
 Top Head Size: 16mm x 20mm
 Bottom Head Diameter: 15mm
 Stem Length: 10mm
 Fits into 9mm Hole
 Hyundai Sonata 2005 - 02

UNIT PACKAGE: 25



20568
 (87758-3D000)
 Yellow Nylon
 Rocker Panel Clip with Sealer
 Top Head Size: 16mm x 20mm
 Bottom Head Size: 14mm x 18mm
 Stem Length: 10mm
 Elantra & Sonata 2002 - On

UNIT PACKAGE: 15



21136
 (87756-2E000)
 White Nylon
 Moulding Clip with Sealer
 Top Head Size: 10mm x 12mm
 Bottom Head Size: 14mm x 20mm
 Stem Length: 10mm
 Hyundai Entourage, Tucson & Veracruz and Kia
 Optima, Sedona, Spectra & Sportage 2005 - On

UNIT PACKAGE: 15



22314
 (Hyundai: 85815-24100)
 Gray Nylon
 Rocker Panel Moulding Clip
 Top Head Size: 12mm x 14mm
 Bottom Head Diameter: 17mm
 Stem Length: 12mm
 Fits into 8mm Hole
 Hyundai Scoupe 1995 - 1991

UNIT PACKAGE: 25



21321
 (87758-3L000)
 Blue Nylon
 Moulding Clip with Sealer
 Top Head Size: 16mm x 18mm
 Bottom Head Size: 18mm x 20mm
 Stem Length: 15mm
 Hyundai Azera & Genesis 2009 - On

UNIT PACKAGE: 15



22135

(Hyundai: 83219-22000)
White Nylon

Belt Moulding
Weatherstrip Clip
Width: 18.3mm
Length: 29mm
Hyundai Accent 2005 - 1995

UNIT PACKAGE: 25



21069

(92351-37000)
Natural Nylon

Headlight Assembly Grommet
Head Diameter: 15mm
Stem Length: 8mm
Fits into 10mm Hole
XG300/350 2001 - On
Kia 2000 - On

UNIT PACKAGE: 25



22322

(Hyundai: 86518-3M000)
White Nylon

Bumper Grommet
Screw Size: M3.5 (#6)
Head Size: 8mm x 10mm
Stem Length: 12mm
Hyundai Azera & Sonata 2012 - On
Kia Cadenza 2014 - On

UNIT PACKAGE: 25



20566

(87756-3D000)
White Nylon

Body Side Nylon Nut
with Sealer
Screw Size: M4.2 (#8)
Head Size: 14mm x 14mm
Stem Length: 10mm
Elantra & Sonata 2002 - On

UNIT PACKAGE: 15



22323

(Kia: 86625-1M000)
White Nylon

Bumper Grommet
Screw Size: M4.8 (#10)
Head Size: 8mm x 10mm
Stem Length: 12mm
Kia Optima 2011 - On

UNIT PACKAGE: 25



21356

(Hyundai: 87714-FD200;
Kia: 87756-1C000)
White Nylon

Body Side Moulding Nylon Nut
Screw Size: M4.2 (#8)
Head Size: 13mm x 13mm
Stem Length: 10mm
Hyundai Veracruz and
Kia Rio 2009 - On

UNIT PACKAGE: 15



21150

(14913-05010)
White Nylon

Front & Rear Bumper and Fender Nylon Nut
Screw Size: M4.8 (#10)
Head Size: 12mm x 12mm
Stem Length: 11mm
Hyundai Elantra, Sonata, XG300 & XG350 and Kia
Magentis & Optima 1992 - On

UNIT PACKAGE: 25



22324

(Hyundai: 87701-3B000)
Natural Nylon

Body Side Moulding Nut
Top Size: 16mm x 20mm
Bottom Size: 16mm x 16mm
Screw Size: M3.5 (#6)
Hyundai Tucson 2009 - 2004

UNIT PACKAGE: 50



22300

(Hyundai: 14910-05000)
Natural Nylon

Door Handle Nylon Nut
Screw Size: M4.2 (#8)
Head Size: 12mm x 12mm
Stem Length: 9mm
Overall Height: 10mm
Hyundai Accent, Azera, Elantra, Equus,
Genesis, Santa Fe, Sonata,
Tucson & Veloster 2014 - On

UNIT PACKAGE: 25



21068

(86848-22000)
Black Nylon

Fender Apron Nylon Nut
Screw Size: M4.8 (#10)
Head Diameter: 16mm
Stem Length: 11mm
Fits into 8.5mm Square Hole
Accent, Elantra, Sonata
& Tiburon 1995 - On

UNIT PACKAGE: 25



22017

(Hyundai: 87756-34520)
Green Nylon

Fender & Door Moulding Nylon Nut
Screw Size: M3.5 (#6)
Head Size: 13mm x 13mm
Stem Diameter: 13.5mm
Stem Length: 8mm
Hyundai Tucson 2009 - 05
Kia Optima 2006 - 01

UNIT PACKAGE: 50



22016

(Hyundai: 87756-26900)
White Nylon

Emblem & Rocker Moulding
Nylon Nut with Sealer
Screw Size: M3.5 (#6)
Head Size: 13mm x 13mm
Stem Diameter: 12mm
Stem Length: 10mm
Hyundai Genesis & Santa Fe 2007 - On

UNIT PACKAGE: 50



21066

(87758-37000)
White Nylon

Fender & Rocker Moulding
Nylon Nut with Sealer
Screw Size: M4.2 (#8)
Head Size: 17mm x 17mm
Stem Length: 14mm
Hyundai Accent & Sonata 1999 - On
Kia 2001 - On

UNIT PACKAGE: 25



22297

(Hyundai: 87759-3S000)
Gray Nylon

Rocker & Exterior Trim Moulding
Grommet with Sealer
Screw Size: M4.2 (#8)
Head Size: 16.5mm x 16.5mm
Stem Diameter: 12.5mm
Stem Length: 12mm
Overall Height: 15mm
Hyundai Azera & Sonata 2011 - On

UNIT PACKAGE: 10



21292

(87759-27000)
Yellow Nylon

Rocker Moulding Grommet with Sealer
Screw Size: M4.2 (#8)
Head Size: 17mm x 25mm
Stem Length: 16mm
Accent, Genesis, Santa Fe, Sonata,
Tiburon & Veracruz 1995 - On

UNIT PACKAGE: 15



21232

(86910-21010)
Natural Nylon

Bumper Screw Grommet with Sealer
Screw Size: M4.8 (#10)
Head Diameter: 18mm
Stem Length: 21mm
Azera 2009 - On

UNIT PACKAGE: 15



22011

(Hyundai: 86625-3S000)
White Nylon

Bumper Cover Screw
Grommet with Sealer
Screw Size: M4.8 (#10)
Top Head Size: 14mm x 18mm
Bottom Head Diameter: 18mm
Stem Length: 18mm
Hyundai Santa Fe 2013 - On

UNIT PACKAGE: 25



22321

(Hyundai: 86438-2T000)
Black Nylon

Hood & Bumper Seal Retainer
Head Size: 4.5mm x 13mm
Stem Diameter: 7.6mm
Stem Length: 7.5mm
Hyundai Elantra & Genesis 2013 - On
Kia K900 & Optima 2011 - On

UNIT PACKAGE: 50



21381

(86438-4A100)
Black Nylon

Hood Seal Retainer
Head Size: 5mm x 13mm
Stem Diameter: 8mm
Stem Length: 11mm
Hyundai Elantra & Tucson and
Kia Forte & Sportage 2009 - On

UNIT PACKAGE: 50



21382

(86434-4A000)
Black Nylon

Hood Seal Retainer
Head Size: 6mm x 16mm
Stem Diameter: 8mm
Stem Length: 14mm
Hyundai Elantra, Sonata &
Tucson and Kia Sportage 2009 - On

UNIT PACKAGE: 50



22320

(Hyundai: 86438-1R000)
Black Nylon

Hood Seal Retainer
Head Size: 5mm x 13mm
Stem Diameter: 8mm
Stem Length: 10mm
Hyundai Accent 2011 - On

UNIT PACKAGE: 50



22325

(Hyundai: 87756-2W000)
Red Nylon

Weatherstrip Retainer
Head Size: 5mm x 15mm
Stem Diameter: 7mm
Stem Length: 8mm
Hyundai Santa Fe & Kia Sorento 2013 - On

UNIT PACKAGE: 100



22337

(Hyundai: 82132-27100)
White Nylon

Door Weatherstrip Retainer
Top Head Size: 5mm x 15mm
Bottom Head Diameter: 9.3mm
Stem Diameter: 7mm
Stem Length: 11mm
Hyundai Azera, Santa Fe & Sonata 2001 - On

UNIT PACKAGE: 25



20543

(81126-37010)
Black Nylon

Hood Insulation Retainer
Head Diameter: 26mm
Stem Diameter: 12mm
Stem Length: 14mm
Hyundai Elantra & Sonata
and Kia Optima 1995 - On

UNIT PACKAGE: 15



22318

(Hyundai: 86179-2V000)
White Nylon

Garnish Moulding
Retainer with Sealer
Top Head Size 13mm x 13mm
Bottom Head Diameter: 20mm
Stem Length: 11mm
Fits into 7.5mm Hole
Hyundai Veloster 2012 - On

UNIT PACKAGE: 25



22319

(Hyundai: 86179-2V020)
Blue Nylon

Garnish Moulding Retainer with Sealer
Top Head Size: 10.5mm x 12mm
Bottom Head Diameter: 12mm
Stem Length: 11mm
Fits into 7.5mm Hole
Hyundai Veloster 2012 - On
Kia Soul 2014 - On

UNIT PACKAGE: 25



22003

(Hyundai: 82315-2P000)
White Nylon

Trim Panel Retainer
Top Head Diameter: 13mm
Middle Head Diameter: 15mm
Bottom Head Diameter: 18mm
Stem Diameter: 11mm
Stem Length: 13mm
Overall Length: 19mm
Hyundai & Kia 1999 - On

UNIT PACKAGE: 50



22009

(Hyundai: 85506-4A000)
White Nylon

Trim Panel &
Window Garnish Retainer
Top Head Diameter: 13mm
Middle Head Diameter: 16mm
Bottom Head Diameter: 15mm
Stem Diameter: 9.6mm
Stem Length: 13mm
Overall Length: 20mm
Hyundai Tucson & Kia Sorento 2003 - On

UNIT PACKAGE: 50



22006

(Hyundai: 82315-36000,
92552-36000)
White Nylon

Trim Panel Retainer with Sealer
Top Head Diameter: 13mm
Middle Head Diameter: 15mm
Bottom Head Diameter: 18.5mm
Stem Diameter: 10.3mm
Stem Length: 15mm
Overall Length: 21mm
Hyundai Accent & Elantra 2000 - 1995

UNIT PACKAGE: 25



21070
 (Hyundai: 82315-38000
 GM: 94530565)
 White Nylon

Trim Panel Retainer
 Top Head Diameter: 13mm
 Middle Head Diameter: 16mm
 Bottom Head Diameter: 16mm
 Stem Diameter: 9.5mm
 Stem Length: 10mm
 Chevrolet 2004 - On
 Hyundai Accent, Santa Fe,
 Sonata Tiburon & XG300/350 1999 - On
 Kia 2001 - On

UNIT PACKAGE: 25



22008
 (Hyundai: 85495-2E050)
 Black Nylon

Headliner Retainer
 Top Head Diameter: 14mm
 Middle Head Diameter: 15mm
 Bottom Head Diameter: 16mm
 Stem Diameter: 10.3mm
 Stem Length: 10mm
 Overall Length: 15.5mm
 Hyundai & Kia

UNIT PACKAGE: 50



21360
 (85849-3B000)
 White Nylon

Headliner & Trim Panel Retainer
 Top Head Diameter: 13mm
 Middle Head Diameter: 16mm
 Bottom Head Diameter: 16mm
 Stem Diameter: 10mm
 Stem Length: 12mm
 Hyundai 2001 - On

UNIT PACKAGE: 25



21188
 (82315-27000)
 Pink Nylon

Trim Panel Retainer
 Top Head Diameter: 15mm
 Middle Head Diameter: 16mm
 Bottom Head Diameter: 18mm
 Stem Diameter: 10mm
 Stem Length: 12mm
 Hyundai and Kia 2003 - On

UNIT PACKAGE: 15



22313
 (Hyundai: 82315-2W000)
 Green Nylon

Door Panel, Interior Trim
 & Garnish Retainer
 Top Head Diameter: 13mm
 Middle Head Diameter: 16mm
 Bottom Head Diameter: 18mm
 Stem Diameter: 10mm
 Stem Length: 10mm
 Hyundai Santa Fe & Sonata 2013 - On
 Kia Forte & K900 2014 - On

UNIT PACKAGE: 25



22315
 (Hyundai: 85849-3L000)
 Gray Nylon

Garnish & Interior Moulding Retainer
 Top Head Diameter: 13mm
 Middle Head Diameter: 16.5mm
 Bottom Head Diameter: 18mm
 Stem Length: 15mm
 Fits into 9mm Hole
 Hyundai Azera, Sonata
 & Tuscon 2006 - On
 Kia Forte 2010 - On

UNIT PACKAGE: 50



22004
 (Hyundai: 82315-22000)
 White Nylon

Trim Panel Retainer
 Top Head Diameter: 13mm
 Middle Head Diameter: 16mm
 Bottom Head Diameter: 18mm
 Stem Diameter: 9mm
 Stem Length: 15mm
 Overall Length: 20mm
 Hyundai Accent 1999 - 95

UNIT PACKAGE: 50



22005
 (Hyundai: 82315-33020)
 White Nylon

Trim Panel Retainer
 Top Head Diameter: 15mm
 Middle Head Diameter: 16mm
 Bottom Head Diameter: 18mm
 Stem Diameter: 10.7mm
 Stem Length: 12mm
 Overall Length: 18.5mm
 Hyundai & Kia 1995 - On

UNIT PACKAGE: 50



22012

(Hyundai: 87378-3N000)
Blue Nylon

License Plate Panel Retainer with Sealer
Top Head Diameter: 15mm
Middle Head Diameter: 16mm
Bottom Head Diameter: 18mm
Stem Diameter: 10.5mm
Stem Length: 39mm
Overall Length: 44.5mm
Hyundai Equus 2011 - On

UNIT PACKAGE: 25



21233

(86157-37000)
Black Nylon

Hood Mounting Push-Type Retainer
Head Diameter: 10mm
Stem Length: 13mm
Fits into 5mm Hole
Azera 2009 - On

UNIT PACKAGE: 15



21328

(86155-2H100)
Black Nylon

Cowl & Bumper Push-Type Retainer
Head Diameter: 15mm
Stem Length: 10mm
Fits into 7mm Hole

Hyundai Genesis & Veracruz and Kia Rio 2009 - On

UNIT PACKAGE: 15



21530

(Subaru: 909130067;
Hyundai: 86590-3S000)
Black Nylon

Engine Cover and Fender Liner
Push-Type Retainer
Head Diameter: 18mm
Stem Length: 10mm
Fits into 8mm Hole

B9 Tribeca, Forester, Legacy & Outback & Tribeca. 2005 - On
Hyundai Azera, Elantra, Genesis & Sonata and Kia Cadenza & Optima 2011 - On

UNIT PACKAGE: 15



17632

(Mazda: B092-51-833;
Ford: MB-455-56143, W705845-S300;
Hyundai: 86590-28000)
Black Nylon

Push-Type Retainer
Head Diameter: 18mm
Stem Length: 12mm
Fits into 8mm Hole

Hyundai, Mazda & Ford Aspire

UNIT PACKAGE: 10



22253

(Hyundai: 86595-2T500,
14206-08250-B)
Black Nylon

Bumper, Engine Under Cover & Fender Liner Push-Type Retainer
Head Diameter: 18mm
Stem Length: 14mm
Fits into 8mm Hole
Hyundai Elantra, Equus, Genesis, Santa Fe & Sonata and Kia Forte, K900, Optima, Sedona & Sorento 2013 - On

UNIT PACKAGE: 15

21355

(Not Available from O.E.M.)
Black Nylon



Photo not actual size

Cable Strap

Overall Length: 160mm (6-3/8")

Strap Width: 5mm (3/16")

Maximum Bundle Diameter: 36mm (1-13/32")

Fits into 7mm Hole
Hyundai & Universal

UNIT PACKAGE: 25



21067

(86593-24000)
Stainless Steel

Bumper & Grille Retainer
Width: 13mm
Length: 30mm

Accent, Santa Fe & Sonata 1995 - On

UNIT PACKAGE: 25



22352

(Hyundai: 84145-26000)
Black Nylon

Wheel Well Liner & Splash Shield Nylon Nut
Hex Size: 14mm

Flange Diameter: 30mm
Overall Height: 10mm

Hyundai Accent, Elantra, Equus, Genesis, Genesis Coupe, Genesis G90, Santa Fe, Sonata, Tucson, Veloster & Veracruz 2000 - On

UNIT PACKAGE: 15



21378

(86825-28000)
Black Nylon

Nylon U-Nut

Screw Size: M6 (#14)

Panel Size: Up to 1.5mm

Center of Hole to Edge: 8mm

Hyundai Accent & Elantra and Kia 1995 - On

UNIT PACKAGE: 25





22301

(Nissan: 01553-05233)
Black Nylon

Fender Liner Moulding Clip
Top Width: 31mm
Bottom Width: 30mm
Overall Height: 11mm
Infiniti JX35 & QX60 2013 - On
Nissan Altima, Murano, Pathfinder,
Rogue & Sentra 2007 - On

UNIT PACKAGE: 25



20961

(Not Available from O.E.M.)
White Nylon

Drip Moulding Clip
with Sealer
Top Width: 25mm
Overall Height: 16mm
Fits into 5mm Hole
Infiniti M45, I30 & G35 2005 - On
Nissan Altima, Maxima & 350Z 2002 - On

UNIT PACKAGE: 15



22076

(Nissan: 76882-6P010)
Natural Nylon

Hood, Front Fender Bracket
& Exterior Moulding Clip
Top Head Size: 15mm x 15mm
Bottom Head Size: 15mm x 15mm
Stem Length: 15mm
Overall Length: 22mm
Infiniti Q45 2001 - 1996
Nissan Altima & Maxima 2006 - 02

UNIT PACKAGE: 25



20886

(76882-6P000)
White Nylon

Moulding Clip
Top Head Size: 8mm x 15mm
Bottom Head Diameter: 15mm
Stem Length: 9mm
Infiniti 2005 - On

UNIT PACKAGE: 25



22061

(Nissan: 76882-JG10A)
White Nylon

Fender Moulding Clip
with Sealer
Top Head Size: 6mm x 12mm
Bottom Head Diameter: 16mm
Stem Length: 10mm
Infiniti Qx80 2014 - On
Nissan Juke 2011 - On

UNIT PACKAGE: 25



21330

(Not Available from O.E.M.)
White Nylon

Body Side Moulding Clip
Head Size: 18mm x 25mm
Overall Length: 29mm
Infiniti 2008 - On

UNIT PACKAGE: 15



21147

(85284-AD000)
White Nylon

Rear Bumper Clip
Width: 20mm
Height: 29mm
Length: 35mm
Infiniti G20, I30, I35, Q45 & QX56
and Nissan 350Z, Altima, Maxima &
Murano 1999 - On

UNIT PACKAGE: 10



21850

(Nissan: 26398-ED000)
White Nylon

Tail Light Clip
Top Head Size: 13mm x 13mm
Bottom Head Diameter: 19mm
Stem Length: 10mm
Infiniti M37, M56 & M Hybrid 2013 - On
Nissan Armada, Juke, Pathfinder,
Sentra & Versa 2006 - On

UNIT PACKAGE: 25



21160

(85284-7S610)
Black Nylon

Rear Bumper Retainer with Sealer
Head Diameter: 12mm
Stem Length: 21mm
Overall Length: 35mm
Infiniti QX56 and Nissan
Armada & Pathfinder 2004 - On

UNIT PACKAGE: 15



22261

(Nissan: 76848-35F00)
White Nylon

Moulding Screw Grommet with Sealer
Head Diameter: 18mm
Stem Diameter: 8.5mm
Stem Length: 14mm
Infiniti G35, G37, I30, I35, M35h, Q40, Q50,
Q70, QX56 & QX80 and Nissan 350Z, Altima,
Cube, Pathfinder & Sentra 2003 - On

UNIT PACKAGE: 15



22274

(Nissan: 01281-01121)
White Nylon

Screw Grommet with Sealer
Screw Size: 2.9mm (#4)
Head Diameter: 12mm
Stem Length: 16mm
Fits into 7mm x 7mm Square Hole
Infiniti M35h, M45, Q45 & QX50 and
Nissan Altima, Maxima, Pathfinder, Quest,
Rogue & Sentra 2012 - 2003

UNIT PACKAGE: 10

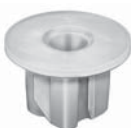

20764

(01281-00831)
Natural Nylon

Bumper, Fender & Light
Screw Grommet
Screw Size: M4.2 (#8)
Head Diameter: 16mm
Stem Length: 10mm
Fits into 9mm x 9mm Hole
Infiniti and Nissan 240SX, Altima,
Frontier, Maxima, Pathfinder,
Quest & Xterra 1989 - On

UNIT PACKAGE: 25



21425

(01281-01321)
Natural Nylon

Bumper Screw Grommet
M5.5 (#12) Screw Size
Overall Length: 22mm
Infiniti I30, I35 & Q45 and Nissan Altima,
Maxima & Quest 2009 - 1996

UNIT PACKAGE: 25



21324

(01281-00691)
Natural Nylon

Screw Grommet with Sealer
Screw Size: M4.2 (#8)
Head Diameter: 16mm
Stem Length: 20mm
Nissan 240SX, Altima, Frontier,
Maxima, Pathfinder & Titan and
Infiniti I30, I35 & Q45 1989 - On

UNIT PACKAGE: 15



20604

(01281-00711)
Natural Nylon

Rocker Moulding Screw Grommet
Screw Size: M4.2 (#8) & #10 (M4.8)
Head Diameter: 20mm
Stem Length: 15mm
Nissan & Infiniti 1995 - On

UNIT PACKAGE: 10



21768

(Nissan: 63846-5V000)
White Nylon

Bumper Grommet with Sealer
Screw Size: M4.8 (#10)
Head Diameter: 20mm
Stem Length: 16mm
Overall Length: 22mm
Infiniti FX35, FX45, JX35, M35, M36, M37, M56 & QX56
and Nissan Altima, Juke, Maxima, Murano,
Quest & Sentra 2003 - On

UNIT PACKAGE: 25



21824

(Nissan: 26557-2U001)
Brown Nylon

Screw Grommet with Sealer
Screw Size: M6.3-1.81 (#14)
Head Size: 15mm x 19mm
Stem Length: 16mm
Infiniti EX35, G37, JX35, M35, M45, Q50, QX56, QX60
& QX70 and Nissan 350Z, 370Z, Altima, Armada,
Cube, Juke, Maxima, Murano, Pathfinder, Quest,
Rogue, Sentra, Versa & Xterra 2014 - 02

UNIT PACKAGE: 15



21111

(01281-00331)
Natural Nylon

Bumper, Rocker Panel & Light Mounting
Screw Grommet with Sealer
Screw Size: M6.3 (#14)
Head Diameter: 20mm
Stem Length: 16mm
Fits into 10mm Square Hole
Infiniti 1997 - On
Nissan 1996 - On

UNIT PACKAGE: 25



21688

(Nissan: 01553-02923)
White Nylon

Moulding Grommet with Sealer
Head Size: 14mm x 18mm
Stem Length: 13mm
Infiniti M45 & Q45 and Nissan Armada, Frontier,
Pathfinder & Xterra 1996 - On

UNIT PACKAGE: 25



20736

(01281-01081)
Natural Nylon

Front Bumper Nylon Nut
Screw Size: M4.8 (#10)
Flange Diameter: 16mm
Overall Length: 22mm
Infiniti & Nissan 1997 - On

UNIT PACKAGE: 15



22287

(Nissan: 62319-AU000)
Black Nylon

Front Bumper & Grille Screw Grommet
Head Size: 13.5mm x 23.5mm
Stem Length: 13mm
Overall Height: 15mm
Infiniti G37, M35, M45, QX56 &
QX80 and Nissan Rogue 2006 - On

UNIT PACKAGE: 15



22255

(Nissan: 76848-ED000)
Light Blue Nylon

Rocker & Door Trim Panel Grommet
Head Diameter: 15mm
Stem Diameter: 8mm
Stem Length: 15mm
Infiniti Q60 Coupe and Nissan 350Z &
Versa 2014 - 2006

UNIT PACKAGE: 25



22060

(Nissan: 65810-K2002)
Black Nylon

Hood Seal Retaining Clip
Head Size: 6.5mm x 16mm
Stem Diameter: 3.5mm x 5.5mm
Stem Length: 8mm
Infiniti 2003 - 1997
Nissan 2003 - 1996

UNIT PACKAGE: 25



21229

(65810-K2000)
Black Nylon

Hood Sealer Retaining Clip
Head Size: 6.4mm x 16mm
Stem Diameter: 3.5mm x 6mm
Stem Length: 10mm
Infiniti I30, I35, Q45 & QX4 and Nissan Maxima
& Pathfinder 2004 - 1996

UNIT PACKAGE: 25



22286

(Nissan: 80287-37F00)
Natural Nylon

Front Door, Garnish &
Interior Trim Retaining Clip
Head Diameter: 14mm
Stem Length: 10mm
Overall Height: 11.5mm
Infiniti FX35, FX45, G35, G37 &
Q60 and Nissan Murano 2015 - 2003

UNIT PACKAGE: 25



21689

(Nissan: 66820-61U00)
Black Nylon

Cowl Grille Retainer
Head Diameter: 11mm
Stem Diameter: 4.5mm
Stem Length: 15mm
Infiniti M45 & Q45 and Nissan Sentra 1997 - On

UNIT PACKAGE: 25



21519

(01553-01A50)
Black Nylon

Bumper & Trim Retainer
Head Diameter: 12mm
Stem Diameter: 6mm
Stem Length: 15mm
Infiniti FX35, G35, G37, M35, M45 & Q45
and Nissan 350Z & 370Z 1997 - On

UNIT PACKAGE: 25



22075

(Nissan: 01553-06451)
Black Nylon

Upper Quarter Trim &
Rear Trunk Seal Retainer
Head Diameter: 20mm
Stem Diameter: 8.7mm
Stem Length: 16mm
Infiniti G35, J30, JX60, M35, M37, M56, Q45, Q50 &
QX60 and Nissan Altima, Pathfinder & Quest 1996 - On

UNIT PACKAGE: 25



19468

(65846-40F00)
Black Nylon

Hood Insulation Retainer
Head Diameter: 28mm
Stem Diameter: 6mm
Stem Length: 10mm
J30, M30 & Q45 1989-On

UNIT PACKAGE: 15



22063

(Nissan: 01553-02903)
White Nylon

Front Side Lower Fender
Panel Bracket Retainer
Top Head Diameter: 13mm
Bottom Head Diameter: 12mm
Stem Length: 14mm
Overall Length: 21mm
Infiniti Qx4 & Qx56 and Nissan Pathfinder,
Frontier & Xterra 2010 - 1997

UNIT PACKAGE: 25



21701

(Nissan: 85284-4J500)
Black Nylon

Retainer with Sealer
Top Head Diameter: 13mm
Middle Head Diameter: 16mm
Bottom Head Diameter: 18mm
Stem Diameter: 10mm
Stem Length: 11mm
Overall Length: 17mm
Infiniti I35 and Nissan Altima,
Cube & Maxima 2011 - 02

UNIT PACKAGE: 10



21414

(80999-VE000)
White Nylon

Trim Panel Retainer with Sealer
Top Head Diameter: 13mm
Middle Head Diameter: 16mm
Bottom Head Diameter: 18mm
Stem Diameter: 9mm
Stem Length: 13mm
Infiniti and Nissan 1993 - On

UNIT PACKAGE: 25



20669

(01553-07111)
Black Nylon

Trim Panel Retainer
Top Head Diameter: 13mm
Middle Head Diameter: 15mm
Bottom Head Diameter: 18mm
Stem Diameter: 9mm
Stem Length: 15mm
Nissan Altima and
Infiniti G35 & Q45 1997 - On

UNIT PACKAGE: 25



20668

(01553-09791)
White Nylon

Trim Panel Retainer
Top Head Diameter: 13mm
Middle Head Diameter: 16mm
Bottom Head Diameter: 18mm
Stem Diameter: 9mm
Stem Length: 14mm
Nissan & Infiniti 1999 - On

UNIT PACKAGE: 15



22288

(Infiniti: 01553-10641)
Green Nylon

Door & Interior Trim Panel Retainer
Top Head Diameter: 13mm
Middle Head Diameter: 16.4mm
Bottom Head Diameter: 18mm
Stem Diameter: 9.5mm
Stem Length: 15mm
Overall Length: 22mm
Infiniti FX35, FX 37, FX50
& QX70 2009 - On

UNIT PACKAGE: 25



21640

(84953-AU100)
Black Nylon

Door Trim Panel Retainer with Sealer
Top Head Diameter: 13mm
Middle Head Diameter: 16mm
Bottom Head Diameter: 18mm
Stem Diameter: 9mm
Stem Length: 14mm
FX35, FX45, G35 & G37 2008 - 03

UNIT PACKAGE: 15



21633

(80850-89900)
White Nylon

Weather Retainer
Head Size: 6mm x 16mm
Stem Diameter: 6.5mm
Stem Length: 12mm
Infiniti I30, I35 & M45
and Nissan Maxima 2004 - 2000

UNIT PACKAGE: 25



22039
 (Nissan: 01553-2DR9A)
 Black Nylon

Push-Type Retainer
 Top Head Diameter: 16mm x 19mm
 Bottom Head Diameter: 20mm
 Stem Length: 12mm
 Fits into 8mm Hole
 Infiniti G20, JX35, Q45 & QX60 and
 Nissan Frontier, Maxima, NV, Pathfinder,
 Sentra, Versa & Xterra 2002 - On

UNIT PACKAGE: 15



21192
 (Nissan: 01553-05323)
 (Mazda: L33X13209)
 Black Nylon

Cowl, Bumper & Fender Liner
 Push-Type Retainer
 Head Diameter: 20mm
 Stem Length: 12mm
 Fits into 8mm Hole
 Infiniti FX35, FX45, G35 and Nissan 2003 - On
 Mazda 2, 3, 5, 6, CX-5, CX-7 & CX-9 2007 - On

UNIT PACKAGE: 10



20953
 (11296-AG000)
 Black Nylon

Front Bumper and Radiator Support
 Push-Type Retainer
 Head Diameter: 20mm
 Stem Length: 13mm
 Fits into 8mm Hole
 Infiniti FX 35/45 and Nissan Altima,
 Maxima & Quest 2002 - On

UNIT PACKAGE: 25



21545
 (01553-08231)
 Black Nylon

Front & Rear Bumper
 and Grille Push-Type Retainer
 Head Diameter: 20mm
 Stem Length: 15mm
 Fits into 8mm Hole
 Infiniti FX35, FX45 & Q45 and Nissan
 Murano, 240SX & 350Z 1995 - On

UNIT PACKAGE: 25



21646
 (80874-AX000)
 Black Nylon

Hole Plug
 Head Diameter: 25mm
 Fits into 18mm Hole
 Infiniti EX35 and Nissan Juke & Murano 2003 - On

UNIT PACKAGE: 25



22358
 (Nissan: 65722-01E00)
 White Nylon

Hood Prop Rod Clip
 Holds 8mm Diameter Rod
 Overall Height: 23mm
 Fits into 9mm Hole
 Infiniti G20 & QX4 2003 - 1991
 Nissan 200SX, 240SX, 300ZX, 370Z, Altima, Frontier,
 Pathfinder, Sentra, Stanza & Xterra 1986 - On

UNIT PACKAGE: 15



21637
 (01553-05131)
 Black Nylon

Wheel Liner, Cowl Insulator
 & Trim Flange Clip
 Flange Diameter: 20mm
 Hex: 10.5mm
 Overall Height: 12.5mm
 Infiniti EX35, FX35, FX50, G25, G35, G37, J30, M35,
 M45 & Q45 and Nissan 370Z, Altima, Cube, Frontier,
 GT-R, Juke, Leaf, Maxima, Murano, NV, Pathfinder,
 Quest, Rouge, Versa & Xterra 1993 - On

UNIT PACKAGE: 15



21664
 (63848-9Y000)
 Black Nylon

Fender Apron Clip
 Width: 20mm
 Width at Wings: 30mm
 Overall Length: 30mm
 Infiniti EX35, FX35, FX50, G35, G37, M35, M37, M45 &
 M56 and Nissan Altima, Maxima, Murano,
 Pathfinder, Quest & 370Z 2005 - On

UNIT PACKAGE: 10



21017
 (76882-0M000)
 White

Nylon U-Nut
 Screw Size: M4.8 (#10)
 Panel Range: Up to 1.5mm
 Center of Hole to Edge: 8mm
 Nissan & Infiniti 1995 - On

UNIT PACKAGE: 15

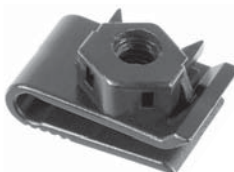

21459
 (01241-00881)
 Black Nylon

Nylon U-Nut
 with Captive Metal Hex Nut
 Thread: M6 - 1.0
 Center of Hole to Edge: 14mm
 Panel Range: Up to 4mm
 Nissan Altima, Maxima & 240SX
 and Infiniti I30 2001 - 1993

UNIT PACKAGE: 10



17195

(Isuzu: 8942180270)
Black Nylon

Grille Clip
Width: 13mm
Length: 22mm
Ford Escort, Honda,
Isuzu, Mitsubishi & Plymouth Laser

UNIT PACKAGE: 25



17355

(GM: 94467458;
Isuzu: 8944674584)
Nylon

Windshield Reveal Moulding Clip
Isuzu and Geo Storm 1992 - On

UNIT PACKAGE: 10



14739

(Isuzu: 8941340270;
Toyota: 90189-05012)
Natural Nylon

Screw Size: #6
Width: 16mm
Length: 12mm
Snaps into 6mm x 10mm Hole

UNIT PACKAGE: 50



14269

(Isuzu: 8942264920;
Mazda: 9927-40-825;
Toyota: 67771-01010, 67771-12010)
White Nylon

Door Panel Retainer
Top Head Diameter: 13mm
Middle Head Diameter: 15.5mm
Bottom Head Diameter: 18mm
Stem Length: 14mm
Overall Length: 20.5mm
Stem Diameter: 9.5mm

UNIT PACKAGE: 25



14696

(Isuzu: 8942981190;
Honda: 90684-SA5-003;
Nissan: 10998-30880)
Black Nylon

Push-Type Retainer
Head Diameter: 15mm
Stem Length: 11mm
Fits into 6mm Hole

UNIT PACKAGE: 25



14727

(Isuzu: 8942211500; GM: 94221150;
Nissan: 63844-00100)
Black Nylon

Push-Type Retainer
Head Size: 14mm x 22mm
Stem Length: 9mm
Fits into 7mm Hole

UNIT PACKAGE: 25



17076

(GM: 94145515;
Isuzu: 89414-55150)

Inner Fender Shield &
Bumper Fascia Retainer
Head Diameter: 18mm
Stem Length: 23mm
Stem Diameter: 7mm
Geo Storm & Isuzu 1990-On

UNIT PACKAGE: 25

BODY HARDWARE MASTER PROGRAM

The Body Hardware Master Program, 6600BHM is based on Auveco's Display Boards, DB-428.

Learn more about the Body Hardware Master Program in the green section of the catalog, online at www.auveco.com or contact customer service at 1-800-354-9816 or mail@auveco.com.

"428" DISPLAY BOARDS

428 of the most popular body hardware and fastener items are shrink-wrapped onto seven different boards. Each board contains product groups, body shops are familiar with and use often.

The back of each board contains each part number, unit package quantity, OEM number and size specification. The backs are protected by a clear plastic liner.

Learn more about the display boards at the front of the catalog, online at www.auveco.com or contact customer service at 1-800-354-9816 or mail@auveco.com

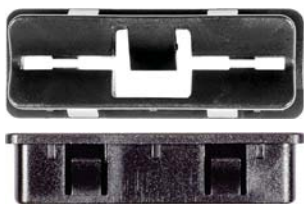

22247
(Jaguar: C2Z11575)
Black Nylon
Headliner Retaining Clip
Width: 14.5mm
Length: 39.3mm
Overall Height: 9.5mm
Jaguar XF & XFR 2009 - On

UNIT PACKAGE: 15



22246
(Jaguar: C2Z11576)
Black Nylon
Headliner Retaining Clip
Width: 16mm
Length: 51mm
Overall Height: 10mm
Jaguar XF & XFR 2009 - On

UNIT PACKAGE: 15



22157
(Jaguar: C2D5807)
Yellow Nylon
Rocker Moulding Retainer
Top Head Diameter: 13mm
Middle Head Diameter: 16mm
Bottom Head Diameter: 18mm
Stem Diameter: 12mm
Stem Length: 11mm
Overall Length: 20mm
Jaguar XJ & XJ-L 2011 - On

UNIT PACKAGE: 15



22250
(Jaguar: C2C14628)
Black Nylon
Trim Panel Retainer with Sealer
Top Head Diameter: 15mm
Bottom Head Diameter: 18mm
Stem Diameter: 7.2mm
Stem Length: 20mm
Jaguar 2015 - On

UNIT PACKAGE: 15



22256
(Jaguar: XR831159)
Black Nylon
Radiator Support & Air Deflector Shield
Push-Type Retainer
Head Diameter: 24mm
Stem Length: 12mm
Fits into 12mm Hole
Jaguar X, XF, XJ-L & XK 2012 - On

UNIT PACKAGE: 10

KIA CLIPS & FASTENERS



22007
(Hyundai: 84747-2L000)
White Nylon
Trim Panel & Dash Console Clip
Overall Length: 21mm
Hyundai Elantra, Entourage,
Sonata & Veloster 2006 - On
Kia Forte, Sorento & Soul 2010 - On

UNIT PACKAGE: 50



22317
(Hyundai: 85859-3S100)
Black Nylon
Interior Trim Clip
Overall Height: 19mm
Width at Bottom: 15mm
Hyundai Accent, Azera, Elantra & Sonata
and Kia Optima & Rio 2011 - On

UNIT PACKAGE: 50



22316
(Hyundai: 85858-3S000)
Black Nylon
Interior Trim Clip
Overall Height: 16mm
Width at Bottom: 11mm
Hyundai Azera & Sonata and
Kia Optima & Soul 2011 - On

UNIT PACKAGE: 50



21863
(Hyundai: 87758-35010)
White Nylon
Moulding Clip with Sealer
Top Head Size: 10mm x 12mm
Bottom Head Size: 14mm x 18mm
Stem Length: 10mm
Hyundai Accent, Kia Soul &
Mitsubishi Outlander 2006 - On

UNIT PACKAGE: 15



21484

(87756-3E500)
Red Nylon

Wheel Flare & Body Side
Moulding Clip with Sealer
Top Head Size: 11mm x 13mm
Bottom Head Size: 12mm x 20mm
Stem Length: 10mm
Forte Koup & Sorento 2009 - On
UNIT PACKAGE: 15



21457

(86359-33500)
White Nylon

Front Bumper Moulding Clip
Top Head Size: 10mm x 15mm
Bottom Head Size: 16mm x 18mm
Stem Length: 9mm
Spectra 2009 - 04
UNIT PACKAGE: 25



22329

(Hyundai: 87758-38000)
White Nylon

Rocker Moulding Clip with Sealer
Top Head Size: 10mm x 13mm
Bottom Head Size: 7mm x 16mm
Stem Length: 9mm
Hyundai Sonata 2001 - 1999
Kia Optima & Sorento 2009 - 2001
UNIT PACKAGE: 50



21363

(86591-25000)
Black Nylon

Bumper Cover Clip with Sealer
Head Size: 25mm x 30mm
Stem Length: 15mm
Overall Length: 35mm
Rio 2010 - On
UNIT PACKAGE: 5



22326

(Kia: 87756-C5000)
Red Nylon

Fender, Rocker &
Wheel Moulding Clip with Sealer
Top Head Size: 10mm x 12mm
Bottom Head Size: 14mm x 20mm
Stem Length: 10mm
Kia Sorento 2016 - On
UNIT PACKAGE: 25



21069

(92351-37000)
Natural Nylon

Headlight Assembly Grommet
Head Diameter: 15mm
Stem Length: 8mm
Fits into 10mm Hole
Hyundai 2001 - On
Kia Rio & Spectra 2000 - On
UNIT PACKAGE: 25



22014

(Kia: 87758-3E000, 87759-3E000,
87719-02500)
White Nylon

Fender Flare & Door
Moulding Clip with Sealer
Top Head Size: 10.5mm x 9.5mm
Bottom Head Size: 14mm x 17.5mm
Stem Diameter: 14.3mm
Stem Length: 10mm
Kia Sorento 2009 - 03
UNIT PACKAGE: 25



22322

(Hyundai: 86518-3M000)
White Nylon

Bumper Grommet
Screw Size: M3.5 (#6)
Head Size: 8mm x 10mm
Stem Length: 12mm
Hyundai Azera & Sonata 2012 - On
Kia Cadenza 2014 - On
UNIT PACKAGE: 25



22015

(Hyundai: 87756-1F000)
Blue Nylon

Fender Flare, Rocker, Door & Exterior
Moulding Clip with Sealer
Top Head Size: 10mm x 12mm
Bottom Head Size: 14mm x 20mm
Stem Diameter: 14mm
Stem Length: 10mm
Hyundai Santa Fe 2013 - On
Kia Sportage 2011 - On
UNIT PACKAGE: 25



22323

(Kia: 86625-1M000)
White Nylon

Bumper Grommet
Screw Size: M4.8 (#10)
Head Size: 8mm x 10mm
Stem Length: 12mm
Kia Optima 2011 - On
UNIT PACKAGE: 25





21371

(86699-2D000)
White Nylon

Front & Rear Bumper
Cover Nylon Nut
Head Size: 11mm x 11mm
Stem Length: 9mm
Overall Length: 13.5mm
Forte Koup 2010 - On

UNIT PACKAGE: 25



21381

(86438-4A100)
Black Nylon

Hood Seal Retainer
Head Size: 5mm x 13mm
Stem Diameter: 8mm
Stem Length: 11mm
Hyundai Elantra & Tucson
and Kia Forte & Sportage 2009 - On

UNIT PACKAGE: 50



22017

(Hyundai: 87756-34520)
Green Nylon

Fender & Door Moulding Nylon Nut
Screw Size: M3.5 (#6)
Head Size: 13mm x 13mm
Stem Diameter: 13.5mm
Stem Length: 8mm
Hyundai Tucson 2009 - 05
Kia Optima 2006 - 01

UNIT PACKAGE: 50



21382

(86434-4A000)
Black Nylon

Hood Sealer Retainer
Head Size: 6mm x 16mm
Stem Diameter: 8mm
Stem Length: 14mm
Hyundai Elantra, Sonata & Tucson
and Kia Sportage 2009 - On

UNIT PACKAGE: 50



21066

(87758-37000)
White Nylon

Fender & Rocker Moulding
Nylon Nut with Sealer
Screw Size: M4.2 (#8)
Head Size: 17mm x 17mm
Stem Length: 14mm
Hyundai 1999 - On
Kia Optima & Sorento 2001 - On

UNIT PACKAGE: 25



22325

(Hyundai: 87756-2W000)
Red Nylon

Weatherstrip Retainer
Head Size: 5mm x 15mm
Stem Diameter: 7mm
Stem Length: 8mm
Hyundai Santa Fe & Kia Sorento 2013 - On

UNIT PACKAGE: 100



20567

(87756-38000)
Black Nylon

Body Side Moulding Clip with Sealer
Top Head Size: 8mm x 9mm
Bottom Head Size: 14mm x 18mm
Stem Length: 10mm
Elantra & Sonata 2002 - On
Kia Rio 2010 - On

UNIT PACKAGE: 15



21349

(85746-06000LX)
Gray Nylon

Headliner Retainer
Head Diameter: 18mm
Stem Diameter: 8mm
Stem Length: 16mm
Rio 2010 - On

UNIT PACKAGE: 25



22321

(Hyundai: 86438-2T000)
Black Nylon

Hood & Bumper Seal Retainer
Head Size: 4.5mm x 13mm
Stem Diameter: 7.6mm
Stem Length: 7.5mm
Hyundai Elantra & Genesis 2013 - On
Kia K900 & Optima 2011 - On

UNIT PACKAGE: 50



21350

(85746-06000RU)
Tan Nylon

Headliner Retainer
Head Diameter: 18mm
Stem Diameter: 8mm
Stem Length: 16mm
Rio 2010 - On

UNIT PACKAGE: 25



20543

(81126-37010)
Black Nylon

Hood Insulation Retainer
Head Diameter: 26mm
Stem Diameter: 12mm
Stem Length: 14mm
Hyundai Elantra & Sonata
and Kia Optima 1995 - On

UNIT PACKAGE: 15



22312

(Kia: 0K95-A-68401)
Gray Nylon

Exterior & Interior Moulding Retainer
Top Head Diameter: 13mm
Middle Head Diameter: 16mm
Bottom Head Diameter: 15mm
Stem Diameter: 9.5mm
Stem Length: 12mm
Overall Length: 18mm
Kia Soul, Sedona & Sportage 2010 - On

UNIT PACKAGE: 50



22319

(Hyundai: 86179-2V020)
Blue Nylon

Garnish Moulding Retainer with Sealer
Top Head Size: 10.5mm x 12mm
Bottom Head Diameter: 12mm
Stem Length: 11mm
Fits into 7.5mm Hole
Hyundai Veloster 2012 - On
Kia Soul 2014 - On

UNIT PACKAGE: 25



21070

(Hyundai: 82315-38000)
GM: 94530565)
White Nylon

Trim Panel Retainer
Top Head Diameter: 13mm
Middle Head Diameter: 16mm
Bottom Head Diameter: 16mm
Stem Diameter: 9.5mm
Stem Length: 10mm
Chevrolet 2004 - On
Hyundai 1999 - On
Kia Optima, Rio & Sorento 2001 - On

UNIT PACKAGE: 25



22003

(Hyundai: 82315-2P000)
White Nylon

Trim Panel Retainer
Top Head Diameter: 13mm
Middle Head Diameter: 15mm
Bottom Head Diameter: 18mm
Stem Diameter: 11mm
Stem Length: 13mm
Overall Length: 19mm
Hyundai & Kia 1999 - On

UNIT PACKAGE: 50



22008

(Hyundai: 85495-2E050)
Black Nylon

Headliner Retainer
Top Head Diameter: 14mm
Middle Head Diameter: 15mm
Bottom Head Diameter: 16mm
Stem Diameter: 10.3mm
Stem Length: 10mm
Overall Length: 15.5mm
Hyundai & Kia

UNIT PACKAGE: 50



22009

(Hyundai: 85506-4A000)
White Nylon

Trim Panel &
Window Garnish Retainer
Top Head Diameter: 13mm
Middle Head Diameter: 16mm
Bottom Head Diameter: 15mm
Stem Diameter: 9.6mm
Stem Length: 13mm
Overall Length: 20mm
Hyundai Tucson & Kia Sorento 2003 - On

UNIT PACKAGE: 50



21188

(82315-27000)
Pink Nylon

Trim Panel Retainer
Top Head Diameter: 15mm
Middle Head Diameter: 16mm
Bottom Head Diameter: 18mm
Stem Diameter: 10mm
Stem Length: 12mm
Hyundai & Kia
2003 - On

UNIT PACKAGE: 15



22313

(Hyundai: 82315-2W000)
Green Nylon

Door Panel, Interior Trim
& Garnish Retainer
Top Head Diameter: 13mm
Middle Head Diameter: 16mm
Bottom Head Diameter: 18mm
Stem Diameter: 10mm
Stem Length: 10mm
Overall Length: 17mm

Hyundai Santa Fe & Sonata 2013 - On
Kia Forte & K900 2014 - On

UNIT PACKAGE: 25



22315

(Hyundai: 85849-3L000)
Gray Nylon

Garnish & Interior Moulding Retainer
Top Head Diameter: 13mm
Middle Head Diameter: 16.5mm
Bottom Head Diameter: 18mm
Stem Length: 15mm
Overall Length: 21mm
Fits into 9mm Hole

Hyundai Azera, Sonata &
Tucson 2006 - On
Kia Forte 2010 - On

UNIT PACKAGE: 50



22005

(Hyundai: 82315-33020)
White Nylon

Trim Panel Retainer
Top Head Diameter: 15mm
Middle Head Diameter: 16mm
Bottom Head Diameter: 18mm
Stem Diameter: 10.7mm
Stem Length: 12mm
Overall Length: 18.5mm
Hyundai & Kia 1995 - On

UNIT PACKAGE: 50



21530

(Subaru: 909130067;
Hyundai: 86590-3S000)
Black Nylon

Engine Cover and Fender Liner
Push-Type Retainer
Head Diameter: 18mm
Stem Length: 10mm
Fits into 8mm Hole

B9 Tribeca, Forester, Legacy &
Outback & Tribeca. 2005 - On
Hyundai Azera, Elantra, Genesis & Sonata and
Kia Cadenza & Optima 2011 - On

UNIT PACKAGE: 15



21146

(0G032-50037-A)
Black Nylon

Bumper, Render, Grille,
Interior & Exterior Trim and
Pillar Push-Type Retainer
Head Diameter: 18mm
Stem Length: 12mm
Fits into 8mm Hole
Amanti, Magentis, Optima,
Rio, Sedona, Sephia, Sorento,
Spectra & Sportage 2000 - On

UNIT PACKAGE: 15



22253

(Hyundai: 86595-2T500, 14206-08250-B)
Black Nylon

Bumper, Engine Under Cover
& Fender Liner Push-Type Retainer
Head Diameter: 18mm
Stem Length: 14mm
Fits into 8mm Hole

Hyundai Elantra, Equus, Genesis, Santa Fe
& Sonata and Kia Forte, K900, Optima,
Sedona & Sorento 2013 - On

UNIT PACKAGE: 15



22299

(Hyundai: 86590-35000)
Black Nylon

Bumper Cover
Push-Type Retainer
Head Diameter: 20mm
Stem Length: 26mm
Fits into 9.5mm Hole
Hyundai Tucson 2009 - 2005

UNIT PACKAGE: 25



16858

(Kia: MNA01-56-145;
Mazda: NA01-56-145;
Nissan: 63844-01A00;
Ford: MNA01-56145, NA01-56145)
Black Nylon

Inner Fender Push-Type Retainer
Head Diameter: 20mm (25/32")
Stem Length: 18mm (23/32")
Fits into 8mm (5/16") Hole
Kia, Ford, Mazda & Nissan

UNIT PACKAGE: 25



21372

(0K95A-68615)
Black Nylon

Cowl Trim Retainer
Flange Diameter: 25mm
Hex Size: 14mm
Overall Height: 10mm
Forte Koup 2010 - On

UNIT PACKAGE: 25



21745

(GM: 11609651)
Zinc

Windshield Garnish and Interior Trim
Moulding Fastener
Screw Size: M4.2 (#8)
Stem Width: 13mm
Head Size: 13.5mm x 20.5mm
Overall Length: 22mm

Buick Enclave & Encore; Cadillac CTS, Escalade,
STS & XTS; Chevrolet Avalanche, Camaro, Cobalt,
Corvette, HHR, Impala, Malibu, Monte Carlo,
Silverado, Suburban, Tahoe & Traverse; Dodge Truck;
Ford Flex & Taurus; GMC Sierra & Yukon; Kia Sorento
& Soul; Pontiac G6 & G8; Saturn Outlook
and Suzuki Grand Vitara 2004 - On

UNIT PACKAGE: 15



21378

(86825-28000)
Black Nylon

Nylon U-Nut
Screw Size: M6 (#14)
Panel Range: Up to 1.5mm
Center of Hole to Edge: 8mm
Hyundai Accent & Elantra
and Kia 1995 - On

UNIT PACKAGE: 25

LAND ROVER CLIPS & FASTENERS



21657

(DYC101420)
White & Yellow Nylon

Moulding Clip
Top Head Diameter: 12.5mm
Middle Head Diameter: 15mm
Bottom Head Diameter: 15mm
Stem Diameter: 10.2mm
Stem Length: 8mm

Land Rover, Freelander & Range Rover 2002 - On

UNIT PACKAGE: 25



22151

(Land Rover: DYC000091)
White Nylon

Lower Side
Vent Grille Trim
Moulding Clip with Sealer
Width: 37mm
Length: 40mm
Stem Length: 13mm
Range Rover 2012 - 2003

UNIT PACKAGE: 15



22154

(Ford: W717736-S300)
White Nylon

Wheel Opening Moulding Clip
Top Head Size: 14mm x 20mm
Bottom Head Size: 14mm x 18mm
Stem Length: 18mm
Fits into 9mm Hole
Ford F-150 2015 - On

UNIT PACKAGE: 10



22249

(Land Rover: DYH500131)
White Nylon

Upper Bumper Screw Grommet
Screw Size: M4.8 (#10)
Top Head Size: 9mm x 13mm
Stem Length: 13mm
Land Rover LR3, LR4 & Range
Rover Sport 2005 - On

UNIT PACKAGE: 15



22145

(Land Rover: DYC000122)
White Nylon

Exterior Rear Door Lower
Moulding Clip with Sealer
Width: 23mm
Length: 39.3mm
Stem Length: 19mm
Range Rover 2012 - 2003

UNIT PACKAGE: 10



22085

(Land Rover: MWC3136)
White Nylon

Door Panel Grommet
Head Diameter: 14mm
Stem Length: 11mm
Overall Height: 14mm
Fits into 8mm Hole
Use with Auveco 21770
Discovery, Freelander &
Range Rover 2005 - 1995

UNIT PACKAGE: 25



22148

(Land Rover: LR000080)
Black Nylon

Rear Tail Light Guide Grommet
Head Size: 18mm x 22mm
Stem Length: 15mm
Overall Height: 18mm
Range Rover 2014 - On

UNIT PACKAGE: 25



22150

(Land Rover: LR002229)
Black Nylon

Pillar Post Moulding Grommet
Head Diameter: 15.5mm
Stem Length: 15mm
Overall Height: 16.5mm
Land Rover Evoque 2012 - 2004

UNIT PACKAGE: 25



22245

(Land Rover: LR012844)
Black Nylon

Body Liner Twist to Lock Retainer
Slotted Head Diameter: 19mm
Stem Length: 23mm
Land Rover Discovery, Range Rover &
Range Rover Sport 2004 - On

UNIT PACKAGE: 15



21855

(Land Rover: MXC1800)
Black Nylon

Door Panel Retainer
Head Diameter: 10.7mm
Stem Diameter: 5.8mm
Stem Length: 14mm
Defender & Discovery Series 1997-On

UNIT PACKAGE: 15



21770

(Land Rover: MWC9134)
Black Nylon

Side Door Trim Panel Retainer
Head Diameter: 14mm
Stem Diameter: 6mm
Stem Length: 17mm
Use with Auveco 22085
Defender Series, Discovery Series,
Freelander & Range Rover 2006 - 1989

UNIT PACKAGE: 25



22093

(Land Rover: DKP5279L)
Black Nylon

Trim Panel Retainer
Top Head Diameter: 12.3mm
Bottom Head Diameter: 12.3mm
Stem Diameter: 5.5mm
Stem Length: 17mm
Land Rover Discovery &
Defender 2004 - 1989

UNIT PACKAGE: 25



21853

(VW: 7M0-867-299-K, 7M3-867-299;
Land Rover: DYC500020;
Ford: 1008068)
Yellow Nylon

Door Trim Panel
Retainer with Sealer
Top Head Diameter: 13mm
Bottom Head Diameter: 17.5mm
Stem Diameter: 10.5mm
Stem Length: 15mm
Land Rover 1997 - On
VW & Audi 1999 - On

UNIT PACKAGE: 25



22153

(Land Rover: LR032984)
White Nylon

Front Door Louver Exterior
Trim Retainer with Sealer
Top Head Size: 8mm x 10mm
Bottom Head Diameter: 15mm
Stem Diameter: 12mm
Stem Length: 8mm
Land Rover Evoque,
HSE & Range Rover 2014 - 2012

UNIT PACKAGE: 15



22244

(Land Rover: LR034389;
LR053837)
White Nylon

Pillar Retainer with Sealer
Top Head Diameter: 14mm
(with extension: 21mm)
Bottom Head Diameter: 17mm
Stem Diameter: 10.8mm
Stem Length: 11mm
Land Rover Discovery &
Range Rover Sport 2010 - On

UNIT PACKAGE: 15



22251

(Land Rover: LR013135)
White Nylon

Trim Panel, Tail Gate & Luggage
Compartment Retainer with Sealer
Top Head Diameter: 14.5mm
Bottom Head Diameter: 15mm
Stem Diameter: 11mm
Stem Length: 15mm

Land Rover LR3, Range Rover Sport
& Range Rover Sport Supercharge 2009 - 2005

UNIT PACKAGE: 15



22152

(Land Rover: LR028939)
White Nylon

Front Lower Fender &
Exterior Trim Retainer
Top Head Diameter: 12.5mm
Middle Head Diameter: 16mm
Bottom Head Diameter: 18mm
Stem Diameter: 11.5mm
Stem Length: 10mm
Overall Length: 16.5mm
Land Rover Evoque,
HSE & Range Rover 2014 - 2012

UNIT PACKAGE: 25



22156

(Land Rover: IPN500050)
White Nylon

Windshield Glass Side Moulding
Retainer with Sealer
Top Head Diameter: 13mm
Middle Head Diameter: 15mm
Bottom Head Diameter: 17mm
Stem Length: 13mm
Overall Length: 19mm
Land Rover HSE &
Range Rover Sport 2012 - 2006

UNIT PACKAGE: 15



22149

(Land Rover: LR027255)
Blue Nylon

Wheel Arch Moulding Retainer
Top Head Diameter: 14mm
Middle Head Diameter: 15.5mm
Bottom Head Diameter: 18mm
Stem Diameter: 10mm
Stem Length: 16mm
Overall Length: 23mm
Land Rover Evoque 2012 - 2004

UNIT PACKAGE: 15

HAVE YOU VISITED US ONLINE?

Auveco's website has been completely renovated. Our new design is user friendly with easy navigation and ordering.

Product is searchable by car make, OEM number and category, as well as, several attribute drop downs within individual categories. All product also has stock availability listed.

Make sure to head over to

www.auveco.com

to receive up to date information on all our products.



22155

(Land Rover: LR033144)
Black Nylon

Pillar, Rocker & Floor
Moulding Push-Type Retainer
Head Diameter: 13mm
Stem Length: 13mm
Fits into 8mm Hole
Land Rover HSE &
Range Rover 2012 - On

UNIT PACKAGE: 15



22248

(Land Rover: DYQ500060)
Black Nylon

Exterior Pillar Moulding
Push-Type Retainer
Top Head Diameter: 19mm
Bottom Head Diameter: 13mm
Stem Length: 12mm
Fits into 8mm Hole
Range Rover Sport 2012 - 2006

UNIT PACKAGE: 25



21699

(Lexus: 75396-30260)
Natural Nylon

Moulding Clip with Metal Insert
Head Diameter: 17mm
Stem Length: 10mm
Fits into 12mm Hole
Lexus LX 470 2007 - 1998

UNIT PACKAGE: 25



21546

(90467-09204)
White Nylon

Rear Hatch Door Side Garnish
and Front Body Pillar Garnish Moulding Clip
Overall Height: 14mm
Lexus GS 300, GS 400, GS 430, GX 470, RX 330,
RX 350, RX 400 & RX 450 and Toyota Camry,
Highlander, Prius & Sienna 1998 - On

UNIT PACKAGE: 25



21549

(90467-12080)
Pink Nylon

Door Trim, Instrument Panel,
Rear Deck Trim & Roof Garnish
Trim Moulding Clip
Overall Height: 21mm
Lexus ES 350, GX 460, RX 330 & RX 450h and Toyota
Avalon, Camry, Corolla, Echo, FJ Cruiser, Highlander,
Matrix, Prius, RAV4, Sequoia, Sienna, Tacoma, Tundra,
Venza, Yaris & 4-Runner 2000 - On

UNIT PACKAGE: 25



19492

(75039-33040)

Front Fender
Moulding Clip
ES300 1991 - On

UNIT PACKAGE: 5



22351

(Toyota: 90467-10181)
Black Nylon

Headliner & Interior Trim Moulding Clip
Top Head Size: 18mm x 19mm
Bottom Head Size: 18mm x 24mm
Stem Diameter: 10mm
Stem Length: 13mm
Lexus ES 300h/350,
GS 300/350/430/460,
IS 200T/250/300/350, NX 200T/300h, RC 200T/300/350
& RX 350/400h/450h and Toyota Avalon &
Camry 1998 - On

UNIT PACKAGE: 25



22346

(Toyota: 53857-12010)
Black Nylon



Front Fender Moulding Clip with Sealer
Head Size: 20mm x 30mm
Stem Diameter: 9mm
Stem Length: 10mm
Lexus NX 200t, NX 300h, Scion iM and
Toyota Corolla & Prius 2015 - On

UNIT PACKAGE: 15



17989

(75049-33010)
Black Nylon

Side Moulding Retainer
Lexus 1990-On

UNIT PACKAGE: 5



19899

(75397-48010)
Red Nylon

Moulding Clip
ES300 & RX300 1999 - On

UNIT PACKAGE: 15



20661

(75397-33010)
White Nylon

Body Side Moulding Clip with Sealer
Head Size: 16mm x 20mm
Stem Length: 9mm
Lexus ES300 1997 - On

UNIT PACKAGE: 10



20605

(75397-48030)
Orange Nylon

Moulding Clip with Sealer
Head Size: 15mm x 20mm
Stem Length: 15mm
Lexus 1999 - On

UNIT PACKAGE: 10



22127

(Lexus: 81496-50010)
Green Nylon

Rear Lamp Moulding Clip with Sealer
Top Head Diameter: 13mm
Bottom Head Diameter: 20mm
Stem Length: 10mm
Lexus GS 350, GS 450h, LS 460, LS 460 L,
LS 600h L, RX 350 & RX 450h 2007 - On

UNIT PACKAGE: 15



1990
(75395-33030)
Pink Nylon
Moulding Clip
ES300 & RX300 1999 - On
UNIT PACKAGE: 15



20877
(75392-60030,
75392-60031)
Gray Nylon
Rocker Panel Moulding Clip
Head Diameter: 18mm
Overall Length: 19mm
Lexus 2000 - On
UNIT PACKAGE: 15



21847
(Toyota: 90467-08195)
White Nylon
Front & Rear Fender Flare
Moulding Clip with Sealer
Head Size: 15mm x 22mm
Stem Length: 13mm
Overall Length: 21mm
Lexus GX470 2009 - 03
Toyota Land Cruiser 2007 - 1998
UNIT PACKAGE: 25



21846
(Toyota: 90467-08196)
Yellow Nylon
Front & Rear Fender Flare
and Mudguard Moulding Clip with Sealer
Head Size: 16mm x 22mm
Stem Length: 19mm
Overall Length: 27mm
Lexus GX470 2009 - 03
Toyota Land Cruiser 2007 - 1998
UNIT PACKAGE: 25



21314
(75393-60030)
Black Nylon
Moulding Clip
Head Diameter: 18mm
Overall Length: 24.5mm
Lexus 2000 - On
UNIT PACKAGE: 15



20875
(75394-60060)
Yellow Nylon
Fender Moulding Clip with Sealer
Head Diameter: 18mm
Stem Length: 20mm
Lexus 2000 - On
UNIT PACKAGE: 10



20876
(75492-60030)
Gray Nylon
Fender Moulding Clip with Sealer
Head Diameter: 18mm
Stem Length: 20mm
Lexus 2000 - On
UNIT PACKAGE: 10



21848
(Lexus: 90467-12072)
Red Nylon
Rocker Moulding Clip with Sealer
Top Head Size: 11mm x 13mm
Bottom Head Size: 25mm x 25mm
Stem Length: 14mm
Lexus LX470 2007 - 1998
UNIT PACKAGE: 25



21748
(Toyota: 75819-33010)
White Nylon
Moulding Clip with Sealer
Top Head Size: 8mm x 8mm
Bottom Head Diameter: 15mm
Stem Diameter: 10mm
Stem Length: 14mm
Lexus ES300 & ES330 & Scion
and Toyota Camry, Corolla, Prius,
Sequoia, Sienna & Tundra 2002 - On
UNIT PACKAGE: 25



21537
(90467-10190)
Black Nylon
Grille Clip
Top Head Size: 10mm x 10mm
Bottom Head Diameter: 15mm
Stem Diameter: 10mm
Stem Length: 10mm
RX 330, RX 350 & RX 400 1999 - On
UNIT PACKAGE: 25



21697
(Lexus: 90467-12074)
White Nylon
Moulding Clip
Top Head Size: 10mm x 23mm
Bottom Head Diameter: 18mm
Stem Length: 10mm
Lexus LX 470 2007 - 1998
UNIT PACKAGE: 25



21698

(Lexus: 90467-12071)
White Nylon

Moulding Clip
Top Head Diameter: 12mm
Bottom Head Size: 18mm x 26mm
Stem Length: 10mm
Lexus LX 470 2007 - 1998

UNIT PACKAGE: 25



21857

(Toyota: 75392-35220)
White Nylon

Front & Rear Spoiler Moulding Clip
Head Size: 10mm x 20mm
Stem Length: 24mm
Overall Length: 27mm
Lexus HS250 & RX350 and Toyota
Camry, Corolla, FJ Cruiser &
Highlander 2010 - On

UNIT PACKAGE: 25



19120

(75039-33060)
Brown & White
Nylon

Door Lower Moulding Clip
ES300 1991-On

UNIT PACKAGE: 10



19776

(75545-24030)
White Nylon

Windshield Moulding Clip
SC300 & SC400 1992 - On

UNIT PACKAGE: 10



19482

(75039-33010)
Brown & White Nylon

Front Door Outside Moulding Clip
ES300 1991-On

UNIT PACKAGE: 5



21505

(75545-53011)
Blue Nylon

Windshield Moulding Clip
Width: 15mm
Length: 55mm
GX 460, IS250/350, IS F 2006 - On

UNIT PACKAGE: 5



22350

(Toyota: 90467-A0004)
White Nylon

Headliner & Interior Trim Moulding Clip
Top Head Size: 14mm x 20mm
Bottom Head Size: 18mm x 24mm
Stem Diameter: 10mm
Stem Length: 14mm
Lexus RX 350 and Toyota
Avalon & Camry 2005 - On

UNIT PACKAGE: 25



21255

(75545-53010)
Blue Nylon

Windshield Clip
Width: 15mm
Length: 55mm
ES250 & IS250 2008 - On

UNIT PACKAGE: 10



21712

(Toyota: 52535-0E030)
White Nylon

Moulding Clip
Top Head Size: 13mm x 13mm
Stem Length: 22mm
Overall Length: 25mm
Lexus LS 600h & RX 450h and Toyota
RAV4 & 4Runner 2006 - On

UNIT PACKAGE: 15



20738

(53271-44010)
Black Nylon

Headlight Bracket Clip
Width: 25mm
Length: 40.5mm
Lexus IS-300 and Toyota
Camry & RAV4 2001 - On

UNIT PACKAGE: 4



19783

(Ford: N811169-S, W705550-S300;
Toyota: 90075-10801, 90189-06111)
White Nylon

Head Diameter: 13mm
Stem Length: 9mm
Fits into 11mm Hole
Ford, Lexus & Toyota

UNIT PACKAGE: 50



21685

(Lexus: 90189-04207)
Yellow Nylon

Outer Wheel Well & Side Moulding
Screw Grommet
Screw Size: M2.9 (#4)
Head Size: 9mm x 9mm
Stem Length: 14mm
Fits into 7mm x 7mm Hole
Lexus GS300, GS450, LS430,
LS460, SC300 & SC430 1992 - On

UNIT PACKAGE: 25



21151

(90189-04059)
White Nylon

Rocker, Pillar, Floor &
Exterior Trim Screw Grommet
Screw Size: M3.5 (#6)
Head Size: 12mm x 18mm
Stem Length: 7mm

Lexus ES300, ES330, RX330, RX400, SC300, SC400
and Toyota Scion, Avalon & FJ Cruiser 1992 - On

UNIT PACKAGE: 25



21544

(90189-04102)
White Nylon

Screw Grommet with Sealer
Screw Size: M3.2 (#6)
Head Size: 10mm x 10mm
Stem Length: 15mm
Fits into 7mm Square Hole
Lexus IS 250, IS 350 & IS F
and Toyota Highlander 2006 - On

UNIT PACKAGE: 25



19742

(90189-06104)
Natural Nylon

Fender Lining Screw Grommet
Screw Size: #12 (M5.5)
Head Diameter: 18mm
Stem Length: 15mm
Fits into 9mm Square Hole
Lexus IS300 and Toyota
Avalon, Camry & Sienna 1997 - On

UNIT PACKAGE: 15



21625

(90189-06145)
Black Nylon

Fender Lining Screw Grommet
Screw Size: M5.5 (#12)
Head Diameter: 16mm
Stem Length: 16mm
Fits into 9mm x 9mm Hole
Lexus CT 200h and Toyota Prius,
Sequoia & T-100 1993 - On

UNIT PACKAGE: 15



21605

(90189-A0002)
Black Nylon

Screw Grommet
Screw Size: M5.5 (#12)
Head Diameter: 20mm
Stem Length: 17mm
Fits into 9mm x 9mm Hole
Lexus GX460, GX470 & LX570 and
Toyota Avalon, Corolla, FJ Cruiser, RAV4,
Sienna, Tacoma & 4-Runner 1995 - On

UNIT PACKAGE: 25



21682

(Lexus: 52197-30040)
White Nylon

Front Bumper Screw
Grommet with Sealer
Screw Size: M5.5 (#12)
Head Size: 22mm x 18mm
Overall Length: 24mm
Lexus CT200h, GS300, 350, 430, 460, GS450h,
HS250h, LS460, 600h, RX350 & RX450h 2006 - On

UNIT PACKAGE: 15



14273

(90189-06005)
White Nylon

Screw Grommet
Screw Size: #14 (1/4") or M6.3-1.81
Head Diameter: 18mm
Stem Length: 16mm
Fits into 8mm x 8mm Hole
Lexus & Toyota

UNIT PACKAGE: 50



14267

(90189-06013)
Black Nylon

Screw Grommet
Screw Size: #14 (1/4") or M6.3-1.81
Head Diameter: 20mm
Stem Length: 17mm
Fits into 8mm x 8mm Hole
Lexus & Toyota

UNIT PACKAGE: 25



22096

(Toyota: 52197-22020)
Black Nylon

Rear Bumper Side Bracket
Screw Grommet with Sealer
Screw Size: M6.3 (#14)
Head Size: 16mm x 18mm
Stem Length: 19mm
Lexus ES 350 & Hs 250h 2012 - 07
Toyota Avalon & Camry 2012 - On

UNIT PACKAGE: 15



21084

(52599-0E010)
Black Nylon

Rear Bumper Grommet with Sealer
Head Diameter: 21mm
Shoulder Diameter: 13mm
Stem Length: 27mm
RX 330, RX 350 & RX 400h 2004 - On

UNIT PACKAGE: 10



20660

(90901-89004)
Yellow Nylon

Bumper Screw Grommet with Sealer
Screw Size: M6.3 (#14)
Head Size: 16.5mm x 18mm
Stem Length: 25mm
Lexus GS300 & GS400 1998 - On

UNIT PACKAGE: 10



21015

(52535-50060, 52535-0E010)
Black Nylon

Front Bumper Screw Grommet
Screw Size: M5.5 - M6 (#12)
Head Size: 17mm x 30mm
Stem Length: 9mm
Lexus IS250, IS350, RX330 & RX350 and
Toyota Camry, Highlander & Tacoma 2001 - On

UNIT PACKAGE: 5



21583

(52535-30150)
White Nylon

Front & Rear Bumper
Screw Grommet
Screw Size: M5.5 (#12)
Head Size: 17.5mm x 30mm
Stem Length: 10mm
Lexus ES300, 330, 350, LS430 & RX300 and Toyota
Avalon, Sequoia & Tundra 1999 - On

UNIT PACKAGE: 25



19534

(90467-10152)
Natural Nylon

Cowl Vent Grommet
Flange Diameter: 18mm
Stem Length: 16mm
Fits into 9mm Hole
Use with Auveco 19535
Lexus ES300, Toyota Camry & Tercel 1995 - On

UNIT PACKAGE: 10



22051

(Toyota: 90467-11117)
White Nylon

Rear Trunk License Plate
Trim Retaining Nut
Screw Size: M3.5 (#6)
Overall Height: 11.5mm
Width at Bottom: 11mm
Lexus & Toyota 2009 - 1998

UNIT PACKAGE: 15



19535

(90467-07126)
Black Nylon

Cowl Vent Pin Retainer
Head Diameter: 16mm
Stem Length: 17mm
Use with Auveco 19534
Lexus ES300, Toyota Camry & Tercel 1995 - On

UNIT PACKAGE: 10



22102

(Toyota: 53271-12040;
53271-12060; 53271-0B010)
Black Nylon

Headlight Bracket Clip
Width: 25mm
Length: 39mm
Overall Height: 33mm
Lexus GX460, GX470, RX 300, RX 330 & RX 350 and
Toyota Corolla, Echo, Highlander, MR2, Prius,
Tacoma, Tercel & 4-Runner 1993 - On

UNIT PACKAGE: 10



20758

(53879-58010)
Black Nylon

Front Fender &
Bumper Cover Clip
Width: 25mm
Length: 34mm
Use with Auveco 20757
Lexus and Toyota 4 Runner,
Highlander, Sienna & Solara 2000 - On

UNIT PACKAGE: 5



21358

(53879-50020)
Black Nylon

Bumper Cover Clip
Width: 35mm
Length: 25mm

Use with Auveco 21357
GS, IS & LS 2007 - On

UNIT PACKAGE: 10



21797

(Toyota: 53879-30040)
Black Nylon

Front Bumper Cover Clip
Width: 32mm
Length: 39mm

Use with Auveco 21357
Lexus CT200h &
HS250h 2010 - On
Toyota Camry 2012 - On

UNIT PACKAGE: 5



20757

(47749-58010)
Black Nylon

Front Fender & Bumper
Cover Pin Retainer
Head Diameter: 15mm
Stem Length: 25mm

Use with Auveco 20758
Lexus and Toyota 4 Runner,
Highlander, Sienna & Solara 2000 - On

UNIT PACKAGE: 10



21357

(47749-50090)
Black Nylon

Bumper Cover Pin Retainer
Head Diameter: 10mm
Stem Length: 24mm

Use with Auveco 21358
GS, IS & LS 2007 - On

UNIT PACKAGE: 15



22073

(Toyota: 76924-47020)
Black Nylon

Moulding Retainer
Head Diameter: 32mm
Stem Length: 12mm
Fits into 22mm Hole

Lexus CT 200h & Toyota Prius 2011 - On

UNIT PACKAGE: 15



22353

(Toyota: 90467-09237)
Red Nylon

Body Side Retainer
Head Diameter: 20mm (with Phillips Drive)
Stem Length: 24mm
Overall Length: 26mm
Lexus GS 200h, GS 350,
GS 450h, IS 250, IS 350, RC 350,
RX 350, RX 450h,

Toyota Camry & Scion iM 2012 - On

UNIT PACKAGE: 25



21693

(Lexus: 90467-05125)
Black Nylon

Front Bumper Bracket Retainer
Head Diameter: 16mm
Stem Diameter: 4.7mm x 4.7mm
Stem Length: 12mm

Lexus GS 300, GS 450h & LS 400 1995 - On

UNIT PACKAGE: 25



20878

(90467-A0008)
Black Nylon

Bumper Cover Retainer
Head Diameter: 19mm
Stem Diameter: 7.5mm
Stem Length: 16mm

Lexus, Toyota & Scion 1995 - On

UNIT PACKAGE: 50



20874

(90467-07049-CO)
Black Nylon

Trim Panel Retainer
Head Diameter: 25mm
Stem Diameter: 7mm
Stem Length: 23mm
Lexus 2000 - On

UNIT PACKAGE: 25



18297

(Toyota: 90467-08004, 90467-08011)
(GM: 94842841, 94849113)
Black Nylon

Hood Seal Retaining Clip
Head Diameter: 13mm
Stem Length: 11mm
Fits into 6mm Hole

Lexus, Toyota, Geo Prizm & Nova 1985 - On

UNIT PACKAGE: 50



21692

(Lexus: 90467-07137)
Black Nylon

Fender Panel Retaining Clip
Head Size: 4.5mm x 11mm
Stem Diameter: 6.5mm
Stem Length: 9mm
Lexus ES 350, GS 300,
GS 450h & IS 250 2006 - On

UNIT PACKAGE: 25



19113

(90467-08124)
Black Nylon

Hood Insulation Retainer
Head Diameter: 25mm
Stem Diameter: 8mm
Stem Length: 12mm
Toyota Supra 1993-On
Lexus 1994-89

UNIT PACKAGE: 15



22212

(Toyota: 53145-60030)
Black Nylon

Front Bumper, Grille & Hood Seal Retaining Clip
Head Size: 4.3mm x 11mm
Stem Diameter: 6.2mm
Stem Length: 10mm
Toyota Avalon, Camry, Highlander, Land Cruiser, Prius
& Venza and Lexus GS 350, GS 450h, IS 250,
IS 350, LX 570, NX 200t, NX 300h, RX 350 & RX 450h
and Scion iQ & tC 2008 - On

UNIT PACKAGE: 100



19729

(90467-09050)
Black Nylon

Hood Insulation Retainer
Head Diameter: 25mm
Stem Length: 10mm
Fits into 7mm Hole
Lexus, Toyota Camry & Solara 1998-On

UNIT PACKAGE: 15



21643

(90467-08101)
Black Nylon

Hood to Cowl Top Seal Retaining Clip
Head Size: 7mm x 13mm
Stem Diameter: 7.5mm
Stem Length: 13mm
Lexus ES 300 and Toyota Camry,
Sequoia, Solara & Tundra 2006 - 1997

UNIT PACKAGE: 25



21627

(67868-30030)
Black Nylon

Door & Roof Rail Retainer
Head Diameter: 9mm
Stem Diameter: 5.3mm
Stem Length: 8mm
Lexus HS 250h, IS 250, IS 350,
RX 350 & 450h 2006 - On
Toyota Camry, Corolla, Corona
& Land Cruiser 1999 - 74

UNIT PACKAGE: 25



17990

(90467-09138)
Black Nylon

Retaining Clip
Head Size: 14mm x 15mm
Stem Length: 19mm
Fits into 7mm Hole
Lexus 1990-On

UNIT PACKAGE: 5



21548

(67869-20030)
Black Nylon

Weatherstrip Retainer
Head Diameter: 10mm
Stem Diameter: 6mm
Stem Length: 10mm
Lexus IS 300 & SC 430 and Toyota Camry, Celica,
Corolla, Highlander, Matrix, MR-2, Prius, RAV-4,
Scion, Solara & Supra 1990 - On

UNIT PACKAGE: 25



21634

(90467-10186)
Black Nylon

Dash & Fender Apron Seal Retainer
Head Diameter: 16.5mm
Stem Diameter: 9mm
Stem Length: 13mm
Lexus GX 460, GX 470 & LX 470 and
Toyota 4 Runner, FJ Cruiser, Land Cruiser,
RAV4, Sequoia & Tundra 1996 - On

UNIT PACKAGE: 25



21694

(Lexus: 67867-50020)
Black Nylon

Weatherstrip Retaining Clip
Top Head Size: 5mm x 14mm
Bottom Head Diameter: 8mm
Stem Diameter: 6.3mm
Stem Length: 5mm
Lexus GS 300 & LS 400 2005 - 1990

UNIT PACKAGE: 25



21552

(90467-04034)
White Nylon

Weatherstrip Retainer
Top Head Size: 5mm x 15mm
Bottom Head Diameter: 9mm
Stem Diameter: 6.5mm
Stem Length: 4mm
Lexus CT 200h, HS 250h, IS F, IS 250,
IS 350, LS 460, LS 600h, RX 350,
RX 400h & RX 450h and Toyota Avalon,
Corolla, Highlander, Matrix, Prius,
RAV-4, Scion & Venza 2003 - On

UNIT PACKAGE: 25



21012

(75867-AA010)
Black Nylon

Rocker Panel &
Scuff Plate Retainer
Top Head Diameter: 13mm
Bottom Head Diameter: 18mm
Stem Diameter: 9.5mm
Stem Length: 14mm
Lexus ES300 & ES330 2002 - On
Toyota Avalon, Camry, Scion
& Solara 2004 - On

UNIT PACKAGE: 15



17991

(90467-06092)
White Nylon

Retaining Clip
Head Size: 8mm x 17mm
Stem Length: 14mm
Fits into 8mm Hole
Lexus 1990-On

UNIT PACKAGE: 10

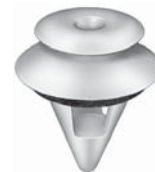

20473

(67771-12070)
White Nylon

Door Panel & Rocker
Moulding Retainer with Sealer
Top Head Diameter: 13mm
Bottom Head Diameter: 18mm
Stem Diameter: 11mm
Stem Length: 14mm
Lexus SC300/400 Toyota Avalon & Corolla 1992 - On

UNIT PACKAGE: 15



22103

(Toyota: 53857-47011)
Black Nylon

Front Fender
Retainer with Sealer
Head Diameter: 20mm
Stem Diameter: 9mm
Stem Length: 9mm
Lexus CT 200h and Toyota Camry, Prius,
RAV4, Yaris & 4-Runner 2010 - On

UNIT PACKAGE: 15



22334

(Toyota: 53857-0E010)
Black Nylon

Front Fender Retainer with Sealer
Top Head Diameter: 20mm
Bottom Head Diameter: 18mm
Stem Diameter: 12mm
Stem Length: 15mm
Overall Height: 31.5mm
Toyota Highlander 2015 - On

UNIT PACKAGE: 10



22056

(Toyota: 75867-30130)
White Nylon

Rocker Moulding Retainer with Sealer
Top Head Diameter: 13mm
Bottom Head Diameter: 18mm
Stem Diameter: 8.5mm x 8.5mm
Stem Length: 13mm
Lexus CT 200h, ES 300h, ES 350, GS 300, GS 350,
GS 430, GS 460, GS 450h, HS 250h, IS 250,
IS 350, IS F, LS 460, LS 600h & LX 570 and
Toyota Land Cruiser 2006 - On

UNIT PACKAGE: 25



22335

(Toyota: 52599-48020)
Black Nylon

Rear Bumper Retainer with Sealer
& Stainless Steel Screw
Head Diameter: 22mm
(with Black Finish Stainless
Steel Tapping Screw)
Shoulder Diameter: 13mm
Stem Length: 27mm
Toyota Highlander 2007 - 01
Venza 2009 - On

UNIT PACKAGE: 5



21795

(Toyota: 67773-0E020)
White Nylon

Door Panel Retainer with Sealer
Top Head Diameter: 13mm
Bottom Head (Including Sealer)
Diameter: 18mm
Overall Length: 20mm
Fits into 8.5mm Hole
Lexus RX350 2009 and
Toyota Camry 2012 - On

UNIT PACKAGE: 25



20575

(67771-12080)
Yellow & White Nylon

Door Panel & Rocker Moulding Retainer
Top Head Diameter: 13mm
Middle Head Diameter: 16mm
Bottom Head Diameter: 18mm
Stem Diameter: 10mm
Stem Length: 13mm
Overall Length: 20mm
Toyota & Lexus 1998 - On

UNIT PACKAGE: 15



22132

(Toyota: 53813-48011)
Gray Nylon

Front Fender
Retainer with Sealer
Top Head Diameter: 20mm
Bottom Head Diameter: 22mm
Stem Length: 11mm
Fits into 10mm Hole
Lexus HS 250h, RX 350 & RX 450h and
Toyota Prius & Sienna 2010 - On

UNIT PACKAGE: 10



20559

(GM: 88970345;
Toyota: 90467-10167)
Blue Nylon

Garnish Moulding Retainer
Top Head Diameter: 13mm
Middle Head Diameter: 16mm
Bottom Head Diameter: 18mm
Stem Diameter: 9mm x 9mm
Stem Length: 11mm
Overall Length: 18mm
Pontiac Vibe, Lexus and Toyota 2000 - On

UNIT PACKAGE: 25



21686

(Toyota: 67771-32120)
Green Nylon

Trim Panel Retainer with Sealer
Top Head Size: 13mm x 16mm
Middle Head Diameter: 16mm
Bottom Head Diameter: 18mm
Stem Diameter: 9mm
Stem Length: 9mm
Overall Length: 16.5mm
Lexus ES 300, GS 300, GS 450h,
IS F, IS 250, LS 460, LS 600hl, RX 350,
Scion XA and Toyota Prius 2001 - On

UNIT PACKAGE: 25



21102

(90467-A0005)
White Nylon

Door Trim Panel Retainer with Sealer
Top Head Diameter: 13mm
Middle Head Diameter: 16mm
Bottom Head Diameter: 18mm
Stem Diameter: 8.5mm
Stem Length: 14mm
Lexus ES 350, GX 470, IS 250, IS 350, IS F, LS 460 &
LS 600HL and Toyota Camry, FJ Cruiser, Highlander,
RAV4 & 4-Runner 2001 - On

UNIT PACKAGE: 15



20558

(62217-13010)
White Nylon

Garnish Moulding Retainer
Top Head Diameter: 13mm
Middle Head Diameter: 16mm
Bottom Head Diameter: 15mm
Stem Diameter: 10mm
Stem Length: 11mm
Lexus and Toyota Corolla,
Matrix & 4 Runner 2003 - On

UNIT PACKAGE: 25



19257

(67771-12050)
Nylon

Front & Rear Door
Trim Board Retainer
Top Head Diameter: 13mm
Bottom Head Diameter: 18mm
Stem Diameter: 9mm
Stem Length: 14mm
Lexus and Toyota Celica, Corolla &
Previa 1990-On

UNIT PACKAGE: 15



22125

(Toyota: 90467-05170)
Black Nylon

Front Bumper Push-Type Retainer
Head Diameter: 10mm
Stem Length: 10mm
Fits into 5mm Hole

Lexus IS 250, IS 350 & NX 300h and Toyota Corolla,
Highlander, Matrix & RAV4 2012 - On

UNIT PACKAGE: 25



21849

(Toyota: 90467-05136)
Black Nylon

Inner Door Lock Plate, Engine Cover &
Outside Air Duct Push-Type Retainer

Head Diameter: 13mm
Stem Length: 15mm
Fits into 5.5mm Hole
Lexus & Toyota 2012 - On

UNIT PACKAGE: 25



17439

(90467-09093)
Black Nylon

Bumper Cover
Push-Type Retainer
Head Diameter: 15mm
Stem Length: 27mm
Fits into 9mm Hole
LS-400

UNIT PACKAGE: 10



21624

(90467-10206)
Black Nylon

Cowl Push-Type Retainer
Head Diameter: 16mm
Stem Length: 10mm
Fits into 8mm Hole
Lexus ES 350, RX 350 &
RX 450h and Toyota Camry,
Sequoia, Tundra & Yaris 2006 - On

UNIT PACKAGE: 15



18939

(90467-09101)
Black Nylon

Bumper Cover
Push-Type Retainer
Head Diameter: 18mm
Stem Length: 23mm
Fits into 9mm Hole
ES300 1993-On

UNIT PACKAGE: 25



17988

(90467-09143)
Black Nylon

Push-Type Retainer
Head Diameter: 19mm
Stem Length: 26mm
Fits into 9mm Hole
Lexus 1990-On

UNIT PACKAGE: 10



20577

(GM: 88970494;
Toyota: 90467-07168)
Black Nylon

Rocker Panel & Garnish Moulding
Push-Type Retainer

Head Diameter: 20mm
Stem Length: 8mm
Fits into 7mm Hole

Pontiac Vibe 2004 - 2003
Lexus & Toyota 2000 - On

UNIT PACKAGE: 15



17992

(90467-07138)
Black Nylon

Push-Type Retainer
Head Diameter: 20mm
Stem Length: 12mm
Fits into 7mm Hole
Lexus 1990-On

UNIT PACKAGE: 10



19219

(90467-09096)
Black Nylon

Front Bumper
Push-Type Retainer
Head Diameter: 15mm
Stem Length: 27mm
Fits into 9mm Hole
LS400 1993-On

Toyota Celica & Supra 1989-On

UNIT PACKAGE: 10



18270

(90467-07117)
Black Nylon

Push-Type Retainer
Head Diameter: 17mm
Stem Length: 9mm
Fits into 7mm Hole
Lexus 1990-On

UNIT PACKAGE: 10



20869

(GM: 88970767;
Toyota: 90467-10183)
Black Nylon

Front Fender Liner Push-Type Retainer
Head Diameter: 18mm
Stem Length: 7.5mm
Fits into 7mm Hole
Lexus, Pontiac Vibe, and Toyota Celica,
Corolla, Matrix & Solara 1999 - On

UNIT PACKAGE: 10



20349

(Toyota: 90467-08185;
Nissan: 01553-09611)
Black Nylon

Push-Type Retainer
Head Diameter: 18mm
Stem Length: 10mm (Excluding the Pin)
Fits into 8mm Hole
Lexus & Toyota 2002 - On
Nissan 1994 - On

UNIT PACKAGE: 15



21547

(90467-09185)
Black Nylon

Front Spoiler & Grille Push-Type Retainer
Head Diameter: 18mm
Stem Length: 10mm
Fits into 9mm Hole
Lexus HS 250h and Toyota Celica,
Sequoia, Sienna & 4-Runner 1994 - On

UNIT PACKAGE: 25



21702

(Toyota: 90467-10170-C0)
Black Nylon

Cowl Vent, Upper Radiator Cover &
Wheel Apron Push-Type Retainer
Head Diameter: 18mm
Stem Length: 12mm
Fits into 10mm Hole
Lexus LS 460, LS 600, RX 350
& RX 450 and Toyota RAV4 2006 - On

UNIT PACKAGE: 10



21201

(90467-07211)
Black Nylon

Bumper, Radiator Cover & Grille
Push-Type Retainer
Head Diameter: 19mm
Stem Length: 8mm
Fits into 7mm Hole
Lexus IS & LS, Scion and Toyota
Avalon, Camry & Highlander 2005 - On

UNIT PACKAGE: 10



21525

(53259-0E010)
Black Nylon

Front Inner Structure Push-Type Retainer
Head Diameter: 19mm
Stem Length: 9mm
Fits into 7mm Hole
Lexus EX 350, IS 250, IS 350,
RX 330 RX350 & RX 400h 2004 - On

UNIT PACKAGE: 15



20955

(90467-07201)
Black Nylon

Engine Under Cover
Push-Type Retainer
Head Diameter: 20mm
Stem Length: 10mm
Fits into 7mm Hole
Lexus ES300/330 and
Toyota Avalon, Camry &
Solara 2002 - On

UNIT PACKAGE: 10



21856

(Toyota: 51454-48010,
51454-0E010)
Black Nylon

Front Bumper Extension Mounting
Bracket Push-Type Retainer
Head Diameter: 20mm
Stem Length: 12mm
Fits into 10mm Hole

Lexus IS CV, F, RX330 & RX400 Hybrid 2006 - On
Toyota Highlander, Sienna & Venza 2009 - On

UNIT PACKAGE: 15



21596

(75867-06030)
Black Nylon

Rocker Panel Push-Type Retainer
Head Diameter: 20mm
Stem Length: 16mm
Fits into 8mm Hole
Toyota & Lexus 2007 - On

UNIT PACKAGE: 25



21860

(Toyota: 51453-48010,
51453-0E010)
Black Nylon

Front Side Lower Fender Panel
Bracket Push-Type Retainer
Head Diameter: 22mm
Stem Length: 14mm
Fits into 13mm Hole
Lexus RX330 2009-2004
Toyota Highlander 2010 - On

UNIT PACKAGE: 15



22072

(Toyota: 76923-47010)
Black Nylon

Rocker Moulding
Push-Type Retainer
Head Diameter: 38mm
Stem Length: 32mm
Fits into 22mm Hole
Lexus HS 250h & CT 200h
and Toyota Prius 2010 - On

UNIT PACKAGE: 5



20469

(69293-12030)
Natural Nylon

Door Lock Rod Clip
Rod Size: 5mm
Right (Passenger) Side
Lexus ES 300 2001 - 97

Toyota Camry, Celica, Corolla, Echo, Highlander, MR2,
RAV4, Tundra and 4-Runner 1994 - On

UNIT PACKAGE: 10



20470

(69293-12040)
Yellow Nylon

Door Lock Rod Clip
Rod Size: 5mm
Left (Driver) Side
Lexus ES 300 2001 - 97

Toyota Camry, Celica, Corolla, Echo, Highlander, MR2,
RAV4, Tundra and 4-Runner 1994 - On

UNIT PACKAGE: 10



20534

(69293-12050)
Natural Nylon

Door Lock Rod Clip
Rod Size: 5mm
Fits into 8.5mm Hole
Right (Passenger) Side
Lexus ES250, 300 & RX300
and Toyota Tacoma 1990 - On

UNIT PACKAGE: 10



20535

(69293-12060)
Yellow Nylon

Door Lock Rod Clip
Rod Size: 5mm
Fits into 8.5mm Hole
Left (Driver) Side
Lexus ES250, 300 & RX300
and Toyota Tacoma 1990 - On

UNIT PACKAGE: 10



21336

(69293-30030)
Natural Nylon

Door Lock Rod Clip
Rod Size: 5mm
Fits into 8mm Hole
Overall Height: 20mm
Toyota & Lexus 1993 - On

UNIT PACKAGE: 10



20380

(Not Supplied by O.E.M.)
Black Nylon

Photo not actual size
Cable Strap

Length: 200mm (8")
Max. Bundle Diameter: 44mm (1-3/4")
Fits into 6.3mm (1/4") Hole
Import Cars

UNIT PACKAGE: 25



22097

(Toyota: 90950-01620)
Black Nylon

Hole Plug
Head Diameter: 30mm
Height: 5.6mm

Fits into 22mm Hole
Lexus ES, RX & SC;
Scion iQ, tC, xA, xB & xD
and Toyota Avalon, Camry,
Celica, Corolla, FJ Cruiser,
Highlander, Matrix, Prius, RAV4,
Sequoia, Sienna, Tacoma,
Tundra & Yaris 1984 - On

UNIT PACKAGE: 15



21615

(90467-A0018, 90467-05081)
Maroon Nylon

Left & Right Front Bumper &
Bumper Stay Nylon U-Nut
Screw Size: M6 (#14)
Panel Range: Up to 2mm
Center of Hole to Edge: 12mm
Lexus and Toyota Avalon, Camry & Solara 2000 - On

UNIT PACKAGE: 15

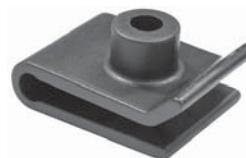

17993

(90179-05060)
Black Nylon

Nylon U-Nut
Screw Size: #10
Width: 18mm Wide
Length: 27mm
Panel Range: Up to 3mm
Center of Hole to Edge: 14mm
Lexus 1990-On

UNIT PACKAGE: 10



21359
(53879-17020)
Black Nylon

Bumper & Fender Apron
Nylon U-Nut

Screw Size: M4.8 (#10)
Panel Range: Up to 2mm

Center of Hole to Edge: 10mm

Lexus GS, IS, LS & SC and Toyota Celica 2000 - On

UNIT PACKAGE: 10



20956
(90467-05114)
Black Nylon

Bumper & Fender Apron
Nylon U-Nut

Screw Size: M5.5 (#12)

Width: 20mm

Length: 36mm

Panel Range: Up to 1mm

Center of Hole to Edge: 14mm

Lexus & Toyota 2000 - On

UNIT PACKAGE: 10



21687
(Toyota: 90467-05138)
Black Nylon

Front Bumper &
Fender Liner Nylon U-Nut

Screw Size: M6.3 (#14)

Panel Range: Up to 3mm

Center of Hole to Edge: 14mm

Lexus GX 460, GX 470 & LX 570, Scion tC and Toyota
Corolla, FJ Cruiser, Land Cruiser, Matrix, Sequoia,
Tacoma, Tundra & 4 Runner 2003 - On

UNIT PACKAGE: 15

MAZDA CLIPS & FASTENERS



20936
(Mazda: 9XG0-73-88X0;
Ford: W707388-S300)
Black Nylon

Front Bumper Cover Moulding Clip

Bottom Head Size: 18mm x 20mm

Stem Length: 10mm

Fits into 8mm x 12mm Hole

Mazda Tribute 2006 - 2001

Ford Escape 2001 - On

UNIT PACKAGE: 10



21561
(E11451W24)
White Nylon

Moulding Clip

Top Head Size: 10mm x 15mm

Bottom Head Diameter: 17mm

Stem Diameter: 13mm

Stem Length: 9mm

CX-7 2007 - On

UNIT PACKAGE: 25



19228
(NA01-50-101A)
Nylon

Bumper Clip
Miata 1992-On

UNIT PACKAGE: 10



18882
(Ford: KA80-51-PR6;
Mazda: EA01-50-048)
Black Nylon

Body Side Lower
Wide Moulding Grommet

Ford Probe &

Mazda MX6 1993-On

UNIT PACKAGE: 10

All items available in bulk quantities.

Call customer service 1-800-354-9816 for a price quote



19450

(T001-50-M48B)
Natural Nylon

Rear Door Garnish Clip
Millenia 1995 - On

UNIT PACKAGE: 25



21171

(BP4L-51-SJ3)
Gray Nylon

Photos not actual size



Moulding Clip with Sealer
Top Head Size: 14mm x 20mm
Bottom Head Diameter: 36.5mm
Stem Length: 10mm
3, 5, 6, CX-7, CX-9 &
RX-8 2004 - On

UNIT PACKAGE: 10



14719

(H001-50-609)
Nylon

Windshield Moulding Clip
Width: 25mm
Length: 10mm

UNIT PACKAGE: 25



12591

(1243-50-609)
Nylon

Windshield Moulding Clip
Width: 28.5mm
Clip Length: 14.5mm
Arm Length: 22.5mm

UNIT PACKAGE: 25



19648

(HG30-50-6B9A)
Brown Nylon

Windshield Clip
Width: 13mm
Length: 49mm
Height: 11mm
929 & Millenia 1992 - On

UNIT PACKAGE: 10



20958

(GJ6A-68-162)
White Nylon

Windshield Garnish
Moulding Retainer
Top Head Size: 10mm x 13mm
Bottom Head Diameter: 16mm
Stem Length: 33mm
Fits into 10mm Hole
3,5 & RX8 2004 - On

UNIT PACKAGE: 10



20960

(GM9E-63-938A)
White Nylon

Windshield Moulding Clip
Head Size: 17mm x 20mm
Stem Length: 21mm
Fits into 8mm Hole
Mazda 6 2003 - On

UNIT PACKAGE: 10



20957

(G6JA-50-0Z5)
Natural Nylon

Front Bumper
Screw Grommet
Screw Size: M4.2 (#8)
Head Size: 23mm x 24mm
Stem Length: 14mm
Miata, MPV, RX8 3, 5 & 6 2000 - On

UNIT PACKAGE: 15



20984

(BC1M-50-0Z5)
Natural Nylon

Front Bumper
Screw Grommet
Screw Size: M4.2 (#8)
Head Size: 24mm x 28mm
Stem Length: 14mm
323, 626, Miata MPV &
Protégé 1995 - On

UNIT PACKAGE: 10



19831

(LA01-50-6A8A)
White Nylon

Window Screw Grommet
with Sealer Gasket
Screw Size: #6
MPV 1998 - On

UNIT PACKAGE: 10



13930

(Nissan: 96706-B0700;
Mazda: 9991-00-412)
Natural Nylon

Screw Size: #8
Width: 9.5mm
Length: 9.5mm
Snaps into 7mm x 7mm Hole

UNIT PACKAGE: 50



14255

(Mitsubishi: MS-480001;
Honda: 75522-611-000;
Mazda: 9991-00-412)
Black Nylon

Screw Size: #8
Width: 9.5mm
Length: 9.5mm
Snaps into 7mm x 7mm Hole

UNIT PACKAGE: 50



14274

(Mazda: 9991-00-601;
Honda: 75521-611-000;
Nissan: 96706-P0105;
Toyota: 90189-06010)
Natural Nylon

Screw Size: #10
Width: 13mm
Length: 13mm
Snaps into 8.5mm x 8.5mm Hole

UNIT PACKAGE: 25



14357

(9991-00-501)
Natural Nylon

Screw Size: #10
Width: 12mm
Length: 12mm
Snaps into 8mm x 8mm Hole

UNIT PACKAGE: 25



14313

(Mazda: 9991-00-503)
Honda: 90662-671-003;
Nissan: 62698-V7000, 68425-H5000)
Natural Nylon

Screw Size: #10
Width: 17mm
Length: 17mm
Snaps into 8mm x 8.5mm Hole

UNIT PACKAGE: 25



14364

(9991-00-403)
Natural Nylon

Screw Size: #8
Head Diameter: 13mm
Fits into 7mm x 7mm Hole

UNIT PACKAGE: 25



14366

(9991-00-402)
Natural Nylon

Screw Grommet
Screw Size: #6
Width: 9.5mm
Length: 9.5mm
Stem Length: 16mm
Fits into 7mm x 7mm Hole
Also for Nissan/Datsun

UNIT PACKAGE: 50



14695

(Mazda: H001-50-841;
Honda: 90661-SC7-003;
Mitsubishi: MS-480012;
Nissan: 01651-00481, 74798-S9000;
Toyota: 90189-06042)
White Nylon

Screw Grommet
Screw Size: #8
Head Diameter: 16mm
Stem Length: 17mm
Fits into 8mm x 8mm Hole

UNIT PACKAGE: 25



21413

(GS3L-68-615)
Black Nylon

Cowl Trim Grommet
Head Diameter: 25mm
Stem Length: 22mm
6 GT 2010 - On

UNIT PACKAGE: 10



20579
(FD02-50-798)
Black Nylon

Cowl Vent Grommet with Sealer
Screw Size: M4.2 (#8)
Head Size: 12mm x 22mm
Stem Length: 13mm
323, 626, Millenia & MX6 1995 - On

UNIT PACKAGE: 10



19753
(GA2A-56-399A)
Black Nylon

Front Fender
Plate Seal Clip
Head Diameter: 18mm
Stem Length: 26mm
626 1998 - On

UNIT PACKAGE: 10



19748
(KA78-50-AF4)
Black Nylon

Splash Shield Screw Grommet
Screw Size: #12 (M5.5)
Head Diameter: 18mm x 20mm
Stem Length: 15mm
626 1998 - On



UNIT PACKAGE: 10



17451
(H001-68-719B)
Natural Nylon

Rocker Scuff Plate Retainer
Ford Probe and
Mazda MX6 1988-On

UNIT PACKAGE: 25



21743
(Mazda: GJ6A-58-975)
White Nylon

Screw Grommet with Sealer
Screw Size: M4.2 (#8)
Head Diameter: 20mm
Stem Length: 15mm
RX-8 2010 - 04



UNIT PACKAGE: 10



19138
(Ford: F1CZ-5802316A;
Mazda: BW0A-50-792)
Gray Nylon

Cowl Top Vent Grille Retainer
Ford Escort & Tracer
and Mazda 1991 - On

UNIT PACKAGE: 15



22064
(Mazda: H260-50-6K8)
White Nylon

Screw Grommet
with Sealer
Screw Size: M4.2-1.41 (#8)
Head Size: 16mm x 22mm
Stem Length: 20mm
Mazda MPV, MX-6, RX-8, 3, 6 & 626
2010 - 1988

UNIT PACKAGE: 15



17551
(GJ21-50-H81)
Natural Nylon

Cowl Screen Grommet
Ford Probe and
Mazda 626 & MX6 1988-On

UNIT PACKAGE: 25



19743
(GJ21-58-502A)
Natural Nylon

Window Moulding
Screw Grommet
Screw Size: #12 (M5.5)
Width: 18mm
Length: 22mm
Snaps into 11mm Hole
626 1998-On

UNIT PACKAGE: 15



17552
(GJ21-50-H82)
Natural Nylon

Cowl Screen Grommet
Ford Probe and
Mazda 626 & MX6 1988-On

UNIT PACKAGE: 25



17553

(KA01-50-H16)
Green Nylon

Rear Hatch Grommet
Use with Auveco 17554

Ford Probe and
Mazda MX 6 1988-On

UNIT PACKAGE: 25



18458

(Ford: F1CZ-16774-A;
Mazda: B455-56-741)
Black Nylon

Hood Insulation Retaining Clip
Head Diameter: 14mm

Stem Length: 10mm

Fits into 6mm Hole

Ford Probe & Mazda MX6 1992-88

UNIT PACKAGE: 25



17554

(KA01-50-H15A)
Black Nylon

Rear Hatch Retainer

Use with Auveco 17553
Ford Probe and Mazda MX6 1988-On

UNIT PACKAGE: 25



14349

(Mazda: 9926-40-543;
Nissan: 01553-00291)
Black Nylon

Retaining Clip

Head Diameter: 11mm

Stem Length: 15mm

Panel Thickness: 5mm

Fits into 5.5mm Hole

UNIT PACKAGE: 50



14367

(9924-90-512B)
Black Nylon

Retainer

Head Diameter: 12mm

Stem Length: 10mm

Panel Thickness: 2mm

Snaps into 4mm Hole

UNIT PACKAGE: 50



18271

(9926-40-531B)
Black Nylon

Hood Insulation Retainer

Head Diameter: 14mm

Stem Diameter: 6mm

Stem Length: 15mm

UNIT PACKAGE: 25



21307

(BP4K-58-762)
Black Nylon

Weatherstrip Retaining Clip

Head Diameter: 9mm

Stem Diameter: 5.5mm

Stem Length: 7mm

Mazda 2007 - On

UNIT PACKAGE: 25



17453

(B003-68-865-96)
Gray Nylon

Rear Compartment

Interior Trim Retainer

Head Diameter: 15mm

Stem Length: 14mm

Stem Diameter: 6.5mm

Ford Probe and Mazda MX6 1988-On

UNIT PACKAGE: 50



21520

(J001-56-741)
Black Nylon

Weatherstrip Retaining Clip

Head Diameter: 14mm

Stem Diameter: 6.5mm

Stem Length: 10mm

CX-7, Millenia, MPV, 3, 6 & 626 1995 - On

UNIT PACKAGE: 25



21755

(Mazda: B003-68-865-00)
Black Nylon

Trim Panel Retainer

Head Diameter: 15mm

Stem Diameter: 6.5mm

Stem Length: 14mm

MPV 1998 - 89

UNIT PACKAGE: 50



16777
(Mazda: B001-68-302-00;
Toyota: 90950-01248)
Black Nylon

Retaining Clip
Head Diameter: 15mm
Stem Length: 15mm
Panel Thickness: 2mm
Fits into 8mm Hole

UNIT PACKAGE: 25



14380
(8133-50-022)
Black Nylon

Retaining Clip
Head Diameter: 18mm
Stem Length: 18mm
Panel Thickness: 7mm
Snaps into 8mm Hole

UNIT PACKAGE: 25



14709
(Mazda: G030-68-885-B-38;
Ford: F22Z-16774-A, GA2A-56694)
Black Nylon

Hood Insulation Retainer
Head Diameter: 20mm
Stem Length: 9mm
Fits into 6mm Hole

UNIT PACKAGE: 25



21661
(TD11-56-694)
Black Nylon

Hood Insulation Retainer
Head Diameter: 20mm
Stem Diameter: 7mm
Stem Length: 10mm
3, 5, 6, CX7, CX9, MX-5 Miata & RX8 2004 - On

UNIT PACKAGE: 25



21560
(G032-68-865A-00)
Black Nylon

Trunk & Carpet Retainer
Head Diameter: 20mm
Stem Diameter: 7mm
Stem Length: 15mm
B2000, B2600, CX-7, CX-9,
Miata, Millenia, MX-3, MX-5,
MX-6, Protege, RX-7, RX-8,
3, 5, 6, 626 & 929 1987 - On

UNIT PACKAGE: 25



18692
(Mazda: G031-58-762;
Toyota: 67867-89103,
97868-89101)
Natural Nylon

Weatherstrip Retainer
Head Size: 5mm x 15mm
Stem Length: 10mm
Fits into 5mm Hole
Toyota 4-Runner 1989-83
Mazda 1996-On

UNIT PACKAGE: 50



20932
(G18K-51-SJ3)
White Nylon

Door Trim Panel
Retainer with Sealer
Top Head Diameter: 14mm
Bottom Head Diameter: 18mm
Stem Diameter: 12mm
Stem Length: 14mm
3, 5, 6, CX-7 Miata &
Protégé 2001 - On

UNIT PACKAGE: 10



21678
(Mazda: NE51-51-SJ3A)
Black Nylon

Moulding Retainer with Sealer
Top Head Diameter: 14mm
Bottom Head Diameter: 18.5mm
Stem Diameter: 12mm
Stem Length: 14mm
CX-9 & Miata 2006 - On

UNIT PACKAGE: 10



20983
(GJ6R-68-ABX)
White Nylon

Trim Panel
Retainer with Sealer
Top Head Diameter: 13mm
Middle Head Diameter: 16mm
Bottom Head Diameter: 18mm
Stem Diameter: 9mm
Stem Length: 13mm
3, 5, 6, Miata &
RX-8 2003 - On

UNIT PACKAGE: 15



14269

(Mazda: 9927-40-825;
Isuzu: 8942264920;
Toyota: 67771-01010, 67771-12010)
White Nylon

Door Panel Retainer
Top Head Diameter: 13mm
Middle Head Diameter: 15.5mm
Bottom Head Diameter: 18mm
Stem Diameter: 9.5mm
Stem Length: 14mm
Overall Length: 20.5mm

UNIT PACKAGE: 25



16778

(Mazda: 9927-40-822;
Toyota: 62581-14020)
Natural Nylon

Trim Panel Retainer
Top Head Diameter: 14mm
Bottom Head Diameter: 18mm
Stem Length: 14mm
Fits into 8mm Hole

UNIT PACKAGE: 25



18824

(G350-68-AB1)
White Nylon

Trim Panel Retainer
Top Head Diameter: 13mm
Middle Head Diameter: 16mm
Bottom Head Diameter: 15mm
Stem Length: 9.5mm
Fits into 9mm Hole
626, MX6, Millenia, MX3, 929,
Protege & MPV and
Ford Probe 1992-On

UNIT PACKAGE: 50



19481

(GA2A-58-762)
Blue Nylon

Weatherstrip Retainer
Head Size: 5mm x 15mm
Stem Length: 8mm
Fits into 6mm Hole
Front & Rear Door and Hood Weatherstrip
626 & Millenia 1995 - On

UNIT PACKAGE: 50



21663

(EA01-50-037)
Black Nylon

Push-Type Retainer
Head Diameter: 10mm
Stem Length: 9mm
Fits into 5mm Hole
2, 3, CX7, CX9, MX-3,
MX-5 Miata & RX8 1992 - On

UNIT PACKAGE: 15



21412

(TD12-51-SJ3A)
Gray Nylon

Rocker Moulding
Retainer with Sealer
Top Head Diameter: 14mm
Bottom Head Diameter: 18.5mm
Stem Diameter: 12mm
Stem Length: 13mm
6 GT 2010 - On

UNIT PACKAGE: 15



21662

(S51S-51-833)
Black Nylon

Push-Type Retainer
Head Diameter: 11mm
Stem Length: 11mm
Fits into 7mm Hole
3, MX-5 Miata & RX8 2004 - On

UNIT PACKAGE: 15



14363

(9927-40-821)
Nylon

Door Panel Retainer
Bottom Head Diameter: 17mm
Stem Length: 14mm
Overall Length: 20mm
Fits into 8mm Hole

UNIT PACKAGE: 25



21769

(Mazda: G14S-50-EA1)
Black Nylon

Push-Type Retainer
Head Diameter: 13mm
Stem Length: 13mm
Fits into 8mm Hole
CX7 & Miata 2004 - On

UNIT PACKAGE: 25



14697

(Mazda: N304-13-356-A;
GM: 94198687;
Honda: 90657-SA6-0030)
Black Nylon



Push-Type Retainer
Head Diameter: 14mm
Stem Length: 11mm
Fits into 7mm Hole

UNIT PACKAGE: 25



17478

(B101-68-252-00)
Black Nylon

Interior Trim
Push-Type Retainer
Head Diameter: 14mm
Stem Length: 16mm
Fits into 6mm Hole
Ford Probe and Mazda MX6 1988 - On

UNIT PACKAGE: 25



20923

(Ford: 3M8Z-1502316-A;
Mazda: GJ6E-50-715A)
Black Nylon

Cowl Vent Push-Type Retainer
Head Size: 8.5mm x 12mm
Stem Length: 9mm
Fits into 5mm Hole
Ford Fusion, Milan & Zephyr 2006 - On
Mazda 5 & 6 2003 - On

UNIT PACKAGE: 15



14260

(Mazda: 9926-50-625;
Toyota: 90467-06017)
Black Nylon

Push-Type Retainer
Head Diameter: 15mm
Stem Length: 12mm
Fits into 7mm Hole

UNIT PACKAGE: 15



19306

(GA5R-56-392)
Black Nylon

Shroud Seal Board Push-Type Retainer
Head Diameter: 16mm
Stem Length: 12mm
Fits into 6mm Hole
626 1994-On

UNIT PACKAGE: 10



20465

(UB39-45-919)
Black Nylon

Front & Rear Fender Push-Type Retainer
Head Diameter: 18mm
Stem Length: 9mm
Fits into 8mm Hole
626 2000 - On

UNIT PACKAGE: 10



21024

(Ford: 5R3Z-54310D12-AAA,
6E5Z-7850980-AAA;
Mazda: GJ21-68-885B-02)
Black Nylon

Trim Panel Push-Type Retainer
Head Diameter: 18mm
Stem Length: 10mm
Fits into 6mm Hole
Ford Fusion & Mustang 2005 - On
Mazda 1992 - On

UNIT PACKAGE: 15



21858

(Mazda: B467-68-AC3-02)
Black Nylon

Rear Trunk Liner Push-Type Retainer
Head Diameter: 18mm
Stem Length: 14mm
Fits into 6mm Hole
5, CX-7, CX-9, Miata, Millenia,
MX-6, RX-7 & Protégé 1993 - On

UNIT PACKAGE: 25



19747

(UB39-50-795)
Black Nylon

Stone Guard Push-Type Retainer
Head Diameter: 18mm
Stem Length: 10mm
Fits into 8mm Hole
MPV 1998-On

UNIT PACKAGE: 10



17632

(Mazda: B092-51-833;
Ford: MB-455-56143, W705845-S300;
Hyundai: 86590-28000)
Black Nylon

Push-Type Retainer
Head Diameter: 18mm
Stem Length: 12mm
Fits into 8mm Hole
Mazda, Hyundai & Ford Aspire

UNIT PACKAGE: 10



18206

(GJ21-68885B-69)
Gray Nylon

Push-Type Retainer
Head Diameter: 18mm
Stem Length: 12mm
Fits into 6mm Hole
Ford Probe & Mazda MX6 1989-On

UNIT PACKAGE: 25



14369

(1395-68-676, 9926-50-635)
Black Nylon

Push-Type Retainer
Head Diameter: 20mm
Stem Length: 9mm
Fits into 6mm Hole

UNIT PACKAGE: 15



21110

(B100-68-8550)
Black Nylon

Rear Light Access Door
Push-Type Retainer
Head Diameter: 18mm
Stem Length: 12mm
Fits into 8.5mm Hole
323 1986 - On

UNIT PACKAGE: 15



16000

(Honda: 90675-SB3-003;
Mazda: FB01-56-964;
Nissan: 63876-95596)
Black Nylon

Push-Type Retainer
Head Diameter: 20mm
Stem Length: 9mm
Fits into 8mm Hole

UNIT PACKAGE: 25



19416

(Toyota: 90467-09139)
Black Nylon

Bumper Cover & Wheel Housing
Push-Type Retainer
Head Diameter: 18mm
Stem Length: 15mm
Fits into 9mm Hole
Honda, Mazda 626 &
Toyota Corolla 1992-On

UNIT PACKAGE: 15



19315

(BC1D-56-145)
Black Nylon

Mud Guard Push-Type Retainer
Head Diameter: 20mm
Stem Length: 9mm (Excluding the Pin)
Fits into 8mm Hole
Protege 1996-On

UNIT PACKAGE: 15



22049

(Mazda: B27K-51-PS7)
Black Nylon

Headlight Bracket Push-Type Retainer
Head Diameter: 18mm
Stem Length: 20mm
Fits into 9mm Hole
Mazda 3, CX-7, CX-9, Miata, MPV & RX-8
2000 - On

UNIT PACKAGE: 15



21192

(Nissan: 01553-05323)
(Mazda: L33X13209)
Black Nylon

Cowl, Bumper & Fender Liner
Push-Type Retainer
Head Diameter: 20mm
Stem Length: 12mm
Fits into 8mm Hole
Infiniti FX35, FX45, G35 and Nissan 2003 - On
Mazda 2, 3, 5, 6, CX-5, CX-7 & CX-9 2007 - On

UNIT PACKAGE: 10



20755

(GD7A-50-EA1)
Black Nylon

Bumper Cover & Grille Push-Type Retainer
Head Diameter: 19.5mm
Stem Length: 15mm
Fits into 10mm Hole
Mazda 1999 - On

UNIT PACKAGE: 10



16858

(Mazda: NA01-56-145;
Kia: MNA01-56-145;
Nissan: 63844-01A00;
Ford: MNA01-56145, NA01-56145)
Black Nylon

Inner Fender Push-Type Retainer
Head Diameter: 20mm (25/32")
Stem Length: 18mm (23/32")
Fits into 8mm (5/16") Hole
Mazda, Kia, Ford & Nissan

UNIT PACKAGE: 25



21119

(B100-68-675-69)
Black Nylon

Push-Type Retainer
Head Diameter: 20mm
Stem Length: 19mm
Fits into 6mm Hole
Mazda MX6 and Ford Probe 1988 - On

UNIT PACKAGE: 15



22282

(Mazda: FD01-68-AC3)
Gray Nylon

Bumper Filler & Door Panel
Push-Type Retainer
Head Diameter: 22mm
Stem Length: 25mm
Fits into 8mm Hole
Mazda 2, 3, 5, 6,
CX-5, CX-7 & CX-9 2004 - On

UNIT PACKAGE: 15



17450

(Ford: E8B2-17C756C;
Mazda: BF67-50-235)
Black Nylon

Bumper Cover Retainer
Head Size: 20mm x 30mm
Stem Length: 11mm
Fits into 10mm Hole
Ford Festiva 1988-On
Mazda 323 1986-On

UNIT PACKAGE: 10



15366

(Ford: E7GZ-17A904-B;
Mazda: BF67-50-033)
Nylon

Bumper Retainer
Head Size: 20mm x 30mm
Stem Length: 11mm
Fits into 10mm Hole
Mazda and
Mercury Tracer 1987-On

UNIT PACKAGE: 10



16843

(Mazda: BF82-50-233;
Nissan: 01553-01393)
Black Nylon

Bumper Cover Retainer
Head Size: 20mm x 30mm
Stem Length: 18mm
Fits into 10mm Hole

UNIT PACKAGE: 10



17060

(Ford: E92Z-17C756C;
Mazda: GJ21-50-034)
Black Nylon

Bumper Cover Retainer
Head Size: 20mm x 30mm
Stem Length: 20mm
Fits into 10mm Hole
Ford Probe & Mazda MX6 1989-On

UNIT PACKAGE: 10



14378

(9927-70-901)
Nylon

Tube/Cable Routing Clip
For Holding Multiple Cables or Tubes
Diameter: 8mm
Fits into 6mm Hole

UNIT PACKAGE: 25



14359

(9927-80-405)
Nylon

Rod End Clip
Holds 4mm Rods
Snaps into 6mm Hole

UNIT PACKAGE: 25



14365

(9927-80-404)
Nylon

Rod End Clip
Holds 4mm Rods
Snaps into 6mm Hole

UNIT PACKAGE: 25



20153

White

Door Lock Pawl
Right-Hand Side

Mazda Truck and Ford Continental,
Contour, Explorer, Mountaineer, Mystique,
Ranger, Sable & Taurus 1996 - On

UNIT PACKAGE: 1



20195

Pink

Door Lock Pawl
Left-Hand Side

Ford Continental, Contour, Explorer,
Mountaineer, Mystique, Ranger, Sable & Taurus
and Mazda Truck 1996 - On

UNIT PACKAGE: 1

14376

(9928-90-753)
Nylon



Photo not actual size
Releasable Cable Strap
Length: 110mm (4-3/8")
Max. Bundle Diameter: 25mm
Fits into 7mm Hole

UNIT PACKAGE: 15

14298

(Mazda: 9928-91-053;
Honda: 90672-SAO-003)
Nylon



Photo not actual size
Releasable Cable Strap
Overall Length: 140mm (5-1/2")
Max. Bundle Diameter: 30mm
Fits into 7mm Hole

UNIT PACKAGE: 25

21305

(Not Available from O.E.M.)
Natural Nylon



Photo not actual size
Push-Mount Cable Strap
Strap Width: 5mm (3/16")
Overall Length: 156mm (6-1/8")
Snaps into 6.3mm (1/4") Hole
Max. Bundle Diameter: 40mm (1-9/16")
European Makes & Universal

UNIT PACKAGE: 25

20380

(Not Supplied by O.E.M.)
Black Nylon



Photo not actual size
Cable Strap
Width: 5mm (3/16")
Length: 200mm (8")
Max. Bundle Diameter: 44mm (1-3/4")
Fits into 6.3mm (1/4") Hole
Import Cars

UNIT PACKAGE: 25



17003

(Mazda: GJ21-50-049;
Ford: F32Z-17C756-S)

Bumper Cover Retainer
Front & Rear Bumpers
Mazda & Ford 1988 - On

UNIT PACKAGE: 50



21862

(Mazda: B455-56-135)
Gray Nylon

Nylon U-Nut
Screw Size: M4.8 (#10)
Panel Range: Up to 1mm
Center of Hole to Edge: 11mm
2, 3, 5, 6, 323, 626, 929, CX-7, CX-9, Miata,
Millenia, MPV, MX-3, MX-5, Protégé,
RX-7 & RX-8 2014 - 1992

UNIT PACKAGE: 25



14750

(Toyota: 53879-14010-A,
53879-14020, 53879-22030;
GM: 94841226;
Mazda: LA01-56-135)
Black Nylon

Nylon U-Nut Fender/Wheel
Housing Applications
Screw Size: #10
Width: 20mm
Length: 31mm
Panel Range: Up to 1mm
Center of Hole to Edge: 11mm
Toyota, Geo Prizm & Nova and Mazda

UNIT PACKAGE: 15

19669

Same as 14750 except for unit package quantity

UNIT PACKAGE: 25

**Please place orders in
Unit Package quantities,
not based on pieces needed**



20201

(006-988-30-78)
Natural Nylon

Body Side Moulding Clip
Body Style 124 1995 - 86

UNIT PACKAGE: 10



20657

(004-988-76-78, 004-988-77-78)
Black Nylon

Moulding Clip
Width: 11mm
Length: 20mm

UNIT PACKAGE: 15



20202

(201-988-04-78)
Natural Nylon

Body Side Quarter Panel
Moulding Clip
Body Style 201 1995 - 84

UNIT PACKAGE: 10



20897

(002-988-51-81)
Black Nylon

Grille Moulding Clip
Fits into 7mm Hole
CLK320, CLK500 & ML350 2003 - On

UNIT PACKAGE: 10



21464

(001-988-44-81)
White Nylon

Front Fender Moulding Clip
Head Size: 12mm x 16mm
Stem Length: 7mm
Overall Height: 16mm
Mercedes-Benz 2000 - 1994

UNIT PACKAGE: 25



21468

(001-988-60-81)
Yellow Nylon

Front Fender Moulding Clip
Head Size: 12.5mm x 15.5mm
Stem Length: 7mm
Overall Height: 15.5mm
Mercedes-Benz 2000 - 1994

UNIT PACKAGE: 25



21433

(001-988-49-81)
White Nylon

Moulding Clip
Head Size: 16mm x 16mm
Overall Length: 21.5mm
Mercedes-Benz 124 & 201
1995 - 84

UNIT PACKAGE: 25



21466

(001-988-46-81)
White Nylon

Front & Rear Door Moulding Clip
Width: 18.5mm
Length: 25mm
Overall Height: 21.5mm
Mercedes-Benz 1995 - 1987

UNIT PACKAGE: 25

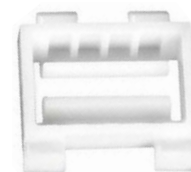

21441

(001-988-50-81)
White Nylon

Moulding Clip
Width: 22.5mm
Length: 23mm
Mercedes-Benz

UNIT PACKAGE: 25



21469

(001-988-63-81)
White Nylon

Quarter Panel Moulding Clip
Width: 19mm
Length: 32mm
Overall Height: 25.5mm
Mercedes-Benz 1995 - 1987

UNIT PACKAGE: 25



21434

(006-988-89-78)
White Nylon

Moulding Clip
Width: 11mm
Length: 45mm
Overall Height: 16mm
Mercedes-Benz 1999 - 92

UNIT PACKAGE: 25



21465
(001-988-80-81)
White Nylon with Rubber Boot

Moulding Clip
Width: 23mm
Length: 32.5mm
Stem Length: 16mm
Mercedes-Benz 2006 - 1994

UNIT PACKAGE: 15



21467
(007-988-71-78)
White Nylon

Front & Rear Door
Moulding Clip
Width: 32.5mm
Length: 48mm
Overall Height: 15mm
Mercedes-Benz
2009 - 1994

UNIT PACKAGE: 25



21759
(Mercedes-Benz: 124-988-94-78)
Black Phosphate Plated Steel
& White Nylon

Front & Rear Door
Upper Moulding Clip
Nylon Clip: 14.5mm x 47mm
Metal Clip Length:
43mm
300D, 300E, 300TE,
400E & 500E
1995 - 90

UNIT PACKAGE: 10



20199
(006-988-35-78)
White Nylon

Body Side Moulding Clip
Body Style 201 1993 - 87

UNIT PACKAGE: 10



20773
(211-988-00-81)
Black Nylon

Cowl Cover Retainer
Head Size: 20mm x 43mm
Stem Length: 25mm
Fits into 8mm Hole
E, CL & S Class 2000 - On

UNIT PACKAGE: 10



22307
(Mercedes: 000-991-73-98)
White Nylon

Rocker Moulding Clip with Sealer
Top Head Diameter: 24mm
Bottom Head Diameter: 32mm
Overall Height: 28mm
Mercedes-Benz C250, C300, C350, C400,
C63, CLS400, CLS550, CLS63, E250, E350, E400,
E550, E63, S550, S600, S63 & S65 2015 - On

UNIT PACKAGE: 10



20656
(140-698-00-82)
White Nylon

Rocker Moulding Clip
Head Diameter: 12mm x 16mm
Stem Length: 28mm
Overall Length: 36mm

UNIT PACKAGE: 10



20205
(001-988-76-81)
White Nylon

Moulding Insert
Head Diameter: 11.5mm
Stem Length: 12mm
Fits into 9mm Hole
Body Styles 170, 202, 203, 208, 210 & 220 1994 -On

UNIT PACKAGE: 25



20659
(201-997-22-81)
White Nylon

Hood & Trunk Moulding Insert
Head Diameter: 7mm
Stem Length: 6mm
Fits into 5.5mm Hole
C, CL, CLK, E, SLK & S Class 1996 - On

UNIT PACKAGE: 15



13141
(000-988-15-81)
Red Nylon

Moulding Insert

UNIT PACKAGE: 50



13144
(000-988-55-81)
Blue Nylon

Moulding Insert

UNIT PACKAGE: 50



13157
(000-987-10-81)
White Nylon

Moulding Insert

UNIT PACKAGE: 50



16124
(001-988-20-81)
Red Nylon

Tubular Nut
Inner Diameter: 4.5mm
Length: 14mm
Fits into 9mm Hole

UNIT PACKAGE: 50



21499
(BMW: 51-44-7-780-135;
Mercedes-Benz: 108-988-00-27)
Natural Nylon

Tubular Nut
Stud Size: 7mm
Head Diameter: 16mm
Stem Length: 16mm
Fits into 8.5mm Hole
BMW, Mercedes-Benz & Universal

UNIT PACKAGE: 25



20647
(000-988-16-25)
White Nylon

Cowl Vent Nylon Nut
Screw Size: M3.5 (#6)
Head Size: 9.5mm x 9.5mm
Stem Length: 14mm
Fits into 6.5mm x 7mm Hole

UNIT PACKAGE: 25



20404
(000-988-86-25)
Natural Nylon

Rocker Panel Moulding Screw Grommet
Screw: M4.2 (#8)
Class CL, E & S 1996 - On

UNIT PACKAGE: 25



20315
(673-988-00-25)
Black Nylon

Screw Grommet
Screw Size: #8 (M4.2)
Head Diameter: 25mm
Stem Length: 17mm
Body Styles 124, 126, 170, 201,
202, 208 & 210 1991 - On

UNIT PACKAGE: 15



22254
(Mercedes-Benz: 000-991-74-98)
Black Nylon

Rocker Moulding
Retaining Clip
Slotted Head Diameter: 31mm
Stem Diameter: 7mm
Stem Length: 12mm
Mercedes-Benz C, Cla, Cls, E,
Gla & S Class 2015 - On

UNIT PACKAGE: 15



22310
(Mercedes: 001-988-97-81)
White Nylon

Scuff Plate Retainer
Head Size: 9.5mm x 16.5mm
Stem Length: 13.5mm
Overall Length: 14.5mm
Mercedes-Benz C230, C280, C350,
C55, CLK350, CLK500, CLK55, CLK63,
S350 & S430 2009 - 2006

UNIT PACKAGE: 25



21843
(Mercedes-Benz: A901-988-00-25;
VW: 2D1-867-741)
Black Nylon

Rear Entry Scuff Plate
Retaining Pin
Head Size: 15mm x 15mm
Overall Length: 31mm
Mercedes-Benz Sprinter 1995 - On
VW LT Van 2007 - 1987

UNIT PACKAGE: 25



21105
(001-988-03-25)
Black Nylon

Hood Insulation Retainer
Head Diameter: 20mm
Stem Diameter: 14mm
Stem Length: 10mm
Mercedes - Benz 2002 - On

UNIT PACKAGE: 15



20188
(003-988-41-78)
White Nylon

Trim Panel Retainer
Top Head Diameter: 13mm
Bottom Head Diameter: 18mm
Stem Diameter: 8.5mm
Stem Length: 11mm
Body Styles 107, 108, 109, 114,
115, 123 & 124 1995 - 68

UNIT PACKAGE: 10



20735
(463-988-02-78)
Black Nylon

Door Panel Retainer
Top Head Diameter: 11.5mm
Bottom Head Diameter: 18mm
Stem Diameter: 9mm
Stem Length: 14mm
G55 & G500 2002 - On

UNIT PACKAGE: 25



20642
(000-990-57-92)
Gray Nylon

Door Panel Retaining Clip
Top Head Diameter: 13mm
Bottom Head Diameter: 16mm
Stem Diameter: 9mm
Stem Length: 13mm

UNIT PACKAGE: 10



22252
(Mercedes-Benz: 000-991-63-98;
000-991-63-98-M22)
Yellow Nylon

Door Garnish Moulding
Retainer with Sealer
Top Head Diameter: 13mm
Bottom Head Diameter: 18mm
Stem Diameter: 10.5mm
Stem Length: 12mm
Mercedes-Benz GL450, GL550, MI320, MI550, R63,
R320, R350 & R500 2010 - 2006

UNIT PACKAGE: 15



22236
(Mercedes: 006-988-43-78)
White Nylon

Tailgate Garnish Retainer with Sealer
Top Head Diameter: 13mm
Bottom Head Diameter: 18mm
Stem Diameter: 9.3mm
Stem Length: 13mm
Mercedes-Benz C Class, CLK Class,
E Class, SL Class & SLK Class 1996 - On

UNIT PACKAGE: 25



20879
(007-988-99-78, 007-988-34-78)
Green Nylon

Door Trim Panel Retainer
Top Head Diameter: 13mm
Bottom Head Diameter: 17mm
Stem Diameter: 9mm
Stem Length: 14mm
Mercedes-Benz 1996 - On

UNIT PACKAGE: 10



22305
(Mercedes: 001-991-26-98)
Yellow Nylon

Door Trim Panel Retainer with Sealer
Top Head Diameter: 13.3mm
Middle Head Diameter: 13.3mm
Bottom Head Diameter: 17mm
Stem Diameter: 9.3mm
Stem Length: 13mm
Mercedes-Benz CLS400, CLS550, CLS63,
S500, S600 & S63 2012 - On

UNIT PACKAGE: 15



22309
(Mercedes: 000-991-01-98; 011-988-76-78)
White Nylon

Door Upper Pillar Trim &
Trunk Lining Retainer with Sealer
Top Head Diameter: 13.3mm
Middle Head Diameter: 13.3mm
Bottom Head Diameter: 17mm
Stem Diameter: 9.3mm
Stem Length: 13mm
Mercedes-Benz C250, C300, C350, C63,
GLA250, GLA45, GLK250 & GLK350 2013 - On

UNIT PACKAGE: 15



13230

(Mercedes 000-990-03-92;
Volvo: 947-098)
Black Nylon

Push-Type Retainer
Head Diameter: 10mm
Stem Length: 7mm
Fits into 5mm Hole

UNIT PACKAGE: 50



20640

(000-990-40-92, 124-990-05-92-9051)
Black Nylon

Push-Type Retainer
Head Diameter: 12mm
Stem Length: 11mm
Fits into 5mm Hole

UNIT PACKAGE: 25



20187

(Mercedes: 000-990-34-92;
BMW: 51-16-1-881-149;
VW: N-102-593-01)
Black Nylon

Radiator Housing Push-Type Retainer
Head Diameter: 10mm
Stem Length: 10mm
Fits into 6mm Hole
Body Styles 116, 123, 124, 126, 129, 140,
170, 201, 208 & 210 1974 - On
BMW & VW

UNIT PACKAGE: 15



20639

(000-990-44-92)
Black Nylon

Push-Type Retainer
Head Diameter: 12mm
Stem Length: 11mm
Fits into 5mm x 5mm Hole

UNIT PACKAGE: 25



21037

(000-990-84-92)
Black Nylon

Push-Type Retainer
Head Diameter: 10mm
Stem Length: 10mm
Fits into 6mm Hole
Mercedes - Benz 2005 - On

UNIT PACKAGE: 25



20234

(BMW: 51-11-1-908-077;
Mercedes: 000-990-54-92)
Black Nylon

Bumper, Grille, Scuff Plate
& Trim Push-Type Retainer
Head Diameter: 15mm
Stem Length: 15mm
Fits into 6.3mm Hole
Mercedes-Benz 2014 - 1994
BMW Series 3, 5 & 7 1984 - On

UNIT PACKAGE: 50



21711

(Mercedes-Benz: 000-991-59-40)
Black Nylon & Santoprene Rubber

Push-Type Retainer
Head Diameter: 11mm
Stem Length: 16mm
Fits into 6mm Hole
CLS55, CLS500, C Class, E Class
& S1k Class 2006 - On

UNIT PACKAGE: 15



21044

(123-990-05-92, 126-990-03-92)
Black Nylon

Cowl Screen Cover Push-Type Retainer
Head Diameter: 16mm
Stem Length: 11mm
Fits into 6.3mm Hole
E, CL & S Class 2000 - On

UNIT PACKAGE: 15



20314

(000-990-37-92)
Black Nylon

Trunk Trim & General Purpose
Push-Type Retainer
Head Diameter: 13mm
Stem Length: 14mm
Fits into 8mm Hole
SL500 & SL600 Convertible 1999 - On

UNIT PACKAGE: 15



21859

(Mercedes-Benz: 000-990-29-92, 000-
990-60-92; 001-990-16-92, 114-990-01-92;
Opel: 1104882, 1719245;
Volvo: 9133417, 1268642)
Black Nylon

Push-Type Retainer
Head Diameter: 16mm
Stem Length: 11mm
Fits into 8mm Hole
Mercedes-Benz, Opel & Volvo 1985 - On

UNIT PACKAGE: 15



20641

(000-990-46-92)
Black Nylon

Push-Type Retainer
Head Diameter: 17mm
Stem Length: 15mm
Fits into 6mm Hole

UNIT PACKAGE: 10



20636

(123-990-00-92)
Dark Gray Nylon

Push-Type Retainer
Head Diameter: 12mm
Stem Length: 10mm
Fits into 8.5mm Hole

UNIT PACKAGE: 15



20909

(124-990-04-92)
Black Nylon

Push-Type Retainer
Head Diameter: 16mm
Stem Length: 18mm
Fits into 7mm Hole
Mercedes-Benz 2003 - On

UNIT PACKAGE: 15



20637

(123-990-02-92)
Black Nylon

Push-Type Retainer
Head Diameter: 20mm
Stem Length: 9mm
Fits into 8.5mm Hole

UNIT PACKAGE: 10



22306

(Mercedes: 000-991-49-40-M58)
Black Nylon

Lower Engine Cover, Interior Trim &
Trunk Cover Liner Push-Type Retainer
Head Diameter: 20mm
Stem Length: 10mm
Fits into 8mm Hole
Mercedes-Benz C300, C400, C63,
CLS400, CLS550, CLS63, GLK250,
GLK350, S550, S63 & S65 2015 - On

UNIT PACKAGE: 15



21086

(Mercedes-Benz: 230-990-01-92;
Chry: 6104900-A)
Black Nylon

Hood Insulation & Cowl Grille
Push-Type Retainer
Head Diameter: 20mm
Stem Length: 10mm
Fits into 8mm Hole
Mercedes GL, M, R, SL & SLK 2005 - On
Chrysler 2010 - On

UNIT PACKAGE: 15



20638

(BMW: 51471911992,
51470146782, 51470390017
Mercedes-Benz: 201-990-02-92)
Black Nylon

Push-Type Retainer
Head Diameter: 20mm
Stem Length: 14mm
Fits into 8.5mm Hole
BMW 1, 2, 3, 4, 5, 6, 7, i3, i8, X
& Z Series 1988 - On
Mercedes-Benz

UNIT PACKAGE: 25



22339

(Mercedes: 001-990-01-92)
Black Nylon

Rocker Panel Moulding
Push-Type Retainer
Head Diameter: 30.5mm
T25 Drive
Stem Length: 17mm
Fits into 8.5mm Hole
Mercedes-Benz CLS550,
CLS63 AMG, SL550, SL600,
SL63 AMG, SLK300, SLK350
and SLK55 AMG 2011 - 2008

UNIT PACKAGE: 25



20203

(124-990-07-92)
Black Nylon

Push-Type Retainer
Head Size: 11mm x 14mm
Stem Length: 8mm
Fits into 7mm x 8mm Hole
Body Styles 124, 129, 140, 170, 202, 203,
208, 210, 215, & 220 1986 - On

UNIT PACKAGE: 25

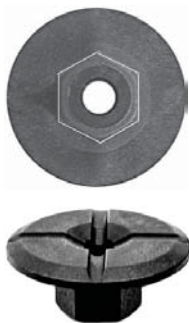

20645

(201-990-00-50)
Black Nylon

Rear Compartment
Carpet Retainer
Stud Size: 5mm
Head Diameter: 24mm
Hex: 10mm

UNIT PACKAGE: 25



21431

(BMW: 16-13-1-176-747;
Mercedes-Benz: 003-990-02-51)
Black Nylon

Nylon Flange Nut
Stud Size: 5mm
Flange Diameter: 16mm
Hex: 10mm
Overall Height: 11mm
BMW & Mercedes-Benz 1997 - On

UNIT PACKAGE: 25



20653

Gray Nylon

Wire Routing Clip
Inside Diameter: 7mm x 10mm
Fits into 6mm Hole
BMW & Mercedes

UNIT PACKAGE: 50



20654

(001-997-42-90)
Black Nylon

Photo not actual size
Cable Strap
Length: 120mm (4-3/4")
Fits into 8mm Hole

UNIT PACKAGE: 10

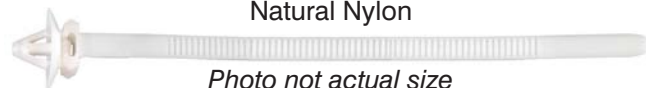

21305

(Not Available from O.E.M.)
Natural Nylon

Photo not actual size
Push-Mount Cable Strap
Strap Width: 5mm (3/16")
Length: 156mm (6-1/8")
Snaps into 6.3mm (1/4") Hole
Maximum Bundle Diameter: 40mm (1-9/16")
European Makes & Universal

UNIT PACKAGE: 25



20655

(114-997-02-90)
Black Nylon

Photo not actual size
Cable Strap
Length: 160mm (6-3/8")
Fits into 8mm Hole

UNIT PACKAGE: 10



21823

(Mercedes-Benz: 001-994-98-45)
Zinc

Shield Clip Nut
Screw Size: M4.8-1.61 (#10)
Head Size: 10mm x 19mm
Overall Height: 7.5mm
Mercedes-Benz 2002 - On

UNIT PACKAGE: 25



22115

(Mercedes: 124-988-90-78-M89)
Zinc

Bumper Moulding Clip
Width: 16mm
Length: 19mm
Overall Height: 9mm
Mercedes

UNIT PACKAGE: 25



20649

Screw Size: M3.5 (#6)
Panel Range: .5mm - 1.5mm
Center of Hole to Edge: 8mm

UNIT PACKAGE: 50

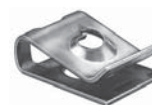

13223

(BMW: 0712-9-925-708;
Mercedes: 000-994-25-45)
Plated

U-Type Nut
Screw Size: 4.2mm (#8)
Panel Range: 3mm-4mm
Center of Hole to Edge: 7mm

UNIT PACKAGE: 50



13224

(000-994-04-45)
Plated

U-Type Nut
Screw Size: 4.2mm (#8)
Panel Range: .5mm-1.7mm
Center of Hole to Edge: 8mm

UNIT PACKAGE: 50

**MERCEDES-BENZ AND MINI-COOPER
CLIPS & FASTENERS**



20650
(123-994-08-45)
Zinc

Screw Size: M4.2 (#8)
Panel Range: .5mm - 2.5mm
Center of Hole to Edge: 14mm

UNIT PACKAGE: 25



13216
Zinc

U-Type Nut
Screw Size: 4.8mm
Panel Range: .9mm-2.0mm
Center of Hole to Edge: 8mm

UNIT PACKAGE: 25



13218
(BMW: 0712-9-925-737;
Mercedes 000-994-06-45)
Plated

U-Type Nut
Screw Size: 4.8mm
Panel Range: .5mm-1.7mm
Center of Hole to Edge: 7mm

UNIT PACKAGE: 50



13220
(Mercedes: 000-994-09-45;
Volvo: 946-418; Opel: 20-72-175)
Plated

U-Type Nut
Screw Size: 6.3mm
Panel Range: .7mm-1.5mm
Center of Hole to Edge: 13mm

UNIT PACKAGE: 50



13215
(BMW: 0711-9-916-945,
Mercedes 000-994-14-45)
Plated

U-Type Nut
Screw Size: 4.8mm
Panel Range: .8mm-1.7mm
Center of Hole to Edge: 11mm

UNIT PACKAGE: 50



20651
(001-990-00-91)
Zinc

Screw Size: M6 - 1.0
Panel Range: .5mm - 1.7mm
Center of Hole to Edge: 15mm

UNIT PACKAGE: 10

MINI-COOPER CLIPS & FASTENERS



21659
(07-13-2-757-821)
Gray Nylon

Moulding Clip
Top Head Size: 11mm x 19mm
Bottom Head Diameter: 21mm
Stem Length: 11mm
Mini-Cooper 2002 - On

UNIT PACKAGE: 15



21709
(Mini-Cooper: 07-13-1-480-419)
Black Nylon

Rocker Panel Moulding Clip
Top Head Size: 16mm x 20mm
Middle Head Diameter: 18mm
Bottom Head Diameter: 23mm
Stem Length: 19mm
Mini-Cooper 2002 - On

UNIT PACKAGE: 15



21527
(07-13-7-073-915)
White Nylon

Trim Panel & Fender Flare Moulding Clip
Top Head Size: 11.5mm x 19mm
Bottom Head Diameter: 21mm
Stem Length: 13mm
Fits into 8mm Hole
Mini Cooper S 2002 - On

UNIT PACKAGE: 15



21716
(Mini-Cooper: 51-71-7-127-742)
Red Nylon

Moulding Clip
Top Head Size: 16mm x 20mm
Middle Head Diameter: 18mm
Bottom Head Diameter: 23mm
Stem Length: 21mm
Overall Length: 29mm
R58, R59 & S 2009 - On

UNIT PACKAGE: 15



21143

(51-71-1-496-621)
Black Nylon

Rocker Moulding Retainer
Head Size: 8.5mm x 14mm
Stem Size: 5mm x 7.5mm
Stem Length: 14mm
Mini Cooper 2002 - On

UNIT PACKAGE: 25



21137

(07-13-0-702-516)
Black Nylon

Rear Quarter Wheel Opening
Moulding Retaining Clip
Top Head Diameter: 13mm
Middle Head Diameter: 15mm
Bottom Head Diameter: 15mm
Stem Diameter: 10mm
Stem Length: 8mm
Fits into 8mm Hole
Mini Cooper 2002 - On

UNIT PACKAGE: 25



21787

(BMW: 51-77-7-171-002)
White Nylon

Wheel Arch Cover & Footboard
Retainer with Sealer
Top Head Diameter: 12mm
Bottom Head Diameter: 18mm
Stem Diameter: 9.5mm
Stem Length: 16mm
Mini-Cooper S & SX Series 2011 - On
BMW X Series 2006 - On

UNIT PACKAGE: 25



21139

(07-14-7-145-753)
White Nylon

Body Side Moulding Retainer with Sealer
Top Head Diameter: 12mm
Middle Head Diameter: 15mm
Bottom Head Diameter: 18mm
Stem Diameter: 9.5mm
Stem Length: 11mm
Mini Cooper 2002 - On

UNIT PACKAGE: 25



21138

(51-43-7-001-491-2)
White Nylon

Headliner Retainer
Top Head Diameter: 14mm
Middle Head Diameter: 15mm
Bottom Head Diameter: 18mm
Stem Diameter: 9mm
Stem Length: 14mm
Mini Cooper 2005 - On

UNIT PACKAGE: 25



21788

(BMW: 51-41-8-224-768, 51-41-0-407-984)
White Nylon

Door Panel Lining & Rear Window
Retainer with Sealer
Top Head Diameter: 14mm
Middle Head Diameter: 15.5mm
Bottom Head Diameter: 18mm
Stem Diameter: 9.5mm
Stem Length: 14mm
Mini-Cooper 2002 - On
BMW X Series 2006 - On

UNIT PACKAGE: 25



22285

(Mini-Cooper: 07-14-6-962-771)
Red Nylon

Rocker Moulding &
Pillar Retainer with Sealer
Top Head Diameter: 14.3mm
Middle Head Diameter: 15.5mm
Bottom Head Diameter: 18mm
Stem Diameter: 9.5mm
Stem Length: 13mm
Overall Length: 19mm
Mini-Cooper 2006 - On

UNIT PACKAGE: 15



22303

(BMW: 51-16-8-197-908)
Black Nylon

Upper Cover & Spoiler
Push-Type Retainer
Head Diameter: 12mm
Stem Length: 13mm
Fits into 7mm Hole

BMW 1, 3, M3 & Z4 and Mini-Cooper Base, John
Cooper Works, Countryman & Paceman 2013 - On

UNIT PACKAGE: 15



20570

(Mini-Cooper: 07-13-0-702-715;
Honda: 75307-SN7-000)

Wheel Opening Nylon Moulding Nut
With Brass Insert
Thread: M4-0.7
Flange Outer Diameter: 12mm
Hex: 10mm
Height: 11mm

UNIT PACKAGE: 15



21305

(Not Available from O.E.M.)
Natural Nylon

Photo not actual size
Push-Mount Cable Strap
Length: 156mm (6-1/8")
Strap Width: 5mm (3/16")
Snaps into 6.3mm (1/4") Hole
Maximum Bundle Diameter: 40mm (1-9/16")
European Makes & Universal

UNIT PACKAGE: 25



19343
(MB608137)
Natural Nylon

Windshield Moulding Clip
Diamante 1995-91

UNIT PACKAGE: 15



19745
(MB880455)
Light Blue Nylon

Windshield Moulding Clip
Montero 1992-On

UNIT PACKAGE: 10



19314
(MB814419)
Nylon

Drip Moulding & Garnish
Moulding Clip
Galant 1993-On

UNIT PACKAGE: 25



17195
Black Nylon

Grille Clip
Width: 13mm
Length: 22mm
Ford Escort, Honda, Isuzu,
Mitsubishi & Plymouth Laser

UNIT PACKAGE: 25



21623
(Mitsubishi: MR221507;
Toyota: 90467-13075)
Gray Nylon

Radiator Grille Clip
Width: 14mm
Length: 24mm
Mitsubishi Diamante, Endeavor & Galant 1997 - On
Toyota 4 Runner, Highlander & Land Cruiser 1998 - On

UNIT PACKAGE: 25



20572
(MB846992)
White Nylon

Rocker Panel Retainer
Top Head Diameter: 12mm
Bottom Head Diameter: 16mm
Stem Length: 14mm
Fits into 7mm Hole
Montero 2001 - On

UNIT PACKAGE: 10



19330
(MB608140)
White Nylon

Trunk Air Dam
Side Moulding Clip
Diamante 1991-On

UNIT PACKAGE: 10



21863
(Hyundai: 87758-35010)
White Nylon

Moulding Clip with Sealer
Top Head Size: 10mm x 12mm
Bottom Head Size: 14mm x 18mm
Stem Length: 10mm
Hyundai Accent, Kia Soul &
Mitsubishi Outlander 2006 - On

UNIT PACKAGE: 15



21632
(MU480001)
Natural Nylon

Screw Size: M3.5(#6)
Head Size: 10mm x 10mm
Stem Length: 7mm
Fits into 6mm x 6mm Hole
Mitsubishi Eclipse and Chrysler
Avenger, Colt, Jeep Eagle Talon,
Laser & Sebring 2000 - 1984

UNIT PACKAGE: 50



14255
(Mitsubishi: MS-480001;
Honda: 75522-611-000;
Mazda: 9991-00-412)
Black Nylon

Screw Size: #8
Width: 9.5mm
Length: 9.5mm
Snaps into 7mm x 7mm Hole

UNIT PACKAGE: 50



19487
(MB419858)
Natural Nylon

Scuff Plate Screw Grommet
Screw Size: #6
Diamante 1995-91

UNIT PACKAGE: 15



13932

(Mitsubishi: MS-480002;
Toyota: 90189-05013)
Natural Nylon

Screw Size: #10
Width: 12mm
Length: 12mm
Fits into 8mm x 9mm Hole

UNIT PACKAGE: 50



19485

Natural Nylon

Screw Size: #14 (M6.3)
Fits into 3/8" x 3/8" Hole
Eclipse

UNIT PACKAGE: 10



20573

(MB817060)
White Nylon

Headliner Nylon Nut
Head Diameter: 15mm
Inside Diameter: 6mm
Stem Length: 11mm
Fits into 9mm Hole
Montero 1997 - On

UNIT PACKAGE: 15



14335

(Mitsubishi: MB-106212;
Nissan: 96706-H9400, -K1300, -K1351)
Natural Nylon

Screw Grommet
Screw Size: #8
Head Diameter: 13.5mm
Stem Length: 16mm
Fits into 6mm x 6mm Hole

UNIT PACKAGE: 50



14695

(Mitsubishi: MS-480012;
Honda: 90661-SC7-003;
Mazda: H001-50-841;
Nissan: 01651-00481, 74798-S9000;
Toyota: 90189-06042)
White Nylon

Screw Grommet
Screw Size: #8
Head Diameter: 16mm
Stem Length: 17mm
Fits into 8mm x 8mm Hole

UNIT PACKAGE: 25



19322

(MU480034)
Natural Nylon

Rear Side & Trunk Trim
Screw Grommet
Screw Size: #8
Eclipse 1994-On

UNIT PACKAGE: 15



14275

(Mitsubishi: MB-098145;
Nissan: 01281-00023, 01281-00231;
Toyota: 90189-06001)
White Nylon

Screw Grommet
Screw Size: #10
Head Diameter: 18mm
Stem Length: 17mm
Fits into 8.5mm x 8.5mm Hole

UNIT PACKAGE: 25



20581

(MR478263)
Black Rubber

Bumper Cover & Garnish
Moulding Grommet with Sealer
Head Diameter: 16mm
Stem Length: 20mm
Fits into 9mm Hole

Use with Auveco 20580
Chrysler Sebring & Stratus
and Mitsubishi Eclipse 2000 - On

UNIT PACKAGE: 15



20565

(MB271999)
Black Nylon

Bumper Cover Grommet
Head Diameter: 24mm
Stem Length: 21mm
Fits into 13mm Hole
Chrysler Colt, Eagle, Sebring & Stratus 1989 - On
Mitsubishi Eclipse, Galant & Mirage 1993 - On

UNIT PACKAGE: 10



19324

(MB888561)
Natural Nylon

Drip Moulding Screw Grommet
Screw Size: #8
Eclipse 1994-On

UNIT PACKAGE: 25



21025

(MB645307)
Black Nylon

Back Glass Lower Moulding,
Quarter Glass Moulding &
Spoiler Grommet with Sealer
Head Size: 12mm x 16mm
Stem Length: 14mm
Dodge Avenger & Stealth and
Chrysler Sebring 1991 - On
Mitsubishi 1991 - On

UNIT PACKAGE: 15



19331

(MB869072)
Black Nylon

Headliner & Trunk Trim
Retaining Clip
Head Diameter: 14mm
Stem Length: 11mm
Fits into 7mm Hole
Diamante 1995-91

UNIT PACKAGE: 15



20381

(Honda: 90667-671-013ZA;
Mitsubishi: MC440901;
Nissan: 62660-48600-1)
Black Nylon

Trim Panel Retaining Clip
Head Diameter: 16mm
Stem Diameter: 7mm
Stem Length: 16mm
Honda, Mitsubishi & Nissan

UNIT PACKAGE: 25



14720

(HB-121467)
Black Nylon

Retaining Clip
Head Diameter: 18mm
Shank Length: 15mm
Panel Thickness: 5mm
Snaps into 8mm Hole

UNIT PACKAGE: 25



19323

(MU481187)
Black Nylon

Hood Insulation Retainer
Head Diameter: 26mm
Stem Diameter: 10mm
Stem Length: 8mm
Diamante 1993-On

UNIT PACKAGE: 15



19385

(MB020923)
Gray Nylon

Hood Insulation Retainer
Head Diameter: 26mm
Stem Diameter: 10mm
Stem Length: 8mm
Jeep Eagle & Mitsubishi Eclipse 1992 - On

UNIT PACKAGE: 10



22082

(Mitsubishi: MB655630)
Black Nylon

Hood Insulation Retainer
Head Diameter: 26mm
Stem Length: 14mm
Fits into 9mm Hole
Mitsubishi Diamante & Montero
2004 - 1992

UNIT PACKAGE: 15



21690

(Mitsubishi: MR322000)
White Nylon

Trim Panel Retainer with Sealer
Top Head Diameter: 12mm
Bottom Head Diameter: 16mm
Stem Diameter: 8mm x 8mm
Stem Length: 14mm
Diamante, Eclipse, Galant,
Montero & Outlander 2000 - On

UNIT PACKAGE: 25



19334

(MB566720)
Natural Nylon

Rear Pillar Trim &
Air Inlet Grille Retainer
Top Head Diameter: 12mm
Bottom Head Diameter: 16mm
Stem Diameter: 9mm
Stem Length: 15
Eclipse 1994-On

UNIT PACKAGE: 15



19320

(MB696120)
White Nylon

Side Garnish & Moulding Trim Retainer
Top Head Diameter: 12mm
Bottom Head Diameter: 16mm
Stem Diameter: 9mm
Stem Length: 11mm
Eclipse 1994-On

UNIT PACKAGE: 15



20571

(MR435918)
White Nylon

Rocker Panel Retainer
Top Head Diameter: 13mm
Bottom Head Diameter: 18mm
Stem Diameter: 9mm
Stem Length: 9mm
Montero 2001 - On

UNIT PACKAGE: 15



21118

(MB374270, MB374271)
White Nylon

Trim Panel Retainer
Top Head Diameter: 13mm
Middle Head Diameter: 16mm
Bottom Head Diameter: 18mm
Stem Diameter: 10mm
Stem Length: 14mm

Chrysler Laser, Dodge Stealth, Jeep Eagle & Talon and
Mitsubishi Eclipse & Montero 1989 - On

UNIT PACKAGE: 15



19325

(MU481027)
Brown Nylon

Hood Weatherstrip
Retainer
Head Size: 5mm x 13mm
Stem Diameter: 7mm
Stem Length: 6mm
Eclipse & Diamante 1991-On

UNIT PACKAGE: 25



21658

(Mitsubishi: MR288150;
Subaru: 909130013)
Black Nylon

Push-Type Retainer
Head Diameter: 15mm
Stem Length: 11mm
Fits into 6mm Hole
Mitsubishi Endeavor, Galant, Lancer, Mirage,
Montero & Outlander 1997 - On
Subaru BRZ, Forester, Impreza, Legacy,
Outback, & XV Crosstrek 2004 - On

UNIT PACKAGE: 10



21140

(MB619582)
Black Nylon

Interior Trim, Bumper & Grille
Push-Type Retainer
Head Diameter: 15mm
Stem Length: 12mm
Fits into 6.3mm Hole
Eclipse, Endeavor, Lancer & Outlander 2002 - On

UNIT PACKAGE: 25



20580

(MR478262)
Black Nylon

Bumper Cover & Garnish Moulding
Push-Type Retainer
Top Head Diameter: 15mm
Bottom Head Diameter: 14mm
Stem Length: 12mm
Fits into 7mm Hole

Use with Auveco 20581

Chrysler Sebring & Stratus
and Mitsubishi Eclipse 2000 - On

UNIT PACKAGE: 15



19239

(Honda: 91512-SX0-003;
Mitsubishi: MU000319; GM: 11519949)
Black Nylon

Front Fender & Bumper Support
Push-Type Retainer
Head Diameter: 20mm
Stem Length: 11mm
Fits into 8mm Hole

Acura 3.5RL, Honda Accord,
Prelude & Odyssey 1994-On
Mitsubishi Lancer 2002-On
GM 1997 - On

UNIT PACKAGE: 25



20247

(MR200300)
Black Nylon

Fender & Bumper Push-Type Retainer
Head Diameter: 18mm
Stem Length: 12mm
Fits into 9mm Hole

Honda & Mitsubishi 1998 - On

UNIT PACKAGE: 15



17351

(MB-253964)
Black Nylon

Front & Rear Bumper Push-Type Retainer
Head Diameter: 17mm
Stem Length: 10mm
Fits into 7mm Hole
Tredia 1988-83

UNIT PACKAGE: 10



22077

(Mitsubishi: MB879499)
Black Nylon

Front Bumper Push-Type Retainer
Head Diameter: 18mm
Stem Length: 9mm
Fits into 9mm Hole

Mitsubishi Montero 2006 - 01

UNIT PACKAGE: 25

MITSUBISHI AND NISSAN CLIPS & FASTENERS



17472

(Mitsubishi: MB547806;
Nissan: 63854-01A00)
Black Nylon

Front Bumper Fascia Push-Type Retainer
Head Diameter: 20mm
Stem Length: 20mm
Fits into 8mm Hole

UNIT PACKAGE: 15



19140

(Acura: 90505-SL0-003;
GM: 94852638;
Mitsubishi: MB888869;
Toyota: 90467-08155)
Black Nylon

Push-Type Retainer
Head Diameter: 20mm
Stem Length: 21mm
Fits into 8mm Hole

Acura, Dodge Avenger, Eagle Talon, Geo Prizm,
Mitsubishi Eclipse & Galant and Toyota 1993-On

UNIT PACKAGE: 5



18951

(MR-138807)
Black Nylon

Front Bumper & Support
Push-Type Retainer
Head Diameter: 20mm
Stem Length: 26mm
Fits into 8mm Hole
Eclipse 1994-On

UNIT PACKAGE: 5



19328

(MR201466)
White Nylon

Trunk Trim Cap
Eclipse 1994-On

UNIT PACKAGE: 15



20380

(Not Supplied by O.E.M.)
Black Nylon

Photo not actual size
Cable Strap

Width: 5mm (3/16")
Length: 200mm (8")
Max. Bundle Diameter: 44mm (1-3/4")
Fits into 6.3mm (1/4") Hole
Import Cars

UNIT PACKAGE: 25



13225

Plated

U-Type Nut
Screw Size: 4.2mm (#8)
Width: 11mm
Length: 16.5mm
Panel Range: .5mm-2.5mm
Center of Hole to Edge: 8mm

UNIT PACKAGE: 50

NISSAN CLIPS & FASTENERS



16860

(62318-01WOO)
Dark Gray Nylon

Grille Clip
Overall Height: 21.5mm (27/32")

UNIT PACKAGE: 25



21121

(01553-03831)
Black Nylon

Grille Clip
Overall Height: 22mm (7/8")
Maxima & Stanza 1982 - On

UNIT PACKAGE: 25



22000

(Nissan: 01553-05751)
Gray Nylon

Grille Clip
Width: 18mm
Overall Length: 22mm
Nissan

UNIT PACKAGE: 10



21619

(76882-0M060)
Black Nylon

Grille Clip
Overall Height: 25mm (1")
Frontier, Krom & SL 2006 - On

UNIT PACKAGE: 15



22301

(Nissan: 01553-05233)
Black Nylon

Fender Liner Moulding Clip
Top Width: 31mm
Bottom Width: 30mm
Overall Height: 11mm

Infiniti JX35 & QX60 2013 - On
Nissan Altima, Murano, Pathfinder,
Rogue & Sentra 2007 - On

UNIT PACKAGE: 25



21085

(Not Available from O.E.M.)
Light Blue Nylon

Rocker Panel Moulding Clip
Overall Height: 15mm
Stem Length: 9mm
Murano 2003 - On

UNIT PACKAGE: 15



21291

(76988-4N000)
White Nylon

Moulding Clip
Top Head Size: 8mm x 15mm
Bottom Head Diameter: 15mm
Stem Diameter: 5.3mm
Stem Length: 9mm
Quest & 370Z 2004 - On

UNIT PACKAGE: 25



22076

(Nissan: 76882-6P010)
Natural Nylon

Hood, Front Fender Bracket
& Exterior Moulding Clip
Top Head Size: 15mm x 15mm
Bottom Head Size: 15mm x 15mm
Stem Length: 15mm
Overall Length: 22mm
Infiniti Q45 2001 - 1996
Nissan Altima & Maxima 2006 - 2002

UNIT PACKAGE: 25



21683

(Nissan: 76882-EW00B)
White Nylon

Rocker Moulding & Exterior Trim
Moulding Clip with Sealer
Top Head Size: 6mm x 9mm
Bottom Head Diameter: 13mm
Stem Length: 7mm
Fits into 8mm Hole

Nissan Altima & Juke 2011 - On

UNIT PACKAGE: 10



22061

(Nissan: 76882-JG10A)
White Nylon

Fender Moulding Clip with Sealer
Top Head Size: 6mm x 12mm
Bottom Head Diameter: 16mm
Stem Length: 10mm
Infiniti Qx80 2014 - On
Nissan Juke 2011 - On

UNIT PACKAGE: 25



21285

(76882-EG01A)
Black Nylon

Rocker Panel
Moulding Clip with Sealer
Top Head Size: 10mm x 15mm
Bottom Head Diameter: 18mm
Stem Length: 12mm
Fits into 8mm Hole
Altima and Maxima 2010 - On

UNIT PACKAGE: 15



22055

(Nissan: 76847-1JB0A)
White Nylon

Moulding Clip with Sealer
Top Head Diameter: 13mm
Bottom Head Diameter: 13mm
Stem Length: 11mm
Fits into 8mm Hole
Nissan Altima, Quest & Sentra 2011 - On

UNIT PACKAGE: 15



21618

(01553-08911)
White Nylon

Scuff Plate Moulding Clip
Top Head Size: 12mm x 15mm
Bottom Head Diameter: 16mm
Stem Length: 12mm
Fits into 8.5mm Hole
Maxima 1999 - On

UNIT PACKAGE: 15



20873

(73858-8J000)
Black Nylon

Drip Rail Moulding Clip
Width: 13.5mm
Length: 31mm
Nissan 2000 - On

UNIT PACKAGE: 10



20961

(Not Available from O.E.M.)
White Nylon

Drip Moulding Clip with Sealer
Top Width: 25mm
Overall Height: 16mm
Fits into 5mm Hole

Infiniti M45, I30 & G35 2005 - On
Nissan Altima, Maxima & 350Z 2002 - On

UNIT PACKAGE: 15



20614

(66820-3S510)
White Nylon

Cowl Vent Retainer
Head Size: 10mm x 18mm
Stem Diameter: 6mm
Stem Length: 13mm
Frontier & Xterra 1998 - On

UNIT PACKAGE: 25



12583

(76884-90100)
Nylon

Step Moulding Clip
Width: 24mm
Length: 14mm
Snaps into 8mm Hole

UNIT PACKAGE: 15



22345

(Not Available from O.E.M.)
Black Nylon

Rocker Panel Moulding Clip
Top Head Size: 14mm x 21.5mm
Bottom Head Size: 14mm x 21.5mm
Stem Length: 12mm
Fits into 9mm Hole
Nissan Pathfinder

UNIT PACKAGE: 25



12585

(255 Y 3616-10)
Nylon

Side Window Moulding Clip
Width: 12mm
Length: 12mm
Snaps into 5mm Hole

UNIT PACKAGE: 15



21617

(76882-0E700)
White Nylon

Rocker Moulding Clip
Top Head Size: 14mm x 14mm
Bottom Head Diameter: 16mm
Stem Length: 10mm
Altima 1996 - On

UNIT PACKAGE: 15



22281

(Nissan: 76847-JG00A)
Yellow Nylon

Wheel Well Opening Moulding Clip
Head Size: 8mm x 17mm
Stem Length: 12mm
Overall Height: 16.5mm
Use with Auveco 22257
Nissan Juke 2011 - On

UNIT PACKAGE: 25



22032

(Nissan: 76988-3DN0A)
Green Nylon

Windshield Garnish Moulding Clip
Overall Length: 44mm
Fits into 7mm x 12mm Hole
Nissan Altima, Juke
& Sentra 2011 - On

UNIT PACKAGE: 10



15468

(72826-01P00)
Nylon

Windshield Moulding Clip
Width: 11mm
Length: 40mm
300ZX 1984 - On

UNIT PACKAGE: 15



17348

(73856-51E00)
Nylon

Roof Side Moulding Clip
Stanza 1990 - On

UNIT PACKAGE: 25



17349

(79796-71E00)
Nylon

Window Reveal Moulding Clip
Back Glass
Maxima 1990-On

UNIT PACKAGE: 25



15470
(72727-W1000)
White Nylon

Windshield Reveal Moulding Clip
Width: 21mm
Length: 40mm

UNIT PACKAGE: 15



21097
(Not Available
from O.E.M.)
Black Nylon

Windshield Moulding Clip
Width: 22mm
Length: 46mm
Altima 2004 - On

UNIT PACKAGE: 25



18113
(69951-12180)
Nylon with
Steel Threaded Insert

Glass Mount
Thread: M6-1.0
Nissan, Ford & Imports

UNIT PACKAGE: 5



13931
(26023-H1000)
White Nylon

Screw Grommet
For Headlight Adjusting Screws
Screw Size: 5mm
Width: 14mm
Length: 14mm

UNIT PACKAGE: 50



21930
(Renault & Dacia: 77-03-081-160;
Nissan: 01281-00QAF)
Natural Nylon

Nylon Nut
Screw Size: M2.9mm (#4)
Head Size: 9mm x 9mm
Stem Length: 7mm
Renault, Dacia & Nissan

UNIT PACKAGE: 50



13930
(Nissan: 96706-B0700;
Mazda: 9991-00-412)
White Nylon

Screw Size: #8
Width: 9.5mm
Length: 9.5mm
Snaps into 7mm x 7mm Hole

UNIT PACKAGE: 50



14274
(Mazda: 9991-00-601;
Honda: 75521-611-000;
Nissan: 96706-P0105;
Toyota: 90189-06010)
Natural Nylon

Screw Size: #10
Width: 13mm
Length: 13mm
Snaps into 8.5mm x 8.5mm Hole

UNIT PACKAGE: 25



14334
(96706-N8000)
Natural Nylon

Screw Size: #8
Width: 12mm
Length: 15mm
Fits into 8mm x 12mm Hole

UNIT PACKAGE: 25



14313
(Nissan: 62698-V7000, 68425-H5000;
Honda: 90662-671-003;
Mazda: 9991-00-503)
Natural Nylon

Screw Size: #10
Width: 17mm
Length: 17mm
Snaps into 8mm x 8.5mm Hole

UNIT PACKAGE: 25

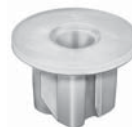

20764
(01281-00831)
Natural Nylon

Bumper, Fender & Light Screw Grommet
Screw Size: M4.2 (#8)
Head Diameter: 16mm
Stem Length: 10mm
Fits into 9mm x 9mm Hole
Nissan 240SX, Altima, Frontier, Maxima, Pathfinder,
Quest & Xterra and Infiniti 1989 - On

UNIT PACKAGE: 25



17342

(01281-00441)
Black Nylon

Front Bumper Apron
Nylon Nut
Screw Size: #10
Head Diameter: 15mm
Snaps into 8mm x 8mm Hole
Stanza 1990-On

UNIT PACKAGE: 25



21820

(Not Available from O.E.M.)
Black Nylon

Nylon Nut
Screw Size: M5.5 (#12)
Head Diameter: 15mm
Stem Length: 8mm
Fits into 8.5mm x 8.5mm Hole
Nissan

UNIT PACKAGE: 50



20266

(62319-0W000)
Natural Nylon

Front Bumper Nylon Nut
Screw Size: M5.5 (#12)
Head Diameter: 16mm
Stem Length: 11mm
Frontier Truck 1997 - On

UNIT PACKAGE: 10



22274

(Nissan: 01281-01121)
White Nylon

Screw Grommet with Sealer
Screw Size: 2.9mm (#4)
Head Diameter: 12mm
Stem Length: 16mm
Fits into 7mm x 7mm Square Hole
Infiniti M35h, M45, Q45 & QX50 and
Nissan Altima, Maxima, Pathfinder, Quest,
Rogue & Sentra 2012 - 2003

UNIT PACKAGE: 10



14724

(96706-H2500)
Natural Nylon

Screw Grommet
Screw Size: #6
Head Diameter: 11.5mm
Stem Diameter: 9.5mm
Fits into 7mm x 7mm Hole

UNIT PACKAGE: 25



14366

(Nissan: 96706-89901;
Mazda: 9991-00-402)
Natural Nylon

Screw Grommet
Screw Size: #6
Width: 9.5mm
Length: 9.5mm
Stem Length: 16mm
Fits into 7mm x 7mm Hole

UNIT PACKAGE: 50



21367

(01281-00501)
White Nylon

Body Side Moulding
Screw Grommet with Sealer
Screw Size: M3.5 (#6)
Head Size: 9.5mm x 9.5mm
Stem Length: 16mm

UNIT PACKAGE: 15



14335

(Nissan: 96706-H9400; -K1300, -K1351;
Mitsubishi: MB-106212)
Natural Nylon

Screw Grommet
Screw Size: #4
Head Diameter: 13.5mm
Stem Length: 16mm
Fits into 6mm x 6mm Hole

UNIT PACKAGE: 50



14695

(Nissan: 01651-00481 74798-S9000;
Honda: 90661-SC7-003;
Mazda: H001-50-841;
Mitsubishi: MS-480012;
Toyota: 90189-06042)
White Nylon

Screw Grommet
Screw Size: #8
Head Diameter: 16mm
Stem Length: 17mm
Fits into 8mm x 8mm Hole

UNIT PACKAGE: 25



21324

(01281-00691)
Natural Nylon

Screw Grommet with Sealer
Screw Size: 4.2 (#8)
Head Diameter: 16mm
Stem Length: 20mm
Nissan 240SX, Altima, Frontier, Maxima, Pathfinder &
Titan and Infiniti I30, I35 & Q45 1989 - On

UNIT PACKAGE: 15



22239

(Nissan: 76881-JG00A)
Black Nylon

Screw Grommet
Head Diameter: 16mm
Stem Length: 12mm
Fits into 8mm x 8mm Hole
Nissan Murano & Rogue 2014 - On

UNIT PACKAGE: 15



20604

(01281-00711)
Natural Nylon

Rocker Moulding Screw Grommet
Screw Size: M4.2 (#8) & M4.8 (#10)
Head Diameter: 20mm
Stem Length: 15mm
Nissan & Infiniti 1995 - On

UNIT PACKAGE: 10



14275

(Nissan: 01281-00023, 01281-00231;
Mitsubishi: MB-098145;
Toyota: 90189-06001)
White Nylon

Screw Grommet
Screw Size: #10
Head Diameter: 18mm
Stem Length: 17mm
Fits into 8.5mm x 8.5mm Hole

UNIT PACKAGE: 25



21621

(01553-02913)
White Nylon

Moulding Grommet with Sealer
Screw Size: M4.2 (#8)
Head Diameter: 14mm
Stem Length: 8mm
Fits into 8mm Hole
Nissan Frontier, Pathfinder &
Titan and Infiniti QX4 & QX56 1996 - On

UNIT PACKAGE: 15



19293

(01281-00601)
Natural Nylon

Body Side Moulding
Floor & Trunk Screw Grommet
Screw Size: M4.8 (#10)
Maxima, Sentra, 240SX & 300ZX 1986-On

UNIT PACKAGE: 15



22311

(Nissan: 88796-6P000)
Natural Nylon

Screw Grommet with Sealer
Screw Size: M4.8 (#10)
Head Diameter: 16mm
Stem Length: 15mm
Nissan Frontier & Rogue 2005 - On

UNIT PACKAGE: 15



21768

(Nissan: 63846-5V000)
White Nylon

Bumper Grommet with Sealer
Screw Size: M4.8 (#10)
Head Diameter: 20mm
Stem Length: 16mm
Overall Length: 22mm
Infiniti FX35, FX45, JX35, M35, M36, M37, M56 & QX56
and Nissan Altima, Juke, Maxima, Murano,
Quest & Sentra 2003 - On

UNIT PACKAGE: 25



22123

(Nissan: 85099-1VA0A)
White Nylon

Screw Grommet with Sealer
Screw Size: M5.5 (#12)
Head Diameter: 19mm
Stem Length: 16mm
Overall Length: 20mm
Nissan LEAF, Pathfinder & Rogue 2011 - On

UNIT PACKAGE: 10



21824

(Nissan: 26557-2U001)
Brown Nylon

Screw Grommet with Sealer
Screw Size: M6.3-1.81 (#14)
Head Size: 15mm x 19mm
Stem Length: 16mm
Infiniti EX35, G37, JX35, M35, M45, Q50, QX56, QX60
& QX70 and Nissan 350Z, 370Z, Altima, Armada,
Cube, Juke, Maxima, Murano, Pathfinder, Quest,
Rouge, Sentra, Versa & Xterra 2014 - 02

UNIT PACKAGE: 15



21111

(01281-00331)
Natural Nylon

Bumper, Rocker Panel & Light Mounting
Screw Grommet with Sealer
Screw Size: M6.3 (#14)
Head Diameter: 20mm
Stem Length: 16mm
Fits into 10mm Square Hole
Infiniti 1997 - On
Nissan 1996 - On

UNIT PACKAGE: 25



22261

(Nissan: 76848-35F00)
White Nylon

Moulding Screw Grommet with Sealer
Head Diameter: 18mm
Stem Diameter: 8.5mm
Stem Length: 14mm

Infiniti G35, G37, I30, I35, M35h, Q40, Q50,
Q70, QX56 & QX80 and Nissan 350Z, Altima,
Cube, Pathfinder & Sentra 2003 - On

UNIT PACKAGE: 15



22257

(Nissan: 76848-JG00A)
Gray Nylon

Wheel Well Opening &
Fender Flare Screw Grommet
Screw Size: M6.3-1.81 (#14)
Head Size: 12mm x 16mm
Stem Length: 10mm
Overall Height: 12mm

Use with Auveco 22281
Nissan Juke & Rogue 2011 - On

UNIT PACKAGE: 15



20736

(01281-01081)
Natural Nylon

Front Bumper Nylon Nut
Screw Size: M4.8 (#10)
Flange Diameter: 16mm
Overall Length: 22mm
Nissan & Infiniti 1997 - On

UNIT PACKAGE: 15



22176

(Nissan: 01281-00431)
Natural Nylon

Screw Grommet
Screw Size: M6 (#14)
Head Size: 14mm x 14mm
Overall Height: 19mm
Nissan Murano 2003 - On

UNIT PACKAGE: 25



14690

(Nissan: 78856-R4301,
Honda: 90683-693-000)
White Nylon

Screw Grommet
Screw Size: #10
Width: 12mm
Length: 19mm
Stem Length: 17mm
Fits into 8mm x 15mm Hole

UNIT PACKAGE: 25



22059

(Nissan: 76848-54C00)
Black Nylon

Rear Taillight Assembly & Exterior
Rocker Moulding Grommet with Sealer
Head Diameter: 18mm
Stem Diameter: 8.5mm
Stem Length: 14mm
Nissan 2003 - On

UNIT PACKAGE: 25



21622

(76848-71S00)
Yellow Nylon

Pillar Moulding Grommet with Sealer
Screw Size: M5.5 (#12)
Head Size: 15.4mm x 19mm
Stem Length: 15mm
Nissan 370Z & Quest and
Infiniti G37 & Q45 2002 - On

UNIT PACKAGE: 15



20786

(76848-8J010)
Black Nylon

Headlight Assembly Grommet
Head Size: 17mm x 23mm
Stem Length: 10mm
Altima 2002 - On

UNIT PACKAGE: 10



21688

(Nissan: 01553-02923)
White Nylon

Moulding Grommet with Sealer
Head Size: 14mm x 18mm
Stem Length: 13mm
Infiniti M45 & Q45 and Nissan Armada,
Frontier, Pathfinder & Xterra 1996 - On

UNIT PACKAGE: 25



17196

(62380-U7400)
Black Nylon

Grille Grommet
Width: 22mm
Length: 26mm
Nissan 1987 - On

UNIT PACKAGE: 10



22287

(Nissan: 62319-AU000)
Black Nylon

Front Bumper & Grille Screw Grommet
Head Size: 13.5mm x 23.5mm
Stem Length: 13mm
Overall Height: 15mm
Infiniti G37, M35, M45, QX56 &
QX80 and Nissan Rogue 2006 - On

UNIT PACKAGE: 15



22218

(Nissan: 85284-EG000)
Yellow Nylon

Rear Bumper Clip
Width: 20mm
Length: 32mm
Overall Height: 25mm
Nissan GT-R and Infiniti G,
Q40, FX & QX70 2009 - On

UNIT PACKAGE: 15



21318

(01281-0005U)
Black Nylon

Grille Grommet
Head Diameter: 20mm
Stem Length: 13mm
Fits into 11mm Hole
Frontier & Titan 2005 - On

UNIT PACKAGE: 25



20813

(63846-9E000)
Natural Nylon

Rear Bumper
Moulding Grommet with Sealer
Head Size: 18mm x 18mm
Stem Length: 15mm
Altima 2001 - 1998

UNIT PACKAGE: 15



22255

(Nissan: 76848-ED000)
Light Blue Nylon

Rocker & Door Trim Panel Grommet
Head Diameter: 15mm
Stem Diameter: 8mm
Stem Length: 15mm
Infiniti Q60 Coupe and Nissan 350Z &
Versa 2014 - 2006

UNIT PACKAGE: 25



22128

(Nissan: 66820-9N00A)
Black Nylon

Cowl & Dash
Retaining Clip
Width at Bottom Legs:
19mm
Overall Height: 29.5mm
Nissan 370Z, Leaf &
Maxima 2009 - On

UNIT PACKAGE: 25



19736

(76988-3J000)
White Nylon

Kick Plate Retainer Grommet
Head Size: 14mm x 34mm
Stem Length: 14mm
Altima 1997-On

UNIT PACKAGE: 15



21850

(Nissan: 26398-ED000)
White Nylon

Tail Light Clip
Top Head Size: 13mm x 13mm
Bottom Head Diameter: 19mm
Stem Length: 10mm
Infiniti M37, M56 & M Hybrid 2013 - On
Nissan Armada, Juke, Pathfinder,
Sentra & Versa 2006 - On

UNIT PACKAGE: 25



20790

(85222-0M000)
Black Nylon

Rear Bumper
Fascia Clip with Sealer
Overall Height: 35mm
Stem Length: 16mm
Pathfinder 2004 - On

UNIT PACKAGE: 5



17633

(66820-88E00)
Nylon

Cowl Screen Pin Retainer
Maxima 1990-On

UNIT PACKAGE: 25



21689
 (Nissan: 66820-61U00)
 Black Nylon

Cowl Grille Retainer
 Head Diameter: 11mm
 Stem Diameter: 4.5mm
 Stem Length: 15mm
 Infiniti M45 & Q45 and
 Nissan Sentra 1997 - On

UNIT PACKAGE: 25



17634
 (01553-01781)
 Black Nylon

Cowl Grille Retainer
 Head Diameter: 12mm
 Stem Length: 16mm
 Stem Diameter: 6mm
 240SX 1990-On

UNIT PACKAGE: 25



21588
 (80850-CA003)
 Black Nylon

Weatherstrip Retainer
 Head Diameter: 8mm
 Stem Diameter: 5.3mm
 Stem Length: 7mm
 Murano & Rouge 2003 - On

UNIT PACKAGE: 25



14355
 (01553-00401)
 Black Nylon

Retaining Clip
 Head Diameter: 11mm
 Stem Length: 13mm
 Snaps into 5mm Hole
 Panel Range: 4mm

UNIT PACKAGE: 50



21295
 (01553-08961)
 Black Nylon

Weatherstrip Retaining Clip
 Head Diameter: 10mm
 Stem Diameter: 6mm
 Stem Length: 8mm
 Altima 2009 - On

UNIT PACKAGE: 25



14349
 (Mazda: 9926-40-543;
 Nissan: 01553-00291)
 Black Nylon

Retaining Clip
 Head Diameter: 11mm
 Stem Length: 15mm
 Panel Thickness: 5mm
 Fits into 5.5mm Hole

UNIT PACKAGE: 50



22060
 (Nissan: 65810-K2002)
 Black Nylon

Hood Seal Retaining Clip
 Head Size: 6.5mm x 16mm
 Stem Diameter: 3.5mm x 5.5mm
 Stem Length: 8mm
 Infiniti 2003 - 1997
 Nissan 2003 - 1996

UNIT PACKAGE: 25



14352
 (76876-W5000)
 Black Nylon

Retaining Clip
 Head Diameter: 13mm
 Stem Length: 13mm
 Panel Thickness: 4mm
 Fits into 5mm Hole

UNIT PACKAGE: 50



21229
 (65810-K2000)
 Black Nylon

Hood Seal Retaining Clip
 Head Size: 6.4mm x 16mm
 Stem Diameter: 3.5mm x 6mm
 Stem Length: 10mm
 Nissan Maxima & Pathfinder and
 Infiniti I30, I35, Q45 & QX4 2004 - 1996

UNIT PACKAGE: 25



17452
 (01553-00545)
 Black Nylon

Bumper Fascia Retainer
 Head Diameter: 13mm
 Stem Length: 15mm
 Fits into 5mm Hole
 Sentra 1990-On

UNIT PACKAGE: 25



14737

(Nissan: 01553-00172;
Toyota: 90467-07050)
Black Nylon

Retaining Clip
Head Diameter: 13mm
Stem Length: 15mm
Panel Thickness: 3mm
Fits into 5mm Hole

UNIT PACKAGE: 25



14723

(62869-N4700)
Black Nylon

Retaining Clip
Head Diameter: 14mm
Stem Length: 11mm
Panel Thickness: 4mm
Fits into 6mm Hole

UNIT PACKAGE: 25



14353

(76906-T3000)
Black Nylon

Retaining Clip
Head Diameter: 14mm
Stem Length: 16mm
Panel Thickness: 5mm
Snaps into 6mm Hole

UNIT PACKAGE: 50



14348

(27948-M7002)
Black Nylon

Retaining Clip
Head Diameter: 16mm
Stem Length: 15mm
Panel Thickness: 4mm
Snaps into 5mm Hole

UNIT PACKAGE: 25



20381

(Honda: 90667-671-013ZA;
Mitsubishi: MC440901;
Nissan: 62660-48600-1)
Black Nylon

Trim Panel Retaining Clip
Head Diameter: 16mm
Stem Diameter: 7mm
Stem Length: 16mm
Honda, Mitsubishi & Nissan

UNIT PACKAGE: 25



14347

(Nissan: 01553-00202;
Toyota: 90467-10018)
Black Nylon

Retaining Clip
Head Diameter: 18mm
Stem Length: 12mm
Panel Thickness: 4mm
Snaps into 7mm Hole
Nissan & Toyota

UNIT PACKAGE: 50



20671

(01553-0052U)
Black Nylon

Trim Panel Retaining Clip
Head Diameter: 20mm
Stem Diameter: 9.5mm
Stem Length: 15mm
Frontier Xterra 2000 - On

UNIT PACKAGE: 25

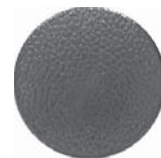

**FasTrack Web is your next step to savings.
Recover money spent on repair fasteners
during collision repair jobs.**

**Go to www.auveco.com to learn more about
Auveco's FasTrack Web
"Your body shop cost recovery system."**



14356

(01553-00051)
Black Nylon

Retaining Clip
Head Diameter: 20mm
Stem Length: 16mm
Panel Thickness: 7mm
Snaps into 7mm Hole

UNIT PACKAGE: 50



22286

(Nissan: 80287-37F00)
Natural Nylon

Front Door, Garnish &
Interior Trim Retaining Clip
Head Diameter: 14mm
Stem Length: 10mm
Overall Height: 11.5mm
Infiniti FX35, FX45, G35, G37 &
Q60 and Nissan Murano 2015 - 2003

UNIT PACKAGE: 25



18948

(Nissan: 01553-0075U; GM: 1644290)
Black Nylon

Hood Insulation Retainer
Head Diameter: 11mm
Stem Diameter: 5.5mm
Stem Length: 17.5mm
Altima & Maxima 2002 - On

UNIT PACKAGE: 25



16775

(Honda: 90667-SA7-003;
Nissan: 89427-98070)
Black Nylon

Trim Panel Retainer
Head Diameter: 20mm
Stem Length: 15mm
Fits into 5mm Hole

UNIT PACKAGE: 25



21519

(01553-01A50)
Black Nylon

Bumper & Trim Retainer
Head Diameter: 12mm
Stem Diameter: 6mm
Stem Length: 15mm
Infiniti FX35, G35, G37, M35, M45 & Q45
and Nissan 350Z & 370Z 1997 - On

UNIT PACKAGE: 25



21288

(65846-4Z000)
Black Nylon

Hood Insulation Retainer
Head Diameter: 28mm
Stem Diameter: 6mm
Stem Length: 10mm
Altima 2010 - On

UNIT PACKAGE: 15



20256

(01553-01182)
Black Nylon

Splash Shield Retainer
Head Diameter: 15mm
Stem Diameter: 4.5mm
Stem Length: 14mm
Frontier Truck 1997 - On

UNIT PACKAGE: 50



17237

(65832-F5000, 65846-30F00)
Black Nylon

Hood Insulation Retainer
Outer Diameter: 29.5mm
Stem Diameter: 7mm
Stem Length: 9mm
Nissan 1981-On

UNIT PACKAGE: 15



16776

(Honda: 90667-SA0-003;
Nissan: 76996-01P02)
Black Nylon

Trim Panel Retainer
Head Diameter: 18mm
Stem Length: 20mm
Fits into 6mm Hole

UNIT PACKAGE: 25



20672

(66820-3S500-C1)
White Nylon

Cowl Vent Retainer
Top Head Diameter: 13mm
Bottom Head Diameter: 16mm
Stem Diameter: 4mm
Stem Length: 13mm
Frontier & Xterra 1998 - On

UNIT PACKAGE: 25



22075

(Nissan: 01553-06451)
Black Nylon

Upper Quarter Trim &
Rear Trunk Seal Retainer
Head Diameter: 20mm
Stem Diameter: 8.7mm
Stem Length: 16mm

Infiniti G35, J30, JX60, M35, M37, M56, Q45, Q50 &
QX60 and Nissan Altima, Pathfinder & Quest 1996 - On

UNIT PACKAGE: 25



22063

(Nissan: 01553-02903)
White Nylon

Front Side Lower Fender
Panel Bracket Retainer
Top Head Diameter: 13mm
Bottom Head Diameter: 12mm
Stem Length: 14mm
Overall Length: 21mm
Infiniti Qx4 & Qx56 and Nissan Pathfinder,
Frontier & Xterra 2010 - 1997

UNIT PACKAGE: 25



21289
(84953-JA00A)
Yellow Nylon

Trim Panel Retainer
Top Head Diameter: 12.5mm
Middle Head Diameter: 16mm
Bottom Head Diameter: 18mm
Stem Diameter: 9.5mm
Stem Length: 14mm
Altima 2010 - On

UNIT PACKAGE: 25



19731
(84915-0W000)
White Nylon

Trim Panel Retainer
Top Head Diameter: 13mm
Middle Head Diameter: 16mm
Bottom Head Diameter: 17mm
Stem Diameter: 9.5mm
Stem Length: 13mm
Pathfinder 1995 - On

UNIT PACKAGE: 15



20669
(01553-07111)
Black Nylon

Trim Panel Retainer
Top Head Diameter: 13mm
Middle Head Diameter: 15mm
Bottom Head Diameter: 18mm
Stem Diameter: 9mm
Stem Length: 15mm
Nissan Altima and
Infiniti G35 & Q45 1997 - On

UNIT PACKAGE: 25



21998
(Nissan: 01553-08101)
Yellow & White Nylon

Trim Panel Retainer
Top Head Diameter: 13mm
Middle Head Diameter: 16mm
Bottom Head Diameter: 17mm
Stem Length: 9mm
Overall Length: 18.5mm
Fits into 8mm Hole
Nissan

UNIT PACKAGE: 10



21414
(80999-VE000)
White Nylon

Trim Panel Retainer with Sealer
Top Head Diameter: 13mm
Middle Head Diameter: 16mm
Bottom Head Diameter: 18mm
Stem Diameter: 9mm
Stem Length: 13mm
Infiniti & Nissan 1993 - On

UNIT PACKAGE: 25



22237
(Nissan: 01553-30001)
White Nylon

Trim Panel Retainer
Top Head Diameter: 13mm
Middle Head Diameter: 16.5mm
Bottom Head Diameter: 18mm
Stem Diameter: 9mm
Stem Length: 13mm
Nissan Altima, Cube, GT-R, Murano,
Pathfinder, Quest, Rogue, Sentra,
Versa & Versa Note 2007 - On

UNIT PACKAGE: 25



21701
(Nissan: 85284-4J500)
Black Nylon

Retainer with Sealer
Top Head Diameter: 13mm
Middle Head Diameter: 16mm
Bottom Head Diameter: 18mm
Stem Diameter: 10mm
Stem Length: 11mm
Overall Length: 17mm
Infiniti I35 and Nissan Altima,
Cube & Maxima 2011 - 02

UNIT PACKAGE: 10



20668
(01553-09791)
White Nylon

Trim Panel Retainer
Top Head Diameter: 13mm
Middle Head Diameter: 16mm
Bottom Head Diameter: 18mm
Stem Diameter: 9mm
Stem Length: 14mm
Nissan & Infiniti 1999 - On

UNIT PACKAGE: 15



20670
(01553-02821)
Gray Nylon

Trim Panel Retainer
Top Head Diameter: 13mm
Middle Head Diameter: 16mm
Bottom Head Diameter: 18mm
Stem Diameter: 8.5mm
Stem Length: 12mm
Maxima 1988 - On

UNIT PACKAGE: 15



13945
(01553-S3500)
White Nylon

Door Trim Panel Retainer
Trucks

UNIT PACKAGE: 50



18166
(80875-85E00)
Black Nylon

Trim Panel Retainer
Head Diameter: 10mm
Stem Length: 10mm
Stem Diameter: 4mm
Maxima 1989-On

UNIT PACKAGE: 25



21633
(80850-89900)
White Nylon

Weatherstrip Retainer
Head Size: 6mm x 16mm
Stem Diameter: 6.5mm
Stem Length: 12mm
Nissan Maxima and
Infiniti I30, I35 & M45 2004 - 2000

UNIT PACKAGE: 25



19724
(65810-K2009)
White Nylon

Hood to Cowl
Seal Retainer
Head Size: 6mm x 16mm
Stem Length: 15mm
Fits into 5mm Hole
Infiniti & Pathfinder 1992 - On

UNIT PACKAGE: 25



19684
(01553-09311)
Blue Nylon

Weatherstrip Retainer
Head Size: 7mm x 16mm
Stem Length: 12mm
Fits into 6mm Hole
Altima & Sentra 1994-On

UNIT PACKAGE: 25



22107
(Nissan: 80850-JM01A)
Black Nylon

Weatherstrip Retainer
Head Size: 6mm x 15mm
Stem Size: 5.6mm x 7mm
Stem Length: 12mm
Overall Length: 16mm
Nissan Rogue 2008 - On

UNIT PACKAGE: 25



16783
(66824-01G00)
Black Nylon

Push-Type Retainer
Head Diameter: 12mm
Stem Length: 8mm (Excluding the Pin)
Fits into 6mm Hole

UNIT PACKAGE: 25



21159
(66820-AX020)
Black Nylon

Cowl Vent & Outside Mirror
Push-Type Retainer
Head Diameter: 14mm
Stem Length: 10mm
Fits into 6mm Hole
Pathfinder & Versa 2005 - On

UNIT PACKAGE: 15



16859
(Nissan: 66860-01W01;
GM: 94051993)
Black Nylon

Cowl Panel to Reinforcement Plate &
Engine Splash Shield Retainer
Head Diameter: 14mm (9/16")
Stem Length: 16mm (5/8")
Fits into 6mm (1/4") Hole
Nissan 1980-On
Geo Storm 1990-On

UNIT PACKAGE: 25



14696

(Nissan: 10998-30880;
Honda: 90684-SA5-003;
Isuzu: 8942981190)
Black Nylon



Push-Type Retainer
Head Diameter: 15mm
Stem Length: 11mm
Fits into 6mm Hole

UNIT PACKAGE: 25



21620

(01553-06071)
Black Nylon

Rear Duct Finishing Panel
Push-Type Retainer
Head Diameter: 15mm
Stem Length: 14mm
Fits into 5mm Hole
Cube S, SL, Krom & Leaf 2012 - On

UNIT PACKAGE: 15



18265

(76882-57A00)
Black Nylon

Body Side Moulding
Push-Type Retainer
Head Diameter: 16mm
Stem Length: 20mm
Fits into 8mm Hole
Sentra 1986-On

UNIT PACKAGE: 25



14726

(63844-01A99)
Black Nylon

Push-Type Retainer
Head Diameter: 17mm
Stem Length: 18mm
Fits into 8mm Hole

UNIT PACKAGE: 25



16784

(Nissan: 80999-05N07;
Toyota: 90467-07043)
Black Nylon

Push-Type Retainer
Head Diameter: 18mm
Stem Length: 11mm (Excluding the Pin)
Fits into 7mm Hole

UNIT PACKAGE: 25



22039

(Nissan: 01553-2DR9A)
Black Nylon

Push-Type Retainer
Top Head Diameter: 16mm x 19mm
Bottom Head Diameter: 20mm
Stem Length: 12mm
Fits into 8mm Hole
Infiniti G20, JX35, Q45 & QX60 and Nissan Frontier,
Maxima, NV, Pathfinder, Sentra,
Versa & Xterra 2002 - On

UNIT PACKAGE: 15



20349

(Nissan: 01553-09611;
Toyota: 90467-08185)
Black Nylon

Bumper Clip
Push-Type Retainer
Head Diameter: 18mm
Stem Length: 10mm (Excluding the Pin)
Fits into 8mm Hole
Maxima 1994 - On
Toyota & Lexus 2002 - On

UNIT PACKAGE: 15



21311

(01553-0038U)
Gray Nylon

Bumper Push-Type Retainer
Head Diameter: 18mm
Stem Length: 12mm
Fits into 8mm Hole
Frontier, Pathfinder & Xterra 2005 - On

UNIT PACKAGE: 10



19246

(01553-09241)
Black Nylon

Bumper Push-Type Retainer
Head Diameter: 18mm
Stem Length: 15mm
Fits into 10mm Hole
240SX & Maxima 1994-On

UNIT PACKAGE: 15



21876

(Renault & Dacia: 05-40-000-1R;
Nissan: 01515-00Q0C)
Black Nylon

Bumper Push-Type Retainer
Head Diameter: 18mm
Stem Length: 18mm
Fits into 9mm Hole
Renault, Dacia & Nissan

UNIT PACKAGE: 15



20613
(63848-40Y00)
Black Nylon

Front Bumper Push-Type Retainer
Head Diameter: 18mm
Stem Length: 20mm
Fits into 9mm Hole
Frontier & Xterra 1998 - On

UNIT PACKAGE: 15



20327
(63848-9E001)
Black Nylon

Bumper Fascia
Push-Type Retainer
Head Diameter: 18mm
Stem Length: 19mm (Excluding the Pin)
Fits into 9mm Hole
Altima 1997 - On

UNIT PACKAGE: 10



16782
(Honda: 91545-SE0-003-W;
Nissan: 63848-01G00)
Black Nylon

Push-Type Retainer
Head Diameter: 20mm
Stem Length: 8mm (Excluding the Pin)
Fits into 8mm Hole

UNIT PACKAGE: 25



21631
(84995-3J101)
Black Nylon

Push-Type Retainer
Head Diameter: 20mm
Stem Length: 8mm (Excluding the Pin)
Fits into 8mm Hole
Sentra 2007 - On

UNIT PACKAGE: 15



21134
(01553-09431)
Black Nylon

Front Bumper Push-Type Retainer
Head Diameter: 20mm
Stem Length: 11mm (Excluding the Pin)
Fits into 8mm Hole
Maxima 2004 - On

UNIT PACKAGE: 15



21545
(01553-08231)
Black Nylon

Front & Rear Bumper
and Grille Push-Type Retainer
Head Diameter: 20mm
Stem Length: 15mm
Fits into 8mm Hole
Nissan Murano, 240 SX & 350Z
and Infiniti FX35, FX45 & Q45 1995 - On

UNIT PACKAGE: 25



16858

(Nissan: 63844-01A00;
Kia: MNA01-56-145;
Mazda: NA01-56-145;
Ford: MNA01-56145, NA01-56145)
Black Nylon

Inner Fender Push-Type Retainer
Head Diameter: 20mm (25/32")
Stem Length: 18mm (23/32")
Fits into 8mm (5/16") Hole
Nissan 1980-On
Mazda, Kia & Ford

UNIT PACKAGE: 25



16000

(Honda: 90675-SB3-003;
Mazda: FB01-56-964;
Nissan: 63876-95596)
Black Nylon

Push-Type Retainer
Head Diameter: 20mm
Stem Length: 9mm
Fits into 8mm Hole

UNIT PACKAGE: 25



20348

(63878-01E10)
Black Nylon

Push-Type Retainer
Head Diameter: 20mm
Stem Length: 22mm
Fits into 8mm Hole
Maxima 1994 - On

UNIT PACKAGE: 15



19905

(01553-10051)
Black Nylon

Push-Type Retainer
Head Diameter: 20mm
Stem Length: 8mm (Excluding the Pin)
Fits into 8mm Hole
Maxima 1999 - On

UNIT PACKAGE: 15



19274
(01553-09321)
Black Nylon

Push-Type Retainer
Head Diameter: 20mm
Stem Length: 9mm (Excluding the Pin)
Fits into 8mm Hole
Maxima & 300ZX 1994-On

UNIT PACKAGE: 15



17472
(Mitsubishi: MB547806;
Nissan: 63854-01A00)
Black Nylon

Front Bumper Fascia
Push-Type Retainer
Head Diameter: 20mm
Stem Length: 20mm
Fits into 8mm Hole
300ZX 1990-On

UNIT PACKAGE: 15



21192
(Nissan: 01553-05323)
(Mazda: L33X13209)
Black Nylon

Cowl, Bumper & Fender Liner
Push-Type Retainer
Head Diameter: 20mm
Stem Length: 12mm
Fits into 8mm Hole
Infiniti FX35, FX45, G35
and Nissan 2003 - On
Mazda 2, 3, 5, 6, CX-5, CX-7
& CX-9 2007 - On

UNIT PACKAGE: 10



17378
(01553-03101)
Black Nylon

Bumper & Fascia
Push-Type Retainer
Head Diameter: 22mm
Stem Length: 14mm
Fits into 11mm Hole
Nissan 1986 - On

UNIT PACKAGE: 15



20953
(11296-AG000)
Black Nylon

Front Bumper and Radiator Support
Push-Type Retainer
Head Diameter: 20mm
Stem Length: 13mm (Excluding the Pin)
Fits into 8mm Hole
Infiniti FX 35/45 and Nissan Altima,
Maxima & Quest 2002 - On

UNIT PACKAGE: 25



20753
(01553-03201)
Black Nylon

Front & Rear Bumper
Push-Type Retainer
Head Diameter: 22mm
Stem Length: 21mm
Fits into 8mm Hole
Nissan 1982 - On

UNIT PACKAGE: 10



17347
(01553-06721)
Black Nylon

Front & Rear Bumper Cover
Push-Type Retainer
Head Diameter: 20mm
Stem Length: 11mm (Excluding the Pin)
Fits into 8mm Hole
Maxima & Infiniti 1990 - On

UNIT PACKAGE: 15



17350
(Honda 91516-SK7-013;
Nissan 01553-00344)
Black Nylon

Splash Shield Push-Type Retainer
Phillips Drive
Hex: 10mm
Head Diameter: 20mm
Stem Length: 15mm
Fits into 8mm Hole
Civic 1992 - On
Nissan XTerra, Frontier, &
Quest 1999 - On

UNIT PACKAGE: 10



21361
(GM: 11561874;
Nissan: 622A2-9E000A)
Black Nylon

Bumper Cover Push-Type Retainer
Head Diameter: 25mm
Stem Length: 29mm
Fits into 7mm Hole
Chevrolet Malibu 2008 - On
Saturn Aura 2007 - On
Pontiac G6 2010 - On
Nissan Altima 1997 - On

UNIT PACKAGE: 15



16725
(66814-01G00)
Black Nylon

Cowl Grille Retainer
Head Size: 8mm x 12mm
Stem Length: 8mm
Fits into 6mm Square Hole
Nissan Pick-Up 1986 - On

UNIT PACKAGE: 25



14725
(66824-W1000)
Black Nylon

Push-Type Retainer
Head Width: 12mm
Head Length: 18mm
Stem Length: 10mm
Fits into 6mm Hole

UNIT PACKAGE: 15



14727
(Nissan: 63844-D0100;
GM: 94221150; Isuzu: 8942211500)
Black Nylon

Push-Type Retainer
Screw: 5mm x 14mm
Head Size: 14mm x 22mm
Stem Length: 9mm
Fits into 7mm Hole

UNIT PACKAGE: 25



16843
(Mazda: BF82-50-233;
Nissan: 01553-01393)
Black Nylon

Bumper Cover Retainer
Head Size: 20mm x 30mm
Stem Length: 18mm
Fits into 10mm Hole

UNIT PACKAGE: 10



22275
(Nissan: 28945-CA000)
Black Nylon

Tube/Cable Routing Clip
Holds 7mm Diameter Tube/Cable
Overall Height: 21.5mm
Nissan Murano & Rogue 2012 - On

UNIT PACKAGE: 25



21999
(Nissan: 01552-00661)
Natural Nylon

Tube/Cable Routing Clip
Tube/Cable Diameter: 5mm
Snaps into 6mm Hole
Nissan

UNIT PACKAGE: 15



16780
(Nissan: 99604-H1400;
Toyota: 58788-13010)
Natural Nylon

Hood Prop Rod Clip
Holds 11mm Diameter Rod
Fits into 10mm x 12mm Hole

UNIT PACKAGE: 10



22362
(Nissan: 65722-50A00)
Natural Nylon

Hood Prop Rod Clip
Holds 8mm Diameter Rod
Overall Height: 20.5mm
Fits into 8mm Square Hole
Nissan Juke 2013 - 2011

UNIT PACKAGE: 15



14337
(84653-N7400)
Black Nylon

Tube/Cable Routing Clip
Holds 5mm Tube or Cable
Snaps into 5mm Hole

UNIT PACKAGE: 25



14345
(24220-89986)
White Nylon

Hood Prop Rod Clip
Holds 10mm Rod
Snaps into 8mm Hole

UNIT PACKAGE: 10



21309
(65722-EA000)
Black Nylon

Hood Prop Rod Clip
Rod Size: 8mm
Overall Length: 33mm
Frontier, Pathfinder & Xterra 2005 - On

UNIT PACKAGE: 10

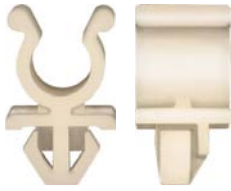

22358

(Nissan: 65722-01E00)
White Nylon

Hood Prop Rod Clip
Holds 8mm Diameter Rod
Overall Height: 23mm
Fits into 9mm Hole

Infiniti G20 & QX4 2003 - 1991

Nissan 200SX, 240SX, 300ZX, 370Z, Altima, Frontier,
Pathfinder, Sentra, Stanza & Xterra 1986 - On

UNIT PACKAGE: 15



21646

(80874-AX000)
Black Nylon

Hole Plug
Head Diameter: 25mm
Fits into 18mm Hole

Nissan Juke & Murano and Infiniti EX35 2003 - On

UNIT PACKAGE: 25



21637

(01553-05131)
Black Nylon

Wheel Liner, Cowl Insulator
& Trim Flange Clip
Flange Diameter: 25mm
Hex: 10.5mm

Overall Height: 12.5mm

Nissan 370Z, Altima, Cube, Frontier, GT-R, Juke, Leaf,
Maxima, Murano, NV, Pathfinder, Quest, Rouge, Versa
& Xterra and Infiniti EX35, FX35, FX50, G25, G35,
G37, J30, M35, M45 & Q45 1993 - On

UNIT PACKAGE: 15

20380

(Not Supplied by O.E.M.)
Black Nylon



Photo not actual size
Cable Strap

Width: 5mm (3/16")

Length: 200mm (8")

Max. Bundle Diameter: 44mm (1-3/4")

Fits into 6.3mm (1/4") Hole

Import Cars

UNIT PACKAGE: 25

21259

(24225-89960)
Black Nylon



Photo not actual size
Cable Strap

Overall Length: 200mm (8")

Width: 8mm (5/16")

Maximum Bundle Diameter: 55mm (2-3/16")

Snaps into 8mm (5/16") Hole

Nissan 2005 - On

UNIT PACKAGE: 25



16340

(54229-0201P)
Zinc

Window Crank Handle
Retaining Clip

UNIT PACKAGE: 100



19147

(62228-51S00)

Front Bumper Retainer
300ZX 1992 - On

UNIT PACKAGE: 10



22198

(Nissan: 11296-3TA0A)
Zinc Organic

Trim Retaining Clip
Overall Height: 18.5mm
Width from Ear to Ear: 11mm
Nissan Altima 2013 - On

UNIT PACKAGE: 50



21664

(63848-9Y000)
Black Nylon

Fender Apron Clip
Width: 20mm

Width at Wings: 30mm
Overall Length: 30mm

Nissan Altima, Maxima, Murano, Pathfinder, Quest &
370Z and Infiniti EX35, FX35, FX50, G35,
G37, M35, M37, M45 & M56 2005 - On

UNIT PACKAGE: 10



21017

(76882-0M000)
White Nylon

Nylon U-Nut

Screw Size: M4.8 (#10)

Panel Range: Up to 1.5mm

Center of Hole to Edge: 8mm

Nissan & Infiniti 1995 - On

UNIT PACKAGE: 15



17193

(63848-D0100)
Black Nylon

Nylon U-Nut

Fender/Wheel Housing

Screw Size: M5.5 (#12)

Width: 20mm

Length: 20mm

Panel Range: Up to 1mm

Center of Hole to Edge: 9mm

UNIT PACKAGE: 15



19735

(63848-35F00)
Black Nylon

Fender Clip U-Nut
Screw Size: M4.8 (#10)
Width: 20mm
Length: 32mm
Panel Range: Up to 2mm
Center of Hole to Edge: 8mm
Maxima & 240SX 1994 - On

UNIT PACKAGE: 15

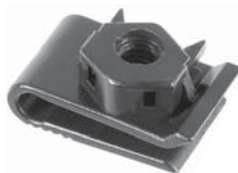

21459

(01241-00881)
Black Nylon

Nylon U-Nut
with Captive Metal Hex Nut
Thread: M6 - 1.0
Center of Hole to Edge: 14mm
Panel Range: Up to 4mm
Nissan Altima, Maxima &
240SX and Infiniti I30 2001 - 1993

UNIT PACKAGE: 10

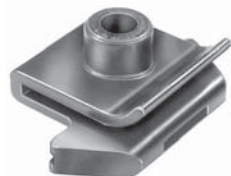

17385

(63848-D4000)
Black Nylon

Nylon U-Nut
Fender/Wheel Housing
Screw Size: M5.5 (#12)
Width: 31mm
Length: 22mm
Panel Range: Up to 2mm
Center of Hole to Edge: 9mm
Sentra

UNIT PACKAGE: 10



13225

Plated

U-Type Nut
Screw Size: 4.2mm (#8)
Width: 11mm
Length: 16.5mm
Panel Range: .5mm-2.5mm
Center of Hole to Edge: 8mm

UNIT PACKAGE: 50

OPEL CLIPS & FASTENERS



12642

(1-74-713)
Nylon

Moulding Clip

UNIT PACKAGE: 10



19153

(1-74-820, 03467-531)
Nylon

Moulding Clip

UNIT PACKAGE: 25



21859

(Mercedes-Benz: 000-990-29-92,
000-990-60-92; 001-990-16-92, 114-990-01-92;
Opel: 1104882, 1719245;
Volvo: 9133417, 1268642)
Black Nylon

Push-Type Retainer
Head Diameter: 16mm
Stem Length: 11mm
Fits into 8mm Hole
Mercedes-Benz, Opel & Volvo 1985 - On

UNIT PACKAGE: 15



13216

Zinc

U-Type Nut
Screw Size: 4.8mm
Panel Range: .9mm-2.0mm
Center of Hole to Edge: 8mm

UNIT PACKAGE: 25



13220

(Mercedes: 000-994-09-45;
Volvo: 946-418; Opel: 20-72-175)
Plated

U-Type Nut
Screw Size: 6.3mm
Panel Range: .7mm-1.5mm
Center of Hole to Edge: 13mm

UNIT PACKAGE: 50

PEUGEOT AND CITROEN CLIPS & FASTENERS

Sec. 22



21929

(Peugeot & Citroen: 6987.A1)
Black Nylon

Nylon Nut
Screw Size: M2.9 (#4)
Head Size: 9.5mm x 9.5mm
Stem Length: 7mm
Peugeot, Citroen, Renault & Dacia

UNIT PACKAGE: 50



21874

(Peugeot & Citroen: 7427.46;
Renault & Dacia: 77-03-081-184)
White Nylon

Screw Grommet
Screw Size: M4.2 (#8)
Head Diameter: 15mm
Stem Length: 15mm
Peugeot, Citroen, Renault & Dacia

UNIT PACKAGE: 25



21962

(Peugeot & Citroen: 7136.A5)
White Nylon

Nylon Nut
Screw Size: M4.2 (#8)
Head Size: 12mm x 12mm
Stem Length: 11mm
Peugeot & Citroen

UNIT PACKAGE: 15



21958

(Renault & Dacia: 77-03-081-233)
White Nylon

Screw Grommet
Screw Size: M2.9 (#4)
Head Size: 9.5mm x 15mm
Stem Length: 9mm
Peugeot, Citroen, Renault & Dacia

UNIT PACKAGE: 25



21931

(Peugeot & Citroen: 7136.J7;
Renault & Dacia: 77-03-081-163)
Natural Nylon

Nylon Nut
Screw Size: M2.9 (#4)
Head Size: 13mm x 13mm
Stem Length: 10mm
Peugeot, Citroen, Renault & Dacia

UNIT PACKAGE: 25



21960

(Peugeot & Citroen: 6997.96;
Renault & Dacia: 77-03-081-185)
Natural Nylon

Screw Grommet
Screw Size: M2.9 (#4)
Head Size: 13mm x 20mm
Stem Length: 15mm
Peugeot, Citroen, Renault & Dacia

UNIT PACKAGE: 15



21965

(Peugeot & Citroen: 6991.39)
Natural Nylon

Nylon Nut
Screw Size: M6 (#14)
Head Size: 16mm x 16mm
Stem Length: 10mm
Peugeot & Citroen

UNIT PACKAGE: 25



21964

(Peugeot & Citroen: 7410.E2)
Natural Nylon

Screw Grommet
Screw Size: M2.9 (#4)
Top Head Size: 11mm x 18mm
Bottom Head Size: 14mm x 21mm
Overall Length: 17mm
Peugeot & Citroen

UNIT PACKAGE: 10



21963

Light Gray Nylon

Screw Grommet
Screw Size: M2.9 (#4)
Head Diameter: 16mm
Stem Length: 15mm
Peugeot & Citroen

UNIT PACKAGE: 10



21959

(Peugeot & Citroen: 6990.62;
Renault & Dacia: 77-03-081-134)
Black Nylon

Screw Grommet
Screw Size: M3.5 (#6)
Head Size: 13.5mm x 20mm
Stem Length: 15mm
Peugeot, Citroen, Renault & Dacia

UNIT PACKAGE: 10

**PEUGEOT AND CITROEN
CLIPS & FASTENERS**



21961

(Peugeot & Citroen: 8749.ZA;
Renault & Dacia: 77-03-081-232)
Natural Nylon

Screw Grommet with Black Rubber Sealer
Screw Size: M4.2 (#8)
Head Size: 10.5mm x 17.5mm
Stem Length: 15mm
Peugeot, Citroen, Renault & Dacia

UNIT PACKAGE: 10



21979

(Peugeot & Citroen: 6992.S2)
Natural Nylon

Tubular Nut
Inside Diameter: 6mm
Head Diameter: 12mm
Stem Length: 25mm
Peugeot & Citroen

UNIT PACKAGE: 15



21942

(Peugeot & Citroen: 6983.24)
Black Nylon

Trim Retaining Clip
Head Diameter: 9.3mm
Stem Diameter: 6.5mm
Stem Length: 13mm
Peugeot & Citroen

UNIT PACKAGE: 25



21943

(Peugeot & Citroen: 8749.Q5)
Gray Nylon

Trim Retaining Clip
Head Diameter: 12mm
Stem Diameter: 7.5mm
Stem Length: 13mm
Peugeot & Citroen

UNIT PACKAGE: 25



21880

(Peugeot & Citroen: 6999.T4)
Black Nylon

Weatherstrip Retaining Clip
Head Diameter: 12mm
Stem Diameter: 7mm
Stem Length: 10mm
Peugeot & Citroen

UNIT PACKAGE: 50



21919

Black Nylon

Weatherstrip Retaining Clip
Head Size: 7mm x 12mm
Stem Diameter: 7mm
Stem Length: 9mm
Peugeot, Citroen, Renault & Dacia

UNIT PACKAGE: 25



21918

(Peugeot & Citroen: 9025.J8)
Black Nylon

Weatherstrip Retaining Clip
Head Size: 7mm x 12mm
Stem Diameter: 8mm
Stem Length: 9mm
Peugeot, Citroen, Renault & Dacia

UNIT PACKAGE: 25



21920

Black Nylon

Weatherstrip Retaining Clip
Head Size: 9mm x 18mm
Stem Diameter: 8.5mm
Stem Length: 10mm
Peugeot, Citroen, Renault & Dacia

UNIT PACKAGE: 25



21949

Black Nylon

Weatherstrip Retainer
Head Size: 5mm x 12mm
Stem Diameter: 7mm
Stem Length: 10mm
Peugeot & Citroen

UNIT PACKAGE: 25



21879

(Peugeot & Citroen: 6995.V6)
Black Nylon

Hood Insulation Retainer
Head Diameter: 20mm
Stem Diameter: 8mm
Stem Length: 10mm
Peugeot & Citroen

UNIT PACKAGE: 25



21808

(Peugeot & Citroen: 6992.31)
White Nylon

Interior Trim Retainer
Head Diameter: 10mm
Stem Diameter: 8mm
Stem Length: 15mm
Peugeot & Citroen

UNIT PACKAGE: 25

PEUGEOT AND CITROEN CLIPS & FASTENERS

Sec. 22



21936

(Peugeot & Citroen: 6992.07)
Black Nylon

Trim Panel Retainer
Head Diameter: 11.5mm
Stem Diameter: 5.5mm
Stem Length: 12mm
Peugeot & Citroen

UNIT PACKAGE: 25



21868

(Peugeot & Citroen: 6999.R1;
Renault & Dacia: 77-03-077-174)
Black Nylon

Trim Panel Retainer
Head Diameter: 20mm
Stem Diameter: 8mm
Stem Length: 17mm
Peugeot, Citroen, Renault & Dacia

UNIT PACKAGE: 25



21878

(Peugeot & Citroen: 8964.57)
Black Nylon

Trunk Lining Retainer
Head Diameter: 14mm
Stem Diameter: 7.5mm x 8mm
Stem Length: 16mm
Peugeot & Citroen

UNIT PACKAGE: 25



21947

(Peugeot & Citroen: 7437.10)
Black Nylon

Trim Panel Retainer
Head Diameter: 16mm
T30 Torx® Drive
Stem Diameter: 5.5mm
Stem Length: 26mm
Peugeot & Citroen

UNIT PACKAGE: 10



21938

(Peugeot & Citroen: 7588.VX)
Black Nylon

Trim Panel Retainer
Head Diameter: 18mm
Stem Diameter: 7mm
Stem Length: 17mm
Peugeot & Citroen

UNIT PACKAGE: 25



21809

(Peugeot & Citroen: 6983.17)
Black Nylon

Retainer
Head Diameter: 21mm
Stem Diameter: 7.5mm
Stem Length: 23mm
Peugeot & Citroen

UNIT PACKAGE: 25



21940

(Peugeot & Citroen: 6992.95)
Black Nylon

Trim Panel Retainer
Head Diameter: 18mm
Stem Diameter: 7.3mm
Stem Length: 16mm
Peugeot & Citroen

UNIT PACKAGE: 25



21937

(Peugeot & Citroen: 6992.W9)
Black Nylon

Trim Panel Retainer
Head Diameter: 21mm
Stem Diameter: 7.7mm
Stem Length: 16mm
Peugeot & Citroen

UNIT PACKAGE: 25



21877

(Peugeot & Citroen: 6992.C6)
Black Nylon

Radiator Panel Retainer
Head Diameter: 19.5mm
Stem Diameter: 7mm
Stem Length: 13mm
Peugeot & Citroen

UNIT PACKAGE: 25



21939

(Peugeot & Citroen: 7589.V4)
Tan Nylon

Trim Panel Retainer
Head Diameter: 21mm
Stem Diameter: 7.7mm
Stem Length: 16mm
Peugeot & Citroen

UNIT PACKAGE: 15

**PEUGEOT AND CITROEN
CLIPS & FASTENERS**



21941
(Peugeot & Citroen: 9128.S1)
Light Gray Nylon

Trim Panel Retainer
Head Diameter: 21mm
Stem Diameter: 7.7mm
Stem Length: 16mm
Peugeot & Citroen

UNIT PACKAGE: 10



21977
(Renault & Dacia: 77-01-049-008)
White Nylon

Trim Panel Retainer
Top Head Diameter: 13mm
Bottom Head Diameter: 18mm
Stem Diameter: 11.5mm
Stem Length: 12mm
Peugeot, Citroen, Renault & Dacia

UNIT PACKAGE: 25



21975
(Peugeot & Citroen: 6991.43;
Renault & Dacia: 77-03-077-059)
White Nylon

Trim Panel Retainer
Top Head Diameter: 14mm
Bottom Head Diameter: 17mm
Stem Diameter: 9mm
Stem Length: 10mm
Peugeot, Citroen, Renault & Dacia

UNIT PACKAGE: 25



21871
(Peugeot & Citroen: 6995.A3;
Renault & Dacia: 77-03-077-111)
White Nylon

Trim Panel Retainer with Sealer
Top Head Diameter: 13mm
Bottom Head Diameter: 16.5mm
Stem Diameter: 8.7mm
Stem Length: 11mm
Peugeot, Citroen, Renault & Dacia

UNIT PACKAGE: 25



21814
(Peugeot: 6991.S6;
Renault: 77-03-077-468)
White Nylon

Door Panel Retainer
Top Head Diameter: 13mm
Middle Head Diameter: 16mm
Bottom Head Diameter: 18mm
Stem Diameter: 12mm
Stem Length: 11mm
Overall Length: 18.5mm
Renault, Dacia, Peugeot and Citroen

UNIT PACKAGE: 25



21974
(Peugeot & Citroen: 6992.82)
White Nylon

Trim Panel Retainer with Sealer
Top Head Diameter: 14mm
Middle Head Diameter: 17mm
Bottom Head Diameter: 17mm
Stem Diameter: 8.5mm
Stem Length: 11mm
Peugeot & Citroen

UNIT PACKAGE: 25



21916
(Peugeot & Citroen: 8335.TE;
Renault & Dacia: 82-00-700-969)
Yellow Nylon

Trim Panel Retainer
Top Head Diameter: 12.3mm
Middle Head Diameter: 15mm
Bottom Head Diameter: 18mm
Stem Diameter: 12mm
Stem Length: 13mm
Peugeot, Citroen, Renault & Dacia

UNIT PACKAGE: 25



21895
(Peugeot & Citroen: 6991.Z1;
Renault & Dacia: 82-00-909-084)
Blue Nylon

Trim Panel Retainer
Top Head Diameter: 13mm
Middle Head Diameter: 16mm
Bottom Head Diameter: 18mm
Stem Diameter: 12mm
Stem Length: 12mm
Peugeot, Citroen, Renault & Dacia

UNIT PACKAGE: 25



21944
(Peugeot & Citroen: 8742.G2)
Green & White Nylon

Trim Panel Retainer
Top Head Diameter: 12.5mm
Middle Head Diameter: 14mm
Bottom Head Diameter: 18mm
Stem Diameter: 10.5mm
Stem Length: 12mm
Peugeot, Citroen, Renault & Dacia

UNIT PACKAGE: 10



21978
(Peugeot & Citroen: 6992.J4)
White Nylon

Trim Panel Retainer
Top Head Diameter: 14mm
Middle Head Diameter: 16.5mm
Bottom Head Diameter: 17mm
Stem Diameter: 9mm
Stem Length: 10mm
Peugeot & Citroen

UNIT PACKAGE: 25

PEUGEOT AND CITROEN CLIPS & FASTENERS

Sec. 22



21822

(Peugeot & Citroen: 6822.LL)
White Nylon

Door Panel Retainer
Top Head Diameter: 13mm
Middle Head Diameter: 16mm
Bottom Head Diameter: 18mm
Stem Diameter: 8.5mm x 9mm
Stem Length: 14mm
Overall Length: 20mm
Peugeot, Citroen & Toyota

UNIT PACKAGE: 25



21976

(Peugeot & Citroen: 6966.39)
White Nylon

Trim Panel Retainer
Top Head Diameter: 16mm
Middle Head Diameter: 16mm
Bottom Head Diameter: 16.5mm
Stem Diameter: 8.7mm
Stem Length: 13mm
Overall Length: 20mm
Peugeot & Citroen

UNIT PACKAGE: 15



21884

(Peugeot & Citroen: 6990.50)
White Nylon

Trim Panel Retainer
Top Head Diameter: 11mm
Middle Head Diameter: 16mm
Bottom Head Diameter: 18mm
Stem Diameter: 8mm
Stem Length: 13mm
Overall Length: 21.3mm
Peugeot & Citroen

UNIT PACKAGE: 25



21967

(Peugeot & Citroen: 6902.07)
Black Nylon

Push-Type Retainer
Head Diameter: 8mm
Stem Length: 7mm
Fits into 3.5mm Hole
Peugeot & Citroen

UNIT PACKAGE: 100



21968

(Peugeot & Citroen: 6972.24;
Renault & Dacia: 77-03-072-224)
Black Nylon

Push-Type Retainer
Head Diameter: 8mm
Stem Length: 8mm
Fits into 4mm Hole
Peugeot, Citroen, Renault & Dacia

UNIT PACKAGE: 25



21881

(Peugeot & Citroen: 6972.11)
Black Nylon

Mud Flap Push-Type Retainer
Head Diameter: 10mm
Stem Length: 12mm
Fits into 6.3mm Hole
Peugeot & Citroen

UNIT PACKAGE: 25



21972

(Peugeot & Citroen: 6992.18)
Black Nylon

Push-Type Retainer
Top Head Diameter: 10.5mm
Bottom Head Diameter: 11mm
Stem Length: 6mm
Fits into 6mm Hole
Overall Length: 24.5mm
Peugeot & Citroen

UNIT PACKAGE: 15



21882

(Peugeot & Citroen: 6991.F0;
Renault & Dacia: 77-03-072-261)
Black Nylon

Push-Type Retainer
Torx® Drive (T27)
Head Diameter: 12mm
Stem Length: 14mm
Fits into 6mm Hole
Peugeot, Citroen, Renault & Dacia

UNIT PACKAGE: 25



21875

(Peugeot & Citroen: 6555.LE;
Renault & Dacia: 77-03-072-236)
Black Nylon

Push-Type Retainer
Torx® Drive (T27)
Head Diameter: 12.5mm
Stem Length: 9mm
Fits into 6mm Hole
Peugeot, Citroen, Renault & Dacia

UNIT PACKAGE: 25



21970

(Peugeot & Citroen: 6990.C4)
Black Nylon

Push-Type Retainer
Head Diameter: 13mm
Stem Length: 10mm
Fits into 6mm Hole
Peugeot & Citroen

UNIT PACKAGE: 25

**PEUGEOT AND CITROEN
CLIPS & FASTENERS**



21969
(Peugeot & Citroen: 8748.C2)
Charcoal Gray Nylon

Push-Type Retainer
Head Diameter: 16mm
Stem Length: 10mm
Fits into 6mm Hole
Peugeot & Citroen

UNIT PACKAGE: 25



21883
(Peugeot & Citroen: 6991.X7)
Black Nylon

Bumper Push-Type Retainer
Head Diameter: 20mm
Stem Length: 14mm
Fits into 8mm Hole
Peugeot & Citroen

UNIT PACKAGE: 25



21971
(Peugeot & Citroen: 6973.34)
Black Nylon

Push-Type Retainer
Head Diameter: 16mm
Stem Length: 14mm
Fits into 9mm Hole
Peugeot & Citroen

UNIT PACKAGE: 25



21810
(Peugeot & Citroen: 6997.T2)
Black Nylon

Push-Type Retainer
Head Diameter: 22mm
Stem Length: 14mm
Fits into 6.3mm Hole
Peugeot & Citroen

UNIT PACKAGE: 25



21973
(Peugeot & Citroen: 1539.16)
Tan Nylon

Push-Type Retainer
Head Diameter: 20mm
Stem Length: 10mm
Fits into 6mm Hole
Peugeot & Citroen

UNIT PACKAGE: 10



21813
(Peugeot & Citroen: 6973.A9)
Black Nylon

Nylon Rivet
Diameter: 4mm
Grip: 1.2mm - 6.5mm
Flange Diameter: 9mm
Peugeot & Citroen

UNIT PACKAGE: 25



21811
(Peugeot & Citroen: 8211.WV)
Black Nylon

Push-Type Retainer
Head Diameter: 20mm
Stem Length: 10mm
Fits into 8mm Hole
Peugeot & Citroen

UNIT PACKAGE: 25



21966
Yellow Nylon

Nylon U-Nut
Screw Size: M4.2 (#8)
Panel Range: Up to 2.5mm
Center of Hole to Edge: 7mm
Overall Height: 12.5mm
Peugeot & Citroen

UNIT PACKAGE: 10



21812
(Peugeot & Citroen: 16-092-672-80;
Renault: 77-03-072-416)
Black Nylon

Push-Type Retainer
Rectangular Head Size: 9mm x 20mm
Head Diameter: 20mm
Stem Length: 13mm
Fits into 8mm Hole
Renault, Dacia, Peugeot and Citroen

UNIT PACKAGE: 25



21934
White Nylon

Heat Shield Nylon U-Nut
Screw Size: M4.8 (#10)
Panel Range: Up to 3mm
Hole Center to Edge: 8mm
Overall Height: 16mm
Peugeot, Citroen, Renault & Dacia

UNIT PACKAGE: 10

RENAULT AND DACIA CLIPS & FASTENERS

Sec. 22



21929
(Peugeot & Citroen: 6987.A1)
Black Nylon
Nylon Nut
Screw Size: M2.9 (#4)
Head Size: 9.5mm x 9.5mm
Stem Length: 7mm
Peugeot, Citroen, Renault & Dacia
UNIT PACKAGE: 50



21930
(Renault & Dacia: 77-03-081-160;
Nissan: 01281-00QAF)
Natural Nylon
Nylon Nut
Screw Size: M2.9mm (#4)
Head Size: 9mm x 9mm
Stem Length: 7mm
Renault, Dacia & Nissan
UNIT PACKAGE: 50



21931
(Peugeot & Citroen: 7136.J7;
Renault & Dacia: 77-03-081-163)
Natural Nylon
Nylon Nut
Screw Size: M2.9 (#4)
Head Size: 13mm x 13mm
Stem Length: 10mm
Peugeot, Citroen, Renault & Dacia
UNIT PACKAGE: 25



9377
(Renault: 8934-201-263; Chrysler: 6000943)
White Nylon
Radiator Grille Nut
Screw Size: #8
UNIT PACKAGE: 100



11855
(Renault: 8934-201-262; GM: 9669486)
Natural Nylon
Screw Size: #8
Rear License Plate Bracket Nut
AMC-Renault
Side Marker Nut
GM 1980-On
UNIT PACKAGE: 25



21874
(Peugeot & Citroen: 7427.46;
Renault & Dacia: 77-03-081-184)
White Nylon
Screw Grommet
Screw Size: M4.2 (#8)
Head Diameter: 15mm
Stem Length: 15mm
Peugeot, Citroen, Renault & Dacia
UNIT PACKAGE: 25



21958
(Renault & Dacia: 77-03-081-233)
White Nylon
Screw Grommet
Screw Size: M2.9 (#4)
Head Size: 9.5mm x 15mm
Stem Length: 9mm
Peugeot, Citroen, Renault & Dacia
UNIT PACKAGE: 25



21959
(Peugeot & Citroen: 6990.62;
Renault & Dacia: 77-03-081-134)
Black Nylon
Screw Grommet
Screw Size: M3.5 (#6)
Head Size: 13.5mm x 20mm
Stem Length: 15mm
Peugeot, Citroen, Renault & Dacia
UNIT PACKAGE: 10



21960
(Peugeot & Citroen: 6997.96;
Renault & Dacia: 77-03-081-185)
Natural Nylon
Screw Grommet
Screw Size: M2.9 (#4)
Head Size: 13mm x 20mm
Stem Length: 15mm
Peugeot, Citroen, Renault & Dacia
UNIT PACKAGE: 15



21961
(Peugeot & Citroen: 8749.ZA;
Renault & Dacia: 77-03-081-232)
Natural Nylon
Screw Grommet with
Black Rubber Sealer
Screw Size: M4.2 (#8)
Head Size: 10.5mm x 17.5mm
Stem Length: 15mm
Peugeot, Citroen, Renault & Dacia
UNIT PACKAGE: 10



21932
(Renault & Dacia: 77-03-081-225)
Natural Nylon
Screw Grommet with
Black Rubber Sealer
Screw Size: M2.9 (#4)
Head Diameter: 11mm
Stem Length: 16mm
Renault & Dacia
UNIT PACKAGE: 10

**RENAULT AND DACIA
CLIPS & FASTENERS**



12713
(GM: 10032838; 1264963;
Chrysler: 6031869;
Renault: 8934-201-602)
Natural Nylon

High Torque
Screw Grommet

UNIT PACKAGE: 25



13464
(8934-201-235)
Natural Nylon
Grille Retainer Screw Grommet
Screw Size: 4.2mm (#8)

UNIT PACKAGE: 25



13966
(8934-201-767)
Black Nylon
Tubular Barrel Nut
For 3/16" Stud
Barrel Length 17/64"
Head Diameter: 5/16"
Head Thick 1/32"
For Hole Diameter 17/64"

UNIT PACKAGE: 100



21897
(Renault & Dacia: 77-03-077-420)
White Nylon

Moulding Clip
Head Diameter: 20mm
Stem Length: 9mm
Overall Length: 16.5mm
Renault & Dacia

UNIT PACKAGE: 15



21915
(Renault & Dacia: 77-03-081-056)
Black Nylon

Retainer
Flange Diameter: 30mm
Fits on 6mm Stud
Overall Height: 14mm
Renault & Dacia

UNIT PACKAGE: 25



21919
Black Nylon
Weatherstrip Retaining Clip
Head Size: 7mm x 12mm
Stem Diameter: 7mm
Stem Length: 9mm
Peugeot, Citroen, Renault & Dacia

UNIT PACKAGE: 25



21918
(Peugeot & Citroen: 9025.J8)
Black Nylon

Weatherstrip Retaining Clip
Head Size: 7mm x 12mm
Stem Diameter: 8mm
Stem Length: 9mm
Peugeot, Citroen, Renault & Dacia

UNIT PACKAGE: 25



21920
Black Nylon
Weatherstrip Retaining Clip
Head Size: 9mm x 18mm
Stem Diameter: 8.5mm
Stem Length: 10mm
Peugeot, Citroen, Renault & Dacia

UNIT PACKAGE: 25



21908
(Renault & Dacia: 77-03-077-449)
Black Nylon

Trim Panel Retaining Clip
Head Diameter: 18mm
Stem Diameter: 11mm
Stem Length: 12mm
Renault & Dacia

UNIT PACKAGE: 25



21909
(Renault & Dacia: 82-00-110-307)
Gray Nylon

Trim Panel Retaining Clip
Head Diameter: 18mm
Stem Diameter: 11.3mm
Stem Length: 12mm
Renault & Dacia

UNIT PACKAGE: 25



21870
(Renault & Dacia: 77-03-077-457)
Light Gray Nylon

Trim Retaining Clip
Head Diameter: 18mm
Stem Diameter: 11.5mm
Stem Length: 13mm
Renault & Dacia

UNIT PACKAGE: 25



21800
(Renault: 77-03-077-080)
Black Nylon

Retainer
Head Diameter: 13mm
Stem Diameter: 7mm
Stem Length: 15mm
Renault and Dacia

UNIT PACKAGE: 25

RENAULT AND DACIA CLIPS & FASTENERS

Sec. 22



21801
(Not Available from O.E.M.)
White Nylon

Retainer
Head Diameter: 13mm
Stem Diameter: 7mm
Stem Length: 17mm
Renault and Dacia

UNIT PACKAGE: 25



12993
(7703-077-066)
Black Nylon
Rear Window Moulding Retainer
Alliance 1983-On

UNIT PACKAGE: 25



21910
(Renault & Dacia: 77-03-077-487)
Black Nylon

Trim Panel Retainer
Head Diameter: 16mm
Stem Diameter: 9mm
Stem Length: 20mm
Renault & Dacia

UNIT PACKAGE: 25



21911
(Renault & Dacia: 77-03-077-464)
Gray Nylon

Trim Panel Retainer
Head Diameter: 16mm
Stem Diameter: 9mm
Stem Length: 20mm
Renault & Dacia

UNIT PACKAGE: 15



21912
(Renault & Dacia: 77-03-077-153)
Black Nylon

Trim Panel Retainer
Head Diameter: 16mm
Stem Diameter: 9mm
Stem Length: 20mm
Renault & Dacia

UNIT PACKAGE: 15



21913
(Renault & Dacia: 77-03-077-107)
Dark Gray Nylon

Trim Panel Retainer
Head Diameter: 16mm
Stem Diameter: 12mm
Stem Length: 19mm
Renault & Dacia

UNIT PACKAGE: 25



21802
(Renault: 77-03-077-231;
Fiat: 14591787)
Black Nylon

Retainer
Head Diameter: 15mm
Stem Diameter: 8mm
Stem Length: 17mm
Renault, Dacia and Fiat

UNIT PACKAGE: 25



21803
(Fiat: 14592087)
Black Nylon

Retainer
Head Diameter: 20mm
Stem Diameter: 8mm
Stem Length: 23mm
Renault, Dacia and Fiat

UNIT PACKAGE: 25



21804
(Fiat: 14592086)
Gray Nylon

Retainer
Head Diameter: 20mm
Stem Diameter: 8mm
Stem Length: 23mm
Renault, Dacia and Fiat

UNIT PACKAGE: 25



21868
(Peugeot & Citroen: 6999.R1;
Renault & Dacia: 77-03-077-174)
Black Nylon

Trim Panel Retainer
Head Diameter: 20mm
Stem Diameter: 8mm
Stem Length: 17mm
Peugeot, Citroen, Renault & Dacia

UNIT PACKAGE: 25



21905
(Renault & Dacia: 82-00-721-200)
Gray Nylon

Trim Panel Retainer
Head Diameter: 21mm
Stem Diameter: 7.5mm
Stem Length: 19mm
Renault & Dacia

UNIT PACKAGE: 25

**RENAULT AND DACIA
CLIPS & FASTENERS**



21900
(Renault & Dacia: 77-03-077-453)
Black Nylon

Trim Panel Retainer
Head Diameter: 24mm
Stem Diameter: 7mm
Stem Length: 10mm
Renault & Dacia

UNIT PACKAGE: 15



21914
(Renault & Dacia:
77-03-074-315)
Black Nylon

Trim Panel Retainer
Head Diameter: 40mm
Stem Diameter: 10.5mm
Stem Length: 26mm
Renault & Dacia

UNIT PACKAGE: 10



21906
(Renault & Dacia: 77-03-077-090)
Black Nylon

Trim Panel Retainer
Head Diameter: 30mm
Stem Diameter: 8mm
Stem Length: 18mm
Renault & Dacia

UNIT PACKAGE: 10



21495
(VW: 7L5-853-994)
Blue Nylon

Trim Panel Retainer
Top Head Diameter: 13mm
Bottom Head Diameter: 18mm
Stem Diameter: 9mm
Stem Length: 14mm
Renault, VW & Audi

UNIT PACKAGE: 25



21907
(Renault & Dacia: 82-00-321-368)
Gray Nylon

Trim Panel Retainer
Head Diameter: 30mm
Stem Diameter: 8mm
Stem Length: 18mm
Renault & Dacia

UNIT PACKAGE: 10



21977
(Renault & Dacia: 77-01-049-008)
White Nylon

Trim Panel Retainer
Top Head Diameter: 13mm
Bottom Head Diameter: 18mm
Stem Diameter: 11.5mm
Stem Length: 12mm
Peugeot, Citroen, Renault & Dacia

UNIT PACKAGE: 25



21805
(Renault: 77-03-077-435)
Black Nylon

Retainer
Head Diameter: 35mm
Stem Diameter: 10mm x 10.5mm
Stem Length: 22mm
Renault and Dacia

UNIT PACKAGE: 25



21871
(Peugeot & Citroen: 6995.A3;
Renault & Dacia: 77-03-077-111)
White Nylon

Trim Panel Retainer with Sealer
Top Head Diameter: 13mm
Bottom Head Diameter: 16.5mm
Stem Diameter: 8.7mm
Stem Length: 11mm
Peugeot, Citroen, Renault & Dacia

UNIT PACKAGE: 25



21806
(Renault: 77-03-077-225)
Black Nylon

Retainer
Head Diameter: 35mm
Stem Diameter: 10.5mm
Stem Length: 22mm
Renault and Dacia

UNIT PACKAGE: 25



21896
Gray Nylon

Trim Panel Retainer
Top Head Diameter: 13.3mm
Bottom Head Diameter: 18mm
Stem Diameter: 9.3mm
Stem Length: 13mm
Renault & Dacia

UNIT PACKAGE: 25

RENAULT AND DACIA CLIPS & FASTENERS

Sec. 22



21975
(Peugeot & Citroen: 6991.43;
Renault & Dacia: 77-03-077-059)
White Nylon

Trim Panel Retainer
Top Head Diameter: 14mm
Bottom Head Diameter: 17mm
Stem Diameter: 9mm
Stem Length: 10mm
Peugeot, Citroen, Renault & Dacia
UNIT PACKAGE: 25



21895
(Peugeot & Citroen: 6991.Z1;
Renault & Dacia: 82-00-909-084)
Blue Nylon

Trim Panel Retainer
Top Head Diameter: 13mm
Middle Head Diameter: 16mm
Bottom Head Diameter: 18mm
Stem Diameter: 12mm
Stem Length: 12mm
Peugeot, Citroen, Renault & Dacia
UNIT PACKAGE: 25



21917
Yellow Nylon

Trim Panel Retainer with Sealer
Top Head Diameter: 12.3mm
Middle Head Diameter: 15mm
Bottom Head Diameter: 18mm
Stem Diameter: 12mm
Stem Length: 13mm
Overall Length: 19mm
Renault & Dacia
UNIT PACKAGE: 15



21944
(Peugeot & Citroen: 8742.G2)
Green & White Nylon

Trim Panel Retainer
Top Head Diameter: 12.5mm
Middle Head Diameter: 14mm
Bottom Head Diameter: 18mm
Stem Diameter: 10.5mm
Stem Length: 12mm
Peugeot, Citroen, Renault & Dacia
UNIT PACKAGE: 10



21814
(Peugeot: 6991.S6;
Renault: 77-03-077-468)
White Nylon

Door Panel Retainer
Top Head Diameter: 13mm
Middle Head Diameter: 16mm
Bottom Head Diameter: 18mm
Stem Diameter: 12mm
Stem Length: 11mm
Overall Length: 18.5mm
Renault, Dacia, Peugeot and Citroen
UNIT PACKAGE: 25



21873
(BMW: 51-43-7-001-491)
White Nylon

Trim Panel Retainer
Top Head Diameter: 14mm
Middle Head Diameter: 15mm
Bottom Head Diameter: 18mm
Stem Diameter: 9.5mm
Stem Length: 14mm
Renault, Dacia & BMW
UNIT PACKAGE: 25



13475
(VW: 175-867-299;
Renault: 8934-201-681)
White Nylon

Trim Panel Retainer
Head Diameter: 19mm
Stem Length: 18mm
Stem Diameter: 9mm
AMC Renault 1984-On
VW 1982-On
UNIT PACKAGE: 50



21916
(Peugeot & Citroen: 8335.TE;
Renault & Dacia: 82-00-700-969)
Yellow Nylon

Trim Panel Retainer
Top Head Diameter: 12.3mm
Middle Head Diameter: 15mm
Bottom Head Diameter: 18mm
Stem Diameter: 12mm
Stem Length: 13mm
Overall Length: 19mm
Peugeot, Citroen, Renault & Dacia
UNIT PACKAGE: 25



21968
(Peugeot & Citroen: 6972.24;
Renault & Dacia: 77-03-072-224)
Black Nylon

Push-Type Retainer
Head Diameter: 8mm
Stem Length: 8mm
Fits into 4mm Hole
Peugeot, Citroen, Renault & Dacia
UNIT PACKAGE: 25

**RENAULT AND DACIA
CLIPS & FASTENERS**



21882

(Peugeot & Citroen: 6991.F0;
Renault & Dacia: 77-03-072-261)
Black Nylon

Push-Type Retainer
Torx® Drive (T27)
Head Diameter: 12mm
Stem Length: 14mm
Fits into 6mm Hole
Peugeot, Citroen, Renault & Dacia

UNIT PACKAGE: 25



21876

(Renault & Dacia: 05-40-000-1R;
Nissan: 01515-00Q0C)
Black Nylon

Bumper Push-Type Retainer
Head Diameter: 18mm
Stem Length: 18mm
Fits into 9mm Hole
Renault, Dacia & Nissan

UNIT PACKAGE: 15



21875

(Peugeot & Citroen: 6555.LE;
Renault & Dacia: 77-03-072-236)
Black Nylon

Push-Type Retainer
Torx® Drive (T27)
Head Diameter: 12.5mm
Stem Length: 9mm
Fits into 6mm Hole
Peugeot, Citroen, Renault & Dacia

UNIT PACKAGE: 25



21812

(Peugeot & Citroen: 16-092-672-80;
Renault: 77-03-072-416)
Black Nylon

Push-Type Retainer
Rectangular Head Size: 9mm x 20mm
Head Diameter: 20mm
Stem Length: 13mm
Fits into 8mm Hole
Renault, Dacia, Peugeot and Citroen

UNIT PACKAGE: 25



21935

(Renault & Dacia: 77-03-072-361)
Black Nylon

Push-Type Retainer
Head Diameter: 12mm
Stem Length: 10mm
Fits into 6mm Hole
Renault & Dacia

UNIT PACKAGE: 15



21921

(Renault & Dacia: 77-01-030-059)
Pink Nylon

Door Lock Rod Clip
Use on Left-Hand Side
Rod Size: 2.5mm
Renault & Dacia

UNIT PACKAGE: 15



21898

(Renault & Dacia: 77-03-072-352)
Black Nylon

Push-Type Retainer
Head Diameter: 17.5mm
Stem Length: 9mm
Fits into 6mm Hole
Renault & Dacia

UNIT PACKAGE: 10



21922

(Renault & Dacia: 77-01-030-059)
White Nylon

Door Lock Rod Clip
Use on Right-Hand Side
Rod Size: 2.5mm
Renault & Dacia

UNIT PACKAGE: 15



21807

(Renault: 77-03-072-360)
Black Nylon

Push-Type Retainer
Head Diameter: 18mm
Stem Length: 14mm
Fits into 8mm Hole
Renault and Dacia

UNIT PACKAGE: 25



21923

(Renault & Dacia: 77-01-030-058)
Green Nylon

Door Lock Rod Clip
Use on Left-Hand Side
Rod Size: 3mm
Renault & Dacia

UNIT PACKAGE: 10

RENAULT, DACIA, SAAB AND SUBARU CLIPS & FASTENERS

Sec. 22



21927

(Renault & Dacia: 77-01-030-060)
White Nylon

Door Lock Rod Clip
Use on Right-Hand Side
Rod Size: 4mm
Renault & Dacia

UNIT PACKAGE: 15



21926

(Renault & Dacia: 77-01-030-060)
Yellow Nylon

Door Lock Rod Clip
Use on Left-Hand Side
Rod Size: 4mm
Renault & Dacia

UNIT PACKAGE: 15



13216

Zinc

U-Type Nut
Screw Size: 4.8mm
Panel Range: .9mm-2mm
Center of Hole to Edge: 8mm

UNIT PACKAGE: 25



21934

White Nylon

Heat Shield Nylon U-Nut
Screw Size: M4.8 (#10)
Panel Range: Up to 3mm
Center of Hole to Edge: 8mm
Overall Height: 16mm
Peugeot, Citroen, Renault & Dacia

UNIT PACKAGE: 10

SAAB



21540

(GM: 24449408)
Orange Nylon

Bumper, Grille, Wheel Apron & Lights
Nylon Extruded U-Nut
Screw Size: M5.5 (#12)
Panel Range: Up to 2mm
Center of Hole to Edge: 12mm
Use with Auveco 21541
Buick Lacrosse & Regal 2011 - On
Saab 9-3 & 9-5 2003 - On
Saturn Astra 2009 - 08

UNIT PACKAGE: 25

SUBARU CLIPS & FASTENERS



22042

(Subaru: 57160FC010)
White Nylon

Upper Front Bumper
Extension Moulding Clip
Top Head Size: 9mm x 11mm
Bottom Head Size: 14mm x 17mm
Stem Length: 11mm
Forester 2005 - 1998

UNIT PACKAGE: 25



21771

Subaru: 909130008)
Pink Nylon

Moulding Clip with Sealer
Top Head Size: 11mm x 14mm
Bottom Head Diameter: 17mm
Stem Diameter: 10mm
Stem Length: 11mm
Baja, Forester, Impreza, Legacy,
Outback & Tribeca 2000 - On

UNIT PACKAGE: 25



21581

(91059FC030)
White Nylon

Front & Rear Door Fender,
Quarter Panel and Lift Gate
Moulding Clip with Sealer
Top Head Size: 11mm x 14mm
Bottom Head Diameter: 17mm
Stem Length: 12mm
Fits into 9mm Hole
B9 Tribeca, Forester, Impreza
& Outback 1998 - On

UNIT PACKAGE: 25



21564

(91059FC110)
White Nylon

Moulding Clip with Sealer
Head Size: 21.5mm x 24mm
Stem Diameter: 14.5mm
Stem Length: 17mm
Forester 2002 - 01

UNIT PACKAGE: 25



21572
(91059FC090)
Black Nylon

Grille Clip
Top Head Size: 15.5mm x 11mm
Bottom Head Size: 19.5mm x 14mm
Stem Length: 11mm
Forester & Legacy 2008 - 1991

UNIT PACKAGE: 25



22050
(Subaru: 91059FC041)
Gray Nylon

Moulding Clip
Top Head Size: 11mm x 15mm
Bottom Head Size: 14mm x 22.5mm
Stem Length: 13mm
Overall Height: 24mm
Forester 2005 - 1998

UNIT PACKAGE: 25



21562
(91017FA080)
Gray Nylon

Grille Clip
Overall Height: 27mm
Forester Impreza & SVX 2008 - 1993

UNIT PACKAGE: 25



21579
(91167AA000)
Black Nylon

Cowl Top, Quarter Glass, Exterior Trim,
Belt Moulding, Trunk Lid &
Rear Light Grommet with Sealer
Head Diameter: 17.5mm
Stem Length: 15mm
Fits into 8mm Hole
Baja, Forester, Impreza, Legacy,
Outback & SVX 2006 - 1991

UNIT PACKAGE: 25



21587
(62731FA010)
Blue Nylon

Screw Size: M3.5 (#6)
Head Size: 11mm x 11mm
Stem Length: 10mm
Fits into 8mm x 8mm Square Hole
Subaru 1993 - On

UNIT PACKAGE: 25



21629
(62731FA000)
White Nylon

Screw Size: M3.5 (#6)
Head Size: 10mm x 10mm
Stem Length: 5mm
Fits into 7mm x 7mm Hole
Forester, Impreza, Legacy &
Outback 2009 - 05

UNIT PACKAGE: 25



22044
(Subaru: 661179000, 909300007)
Yellow Nylon

Nylon Nut
Screw Size: M4.8 (#10)
Head Size: 14mm x 14mm
Stem Length: 7mm
Forester, Impreza, Justy, Legacy,
Outback, SVX, Tribeca & XV 1987 - On

UNIT PACKAGE: 25



21575
(94081FA010)
White Nylon

Screw Grommet
Screw Size: M4.8 (#10)
Head Diameter: 13mm
Stem Length: 8mm
Fits into 8mm Square Hole
Subaru 1992 - On

UNIT PACKAGE: 25



21569
(909300015)
White Nylon

Rear Bumper Screw Grommet
Screw Size: M4.8 (#10)
Head Diameter: 12mm
Stem Length: 15mm
Fits into 7mm Square Hole
Impreza, Legacy, Outback & SVX 2009 - 1995

UNIT PACKAGE: 25



21577
(57750FC010)
White Nylon

Rear Bumper Reinforcement Beam
Screw Grommet with Sealer
Screw Size: M4.8 (#10)
Head Size: 16mm x 16mm
Stem Length: 19mm
Forester 2008 - 1998

UNIT PACKAGE: 25



22043

(Subaru: 91084AA010)
White Nylon

Screw Grommet with Sealer
Screw Size: M5.5 (#12)
Head Diameter: 20mm
Stem Length: 18mm
Forester, Impreza, Legacy,
Outback & Tribeca 1995 - On

UNIT PACKAGE: 15



21589

(99045AE03AMA)
Black Nylon

Trim Panel Retainer
Head Diameter: 18mm
Stem Diameter: 7.7mm
Stem Length: 15mm
B9 Tribeca, Impreza, Legacy
& Outback 2005 - On

UNIT PACKAGE: 25



21590

(91486KJ000)
White Nylon

Cowl & Dash Grommet
Head Diameter: 14mm
Stem Length: 7mm
Fits into 7mm Hole

Use with Auveco 21531

Forester, Impreza, Legacy & Outback 2008 - On

UNIT PACKAGE: 25



22211

(Subaru: 909207031)
Black Nylon

Hood Insulation Retainer
Head Diameter: 23mm
Stem Diameter: 8mm
Stem Length: 15mm
Subaru BRZ, Forester, Impreza,
WRX & XV Crosstrek 2012 - On

UNIT PACKAGE: 50



21531

(91486KJ010)
Black Nylon

Cowl Panel Vent Cap
Top Head Size: 16mm x 18mm
Bottom Head Diameter: 14mm
Stem Length: 12mm
Use with Auveco 21590
Forester, Impreza, Legacy, Outback
& WRX 2008 - On

UNIT PACKAGE: 15



21630

(95022AC040ML)
Black Nylon

Headliner & Trim Space Retainer
Head Diameter: 20mm
Stem Diameter: 6mm
Stem Length: 22mm
Forester, Impreza, Legacy
& Outback 1998 - On

UNIT PACKAGE: 25



21573

(90331GA090)
Black Nylon

Weatherstrip Retaining Clip
Head Diameter: 9mm
Stem Diameter: 6.5mm
Stem Length: 13mm
Forester & Legacy 2008 - 1990

UNIT PACKAGE: 25



21322

(90814FC001)
Black Nylon

Retainer
Head Diameter: 30mm
Stem Diameter: 6.5mm
Stem Length: 13mm
Subaru 1998 - On

UNIT PACKAGE: 10



22046

(Subaru: 91167FA010)
Black Nylon

Front Hood Cowl Retaining Clip
Head Size: 9.3mm x 14.5mm
Stem Diameter: 7mm
Stem Length: 16mm
Impreza 2001 - 1993

UNIT PACKAGE: 25



21421

(909130074)
Black Nylon

Hood Insulation Retainer
Head Diameter: 30mm
Stem Diameter: 7.7mm
Stem Length: 13mm
Baja, Forester, Impreza,
Legacy, Outback & Tribeca 1998 - On

UNIT PACKAGE: 15



22290

(Subaru: 909130118)
Black Nylon

Moulding Retainer with Sealer
Head Diameter: 24mm
Stem Length: 16mm
Overall Length: 19.3mm
Subaru Impreza, Legacy &
Outback 2005 - On

UNIT PACKAGE: 15



21591

(909130109)
Black Nylon

Front & Rear Door, Fender, Quarter Panel
and Rocker Panel Moulding Retainer
Top Head Size: 11mm x 14mm
Bottom Head Diameter: 17mm
Stem Diameter: 9.7mm
Stem Length: 12mm
B9 Tribeca, Forester, Impreza,
Legacy & Outback 2003 - On

UNIT PACKAGE: 25



22207

(Subaru: 909130088)
Black Nylon

Fender, Rocker, Garnish, Pillar, Floor
& Exterior Trim Retainer with Sealer
Top Head Size: 11mm x 14mm
Bottom Head Diameter: 17mm
Stem Diameter: 9.7mm
Stem Length: 12mm
Subaru Forester, Impreza, Legacy,
Outback, B9 Tribeca & WRX 2005 - On

UNIT PACKAGE: 25



21567

(909130007)
Gray Nylon

Pillar & Door Moulding Trim
and Rear Light Retainer with Sealer
Top Head Size: 11mm x 15mm
Bottom Head Diameter: 18mm
Stem Diameter: 9.7mm
Stem Length: 12mm
B9 Tribeca, Forester, Impreza,
Legacy & Outback 2005 - On

UNIT PACKAGE: 25



21574

(909130034)
White Nylon

Door, Pillar, Rocker, Floor &
Interior Trim Retainer
Top Head Diameter: 13mm
Middle Head Diameter: 16mm
Bottom Head Diameter: 15mm
Stem Diameter: 9.5mm
Stem Length: 11mm

Baja, Forester, Legacy & Outback 2008 - 03

UNIT PACKAGE: 25



22343

(Subaru: 909130096)
Green Nylon

Cowl, Garnish, Headliner, Rocker,
Pillar & Interior Trim Retainer
Top Head Diameter: 13mm
Middle Head Diameter: 16mm
Bottom Head Diameter: 15mm
Stem Diameter: 9.8mm
Stem Length: 10mm

Subaru B9 Tribeca, BRZ, Forester, Impreza, Legacy,
Outback, WRX & XV Crosstrek 2005 - On

UNIT PACKAGE: 25



21502

(909130213)
White Nylon

Door Trim Panel Retainer with Sealer
Top Head Diameter: 13mm
Middle Head Diameter: 16mm
Bottom Head Diameter: 15mm
Stem Diameter: 9.5mm
Stem Length: 14mm
Legacy & Outback 2010 - On

UNIT PACKAGE: 10



22206

(Subaru: 909130105)
White Nylon

Front & Rear Door, Headliner, Interior Trim,
Liftgate & Quarter Panel Retainer
Top Head Diameter: 13mm
Middle Head Diameter: 16mm
Bottom Head Diameter: 15mm
Stem Diameter: 9.6mm x 9.6mm
Stem Length: 14mm
Overall Length: 21mm
Subaru BRZ, Forester, Impreza, Legacy,
Outback, B9 Tribeca, WRX &
XV Crosstrek 2002 - On

UNIT PACKAGE: 50



21584
(693005370)
White Nylon

Front Door & Lift Gate Trim Panel Retainer
Top Head Diameter: 13mm
Middle Head Diameter: 16mm
Bottom Head Diameter: 18mm
Stem Diameter: 9.3mm
Stem Length: 10mm
Impreza, Justy, Legacy & Outback 2007 - 1987

UNIT PACKAGE: 25



22048
(Subaru: 94078FA080)
White Nylon

Trim Panel Retainer
Top Head Diameter: 13mm
Middle Head Diameter: 16mm
Bottom Head Diameter: 18mm
Stem Diameter: 9mm x 9.5mm
Stem Length: 11mm
Overall Length: 16.5mm
Forester, Impreza & XV Crosstrek 1994 - On

UNIT PACKAGE: 25



21565
(90331AA050)
White Nylon

Weatherstrip Retaining Clip
Head Size: 5mm x 14mm
Stem Diameter: 7mm
Stem Length: 8.5mm
Forester 2008 - 03

UNIT PACKAGE: 25



21585
(909130003)
Black Nylon

Upper Grille Push-Type Retainer
Head Diameter: 9mm
Stem Length: 7mm
Fits into 4mm Hole
Baja, Legacy & Outback 2006 - 2000

UNIT PACKAGE: 25



22230
(Subaru: 909140059)
Black Nylon

Front & Rear Bumper Push-Type Retainer
Head Diameter: 10mm
Stem Length: 8.5mm
Fits into 5mm Hole
Subaru Forester, Impreza, Legacy,
Outback, WRX, XV Crosstrek 2008 - On

UNIT PACKAGE: 15



21593
(46064AE000)
Black Nylon

Front Fender Bumper &
Quarter Panel Push-Type Retainer
Head Diameter: 15mm
Stem Length: 8mm
Fits into 7mm Hole
Baja, Forester, Impreza,
Legacy & Outback 2003 - On

UNIT PACKAGE: 10



22160
(Subaru: 909140062)
Black Nylon

Front & Rear Bumper
Push-Type Retainer
Head Diameter: 15mm
Stem Length: 10mm
Fits into 7mm Hole
Subaru BRZ, Forester, Impreza &
XV Crosstrek 2008 - On

UNIT PACKAGE: 15



21658
(Mitsubishi: MR288150;
Subaru: 909130013)
Black Nylon

Push-Type Retainer
Head Diameter: 15mm
Stem Length: 11mm
Fits into 6mm Hole
Mitsubishi Endeavor, Galant, Lancer,
Mirage, Montero & Outlander 1997 - On
Subaru BRZ, Forester, Impreza, Legacy,
Outback, & XV Crosstrek 2004 - On

UNIT PACKAGE: 10



21570
(909140012)
Black Nylon

Rear Light Reflector
& Roof Spoiler
Push-Type Retainer
Head Diameter: 16mm
Stem Length: 11mm
Fits into 6mm Hole
B9 Tribeca, Impreza,
Legacy & Outback 2005 - On

UNIT PACKAGE: 25



21566
(91085TA030)
Black Nylon

Push-Type Retainer
Head Diameter: 16mm
Stem Length: 13mm
Fits into 7mm Hole

Baja, Impreza, Legacy & Outback 2000 - On

UNIT PACKAGE: 25



21530
(Subaru: 909130067;
Hyundai: 86590-3S000)
Black Nylon

Engine Cover and Fender Liner
Push-Type Retainer
Head Diameter: 18mm
Stem Length: 10mm
Fits into 8mm Hole

B9 Tribeca, Forester, Legacy &
Outback & Tribeca. 2005 - On
Hyundai Azera, Elantra, Genesis &
Sonata and Kia Cadenza & Optima 2011 - On

UNIT PACKAGE: 15



22181
(Subaru: 909140065)
Black Nylon

Front Fender Liner, Engine Cover,
Hood & Quarter Panel Push-Type Retainer
Head Diameter: 18mm
Stem Length: 10mm
Fits into 8mm Hole

Subaru BRZ, Crosstrek, Forester, Impreza,
Legacy, Outback & WRX 2008 - On

UNIT PACKAGE: 15



21422
(909140051)
Black Nylon

Front Bumper & Quarter Panel
Push-Type Retainer
Head Diameter: 20mm
Stem Length: 9mm
Fits into 7mm Hole

B9 Tribeca, Impreza, Legacy & Outback 2005 - On

UNIT PACKAGE: 15



21571
(59122FA010)
Black Nylon

Front Bumper, Fender, Windshield Washer
& Rocker Moulding Push-Type Retainer
Head Diameter: 20mm
Stem Length: 10mm
Fits into 8mm Hole

B9 Tribeca, Baja, Forester,
Impreza, Legacy & Outback 1998 - On

UNIT PACKAGE: 25



22270
(Subaru: 909140068)
Black Nylon

Front Fender Push-Type Retainer
Head Diameter: 20mm
Stem Length: 10mm
Fits into 8mm Hole

Subaru BRZ, Impreza, Legacy,
Outback & XV Crosstrek 2012 - On

UNIT PACKAGE: 15



21592
(909140052)
Black Nylon

Push-Type Retainer
Head Diameter: 20mm
Stem Length: 11mm
Fits into 7mm Hole

B9 Tribeca, Impreza, Legacy
& Outback 2005 - On

UNIT PACKAGE: 15



21594
(909130051)
Black Nylon

Fender Liner, Duct &
Lower Moulding Push-Type Retainer
Head Diameter: 20mm
Stem Length: 11mm
Fits into 7mm Hole

B9 Tribeca, Forester, Impreza,
Legacy & Outback 2005 - On

UNIT PACKAGE: 15



21580
(59122AC030)
Black Nylon

Front Fender Push-Type Retainer
Head Diameter: 20mm
Stem Length: 12mm
Fits into 7mm Hole

B9 Tribeca, Baja, Forester,
Legacy & Outback 1995 - On

UNIT PACKAGE: 25



21500
(909140063)
Black Nylon

Cowl Vent Push-Type Retainer
Head Diameter: 20mm
Stem Length: 12mm
Fits into 7mm Hole

Legacy & Outback 2010 - On

UNIT PACKAGE: 10



21563

(909130059)
Black Nylon

Front Bumper & Fender
Push-Type Retainer
Head Diameter: 20mm
Stem Length: 15mm
Fits into 10mm Hole
Forester, Impreza, & Outback 2006 - 02

UNIT PACKAGE: 25



21420

(909140007)
Black Nylon

Bumper, Engine Cover, Fender
& Grille Push-Type Retainer
Head Diameter: 21mm
Stem Length: 15mm
Fits into 10mm
B9 Tribeca, Baja, Forester, Impreza,
Legacy & Outback 2000 - On

UNIT PACKAGE: 15



21578

(57750AA090)
Black Nylon

Front & Rear Bumper
Push-Type Retainer
Head Diameter: 22mm
Stem Length: 28mm
Fits into 10mm Hole
Impreza & Legacy 2001 - 1993

UNIT PACKAGE: 25



21501

(909140055)
Black Nylon

Push-Type Retainer with Sealer
Head Diameter: 25mm
Shoulder Length: 3mm
Shoulder Diameter: 16.5mm
Stem Length: 12mm
Fits into 11mm Hole
Subaru 2006 - On

UNIT PACKAGE: 5



21576

(909140002)
Black Nylon

Rocker, Pillar, Floor & Exterior Trim
Push-Type Retainer with Sealer
Head Diameter: 25mm
Shoulder Diameter: 17mm
Shoulder Length: 3mm
Stem Length: 14mm
Fits into 11mm Hole
B9 Tribeca, Baja, Legacy & Outback 2000 - On

UNIT PACKAGE: 25



22047

(Subaru: 94415FA000NE)
Gray & Black Nylon

Rear Roof Spoiler Trim
Push-Type Retainer
Top Head Diameter: 25mm
Bottom Head Diameter: 21mm
Stem Length: 9mm (Excluding the Pin)
Fits into 8mm Hole
Impreza 2007 - 1998

UNIT PACKAGE: 15



21568

(57160FC000)
Black Nylon

Front Fender
Push-Type Retainer
Top Head Length: 19.5mm
Bottom Head Diameter: 14mm
Stem Length: 15mm
Fits into 10mm Hole
Forester 2008 - 1998

UNIT PACKAGE: 25



22210

(Subaru: 57371GA070)
Natural Nylon

Tube/Cable Routing Clip
Holds 5mm Diameter Tube/Cable
Snaps into 6mm Hole
Overall Height: 15mm
Subaru BRZ, Forester, Impreza, Legacy,
Outback, B9 Tribeca & WRX 1995 - On

UNIT PACKAGE: 25



22175

(Subaru: 91086AA000)
Black Nylon

Splash Guard Nylon U-Nut
with Metal Insert Nut
Thread: M5-.80
(Internal Steel Nut)
Panel Range: Up to 3mm
Center of Hole to Edge: 10mm
Subaru 2008 - On

UNIT PACKAGE: 10



22078

(Suzuki: 83942-65D00)
White Nylon

Liftgate, Exterior Trim &
Garnish Moulding Clip
Top Head Size: 9mm x 10mm
Middle Head Diameter: 12mm
Bottom Head Diameter: 15mm
Stem Length: 11mm
Fits into 9mm Hole

Suzuki Grand Vitara & XL7 2006 - 1999

UNIT PACKAGE: 25



17383

(GM: 94847334, 96057847;
Toyota: 90467-07066;
Suzuki: 09409-07313)
Black Nylon

Radiator Grille & Trim Panel
Push-Type Retainer
Head Diameter: 11mm
Stem Length: 14mm (Excluding the Pin)
Fits into 7mm Hole

Suzuki and Geo Tracker & Prizm 1992 - 89

UNIT PACKAGE: 10



20743

(77553-65D00)
White Nylon

Moulding Clip
Head Diameter: 18mm
Stem Length: 9mm
Overall Length: 18mm
Suzuki

UNIT PACKAGE: 10



22083

(Suzuki: 09409-08327)
Black Nylon

Front Lights, Cowl &
Rear Bumper Push-Type Retainer
Head Diameter: 16mm
Stem Length: 10mm
Fits into 8mm Hole

Suzuki Kizashi, SX4 & XL7 2013 - 02

UNIT PACKAGE: 15



22079

(Suzuki: 77553-65D10)
White Nylon

Moulding Clip
Head Diameter: 18mm
Stem Length: 9mm
Overall Height: 18mm
Suzuki Grand Vitara,
Swift & XL7 1990 - On

UNIT PACKAGE: 15



20908

(Suzuki: 09409-07332;
Toyota: 90467-07164)
Black Nylon

Push-Type Retainer
Head Diameter: 20mm
Stem Length: 10mm
Fits into 7mm Hole
Suzuki 1999 - On
Toyota 1997 - On

UNIT PACKAGE: 10



20744

(77259-71B00)
White Nylon

Moulding Clip with Sealer
Top Head Diameter: 13mm
Bottom Head Diameter: 16mm
Stem Length: 13mm
Suzuki

UNIT PACKAGE: 10



21691

(Suzuki: 09409-06309-5ES)
Black Nylon

Hood Insulation Retainer
Head Diameter: 24mm
Stem Diameter: 6mm x 6mm
Stem Length: 13mm
Grand Vitara, Swift & XL7 1990 - On

UNIT PACKAGE: 25



21745

(GM: 11609651)
Zinc

Windshield Garnish and Interior Trim
Moulding Fastener
Screw Size: M4.2 (#8)
Stem Width: 13mm
Head Size: 13.5mm x 20.5mm
Overall Length: 22mm
Buick Enclave & Encore; Cadillac CTS, Escalade,
STS & XTS; Chevrolet Avalanche, Camaro, Cobalt,
Corvette, HHR, Impala, Malibu, Monte Carlo,
Silverado, Suburban, Tahoe & Traverse; Dodge Truck;
Ford Flex & Taurus; GMC Sierra & Yukon; Kia Sorento
& Soul; Pontiac G6 & G8; Saturn Outlook
and Suzuki Grand Vitara 2004 - On

UNIT PACKAGE: 15



16691

Natural Nylon

Headlight Adjusting
Screw Nut
Pick-Up Truck 1984-On

UNIT PACKAGE: 25



18747

(90189-06162)

Natural Nylon

Front Clearance Lamp Nut
Camry 1994-91
Headlight Adjusting Nut
Lexus

UNIT PACKAGE: 10



16951

(81124-89101)

Nylon

Headlight Spacer
Width: 15mm
Length: 18mm
Fits into 7mm Square Hole
Pick-Up Truck 1984-On

UNIT PACKAGE: 25



20738

(53271-44010)

Black Nylon

Headlight Bracket Clip
Width: 25mm
Length: 40.5mm
Toyota Camry & RAV4
and Lexus IS-300 2001 - On

UNIT PACKAGE: 4



22102

(Toyota: 53271-12040;
53271-12060; 53271-0B010)

Black Nylon

Headlight Bracket Clip
Width: 25mm
Length: 39mm
Overall Height: 33mm
Lexus GX460, GX470, RX 300, RX 330 & RX 350
and Toyota Corolla, Echo, Highlander, MR2, Prius,
Tacoma, Tercel & 4-Runner 1993 - On

UNIT PACKAGE: 10



21369

(67771-58010)

White Nylon

Door & Garnish Moulding Clip
Overall Height: 12.4mm (1/2")
Tundra 2007 - On

UNIT PACKAGE: 25



21546

(90467-09204)

White Nylon

Rear Hatch Door Side Garnish
and Front Body Pillar Garnish
Moulding Clip
Overall Height: 14mm
Toyota Camry, Highlander, Prius & Sienna and
Lexus GS 300, GS 400, GS 430, GX 470, RX 330,
RX 350, RX 400 & RX 450 1998 - On

UNIT PACKAGE: 25



21549

(90467-12080)

Pink Nylon

Door Trim, Instrument Panel,
Rear Deck Trim & Roof Garnish Trim
Moulding Clip
Overall Height: 21mm
Toyota Avalon, Camry, Corolla, Echo, FJ Cruiser,
Highlander, Matrix, Prius, RAV4, Sequoia, Sienna,
Tacoma, Tundra, Venza, Yaris & 4-Runner and
Lexus ES 350, GX 460, RX 330 & RX 450h 2000 - On

UNIT PACKAGE: 25



17194

(90467-13005)

Black Nylon

Grille Clip
Width: 13mm
Length: 23mm

UNIT PACKAGE: 25



21623

(Mitsubishi: MR221507;

Toyota: 90467-13075)

Gray Nylon

Radiator Grille Clip
Width: 14mm
Length: 24mm
Mitsubishi Diamante, Endeavor & Galant 1997 - On
Toyota 4 Runner, Highlander & Land Cruiser 1998 - On

UNIT PACKAGE: 25



17438
(90467-17004)
Black Nylon

Radiator Grille Clip
Width: 21mm
Length: 22mm
Cressida 1987-84

UNIT PACKAGE: 10



19430
(90904-67021)
Black Nylon

Radiator Grille Retainer
T-100 Truck 1992-On

UNIT PACKAGE: 15



22163
(Toyota: 53145-12010)
Black Nylon

Grille Clip
Overall Length: 38mm
Toyota Corolla, FJ Cruiser
& Tacoma 1993 - On

UNIT PACKAGE: 15



21194
(61118-35010)
Black Nylon

Front Fender Upper Seal
Moulding Clip
Head Size: 18mm x 18mm
Stem Length: 13mm
Fits into 9mm Hole
FJ Cruiser 2007 - On

UNIT PACKAGE: 15



22351
(Toyota: 90467-10181)
Black Nylon

Headliner & Interior Trim Moulding Clip
Top Head Size: 18mm x 19mm
Bottom Head Size: 18mm x 24mm
Stem Diameter: 10mm
Stem Length: 13mm
Lexus ES 300h/350,
GS 300/350/430/460,
IS 200T/250/300/350, NX 200T/300h,
RC 200T/300/350 & RX 350/400h/450h and
Toyota Avalon & Camry 1998 - On

UNIT PACKAGE: 25



22346
(Toyota: 53857-12010)
Black Nylon

Front Fender Moulding Clip with Sealer
Head Size: 20mm x 30mm
Stem Diameter: 9mm
Stem Length: 10mm
Lexus NX 200t, NX 300h, Scion iM and
Toyota Corolla & Prius 2015 - On

UNIT PACKAGE: 15



21684
(Toyota: 81496-21010)
Yellow Nylon

Rear Light Housing Guide with Sealer
Top Head Diameter: 13mm
Bottom Head Diameter: 20mm
Stem Length: 10mm
Toyota Prius 2012 - On

UNIT PACKAGE: 10



15695
(Toyota: 62955-20020, 65955-12010;
GM: 94848834)
White Nylon

Moulding Clip with Sealer
Head Diameter: 15mm
Stem Length: 9mm
Fits into 8mm Hole
Toyota Pick-Up Truck and Pontiac Vibe

UNIT PACKAGE: 25



21748
(Toyota: 75819-33010)
White Nylon

Moulding Clip with Sealer
Top Head Size: 8mm x 8mm
Bottom Head Diameter: 15mm
Stem Diameter: 10mm
Stem Length: 14mm
Lexus ES300 & ES330 & Scion and Toyota Camry,
Corolla, Prius, Sequoia, Sienna & Tundra 2002 - On

UNIT PACKAGE: 25



21453
(75395-0T010)
White Nylon

Moulding Clip with Sealer
Top Head Size: 5mm x 10mm
Bottom Head Diameter: 18mm
Stem Diameter: 10mm
Stem Length: 13mm
Corolla & Venza 2008 - On

UNIT PACKAGE: 25



19647

(90467-11111)
Red Nylon

Scuff Plate Retainer
Head Diameter: 18mm
Stem Diameter: 10mm
Stem Length: 10mm
Sienna 1997-On

UNIT PACKAGE: 10



21653

(75867-AC020)
White Nylon

Moulding Clip with Sealer
Head Diameter: 18mm
Stem Length: 13mm
Fits into 8mm Hole
Avalon 2005 - On

UNIT PACKAGE: 15



19797

(90467-10077)
Butterscotch Nylon

Door Moulding Clip with Sealer
Head Diameter: 15mm
Stem Length: 9mm
Fits into 8mm Hole
Avalon & Corolla 1998 - On

UNIT PACKAGE: 15



22217

(Toyota: 90467-08225)
White Nylon

Moulding Clip with Sealer
Top Head Size: 10mm x 10mm
Bottom Head Diameter: 15mm
Stem Diameter: 8mm x 8mm
Stem Length: 8mm
Toyota Corolla, Highlander & RAV4 2014 - On

UNIT PACKAGE: 25



21550

(90467-11099)
White Nylon

Hood and Front &
Rear Side Moulding Clip
Head Diameter: 17mm
Stem Length: 8.5mm
Fits into 9mm Square Hole
Tundra & 4-Runner 2006 - 1996

UNIT PACKAGE: 25



20687

(75396-35020, 75495-35010)
Blue Nylon

Rocker Moulding Clip with Sealer
Head Diameter: 17mm
Stem Length: 10mm
4-Runner 2003 - On

UNIT PACKAGE: 10



17481

(90467-11063)
White Nylon

Rocker Panel
Moulding Clip with Sealer
Head Diameter: 18mm
Stem Length: 9mm
Previa 1990-On

UNIT PACKAGE: 15



20390

(90904-67036)
Blue Nylon

Fender Moulding Clip
Head Diameter: 17mm
Stem Length: 17mm
Highlander, Land Cruiser,
Tacoma & Tundra 2001 - On

UNIT PACKAGE: 10



20391

(90904-67037)
Red Nylon

Fender Moulding Clip
Head Diameter: 17mm
Stem Length: 13mm
Highlander, Land Cruiser,
Tacoma & Tundra 2001 - On

UNIT PACKAGE: 10



20688

(75397-35010)
Orange Nylon

Wheel Flare Moulding Clip with Sealer
Head Diameter: 17mm
Stem Length: 17mm
4-Runner 2003 - On

UNIT PACKAGE: 10



20429

(90467-11100)
Yellow Nylon

Fender & Wheel Flare
Moulding Clip
Head Diameter: 17mm
Stem Length: 17mm
Highlander, Land Cruiser, Tacoma & Tundra 2000 - On

UNIT PACKAGE: 10



21847

(Toyota: 90467-08195)
White Nylon

Front & Rear Fender Flare
Moulding Clip with Sealer
Head Size: 15mm x 22mm
Stem Length: 13mm
Overall Length: 21mm
Lexus GX470 2009 - 03
Toyota Land Cruiser 2007 - 1998

UNIT PACKAGE: 25



21846

(Toyota: 90467-08196)
Yellow Nylon

Front & Rear Fender Flare and
Mudguard Moulding Clip with Sealer
Head Size: 16mm x 22mm
Stem Length: 19mm
Overall Length: 27mm
Lexus GX470 2009 - 03
Toyota Land Cruiser 2007 - 1998

UNIT PACKAGE: 25



19843

(75498-42010)
White Nylon

Garnish Clip
Head Diameter: 20mm
Stem Length: 20mm
RAV4 1996 - On

UNIT PACKAGE: 10



21612

(76817-12060)
White Nylon

Rear Door, Hatch Garnish and
Luggage Compartment
Moulding Clip with Sealer
Large Head Diameter: 24mm
Overall Length: 24mm
Camry, Corolla & Matrix 2003 - On

UNIT PACKAGE: 15



22350

(Toyota: 90467-A0004)
White Nylon

Headliner & Interior Trim Moulding Clip
Top Head Size: 14mm x 20mm
Bottom Head Size: 18mm x 24mm
Stem Diameter: 10mm
Stem Length: 14mm
Lexus RX 350 and Toyota
Avalon & Camry 2005 - On

UNIT PACKAGE: 25



22215

(Toyota: 75397-42010)
White Nylon

Moulding Clip with Sealer
Top Head Size: 14.5mm x 17mm
Bottom Head Size: 12mm x 18mm
Stem Length: 9mm
Toyota RAV4 2005 - 2001

UNIT PACKAGE: 25



20578

(GM: 88970495, 88973654;
Toyota: 76924-52021)
Black Nylon

Rocker Moulding Retainer
Head Diameter: 32mm
Stem Length: 10mm
Fits into 22mm Hole
Pontiac Vibe & Toyota Corolla 2003 - On

UNIT PACKAGE: 25



14264

(75395-14020-A)
Nylon

Moulding Clip
Width: 28mm
Length: 14mm
Snaps into 7mm Hole

UNIT PACKAGE: 25



21071

(90084-46020)
White Nylon

Bumper Cover Clip
Head Size: 21mm x 30mm
Stem Length: 12mm
Camry 2005 - On

UNIT PACKAGE: 10



21641

(90467-12073)
White Nylon

Rocker Moulding Clip
Head Size: 23mm x 28mm
Stem Length: 14mm
Fits into 10mm x 10mm Hole
Land Cruiser 2007 - 1998

UNIT PACKAGE: 15



19380

(68211-07010)
Natural Nylon

Door Belt Moulding Clip
Avalon 1994-On

UNIT PACKAGE: 25



21712

(Toyota: 52535-0E030)
White Nylon

Moulding Clip
Top Head Size: 13mm x 13mm
Stem Length: 22mm
Overall Length: 25mm
Lexus LS 600h & RX 450h
and Toyota RAV4 & 4Runner 2006 - On

UNIT PACKAGE: 15



21857

(Toyota: 75392-35220)
White Nylon

Front & Rear Spoiler Moulding Clip
Head Size: 10mm x 20mm
Stem Length: 24mm
Overall Length: 27mm
Lexus HS250 & RX350 and Toyota
Camry, Corolla, FJ Cruiser &
Highlander 2010 - On

UNIT PACKAGE: 25



21016

(75392-35200, 75392-04010)
Blue Nylon

Fender Flare & Bumper Clip
Head Size: 13mm x 26mm
Stem Length: 24mm
Toyota Camry, FJ,
RAV4 & Tacoma 2005 - On

UNIT PACKAGE: 15



21586

(76853-10010)
White Nylon

Front & Rear Bumper Clip
Head Size: 13mm x 26mm
Stem Length: 25mm
Matrix 2008 - 03

UNIT PACKAGE: 25



22158

(Toyota: 62217-33031)
Black Nylon

Windshield Pillar Trim Clip
Overall Length: 43mm
Stem Size: 7mm x 12mm
Stem Length: 12mm
Toyota Camry 2011 - 2007

UNIT PACKAGE: 15



22159

(Toyota: 90950-08004)
Black Nylon

Roof Garnish &
Front Pillar Post Trim Clip
Overall Length: 51mm
Stem Size: 7mm x 12mm
Stem Length: 12mm
Toyota Camry, Corolla, Highlander,
Land Cruiser, Matrix &
RAV4 2013 - 2004

UNIT PACKAGE: 15



21642

(90467-12075)
Yellow Nylon

Rocker Moulding Clip
Top Head Size: 11mm x 13mm
Bottom Head Size: 15mm x 25mm
Stem Length: 14mm
Fits into 10mm x 10mm Hole
Land Cruiser 2007 - 1998

UNIT PACKAGE: 15



21133

(52197-52010)
Black Nylon

Front Bumper
Moulding Clip with Sealer
Overall Width: 30mm
Overall Height: 25mm
Stem Length: 13mm
Highlander 2001 - On

UNIT PACKAGE: 10



21234

(61991-35010)
Black Nylon

Front Fender/Sheet Metal
Upper Seal Moulding Clip
Top Head Size: 9mm x 31mm
Overall Height: 30mm
FJ Cruiser 2007 - On

UNIT PACKAGE: 10

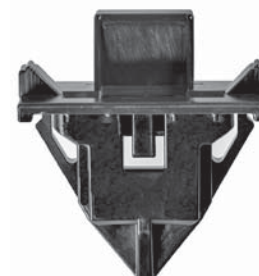

21235

(61992-35010)
Black Nylon

Front Fender/Sheet Metal
Upper Seal Moulding Clip
Top Head Size: 13mm x 31mm
Overall Height: 34mm
FJ Cruiser 2007 - On

UNIT PACKAGE: 10



21132
(52115-48040)
Gray Nylon
Front Bumper
Moulding Clip
Overall Length: 47mm
Stem Length: 8mm
Highlander 2001 - On
UNIT PACKAGE: 10



17636
Nylon
License Plate
Bracket Spacer
Inner Diameter: 1/4" (6mm)
Outer Diameter: 3/4" (19mm)
Thickness: 1/4" (6mm)
UNIT PACKAGE: 50



21217
(76924-47010)
Black Nylon
Rocker Panel
Moulding Clip
Head Size: 43mm x 54mm
Overall Height: 26mm
Prius 2009 - On
UNIT PACKAGE: 5



19722
(68211-95D00)
White Nylon
Door Glass Clip
Previa Van 1990 - On
UNIT PACKAGE: 15



21221
(52115-0C090)
Black Nylon
Front Bumper Moulding Clip
Head Size: 25mm x 74mm
Overall Height: 17mm
Stem Length: 15mm
Tundra 2009 - On
UNIT PACKAGE: 10



16833
(75545-32020)
Nylon
Windshield Moulding Clip
Width: 12mm
Length: 66mm
Camry 1987-On
UNIT PACKAGE: 10



21162
(53935-35020)
Black Nylon
Bumper Filler Clip
Overall Length: 30mm
Overall Height: 17mm
4 Runner 2003 - On
UNIT PACKAGE: 10



19204
(75546-12060)
Natural Nylon
Windshield Moulding Clip
Corolla Sedan Wagon 1992-88
UNIT PACKAGE: 25



16800
Photo not actual size
M6-1.0 x 20mm
License Plate Hardware
Includes Nylon Screw,
Washer & Spacer and Brass Nut
UNIT PACKAGE: 25 Sets



17334
(75546-22060)
Natural Nylon
Windshield Side Moulding Clip
Cressida 1988-On
UNIT PACKAGE: 15



14746
(75546-12050)
Nylon

Windshield Moulding Clip
Width: 20mm
Length: 41mm
Fits into 8mm Hole

UNIT PACKAGE: 15



14751
(75545-16020)
Nylon

Windshield Moulding Clip
Width: 18mm
Length: 49mm
Height: 13mm

UNIT PACKAGE: 25



17298
(75547-22010)
Black Nylon

Windshield Moulding Clip
Width: 20mm
Length: 47mm
1981-On

UNIT PACKAGE: 25



14749
(75545-88080;
75545-28010-B)
Nylon

Windshield Moulding Clip
Width: 18mm
Length: 49mm
Height: 16mm

UNIT PACKAGE: 25



19484
(75548-22150)
Blue Nylon

Windshield Moulding Clip
with Adhesive Backing
Width: 9mm
Length: 40mm
Cressida 1988 - On

UNIT PACKAGE: 10



14747
(75545-14081)
Nylon

Windshield Moulding Clip
Width: 18mm
Length: 50mm
Height: 15mm

UNIT PACKAGE: 25



14745
(75546-22050)
Nylon

Windshield Moulding Clip
Width: 14mm
Length: 47mm
Height: 12mm

UNIT PACKAGE: 25



16821
(75546-12030)
Nylon

Windshield Moulding Clip
Width: 21mm
Length: 54mm
Height: 15mm
Corolla 1984-On

UNIT PACKAGE: 25



16942
(75545-89101)
Nylon

Windshield Moulding Clip
Width: 15mm
Length: 47mm
Height: 13mm
Pick-Up Truck 1984-On

UNIT PACKAGE: 15

WE WELCOME INQUIRES

If you have item suggestions
please send them to
mail@auveco.com

or

go to www.auveco.com to
submit your suggestions.



17224

(90189-04022, 95900-04036)
Nylon

Screw Size: #6
Width: 10mm
Length: 10mm
Snaps into 7mm x 7mm Hole

UNIT PACKAGE: 50



14271

(90189-04011)
Natural Nylon

Screw Size: #6
Width: 12mm
Length: 12mm
Snaps into 7mm x 7.5mm Hole

UNIT PACKAGE: 25



21628

(81137-22530, 90075-10004)
White Nylon

Screw Size: M3.5 (#6)
Head Size: 10mm x 10mm
Stem Length: 7mm
Fits into 7mm x 7mm Hole
Avalon, Camry, Land Cruiser,
Tacoma & Tundra 2007 - 1992

UNIT PACKAGE: 25



22051

(Toyota: 90467-11117)
White Nylon

Rear Trunk License Plate
Trim Retaining Nut
Screw Size: M3.5 (#6)
Overall Height: 11.5mm
Width at Bottom: 11mm
Lexus & Toyota 2009 - 1998

UNIT PACKAGE: 15



14256

(90189-04014)
Natural Nylon

Screw Size: #8
Width: 10mm
Length: 10mm
Snaps into 7mm x 7mm Hole

UNIT PACKAGE: 50



13932

(Toyota: 90189-05013;
Mitsubishi: MS-480002)
Natural Nylon

Screw Size: #10
Width: 12mm
Length: 12mm
Fits into 8mm x 9mm Hole

UNIT PACKAGE: 50



14274

(Toyota: 90189-06010;
Honda: 75521-611-000;
Mazda: 9991-00-601;
Nissan: 96706-P0105)
Natural Nylon

Screw Size: #10
Width: 13mm
Length: 13mm
Snaps into 8.5mm x 8.5mm Hole

UNIT PACKAGE: 25



14258

(90189-06018)
Black Nylon

Screw Size: #10
Width: 14mm
Length: 14mm
Snaps into 9mm x 9mm Hole

UNIT PACKAGE: 25



20895

(90189-06193)
Natural Nylon

Front Bumper Nylon Nut
Screw Size: M5.5 (#12)
Head Size: 14mm x 16mm
Stem Length: 10mm
Avalon & Camry 2002 - On

UNIT PACKAGE: 25



14739

(Toyota: 90189-05012;
Isuzu: 8941340270)
Natural Nylon

Screw Size: #6
Width: 16mm
Length: 12mm
Snaps into 6mm x 10mm Hole

UNIT PACKAGE: 50



20431

(90189-05105)
Natural Nylon

Front Fender Flare Screw Grommet
Screw Size: M4.2 (#8)
Head Size: 10mm x 15mm
Stem Length: 12mm
RAV4 1996 - On

UNIT PACKAGE: 15



21151

(90189-04059)
White Nylon

Rocker, Pillar, Floor &
Exterior Trim Screw Grommet
Screw Size: M3.5 (#6)
Head Size: 12mm x 18mm
Stem Length: 7mm
Toyota Scion, Avalon & FJ Cruiser
and Lexus ES300, ES330, RX330,
RX400, SC300, SC400 1992 - On

UNIT PACKAGE: 25



19840

(90189-04176)
Natural Nylon

Mudguard Screw Grommet
Screw Size: #8 (M4.2 - 1.41)
Head Size: 10mm x 10mm
Stem Length: 15mm
Corolla 1997 - On

UNIT PACKAGE: 15



21544

(90189-04102)
White Nylon

Screw Grommet with Sealer
Screw Size: M3.2 (#6)
Head Size: 10mm x 10mm
Stem Length: 15mm
Fits into 7mm Square Hole
Toyota Highlander and
Lexus IS 250, IS 350, & IS F 2006 - On

UNIT PACKAGE: 25



19783

(Ford: N811169-S, W705550-S300;
Toyota: 90075-10801, 90189-06111)
White Nylon

Head Diameter: 13mm
Stem Length: 9mm
Fits into 11mm Hole
Ford, Lexus & Toyota

UNIT PACKAGE: 50



14277

(90189-04008, 90467-12096)
Black Nylon

Screw Grommet
Screw Size: #8
Width: 12mm
Length: 16mm
Height: 15mm
Fits into 10mm x 10mm Hole

UNIT PACKAGE: 15



18843

(90189-04031)
Natural Nylon

Grille & Rear Filler Nut
Screw Size: #8
Camry & RAV4 2000 - 1991

UNIT PACKAGE: 25



18846

(53145-16020)
Black Nylon

Radiator Grille
Garnish Grommet
Terrel 1990 - On

UNIT PACKAGE: 10



14263

(90189-04019)
Natural Nylon

Screw Size: #8
Width: 12mm
Length: 14mm
Fits into 6.5mm x 8.5mm Hole

UNIT PACKAGE: 25



21015

(52535-50060, 52535-0E010)
Black Nylon

Front Bumper Screw Grommet
Screw Size: M5.5 - M6 (#12)
Head Size: 17mm x 30mm
Stem Length: 9mm
Lexus IS250, IS350, RX330 & RX350 and
Toyota Camry, Highlander & Tacoma 2001 - On

UNIT PACKAGE: 5



21583

(52535-30150)
White Nylon

Front & Rear Bumper Screw Grommet
Screw Size: M5.5 (#12)
Head Size: 17.5mm x 30mm
Stem Length: 10mm
Toyota Avalon, Sequoia & Tundra and Lexus ES300,
330, 350, LS430 & RX300 1999 - On

UNIT PACKAGE: 25



14265

(90189-06006)
Natural Nylon

Screw Size: M4.8 (#10)
Head Diameter: 17mm
Fits into 9mm x 9mm Hole

UNIT PACKAGE: 25



21331

(90189-06211)
Black Nylon

Pillar, Rocker and Floor
Screw Grommet
Screw Size: M5.5 (#12)
Head Diameter: 17mm
Stem Length: 10mm
Fits into 9mm Square Hole
Camry 2010 - On

UNIT PACKAGE: 25



21191

(90189-05142)
Natural Nylon

Headlight Mounting Nylon Nut
Screw Size: M4.2 (#8)
Head Diameter: 17mm
Stem Length: 8mm
Fits into 9mm Square Hole
Toyota & Scion 2001 - On

UNIT PACKAGE: 25



19187

(90189-05082)
Natural Nylon

Hood Seal to Cowl Top
Screw Grommet
Screw Size: #6
Head Diameter: 13mm
Stem Length: 13mm
Fits into 7mm x 7mm Hole
2WD & 4WD Truck 1988-On

UNIT PACKAGE: 15



14268

(Toyota: 90189-04013;
Honda: 90672-671-8110M1)
Natural Nylon

Screw Size: #6
Head Diameter: 14mm
Stem Length: 15mm
Fits into 7mm x 7mm Hole

UNIT PACKAGE: 25



14695

(Toyota: 90189-06042;
Honda: 90661-SC7-003;
Mazda: H001-50-841;
Mitsubishi: MS-480012;
Nissan: 01651-00481, 74798-S9000)
White Nylon

Screw Grommet
Screw Size: #8
Head Diameter: 16mm
Stem Length: 17mm
Fits into 8mm x 8mm Hole

UNIT PACKAGE: 25



14275

(Toyota: 90189-06001;
Mitsubishi: MB-098145;
Nissan: 01281-00023, 01281-00231)
White Nylon

Screw Grommet
Screw Size: M4.8 (#10)
Head Diameter: 18mm
Stem Length: 17mm
Fits into 8.5mm x 8.5mm Hole

UNIT PACKAGE: 25



14281

(Honda: 90662-693-003;
Toyota: 90189-04066)
White Nylon

Screw Grommet
Screw Size: #6
Head Diameter: 14mm
Stem Length: 10mm
Fits into 7mm x 7mm Hole

UNIT PACKAGE: 25



19505

(Toyota: 90189-06029,
90189-06084, 90189-06116;
Hyundai: 86910-22000)
Natural Nylon

Rear Door Panel Screw Grommet
Screw Size: #12
Head Diameter: 18mm
Stem Length: 17mm
Fits into 9mm x 9mm Hole
Camry & Previa 1988 - On
Hyundai 1997 - On

UNIT PACKAGE: 10



19742

(90189-06104)
Natural Nylon

Fender Lining Screw Grommet
Screw Size: #12 (M5.5)
Head Diameter: 18mm
Stem Length: 15mm
Fits into a 9mm Square Hole
Lexus IS300 & Toyota Avalon,
Camry & Sienna 1997-On

UNIT PACKAGE: 15



21625

(90189-06145)
Black Nylon

Fender Lining Screw Grommet
Screw Size: M5.5 (#12)
Head Diameter: 16mm
Stem Length: 16mm
Fits into 9mm x 9mm Hole
Toyota Prius, Sequoia & T-100
and Lexus CT 200h 1993 - On

UNIT PACKAGE: 15



22213

(Toyota: 90189-06076)
Natural Nylon

Screw Grommet
Screw Size: M5.5 (#12)
Head Diameter: 16mm
Stem Length: 16mm
Fits into 9mm x 9mm Square Hole
Toyota Yaris and Scion xA & xD 2007 - On

UNIT PACKAGE: 25



20440

(90189-06065)
Black Nylon

Hood & Fender Screw Grommet
Screw Size: M5.5 (#12)
Head Diameter: 20mm
Stem Length: 18mm
Fits into 9mm x 9mm Hole
Camry & RAV4 1999 - 95

UNIT PACKAGE: 15



19194

(Toyota: 90189-06028; GM: 94854203)
Black Nylon

Front & Rear Wheel
Fender Liner Screw Grommet
Screw Size: #12
Head Diameter: 16mm
Stem Length: 19mm
Fits into 9mm x 9mm Hole
Tacoma, T100 & 4 Runner 1992-On
Chevrolet Nova & Prizm and Pontiac Vibe 1985-On

UNIT PACKAGE: 15



19721

(90189-06157)
Black Nylon

Fender Lining Screw Grommet
Screw Size: M5.5 (#12)
Head Diameter: 20mm
Stem Length: 22mm
Fits into 8mm x 8mm Hole
Avalon, Camry, RAV4, Solara
& Tacoma 1995-On

UNIT PACKAGE: 15



19756

(90189-06214)
Black Nylon

Fender Liner
Screw Grommet
Screw Size: #12 (M5.5)
Head Diameter: 16mm
Stem Length: 18mm
Sienna, Tacoma & Tundra Pick-Up 1999 - On

UNIT PACKAGE: 15



21411

(90189-06177)
Black Nylon

Rocker Moulding Screw Grommet
Screw Size: M5.5. (#12)
Head Diameter: 20mm
Stem Length: 22mm
Fits into 9mm x 9mm Hole
Camry 2010 - On

UNIT PACKAGE: 15



21605

(90189-A0002)
Black Nylon

Screw Grommet
Screw Size: M5.5 (#12)
Head Diameter: 20mm
Stem Length: 17mm
Fits into 9mm x 9mm Hole
Toyota Avalon, Corolla, FJ Cruiser, RAV4,
Sienna, Tacoma & 4Runner and Lexus
GX460, GX470 & LX570 1995 - On

UNIT PACKAGE: 25



20412

(90189-06114)
White Nylon

Front Fender Liner Screw Grommet
Screw Size: M5.5 (#12)
Head Diameter: 18mm
Stem Length: 15mm
Fits into 9mm Square Hole
RAV4 1996 - On

UNIT PACKAGE: 15



21792

(Toyota: 90189-06236)
Black Nylon

Fender Liner Screw Grommet
Screw Size: M5.5 (#12)
Head Diameter: 20mm
Stem Length: 17mm
Fits into 9mm x 9mm Hole
Toyota Echo, RAV4
Tacoma & Scion 2005 - On

UNIT PACKAGE: 25



14266

(90189-06003)
Nylon

Screw Grommet
Screw Size: #14 (1/4") or M6.3-1.81
Head Diameter: 18mm
Stem Length: 21mm
Fits into 8mm x 8mm Hole

UNIT PACKAGE: 15



14273

(90189-06005)
White Nylon

Screw Grommet
Screw Size: #14 (1/4") or M6.3-1.81
Head Diameter: 18mm
Stem Length: 16mm
Fits into 8mm x 8mm Hole
Lexus & Toyota

UNIT PACKAGE: 50



19534

(90467-10152)
Natural Nylon

Cowl Vent Grommet
Flange Diameter: 18mm
Stem Length: 16mm
Fits into 9mm Hole
Use with Auveco 19535
Lexus ES300, Toyota Camry & Tercel 1995 - On

UNIT PACKAGE: 10



14267

(90189-06013)
Black Nylon

Screw Grommet
Screw Size: #14 (1/4") or M6.3-1.81
Head Diameter: 20mm
Stem Length: 17mm
Fits into 8mm x 8mm Hole
Lexus & Toyota

UNIT PACKAGE: 25



19535

(90467-07126)
Black Nylon

Cowl Vent Pin Retainer
Head Diameter: 16mm
Stem Length: 17mm
Use with Auveco 19534
Lexus ES300, Toyota Camry & Tercel 1995 - On

UNIT PACKAGE: 10



22197

(Toyota: 52188-06030)
Yellow Nylon

Rear Bumper Screw Grommet with Sealer
Screw Size: M6 (#14)
Head Diameter: 20mm
Stem Length: 22mm
Fits into 9mm x 9mm Square Hole
Toyota Camry 2011 - 07

UNIT PACKAGE: 15



21797

(Toyota: 53879-30040)
Black Nylon

Front Bumper
Cover Clip
Width: 32mm
Length: 39mm
Use with Auveco 21357
Lexus CT200h &
HS250h 2010 - On
Toyota Camry 2012 - On

UNIT PACKAGE: 5



22096

(Toyota: 52197-22020)
Black Nylon

Rear Bumper Side
Bracket Screw Grommet with Sealer
Screw Size: M6.3 (#14)
Head Size: 16mm x 18mm
Stem Length: 19mm
Lexus ES 350 & HS 250h 2012 - 07
Toyota Avalon & Camry 2012 - On

UNIT PACKAGE: 15



20758

(53879-58010)
Black Nylon

Front Fender &
Bumper Cover Clip
Width: 25mm
Length: 34mm
Use with Auveco 20757
Lexus and Toyota 4 Runner,
Highlander, Sienna & Solara 2000 - On

UNIT PACKAGE: 5



21237

(53867-47020)
Dark & Light Gray Nylon

Front Fender Retainer with Sealer
Overall Height: 18mm
Fits into 10mm x 16mm Hole
Prius 2004 - On

UNIT PACKAGE: 10



20757

(47749-58010)
Black Nylon

Front Fender & Bumper
Cover Pin Retainer
Head Diameter: 15mm
Stem Length: 25mm
Use with Auveco 20758
Lexus and Toyota 4 Runner
Highlander, Sienna & Solara 2000 - On

UNIT PACKAGE: 10



22073

(Toyota: 76924-47020)
Black Nylon

Moulding Retainer
Head Diameter: 32mm
Stem Length: 12mm
Fits into 22mm Hole
Lexus CT 200h & Toyota Prius 2011 - On

UNIT PACKAGE: 15



22166

(Toyota: 76924-12030)
Black Nylon

Rocker & Quarter
Moulding Retainer
Head Size: 28mm x 37mm
Stem Length: 10mm
Fits into 17mm x 22mm Hole
Toyota Corolla 2014 - On
Scion iQ 2014 - 2012

UNIT PACKAGE: 25

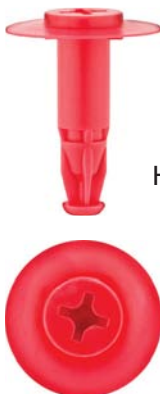

22353

(Toyota: 90467-09237)
Red Nylon

Body Side Retainer
Head Diameter: 20mm (with Phillips Drive)
Stem Length: 24mm
Overall Length: 26mm
Lexus GS 200h, GS 350,
GS 450h, IS 250, IS 350, RC 350,
RX 350, RX 450h,
Toyota Camry & Scion iM 2012 - On

UNIT PACKAGE: 25



19014

(90467-10123)
Natural Nylon

Trim Panel Retainer
Head Size: 11mm x 12mm
Stem Length: 16mm
Fits into 8mm Hole
Celica 1993 - On

UNIT PACKAGE: 10



19686

(90467-05045-22)
Black Nylon

Weatherstrip Retainer
Head Diameter: 12mm
Stem Diameter: 5mm Sq.
Stem Length: 6mm
Solara 1998-On

UNIT PACKAGE: 25



19312

(90467-05096-22)
Black Nylon

Luggage Compartment
Trim Panel Retainer
Head Diameter: 16mm
Stem Diameter: 5mm
Stem Length: 13mm
Tercel & Paseo 1994-On

UNIT PACKAGE: 25



19643

(90467-06175)
Black Nylon

Luggage Compartment Retainer
Head Diameter: 16mm
Stem Diameter: 6mm
Stem Length: 16mm
Solara 1998-On

UNIT PACKAGE: 15



20184

(90467-08186)
Black Nylon

Luggage Compartment Trim Retainer
Head Diameter: 16mm
Stem Diameter: 8mm
Stem Length: 16mm
Camry 1999 - On

UNIT PACKAGE: 25



20878

(90467-A0008)
Black Nylon

Bumper Cover Retainer
Head Diameter: 19mm
Stem Diameter: 7.5mm
Stem Length: 16mm
Toyota, Lexus & Scion 1995 - On

UNIT PACKAGE: 50



21253

(90467-05164-B6)
Gray Nylon

Headliner Retainer
Head Diameter: 20mm
Stem Diameter: 6mm
Stem Length: 15mm
Yaris 2009 - On

UNIT PACKAGE: 25



21332

(90467-05164-E2)
Tan Nylon

Headliner Retainer
Head Diameter: 20mm
Stem Diameter: 6mm
Stem Length: 15mm
Corolla & Yaris 2009 - On

UNIT PACKAGE: 25



19121

(90467-08104)
Gray Nylon

Roof Headliner Retainer
Head Diameter: 20mm
Stem Diameter: 8mm
Stem Length: 20mm
MR2 1990 - On

UNIT PACKAGE: 15



22214

(Lexus: 90467-06015-C0)
Black Nylon

Front & Rear Bumper Retaining Clip
Head Diameter: 7.5mm
Stem Diameter: 5.5mm
Stem Length: 10mm
Lexus GS 300, GS 400 &
GS 430 2005 - 1998

UNIT PACKAGE: 25



21626

(90467-06128)
Black Nylon

Weatherstrip Retaining Clip
Head Diameter: 12mm
Stem Diameter: 6.5mm
Stem Length: 11mm
Camry & RAV4 1992 - On

UNIT PACKAGE: 25



21296

(90080-46010)
Black Nylon

Hood Seal Retaining Clip
Head Diameter: 13mm
Stem Diameter: 7mm
Stem Length: 10mm
Camry 2010 - On

UNIT PACKAGE: 50



18297

(Toyota: 90467-08004, 90467-08011;
GM: 94842841, 94849113)
Black Nylon

Hood Seal Retaining Clip
Head Diameter: 13mm
Stem Length: 11mm
Fits into 6mm Hole
Lexus, Toyota, Geo Prizm & Nova 1985 - On

UNIT PACKAGE: 50



14737

(Toyota: 90467-07050, 90467-08008;
Nissan: 01553-00172)
Black Nylon

Retaining Clip
Head Diameter: 13mm
Stem Length: 15mm
Panel Thickness: 3mm
Fits into 5mm Hole

UNIT PACKAGE: 25



21695

(Toyota: 90467-08045, 90467-08063)
Black Nylon

Hood & Weatherstrip Retaining Clip
Head Diameter: 14mm
Stem Diameter: 9mm
Stem Length: 11mm
Toyota Yaris 2007 - On

UNIT PACKAGE: 25



22212

(Toyota: 53145-60030)
Black Nylon

Front Bumper, Grille & Hood Seal Retaining Clip
Head Size: 4.3mm x 11mm
Stem Diameter: 6.2mm
Stem Length: 10mm
Toyota Avalon, Camry, Highlander, Land Cruiser, Prius
& Venza and Lexus GS 350, GS 450h, IS 250,
IS 350, LX 570, NX 200t, NX 300h, RX 350 & RX 450h
and Scion iQ & tC 2008 - On

UNIT PACKAGE: 100



21643

(90467-08101)
Black Nylon

Hood to Cowl Top Seal
Retaining Clip
Head Size: 7mm x 13mm
Stem Diameter: 7.5mm
Stem Length: 13mm
Toyota Camry, Sequoia, Solara
& Tundra and Lexus ES 300 2006 - 1997

UNIT PACKAGE: 25



22001

(Toyota: 90467-08030)
Black Nylon

Trim Retaining Clip
Head Size: 9mm x 13mm
Stem Diameter: 7.5mm
Stem Length: 10mm
Toyota

UNIT PACKAGE: 25



19124

(90467-07096)
Black Nylon

Side Trim Panel Retaining Clip
Head Diameter: 16mm
Stem Length: 10mm
Fits into 6mm Hole
4WD Truck 1989-On

UNIT PACKAGE: 10



14736

(90467-06161-01)
Black Nylon



Retaining Clip
Head Diameter: 14mm
Stem Length: 10mm
Panel Thickness: 3mm
Fits into 5mm Hole

UNIT PACKAGE: 25



16777

(Mazda: B001-68-302-00;
Toyota: 90950-01248)
Black Nylon

Retaining Clip
Head Diameter: 15mm
Stem Length: 15mm
Panel Thickness: 2mm
Fits into 8mm Hole

UNIT PACKAGE: 25



16781

(Honda: 90670-692-003;
Toyota: 90467-09065)
Black Nylon

Retaining Clip
Head Diameter: 15mm
Stem Length: 20mm
Panel Thickness: 11mm
Fits into 7mm Hole

UNIT PACKAGE: 25



14347

(Toyota: 90467-10018;
Nissan: 01553-00202)
Black Nylon

Retaining Clip
Head Diameter: 18mm
Stem Length: 12mm
Panel Thickness: 4mm
Toyota and Nissan
Snaps into 7mm Hole

UNIT PACKAGE: 50



21634

(90467-10186)
Black Nylon

Dash & Fender Apron
Seal Retainer
Head Diameter: 16.5mm
Stem Diameter: 9mm
Stem Length: 13mm
Toyota 4 Runner, FJ Cruiser, Land Cruiser,
RAV4, Sequoia, Tundra and Lexus GX 460,
GX 470 & LX 470 1996 - On

UNIT PACKAGE: 25



22221

(Toyota: 90080-46327)
Black Nylon

Fender Apron Seal Retainer
Head Diameter: 17mm
Stem Length: 15mm
Fits into 7mm Hole

Toyota Sequoia, Tacoma & Tundra 2000 - On

UNIT PACKAGE: 50

"428" DISPLAY BOARDS

428 of the most popular body hardware and fastener items are shrink-wrapped onto seven different boards. Each board contains product groups, body shops are familiar with and use often.

The back of each board contains each part number, unit package quantity, OEM number and size specification. The backs are protected by a clear plastic liner.

Learn more about the display boards at the front of the catalog, online at www.auveco.com or contact customer service at 1-800-354-9816 or mail@auveco.com



16779
(Honda: 74842-659-0030;
Toyota: 90467-12078)
Black Nylon

Retaining Clip
Head Diameter: 18mm
Stem Length: 15mm
Panel Thickness: 6mm
Fits into 8mm Hole

UNIT PACKAGE: 25



19113
(90467-08124)
Black Nylon

Hood Insulation Retainer
Head Diameter: 25mm
Stem Diameter: 8mm
Stem Length: 12mm
Supra 1993-On
Lexus 1994-89

UNIT PACKAGE: 15



19842
(75867-30110)
Black Nylon

Rocker Panel Clip
Head Diameter: 18mm
Stem Length: 22mm
Fits into 9mm Hole
Corolla 1997 - On

UNIT PACKAGE: 15



19729
(90467-09050)
Black Nylon

Hood Insulation Retainer
Head Diameter: 25mm
Stem Length: 10mm
Fits into 7mm Hole
Lexus, Camry & Solara 1998-On

UNIT PACKAGE: 15



22103
(Toyota: 53857-47011)
Black Nylon

Front Fender
Retainer with Sealer
Head Diameter: 20mm
Stem Diameter: 9mm
Stem Length: 9mm
Lexus CT 200h and Toyota Camry, Prius,
RAV4, Yaris & 4-Runner 2010 - On

UNIT PACKAGE: 15



18878
(90467-08081)
Black Nylon

Hood Insulation Retainer
Head Diameter: 30mm
Stem Length: 16mm
Fits into 6mm Hole
Celica 1993-89

UNIT PACKAGE: 15



21254
(90467-08136)
Black Nylon

Fender Seal Retaining Clip
Head Diameter: 20mm
Stem Diameter: 8mm
Stem Length: 8mm
Snaps into 7mm Hole
Yaris 2009 - On

UNIT PACKAGE: 25



19112
(90467-09004)
Black Nylon

Hood Insulation Retainer
Head Diameter: 30mm
Stem Diameter: 8mm
Stem Length: 16mm
Tacoma 1995-On

UNIT PACKAGE: 15



21211
(53326-08010)
Black Nylon

Hood Insulation Retaining Clip
Head Diameter: 24mm
Stem Length: 12mm
Fits into 7mm Hole
Sienna 2009 - On

UNIT PACKAGE: 25



18842
(90467-09006)
Black Nylon

Hood Insulation Retainer
Head Diameter: 30mm
Stem Length: 17mm
Fits into 7mm Hole
Avalon, Camry, Lexus 1988-On

UNIT PACKAGE: 15



14738

(90467-09008)
Black Nylon

Retaining Clip
Head Diameter: 30mm
Stem Length: 17mm
Panel Thickness: 6mm
Fits into 7mm Hole

UNIT PACKAGE: 25



19123

(90467-10107)
Black Nylon

Fender Apron Seal Clip
Head Diameter: 17mm
2WD & 4WD Truck 1988-On

UNIT PACKAGE: 10



21627

(67868-30030)
Black Nylon

Door & Roof Rail Retainer
Head Diameter: 9mm
Stem Diameter: 5.3mm
Stem Length: 8mm
Toyota Camry, Corolla, Corona
& Land Cruiser 1999 - 74
Lexus HS 250h, IS 250, IS 350,
RX 350 & 450h 2006 - On

UNIT PACKAGE: 25



21548

(67869-20030)
Black Nylon

Weatherstrip Retainer
Head Diameter: 10mm
Stem Diameter: 6mm
Stem Length: 10mm
Toyota Camry, Celica, Corolla, Highlander, Matrix,
MR-2, Prius, RAV4, Scion, Solara & Supra and
Lexus IS 300 & SC 430 1990 - On

UNIT PACKAGE: 25



22357

(Toyota: 67869-22010)
Black Nylon

Front Door Weatherstrip Retainer
Head Diameter: 10mm
Stem Diameter: 5.3mm
Stem Length: 12.5mm
Toyota Avalon & Camry 2013 - On

UNIT PACKAGE: 25



21552

(90467-04034)
White Nylon

Weatherstrip Retainer
Top Head Size: 5mm x 15mm
Bottom Head Diameter: 9mm
Stem Diameter: 6.5mm
Stem Length: 4mm
Toyota Avalon, Corolla, Highlander, Matrix, Prius,
RAV4, Scion & Venza and Lexus CT 200h, HS 250h,
IS F, IS 250, IS 350, LS 460, LS 600h, RX 350,
RX 400h & RX 450h 2003 - On

UNIT PACKAGE: 25



21707

(Honda: 91563-SCV-003)
(Toyota: 67867-52010, 67867-0D060)
White Nylon

Weatherstrip Retainer
Head Size: 5mm x 15mm
Bottom Head Diameter: 6.5mm
Stem Diameter: 7mm
Stem Length: 8.5mm
Acura TL and Honda Element
Odyssey & Pilot 2003 - On
Toyota Echo, Land Cruiser, Prius, Tacoma
& Yaris and Lexus GS 450, GX 460
& LX 430 and Scion xA & xD 2000 - On

UNIT PACKAGE: 25



19749

(67867-12150)
White Nylon

Weatherstrip Retainer
Head Size: 5mm x 15mm
Stem Length: 10mm
Fits into 6mm Hole
Avalon 1995 - On

UNIT PACKAGE: 15



18692

(Mazda: G031-58-762;
Toyota: 67868-89101, 67867-28030,
67867-89103; Ford: E7GZ-6120586-B)
Natural Nylon

Weatherstrip Retainer
Head Size: 5mm x 15mm
Stem Length: 10mm
Fits into 5mm Hole
4-Runner 1989-83
Mazda 1996-On
Ford

UNIT PACKAGE: 50



20443
(67867-0C010)
Black Nylon

Weatherstrip Retainer
Head Size: 5mm x 15mm
Stem Length: 10mm
Fits into 6mm Hole
Tundra 1999 - On

UNIT PACKAGE: 25



19728
(90467-10146)
Black Nylon

Cowl Panel Retainer
Head Size: 8mm x 17mm
Stem Length: 14mm
Fits into 7mm Hole
Sienna Van 1997 - On

UNIT PACKAGE: 25



19720
(90467-06138)
Black & White Nylon

Hood to Cowl Seal Retainer
Head Size: 8mm x 17mm
Stem Length: 16mm
Fits into 7mm Hole
Avalon & Camry 1994 - On

UNIT PACKAGE: 10



21551
(67869-12050)
Black Nylon

Weatherstrip Retainer
Top Head Diameter: 9mm
Bottom Head Diameter: 12mm
Stem Diameter: 7mm
Stem Length: 13mm
Corolla & Prius 2007 - 01

UNIT PACKAGE: 25



16778
(Mazda: 9927-40-822;
Toyota: 62581-14020)
Natural Nylon

Trim Panel Retainer
Top Head Diameter: 14mm
Bottom Head Diameter: 18.5mm
Stem Diameter: 11.5mm
Stem Length: 14mm
Overall Length: 20mm

UNIT PACKAGE: 25



20576
(GM: 88969790;
Toyota: 75867-21010)
Yellow Nylon

Fender Flare Retainer
Top Head Size: 10mm x 13mm
Bottom Head Size: 14mm x 18mm
Stem Diameter: 8.5mm x 8.5mm
Stem Length: 9mm
Overall Length: 13.5mm
Pontiac Vibe & Toyota Echo 2002 - On

UNIT PACKAGE: 25



21226
(75867-02010)
Black Nylon

Rocker Moulding Retainer
Top Head Diameter: 13mm
Bottom Head Diameter: 18mm
Stem Diameter: 9mm
Stem Length: 10mm
Overall Length: 15.5mm
Corolla 2009 - On

UNIT PACKAGE: 25



18861
(90467-10162)
White Nylon

Scuff Plate Retainer
Top Head Diameter: 13mm
Bottom Head Diameter: 18mm
Stem Diameter: 8.5mm x 8.5mm
Stem Length: 12mm
Overall Length: 17mm
Celica 1993-On

UNIT PACKAGE: 15



22056
(Toyota: 75867-30130)
White Nylon

Rocker Moulding Retainer with Sealer
Top Head Diameter: 13mm
Bottom Head Diameter: 18mm
Stem Diameter: 8.5mm x 8.5mm
Stem Length: 13mm
Lexus CT 200h, ES 300h, ES 350, GS 300, GS 350, GS 430, GS 460, GS 450h, HS 250h, IS 250, IS 350, IS F, LS 460, LS 600h & LX 570 and Toyota Land Cruiser 2006 - On

UNIT PACKAGE: 25



19719

(67921-32010)
White Nylon

Scuff Plate Retainer
Top Head Diameter: 13mm
Bottom Head Diameter: 18mm
Stem Diameter: 10mm
Stem Length: 11mm
Overall Length: 17.5mm
Avalon, Camry & Corolla 1997 - On

UNIT PACKAGE: 15



20473

(67771-12070)
White Nylon

Door Panel & Rocker Moulding Retainer with Sealer
Top Head Diameter: 13mm
Bottom Head Diameter: 18mm
Stem Diameter: 11mm
Stem Length: 14mm
Overall Length: 20mm
Lexus SC300/400 Toyota Avalon & Corolla 1992 - On

UNIT PACKAGE: 15



21538

(75867-33030)
Charcoal Nylon

Rocker Moulding Retainer
Top Head Diameter: 13mm
Bottom Head Diameter: 18mm
Stem Diameter: 9.5mm
Stem Length: 13mm
Overall Length: 18.5mm
Avalon, Camry, Prius, Scion, Sienna, Solara & Venza 2000 - On

UNIT PACKAGE: 25



21795

(Toyota: 67773-0E020)
White Nylon

Door Panel Retainer with Sealer
Top Head Diameter: 13mm
Bottom Head (Including Sealer) Diameter: 18mm
Overall Length: 20mm
Fits into 8.5mm Hole
Lexus RX350 2009 and Toyota Camry 2012 - On

UNIT PACKAGE: 25



21012

(75867-AA010)
Black Nylon

Rocker Panel & Scuff Plate Retainer
Top Head Diameter: 13mm
Bottom Head Diameter: 18mm
Stem Diameter: 9.5mm
Stem Length: 14mm
Overall Length: 18.5mm
Lexus ES300 & ES330 2002 - On
Toyota Avalon, Camry, Scion & Solara 2004 - On

UNIT PACKAGE: 15



22132

(Toyota: 53813-48011)
Gray Nylon

Front Fender Retainer with Sealer
Top Head Diameter: 20mm
Bottom Head Diameter: 22mm
Stem Length: 11mm
Fits into 10mm Hole
Lexus HS 250h, RX 350 & RX 450h and Toyota Prius & Sienna 2010 - On

UNIT PACKAGE: 10



18875

(67771-16170)
White Nylon

Door Trim Panel Retainer
Top Head Diameter: 13mm
Bottom Head Diameter: 18mm
Stem Diameter: 11mm
Stem Length: 15mm
Overall Length: 19.5mm
Tercel 1991 - On

UNIT PACKAGE: 25



21686

(Toyota: 67771-32120)
Green Nylon

Trim Panel Retainer with Sealer
Top Head Size: 13mm x 16mm
Middle Head Diameter: 16mm
Bottom Head Diameter: 18mm
Stem Diameter: 9mm
Stem Length: 9mm
Overall Length: 16.5mm
Lexus ES 300, GS 300, GS 450h, IS F, IS 250, LS 460, LS 600hL, RX 350, Scion xA and Toyota Prius 2001 - On

UNIT PACKAGE: 25



21410
(90467-09212)
White Nylon

Cowl Trim Retainer
Top Head Size: 13mm x 18mm
Middle Head Diameter: 16mm
Bottom Head Diameter: 18mm
Stem Diameter: 10.7mm
Stem Length: 12mm
Overall Length: 16mm
Camry 2010 - On

UNIT PACKAGE: 25



19203
(67771-89104)
Natural Nylon

Quarter Board
Inside Trim Panel Retainer
Top Head Diameter: 13mm
Middle Head Diameter: 16mm
Bottom Head Diameter: 18mm
Stem Diameter: 11mm
Stem Length: 11mm
Overall Length: 18.5mm
Truck 2WD 1997 - 1991

UNIT PACKAGE: 15



20558
(62217-13010)
White Nylon

Garnish Moulding Retainer
Top Head Diameter: 13mm
Middle Head Diameter: 16mm
Bottom Head Diameter: 15mm
Stem Diameter: 9mm x 9mm
Stem Length: 11mm
Overall Length: 17mm
Lexus and Toyota Corolla,
Matrix & 4 Runner 2003 - On

UNIT PACKAGE: 25



14728
(67771-22020)
Natural & Yellow Nylon

Door Panel Retainer
Top Head Diameter: 12.5mm
Middle Head Diameter: 16mm
Bottom Head Diameter: 13mm
Stem Diameter: 8.5mm
Stem Length: 11mm
Overall Length: 20mm

UNIT PACKAGE: 25



19109
(67771-30070)
Natural Nylon

Door Trim Panel & Garnish Retainer
Top Head Diameter: 13mm
Middle Head Diameter: 16mm
Bottom Head Diameter: 15mm
Stem Diameter: 9.5mm
Stem Length: 11mm
Overall Length: 18mm
Corolla Wagon, Tercel,
T-100 & Tacoma 2WD 1992-On

UNIT PACKAGE: 25



18844
(67771-06010, 67771-32090)
White Nylon

Trim Panel Retainer
Top Head Diameter: 13mm
Middle Head Diameter: 16mm
Bottom Head Diameter: 18mm
Stem Diameter: 10mm
Stem Length: 13mm
Overall Length: 20mm
Cowl Side & Garnish Center Pillar Retainer
Camry 1991-On

UNIT PACKAGE: 10



20559
(GM: 88970345;
Toyota: 90467-10167)
Blue Nylon

Garnish Moulding Retainer
Top Head Diameter: 13mm
Middle Head Diameter: 16mm
Bottom Head Diameter: 18mm
Stem Diameter: 9mm x 9mm
Stem Length: 11mm
Overall Length: 18mm
Pontiac Vibe, Lexus and Toyota 2000 - On

UNIT PACKAGE: 25



18950
(90467-10168)
Black & White Nylon

Garnish Retainer
Top Head Diameter: 13mm
Middle Head Diameter: 16mm
Bottom Head Diameter: 18mm
Stem Diameter: 10mm
Stem Length: 13mm
Overall Length: 20mm
Avalon & Camry 1991 - On

UNIT PACKAGE: 5



20575

(Toyota: 67771-12080;
GM: 88970656)
Yellow & White Nylon

Door Panel & Rocker Moulding Retainer
Top Head Diameter: 13mm
Middle Head Diameter: 16mm
Bottom Head Diameter: 18mm
Stem Diameter: 10mm
Stem Length: 13mm
Overall Length: 20mm
Toyota & Lexus 1998 - On
Pontiac Vibe 2003 - On

UNIT PACKAGE: 15



20633

(90467-10188)
Turquoise Nylon

Trim Panel Retainer
Top Head Diameter: 13mm
Middle Head Diameter: 16mm
Bottom Head Diameter: 18mm
Stem Diameter: 8.5mm x 9mm
Stem Length: 14mm
Overall Length: 20mm
Sienna 2004 - On

UNIT PACKAGE: 25



18876

(Toyota: 90467-10161;
GM: 94858299)
White Nylon

Trim Board Retainer
Top Head Diameter: 13mm
Middle Head Diameter: 16mm
Bottom Head Diameter: 18mm
Stem Diameter: 9mm x 9mm
Stem Length: 14mm
Overall Length: 20mm
Toyota Sienna, Solara & Tercel 1990 - On
Geo Prizm & Pontiac Vibe 1998 - On

UNIT PACKAGE: 25



21822

(Peugeot & Citroen: 6822.LL)
White Nylon

Door Panel Retainer
Top Head Diameter: 13mm
Middle Head Diameter: 16mm
Bottom Head Diameter: 18mm
Stem Diameter: 8.5mm x 9mm
Stem Length: 14mm
Overall Length: 20mm
Peugeot, Citroen & Toyota

UNIT PACKAGE: 25



19910

(90467-08179)
Yellow Nylon

Garnish Retainer
Top Head Diameter: 13mm
Middle Head Diameter: 16mm
Bottom Head Diameter: 18mm
Stem Diameter: 9mm x 9mm
Stem Length: 14mm
Overall Length: 20mm
Tundra 1999 - On

UNIT PACKAGE: 25



21102

(90467-A0005)
White Nylon

Door Trim Panel Retainer with Sealer
Top Head Diameter: 13mm
Middle Head Diameter: 16mm
Bottom Head Diameter: 18mm
Stem Diameter: 8.5mm
Stem Length: 14mm
Overall Length: 20mm
Lexus ES 350, GX470, IS250, IS 350, IS F, LS 460 &
LS 600HL and Toyota Camry, FJ Cruiser, Highlander,
RAV4 & 4-Runner 2001 - On

UNIT PACKAGE: 15



20437

(90467-09206)
White Nylon

Trim Panel Retainer
Top Head Diameter: 13mm
Middle Head Diameter: 16mm
Bottom Head Diameter: 18mm
Stem Diameter: 8.5mm x 8.5mm
Stem Length: 15mm
Overall Length: 20mm
RAV4 & Tundra 2000 - On

UNIT PACKAGE: 15



19257

(67771-12050)
Nylon

Front & Rear Door
Trim Board Retainer
Top Head Diameter: 13mm
Bottom Head Diameter: 18mm
Stem Diameter: 9mm
Stem Length: 14mm
Lexus and Toyota Celica, Corolla &
Previa 1990-On

UNIT PACKAGE: 15



14144
(67771-01010)
Black Nylon

Trim Panel Retainer
Top Head Diameter: 13mm
Middle Head Diameter: 15.5mm
Bottom Head Diameter: 18mm
Stem Diameter: 9.5mm
Stem Length: 14mm
Overall Length: 20.5mm

UNIT PACKAGE: 25



19898
(67771-02030)
Yellow Nylon

Trim Panel Retainer
Top Head Diameter: 13mm
Middle Head Diameter: 16mm
Bottom Head Diameter: 18mm
Stem Diameter: 9.5mm
Stem Length: 13mm
Overall Length: 21mm
Corolla 1990 - On

UNIT PACKAGE: 50



14269
(Toyota: 67771-01010, 67771-12010;
Isuzu: 8942264920;
Mazda: 9927-40-825)
White Nylon

Door Panel Retainer
Top Head Diameter: 13mm
Middle Head Diameter: 15.5mm
Bottom Head Diameter: 18mm
Stem Diameter: 9.5mm
Stem Length: 14mm
Overall Length: 20.5

UNIT PACKAGE: 25



15707
(67771-03030)
Gray Nylon

Door Trim Retainer
Top Head Diameter: 13mm
Middle Head Diameter: 16mm
Bottom Head: 17.5mm
Stem Length: 14mm
Stem Diameter: 10mm
Overall Length: 21mm
Camry 1988 - On

UNIT PACKAGE: 50



14270
(67771-22010)
Blue & Natural Nylon

Door Panel Retainer
Top Head Diameter: 13mm
Middle Head Diameter: 15.5mm
Bottom Head Diameter: 18mm
Stem Diameter: 9.5mm
Stem Length: 14mm
Overall Length: 20.5mm

UNIT PACKAGE: 25



19108
(67771-16080)
Natural Nylon

Door Trim Panel & Back Panel
Upper Garnish Retainer
Top Head Diameter: 13mm
Middle Head Diameter: 16mm
Bottom Head Diameter: 18mm
Stem Diameter: 9.5mm
Stem Length: 14mm
Overall Length: 21mm
Truck 1988-On

UNIT PACKAGE: 10



15709
(67771-02030)
Natural Nylon

Door Trim Retainer
Top Head Diameter: 13mm
Middle Head Diameter: 16mm
Bottom Head Diameter: 17.5mm
Stem Diameter: 9.5mm
Stem Length: 13mm
Overall Length: 21mm
Corolla 1990 - On

UNIT PACKAGE: 50



18874
(67771-16120)
Gray Nylon

Front & Rear Door
Trim Panel Retainer
Top Head Diameter: 13mm
Middle Head Diameter: 16mm
Bottom Head Diameter: 18mm
Stem Diameter: 9.5mm
Stem Length: 15mm
Overall Length: 21mm
Tercel 1994 - On

UNIT PACKAGE: 15



19016
(67771-12040)
Dark Gray Nylon

Door Trim Panel Retainer
Top Head Diameter: 13mm
Middle Head Diameter: 16mm
Bottom Head Diameter: 18mm
Stem Diameter: 9.5mm
Stem Length: 15mm
Overall Length: 21mm
Cressida 1992 - 88

UNIT PACKAGE: 15



19210
(67771-04040)
Natural Nylon

Front Door Trim Panel Retainer
Top Head Diameter: 13mm
Middle Head Diameter: 16mm
Bottom Head Diameter: 18mm
Stem Diameter: 10mm
Stem Length: 14mm
Overall Length: 22mm
Tacoma 1995 - On

UNIT PACKAGE: 50



19129
(Toyota: 67771-30090;
GM: 95008221)
Yellow Nylon

Door Trim Panel & Back Panel
Lower Garnish Retainer
Top Head Diameter: 13mm
Middle Head Diameter: 16mm
Bottom Head Diameter: 18mm
Stem Diameter: 9.5mm
Stem Length: 17mm
Overall Length: 23mm
Land Cruiser & 2WD Truck 1991 - On

UNIT PACKAGE: 15



22125
(Toyota: 90467-05170)
Black Nylon

Front Bumper Push-Type Retainer
Head Diameter: 10mm
Stem Length: 10mm
Fits into 5mm Hole
Lexus IS 250, IS 350 & NX 300h and Toyota Corolla,
Highlander, Matrix & RAV4 2012 - On

UNIT PACKAGE: 25



21103
(90467-05090-B1)
Black Nylon

Front Bumper Fascia Push-Type Retainer
Head Diameter: 10mm
Stem Length: 12mm
Fits into 5mm Hole
Corolla, Matrix & Scion 2008 - On

UNIT PACKAGE: 10



17383
(GM: 94847334, 96057847;
Toyota: 90467-07066;
Suzuki: 09409-07313)
Black Nylon

Radiator Grille & Trim Panel
Push-Type Retainer
Head Diameter: 11mm
Stem Length: 14mm (Excluding the Pin)
Fits into 7mm Hole
Toyota, Suzuki and Geo Tracker
& Prizm 1992 - 89

UNIT PACKAGE: 10



21218
(90467-05063-C0)
Black Nylon

Front Bumper Push-Type Retainer
Head Diameter: 11mm
Stem Length: 8mm
Fits into 5mm Hole
Corolla 2009 - On

UNIT PACKAGE: 15



21249
(90467-07071-22)
Black Nylon

Bumper Cover Push-Type Retainer
Head Diameter: 11mm
Stem Length: 9mm (Excluding the Pin)
Fits into 7mm Hole
Yaris 2009 - On

UNIT PACKAGE: 25



20196
(90467-06133-CO)
Black Nylon

Rocker Panel Push-Type Retainer
Head Diameter: 14mm
Stem Length: 8mm
Fits into 6mm Hole
4-Runner 1998 - On

UNIT PACKAGE: 15



21849

(Toyota: 90467-05136)
Black Nylon

Inner Door Lock Plate, Engine Cover &
Outside Air Duct Push-Type Retainer
Head Diameter: 13mm
Stem Length: 15mm
Fits into 5.5mm Hole
Lexus & Toyota 2012 - On

UNIT PACKAGE: 25



19013

(90467-07059-22)
Black Nylon

Rear Door Trim &
Luggage Compartment Door
Push-Type Retainer
Head Diameter: 15mm
Stem Length: 10mm
Fits into 7mm Hole
Camry & Celica 1990-On

UNIT PACKAGE: 15



21104

(90467-07190-B2)
Black Nylon

Interior Trim Push-Type Retainer
Head Diameter: 14mm
Stem Length: 14mm
Fits into 7mm Hole
Echo & Scion 2004 - On

UNIT PACKAGE: 10



17206

(90467-09145)
Black Nylon

Bumper Cover Push-Type Retainer
Head Diameter: 15mm
Stem Length: 12mm (Excluding Pin)
Fits into 9mm Hole
Camry 1992-On

UNIT PACKAGE: 15



17162

(GM: 96057846;
Toyota: 90467-07041)
Black Nylon

Push-Type Retainer
Head Diameter: 15mm
Stem Length: 8mm (Excluding the Pin)
Fits into 6.3mm Hole
Geo Metro & Tracker and
Toyota 1989 - On

UNIT PACKAGE: 10



21011

(90467-07188)
Black Nylon

Push-Type Retainer
Head Diameter: 15mm
Stem Length: 17mm
Fits into 7mm Hole
Camry, Tundra & 4-Runner 2002 - On

UNIT PACKAGE: 15



21120

(90467-07192)
Black Nylon

Cowl Vent Push-Type Retainer
Head Diameter: 15mm
Stem Length: 9mm (Excluding the Pin)
Fits into 7mm Hole
RAV4 2002 - On

UNIT PACKAGE: 15



19552

(90467-07146)
Black Nylon

Cowl Panel & Luggage
Compartment Retainer
Head Diameter: 16mm
Stem Length: 9mm
Fits into 7mm Hole
Avalon, Camry, Celica & Solara 1993 - On

UNIT PACKAGE: 15



14260

(Toyota: 90467-06017;
Mazda: 9926-50-625;
GM: 20426301)
Black Nylon

Push-Type Retainer
Head Diameter: 15mm
Stem Length: 12mm
Fits into 7mm Hole

UNIT PACKAGE: 15



21624

(90467-10206)
Black Nylon

Cowl Push-Type Retainer
Head Diameter: 16mm
Stem Length: 10mm
Fits into 8mm Hole
Toyota Camry, Sequoia, Tundra & Yaris and
Lexus ES 350, RX350 & RX 450h 2006 - On

UNIT PACKAGE: 15



21325

(90080-46294)
Black Nylon

Turn Signal Light & General Purpose
Push-Type Retainer
Head Diameter: 16mm
Stem Length: 14mm
Fits into 7mm Hole
Tundra 2003 - On

UNIT PACKAGE: 10



20335

(53879-60010)
Black Nylon

Fender Liner Push-Type Retainer
Head Diameter: 18mm
Stem Length: 7mm
Fits into 7mm Hole
Land Cruiser & RAV4 1998 - On

UNIT PACKAGE: 15



20869

(GM: 88970767;
Toyota: 90467-10183)
Black Nylon

Front Fender Liner
Push-Type Retainer
Head Diameter: 18mm
Stem Length: 7.5mm
Fits into 7mm Hole
Celica, Corolla, Matrix & Solara, Lexus
and Pontiac Vibe 1999 - On

UNIT PACKAGE: 10



19490

(90467-06150)
Black Nylon

Back Garnish Trim Panel
Push-Type Retainer
Head Diameter: 18mm
Stem Length: 8mm
Fits into 6mm Hole
Tacoma 1995 - On

UNIT PACKAGE: 10



20349

(Toyota: 90467-08185;
Nissan: 01553-09611)
Black Nylon

Push-Type Retainer
Head Diameter: 18mm
Stem Length: 10mm (Excluding the Pin)
Fits into 8mm Hole
Lexus & Toyota 2002 - On
Nissan 1994 - On

UNIT PACKAGE: 15



21547

(90467-09185)
Black Nylon

Front Spoiler & Grille
Push-Type Retainer
Head Diameter: 18mm
Stem Length: 10mm
Fits into 9mm Hole
Toyota Celica, Sequoia, Sienna & 4
Runner and Lexus HS 250h 1994 - On

UNIT PACKAGE: 25



21123

(75867-30120)
Black Nylon

Rocker Moulding Push-Type Retainer
Head Diameter: 18mm
Stem Length: 12mm (Excluding the Pin)
Fits into 8mm Hole
Toyota Camry and Lexus GS350,
GS430, GS460 & LS460 2007 - On

UNIT PACKAGE: 15



16784

(Nissan: 80999-05N07;
Toyota: 90467-07043)
Black Nylon

Push-Type Retainer
Head Diameter: 18mm
Stem Length: 11mm
(Excluding the Pin)
Fits into 7mm Hole

UNIT PACKAGE: 25



19416

(Toyota: 90467-09139)
Black Nylon

Bumper Cover & Wheel Housing
Push-Type Retainer
Head Diameter: 18mm
Stem Length: 12mm (Excluding the Pin)
Fits into 9mm Hole
Honda, Mazda 626 &
Toyota Corolla 1992 - On

UNIT PACKAGE: 15



21702

(Toyota: 90467-10170-C0)
Black Nylon

Cowl Vent, Upper Radiator Cover &
Wheel Apron Push-Type Retainer
Head Diameter: 18mm
Stem Length: 12mm
Fits into 10mm Hole
Lexus LS 460, LS 600, RX 350
& RX 450 and Toyota RAV4 2006 - On

UNIT PACKAGE: 10



21225
(53888-48010)
Black Nylon

Wheel Opening Push-Type Retainer
Head Diameter: 18mm
Stem Length: 14mm
Fits into 7mm Hole
Highlander 2001 - On

UNIT PACKAGE: 5



18873
(52161-16010, 52161-02020)
Black Nylon

Rear Bumper Cover
Push-Type Retainer
Head Diameter: 18mm
Stem Length: 28mm
Fits into 9mm Hole
Terrel 1988 - On

UNIT PACKAGE: 6



20931
(52161-20010)
Black Nylon

Bumper Cover & Grille
Push-Type Retainer
Head Diameter: 18mm
Stem Length: 31mm
Fits into 9mm Hole
Toyota 2000 - On

UNIT PACKAGE: 15



22126
(Toyota: 53384-68010)
Black Nylon

Front Grille Push-Type Retainer
Rubber Head Diameter: 19mm
Bottom Head Diameter: 18mm
Stem Length: 28mm
Fits into 9mm Hole
Scion tC & Toyota RAV4 2005 - On

UNIT PACKAGE: 15



19908
(90467-07121)
Black Nylon

Door Trim Panel Push-Type Retainer
Head Diameter: 20mm
Stem Length: 8mm (Excluding the Pin)
Fits into 7mm Hole
RAV4 1997 - On

UNIT PACKAGE: 10



19907
(90467-07121-B2)
Nylon

Door Trim Panel
Push-Type Retainer
Head Diameter: 20mm
Stem Length: 8mm (Excluding the Pin)
Fits into 7mm Hole
RAV4 1997 - On

UNIT PACKAGE: 10



20577
(GM: 88970494, 88973676)
Toyota: 90467-07168)
Black Nylon

Rocker Panel & Garnish Moulding
Push-Type Retainer
Head Diameter: 20mm
Stem Length: 8mm
Fits into 7mm Hole
Pontiac Vibe 2003 - On
Lexus & Toyota 2000 - On

UNIT PACKAGE: 15



18888
(90467-07166)
Black Nylon

Front Fender Liner
Push-Type Retainer
Head Diameter: 20mm
Stem Length: 8mm (Excluding the Pin)
Fits into 7mm Hole
Terrel 1994 - On

UNIT PACKAGE: 15



19128
(90467-07044)
Black Nylon

Quarter Panel Wheel Opening
Moulding Push-Type Retainer
Head Diameter: 20mm
Stem Length: 9mm
Fits into 7mm Hole
T-100 1992 - On

UNIT PACKAGE: 10



21294
(90467-07214)
Black Nylon

Radiator Splash Shield
Push-Type Retainer
Head Diameter: 20mm
Stem Length: 9mm
Fits into 7mm Hole
Camry 2007 - On

UNIT PACKAGE: 25



21010

(90467-09166)
Black Nylon

Push-Type Retainer
Head Diameter: 20mm
Stem Length: 9mm
Fits into 9mm Square Hole
Camry 2006 - On

UNIT PACKAGE: 15



20908

(Toyota: 90467-07164;
Suzuki: 09409-07332)
Black Nylon

Fender Splash Shield
Push-Type Retainer
Head Diameter: 20mm
Stem Length: 10mm
Fits into 7mm Hole
Camry, Echo, MR2 & Sienna 1997 - On
Suzuki 1999 - On

UNIT PACKAGE: 10



20955

(90467-07201)
Black Nylon

Engine Under Cover
Push-Type Retainer
Head Diameter: 20mm
Stem Length: 10mm
Fits into 7mm Hole
Lexus ES300/330 and Toyota Avalon,
Camry & Solara 2002 - On

UNIT PACKAGE: 10



21856

(Toyota: 51454-48010, 51454-0E010)
Black Nylon

Front Bumper Extension
Mounting Bracket Push-Type Retainer
Head Diameter: 20mm
Stem Length: 12mm
Fits into 10mm Hole
Lexus IS CV, F, RX330 & RX400 Hybrid 2006 - On
Toyota Highlander, Sienna & Venza 2009 - On

UNIT PACKAGE: 15



21596

(Toyota: 75867-06030)
Black Nylon

Rocker Panel Push-Type Retainer
Head Diameter: 20mm
Stem Length: 16mm
Fits into 8mm Hole
Toyota & Lexus 2007 - On

UNIT PACKAGE: 25



19140

(Acura: 90505-SL0-003;
GM: 94852368;
Mitsubishi: MB888869;
Toyota: 90467-08155)
Black Nylon

Push-Type Retainer
Head Diameter: 20mm
Stem Length: 21mm
Fits into 8mm Hole

Acura, Dodge Avenger, Eagle Talon,
Geo Prizm, Mitsubishi Eclipse & Galant
and Toyota 1993-On

UNIT PACKAGE: 5



19739

(90467-09127)
Black Nylon

Bumper Cover Push-Type Retainer
Head Diameter: 20mm
Stem Length: 26mm
Fits into 9mm Hole
Avalon, Camry,
Corolla & Solara 1998 - On

UNIT PACKAGE: 10



21860

(Toyota: 51453-48010, 51453-0E010)
Black Nylon

Front Side Lower
Fender Panel Bracket
Push-Type Retainer
Head Diameter: 22mm
Stem Length: 14mm
Fits into 13mm Hole
Lexus RX330 2009-2004
Toyota Highlander 2010 - On

UNIT PACKAGE: 15



21366

(90467-09227)
Black Nylon

Bumper & Engine Under Cover
Push-Type Retainer
Head Diameter: 22mm
Stem Length: 15mm
Fits into 9mm Hole
4 Runner, RAV4 & Scion XB 2006 - On

UNIT PACKAGE: 10



19219
(90467-09096)
Black Nylon

Front Bumper
Push-Type Retainer
Head Diameter: 15mm
Stem Length: 27mm
Fits into 9mm Hole
Lexus LS400 1993-On
Celica & Supra 1989-On

UNIT PACKAGE: 10



22072
(Toyota: 76923-47010)
Black Nylon

Rocker Moulding
Push-Type Retainer
Head Diameter: 38mm
Stem Length: 32mm
Fits into 22mm Hole
Lexus HS 250h & CT 200h
and Toyota Prius 2010 - On

UNIT PACKAGE: 5



14732
(53455-14020)
Nylon

Hood Prop Rod Clip
Holds 8mm Diameter Rod
Snaps into 14mm Hole

UNIT PACKAGE: 15



16780
(Nissan: 99604-H1400;
Toyota: 58788-13010)

Hood Prop Rod Clip
Holds 11mm Diameter Rod
Fits into 10mm x 12mm Hole

UNIT PACKAGE: 10



17631
(90959-01136)
Nylon

Hood Prop Rod Clip
Holds 6mm & 7mm Rods
Toyota

UNIT PACKAGE: 25



17611
(53452-90351)
Nylon

Hood Prop Rod Clip
Holds 6mm & 7mm Rods
Toyota

UNIT PACKAGE: 10



19529
(53455-33010, 53455-33011)
Natural Nylon

Hood Prop Rod Clip
Holds 9mm Rod
Fits into 10mm Square Hole
Camry 1996 - On

UNIT PACKAGE: 15



21336
(69293-30030)
Natural Nylon

Door Lock Rod Clip
Rod Size: 5mm
Overall Height: 20mm
Fits into 8mm Hole
Toyota & Lexus 1993 - On

UNIT PACKAGE: 10



20469
(69293-12030)
Natural Nylon

Door Lock Rod Clip
Rod Size: 5mm
Right (Passenger) Side
Lexus ES 300 2001 - 97
Toyota Camry, Celica, Corolla, Echo,
Highlander, MR2, RAV4, Tundra and
4-Runner 1994 - On

UNIT PACKAGE: 10



20470
(69293-12040)
Yellow Nylon

Door Lock Rod Clip
Rod Size: 5mm
Left (Driver) Side
Lexus ES 300 2001 - 97
Toyota Camry, Celica, Corolla, Echo,
Highlander, MR2, RAV4, Tundra and
4-Runner 1994 - On

UNIT PACKAGE: 10



20534

(69293-12050)
Natural Nylon

Door Lock Rod Clip
Rod Size: 5mm
Fits into 8.5mm Hole
Right (Passenger) Side
Lexus ES250, 300 & RX300
and Toyota Tacoma
1990 - On

UNIT PACKAGE: 10



20535

(69293-12060)
Yellow Nylon

Door Lock Rod Clip
Rod Size: 5mm
Fits into 8.5mm Hole
Left (Driver) Side
Lexus ES250, 300 & RX300
and Toyota Tacoma 1990 - On

UNIT PACKAGE: 10

14284

(Toyota: 90463-10337;
Honda: 90669-671-000; 90669-671-003)
Nylon



Photo not actual size
Cable Strap
Length: 110mm (5-5/16")
Max. Bundle Diameter: 23mm
Fits into 6mm Hole

UNIT PACKAGE: 15

21553

(82711-12200)
Black Nylon



Photo not actual size
Length: 170mm (6-3/4")
Cable Strap
Width: 7mm (7/32")
Max. Bundle Diameter: 40mm (1-9/16")
Camry, Celica, Corolla, Cressida,
Land Cruiser, MR-2, Paseo, Previa, RAV4, Supra,
T-100, Tercel & 4-Runner 1998 - On

UNIT PACKAGE: 25

20380

(Not Supplied by O.E.M.)
Black Nylon



Photo not actual size
Cable Strap
Width: 5mm (3/16")
Length: 200mm (8")
Max. Bundle Diameter: 44mm (1-3/4")
Fits into 6.3mm (1/4") Hole
Import Cars

UNIT PACKAGE: 25



16306

(90183-03001)

Front Bumper Cushion Clip
Toyota 1982 - On

UNIT PACKAGE: 25



16671

(90468-04030)

Bumper Strip Retainer
Toyota 1984 - On

UNIT PACKAGE: 25



21611

(76879-44010)
Dacromet

Front and Rear Spoiler
Locking Fastener
Width: 16mm
Corolla, Matrix, Prius & Solara 2003 - On

UNIT PACKAGE: 15



22097

(Toyota: 90950-01620)
Black Nylon

Hole Plug
Head Diameter: 30mm
Height: 5.6mm
Fits into 22mm Hole
Lexus ES, RX & SC; Scion iQ,
tC, xA, xB & xD and Toyota
Avalon, Camry, Celica, Corolla,
FJ Cruiser, Highlander, Matrix,
Prius, RAV4, Sequoia, Sienna,
Tacoma, Tundra & Yaris 1984 - On



UNIT PACKAGE: 15



21337

(65613-07010)
Black Nylon

Cowl Vent & Fender Apron
Nylon Flange Nut
Flange Diameter: 22mm
Stud Size: 6mm
Overall Height: 10mm
Venza 2009 - On

UNIT PACKAGE: 15



14750

(Toyota: 53879-14010-A,
53879-14020, 53879-22030;
GM: 94841226;
Mazda: LA01-56-135)
Black Nylon

Fender/Wheel Housing
Screw Size: #10
Width: 20mm
Length: 31mm
Panel Range: Up to 1mm
Center of Hole to Edge: 11mm
Toyota, Geo and Mazda

UNIT PACKAGE: 15

19669

Same as 14750 except for unit packing quantity

UNIT PACKAGE: 25



21359

(53879-17020)
Black Nylon

Bumper & Fender Apron U-Nut
Screw Size: M4.8 (#10)
Panel Range: Up to 2mm
Center of Hole to Edge: 10mm
Toyota Celica and Lexus 2000 - On

UNIT PACKAGE: 10



21616

(76647-42010)
Black Nylon

Fender & Mudguard U-Nut
Screw Size: M4.8 (#10)
Panel Range: Up to 2mm
Center of Hole to Edge: 7mm
RAV4 2001 - On

UNIT PACKAGE: 15



21613

(53879-20020)
Black Nylon

Front Fender Liner Nylon U-Nut
Screw Size: M5.5 (#12)
Panel Range: Up to 2mm
Center of Hole to Edge: 11mm
Camry & Sienna 1996 - On

UNIT PACKAGE: 15



20956

(90467-05114)
Black Nylon

Bumper & Fender
Apron Nylon U-Nut
Screw Size: M5.5 (#12)
Width: 20mm
Length: 36mm
Panel Range: Up to 1mm
Center of Hole to Edge: 14mm
Lexus & Toyota 2000 - On

UNIT PACKAGE: 10



21687

(Toyota: 90467-05138)
Black Nylon

Front Bumper & Fender
Liner Nylon U-Nut
Screw Size: M6.3 (#14)
Panel Range: Up to 3mm
Center of Hole to Edge: 14mm
Lexus GX 460, GX 470 & LX 570, Scion tC and Toyota
Corolla, FJ Cruiser, Land Cruiser, Matrix, Sequoia,
Tacoma, Tundra & 4 Runner 2003 - On

UNIT PACKAGE: 15



21614

(90467-05128)
White Nylon

Rear Bumper & Bumper Stay
Nylon U-Nut
Screw Size: M6 (#14)
Panel Range: Up to 2mm
Center of Hole to Edge: 12mm
RAV4 & Yaris 1996 - On

UNIT PACKAGE: 15



21615

(90467-A0018, 90467-05081)
Maroon Nylon

Left & Right Front Bumper
& Bumper Stay Nylon U-Nut
Screw Size: M6 (#14)
Panel Range: Up to 2mm
Center of Hole to Edge: 12mm
Toyota Avalon, Camry & Solara
and Lexus 2000 - On

UNIT PACKAGE: 15

TOYOTA, VOLKSWAGEN & AUDI CLIPS AND FASTENERS

Sec. 22

(Includes SEAT & Skoda)



14276

(53879-22010)
Black Nylon

Nylon U-Nut Fender/Wheel
Housing Applications
Screw Size: #14(1/4")
Width: 20mm
Length: 29mm
Panel Range: Up to 1mm
Center of Hole to Edge: 15mm

UNIT PACKAGE: 15



13225

Plated

U-Type Nut
Screw Size: 4.2mm (#8)
Width: 11mm
Length: 16.5mm
Panel Range: .5mm - 2.5mm
Center of Hole to Edge: 8mm

UNIT PACKAGE: 50

VOLKSWAGEN & AUDI CLIPS AND FASTENERS

(Includes SEAT & Skoda)

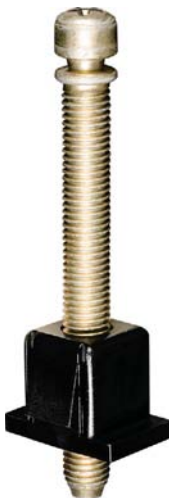

15666

(AMC: 36000148,
36001966, 56001419;
VW: 176-941-1117A)

1/4"-28 x 2-1/4"
Headlight Adjusting
Screw and Nut Assembly
AMC & VW

UNIT PACKAGE: 10



10322

(131-853-585C)
Nylon

Body Side Moulding Clip
VW

UNIT PACKAGE: 50



13189

(803-853-139A)
Nylon

Moulding Clip
Audi

UNIT PACKAGE: 50



12635

(801-853-577)
Nylon

Moulding Clip
VW

UNIT PACKAGE: 25



13174

(803-853-139C)
Red Nylon

Moulding Clip
VW

UNIT PACKAGE: 25

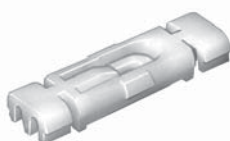

19136

(1HO-853-733B)
Nylon

Windshield Reveal
Moulding Clip
VW Golf & Jetta 1999 - 93

UNIT PACKAGE: 15



21416

(191-853-733-A)
White Nylon

Moulding Clip
Width: 8mm
Length: 31mm
Passat 1997 - 90

UNIT PACKAGE: 25



21760
(VW: 6Q0-868-246-A)
White Nylon

Moulding Clip
Width: 25mm
Length: 40mm
Thickness: 8mm

Audi 2004 - On
Eos, Golf, GTI, Passat, R32 & Rabbit 2005 - On

UNIT PACKAGE: 25



21493
(4A0-853-825-A)
White Nylon

Front & Rear Door Moulding Clip
Width: 22mm
Length: 35mm
Audi 1998 - 92

UNIT PACKAGE: 25



21390
(191-853-577-A)
White Nylon

Door Moulding Clip
Top Head Size: 11.6mm x 15mm
Bottom Head Diameter: 11mm
Stem Diameter: 6mm
Stem Length: 14mm
VW & Audi 1985 - On

UNIT PACKAGE: 25



21508
(191-853-577)
White Nylon

Door Trim & Scuff Plate
Moulding Clip
Head Size: 12mm x 15mm
Stem Diameter: 10mm
Stem Length: 19mm
Audi A1 & A2 and VW Golf & Jetta

UNIT PACKAGE: 25



21449
(3B0-853-575)
White Nylon
Blue Rubber Grommet

Moulding Clip
Width: 17.5mm
Length: 21mm
Stem Length: 12mm
Passat 2005 - 1998

UNIT PACKAGE: 25



21512
(7L0-839-069)
White Nylon

Rocker Panel Moulding Clip
Width: 10mm
Length: 28.5mm
Stem Length: 11mm
Fits into 10mm Hole
Touareg 2010 - 05

UNIT PACKAGE: 25



21761
(VW: 3C0-853-585,
3C9-827-407, 3C9-827-408)
White Nylon

Upper Door Cover Strip Scuff
Protection Moulding Clip
Top Head Size: 13mm x 16mm
Bottom Head Diameter: 14mm
Stem Length: 13mm
Fits into 9mm Hole
Passat, Tiguan & Touareg 2006 - On

UNIT PACKAGE: 25



21491
(443-853-909-A)
Natural Nylon

Front Door, Fender &
Quarter Panel Moulding Clip
Width: 20mm
Length: 41.5mm
Audi 1998 - 88

UNIT PACKAGE: 25



21481
(Audi: 4A0-853-825-C)
White Nylon

Rear Door Moulding Clip
Width: 26mm
Length: 34.5mm
Stem Length: 6mm

Audi 100, A6, S4, S6 & Quattro 1998 - 92

UNIT PACKAGE: 25



21448
(3A0-853-575-A)
White Nylon
Blue Rubber Grommet

Moulding Clip
Width: 16mm
Length: 17mm
Stem Length: 13mm
Passat 1997 - 95

UNIT PACKAGE: 25

(Includes SEAT & Skoda)



21447

(3B0-853-576)
White Nylon
Blue Rubber Grommet

Moulding Clip
Width: 24.5mm
Length: 27mm
Stem Length: 12mm
Passat 2005 - 1998

UNIT PACKAGE: 15



21394

(1H0-853-585)
White Nylon
Blue Rubber Grommet

Door Moulding Clip
Width: 34mm
Length: 38.5mm
Stem Length: 10mm

Audi & VW Cabrio, Golf & Jetta 2002 - 1993

UNIT PACKAGE: 15



21395

(1H0-853-585-B)
White Nylon
Blue Rubber Grommet

Door Moulding Clip
Width: 34mm
Length: 38.5mm
Stem Length: 18mm
Audi & VW Cabrio 2002 - 1999

UNIT PACKAGE: 15



21492

(4A0-853-825)
White Nylon

Front & Rear Door, Fender &
Quarter Panel Moulding Clip
Width: 22mm
Length: 35mm
Overall Height: 16mm
Audi 1998 - 92

UNIT PACKAGE: 25



21396

(1H0-853-858-A)
White Nylon
Blue Rubber Grommet

Quarter Panel Moulding Clip
Width: 23mm
Length: 40mm
Stem Length: 11mm

Audi & VW Cabrio, Golf & Jetta 2002 - 1993

UNIT PACKAGE: 15



21478

(3A0-853-575)
White & Orange Nylon
Blue Rubber Boot

Door, Fender &
Quarter Panel Moulding Clip
Width: 35mm
Length: 38mm
Stem Length: 14mm
Volkswagen 1997 - 90

UNIT PACKAGE: 15



22108

(VW: 4A0-867-276A)
Zinc

Trim Moulding Clip
Overall Height: 16mm
Audi & Volkswagen 2012 - 1998

UNIT PACKAGE: 25



13173

(VW: N14389.3; Volvo: 3104-426)
Metal

Door Panel Clip
Use with Auveco 13206

UNIT PACKAGE: 50



21994

(VW: 3A0-867-301-01C)
Black Nylon

Door Panel Clip
Width: 20mm
Length: 28mm
Stem Diameter: 7.5mm
Stem Length: 6mm
VW, Audi, SEAT & Skoda

UNIT PACKAGE: 15



21993

(VW: 321-867-299B)
Natural Nylon

Door Panel Clip
Width: 20mm
Length: 18.5mm
Stem Diameter: 7.5mm
Stem Length: 6mm
VW, Audi, SEAT & Skoda

UNIT PACKAGE: 10



8843

Nylon

Moulding Fastener
Fits 1/2" -5/8" Mouldings

UNIT PACKAGE: 50



21498
(191-941-142)
White Nylon

Headlight Adjusting Nut
Head Size: 14mm x 18.5mm
Overall Length: 15mm
Fits into 10mm Hole
Audi 100 and VW Golf 1994 - 86

UNIT PACKAGE: 25



21985
(VW: N905-353-01)
Gray Nylon

Nylon Nut
Screw Size: M4.2 (#8)
Head Size: 10mm x 10mm
Stem Length: 9.5mm
VW, Audi, SEAT & Skoda

UNIT PACKAGE: 25



14014
(VW: 175-853-674; GM: 20475950)
Black Nylon

Air Vent Nut

UNIT PACKAGE: 50



12735
(GM: 1370853; Chry: 6029501;
VW: 179-813-883)
Nylon

Headlight Bezel Nut
Screw Size: #6
GM & VW 1982 - On

UNIT PACKAGE: 50



14030
(GM: 3997391; VW: 179-813-881)
Black Nylon

Tail Light Nut
Screw Size: #8
GM Astro & Safari 1985-On
Volkswagen

UNIT PACKAGE: 25



21510
(867-809-966, 811-807-557-C)
Black Nylon

Screw Grommet
Screw Size: M4.8 (#10)
Head Diameter: 12mm
Stem Length: 12.5mm
VW & Audi

UNIT PACKAGE: 25



21480
(VW: 165-827-592)
Natural Nylon

Screw Grommet
Screw Size: M4.2 (#8)
Head Diameter: 11mm
Stem Length: 13mm
VW Cabrio, EuroVan, Golf &
Jetta 2003 - 1992

UNIT PACKAGE: 25



21986
(VW: 4A0-857-610)
Black Nylon

Screw Grommet
Screw Size: M5.5 (#12)
Head Diameter: 17mm
Stem Length: 17mm
VW, Audi, SEAT & Skoda

UNIT PACKAGE: 15



20924
(N908-338-01)
Black Nylon

Fender Apron Screw Grommet
Screw Size: M4.2 (#8)
Head Diameter: 15mm
Stem Length: 12mm
Cabrio, Golf, Jetta &
Phaeton 1999 - On

UNIT PACKAGE: 15



20925
(N908-214-01)
Black Nylon

Bumper & Fender Apron
Screw Grommet
Screw Size: M4.2 (#8)
Head Diameter: 15mm
Stem Length: 20mm
Audi A4/S4 and A6/S6 1996 - On
VW Cabrio, Golf, Jetta & Phaeton 1999 - On

UNIT PACKAGE: 15



21399
(811-807-577-C)
Black Nylon

Screw Grommet
Screw Size: M4.8 (#10)
Head Diameter: 7mm x 12.5mm
Stem Length: 11mm
Audi Quattro, A4, A6, A8, RS6, S4, S6, TT & 90 and
Volkswagen Golf, Jetta & Passat 2010 - 1990

UNIT PACKAGE: 25



21816

(VW: 6N0-809-966A)
Black Nylon

Screw Grommet
Screw Size: M4.8 (#10)
Head Diameter: 12mm
Stem Length: 15mm
Fits into 6.5mm x 8mm Hole
VW, Audi, SEAT & Skoda

UNIT PACKAGE: 25



20933

(357-827-998)
Black Nylon

Front & Rear Door Panel
Screw Grommet
Screw Size: M4.8 (#10)
Head Diameter: 16mm
Stem Length: 20mm
Cabrio, Golf, Jetta & Passat 1993 - On

UNIT PACKAGE: 15



21890

(VW: 357-868-143)
Gray Nylon

Screw Grommet
Screw Size: M5.5 (#12)
Head Diameter: 16mm
Stem Length: 23mm
VW, Audi, SEAT & Skoda

UNIT PACKAGE: 25



21987

(VW: N105-168-01; BMW: 51127020321)
White Nylon

Screw Grommet with Black Rubber Sealer
Screw Size: M5.5 (#12)
Head Diameter: 13mm
Stem Length: 16mm
VW, Audi, SEAT, Skoda & BMW

UNIT PACKAGE: 15



21988

(VW: N-106-213-01; Ford: 1725489)
White Nylon

Screw Grommet with Black Rubber Sealer
Screw Size: M4.8 (#10)
Head Diameter: 16mm
Stem Length: 16mm
VW, Audi, SEAT, Skoda & Ford

UNIT PACKAGE: 10



21815

(VW: 4A0-805-163, 8A0-863-821Q)
Black Nylon

Upper & Lower Engine Cover
Locking Pin Grommet
Overall Width: 20mm
Overall Height: 16mm
VW, Audi, SEAT & Skoda 1998 - On

UNIT PACKAGE: 25



22094

(VW: 4L0-886-373)
White & Black Nylon

Front & Rear Seat Bottom
and Bench Grommet
Top Head Size:
27.6mm x 40mm
Bottom Head Size:
25mm x 37mm
Stem Length: 30mm
Overall Length: 40mm
Audi & Volkswagen 2013 - 2007

UNIT PACKAGE: 10



13227

(113-853-615A)
Nylon

Barrel Nut
For 3mm Stud
Fits into 4mm Hole

UNIT PACKAGE: 50



20250

(357-853-586-D)
Black Nylon

Moulding Insert
Head Diameter: 13mm
Stem Length: 6mm
Fits into 9mm Hole
EuroVan, Golf, Jetta &
Passat 1989 - On

UNIT PACKAGE: 25



13206

(113-857-219A)
Black Vinyl

Door Panel & Trunk Liner Plug
Use with Auveco 13173
VW Beetle & Audi

UNIT PACKAGE: 50

(Includes SEAT & Skoda)



21397
(1H0-853-586)
Blue Rubber

Moulding Clip Grommet
Inner Diameter: 7mm
Flange Outer Diameter: 13mm
Overall Length: 12mm
Use with Auveco Moulding Clips:
21394, 21395 & 21396
Audi and VW Cabrio, Golf,
Jetta, Passat & Touareg 2007 - 1990

UNIT PACKAGE: 50



21843
(Mercedes-Benz: A901-988-00-25;
VW: 2D1867741)
Black Nylon

Rear Entry Scuff Plate Retaining Pin
Head Size: 15mm x 15mm
Overall Length: 31mm
VW LT Van 2007 - 1987
Mercedes-Benz Sprinter 1995 - On

UNIT PACKAGE: 25



22216
(VW: 6N0-867-276)
White Nylon

Windshield Pillar Trim Clip
Top Head Size: 10mm x 15mm
Bottom Head Size: 17mm x 25mm
Overall Height: 20mm
Volkswagen Beetle, Golf, GTI &
Jetta 2010 - 2003

UNIT PACKAGE: 15



22235
(Audi: 4F0-825-429A)
Black Nylon

Splash Shield Retaining Clip
Size: 22mm x 23mm
Audi A4, A6, A7, S4, S5, S6,
S7, Q5 & RS5 2008 - On

UNIT PACKAGE: 25



22308
(Audi: 8K0-821-213A)
Natural Nylon

Bumper & Side Air Baffle Retaining Clip
Head Size: 15.3mm x 18.3mm
Overall Height: 20mm
Audi A4, A5, A6, Q3, Q5, RS7,
S4, S5, S6, S7 & SQ5 2015 - On

UNIT PACKAGE: 15



21981
(VW: 1H0-823-717)
Black Nylon

Weatherstrip Retainer
Head Size: 5.5mm x 17mm
Stem Diameter: 5mm
Stem Length: 7mm
VW, Audi, SEAT & Skoda

UNIT PACKAGE: 25



21982
(VW: 251-823-717)
Black Nylon

Weatherstrip Retainer
Head Size: 5mm x 13mm
Stem Diameter: 5mm
Stem Length: 9mm
VW, Audi, SEAT & Skoda

UNIT PACKAGE: 25



21980
(VW: 1Z0-837-732A)
Yellow Nylon

Weatherstrip Retainer
Head Size: 5mm x 13mm
Stem Diameter: 5.7mm
Stem Length: 5mm
VW, Audi, SEAT & Skoda

UNIT PACKAGE: 25



21497
(1H0-837-719)
Black Nylon

Weatherstrip Retainer
with Clear Grommet
Head Size: 6mm x 15mm
Stem Diameter: 7.5mm
Stem Length: 17mm
Audi A3 and VW Golf, Sharan,
Transporter & Corsa

UNIT PACKAGE: 25

(Includes SEAT & Skoda)



21758

(VW: 801-867-299-01C)
Black Nylon

Door Side Panel, Luggage Compartment
and Armrest Tray Trim Retaining Clip

Head Diameter: 14mm
Stem Diameter: 7mm x 9mm
Stem Length: 18mm

Golf, GTI, Jetta & Rabbit 2005 - 1999

UNIT PACKAGE: 25



21984

(VW: 6Y0-823-717)
Black Nylon

Trim Panel Retainer
Head Diameter: 10mm
Stem Diameter: 6mm
Stem Length: 9mm
VW, Audi, SEAT & Skoda

UNIT PACKAGE: 15



21789

(VW: 1H0-867-199-01C)
Black Nylon

Radiator Grille, Scuff Plate,
Sill & Trim Panel Retainer
Head Diameter: 23mm
Stem Diameter: 11mm
Stem Length: 16mm
Volkswagen & Audi 1997 - On

UNIT PACKAGE: 25



21392

(1H0-819-055-B01C)
Black Nylon

Instrument Panel, Cowl Vent,
Defroster Grille & Ducts Retainer
Head Diameter: 23mm
Stem Diameter: 6.5mm
Stem Length: 16mm
Phillips Drive

Audi and Volkswagen Cabrio, Golf & Jetta 2002 - 1993

UNIT PACKAGE: 25



22338

(VW: 3C0-863-559)
Black Nylon

Wheel House Cover Mount &
Interior Trim Retainer
Head Diameter: 26mm
Stem Diameter: 7.6mm
Stem Length: 28mm
Volkswagen Passat &
CC 2012 - 2006

UNIT PACKAGE: 25



21842

(VW: N90565301, N90642001)
Black Nylon

Engine Compartment Cover
Locking Duo Drive Pin Retainer
Head Diameter: 15.7mm
Shoulder Diameter: 8.8mm
Shoulder Length: 6.5mm
Overall Length: 27mm
Audi A4, A6 & A8, SEAT,
Skoda and VW Passat

UNIT PACKAGE: 25



21885

(VW: 4A0-805-121C)
Black Nylon

Cowl Retaining Pin with Slotted Head
Head Diameter: 25mm
Stem Length: 23mm
VW, Audi, SEAT & Skoda

UNIT PACKAGE: 25



21515

(4A0-805-121-A)
Black Nylon

Front Fender, Bumper &
Engine Cover Retainer
Slotted Drive
Head Diameter: 25mm
Stem Length: 22mm
Passat & Audi 1992 - On

UNIT PACKAGE: 25



22208

(VW: 4A0-805-121C)
Black Nylon

Splash Shield Slotted Retainer
Head Diameter: 25mm
Stem Length: 24mm
Use with Auveco 21815
Audi A4, A6, A8, RS 4, S4, S6 & S8
and Volkswagen 2011 - 02

UNIT PACKAGE: 15



21509

(357-853-575)
White Nylon

Retainer with Gray Grommet
Top Head Diameter: 12mm
Bottom Head Diameter: 18mm
Stem Diameter: 10mm
Stem Length: 16mm
Golf, Jetta, Passat & Scirocco

UNIT PACKAGE: 25



21496
(357-853-585-A)
White Nylon

Trim Panel Retainer with
Black Nylon Grommet
Top Head Diameter: 12mm
Bottom Head Diameter: 18mm
Stem Diameter: 10mm
Stem Length: 12mm
Golf & Passat and Audi B3

UNIT PACKAGE: 15



21495
(7L5-853-994)
Blue Nylon

Trim Panel Retainer
Top Head Diameter: 13mm
Bottom Head Diameter: 18mm
Stem Diameter: 9mm
Stem Length: 14mm
VW, Audi & Renault

UNIT PACKAGE: 25



21783
(VW: 6Q0-868-297)
Black Nylon

Trim Panel Retainer
Top Head Diameter: 16mm
Bottom Head Diameter: 16mm
Stem Diameter: 10mm
Stem Length: 9mm
Golf, GTI, R32 & Rabbit 2006 - On

UNIT PACKAGE: 15



21893
(VW: 5J0-867-276)
White Nylon

Trim Panel Retainer with Sealer
Top Head Diameter: 13mm
Bottom Head Diameter: 17mm
Stem Diameter: 12mm
Stem Length: 13mm
VW, Audi, SEAT & Skoda

UNIT PACKAGE: 15



21853
(VW: 7M0-867-299-K, 7M3-867-299;
Land Rover: DYC500020;
Ford: 1008068)
Yellow Nylon

Door Trim Panel Retainer with Sealer
Top Head Diameter: 13mm
Bottom Head Diameter: 17.5mm
Stem Diameter: 10.5mm
Stem Length: 15mm
Land Rover 1997 - On
VW & Audi 1999 - On

UNIT PACKAGE: 25



21516
(357-853-585)
White Nylon

Retainer with Black Nylon Grommet
Top Head Diameter: 12mm
Bottom Head Diameter: 18mm
Stem Diameter: 10mm
Stem Length: 20mm
VW Golf A2 & A3 and Audi

UNIT PACKAGE: 25



21819
Yellow Nylon

Retainer
Top Head Diameter: 13mm
Bottom Head Diameter: 17.5mm
Stem Diameter: 10mm
Stem Length: 16mm
VW, Audi, SEAT, Skoda & Ford

UNIT PACKAGE: 25



13475
(Renault: 8934-201-681;
VW: 175-867-299)
White Nylon

Trim Panel Retainer
Head Diameter: 19mm
Stem Length: 18mm
Stem Diameter: 9mm
AMC-Renault 1984-On
VW 1982-On

UNIT PACKAGE: 50



21450
(703-867-299)
Black Nylon

Side Panel & Interior Trim Retainer
Top Head Diameter: 13.5mm
Bottom Head Diameter: 18mm
Stem Diameter: 9mm
Stem Length: 14mm
VW 2003 - 1993

UNIT PACKAGE: 25



21991
(VW: 6L6-853-575A)
Black Nylon

Retaining Clip
Top Head Diameter: 14mm
Bottom Head Diameter: 14mm
Stem Diameter: 10mm
Stem Length: 10mm
VW, Audi, SEAT & Skoda

UNIT PACKAGE: 10

(Includes SEAT & Skoda)



13179

(481-867-197)
Black Nylon

Trim Panel Retainer
VW

UNIT PACKAGE: 50



21494

(171-807-249-A)
Natural Nylon

Trim Panel Retainer
Top Head Diameter: 12mm
Bottom Head Diameter: 18mm
Stem Diameter: 9.5mm
Stem Length: 12mm
VW Golf & Audi 1978 - On

UNIT PACKAGE: 25



20252

(823-867-299)
Black Nylon

Trim Panel Retainer
Top Head Diameter: 14mm
Bottom Head Diameter: 18mm
Stem Diameter: 9mm
Stem Length: 14mm
Corrado, EuroVan, Jetta,
Rabbit & Vanagon 1979 - On

UNIT PACKAGE: 25



21992

(VW: 6E0-837-732)
White Nylon

Trim Panel Retaining Clip
Top Head Size: 6.5mm x 11mm
Bottom Head Diameter: 13.5mm
Stem Diameter: 5.8mm
Stem Length: 8mm
VW, Audi, SEAT & Skoda

UNIT PACKAGE: 15



21996

(VW: 8P0-868-243)
Yellow & White Nylon

Trim Panel Retainer with Sealer
Top Head Diameter: 19mm
Bottom Head Diameter: 17mm
Stem Diameter: 12mm
Stem Length: 10mm
VW, Audi, SEAT & Skoda

UNIT PACKAGE: 10



21995

(VW: 8Z0-867-646)
White Nylon

Trim Panel Retainer with Sealer
Top Head Diameter: 19mm
Bottom Head Diameter: 17mm
Stem Diameter: 12mm
Stem Length: 10mm
VW, Audi, SEAT & Skoda

UNIT PACKAGE: 10



22231

(VW: 1K6-837-200B)
Black Nylon

Door Panel Retainer
Top Head Diameter: 10mm
Middle Head Diameter: 12mm
Bottom Head Diameter: 12mm
Stem Diameter: 8mm
Stem Length: 9mm
VW Golf V, GTI, Jetta & R32 2010 - 1999

UNIT PACKAGE: 25



20341

(3B0-868-243)
Black Nylon

Door Trim Panel Retainer
Head Diameter: 22mm
Stem Length: 10mm
Fits into 10mm Hole
Beetle, Golf, Jetta & Passat 1998 - On

UNIT PACKAGE: 25



21398

(6K0-868-243-C)
Black Nylon

Trim Panel Retainer
Top Head Diameter: 22mm
Bottom Head Diameter: 18mm
Stem Length: 12mm
Fits into 8mm Hole
Audi and Volkswagen Touareg 2010 - 2004

UNIT PACKAGE: 25



21144

(8E0-868-243)
Black Nylon

Interior Trim Panel
Retainer with Sealer
Top Head Diameter: 21.5mm
Bottom Head Diameter: 27mm
Stem Diameter: 11mm
Stem Length: 19mm
Audi A4 & S4, Avant, Cabriolet,
Quattro & Sedan Wagon, 2005 - On

UNIT PACKAGE: 25



21894

(VW: 5X0-867-299)
Black Nylon

Trim Panel Retainer
Top Head Diameter: 22mm
Bottom Head Diameter: 22mm
Stem Diameter: 9.3mm
Stem Length: 14mm
VW, Audi, SEAT & Skoda

UNIT PACKAGE: 15



21708

(VW: 7L6-868-243)
Black Nylon

Door Trim Panel Retainer with Sealer
Head Diameter: 22.5mm
Stem Diameter: 9mm
Stem Length: 12mm
Audi A5, A6, A7, S5, S6 & S7 and
VW Beetle, Cabrio, Golf, Gti, Jetta, Passat & Touareg 2004 - On

UNIT PACKAGE: 15



21393

(1H0-868-243)
Blue & Black Nylon

Trim Retainer
Top Head Diameter: 28mm
Bottom Head Diameter: 19mm
Overall Length: 31mm
Audi and Volkswagen Cabrio, Golf & Jetta 1999 - 1993

UNIT PACKAGE: 25



21415

(1H0-868-243-B)
Tan and White Nylon

Adjustable
Door Trim Panel Retainer
Head Diameter: 28.5mm
Stem Diameter: 9.5mm
Stem Length: 11mm
Overall Length: 31mm
Golf 2002 - 1993

UNIT PACKAGE: 25



21997

(VW: 6N0-868-243A)
Black & White Nylon

Trim Panel Retainer
Top Head Diameter: 28mm
Bottom Head Diameter: 19mm
Stem Diameter: 10mm
Stem Length: 12mm
VW, Audi, SEAT & Skoda

UNIT PACKAGE: 10



22204

(Audi: 4D0-867-299D)
Black Nylon

Door Trim Panel Retainer
Top Head Size: 14mm x 14mm
Bottom Head Diameter: 12mm
Stem Length: 9mm
Fits into 9mm Hole
Audi A8, A8 Quattro & S8 2003 - 1997

UNIT PACKAGE: 15



21891

(VW: N905-333-01)
Black Nylon

Hood Insulation Retainer
Head Diameter: 20mm
Stem Diameter: 11mm
Stem Length: 7mm
VW, Audi, SEAT & Skoda

UNIT PACKAGE: 15



21145

(1H5-863-849-A-01C)
Black Nylon

Hood Insulation Retainer
Head Size: 20mm x 25mm
Stem Length: 13mm
Fits into 12mm Hole
Audi A4, A6, Cabriolet, Quattro, S4 & S6 and Volkswagen Beetle, Golf, Jetta, Passat, Rabbit & Touareg 1998 - On

UNIT PACKAGE: 15



21892

(VW: 867-863-849-A01C)
Black Nylon

Hood Insulation Retainer
Head Size: 23mm x 29mm
Stem Length: 12mm
VW, Audi, SEAT & Skoda

UNIT PACKAGE: 25



20187

(Mercedes: 000-990-34-92;
BMW: 51-16-1-881-149;
VW: N-102-593-01)
Black Nylon

Radiator Housing Push-Type Retainer
Head Diameter: 10mm
Stem Length: 10mm
Fits into 6mm Hole
Body Styles 116, 123, 124, 126, 129, 140, 170, 201, 208 & 210 1974 - On
BMW & VW

UNIT PACKAGE: 15

(Includes SEAT & Skoda)



22238

(VW: N-905-369-01)
Black Nylon

Bumper, Hood, Interior Trim &
Quarter Panel Push-Type Retainer
Head Diameter: 10mm
Stem Length: 11mm
Fits into 5mm Hole
Audi 90, A4 & S4 and VW Beetle,
Golf & Jetta 1993 - On

UNIT PACKAGE: 25



21451

(333-867-633-4FB)
Black Nylon

Front Lights & Windshield Washer
Push-Type Retainer
Head Diameter: 14mm
Stem Length: 10mm
Fits into 8.5mm Hole
VW 1998 - 95

UNIT PACKAGE: 25



21989

(VW: 191-867-775A)
Black Nylon

Tailgate Push-Type Retainer
Top Head Diameter: 11mm
Bottom Head Diameter: 12mm
Stem Length: 7mm
Fits into 7mm Hole
Overall Length: 27mm
VW, Audi, SEAT & Skoda

UNIT PACKAGE: 10



22280

(VW: 3C0-853-934)
Black Nylon

Splash Shield & Rocker
Moulding Push-Type Retainer
Head Diameter: 15mm
Hex: 8mm (with 4mm Allen Drive)
Stem Length: 10mm
Fits into 8mm Hole
Volkswagen CC 2009 - On
Passat 2010 - 2006

UNIT PACKAGE: 25



21391

(N038-550-1)
Dark Gray Nylon

Bumper, Exterior Trim, Fender,
Quarter Panel & Wheel Opening
Push-Type Retainer
Head Diameter: 12mm
Stem Length: 11mm
Fits into 8mm Hole
Audi and Volkswagen EuroVan, Golf,
Jetta & Passat 2003 - 1985

UNIT PACKAGE: 25



21479

(701-867-299)
Gray Nylon

Front Bumper & Interior Trim
Push-Type Retainer
Allen Head Drive: 3mm
Head Diameter: 18.5mm
Stem Length: 11mm
Fits into 9mm Hole
VW Jetta & Passat 1999 - On

UNIT PACKAGE: 25



21990

(VW: 6L0-121-136A)
Black Nylon

Push-Type Retainer
Head Diameter: 15mm
Stem Length: 8mm
Fits into 7mm Hole
VW, Audi, SEAT & Skoda

UNIT PACKAGE: 15



22101

(Audi: 4D0-807-300)
Black Nylon

Bumper, Fender & Hood
Insulation Push-Type Retainer
Head Diameter: 22mm
Stem Length: 12mm
Fits into 7.5mm Hole
Audi A4, A5, A8, Q3, Q5 & S8 1997 - On

UNIT PACKAGE: 15



19195

(161-867-299-01C)
Black Nylon

Push-Type Retainer
Head Diameter: 16mm
Stem Length: 12mm
Fits into 8mm Hole
VW Golf & Jetta 1997 - 93

UNIT PACKAGE: 25



22095

(Audi: N90-229-301)
Black Nylon

Hood Insulation Push-Type Retainer
Head Diameter: 22mm
Stem Length: 13mm
Fits into 8mm Hole
Audi & Volkswagen 1986 - On

UNIT PACKAGE: 25



21251

(6Q0-868-243)
Black & White Nylon

Trim Panel Push-Type Retainer with Sealer
Head Diameter: 22.5mm
Stem Length: 7mm (Excluding the Pin)
Fits into 8mm Hole
Golf, Jetta, Passat, Phaeton, Rabbit & Tiguan 2004 - On

UNIT PACKAGE: 15



21452

(1H0-819-055-C01C)
Black Nylon

Push-Type Retainer
Top Head Diameter: 23mm
Bottom Head Diameter: 16mm
Stem Length: 15mm
Fits into 8mm x 8mm Square Hole
VW 2002 - 1993

UNIT PACKAGE: 25



21482

(1H0-867-199-A)
Black Nylon

Push-Type Retainer
Head Diameter: 24mm
Stem Length: 13mm
Fits into 9mm Square Hole
Passat 1999 - 90

UNIT PACKAGE: 25



21887

(VW: 8K0-805-121)
Black Steel

Phillips Drive Cowl Fastener
Head Diameter: 16mm
Stem Diameter: 5mm
Stem Length: 19mm
VW, Audi, SEAT & Skoda

UNIT PACKAGE: 10



21889

(VW: 8D0-805-121)
Zinc

Slotted Drive Cowl Fastener
Head Diameter: 18mm
Stem Diameter: 7mm
Stem Length: 18mm
VW, Audi, SEAT & Skoda

UNIT PACKAGE: 10



21888

(VW: 8D0-805-121B)
Black Steel

Slotted Drive Cowl Fastener
Head Diameter: 18mm
Stem Diameter: 7mm
Stem Length: 20mm
VW, Audi, SEAT & Skoda

UNIT PACKAGE: 10



21886

(VW: 8E0-805-121A)
Black Steel

Slotted Drive Cowl Fastener with Gasket
Head Diameter: 18.5mm
Stem Diameter: 7mm
Stem Length: 12mm
VW, Audi, SEAT & Skoda

UNIT PACKAGE: 15



21483

(1H0-823-397)
Natural Nylon

Hood Prop Rod Clip
Rod Size: 8mm
Stem Length: 10mm
Fits into 7mm Square Hole
VW 1999 - 93

UNIT PACKAGE: 25



21514

(6N0-823-397-AC)
Black Nylon

Hood Prop Rod Clip
Rod Size: 8mm
Head Diameter: 15mm
Fits into 7mm Square Hole
VW & Audi

UNIT PACKAGE: 25

21305

(Not Available from O.E.M.)
Natural Nylon

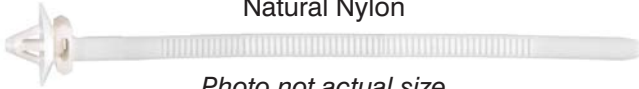

Photo not actual size
Push-Mount Cable Strap
Overall Length: 156mm (6-1/8")
Strap Width: 5mm (3/16")
Snaps into 6.3mm (1/4") Hole
Maximum Bundle Diameter: 40mm (1-9/16")
European Makes & Universal

UNIT PACKAGE: 25

21513

(N90-335-006)
Dacromet



Splash Shield & Wheel Well
Push-On Retainer
Stud Size: 5mm
Outer Diameter: 30mm
VW & Audi

UNIT PACKAGE: 25

21485

(N90-796-501, N90-796-502)
Dacromet



Radiator Support & Splash Shield
Push-On Retainer
Stud Size: 5mm
Outer Diameter: 30mm
VW 2006 - 1999

UNIT PACKAGE: 25

22098

(VW: 4F0-805-163)
Zinc



Sub Frame Clip
Width: 13mm
Length: 27mm
Audi A6 & S6 and
Volkswagen 2005 - On

UNIT PACKAGE: 10

22116

(VW: 1J6-867-276)
Zinc Finish



Door Trim Clip
Overall Height: 22.5mm
Width at Bottom Base: 13.5mm
Audi & VW 2004 - On

UNIT PACKAGE: 25



21818

(VW: 4A0-867-276)
Black Spring Steel

Moulding Fastener
Overall Height: 22mm
VW, Audi, SEAT & Skoda

UNIT PACKAGE: 25



13216

Zinc

U-Nut
Screw Size: 4.8mm
Panel Range: .9mm -2mm
Center of Hole to Edge: 8mm

UNIT PACKAGE: 25

22260

(Audi: 8K0-805-922A)
Zinc



Lower Skid Plate Cover &
Radiator Support U-Type Nut
Panel Range: 2.2mm - 5.5mm
Center of Hole to Edge: 13mm
Width: 19.3mm
Length: 23.5mm
Audi A4, A5, A6, A7, A8, Q5, S4,
S5, S6 & S8 2012 - 2008

UNIT PACKAGE: 15

22113

(BMW: 51127070202;
VW: N90168602)
Zinc Finish



Metric Extruded U-Nut
Screw Size: M5-.8
Panel Range: .45mm - 1.5mm
Center of Hole to Edge: 11.5mm
BMW 1999 - 1992
VW 1993 - On

UNIT PACKAGE: 25

22291

(VW: N-910-189-01)
Black Nylon



Front Bumper Support Retainer Nut
Thread Size: M6.3-1.81
Hex Size: 10mm
Flange Diameter: 16.3mm
Overall Height: 11.3mm
Beetle, CC, Eos, GTI, Golf,
Jetta & Rabbit 2003 - On

UNIT PACKAGE: 25

**21456**
(171-201-969)
Black NylonMoulding Nylon Flange Nut
Stud Size: 5mm
Hex: 10mm
Flange Diameter: 18.5mm
Overall Height: 10.5mm
Audi A8, S8 & 90 2003 - 1993

UNIT PACKAGE: 25

**12595**
(GM: 11503752, 11505329;
VW: N90100001)
PhosphateFree Spinning Washer Nut
Screw Size: M6-1.0
Washer Outer Diameter: 16mm
Hex: 10mm

UNIT PACKAGE: 25

16268

Same as 12595 except for unit package quantity

UNIT PACKAGE: 50

**21817**
(VW: N908-131-01)
Natural NylonNylon Rivet
Diameter: 6mm
Grip: 2.0mm - 8.5mm
Flange Diameter: 13mm
VW, Audi, SEAT & Skoda

UNIT PACKAGE: 25

**11404**
(N14-4003)
Plain SteelManifold Stud
M8-1.25 x 35mm

UNIT PACKAGE: 25

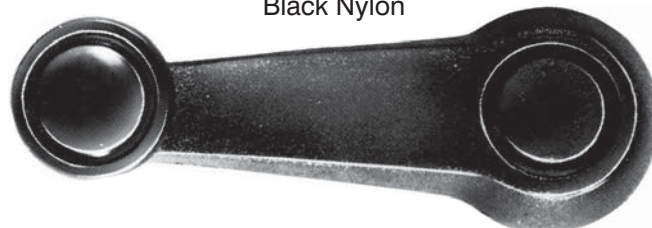
**13031**
(111-837-581J)
Black Nylon*Photo not actual size*Window Crank Handle
VW Beetle

UNIT PACKAGE: 1

**14194**
(321-837-581-016)*Photo not actual size*Window Crank Handle
VW, Scirocco & Dasher 1974 - On

UNIT PACKAGE: 1

HOT
NEW ITEMS**Auveco releases new items every other week.
Our Hot New Items bulletins can keep you up
to date on all new product.****To receive these bulletins please
contact customer service:
mail@auveco.com or 1-800-354-9816****We also have all previous and current bulletins
posted on www.auveco.com.**



12637
(591-740)
Nylon

Body Side
Moulding Clip

UNIT PACKAGE: 50



21784
(Volvo: 30784514)
White Nylon

Moulding Clip
Top Head Size: 15mm x 17mm
Bottom Head Size: 9mm x 16mm
Stem Length: 11mm
Fits into 8mm Hole
S80, V70, XC70 & XC90 2007 - On

UNIT PACKAGE: 25



20405
(9151649-2)
White Nylon

Rocker Panel Moulding Clip
Stem Length: 14mm
Fits into 8mm Hole
850, C70, S70 & V70 1993 - On

UNIT PACKAGE: 10



22138
(Volvo: 30753487)
Metal &
White Nylon

Pillar & Exterior Trim Glass Weatherstrip Clip
Overall Length: 49mm
Volvo XC60 2008 - On

UNIT PACKAGE: 10



22137
(Volvo: 30753556)
Metal & White Nylon

Pillar & Exterior Trim Glass Weatherstrip Clip
Overall Length: 60mm
Volvo V70 & XC70 2008 - On

UNIT PACKAGE: 10

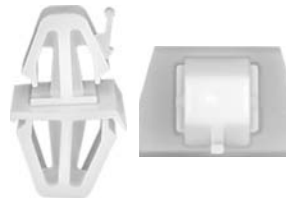

22340
(Volvo: 30808521)
White Nylon

Rocker Panel Moulding Clip
Overall Height: 24mm
Volvo S40 2004 - 2000

UNIT PACKAGE: 15



13173
(VW: N14389.3;
Volvo: 3104-426)

Metal
Panel Clip

UNIT PACKAGE: 50

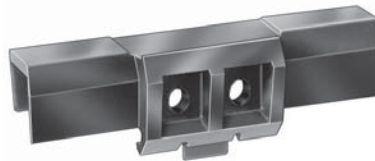

14211
(1-255-551)
Black Nylon

Windshield Clip

UNIT PACKAGE: 25



14212
(1-246-926)
Gray Nylon

Windshield Clip

UNIT PACKAGE: 25



14210
(1-255-553)
White Nylon

Windshield Clip

UNIT PACKAGE: 15



14209
(1-246-993)
Green Nylon

Windshield Clip

UNIT PACKAGE: 15



13191
(680-097)
Black Nylon

Moulding Retainer

UNIT PACKAGE: 50

**VOLVO AND UNIVERSAL EUROPEAN
IMPORT CLIPS & FASTENERS**



21786

(Volvo: 30653441)
Black & White Nylon

Door Trim, Luggage Compartment
& Armrest Tray Trim Retainer
Top Head Diameter: 13mm
Middle Head Diameter: 13mm
Bottom Head Diameter: 17mm
Stem Diameter: 8mm
Stem Length: 9mm
Overall Length: 15.5mm
C30, S40, V50, V60 & XC60 2004 - On

UNIT PACKAGE: 25



19248

(1268176-3)
Black Nylon

Bumper Cover
Push-Type Retainer
Head Diameter: 16mm
Stem Length: 14mm
Fits into 6mm Hole
740 & 760 1993 - On

UNIT PACKAGE: 15



21785

(Volvo: 30624192)
Black & Yellow Nylon

Rocker Panel Moulding Retainer
Top Head Diameter: 16mm
Middle Head Diameter: 17.5mm
Bottom Head Diameter: 17mm
Stem Length: 9mm
Fits into 8mm Hole
Overall Length: 15mm
S60 & V60 2011 - On

UNIT PACKAGE: 25



19904

(9133417-7)
Black Nylon

Rocker Panel
Push-Type Retainer
Head Diameter: 16mm
Stem Length: 14mm
Fits into 9mm Hole
850 Series 1994 - On

UNIT PACKAGE: 15



13230

(Mercedes 000-990-03-92; Volvo 947-098)
Black Nylon

Push-Type Retainer
Head Diameter: 10mm
Stem Length: 7mm
Fits into 5mm Hole

UNIT PACKAGE: 50



20407

(9133073-8)
Black Nylon

Hood Insulation &
Radiator Seal Push-Type Retainer
Head Size: 8mm x 25mm
Stem Length: 10mm
Fits into 5mm Hole
850, 940, 960, S80, S90 & V90 1991 - On

UNIT PACKAGE: 25



21859

(Mercedes-Benz: 000-990-29-92,
000-990-60-92, 001-990-16-92,
114-990-01-92; Opel: 1104882, 1719245;
Volvo: 9133417, 1268642)
Black Nylon

Push-Type Retainer
Head Diameter: 16mm
Stem Length: 11mm
Fits into 8mm Hole
Mercedes-Benz, Opel & Volvo 1985 - On

UNIT PACKAGE: 15



13220

(Mercedes 000-994-09-45;
Volvo 946-418;
Opel 20-72-175)
Plated

U-Type Nut
Screw Size: 6.3mm
Panel Range: .7mm-1.5mm
Center of Hole to Edge: 13mm

UNIT PACKAGE: 50

UNIVERSAL EUROPEAN IMPORT FASTENERS



16132

Black Nylon

Trim Panel Retainer
Head Diameter: 19mm
Stem Length: 20mm
Fits into 8mm Hole

UNIT PACKAGE: 25



16134

Zinc & Yellow

Thread Cutting Nut with Sealer
For 3mm Stud
Outer Diameter: 13.5mm
Hex: 8mm

UNIT PACKAGE: 25

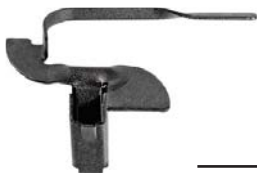

9965
(GM: 1244839, 3944866)
Moulding Fastener
UNIT PACKAGE: 25

12971

Same as 9965 except for unit package quantity
UNIT PACKAGE: 10



2943
(4759145, 4761842, 4779348)
Front and Rear Fender and
Door Peak Moulding Fastener
GM
UNIT PACKAGE: 50

12966

Same as 2943 except for unit package quantity
UNIT PACKAGE: 15



2744
(Chry: 1624705, 6010093)
Moulding Fastener
Bolt: #10-24 x 3/4"
Plate Length: 3/4"
Plate Width: 5/16"
UNIT PACKAGE: 50

12959

Same as 2744 except for unit package quantity
UNIT PACKAGE: 15



2818
(GM: 4689929, 4778814)
Moulding Fastener
Bolt: #10-24 x 3/4"
Plate Length: 3/4"
Plate Width: 5/16"
UNIT PACKAGE: 50

12962

Same as 2818 except for unit package quantity
UNIT PACKAGE: 15



19626
(Ford: 358560;
Chry: 1560058, 6010029;
GM: 568792, 574355, 1165051)
Moulding Fastener
Bolt: #10-24 x 3/4"
Plate Length: 1"
Plate Width: 1/2"
Replaces Auveco 2514
UNIT PACKAGE: 25

19627

Same as 19626 except for unit package quantity
UNIT PACKAGE: 15



20175
(4637277, 4730773)

Moulding Fastener
#10-24 x 3/4"
Plate Length: 1-5/8"
Plate Width: 11/16"
Replaces Auveco 2821
UNIT PACKAGE: 25



2789
(GM: 575411, 4723818)
Moulding Fastener
Bolt: #10-24 x 5/8"
Plate Length: 1-5/8"
Plate Width: 9/16"
UNIT PACKAGE: 50

12961

Same as 2789 except for unit package quantity
UNIT PACKAGE: 15



2619
(Chry: 6000705, 6013029;
GM: 3722635)
Moulding Fastener
Bolt: #10-24 x 3/4"
Plate Length: 1-11/32"
Plate Width: 1/2"
UNIT PACKAGE: 50

12958

Same as 2619 except for unit package quantity
UNIT PACKAGE: 15



2752
(GM: 3744999;
Chry: 1758099,
6000720, 6010046)
Moulding Fastener
Bolt: #10-24 x 3/4"
Plate Length: 1-25/32"
Plate Width: 9/16"
UNIT PACKAGE: 50

12960

Same as 2752 except for unit package quantity
UNIT PACKAGE: 15



19807
(GM: 4676189)
Moulding Fastener
Bolt: #10-24 x 3/4"
Plate Length: 2-17/32"
Plate Width: 11/16"
Replaces Auveco 2820
UNIT PACKAGE: 15



19378
Zinc

Universal Moulding
Fastener
Bolt: #10-24 x 3/4"
Plate: 2-1/2" x 3/4"

Break off plate at 1/16" perforations to fit moulding
Replaces Auveco 2356
Use with Auveco Hex Nut 730

UNIT PACKAGE: 25



8581
Nylon

Moulding Fastener
Plate Length: 3"
Plate Width: 3/4"

Break off plate at 5/32" perforations to fit moulding

UNIT PACKAGE: 10



5889

Universal Moulding Fastener
For 5/16"-1/2" Moulding
Fits into 3/8" Hole

UNIT PACKAGE: 50



8843
Nylon

Moulding Fastener
For 1/2"-5/8" Mouldings

UNIT PACKAGE: 50



8447
(GM: 4886720, 4417599)
Nylon

Front & Rear Door
Moulding Fastener
For 1/2" to 5/8" Moulding

UNIT PACKAGE: 50



8448
(GM: 4879481)
Nylon

Front & Rear Door
Moulding Fastener
For 3/4" to 1" Moulding

UNIT PACKAGE: 50



8398
(GM: 4853108)
Nylon

Front & Rear Door and
Quarter Panel Moulding Fastener
For 3/4" to 1" Moulding

UNIT PACKAGE: 25



8385
(GM: 4877000)
Nylon

Door & Fender Moulding Fastener
For 3/4" to 1" Moulding

UNIT PACKAGE: 25



8399
(GM: 4883164)
Nylon

Rear Fender Lower Moulding Fastener
For 7/8" to 1-1/4" Mouldings

UNIT PACKAGE: 25



8386
(GM: 4877001)
Nylon

Rear Fender Lower
Moulding Fastener
For 1" to 1-1/4" Moulding

UNIT PACKAGE: 25



8400
Nylon
Moulding Fastener
For 1-1/4" to 1-3/4" Moulding

UNIT PACKAGE: 25

Photos not actual size

Rod End Ball Joints • Male

• **Bearing Raceway:**
Locked in by annular groove-trunnion design.
Made of fiber reinforced nylon.

• **Spherical Ball:**
Precision made from selected low carbon steel-case hardened - file hard. Plated plus dichromate treated for corrosion resistance.

• **Outer Member (Housing):**
Low carbon steel, plated plus dichromate treated for corrosion resistance.

• **Left Hand Thread:**
Available with left hand thread in most sizes. Marked for easy user identification.

Only available fully assembled.

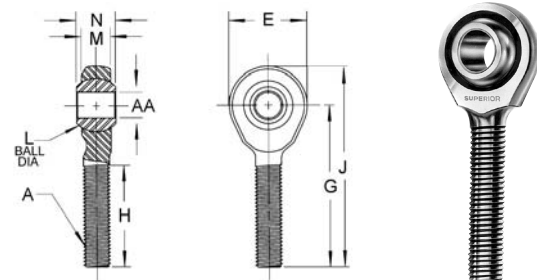

Auveco Part No.	Thread Size (A)	AA	E	G	H	J	L	M	N	Unit Pkg.	Thread
12268	10-32	.189	.625	1.250	.750	1.562	.438	.250	.312	1	R
12269		.191								1	L
12270	1/4-28	.250	.750	1.562	1.000	1.937	.516	.281	.375	1	R
12271		.252								1	L
12021	5/16-24	.3125	.875	1.875	1.250	2.312	.625	.344	.437	1	R
12272		.3145								1	L
12022	3/8-24	.375	1.000	1.937	1.250	2.437	.719	.406	.500	1	R
12273		.377								1	L
12485	7/16-20	.4395	1.125	2.125	1.312	2.687	.812	.437	.562	1	R
		.4375									
12023	1/2-20	.500	1.312	2.437	1.500	3.094	.938	.500	.625	1	R
12274		.502								1	L
12024	5/8-18	.625	1.500	2.625	1.625	3.375	1.125	.562	.750	1	R
12486	3/4-16	.752	1.750	2.875	1.750	3.750	1.312	.687	.875	1	R
		.750									

Rod End Ball Joints • Female

• **Bearing Raceway:**
Locked in by annular groove-trunnion design.
Made of fiber reinforced nylon.

• **Spherical Ball:**
Precision made from selected low carbon steel-case hardened - file hard. Plated plus dichromate treated for corrosion resistance.

• **Outer Member (Housing):**
Low carbon steel, plated plus dichromate treated for corrosion resistance.

• **Left Hand Thread:**
Available with left hand thread in most sizes. Marked for easy user identification.

Only available fully assembled.

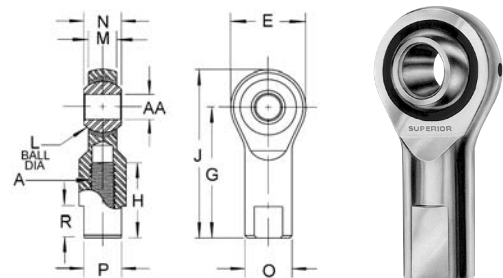

Auveco Part No.	Thread Size (A)	AA	E	G	H	J	L	M	N	O	P	R	Unit Pkg.	Thread
12025	10-32	.189	.625	1.062	.562	1.375	.438	.250	.312	.406	.312	.406	1	R
12276		.191											1	L
12026	1/4-28	.250	.750	1.312	.750	1.687	.516	.281	.375	.469	.375	.406	1	R
12277		.252											1	L
12027	5/16-24	.3125	.875	1.375	.750	1.812	.625	.344	.437	.500	.437	.500	1	R
12278		.3145											1	L
12028	3/8-24	.375	1.000	1.625	.937	2.125	.719	.406	.500	.687	.562	.562	1	R
12279		.377											1	L
12487	7/16-20	.4395	1.125	1.812	1.032	2.375	.812	.437	.562	.750	.625	.625	1	R
		.4375												
12029	1/2-20	.500	1.312	2.125	1.187	2.781	.938	.500	.625	.875	.750	.687	1	R
12280		.502											1	L
12281	5/8-18	.625	1.500	2.500	1.500	3.250	1.125	.562	.750	1.000	.875	.875	1	R
12488	3/4-16	.752	1.750	2.875	1.562	3.750	1.312	.687	.875	1.125	1.000	1.000	1	R
		.750												

Photos not actual size

Rod End Ball Joints • Male with Stud

• **Bearing Raceway:**
Locked in by annular groove-trunnion design.
Made of fiber reinforced nylon.

• **Spherical Ball:**
Precision made from selected low carbon steel-case hardened - file hard. Plated plus dichromate treated for corrosion resistance.

• **Outer Member (Housing):**
Low carbon steel, plated plus dichromate treated for corrosion resistance.

• **Left Hand Thread:**
Available with left hand thread in most sizes. Marked for easy user identification.

Only available fully assembled.

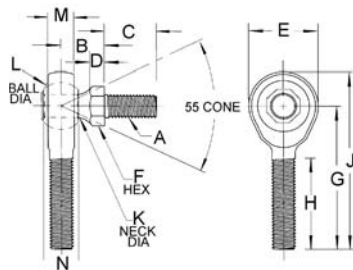

Auveco Part No.	Thread Size (A)	B	C	D	E	F	G	H	J	K	L	M	N	Unit Pkg.	Thread
12290	10-32	.437	.437	.156	.625	.312	1.250	.750	1.562	.189	.438	.250	.312	1	R
12292	1/4-28	.469	.562	.156	.750	.375	1.562	1.000	1.937	.250	.516	.281	.375	1	R
12293														1	L
12030	5/16-24	.531	.687	.187	.875	.437	1.875	1.250	2.312	.312	.625	.344	.437	1	R
12031	3/8-24	.625	.875	.218	1.000	.500	1.937	1.250	2.437	.375	.719	.406	.500	1	R
12295														1	L
12032	1/2-20	.875	1.125	.312	1.312	.625	2.437	1.500	3.094	.500	.938	.500	.625	1	R

Rod End Ball Joints • Female with Stud

• **Bearing Raceway:**
Locked in by annular groove-trunnion design.
Made of fiber reinforced nylon.

• **Spherical Ball:**
Precision made from selected low carbon steel-case hardened - file hard. Plated plus dichromate treated for corrosion resistance.

• **Outer Member (Housing):**
Low carbon steel, plated plus dichromate treated for corrosion resistance.

• **Left Hand Thread:**
Available with left hand thread in most sizes. Marked for easy user identification.

Only available fully assembled.

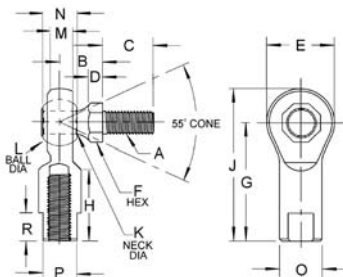

Auveco Part No.	Thread Size (A)	B	C	D	E	F	G	H	J	K	L	M	N	O	P	R	Unit Pkg.	Thread
12034	10-32	.437	.437	.156	.625	.312	1.062	.562	1.375	.189	.438	.250	.312	.406	.312	.406	1	R
12283																	1	L
12035	1/4-28	.469	.562	.156	.750	.375	1.312	.750	1.687	.250	.516	.281	.375	.469	.375	.406	1	R
12284																	1	L
12036	5/16-24	.531	.687	.187	.875	.437	1.375	.750	1.812	.312	.625	.344	.437	.500	.437	.500	1	R
12285																	1	L
12037	3/8-24	.625	.875	.218	1.000	.500	1.625	.937	2.125	.375	.719	.406	.500	.687	.562	.562	1	R
12286																	1	L
12491	7/16-20	.844	1.062	.312	1.125	.625	1.812	1.032	2.375	.437	.812	.437	.562	.750	.625	.625	1	R
12038	1/2-20	.875	1.125	.312	1.312	.625	2.125	1.187	2.781	.500	.938	.500	.625	.875	.750	.687	1	R
12288	5/8-18	1.00	1.125	.375	1.500	.750	2.500	1.500	3.250	.625	1.125	.562	.750	1.00	.875	.875	1	R
12492	3/4-16	1.187	1.812	.375	1.750	1.00	2.875	1.562	3.750	.750	1.312	.687	.875	1.125	1.00	1.00	1	R

Photos not actual size

Damper Control Swivels

The units are made from low carbon steel and are plated and dichromate treated for corrosion resistance. The set screws are made of low carbon steel, plated and dichromate treated for corrosion resistance.

Set screws are case hardened.

A rubber disc is used in the assembly.

Only available fully assembled

Damper Control Swivels				
Thread Size	Auveco Part No. w/o Nut & Washer	Unit Pkg.	Auveco Part No. with Nut & Washer	Unit Pkg.
1/4-28 x 9/16"	12303	2	12047	3
1/4-20 x 9/16"	12305	2	12049	3

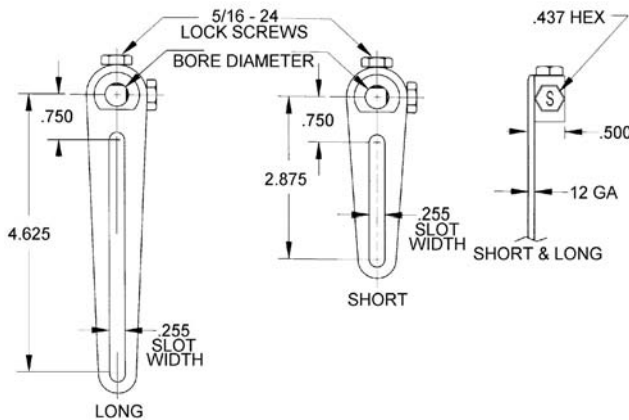
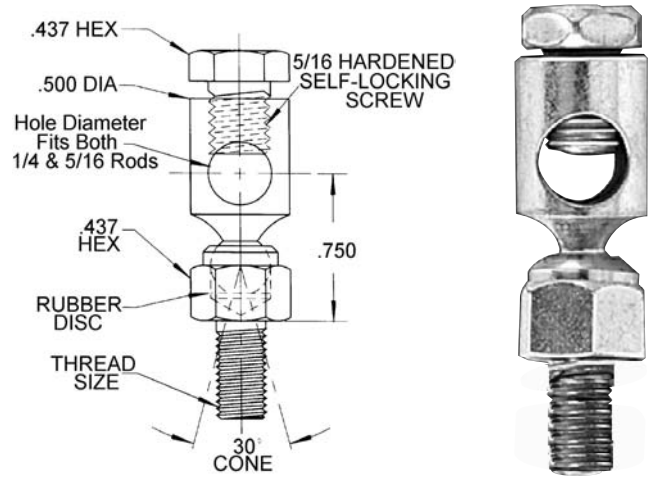

Crank Arms

12 Gauge Steel

12050

Short Series Crank Arm
For 3/8" Shaft
Bore Diameter: .385/.389

UNIT PACKAGE: 1



Lightweight Ball Joint Assemblies

Materials of construction: Made of low carbon steel. Units are plated and dichromate treated for corrosion resistance. A rubber disc is used.

Only available fully assembled.

Auveco Part No	Unit Pkg.	G.M.C. Part No.	A	B	C	D	E	F
21533	2	443773	1/4-28	2-3/32	9/16	7/16	5/16	9/16

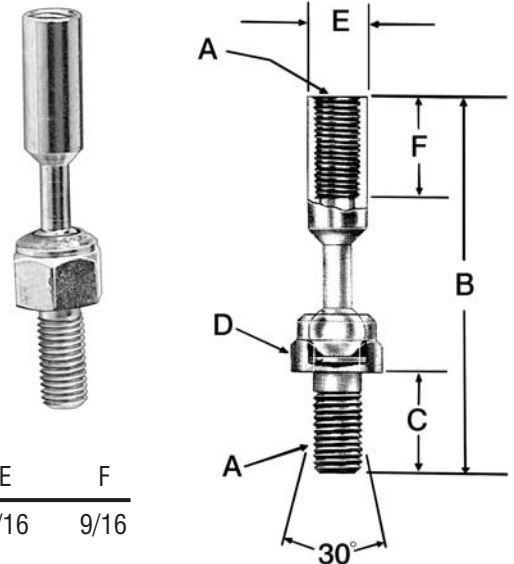

“Flat Top” • Shurseal



Materials of construction:
Made of low carbon steel with ball studs case hardened. Plated and dichromate treated for corrosion resistance.

Only available fully assembled.

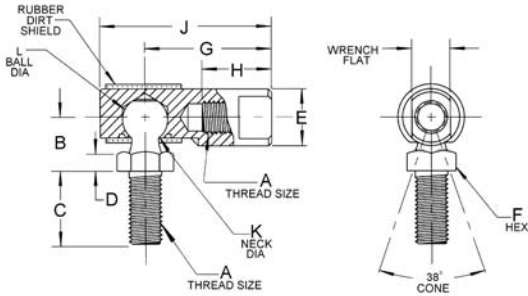

Auveco Part No.	A	B	C	D	E	Wrench Size	F	G	H	J	K	L	Unit Pkg.	Thread
13580	10-32	7/16	7/16	1/8	3/8	5/16	5/16	7/8	15/32	1-5/32	.177	.301	2	R
12039	1/4-28	15/32	9/16	1/8	7/16	3/8	3/8	31/32	17/32	1-5/16	.208	.347	3	R
12040	5/16-24	17/32	11/16	5/32	1/2	7/16	7/16	1-1/8	19/32	1-9/16	.250	.405	3	R
13590													2	L
12041	3/8-24	11/16	7/8	3/16	5/8	1/2	1/2	1-3/8	13/16	1-13/16	.289	.493	1	R
12042	7/16-20	7/8	1-1/8	1/4	3/4	5/8	5/8	1-15/16	1-1/8	2-1/2	.375	.618	1	R

Quick Disconnect

“Key Hole” design on retaining sleeve insures positive alignment of sleeve with ball cavity.

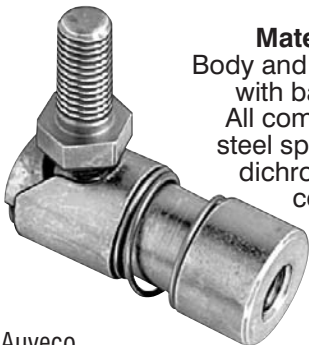

Materials of construction:
Body and ball are of low carbon steel, with ball studs case hardened. All components except stainless steel spring are plated and yellow dichromate treated for greater corrosion resistance.

Only available fully assembled.

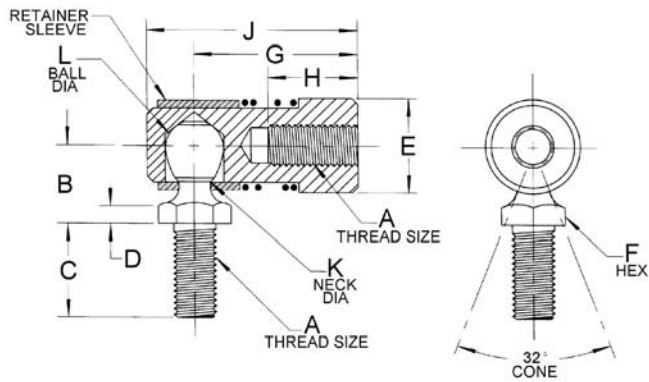

Auveco Part No.	A	B	C	D	E	F	G	H	J	K	L	Unit Pkg.
12044	1/4-28	15/32	9/16	1/8	9/16	3/8	31/32	17/32	1-1/4	.192	.347	2
12045	5/16-24	17/32	11/16	5/32	5/8	7/16	1-1/8	19/32	1-29/64	.224	.405	2
13610	3/8-24	11/16	7/8	3/16	3/4	1/2	1-3/8	13/16	1-3/4	.273	.493	1

Disconnecting

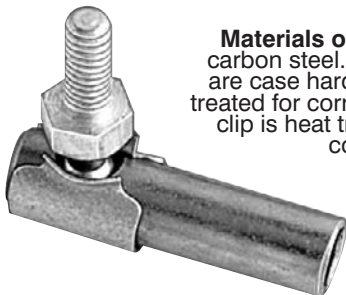

Materials of construction: Made of low carbon steel. Both ball stud and ball cavity are case hardened. Plated and dichromate treated for corrosion resistance. The retaining clip is heat treated spring steel, plated for corrosion resistance.

Only available fully assembled.

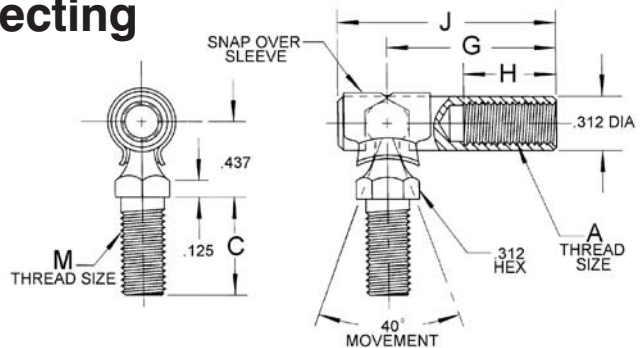

Auveco Part No.	A	C	G	H	J	M	Unit Pkg.
13599	10-32NF	7/16	7/8	31/64	1-5/32	10-32NF	2
13601	10-32NF	9/16	7/8	31/64	1-5/32	1/4-28UNF	2
13600	1/4-28UNF	9/16	31/32	17/32	1-1/4	1/4-28UNF	2

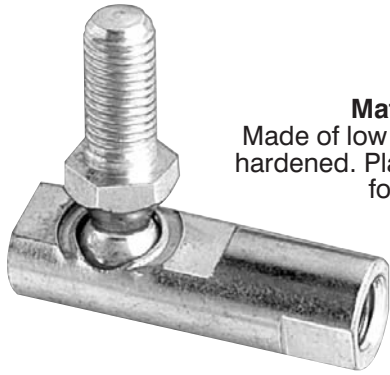

“Flat Top”

Materials of construction:
 Made of low carbon steel with ball studs case hardened. Plated and clear dichromate treated for corrosion resistance.

Only available fully assembled.

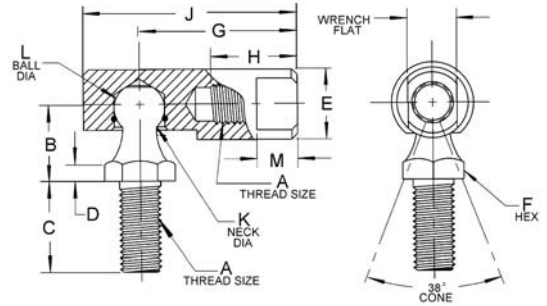

Auveco Part No.	A	B	C	D	E	Wrench Size	F	G	H	J	K	L	Unit Pkg.	Thread
13581	10-32	7/16	7/16	1/8	3/8	5/16	5/16	7/8	15/32	1-5/32	.177	.301	2	R
13582	1/4-28	15/32	9/16	1/8	7/16	3/8	3/8	31/32	17/32	1-5/16	.208	.347	2	R
13584	5/16-24	17/32	11/16	5/32	1/2	7/16	7/16	1-1/8	19/32	1-9/16	.250	.405	2	R
9869	3/8-24	11/16	7/8	3/16	5/8	1/2	1/2	1-3/8	13/16	1-13/16	.289	.493	5	R
13587	1/2-20	7/8	1-1/8	1/4	3/4	5/8	5/8	1-15/16	1-1/8	2-1/2	.375	.618	1	R

YOKE ENDS

Zinc finished Drop Forged Yoke Ends • Adjustable

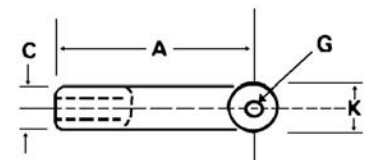
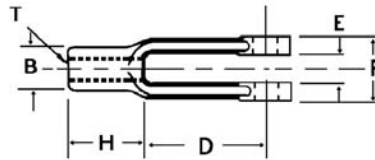
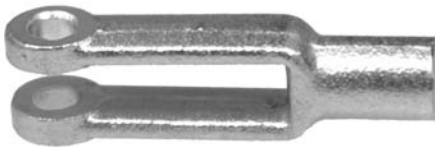

Auveco Part No.	“T” Tap Size	Dimensions in Inches									Unit Pkg.
		A	B	C	D	E	F	G	H	K	
10737	1/4-28	2	7/16	7/16	1-1/4	9/32	5/8	1/4	3/4	1/2	10
10788	1/4-28	2	7/16	7/16	1-1/4	9/32	5/8	1/4	3/4	1/2	2
10738	5/16-24	2-1/4	1/2	1/2	1-7/16	11/32	3/4	5/16	13/16	19/32	10
10789	5/16-24	2-1/4	1/2	1/2	1-7/16	11/32	3/4	5/16	13/16	19/32	2
10739	3/8-24	2-1/2	5/8	5/8	1-5/8	7/16	7/8	3/8	7/8	11/16	10
10790	3/8-24	2-1/2	5/8	5/8	1-5/8	7/16	7/8	3/8	7/8	11/16	2
10740	7/16-20	2-7/8	23/32	23/32	1-7/8	1/2	1	7/16	1	13/16	10
10791	7/16-20	2-7/8	23/32	23/32	1-7/8	1/2	1	7/16	1	13/16	2
10741	1/2-20	3	13/16	13/16	1-7/8	9/16	1-1/8	1/2	1-1/8	15/16	10
10792	1/2-20	3	13/16	13/16	1-7/8	9/16	1-1/8	1/2	1-1/8	15/16	2
10742	5/8-18	4-15/16	1-1/16	1-1/16	3-11/16	11/16	1-3/8	5/8	1-1/4	1-3/16	10
10793	5/8-18	4-15/16	1-1/16	1-1/16	3-11/16	11/16	1-3/8	5/8	1-1/4	1-3/16	2

Sec. 25

HOSE CLAMPS



**Single Bond
Hose Clamps**
Black Nylon

Auveco Part No.	Size	Clamping Range		Unit Pkg.
		Min.	Max.	
19558	1/4"	.246	.290	25
19559	5/16"	.300	.350	25
19560	11/32"	.360	.406	25
19561	13/32"	.410	.468	25
19562	15/32"	.475	.536	25
19564	19/32"	.597	.665	25
19566	3/4"	.730	.830	25
19568	61/64"	.953	1.093	25
19569	1-1/32"	1.031	1.187	25
19570	1-1/4"	1.250	1.425	10
19571	1-13/32"	1.406	1.610	10
19572	1-19/32"	1.593	1.812	10
19575	2-1/8"	2.120	2.390	10



Spring Action Hose Clamps

Spring Steel • Heat Treated
Phosphate and Paint

Auveco Part No.	Hose O.D.	Color	Max. Dia. Clamp in Free Position	Width	Unit Pkg.
12682	3/8"	Black	.321	5/16"	100
12683	7/16"	Green	.405	5/16"	100
12684	1/2"	Red	.460	5/16"	100
12685	9/16"	Black	.520	5/16"	100
12686	5/8"	Olive	.583	5/16"	100
12688	11/16"	Red	.655	5/16"	100
12689	3/4"	Black	.645	3/8"	100

Crimp Type Hose Clamp Tool

18448

Photo not actual size

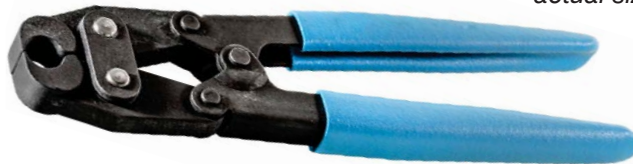

For installing and removing
Auveco Crimp Type Hose Clamps 18436-18447.

UNIT PACKAGE: 1

Crimp Type Hose Clamps

Zinc Plated

Photos not actual size

- For low pressure applications such as automotive, appliance, industrial machinery, etc.
- Easy to apply
- Simply slide on and clamp
- Sizes for all Hoses
- Ideal for Mass Production
- Clamps Tight
- Clamps Quickly
- Only one simple motion needed
- "Full Round" Clamping Pressure
- No gap areas to leak
- Low profile-out of the way
- Avoids Hose cutting and abrasion



Position clamp on hose

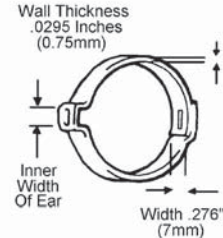
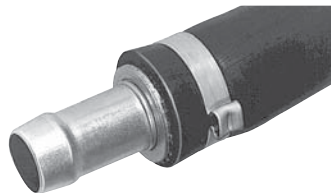

Firmly squeeze ear



Auveco Part No.	Nominal Size	Inches		MM		Inner Width of Ear		Unit Pkg.
		Closed-Open	Closed-Open	Inches	MM			
18436	3/8"	.350 - .414	8.9 - 10.5	.197	5	25		
18437	7/16"	.381 - .444	9.7 - 11.3	.197	5	25		
18438	15/32"	.394 - .486	10.4 - 12.3	.197	6	25		
18439	1/2"	.453 - .524	11.4 - 13.3	.236	6	25		
18440	35/64"	.472 - .551	11.9 - 14.0	.256	6.5	25		
18441	9/16"	.496 - .571	12.6 - 14.5	.236	6	25		
18442	5/8"	.543 - .618	13.8 - 15.7	.236	6	25		
18443	11/16"	.594 - .669	15.1 - 17.0	.236	6	25		
18444	23/32"	.618 - .728	15.7 - 18.5	.354	9	25		
18445	3/4"	.669 - .779	17.0 - 19.8	.354	9	25		
18446	7/8"	.779 - .890	19.8 - 22.6	.354	9	25		
18447	1"	.898 - 1.008	22.8 - 25.6	.354	9	25		



Constant Tension Band Hose Clamps

For Heater & Radiator Hoses
 1074 Spring Steel • Black OEM Finish
 Conforms to SAE J1508 & GM 6298M
 Rated at 30 P.S.I.

Auveco Part No.	Clamping Range	Band Width	Unit Pkg.
18127	15.2mm - 18.5mm (5/8" - 23/32")	15mm (19/32")	10
18128	17.8mm - 20.0mm (23/32" - 25/32")	15mm (19/32")	10
18129	22.0mm - 26.0mm (7/8" - 1")	15mm (19/32")	10
18132	37.2mm - 44.5mm (1-15/32" - 1-3/4")	15mm (19/32")	5



Wire Type Hose Clamps

To Install and remove wire type hose clamps use Auveco Tool 20902 (See page 849)

Auveco Part No.	Hose Size O.D.	Unit Pkg.
5354	9/16"	50
5357	3/4"	50
17086	13/16"	50
5358	15/16"	50
16603	1-7/8"	10
16604	2"	10



9324

Mini Clamp
 Stainless Steel Band with
 Double Plated Hex Head Steel Screw
 Band Width: 5/16"
 Minimum Range 1/4" - Maximum Range 5/8"

UNIT PACKAGE: 10



10221

Mini Clamp
 Stainless Steel Band with Double
 Plated Slotted Head Steel Screw
 Band Width: 5/16"
 Minimum Range 1/2" - Maximum Range 7/8"

UNIT PACKAGE: 10



Hex Slotted Screw-Worm Gear Type-Hose Clamps

Stainless Steel
 Band Saddle Screw Housing
 300 Series Stainless (Non-Corrosive)
 Screw is 400 Series (Magnetic) Stainless

Auveco. Part No.	Inside Std. Size	Clamp Range Min.-Max	Hose I.D. 3/16" Wall	Fits Plastic Pipe Size	Band Width	Unit Pkg.
9584	8	7/16" - 1"	5/16" to 1/2"	1/2" to 9/16"	9/16"	10
9585	10	1/2" - 1-1/8"	3/8" to 5/8"	1/2" to 3/4"	9/16"	10
9586	12	1/2" - 1-1/4"	5/8" to 3/4"	1/2" to 3/4"	9/16"	10
18483	16	3/4" - 1-1/2"	3/4" to 7/8"	1" to 1-1/4"	9/16"	10
9587	20	3/4" - 1-3/4"	1" to 1-1/4"	1" to 1-1/4"	9/16"	10
9588	24	1" - 2"	1-1/4" to 1-1/2"	1" to 1-1/2"	9/16"	10
9589	28	1-5/16" - 2-1/4"	1-1/4" to 1-3/4"	1-1/4" to 1-1/2"	9/16"	10
9590	32	1-9/16" - 2-1/2"	1-1/2" to 2"	1-1/2" to 2"	9/16"	10
9591	36	7/8" - 2-3/4"	1-3/4" to 2-1/4"	1-1/2" to 2"	9/16"	10
9592	40	1-1/8" - 3"	2" to 2-1/2"	2" to 2-1/2"	9/16"	10
9593	48	1-5/8" - 3-1/2"	2-1/4" to 3"	2-5/8" to 3"	9/16"	10
9594	52	1-7/8" - 3-3/4"	2-13/16" to 3-3/4"	3"	9/16"	10
9595	72	3-1/8" - 5"	3-3/4" to 4-1/2"		9/16"	10
9596	88	4-1/4" - 6"	4" to 5-1/2"	4"	9/16"	10
9597	96	4-3/4" - 6-1/2"	4-1/2" to 6"		9/16"	10
9598	104	5" - 7"	5-7/8" to 6-1/2"	6"	9/16"	10



Hex Slotted Screw-Worm Gear Type-Hose Clamps

Partial Stainless Steel
300 Series Stainless Steel Band and Saddle
Plated Screw and Housing

Auveco Part No.	Inside Std. Size	Clamp Range Min.-Max	Hose I.D. 3/16" Wall	Fits Plastic Pipe Size	Band Width	Unit Pkg.
5347	10	1/2" - 1-1/8"	3/8" to 5/8"	1/2" to 3/4"	9/16"	10
5348	12	1/2" - 1-1/4"	5/8" to 3/4"	1/2" to 3/4"	9/16"	10
18482	16	3/4"-1-1/2"	3/4" to 7/8"	1" to 1-1/4"	9/16"	10
5349	20	3/4" - 1-3/4"	1" to 1-1/4"	1" to 1-1/4"	9/16"	10
5350	28	1-5/16" - 2-1/4"	1-1/4" to 1-3/4"	1-1/4" to 1-1/2"	9/16"	10
5351	32	1-9/16" - 2-1/2"	1-1/2" to 2"	1-1/2" to 2"	9/16"	10
5352	36	7/8" - 2-3/4"	1-3/4" to 2-1/4"	1-1/2" to 2"	9/16"	10
9357	48	1-5/8" - 3-1/2"	2-1/4" to 3"	2-1/4" to 2-3/4"	9/16"	10
9599	52	1-7/8" - 3-3/4"	2-13/16" to 3-3/4"	3"	9/16"	10
9358	72	3-1/8" - 5"	3-3/4" to 4-1/2"		9/16"	10
9600	88	4-1/4" - 6"	4" to 5-1/2"	4"	9/16"	10
9601	96	4-3/4" - 6-1/2"	4-1/2" to 6"		9/16"	10

Norma Torro® (European Style) Hose Clamps

DIN 3017 • Stainless Steel Band & Housing • Zinc Plated Steel Screw



Unique off-set non-welded design of the housing provides resistance to over-tightening damage to the hose. The short housing saddle gives a smooth underside ensuring high sealing efficiency. These clamps are original equipment on both domestic and import vehicles. They are particularly suited for fuel, vacuum, water, emission and heater hoses and can be used with silicone hoses.

Auveco Part No.	Clamping Range	Hex Size	Band Width	Unit Pkg.
16868	8mm-12mm (5/16"-1/2")	6mm*	8mm (5/16")	10
16869	10mm-16mm (3/8"-5/8")	6mm*	8mm (5/16")	10
16870	12mm-18mm (1/2"-3/4")	6mm*	8mm (5/16")	10
16871	8mm-16mm (5/16"-5/8")	6mm	9mm (11/32")	10
16872	12mm-20mm (1/2"-3/4")	6mm	9mm (11/32")	10
16873	16mm-25mm (5/8"-1")	6mm	9mm (11/32")	10
16874	20mm-32mm (3/4"-1-1/4")	6mm	9mm (11/32")	10
16875	25mm-40mm (1"-1-5/8")	6mm	9mm (11/32")	10
16876	30mm-45mm (1-3/16"-1-3/4")	6mm	9mm (11/32")	10
16877	32mm-50mm (1-1/4"-2")	6mm	9mm (11/32")	10
16878	40mm-60mm (1-5/8"-2-3/8")	6mm	9mm (11/32")	10
19252	50mm-70mm (1-31/32"-2-3/4")	6mm	9mm (11/32")	10
19253	60mm-80mm (2-3/8"-3-1/8")	6mm	9mm (11/32")	10
19254	70mm-90mm (2-3/4"-3-9/16")	6mm	9mm (11/32")	10

*Phillips Hex Drive



Photo not actual size

16879

Flexible Nut Driver
For 6mm Hex
Fits Auveco Hose Clamps
16868 - 16878 and 19252 - 19254

UNIT PACKAGE: 1



Type "G" Miniature Hose Clamp

These clamps fit all standard automotive fuel injection hoses. Approved for all O.E.M. applications
Zinc Plated

Auveco Part No.	Clamp Range Min.-Max	Hose I.D.	Band Width	Unit Pkg.
16766	8mm-9.5mm 5/16"-13/32"	5/32"	9mm (11/32")	10
16767	9.5mm-11.5mm 3/8"-15/32"	7/32"	9mm (11/32")	10
15860	10.5mm-12.5mm 7/16"-1/2"	1/4"	9mm (11/32")	10
15861	12.5mm-14.5mm 1/2"-19/32"	5/16"	9mm (11/32")	10
15862	13.5mm-15.5mm 17/32"-5/8"	3/8"	9mm (11/32")	10
21256	15mm-17.5mm 19/32"-11/16"	3/8"	9mm (11/32")	10



Steel Clamps with Neoprene Jacket Zinc Plated

UNIT PACKAGE: 10

Auveco Part No.	Tube Size	Band Width	Mounting Hole Diameter
20502	1/4"	1/2"	17/64"
20503	3/8"	1/2"	17/64"
20504	1/2"	1/2"	17/64"
20505	5/8"	1/2"	17/64"
20506	3/4"	1/2"	17/64"
20507	7/8"	1/2"	17/64"
20508	1"	1/2"	17/64"
20509	1-1/4"	1/2"	17/64"
20510	1-1/2"	1/2"	17/64"
20511	1-3/4"	1/2"	17/64"
20512	2"	1/2"	17/64"



Natural Nylon Tubing Clamps

Auveco Part No.	Hole Dia.	Width	Tube Dia.	Unit Pkg.
15525	3/16"	3/8"	1/8"	50
15526	3/16"	3/8"	3/16"	50
9246	3/16"	3/8"	1/4"	25
9247	3/16"	3/8"	5/16"	25
9248	3/16"	3/8"	3/8"	25
9249	3/16"	3/8"	1/2"	25
9250	3/16"	1/2"	5/8"	25
9251	3/16"	1/2"	3/4"	25
9252	3/16"	1/2"	1"	25



Aluminum Tubing Clamps With Neoprene Jacket

Auveco Part No.	Hole Dia.	Width	Tube Dia.	Unit Pkg.
17361	1/4"	1/2"	1/4"	15
17362	1/4"	1/2"	5/16"	15
17363	1/4"	1/2"	3/8"	15
17364	1/4"	1/2"	1/2"	15
17365	1/4"	1/2"	5/8"	15
17366	1/4"	1/2"	3/4"	15
17367	1/4"	1/2"	7/8"	15
17368	1/4"	1/2"	1"	15
22170	1/4"	1/2"	1-1/4"	10
22171	1/4"	1/2"	1-1/2"	10
22172	1/4"	1/2"	2"	10



Insulated "Half" Clamps Galvanized Coated with Black Vinyl (1/32" Thick)

Auveco Part No.	Inside Diameter	Hole Diameter	Center to Center	Hole Center to End	Top of Radius to Base	Gauge	Width	Unit Pkg.
10608	3/16"	7/32"	7/16"	1/4"	5/32"	.032	1/2"	25
10609	1/4"	7/32"	1/2"	1/4"	7/32"	.048	1/2"	25
10610	5/16"	9/32"	17/32"	5/16"	9/32"	.048	5/8"	25
10611	3/8"	9/32"	9/16"	5/16"	11/32"	.048	5/8"	25
10612	7/16"	9/32"	5/8"	5/16"	13/32"	.060	5/8"	25
10613	1/2"	9/32"	11/16"	5/16"	15/32"	.060	5/8"	25
10614	5/8"	9/32"	13/16"	5/16"	9/16"	.060	5/8"	25
10615	3/4"	9/32"	7/8"	5/16"	11/16"	.060	5/8"	25

Steel Insulated Closed Clamps

Furnished Open • Galvanized • Coated with Black Vinyl (1/32" Thick)

UNIT PACKAGE: 25

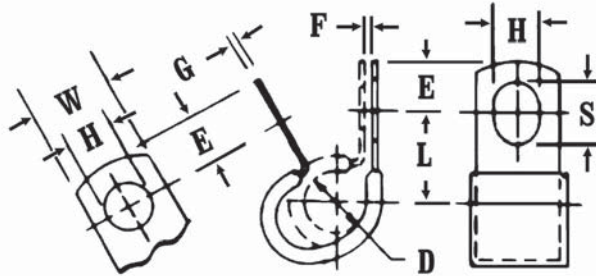

Auveco Part No.	D Inside Diameter	H Hole Diameter	L Center to Center	W Width	E Hole Center to End	F Gap	G Gauge	S Slot Length
Small Hole Clamps								
17087	3/16"	9/32"	1/2"	1/2"	5/16"	1/32"	.032"	3/8"
9381	1/4"	9/32"	17/32"	1/2"	5/16"	1/32"	.032"	3/8"
9382	5/16"	9/32"	9/16"	1/2"	5/16"	1/32"	.032"	3/8"
9383	3/8"	9/32"	19/32"	1/2"	5/16"	1/16"	.032"	3/8"
9384	1/2"	9/32"	21/32"	1/2"	5/16"	1/16"	.048"	3/8"
9385	5/8"	9/32"	23/32"	1/2"	5/16"	1/16"	.048"	3/8"
9386	3/4"	9/32"	25/32"	1/2"	5/16"	1/16"	.048"	3/8"
9387	7/8"	9/32"	27/32"	1/2"	5/16"	1/16"	.048"	3/8"
9388	1"	9/32"	29/32"	1/2"	5/16"	1/16"	.048"	3/8"

Large Hole Clamps

10598	1/4"	13/32"	21/32"	3/4"	7/16"	1/32"	.032"	1/2"
10599	5/16"	13/32"	11/16"	3/4"	7/16"	1/32"	.032"	1/2"
10600	3/8"	13/32"	23/32"	3/4"	7/16"	1/16"	.032"	1/2"
10601	1/2"	13/32"	25/32"	3/4"	7/16"	1/16"	.048"	1/2"
10602	5/8"	13/32"	27/32"	3/4"	7/16"	1/16"	.048"	1/2"
10603	3/4"	13/32"	29/32"	3/4"	7/16"	1/16"	.048"	1/2"
10604	7/8"	13/32"	31/32"	3/4"	7/16"	1/16"	.048"	1/2"
10605	1"	13/32"	1-1/32"	3/4"	7/16"	1/16"	.048"	1/2"
10606	1-1/4"	13/32"	1-5/32"	3/4"	7/16"	1/16"	.048"	1/2"
10607	1-1/2"	13/32"	1-9/32"	3/4"	7/16"	1/16"	.048"	1/2"
17588*	1-3/4"	13/32"	1-13/32"	3/4"	7/16"	1/16"	.048"	1/2"
17589*	2"	13/32"	1-9/16"	3/4"	7/16"	1/16"	.048"	1/2"

*Unit Package: 10



Steel Uninsulated Closed Clamps Furnished Open

Galvanized

UNIT PACKAGE: 25

Auveco Part No.	D Inside Diameter	H Hole Diameter	L Center to Center	W Width	E Hole Center to End	F Gap	G Gauge	S Slot Length
9389	1/4"	9/32"	1/2"	1/2"	5/16"	1/32"	.032"	3/8"
9391	3/8"	9/32"	9/16"	1/2"	5/16"	1/32"	.032"	3/8"

Photos not actual size

Stop excessive coolant consumption or leakage!



20574
Engine Manifold
Repair Kit

UNIT PACKAGE: 1 Kit

2003 - 1995 GM vehicles with 3.8 L series 2 engines (VIN K - RPO L36) have been experiencing excessive coolant consumption or coolant leakage near or under the throttle body and intake manifold. This is caused when the EGR tube on the lower manifold degrades the composite material of the upper intake plenum around the passage area between the two part manifold. Once the composite material is degraded, it becomes porous and allows the coolant areas on either side of the EGR passage to leak coolant either internally or externally. If it leaks internally into the intake manifold and then the cylinders, it can result in "hydro-lock" of the engine. A simple coolant leak has resulted in a major problem that as best requires changing the spark plugs and oil in order to start the engine. That doesn't correct the cause of the problem though.

Until now, the solution has been to replace the upper plenum and lower manifold at a retail cost of \$1200 - \$1400 for parts and labor. That alone does not correct the root cause of the problem. Our 20574 repair kit offers an inexpensive but highly effective and permanent solution.

Here are the steps involved:

1. Remove the upper intake manifold.
2. Remove the EGR tube from the bottom plenum.
3. Install our new EGR port tube.
4. Use epoxy supplied with our repair kit to install our new adapter bushing in the upper plenum.
5. Reinstall the upper intake manifold.

(Detailed instructions are included with the kit)

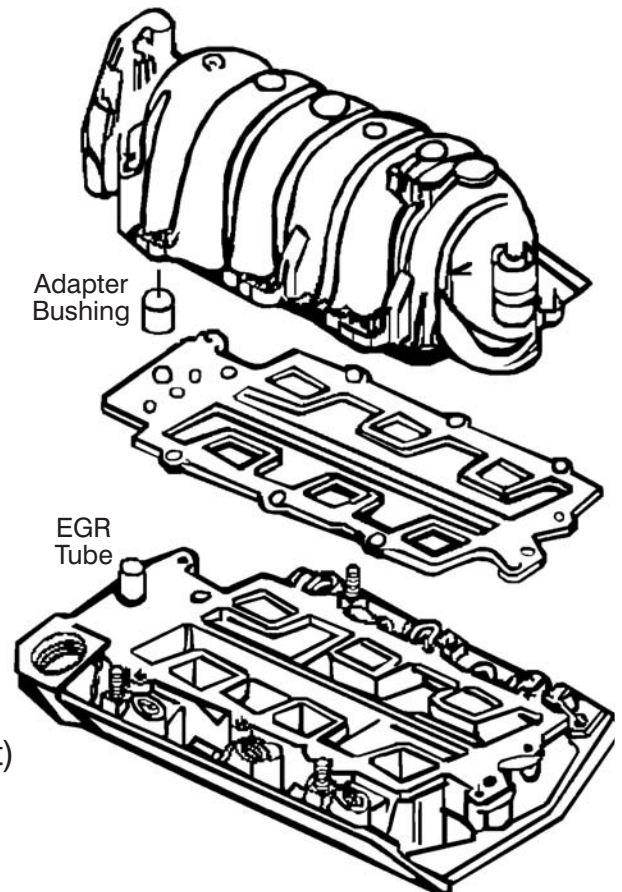

As an added benefit, the smaller diameter of our EGR port tube creates an air space between the repaired (with adapter bushing) upper plenum and the new EGR port tube. This air space insulates the composite material of the plenum from further damage.

SEALER

Photos not actual size

Automotive Body Sealer
Natural Color

1001

10.5 fluid ounces per Cartridge
(Green Colored Cartridge)

UNIT PACKAGE: 10 Cartridges

For use as a water and dust seal on exterior and interior body surfaces. New improved formula allows for a longer open time so it can be tooled for several minutes after being applied. Cures to a firm abrasion resistant seal with no cracks or peeling. Can be air dried or force dried and then painted within 30 minutes

Stands up on vertical surfaces and won't crack even in large seams.

Ideal for drip molds, interior trunk welds, exterior body seam welds and many other body seam areas.

Possesses excellent flexibility properties so it will not harden or become brittle.

Excess sealer and smears can be cleaned up with a suitable solvent before sealer dries. Sealer surface accepts all paints and must be painted. Shelf life is 6 months.

Seam-n-Joint Sealer
Natural Color

1002

11 fluid ounces per Cartridge
(Silver Colored Cartridge)

UNIT PACKAGE: 10 Cartridges

Premium quality, fast setting seam-n-joint sealer with superior adhesion for interior and exterior automotive applications (except windshields)

Its self-leveling qualities make it an excellent sealer on quarter panel seams, trunk seams, wheel house seams, floor seams, cowl seams and door skins.

1002 smooths easily so rough edges and fingerprints disappear.

Possesses superior flexibility properties, eliminating any cracking or peeling. Skin time is 1-2 minutes.

Can be painted with any type of paint in 30-60 minutes. Shelf life is 6 months.

Distributors: Auveco 1001 and 1002 can be combined for price breaks and prepaid freight.

EPOXY REPAIR KITS

Auveco-Flex Epoxy Repair Kit

1005



A two part high strength epoxy adhesive, filler and surface designed for bonding or repairing urethane bumpers, TPO Bumpers, filler panels and most other flexible plastic parts.

Working Time: Approximately 5 minutes

Sandable: 15 to 30 minutes

Paintable: 15 minutes

Cures: 6 to 8 hours

Shelf life: 12 months

Unit Package contains: Part 1 Resin (Black) & Part 2 Hardener (White)

UNIT PACKAGE: 2 Tubes (10 fl. oz kit)

Auveco-Rigid - Set Epoxy Repair Kit

1006

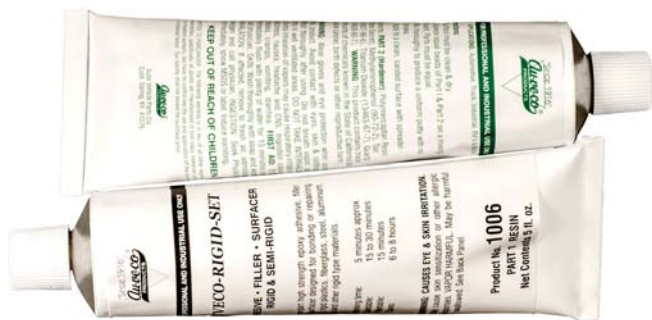

A two part high strength epoxy adhesive, filler and surface designed for bonding or repairing SMC, rigid plastics, fiberglass, steel, aluminum, glass and other rigid type materials.

Working Time: 5 minutes approximately

Sandable: 15 to 30 minutes

Paintable: 15 minutes

Cures: 6 to 8 hours

Shelf life: 12 months

Unit Package contains: Part 1 Resin (Blue) & Part 2 Hardener (Light Gray)

UNIT PACKAGE: 2 Tubes (10 fl. oz kit)

FIXITQUIK EPOXY PUTTY

Photos not actual size

Hardens like Steel in 20 Minutes

FixitQuik will plug or seal practically anything that leaks, it will patch holes and cracks. Excellent for rebuilding or fabricating parts and an all purpose adhesive for metals, wood, glass, masonry, ceramics and many plastics. It can also be drilled, tapped, filed, sanded and painted like metal. Sets steel hard in 20 minutes.



1007
1 Tube (4 oz.)

1008
1 Case (24 - 4oz. Tubes)

Hints for Use

- FixitQuik adheres to most surfaces. Best results will be achieved if area is first roughened by sanding or filing to clean and prepare surface.
 - Starts to harden 2 minutes after mixing. Repair should be in place before hardening starts.
- A smooth finish can be obtained by rubbing with wet finger or damp cloth before hardening begins.
- Can be drilled, filed, tapped sanded and machined after one hour of curing (hardening).
 - Can be painted immediately, even before full hardening.
- Usable under water. Mix as usual and use the polyethylene wrapper, so material will not stick to hands as the FixitQuik is being forced onto the wet surface.
 - Not recommended for use on polyethylene and polypropylene.
- Wash hands thoroughly with soap and water after using.

Mixing Directions

1. Break off required portion of material.
2. Twist and knead until uniform color is achieved leaving no streaks.
3. Apply at once to surface. (2 minute work life).
4. Remove excess before it hardens.

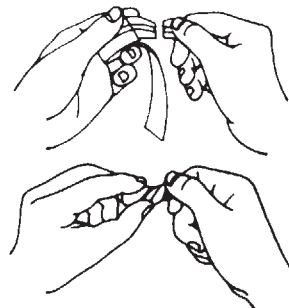

Infinite Uses

U.S.D.A. Authorized



Plumbing Repairs: Sink traps, oil and water tanks, pipe joints, drain leaks, etc.



Electrical: Use in place of tape, ceramic connectors, knobs, etc.



Ceramic Repair: Cracked porcelain wall tile, floor tile, etc.



Auto Repair: Metal Strips, small dent repairing, fuel tank, radiators, etc.



Underwater Repair: Concrete swimming pools, fish tanks, etc.



Custom Formed Gaskets: For permanent sealing and bonding.



Home Repairs: Dethreaded screws in wood or metal, picture hanging, light fixture installation, fixing loose rungs and legs on furniture, air duct leaks, etc.

Safe for lines carrying potable water.

Physical Properties

Density	15.8 lb./gal. (1.9gm/cm ³)
Compression Strength	18,000 psi
Tensile Strength	6,000 psi
Modulus of Elasticity	600,000 psi
Shear Strength	700 psi
Izod Impact	0.3 ft.-lb/in. of notch
Hardness (Shore D)	85
Maximum Use Temperature	300°F (149°C)

Electrical Properties

Volume Resistivity	5 x 10 ¹⁵ ohm-cm
Dielectric Strength	400 volts/mil @ 0.125 in.

WARNING: Harmful if swallowed, Eye irritant. Contains epoxy and amine resins. Keep away from children. If swallowed, call physician. For eyes, flush with water and call physician.

Photos not actual size

Solder Paste

Works with the head of a match, lighter, soldering iron or torch.

Five times stronger than ordinary solder. Provides strength without the distortion of high temperature brazing.

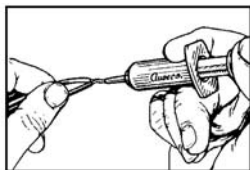

1. Apply solder paste



2. Apply heat until paste begins to bubble

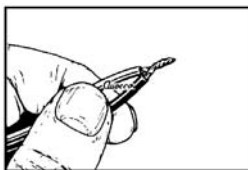

3. Solder will solidify



20409

Silver Bearing Solder Paste

For Ferrous and Non-Ferrous Metals: steel, cast iron, stainless steel, brass, bronze, nickel, platinum, chrome, monel, galvanized, gold & silver. Auto electrical systems, circuit boards, etc. Flows freely at 430° F.

Tensile Strength: 10,000 to 25,000 PSI.

7.1 grams syringe

UNIT PACKAGE: 1

20410

Copper Bearing Lead-Free Solder Paste

For use with copper. Also works on brass, stainless steel, nickel and bronze. Does not contain any lead, cadmium or antimony. Flows freely at 430° F.

Tensile strength: 10,000 to 25,000 PSI.

14.7 grams syringe

UNIT PACKAGE: 1

Weld Pins

Round Head • Copper Plated Steel

By welding these pins to a damaged body panel, a body shop technician can use a gripping tool to pull the dent out of the panel.



Pin Diameter: 2mm (.080")

Length: 2"

Head Diameter: .145"

19095: UNIT PACKAGE: 100

19096: UNIT PACKAGE: 250

19097: UNIT PACKAGE: 500

Pin Diameter: 2.5mm (.098")

Length: 2"

Head Diameter: .175"

19098: UNIT PACKAGE: 100

19099: UNIT PACKAGE: 250

19100: UNIT PACKAGE: 500

Weather-Seal Wrap



Clear, plastic film that has an adhesive on one side that is strong enough to hold the wrap in place on almost any surface and seal out contaminants. Can be easily removed without pulling off paint, leaving adhesive residue or damaging the surface.

It can seal out rain, snow, wind and dirt when windshields or door glass has been broken. Weather-Seal Wrap can be used to protect vehicle carpet and upholstery from soiling and spills. Apply it to paint booth walls and prevent over spray from discoloring white walls. Wrap has 3 mils of plastic protection to preserve finishes, it can also be used as a temporary, protective coating against light abrasions.

21077

24" wide x 200 ft. long

UNIT PACKAGE: 1 Roll

21078

36" wide x 200 ft. long

UNIT PACKAGE: 1 Roll

Moulding Tape

For mounting exterior trim, side mouldings, emblems & nameplates



- Acrylic foam tape with an aggressive, high performance adhesive on both sides.
- Works on all types of plastic mouldings & emblems
- Will not crack or dry out
- Will not absorb water
- Will not migrate in hot weather

21074

.045" thick x 3/16" wide x 60 ft.

UNIT PACKAGE: 1 Roll

21075

.045" thick x 1/2" wide x 60 ft.

UNIT PACKAGE: 1 Roll

21076

.045" thick x 7/8" wide x 60 ft.

UNIT PACKAGE: 1 Roll

MISCELLANEOUS ITEMS

Sec. 27

Photos not actual size

20791

Plastic and Headlight Resurfacer/Protector



Yellowed or cloudy headlights impair night vision. Use of this product on yellowed or discolored headlights will significantly increase the clarity of the lens giving the driver the ability to see better at night. 3 easy steps and about 15 minutes is all it takes to restore most headlights to a like-new appearance that lasts. In addition, it may be used safely on most types of plastics, windshields and more.

Kit Includes: Complete instructions, Pretreatment, Water Base Pretreatment, Oxidation Remover, Shine Restorer/Protector (Increases shine, seals & protects), gloves, sanding sheets, and lint free paper towels.

UNIT PACKAGE: 1 Kit

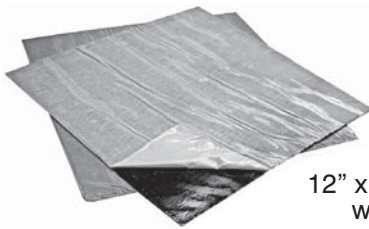

16506

Trunk Vibration/Sound Dampening Pads

12" x 12" x .060" thick pads with adhesive backs.

Can be cut to shape and painted for easy installation. The clear vinyl sheet on the black side must be removed before painting. Meets GM specification #2747M.

UNIT PACKAGE: 6

Stronghold Gloves

Micro-Knit with Nitrile Palms

- Superior Dexterity & Durability
- Excellent Gripping Power
- "Breathable" Micro-Knit
- Super Lightweight
- Machine Washable
- Seamless Comfort



20694

Size: Large

UNIT PACKAGE: 1 Pair

20695

Size: Extra Large

UNIT PACKAGE: 1 Pair

Grease Bully Chemical Resistant Black Nitrile Disposable Gloves

- 6 mil thick, 9" long
- 50% Stronger than standard disposable nitrile gloves
- Highly resistant to puncture and protects hands from solvents, grease & oils
- Reduced Perspiration
- Textured for superior grip
- Powder & Latex free



22190

Size: Medium

UNIT PACKAGE: 100 Gloves (50 pairs)

22191

Size: Large

UNIT PACKAGE: 100 Gloves (50 pairs)

22192

Size: Extra Large

UNIT PACKAGE: 100 Gloves (50 pairs)

Tiger Grip Chemical Resistant Hi-Vis Orange Nitrile Disposable Gloves

- Unique raised texture for superior grip
- 7 mil thick, 9" long
- Hi-Vis Orange color
- Highly resistant to puncture and protects hands from solvents, grease & oils
- Powder & Latex free



22186

Size: Medium

UNIT PACKAGE: 100 Gloves (50 pairs)

22187

Size: Large

UNIT PACKAGE: 100 Gloves (50 pairs)

22188

Size: Extra Large

UNIT PACKAGE: 90 Gloves (45 pairs)

22189

Size: Extra Extra Large

UNIT PACKAGE: 90 Gloves (45 pairs)

Photos not actual size

Panther Grip Chemical Resistant Hi-Vis Green Nitrile Disposable Gloves

- Unique raised texture for superior grip
- 6 mil thick, 9" long
- Hi-Vis Green color
- Highly resistant to puncture and protects hands from solvent, grease & oils
- Powder & Latex free



22193

Size: Medium

UNIT PACKAGE:
100 Gloves (50 pairs)

22194

Size: Large

UNIT PACKAGE: 100 Gloves (50 pairs)

22195

Size: Extra Large

UNIT PACKAGE: 90 Gloves (45 pairs)

Blue Nitrile Gloves

- Chemical Resistant
- 4 MIL Non-Latex
- Secure Grip - Wet or Dry
- Puncture Resistant
- Powder Free
- Fits right or left hand
- Hypoallergenic



Nitrile is resistant to chemicals commonly found in auto, auto body and glass shops including solvents, parts cleaners, paint thinners, lacquers, urethane, enamel, epoxy resins and sealants

20689

Size: Medium

UNIT PACKAGE: 100 Gloves (50 pairs)

20690

Size: Large

UNIT PACKAGE: 100 Gloves (50 pairs)

20691

Size: Extra Large

UNIT PACKAGE: 100 Gloves (50 pairs)



Rough Service

Long Life Light Bulbs

The Rough Service bulb features a special filament that withstands shock and vibration. It was designed exclusively for the automotive service industry. The brass base eliminates "freezing" or corroding in the socket; however, it will explode if it comes in contact with a liquid.

16571

75 Watt

UNIT PACKAGE: 120 (1 Case of 20 Six-Paks)



Super Toughcoat

Long Life Light Bulbs

Super Toughcoat's amazing silicon coating makes it the safest, sturdiest light bulb ever developed. Patented coating protects personnel and products from shattered glass caused by impact, dropping, unusual stress, contact with liquids and thermal shock. Brass base eliminates "freezing" or corroding in the socket.

16575

100 Watt

UNIT PACKAGE: 6

Acid Brushes

Tin Handle Horse Hair Bristles



Auveco Part No.	Width	Trim	Length	Unit Pkg.
15793	1/4"	3/4"	6"	1 Gross
15794	3/8"	3/4"	6"	1 Gross
15795	1/2"	13/16"	6"	1 Gross
15796	9/16"	7/8"	6"	1 Gross
15798	3/4"	1"	6-3/8"	1 Gross

Chip Brushes



Wood Handle Natural Bristles

Auveco Part No.	Width	Trim	Unit Pkg.
15800	1-1/2"	1-5/8" x 5/16"	5
15801	2"	1-1/2" x 5/16"	4

MISCELLANEOUS ITEMS

Photos not actual size

Chip & Dope Brush

Wood Handle Horse Hair Bristles



Auveco Part No.	Width	Trim	Length	Unit Pkg.
15799	11/16"	1-1/8"	7"	25

Steel Wire Scratch Brushes

Wood Handle



15803

Size of Block: 14" x 1"
 Rows: 3 x 19
 Trim: 1-3/16"
 Wire Gauge: 33 Gauge Steel

UNIT PACKAGE: 1



15805

Size of Block: 10" x 1-1/8"
 Rows: 4 x 16
 Trim: 1-3/16"
 Wire Gauge: 33 Gauge Steel

UNIT PACKAGE: 1



Toggle Bolts Spring Wing Type

Auveco Part No.	Head Style	Screw Dia.	Thread Size	Use Drill	Unit Pkg.
10011	Mushroom	1/8"	6-32 x 3"	3/8"	10
10012	Mushroom	1/8"	6-32 x 4"	3/8"	10
10013	Round Slotted	3/16"	10-24 x 3"	9/16"	10
10014	Round Slotted	3/16"	10-24 x 4"	9/16"	10
10018	Round Slotted	1/4"	1/4-20 x 4"	3/4"	10



Hammer Drive Anchors

Steel

Auveco Part No.	Size	Hole Size	Unit Pkg.
12858	1/4" x 3/4"	1/4"	25
12859	1/4" x 1"	1/4"	25
12860	1/4" x 1-1/4"	1/4"	10
12861	1/4" x 1-1/2"	1/4"	10



Nylon Anchor

Steel Nail

Auveco Part No.	Size	Head Style	Unit Pkg.
12870	1/4" x 1"	Mushroom	25



Hollow Wall Anchor

Drive Type

Auveco Part No.	Size	Wall Thickness	Drill Size	Unit Pkg.
12890	1/8" Long	5/8" to 7/8"	1/4"	10



Plastic Anchors

Auveco Part No.	Screw Size	Drill Size	Unit Pkg.
10005	#4 - #6	3/16"	50
12851	#8 - #10	3/16"	50
10006	#10 - #12	1/4"	50
12852	1/4" - 5/16"	5/16"	50



Lag Screw Shields

Auveco Part No.	Screw Size	Length	Drill Size	Unit Pkg.
9994	3/8"	Long	5/8"	10



Hollow Wall Anchors

Auveco Part No.	Size	Wall or Surface Thickness	Unit Pkg.
10008	1/8" Long	5/8" to 1-1/4"	10
10009	3/16" Short	1/8" to 5/8"	10
10010	3/16" Long	5/8" to 1-1/4"	10
12832	1/4" Long	5/8" to 1-1/4"	10

Hollow Wall Toggle with Screws



Auveco Part No.	Toggle Size	Screw Length	Hole Size	Unit Pkg.
12833	1/8"	2"	3/8"	10

Photos not actual size

Screw Pin Anchor Shackles

Weldless Drop-Forged Galvanized Stud with Alloy Pin



12184

Size: 5/16"
 Length Inside: 1-1/4"
 Dimensions Between Eyes: 9/16"
 Diameter Pin: 3/8"
 Safe Working Load (Tons): 3/4"

UNIT PACKAGE: 1



**Nylon
 Spacer Bushings
 Stand-Offs**

Tough and resilient white nylon spacer bushings are ideal for use in electrical and electronic applications or anywhere a slip surface is needed. They can be used as bushings, bearings, rollers, glides or separators.

Auveco Part No.	I.D.	O.D.	Length	Unit Pkg.
16198	.257"	1/2"	1/4"	100
16200	.257"	1/2"	3/8"	100
16202	.257"	1/2"	1/2"	100
16204	.257"	1/2"	5/8"	100
16205	.257"	1/2"	3/4"	100
16207	.257"	1/2"	1"	100

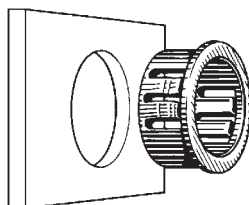

Standard Insulating Bushings

Nylon bushings designed to protect wires, cables, tubing, etc. from sharp, unfinished panel edges. Each size bushing employs multiple lock features to positively snap into panels ranging from 1/32" to 1/8" thickness. Available in both black and white nylon.



Auveco Part No.		Dimensions			Panel Hole Dia.
Black Nylon	White Nylon	Inside Dia.	Head Dia.	Thick-ness	
Unit Package: 50					
16087		1/4"	15/32"	13/32"	3/8"
16088		3/8"	37/64"	13/32"	1/2"
16089		7/16"	21/32"	13/32"	9/16"
16090		1/2"	23/32"	13/32"	5/8"
16091		5/8"	27/32"	13/32"	3/4"
16092		11/16"	61/64"	29/64"	7/8"
16093		3/4"	1-1/8"	29/64"	1"
16094		15/16"	1-7/32"	29/64"	1-3/32"
16095		15/16"	1-23/64"	29/64"	1-1/4"

Auveco Part No.		Dimensions			Panel Hole Dia.
Black Nylon	White Nylon	Inside Dia.	Head Dia.	Thick-ness	
Unit Package: 25					
16096	16108	1-5/16"	1-39/64"	29/64"	1-1/2"
16097		1-5/8"	2-1/8"	29/64"	2"



**ALL-FIT
 Adjustable Bushings**

Black nylon ALL-FIT Adjustable Bushings are designed to protect wire, cable, tubing or irregular shaped items from sharp, unfinished edges. The specially designed resilient multiple supports absorb shock and vibration, and adjust to accept various diameters and shapes. The Bushing is equipped with multiple locks to snap in panel thicknesses ranging from 1/32" to 1/8"

Auveco Part No.	Panel Hole Dia.	Bushing Dimensions			Unit Pkg.
		Head Dia.	Thick-ness	Max. I.D.	
16564	5/8"	23/32"	13/32"	7/16"	50
16565	3/4"	55/64"	25/64"	1/2"	50
16567	7/8"	15/16"	29/64"	9/16"	50
16568	1"	1-1/16"	29/64"	3/4"	50

ORDER BY FAX

Auveco has custom fax order forms available.

This order form ensures that your fax includes all the necessary information needed for Auveco to quickly process your order.

You can request fax order forms by calling customer service at 1-800-354-9816

ORDER ONLINE

Auveco's website has been completely renovated. Our new design is user friendly and allows quick and easy ordering.

Product is searchable by car make, OEM number and category, as well as, several attribute drop downs within individual categories. All product also has available inventory listed.

Make sure to head over to

www.auveco.com

to receive up to date information on all our products.

MISCELLANEOUS ITEMS

Photos not actual size



Clear Flexible Vinyl (PVC) Tubing

Our tubing has a broad range of chemical resistance to acids, alkalis and solvents. It's ideal for use in industrial air pressure line applications, in the food industry (FDA approved), for potable water, and for various gases and chemicals.

Auveco Part No.	I.D.	O.D.	Wall Thickness	*Max. Suggested Pressure PSI @ 70° F
14801	1/8"	1/4"	1/16"	59
14802	3/16"	5/16"	1/16"	51
14803	1/4"	3/8"	1/16"	51
14804	5/16"	7/16"	1/16"	48.
14805	3/8"	1/2"	1/16"	41
14807	1/2"	5/8"	1/16"	28
14808	1/2"	3/4"	1/8"	41

Each 100ft UNIT PACKAGE

**We recommend verification by testing of the size and material to be used.*

Pushnut Fasteners

Axle Caps

- Cover Color - Black
- Cover Material - Plastic
- Caps self-align on shafts
- Low push-on force, high retention
- Fast installation



14178

Shaft Diameter: 3/16"
 Cap O.D., W: .656
 Overall Height, H: .344
 Min. Shaft Extension, A: .150
 Steel Thickness: .012
 Min. Push-on Force: 35
 Min. Holding Strength: 220

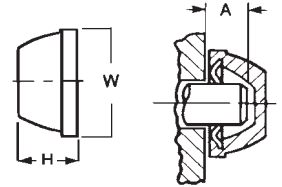

UNIT PACKAGE: 50



"Nipper" Wire Rope Clip

Galvanized Malleable Iron Base
 Zinc Plated Stud U-bolt

Auveco Part No.	Use with Rope Diameter	Diameter	U-Bolt Dimensions Length Overall	Center to Center	Unit Pkg.
12171	1/8"	3/16"	1"	1/2"	6
12172	3/16"	1/4"	1-1/16"	9/16"	6
12173	1/4"	5/16"	1-1/2"	11/16"	6
12177	1/2"	7/16"	2-3/8"	1"	4

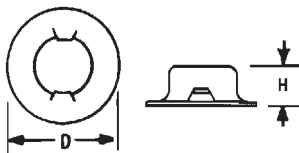

Washer Cap Type Pushnut Fasteners

Zinc Finish



Auveco Part No.	Steel Thickness	Height H	Cap Diameter	Washer Diameter D	Stud Diameter	Performance Pounds		Unit Pkg.
						Push-On Force	Min. Holding Strength	
14170	.018	.205	.289	1/2	1/4(.250)	65	280	100
14171	.020	.236	.358	5/8	5/16(.312)	90	460	100
*8719	.020	.234	.419	11/16	3/8(.375)	70	380	100
14172	.025	.270	.431	3/4	3/8(.375)	90	700	100
14173	.030	.328	.504	7/8	7/16(.438)	150	960	100
8665	.030	.328	.567	15/16	1/2(.500)	150	800	100
14174	.031	.413	.693	1-3/16	5/8(.625)	230	1500	50

*Nickel Plated

Photos not actual size

Push-Pull Controls



14541

5' Long Choke Control
Black Knob
Body Thread: 3/8"-24
Wire Diameter: .047"

UNIT PACKAGE: 1

20243

8' Long Choke Control
Black Knob
Body Thread: 3/8"-24
Wire Diameter: .054"

UNIT PACKAGE: 1



Mechanics Wire

Soft Annealed
Black Steel Wire

Auveco Part No.	Wire Gauge	Wire Length	Unit Pkg.
14205	18	2 LB. (332')	1 Spool
14206	16	2 LB. (192')	1 Spool
14207	18	5 LB. (831')	1 Spool
14208	16	5 LB. (480')	1 Spool

Perforated Hanger Strap

Hot Rolled Galvanized Steel

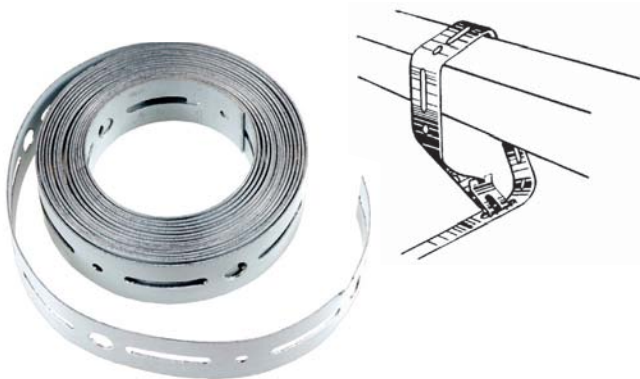

14926

Gauge: 28
3/4" Wide x 10 Ft.

UNIT PACKAGE: 1 ROLL

14927

Gauge: 24
3/4" Wide x 10 Ft.

UNIT PACKAGE: 1 ROLL

Gas Pump Nozzles

Rebuild-able



16294

For Unleaded
(No Lead) Gas
Blue Scuff Guard
Female Thread: 1"

UNIT PACKAGE: 1



16296

"Throwaway Nozzle"
For Unleaded
(No Lead) Gas
Blue Scuff Guard
Female Thread: 3/4"

UNIT PACKAGE: 1

Gas Pump Swivel

C.A.R.B. Approved

Minimum Pressure Drop: Less Than 1PSI @ 10GPM



16299

3/4" Male x 3/4" Female

UNIT PACKAGE: 1

**Gas Pump Fail-Safe
Breakaway Hose Coupling**

C.A.R.B. Approved • 360 Degree Swivel
1.5 Pound Pressure Drop @ 10GPM



16303

Diameter: 3/4"

UNIT PACKAGE: 1

MISCELLANEOUS ITEMS

Photos not actual size

Sec. 27



Expansion Plugs

Zinc Plated



Auveco Part No.	Size	Type	Unit Pkg.
3937	1/2"	Concave	100
3938	5/8"	Concave	100
3939	3/4"	Concave	100
3941	15/16"	Concave	100
3942	1"	Concave	100
3944	1-1/8"	Concave	100
3945	1-3/16"	Concave	100
3946	1-1/4"	Concave	100
3949	1-5/8"	Concave	50
3950	1-3/4"	Concave	50
3952	7/16" O.S.	Cup	25
3953	1/2"	Cup	25
3956	5/8"	Cup	25
3957	3/4"	Cup	25
3958	7/8"	Cup	25
15212	15/16"	Cup	50
3960	1"	Cup	25
3961	1-1/8"	Cup	25
3962	1-7/32"	Cup	25
3963	1-1/4"	Cup	25
3964	1-3/8"	Cup	25
3965	1-1/2"	Cup	25
3966	1-5/8"	Cup	25
3967	1-3/4"	Cup	25
3968	1-7/8"	Cup	25
3969	1-15/16"	Cup	25
3971	2"	Cup	25

See page 149 for Metric Expansion Plugs. For an Assortment of Expansion Plugs see Kit No. 6067

14461

(Chry: 2534814)
Plain

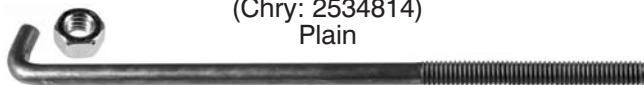

Battery Hold Down Bolt with Nut
Size: 1/4"-20 x 7"
Thread Length: 2"

UNIT PACKAGE: 10

8971

(Chry: 2074089)
Plain

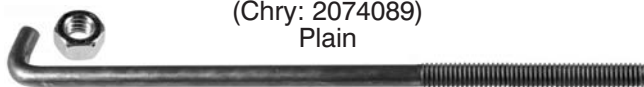

Inside Battery Hold Down Bolt with Nut
Size: 1/4"-20 x 9"
Thread Length: 2-1/4"

UNIT PACKAGE: 10

8963

(GM: 3688699)
Plain

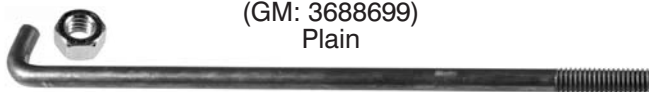

Battery Hold Bolt with Nut
Size: 5/16"-18 x 8"
Thread Length: 1"

UNIT PACKAGE: 10

10643

Zinc



Battery Hold down Bolt with Nut
Size: 5/16"-18 x 12"
Thread Length: 6"

UNIT PACKAGE: 10

10644

Plain



Battery Hold Down Bolt with Nut
Size: 3/8"-16 x 10"
Thread Length: 3"

UNIT PACKAGE: 10

LOOKING FOR A CABINET OR RACK?

We have a variety of cabinets, racks and other organizational containers and items. Located in the green section.

The green section also contains several different types of assortments. Our assortments contain groups of items most commonly used together.

Photos not actual size

7914

Windshield reveal moulding tool



Used to remove windshield reveal moulding from retaining clips on GM vehicles with rubberless installations

UNIT PACKAGE: 1

13574

Glass Retainer Clip Installer



This tool reduces the risk of chips and scratches to glass windows put in by make shift tools. This tool is specifically designed to fit trim clips over the studs and virtually eliminates glass breakage. It also dispenses with the need to remove rubber-like sealant surrounding the studs.

A practical tool for placing trim retainer clips over headed studs welded around the body window shields and rear window openings.

UNIT PACKAGE: 1

20906

Windshield Locking Strip Tool

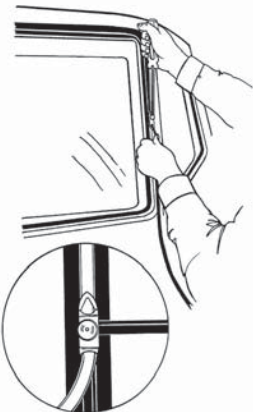

This tool is used when replacing the windshield, rear glass or sliding rear glass on vehicles with locking strips. The unique design allows the tip to swivel 90 degrees in either direction to work where other tools can't. Just select the tip with the opening that most closely fits the locking strip and then feed the locking strip into the eyelet. Overall length: 8-1/4"

UNIT PACKAGE: 1

20907

Windshield Wiper Arm Remover



Makes wiper arm removal and replacement an easy job without damaging the vehicle finish. Simply place the "hook" under the arm base, lift and squeeze the wiper arm and tool handle together.

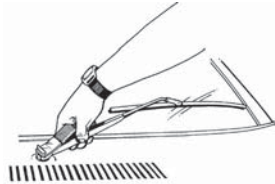

The wiper arm lifts right off.

Reverse the procedure to install a wiper arm. Overall length: 6-7/8"

UNIT PACKAGE: 1

7778



For removing window crank handle retaining clips. The clip remains in the handle after being "popped off". Overall Size: 6-1/4"

UNIT PACKAGE: 1

7999



The Trim Pad Removing Tool is the first tool designed specifically to pull out the plastic trim pad fasteners used on GM cars. It reaches under the trim panel, supports and grips the plastic fastener, and lifts it without damage to the fastener or to the trim pad backboard. The Trim Pad Removing Tool is made of heat treated, high carbon steel and will work equally well on metal fasteners.

UNIT PACKAGE: 1

7672



Headliner Tool stuffs headlining in channel above doors. Stuffs upholstery, trim edges into tedious places. Blunt edge of blade cannot damage material. Easy to use around curves and near corners.

UNIT PACKAGE: 1

13575



For tucking headlining and upholstery around windows and above doors and other hard to reach places. A sturdy tool with a slightly curved blade that has finished edges and rounded corners. Comfortable wood handle with eyelet hole through one end.

UNIT PACKAGE: 1

15301

Clip Removal Tool



The right tool for removing clips and retainers quickly and easily. Simply seat the tool on the shaft of the fastener and squeeze the handles together. Made of high carbon steel and heat treated for strength. Zinc plated with vinyl molded handle grips.

UNIT PACKAGE: 1

13578

Auto Trimmers & Upholsterers
Combination Knife



Made of finest steel with both hook and pointed blade used for ripping seams. Cuts auto and home carpeting, vinyl, plastic and rubber.

Beechwood handle contoured to fit hand. A handy professional tool.

UNIT PACKAGE: 1

17978

Mini Plastic Scraper
With Razor Blade



Scraper with razor sharp edge cuts or scrapes paint, stickers, cardboard, string, etc. Flip a latch and turn the razor blade over to safely store the scraper.

UNIT PACKAGE: 5

13626



A unique retractable scraper that takes the aggravation out of getting old stickers off car windshields and paint blotches off windows. The scraper is 7-7/8" when fully open and locked in position. The razor blade holder tilts the blade to give a better angle of attack in tight corners. The blade can be folded 180 degrees into the handle and locked when not in use, permitting it to be kept in a tool box safely. The blade can be replaced when worn out and the entire tool is compact and durable as well as economical.

UNIT PACKAGE: 1

13625

Single Edge Razor Blades
For use with 13626 and
General Purpose



UNIT PACKAGE: 100

Polypropylene Blades

Remove stickers from plastic-coated windshields without risk of scratching or cutting the windshield.

Made of polypropylene, these blades are also ideal for scraping many other surfaces in automotive, industrial and home applications. Use with tool 13626



14543: UNIT PACKAGE: 25
14575: UNIT PACKAGE: 100
14576: UNIT PACKAGE: 1,000

20823

Extra Long Sticker Scraper



Specially designed to access steep, sloping windshields and other hard-to-reach places. Excellent for corners and on curved surfaces. Supplied with 5 standard steel razor blades and 1 plastic blade. Use the plastic blade on laminated windows and plastic bumpers. Extra blades are stored in the handle. Heavy duty construction. Overall Length: 16"

UNIT PACKAGE: 1

Photos not actual size

13572



All purpose awl used in the installation of roof windows, windshield rubber and back glass. It is used to remove body clips, mouldings and for spring pulling and cotter pin extracting or for radiator hose removal.

Great for hard to reach places. Tempered end.

Hook: 1-1/4"

Blade: 4-1/2"

Overall Length: 8-1/2"

UNIT PACKAGE: 1

13579

Heavy Duty Scratch Awl



3-1/2" blade with rugged plastic handle.

UNIT PACKAGE: 1

20903

O-Ring and Seal Pick



Quickly removes and installs O-Rings and seals.

Tips are angled for hard-to-reach areas typically found around brakes, air conditioning and transmissions.

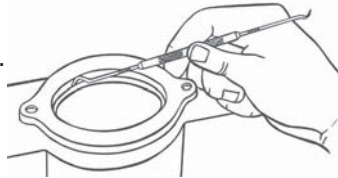

The tips are hardened to stay sharp. The handle is knurled for a sure grip.

Overall Length: 8-3/4"

UNIT PACKAGE: 1

17088



All purpose awl with an extra long hook. Use to remove mouldings, body clips, windshield seals, cotter pins and radiator hoses. Made of tough spring steel, heat treated, tempered and plated.

4-7/8" long blade with 2" long hook.

Overall length: 8"

UNIT PACKAGE: 1

18335

Prep Pen (Spot Sanding Pen) with Glass Fibers

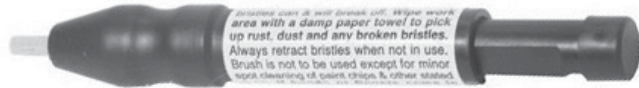

Thoroughly clean rust, dirt or wax from any tight corner, crevice or hard to reach spot with 20,000 glass fibers in a pen point. Fibers finer than human hair and stronger than steel when it comes to cleaning power.

Sand paper can be too rigid to directly contact and clean the contours of inside edges. Thus conventional sanding only cleans the high spots. The Prep Pen's glass fibers can be extended out (by turning) to ensure even the smallest recesses get cleaned.

UNIT PACKAGE: 1

20902

Constant Tension Band (Flat Band) Hose Clamp Pliers

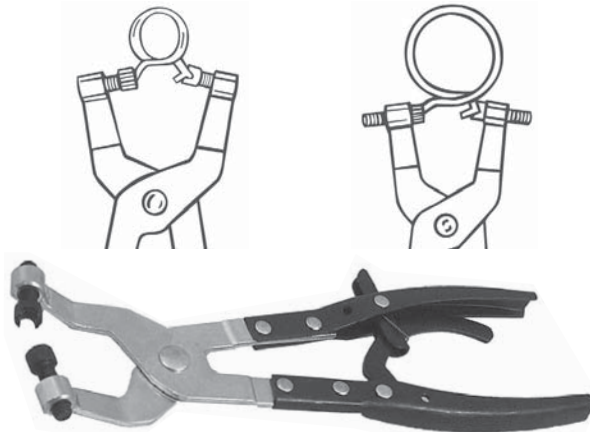

Removes and installs hose clamps (Auveco part numbers 18127 - 18132) on heater and radiator hoses. Tips screw in and out to fit all sizes of clamps. Ratcheting lock mechanism holds the clamp in an open position for easy removal and installation.

Tips can be switched to accommodate different applications. Offset jaws allow access to hard-to-reach areas.

UNIT PACKAGE: 1

7657
Hog Ring Plier



Straight Nose Spring Grip, holds rings in place for fast work.

UNIT PACKAGE: 1

7658
Hog Ring Plier



Offset Angle Nose for close to floor non-removable cushions.

UNIT PACKAGE: 1

Convertible Retaining Ring Pliers
For Internal and External Retaining Rings

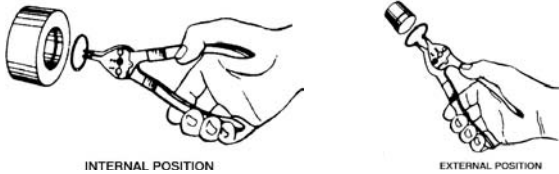

Use with
Auveco Retaining Rings:
8677 - 8678 External
8688 - 8697 Internal
8700 - 8709 External
10116 - 10121 External

UNIT PACKAGE: 1

7910



Use with
Auveco Retaining Rings:
8679 - 8683 External
8698 - 8699 Internal
8710 - 8712 External
10122 - 10129 External
16743 - 16748 External

UNIT PACKAGE: 1

20905
Hood Prop



Unique 3-Piece telescoping design allows a mechanic to hold open the hood in any desired position from 18-1/2" to 46-3/4". It can be used either in the front of the vehicle or on the side for better access to the engine compartment. Also great for body or repair work on doors, trunk lids and hatchbacks.

Overall length: 18-1/2"

UNIT PACKAGE: 1

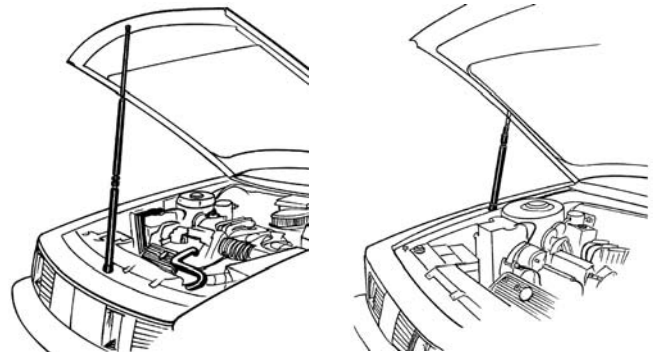

Torx® Power Drive Bits
1" Shank

Auveco Part No.	Bit Size	Hex Size	For Screw Size	Unit Pkg.
12472	T-10	1/4"	No. 4	1
11949	T-15	1/4"	No. 6	1
11950	T-20	1/4"	No. 8	1
12103	T-25	1/4"	No. 10	1
14913	T-27	1/4"	No. 12, 1/4"	1
12104	T-30	1/4"	1/4"	1
12105	T-40	1/4"	5/16"	1
14916*	T-55	5/16"	1/2", 9/16", 5/8"	1

*1-1/4" Shank



Torx® Power Drive Bits
2" Shank

Auveco Part No.	Size	For Screw Diameter	Unit Pkg.
12474	T-15	6	1
12475	T-20	8	1
12477	T-30	1/4"	1

Photos not actual size



Fold-Up Hex Key Set

Auveco Part No.	Size	Keys	System	Unit Pkg.
7976	Small .050" thru 5/32"	8	U.S.	1
7977	Medium 5/64" thru 1/4"	9	U.S.	1
7978	Large Extra Long 3/16" thru 3/8"	5	U.S.	1



Hexagon Shank Magnetic Chuck

for Driving Screws into Metal with an Electric Drill.

Auveco Part No.	Hex Head Shank	Screw Size	Unit Pkg.
7767	1/4"	1/4"	1
11761	1/4"	5/16"	1
11762	1/4"	3/8"	1

Hex Keys

Auveco Part No.	Socket Screw Size	Wrench Size	Unit Pkg.
5414	No. 6	1/16"	10
5415	No. 8	5/64"	10



Metric Hex Key

Plain Finish
Use with DIN 912 & DIN 7991

Auveco Part No.	Hex Size	For Screw Size	Unit Pkg.
7965	3mm	4mm	10

Torx® Tool Selection Chart

Auveco Part No.	Size	Pan Head Struck Slot Screw Size	Head Screw Size								
			Round Washer	Pan	Flat	100 Flat	Hex	Hex Washer	Truss	Fillister	Oval
12472	T-10	4 & 5	4 & 5	4 & 5	5 & 6	6	4 & 5	5	6	4 & 5	5
11949	T-15	6	6	6	8	8	6	6	8	6	6
11950	T-20	8	8	8	10	10	8	8	10	8	8
12103	T-25	10	10	10	12		10	10	12	10	10
14913	T-27	12	12	12	1/4		12	12	1/4	12	12
12104	T-30	1/4	1/4	1/4		1/4	1/4	1/4		1/4	1/4
12105	T-40	5/16		5/16	5/16 & 3/8	5/16	5/16	5/16	5/16	5/16	5/16
	T-45	3/8		3/8		3/8	3/8	3/8	3/8 & 7/16	3/8	3/8
	T-50	7/16		7/16	7/16 & 1/2	7/16			1/2	7/16	7/16 & 1/2
14916	T-55	1/2		1/2	9/16 & 5/8	1/2			9/16 & 5/8	1/2 & 9/16	9/16 & 5/8
	T-60				3/4				3/4	5/8	3/4

TOOLS

Photos not actual size



Plain White Boxes

No Imprinting

White-recycled chipboard versions of six popular sizes of Auveco boxes for packaging small parts. Each box is made of .028" thick chipboard. The full-flap, hardware bottom with locking side tabs provides for a full-strength, spill-proof box. Refer to the chart below for the quantity of boxes per unit package carton.

Auveco Part No.	Length (L)	Width (W)	Height	Boxes Per Carton	Weight Per Carton (lbs.)
0-Boxes	2-3/4"	1-1/2"	1-3/4"	1050	30
1-Boxes	2-3/4"	2-1/4"	1-7/8"	800	33
2-Boxes	3-3/8"	2-7/8"	2"	375	23
3-Boxes	3-1/2"	2-7/8"	2-7/8"	250	19
4-Boxes	4-3/4"	2-3/4"	3"	250	21
7-SBoxes	4-1/4"	3"	6-1/2"	425	55

Professional Drill-Out® Broken Bolt Extractor Kit

Take the frustration out of removing broken Bolts.
Made in U.S.A.



17093

- Incredible improvement over traditional methods of extracting broken bolts
 - Easy, time saving operation
 - Fast and reusable
 - Self-centering tip

For grade 5 and grade 8 bolts in sizes:
1/4" (6mm), 5/16" (8mm), 3/8" (10mm) & 1/2" (12mm)

UNIT PACKAGE: 1

Replacement Extractor Tools



Auveco Part No.	Drill Size
20537	1/4" (6mm)
20538	5/16" (8mm)
20539	3/8" (10mm)
20540	1/2" (12mm)

Fast & Easy to Use

Always use Protective Eye Wear when Drilling

The Drill-Out® Broken Bolt Extractor is excellent for removing broken bolts and studs without damaging the threads in the hole. The drill body is manufactured using the finest quality hi-speed steel. The collet is produced from hot die steel, using the finest steel of its type. All Extractors are made with a precision ground 118° left hand cutting self-centering point, and are heat treated for toughness.

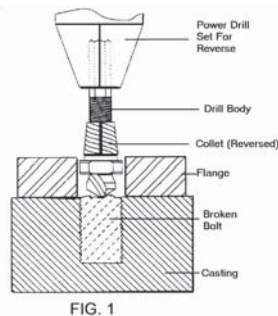

FIG. 1

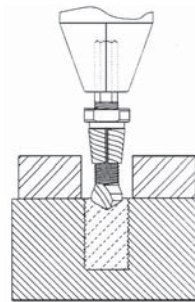

FIG. 2

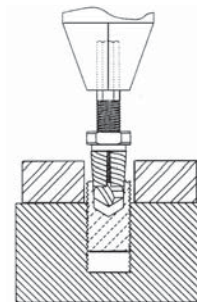

FIG. 3

- 1: Place the Drill-Out® tool into an electric drill and set for reverse operation. Move the collet up to the chuck.
Note: when the bolt is broken below a flange attached to a casting, reverse the collet as in (Fig. 1.)
- 2: Making sure the drill is set in reverse, place the tip of the Drill-Out on the center of the broken bolt and begin drilling. Do not allow the collet to move down towards the tip while drilling. If so, thread the collet back towards the chuck. Drill just deep enough to start a hole (approximately 1/16").

- 3: Make sure the hole is started on center of the bolt. If you reversed the collet in step 1, change it back at this time. Continue drilling. Stop just before you reach the front of the collet. Do not let the collet touch the end of the bolt. (Fig.2)
- 4: Remove the Drill-Out tool from the broken bolt. Move the collet down towards the tip so that 2 threads are showing. Bring drill up to speed and plunge it into the hole. The collet automatically engages and extracts the broken bolt. (Fig.3)

Detailed instructions included in the kit.

Photos not actual size



15748
Moulding Cutting Tool

A professional quality tool that cuts with absolute accuracy every time to give a clean, accurate and precise edge. This tool features a replaceable razor-sharp blade, which cuts against a plastic anvil, also replaceable. Excellent for cutting rubber/plastic moulding (up to 3-1/2"), weatherstrip, carpeting and most flexible materials. The tool measures 10" overall and the handles are vinyl coated.

UNIT PACKAGE: 1



20900
Hose Cutter

Razor sharp blade cleanly cuts heater hoses, fuel line hoses and any other type of flexible hose up to 1-1/4" diameter. The stainless steel blade is reversible for double the life. The pliers are made of glass-filled gray nylon for strength. Includes a locking hoop for safe storage. Overall length: 9-1/2"

UNIT PACKAGE: 1

21511

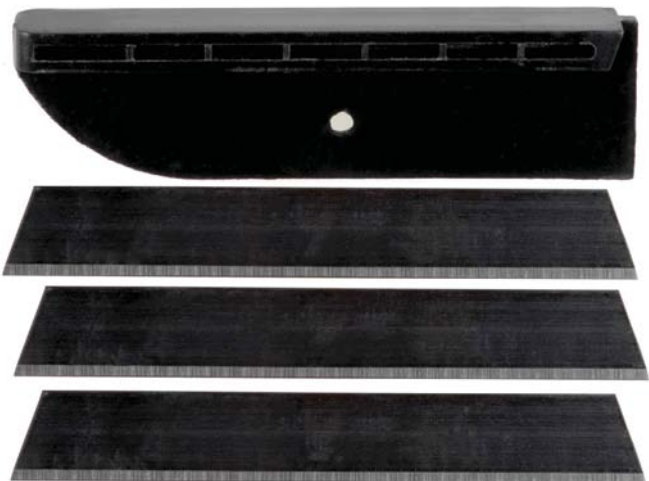

Three replacement cutting blades and one anvil for Moulding Cutting Tool 15748

UNIT PACKAGE: 1 KIT

21152

U.S.S., S.A.E. & Metric Bolt and Nut Gauge

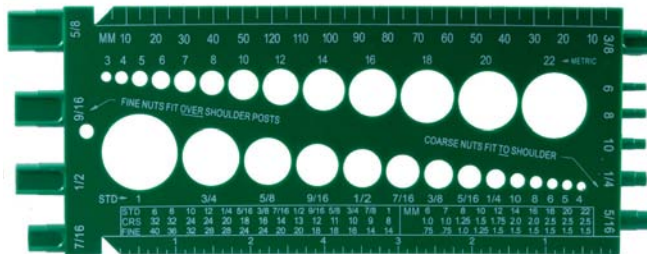

Excellent for sizing bolts, screws, nuts (USS, SAE, and Metric) and twist drills. Determine the bolt diameter by pushing the bolt through the sizing holes, as well as, gauges hex nuts and washers (USS & SAE) size. Metric hex nuts and washers can be measured by holding them under the metric holes.

The back includes a feature for measuring U.S. and Metric thread pitch. Notches on the front allow you to measure flat head metal and wood screws.

Made of sturdy, light weight green plastic that resists water, alcohol, oil and grease.

UNIT PACKAGE: 1

14769

U.S.S. & S.A.E. Plastic Gauge

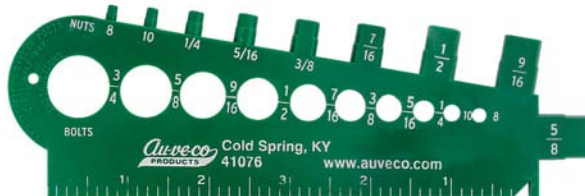

Push bolts through the holes to find the bolt diameter. The length gauge measures "regular" heads from the left end and countersunk heads from the right end notched. Nuts drop on the plugs along the top of the gauge. S.A.E. fine thread nuts fit to the base of the plugs, U.S.S. coarse thread nuts fit half-way.

UNIT PACKAGE: 1

14770

Metric Bolt & Nut Gauge

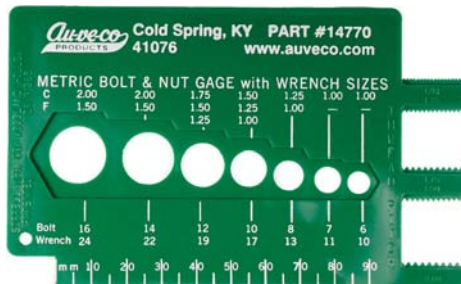

Determine the diameter of the bolts by pushing them through the holes. Measure the hex head of bolts and screws or the "across the flat" dimension of hex nuts in the recesses around the holes (listed as wrench size).

Right-hand side of tool measures thread pitch (1.00, 1.50, 1.75 & 2.00)

UNIT PACKAGE: 1

TOOLS

Photos not actual size

Sec. 28

Aluminum Oxide Resin Bonded Cut-Off Wheels

Designed for steel cutting use only.
Never use these wheels for any other applications.
Never use on Fiberglass!

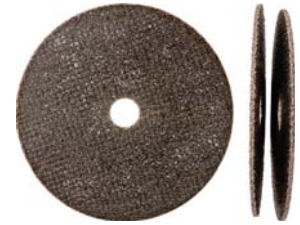

Auveco Part No.		Diameter	Thickness	Arbor	Grit	RPM
Unit Pkg. 10	Unit Pkg. 25					
19688	19687	3"	1/16"	3/8"	54	25,000
19690	19689	3"	1/32"	3/8"	54	25,000
19692	19691	3"	1/16"	1/4"	54	25,000
19694	19693	3"	1/32"	1/4"	54	25,000
19696	19695	3"	1/8"	1/4"	46	25,000
19698	19697	3"	1/8"	3/8"	46	25,000
19702	19701	4"	1/32"	3/8"	60	21,000
19706	19705	4"	1/16"	3/8"	54	21,000



General Purpose Depressed Center Wheels TYPE 27 • Standard Shape

The most popular Raised Hub wheel for grinding and blending

CAUTION!

- Never use a wheel that has been dropped
- Always wear full face protection when grinding
- Use a guard covering 50% or more of wheel diameter

Auveco Part No.		Diameter	Thickness	Arbor	Grit	RPM
Unit Pkg. 10	Unit Pkg. 25					
19712	19711	4"	1/4"	5/8"	36	13,700
19714	19713	4-1/2"	1/4"	7/8"	24	11,900

Cut-Off Wheel Mandrels Arbors for Air Grinders



19715
Zinc

Mandrel with
3/8" Shoulder Screw

UNIT PACKAGE: 1



19716
Zinc

Mandrel with
1/4" & 3/8" Shoulder Screws

UNIT PACKAGE: 1

Heavy Duty Industrial Flashlights

Heavy duty construction for a long life
in a tough industrial environment.
Water, shock and corrosion resistant.
Flashlights requires two D cell batteries (not included).

16168



Fixed magnet plus Magna-Beam
reflector which covers 10 times
the normal area.
Includes a spare bulb.
Length: 8-1/2"

UNIT PACKAGE: 1

16169



Contains super-bright krypton
bulb. Burns 70% brighter
than ordinary bulb.
Magna-Beam flood
reflector covers 10 times
the normal area.
Length: 8-1/2"

UNIT PACKAGE: 1

Photos not actual size

18245

“Stubby” Fluorescent Work Light



With a 2” diameter and 9-3/4” length the “Stubby” is a compact, bright work light that provides 13 watts of high intensity light. The 13 watt light bulb is equivalent in light output to a 100 watt incandescent bulb while being four times more efficient and lasting up to ten times longer (10,000 hours).

Protected on-off switch can be operated by depressing domed end of the light. Oil resistant type SJTOW-A 25 foot cord set is specially designed to stay flexible in cold weather.

UNIT PACKAGE: 1

18246



Rough service replacement fluorescent light bulb for 18245 “Stubby” work light. 13 watt, 110 volts.

UNIT PACKAGE: 1

16894

Wire Bending Tool
For Truck Seat Springs



A tough tool that makes difficult wire repairs easy. You can bend the ends of no sags, edgewise and foam springs right on the spot, making offsets where you need them. Can be readily mounted in a vise for duplicating complex repetitive wire bends. Constructed of heat-hardened steel for long life.

UNIT PACKAGE: 1



16275

One-Hand Grease Gun
3-Way Loading
Uses 14.5 oz. Cartridge
16 oz. Bulk Capacity
2500 PSI Working Pressure
3 Claw Coupler

UNIT PACKAGE: 1

16277

Zinc with Black
Rubber Grip



Professional Grease Gun
Delivers Grease at various Lever Openings
3-Way Loading
Uses 14.5 oz. Cartridge, 16 oz. Bulk Capacity
Variable Pressure
4 Claw Coupler

UNIT PACKAGE: 1

16276



Heavy Duty Grease Gun
3-Way Loading
Uses 14.5 oz. Cartridge, 16 oz. Bulk Capacity
10,000 PSI Working Pressure
3 Claw Coupler

UNIT PACKAGE: 1

Grease Gun Hoses

1/8” NPT Male Fittings



Auveco Part No.	Length	PSI	Unit Pkg.
15691	12”	3000 PSI	1
15692	18”	3000 PSI	1
16279	12”	5800 PSI	1
16280	18”	5800 PSI	1

16667



This professional gun is fabricated from die cast alloy and steel, both riveted and welded for maximum strength. It features a smooth hexagonal drive rod and precision catch plate for effortless action. The handle and trigger are designed for comfortable operation over a long period of use. Corrosion resistant orange epoxy powder coated.

UNIT PACKAGE: 1

17123



This deluxe heavy duty caulkung gun ensures operator comfort and efficiency of use. It has a die-cast alloy, profiled hand grip for strength and lightness, which is contoured for use by all hand sizes and allows the use of smooth, full strokes.

The advanced design of the drive mechanism has a patented catch plate system. Combined with use of a hardened steel drive rod, this prevents notching and scoring of the rod.

UNIT PACKAGE: 1

13577

Revolving Punch



A fine quality pressed frame revolving punch with drive tubes. All tubes are heat treated to give long wear. Fully nickel plated.

Furnished with tube sizes 0, 1, 2, 3, 5, and 7 (Hole sizes 5/64", 3/32", 7/64", 1/8", 5/32", and 3/16") Length: 8"

UNIT PACKAGE: 1

16293

Suction Gun



Designed for all purpose draining and filling clutches, differentials and transmissions. Use with any type of non-corrosive lubricants. Needs no priming. One pint capacity. Comes with 11" flexible vinyl hose.

UNIT PACKAGE: 1

Oil Cans



16286

Capacity: 6 oz.
Rigid Spout: 4"
Brass Pump, Steel Body

UNIT PACKAGE: 1



16288

Capacity: 12 oz.
Rigid Spout: 5"
Brass Pump, Steel Body

UNIT PACKAGE: 1

HAVE YOU VISITED US ONLINE?

Auveco's website has been completely renovated. Our new design is user friendly with easy navigation and ordering.

Product is searchable by car make, OEM number and category, as well as, several attribute drop downs within individual categories. All product also has stock availability listed.

Make sure to head over to www.auveco.com to receive up to date information on all our products.

O.E.M. INTERCHANGE BY MANUFACTURER

The O.E.M. numbers listed in this interchange are cross referenced to the closest equivalent Auveco part. In some instances, the parts are not identically the same. There may be slight differences in the finish, length or washer outer diameter: however, the Auveco part is designed to service the same application.

This interchange is arranged numerically within each manufacturer. OEM numbers are in ascending order regardless of the number of digits in each O.E.M. number. Thus every number that begins with a 1 is listed before any number that begins with a 2. You should key on the first four digits to locate the number. For example, 1121865 is located before 11229 and after 11189734. OEM numbers that begin with a letter precede OEM numbers that begin with a numeral.

OEM No.	Auveco No.	Page No.	OEM No.	Auveco No.	Page No.	OEM No.	Auveco No.	Page No.	OEM No.	Auveco No.	Page No.
AC-DELCO			91512-STK-A01	22112	519, 544, 648, 677	2825	B2825	262	1142	20681	259
L562	20402	303	91512-SX0-003	19239	575, 518, 538, 648, 676, 738	2827	B2827	262	1155	18470	258
L891	20598	260	91513-SJK-003	22068	331	3057	B3057	262	1156	16904	258
LS101	9883	236, 244	91513-SP0-003	17323	643	3057A	B3057A	262	1156NA	17597	258
PT516	13547	243	91514-SMG-E01	22433	51	3156	B3156	262	1157	16899	258
PT549	11440	242, 254	91514-SP0-003	18764	643	3156A	B3156A	262	1157NA	16901	258
16-7552	9481	213	91514-SP1-003	18760	643	3157	B3157	262	1176	20585	259
614	12629	227	91515-SR3-000	19483	441, 480, 646, 675	3157A	B3157A	262	12100	17995	258
616	12628	227	91526-SP1-003	18767	644	3357	B3357	262	1255/H3	20600	260
ACURA			91530-S0A-003	21773	440, 486, 645, 674	3357A	B3357A	262	1260/H4	20601	260
33115-S84-A01	16897	260	91533-ST0-003	19668	643	3457	B3457	262	1295NA	19208	259
33116-SL0-003	BD2C	264	91535-SP0-003	18754	643	3457A	B3457A	262	13050	17994	258
33116-ST7-003	BD2S	264	91537-SP0-013	18236	644	3893	B3893	262	1445	18472	259
33303-S30-003	19206	259	91558-SE3-003	21388	649, 680	3893A	B3893A	262	1449	18473	259
33303-SL4-003	19206	259	91560-S9A-A01	20959	462, 483, 647, 672	4114K	B4114K	262	158	18014	258
34906-S30-003	19207	259	91560-SLJ-J01	21208	461, 483, 647, 672	4157	B4157	262	161	20285	259
34906-ST5-003	19207	259	91560-SZ3-003	19466	460, 480, 647	4157K	B4157K	262	1638	20295	259
72311-S5S-003	21704	440, 486, 645, 674	91560-TX4-A01	22499	52	5007	B5007	262	168	16921	258
75305-S0A-003	20783	660	91561-SW5-003	19479	644	5008	B5008	262	17131	20589	259
75305-SH2-003	20784	660	91563-SCV-003	21707	440, 486, 645, 674, 794	53	B53	262	17171	20590	259
75305-SH4-003	20785	660	91568-SL4-003	17608	644	57	B57	262	17177	20591	259
75315-STK-A01	21204	642	91568-TR0-003	21705	440, 486, 645, 674	67A	B67A	262	17916	20593	259
75315-TP6-A01	22465	51	91591-SJ6-013	21170	649, 680	68	B68	262	1815	18474	259
75316-S9A-004	21557	642, 659	91601-STX-A00	21209	645	6413	B6413	262	1816	16919	258
76222-SP1-003	21772	642, 660	91652-SP0-003	19465	644	6418	B6418	262	1889	18003	258
80871-SN7-003	18141	388	91652-SZ3-003	19746	415, 481, 646	6438	B6438	262	1891	18002	258
80871-ST7-000	18141	388	ALCOA, EUCLID			6461	B6461	262	1893	16909	258
80872-ST7-000	18140	388	5988-L	15010	157	67	B67	262	1895	16906	258
80873-ST7-000	18137	388	5988-R	15009	157	67A	B67A	262	192	20286	259
90001-SG0-003	14291	442, 476, 668	ALEMITE			68	B68	262	193	18013	258
90009-PH1-000	21353	278	1641-B	9257	283	7225	B7225	262	194	16902	258
90009-R70-A00	22205	280	AUTOMOTIVE BULBS			7440	B7440	262	194NA	18012	258
90103-SDA-A00	22203	93, 101, 129, 134	Industry standard number to Auveco's High Performance Imported Bulb No.			7440A	B7440A	262	198	16924	258
90107-S0X-A01	21521	644, 668	D1S	BD1S	264	7443	B7443	262	199	18466	258
90501-SDR-003	22419	53	D2C	BD2C	264	7443A	B7443A	262	2040	19209	260
90505-SL0-003	19140	568, 522, 624, 538, 649, 739, 804	D2R	BD2R	264	7505	B7505	262	2057	16907	258
90602-SEP-A00	21131	468, 483, 647	D2S	BD2S	264	7506	B7506	262	2057NA	16908	258
90602-SFA-004	21308	642, 660	H1	BH1	264	7507	B7507	262	211-2	16913	258
90602-SX0-003	21107	451, 483, 646, 671	H10	BH10	265	7515	B7515	262	212-2	18011	258
90621-SK7-003	18756	643	H11	BH11	265	7528	B7528	262	222	20287	259
90650-S5A-003	22365	51	H1LL	B64150ULT	264	880	B880	263	2357	17999	258
90651-T3L-003	22469	52	H13	BH13	265	881	B881	263	2357NA	18000	258
90651-TP8-003	21705	440, 486, 645, 674	H3	BH3	265	884	B884	263	24	18017	258
90661-ST7-003	18456	644	H4	B64193	265	885	B885	263	24NA	18018	258
90666-SA7-003ZW	19506	420, 480, 646, 669	H4LL	B64193ULT	265	886	B886	263	293	18467	258
90666-SS0-003	19740	643, 662	H6W	B64132	265	889	B889	263	3057	16915	258
90667-SD4-003	19464	452, 480, 646	H7	BH7	265	89	B89	262	3057NA	16916	258
90667-TC0-U01-ZA	22415	52	H7LL	B64210ULT	265	890	B890	263	3155	17997	258
90675-SA5-003	22105	145, 178, 681	H10W	B64113	265	891	B891	263	3156	17996	258
90682-SEA-003	20954	644, 667	H9	BH9	265	893	B893	263	3156NA	18475	259
90688-SB0-013	14698	508, 535, 678	H9	BH9	265	894	B894	263	3157	16917	258
90700-SJ4-000	18746	435, 478, 646, 670	HB1	B9004	264	896	B896	263	3157NA	18001	258
91501-SG0-003	17440	642	HB3	B9005	264	899	B899	263	3157NA-SA	18476	259
91501-SL4-003	19467	443, 480, 646	HB4	B9006	264	9004	B9004	264	3157SA	18479	259
91501-SP1-003	19225	642	HB5	B9007	264	9005	B9005	264	3357	18477	259
91502-SZ5-003	19232	504, 538, 648	1141	B1141	262	9006	B9006	264	3357NA	18478	259
91503-S0K-A01	20608	520, 541, 676	1156	B1156	262	9007	B9007	264	3457	20587	259
91503-SK7-013	19723	644	1156A	B1156A	262	9008	BH13	265	3457NA	20588	259
91503-SP0-003	17267	521, 537, 649	1157	B1157	262	906	B906	262	3496	20296	259
91503-SWA-A01	21466	726	1157A	B1157A	262	906A	B906A	262	3652	20298	259
91503-SZ3-003	19233	519, 538, 648, 676	1255	BH3	265	912	B912	262	37	18465	258
91503-SZ5-003	20564	522, 540, 649, 677	168	B168	262	9145	BH10	265	3757NALL	20859	259
91504-SP1-003	21558	642, 661	1893	B1893	262	916	B916	262	4157LL	20620	259
91505-SL0-003	19231	510, 538, 648	1895	B1895	262	916A	B916A	262	4157NALL	20621	259
91505-TM8-003	21706	486, 520, 648, 676	194	B194	262	921	B921	262	53	16914	258
91506-S9A-003	21173	521, 42, 648, 676	194A	B194A	262	921A	B921A	262	55	20282	259
91512-S50-003	21555	642, 660	2057	B2057	262	97	B97	262	561	18010	258
91512-SJ6-J01	21559	642, 659	2057A	B2057A	262	AUTOMOTIVE BULBS			562	20289	259
91512-SJK-003	22069	519, 545, 648, 677	2357	B2357	262	Industry standard number to Auveco's Wagner Bulb No.			57	16910	258
			2357A	B2357A	262	H3	20600	260	63	20283	259
			24	B24	262	H4	20601	260	631	18468	258
			24A	B24A	262	HB1	16896	260	67	16905	258
			2721	B2721	262	HB2	18661	260	68	20292	259
			2722	B2722	262	HB3	16897	260	73	20284	259
			2821	B2821	262	HB4	16898	260	74	18016	258
						HB5	18662	260	7440	19206	259
						PR2	16927	258	7443	19207	259
						1003	16918	258	881	20595	260
						1004	16920	258	885	20596	260
						1034	16925	258	886	20683	260
						1073	18004	258	89	16911	258
						1076	18469	258	891	20598	260
						11005	20299	259	893	20599	260
						11006	20300	259	900	18015	258
						1141	16923	258	9003	18661	260
									9004	16896	260
									9005	16897	260
									9006	16898	260
									9007	18662	260

O.E.M. INTERCHANGE BY MANUFACTURER

OEM No.	Auveco No.	Page No.	OEM No.	Auveco No.	Page No.	OEM No.	Auveco No.	Page No.	OEM No.	Auveco No.	Page No.
904	20291	259	51-32-1-938-884	21423	400, 650	CHRYSLER (INCLUDES AMC)			1BA41XWG-AA	21175	621
906	16922	258	51-41-015-44-20	21764	651	H452EK1	17080	531, 536, 625	2072728	8746	156
912	18008	258	51-41-0-407-983	22229	89,	J4004175	9298	154	2074089	8971	846
916	18006	258			466, 654	J4004354	9297	154	2096454	17115	221
916NA	18007	258	51-41-0-407-984	21788	466,	J4004354	10087	154	2096466	14892	221
921	18005	258			486, 653, 734	J4005293	10087	154	2096467	15504	221
922	20294	259	51-41-1-802-258	13170	651	J4006956	18163	156	2409826	8742	156
93	16926	258	51-41-1-973-500	20253	471,	L00000880	B880	263	2448770	16873	833
97	16912	258			481, 653	L0000067	B67	262	2486468	17434	632
			51-41-700-16-29	21764	651	L0000089	B89	262	2496279	9905	236,
			51-41-7-001-629	21764	651	L0000168	20706	267	2524525	8419	616
			51-41-8-172-050	13179	470,	L0000168	B168	262	2534814	14461	846
					475, 653, 816	L0000194	B194	262	2664040	14985	436,
			51-41-821-58-06	21762	651	L00002057A	B2057A	262	2745108	20675	476, 629
			51-41-8-224-768	21788	466,	L0000880	B880	263		614, 630, 634	587,
					486, 653, 734	L0000886	B886	263	2945108R	20675	587,
			51-41-8-224-781	22229	489, 654	L0000891	B891	263		614, 630, 634	587,
					466,	L0000894	B894	263	2945109	14967	587,
			51-43-0-141-025	22229	466,	L0000896	B896	263		614, 630, 634	587,
					489, 654	L0000899	B899	263	2945109L	14967	587,
			51-43-7-194-187	22109	656	L0000906	B906	262		614, 630, 634	587,
			51-44-7-780-135	21499	652, 728	L0000912	B912	262	2964547	11129	416, 475
			51-45-030-47-03	21764	651	L0000H11	BH11	265	2998430	10332	428, 475
			51-45-0-396-330	21763	651	L0000H13	BH13	265	3201767	13966	170, 765
			51-45-8-161-557	21763	651	L0001156	B1156	262	3236813	12927	199
			51-45-816-52-60	21764	651	L0001157	B1157	262	3237451	12949	199
			51-45-8-266-814	21775	652	L0001893	B1893	262	3239826	12935	197
			51-46-7-002-606	21779	491,	L0001895	B1895	262	34201287	16826	105,
					544, 654	L0002057	B2057	262		108, 121, 124	
			51-47-0-146-782	20638	520,	L0003057	20722	267	34201358	15331	139
					541, 654, 731	L0003057	B3057	262	34201545	12993	418,
			51-47-0-390-017	20638	520,	L0003156	B3156	262		475, 766	
					541, 654, 731	L0003157	B3157	262	34201621	12567	571,
			51-47-1-881-521	21851	474,	L0003157AK	B3157A	262		505, 625, 534	
					486, 652	L0003457	B3457	262	34201631	18108	297
			51-47-1-911-992	20638	520,	L0007440	B7440	262	34202159	17495	140
					541, 654, 731	L0007440NA	B7440A	262	34202672	13993	573,
			51-47-1-919-209	22052	521,	L0007443	B7443	262		506, 534, 607, 626	
					545, 655	L0009004LL	B9004	264	34202787	15478	430, 477
			51-47-1-945-266	21777	455,	L0009005	B9005	264	3426388	2272	409, 634
					486, 653	L0009006	B9006	264	3441734	12930	197
			51-47-2-499-935	21851	474,	L0009006XS	B9006XS	260	3441743	12930	197
					486, 652	L0009007QL	B9007QL	260	3454220	15673	587, 630
			51-47-7-117-532	22090	469,	L0009007QL	B9007	264	3454221	15674	587, 630
					488, 654	L0009145	BH10	265	3509575	9905	236, 253
			51-47-8-116-564	21851	474,	L000921E	B921	262	3513686	13542	253
					486, 652	L00194NA	B194A	262	3574085	11653	616
			51-47-8-166-992	21780	490,	L002057A	B2057A	262	3588314	13541	253
					544, 654	L004157NAK	B4157K	262	36000148	15666	634, 808
			51-47-8-183-031	21851	474,	L00H355W	20600	260	36001966	15666	634, 808
					486, 652	L01255H3	20600	260	36003452	13454	421, 475
			51-48-1-884-779	22052	521,	MB020923	19385	445,	3671410	12918	198
					545, 655	MB132008	14335	780, 737	3673945	12918	198
			51-48-1-915-964	20270	516,	MB153825	17195	597,	3674096	18395	582, 409
					540, 655		620, 658, 694, 735	504,	3691590	10831	425, 477
			51-48-1-938-725	20270	516,	MB253964	17351	537, 738	3691590	16259	425, 475
					540, 655		16671	806	3693099	14217	582,
			51-48-8-126-849	22524	50	MB325299	16671	806		610, 634	
			51-48-8-181-420	21757	445,	MB374270	21118	465,	3696693	10843	400
					486, 652		21118	483, 738	3744734	10843	400
			51-49-0-151-605	22057	450,	MB374271	21118	483, 738	3744750	12237	236,
					488, 653	MB475404	17162	499,		244, 253	
			51-49-8-105-79	22057	450,	MB547806	17472	522,	3751212	12923	198
					488, 653		537, 739, 754	522,	3759944	18770	416, 478
			51-49-8-105-790	22057	450,	MB566719	19802	455, 481	3764863	12599	253
					488, 653	MB566720	19334	453,	3764865	12598	253
			51-49-8-123-832	22057	450,		480, 737	468,	3767196	18979	400
					488, 653	MB608104	19129	479, 800	3775994	18770	416, 478
			51-49-8-166-702	22201	494,	MB696120	19320	449,	3793876	18979	400
					545, 654		480, 737	449,	3799089	14858	630
			51-71-1-958-025	22087	656	MB888869	19140	568,	3843245	12598	253
			51-71-7-002-953	20754	297		522, 624, 538, 649, 739, 804	509,	3843345	12628	227
			51-71-7-006-757	22140	650	MR200300	20247	509,	3843386	16349	221
			51-71-7-066-220	22141	650	MR328954	19274	516,	3843392	12627	227
			51-71-7-066-223	22142	651		540, 675, 738	516,	3843432	13233	253
			51-71-7-066-226	22092	474,	MS820959	16897	260	3861577	11347	421, 475
					488, 653	OH452KD5	17080	531,	3861577	11679	421, 475
			51-71-7-066-299	22091	473,		536, 625	625,	4000141	11697	634
					488, 652	OWX68BD1-AA	20948	541, 625	400141	9829	549
			51-71-8-184-574	21765	650	OWX68BD5-AA	21021	524,	4001916	18508	441, 478
			51-71-8-259-788	21781	521,		20541	433, 482	4003120	13004	168
					544, 655	TY98TL2-AA	20948	525,	4003672R	20675	587,
			51-75-7-271-848	22084	651	WX68BD1-AA	20948	541, 625		614, 630, 634	
			51-77-7-171-002	21787	454,	WX68DX9-AA	20739	524,	4003673L	14967	587,
					486, 653, 734		541, 625	524,		614, 630, 634	
			51-77-7-171-004	22147	657		541, 625	524,	4004569	10831	425, 475
					50	XX10362-20-K1105	7680	414	4004569	16259	425, 477
			52-20-8-1964-201	22521	650	06504995AA	12993	418,	4004689	10330	549
			52-20-8-238-999	13167	652		475, 766	503,	4005091	18296	92, 98
			63-17-1-637-868	20647	728	06509673AA	21601	543, 628	4005099	11349	471, 475
			63-21-7-160-777	BH1	264		21427	524,	4005250	11350	433, 475
			63-21-7-160-779	BH3	265	OWX68XDB-AA	21427	543, 625	4005470	11678	471, 475
			63-21-7-160-780	BH7	265			91, 96	4005540	11152	401, 402
			63-21-7-160-806	BD2S	264	154534	16478	92, 97	4005714	15813	401, 634
			63-21-7-190-591	BH1S	265	1560058	19626	824	4006204	11470	547, 634
			63-21-7-217-509	BD1S	264	1560058	19627	824	4006316	13965	169
			88-10-0-141-180	B53	262	1624705	2744	824	4006516	11612	418, 475

O.E.M. INTERCHANGE BY MANUFACTURER

OEM No.	Auveco No.	Page No.	OEM No.	Auveco No.	Page No.	OEM No.	Auveco No.	Page No.	OEM No.	Auveco No.	Page No.
4023030	4204	396	5113015-AA	18032	493	6025004	15345	155	6500724	12569	595, 617
4033711	14552	632			537, 623	6025005	15347	155	6500787	14016	490,
4040732	18509	437, 478	5113360-AA	20529	553	6025007	15350	155		534, 572,	625
4055028	13542	253	5116530-AA	20966	511,	6025329	9480	88, 89	6500859	13754	297
4095145	12929	197			541, 626	6026166	16237	168	6500898	13755	297
4100727	12932	199	5116530-AA	20990	514,	6026430	9299	154	6500899	13748	297
4104998	12937	197			575, 542, 627	6026723	10655	87	6500911	13750	298
4114785	12134	410	5159077-AA	20964	620	6026723	10656	87	6501025	12125	141
4124081	20389	253	5159077-AB	20964	620	6026723	10657	87	6501067	15481	428, 477
4124721	12598	253	5160260-AA	20966	511,	6026958	10086	154	6501086	20316	430, 481
4167810	12920	198			541, 626	6027924	10080	631	6501178	14980	141
4179981	12946	197	5183468-AA	19472	580, 610	6027958	19485	112,	6501186B	13747	297
4179982	12944	199	5189180-AA	21154	621			617, 736	6501227	12993	418,
4200408	15326	139	5189181-AA	21155	623	6029348	16852	154		475,	766
4201198	12934	197	5208743	15040	423, 476	6029501	12735	550,	6501301	16818	423, 477
4241054	12939	199	5255110	18979	400			616, 811	6501415	16980	141
4241296	12930	197	5288722AA	18263	594	6030441	11146	425, 475	6501509	18242	297
4241362	12916	198	53041045	16873	833	6030441	15414	425, 477	6501544	14021	416, 476
4270974	11369	106, 109	55022134	15042	530,	6030441	18815	419, 479	6501544	17106	495,
4304729	16804	221			535, 578	6030538	10832	425, 475		536,	572
4307218	12943	199	55054844	15666	634, 808	6031091	11621	304	6501559	13751	298
4336115	17167	632	55055098	18248	442, 478	6031091	16838	304	6501577	17106	495
4339372	21022	403	55074801	14010	528,	6031115	11620	302		536,	572
4341060	17004	435, 477			534, 571, 625	6031115	16837	302	6501590	14019	529,
4368618	15499	217	55075139	17214	569,	6031138	14218	618		535, 609,	628
4370138	17101	298			493, 623, 537	6031147	8865	154	6501630	17104	533,
4378751	20030	635	55075487	20110	635	6031183	14218	618		536,	624
4378794	19933	640	55075488	20090	635	6031234	13647	617	6501699	17354	618
4381395	20316	430, 481	55116997-AA	22461	49	6031321	10831	425, 475	6501772	17104	533,
4389940-AB	21670	621	55116997-AB	22461	49	6031383	11704	505,		536,	624
4389947-AA	21376	527	55156429-AA	20523	621			534, 624	6501773	12569	595, 617
			55156447-AB	20700	622	6031390	11699	571,	6501825	12259	141
4399576	20389	259	55156655-AA	21738	623			506, 624, 534	6501878	17104	533,
4400588	13542	253	55156879-AB	20962	619	6031438	12995	167		536,	624
4428987	19155	435, 479	55157055-AA	20700	622	6031438	12996	167	6501916	15543	426, 477
4437565	12237	236	55157055-AA	20887	623	6031869	12713	552,	6501925	18030	537,
			55157065-AA	20887	623			618, 765		506, 573,	626, 537
4453429	12569	595, 617	55157069-AB	20827	622	6031875	19152	631	6501948	19893	422, 481
4486948	11157	237, 253	55157070-AC	20828	621	6032061	12566	553, 618	6502078	11146	425, 475
4498100	14552	632	55157112-AA	20890	533	6032083	16851	154	6502081	16871	833
4580779	14011	504,			541, 629	6032138	16687	308	6502083	16872	833
			55157112-AB	20890	533	6032363	11351	429, 475	6502085	16873	833
45998051	12119	141			541, 629	6032516	13466	112, 616	6502087	16874	833
4630088	18031	297	55176248	14020	529	6032856	17615	306	6502089	16875	833
4630088	18028	297			535, 577, 609	6032881	12652	315	6502089	16876	833
4630253	18029	533	55256967-AC	19816	400	6032926	12655	303	6502090	16877	833
			55350747-AB	19775	469, 481	6032926	14486	303	6502091	16878	833
4630660	18031	297	56001419	15666	634, 808	6033082	17664	425, 478	6502104	18771	430, 479
4636360	18921	253	5BB14LX9	19245	514,	6033184	2625	111	6502152	16846	145, 178
4636361	18920	253			538, 627	6033560	15345	155	6502328	14921	416, 476
4636362	18920	253	5FR56DX9	19894	621	6033677	14756	595, 617	6502381	18815	419, 479
4638136	14753	570,	5FR56XXX-AB	19894	621	6033688	18810	314	6502407	16826	105
			5GC71RC3-AA	20273	514,	6033840	17664	425, 478		108, 121,	124
4638136	506, 605, 624, 535	506,			540, 606, 625	6033862	11349	471, 475	6502450	16876	833
			5GC71RK5-AA	20273	514,	6034212	18461	308	6502491	16870	833
4658444	19191	631			540, 606, 625	6034213	10375	154	6502545	18237	629
4658673	19149	417, 479	5GF92RC3-AA	20273	514,	6034336	19310	631	6502573	18032	493,
4658676	20675	587,			540, 606, 625	6034376	18373	276		537,	623
			5GF92RK5-AA	20273	514,	6034703	18934	94, 103	6502625	16835	524,
4658677	14967	587,			540, 606, 625	6034812	19310	631		536, 570,	624
			5GUU9K111BA	20993	528,	6034848	19657	306	6502689	18501	297
4658887	20165	416, 481			542, 577, 608	6034944	16988	299	6502738	17353	156
4676356	19339	631	6000020	2611	169	6035094	2562	154	6502745	16968	833
4696129	18033	440, 478	6000258	19537	170	6035188	18934	94, 103	6502776	18102	612, 631
4696488	14995	495,	6000558	10073	169	6035201	17639	315	6502900	14753	570,
			6000605	5854	169	6035201	19263	315		506, 605,	624, 535
4717224	19855	425, 481	6000705	2619	824	6035274	14037	552, 618	6502842	17975	434, 478
4759514-AA	20356	619	6000705	2619	824	6035296	14009	552	6502871	14992	500,
4759514-AB	20356	619	6000709	2744	824	6035401	20179	617		535, 604,	624
4778115	20139	635	6000720	2752	824	6035414	19406	306	6502907	17669	467, 478
4784018-AA	21231	619	6000720	12960	824	6035417	18373	276	6502988	19519	583, 631
4805405-AA	19638	531,	6000943	8419	616	6035807	19310	631	6502991	17685	469, 478
			6000943	8719	411, 877	6035821	20524	618	6503106	18269	526,
4805405-AB	19638	531,	6000943	9377	616, 764	6036148-AA	20629	308		537,	628
			6001419	5592	442, 475	6036155-AA	11146	425, 475	6503108	18034	617
4805570-AA	20526	631	6002893	10622	402	6036310-AA	18163	156	6503163	14997	500,
4806110-AA	20767	526,	6003147	11354	620	6036679-AA	22371	47		535,	569
			6003219	13616	620	6036747-AA	18163	156	6503204	18862	468, 479
4806226-AA	21187	583	6003220	8853	437, 475	6100042	11629	145, 179	6503221	12766	430, 475
4806240-AA	20768	513,	6003308	20276	402	6100047	19216	139	6503336	21023	474, 483
			6003349	11678	471, 475	6100048	15329	139	6503338	21023	474, 483
4806240-AB	20768	513,	6003351	11136	441, 475	6100049	15331	139	6503339	18249	630
			6003409	20276	402	6100050	15333	139	6503373	18825	618
4806271-AA	22028	619	6003423	11673	429, 475	6100053	15337	139	6503401	19417	94,
4806334-AA	20963	531,	6003587	11675	420, 475	6100539	12232	121, 123		104, 130,	137, 579, 629
			6003609	12794	620	6100566	12160	121, 124	6503433	18375	280
4856880	10733	155	6003632	11936	620	6100567	19455	125	6503453	18394	530,
4857104	20526	631	6003737	12563	555	6100568	15818	122, 125		538,	628
4857108	17103	500,	6003752	20276	402						

O.E.M. INTERCHANGE BY MANUFACTURER

OEM No.	Auveco No.	Page No.	OEM No.	Auveco No.	Page No.	OEM No.	Auveco No.	Page No.	OEM No.	Auveco No.	Page No.
6504072	1793	618	7703-077-066	12993	418,	C8AZ-63442413-A	9882	402	E5ZZ-12A209-A	18217	248
6504090	12567	571,			475, 766	C8AZ-63642413-A	9882	402	E6AZ-5421952-A	15675	614
	505, 625, 534		812893	12600	238, 253	C8TZ-13466-A	16899	258	E6DZ-13032-A	15968	594
6504098	19338	433, 480	83501000	12599	253	C8TZ-13466-A	B1157	262	E6DZ-13466-B	18005	258
6504135	19541	428, 480	83504041	19318	277	C9AZ-17698-A	19393	404	E6DZ-13466-B	B916A	262
6504424	18375	280	8880417	15672	505,	C9AZ-17698-C	19393	404	E6DZ-14A411-A	18676	247
6504452	17669	467, 478			536, 624	C9AZ-9C492A	19003	197, 399	E6DZ-5421952A	17122	614
6504521	19422	513,	8880476	15672	505,	C9AZ-9C492-B	19001	197, 399	E6DZ-5421952-A	17122	614
	539, 627				536, 624	C9AZ-9C492-C	19000	197, 399	E6DZ-5421970-A	17119	614
6504555	17222	572,	8934-201-235	13464	765	D0AZ-62234A24-B	17974	405	E6DZ-5421971-A	17118	614
	500, 607, 537		8934-201-262	11855	550, 764	D0DZ-15A434-B	9883	236, 244	E6FZ-13466-B	18016	258
6504601	19779	632	8934-201-263	9377	616, 764	D0DZ-13A-093AA	11660	594	E7EB-14421-EA	16342	220
6504700	13750	298	8934201287	16826	105,	D1AB-14461-AA	14887	220	E7EB-14461-BA	20475	220
6505149-AA	18531	140, 153			108, 121, 124	D1AB-6542413-AB	9882	402	E7EZ-14474-CA	16344	220
6505161-AA	19640	617	8934-201-287	16826	105,	D1AB-6542413-AB	8941	403	E7GZ-17A904-B	15366	603, 724
6505292-AA	19386	466, 480			108, 121, 124	D1AZ-13410-A	19813	251	E7GZ-17A904-G	16843	533,
6505411-AA	10831	425, 475	8934-201-493	16256	168	D1AZ-13410-B	13537	244		536, 724, 755	
6505417-AA	19836	118, 481	8934-201-602	12713	552,	D1AZ-6522841A	14550	592, 615	E7GZ-6120586-B	18692	439,
6505425	10831	425, 475			618, 765	D1AZ-6522841-A	14550	592, 615		478, 720, 794	
6505534-AA	20829	454, 482	8934-201-621	14007	505,	D1AZ-6524213-B	9882	402	E7SB-13A093BA	15966	594
6505539-AA	19628	467, 480			534, 571, 625	D1AZ-65432413-B	8941	403	E7SZ-13032-D	15966	594
6505667-AA	20360	427, 482	8934-201-631	13750	298	D1FZ-13234A	14135	244	E7ZZ-13466-B	18007	258
6505686-AA	20362	430, 482	8934-201-681	13475	471,	D1FZ-13234-A	14135	244	E7ZZ-13466-B	20712	267
6505703-AA	20267	617			476, 768, 815	D1FZ-13466-B	16913	258	E80A-14526B	15926	233
6505759-AA	20427	469, 482	8934-201-767	13966	170, 765	D1FZ-6222600-A	12470	616	E80A-14526B	15927	233
6505813-AA	18934	94, 103	8934-201-835	17496	297	D2AZ-6222008-A	18892	615	E80A-14526D	15931	233
6505878-AA	17124	455, 477	8934-202-293	16251	168	D2FZ-6222600-A	12470	616	E83Z-16758-A	16832	396
6505918-AA	20515	466, 482	8934-202-599	17102	455, 477	D2OB-13A093-AA	11660	594	E83Z-5421952-B	17122	614
6506007-AA	13751	298	8936000	15666	634, 808	D2OB-13A093-AA	11661	594	E8AZ-13466-A	17996	258
6506008-AA	19639	573,	8936-000-148	15666	634, 808	D2OB-14421-BB	20815	221	E8BZ-17C756-C	17450	603, 724
	505, 626, 539		8936001	15666	634, 808	D2VZ-6521952-A	14967	587,	E8EB-14474-VA	16348	220
6506104-AA	20173	632	8955-022-134	15042	530,			614, 630, 634	E8FZ-5802354-A	19845	432, 481
6506132-AA	20458	521,			535, 578	D3AA-90826-AA	10837	611	E92Z-17C756-C	17060	603, 724
	540, 627		8956001	15666	634, 808	D3AB-14474-DA	14889	220	E92Z-17C756-C	17060	603, 724
6506161-AA	19278	92,	9411943	3401	155	D3AZ-13410-A	13535	244	E97B-13A093BA	16399	594
	98, 129, 132		9422202	13708	91, 95	D3AZ-13410-B	13533	244	E97B-13A093-BA	16399	594
6506214-AA	19141	280	9422246	13707	91, 94	D3AZ-13410-E	14131	244	E97B-13A093BB	16399	594
6506306-AA	20623	630	9423950	15827	92, 99	D3AZ-13410-G	14132	244	E97B-13A093BB	16399	594
6506654-AA	20274	455, 481	9427977	13709	93, 100	D3AZ-14474-G	20816	221	E97B-13A093BB	16399	594
6506655-AA	20275	618	9428273	13027	92, 99	D3AZ-14526-D	12629	227	E9AZ-5422008-A	18891	615
6506852-AA	20468	618	972724	4244	395	D3AZ-14526-D	15372	226	E9DB-13N020AA	15940	594
6506852-AB	20468	618				D3AZ-14526-E	12628	227	E9DZ-13N129-A	15940	594
6507055-AA	20765	468, 482				D3AZ-14526-H	12628	227	E9DZ-6730-B	18025	279
6507669-AA	20766	521,				D3AZ-14526-H	12629	227	E9DZ-6730-B	19773	280
	541, 627		BSS800	12654	314	D3AZ-14526-Z	12627	227	E9DZ-6734E	18299	275
6507670-AA	19111	312				D3OZ-16776-A	11136	441, 475	E9FZ-5822008-A	18890	615
6507686-AA	20765	468, 482				D4AZ-13466-A	18465	258	E9SB-6302354ACW	15523	428, 477
6507741-AA	21354	278	5715	15017	158	D4LY-13410-A	14133	244	E9SZ-13N021-A	16898	260
6508072-AA	21236	618	5716	15015	157	D4MY-13466-A	18011	258	E9SZ-13N021-B	16897	260
6508197-AA	21098	510,	8411	15018	158	D4OZ-13234-A	14128	244	E9TZ-13032B	16399	594
	542, 605, 624					D4OZ-13234-A	14130	245	E9TZ-13032-B	16399	594
6508365-AA	20623	630				D5AB-14474-FA	20816	221	E9TZ-6730-B	19365	282
6508444-AA	21446	297	4956-A	15017	158	D6DZ-6551026-A	10048	176	E9SZ-13466-A	20291	259
6508540-AA	21418	305	4963	15015	157	D6EA-1A100-AA	11702	491,	E9VY-13A506-A	17164	610
6508643-AA	21348	531,	5706	15018	158			534, 606	F0TZ-14489-J	19004	251
	543, 629		5735-L	15004	157	D6FZ-1A100-A	11702	491,	F1CZ-13466-C	20595	260
6508712-AA	20888	574,	5988-L	15010	157			534, 606	F1CZ-13A147A	18899	594
	512, 627, 541		5988-R	15009	157	D6TZ-6730-A	14196	276	F1CZ-13A147-A	18899	594
6508727-AA	21257	426, 484				D7TZ-13466-A	18008	258	F1CZ-16674-A	18458	476,
6508746-AA	14010	528,				D7VY-6050074-A	13966	170, 765		478, 719	
	534, 571, 625					D8BB-14474-BA	14889	220	F1CZ-16774-A	18458	476,
6508863-AA	20988	510,	14591787	21802	418,	D8BZ-13466-A	16922	258	F1CZ-5802316-A	19138	598, 718
	574, 626, 541				486, 766	D8BZ-13466-A	B906	262	F1CZ-61101B04-A	17602	602
6508947-AA	21153	622	14592086	21804	418,	D8BZ-14474-A	14889	220	F1CZ-8A188-A	17317	597
6509049-AA	20880	574,	14592087	21803	486, 766	D8BZ-5423342-A	13030	616	F1TZ-13411-A	22184	246
	511, 541				418,	D8TZ-13466-A	18472	259	F1TZ-17698-A	19393	404
6509103-AA	19801	573,	4-131-508-M	13230	486, 766	D8TZ-6730-A	19365	282	F1TZ-7810182-A	19441	602
	500, 607, 626, 539				490,	D9OZ-6522841A	14551	615	F1TZ-13466-A	20286	259
6509106-AA	21019	632	4-29-29-06	13198	534, 730, 823	D9AB-74519B18-AA	14758	473, 476	F22Z-16774-A	14709	420
6509288-AA	21223	622			421,	D9AE-9E645-AA	12921	198		476, 720	
6509432-AA	22289	584,	71728806	22432	475, 657	D9AZ-14474-F	16344	220			
	612, 631				49,	D9AZ-14A163-J	12622	610	F2DZ-13466-C	20599	260
6509539-AA	21865	93,			50, 67	D9OZ-6522841-A	14551	615	F2PZ-14A464-C	19004	251
	100, 129, 134					D9OZ-6643030-AA	19594	615	F2UZ-1602354-AAA	19846	432, 481
6509590-AA	21679	423, 486				D9GZ-14526-A	21749	235	F32Z-17C756-S	17003	612, 725
6509673AA	21601	503,				D9GZ-14526-P	21751	235	F37Z-13N129-A	18263	594
	543, 628					D9GZ-14526-R	21752	235	F3DZ-6730-A	18025	279
6509761-AA	22459	49	A20Z-13410B	13537	244	D9GZ-14526-S	21750	235	F3EZ-6734-A	18299	275
6509884-AA	20989	512,	AB-181-GG	16893	125	D9OZ-6522841-A	14551	615	F3LB-14K056-AA	17222	572,
	574, 541, 608		B100-68-675-69	21119	522,	D9OZ-6643030-AA	19594	615		500, 607, 537	
6509960-AA	21680	507,	B5AZ-13466-A	889	262	D9OZ-6643030-AA	19594	615			
	544, 624		B7A-16758-A	4273	395	D9OZ-6643030-AA	19594	615	F3LY-14570-B	17222	572,
6510139-AA	22354	510,	B8A-7029120-A	2752	824	D9OZ-6643030-AA	19594	615		500, 607, 537	
	545, 626		B8AZ-13466-A	16919	258	D9OZ-6643030-AA	19594	615	F3LY-6321970-A	17119	614
6510734-AA	22363	50	B9A-6423240-A	3135	400	D9OZ-6643030-AA	19594	615	F3LY-6321971-A	17118	614
6510766-AA	22177	502,									

O.E.M. INTERCHANGE BY MANUFACTURER

OEM No.	Auveco No.	Page No.	OEM No.	Auveco No.	Page No.	OEM No.	Auveco No.	Page No.	OEM No.	Auveco No.	Page No.
F5RZ-17K657-A	20425	596	N802734-S	19197	429, 479	N807155-S	19354	425, 480	W702512-S900C	22023	314
F5RZ-6730-B	18374	278	N802737-S	13469	513,	N807168-S	19111	312	W702554-S900	22066	314
F5TZ-6734-BA	20453	275			534, 606	N807189-S100	20171	598	W702554-S900C	22066	314
F61Z-15020C34-AA	19536	611	N802775-S36	16883	139	N807247-S	19526	598	W702926-S	18744	298
F65Z-15020X34-AA	19536	611	N802781-S	14020	529,	N807389-S	17216	576,	W703842-S300	20193	603
F65Z-1521952-AA	19658	588			535, 577, 609			522, 608, 627, 537	W703919-S300	20193	603
F67Z-7822008-AA	18890	615	N802865-S100	18153	584	N807535-S	19760	428, 481	W704021-S100	20268	583
F6AZ-14A411-AA	18218	252	N802900-S	12565	455, 475	N807535-SSZ	19760	428, 481	W704021-S424	20268	583
F6DZ-16758-AD	16850	396	N802900-S	13470	455, 476	N807577-S	18895	506,	W704340-S300	14020	529,
F6DZ-5402316-AA	19238	598	N803043-S	13750	298			538, 605		535, 577, 609	
F6DZ-5403296-A	20942	400	N803170-S	14021	416, 476	N807578-S	18894	506,	W704342-S300	13751	298
F6DZ-5410182-AA	20358	601	N803183-S32	14814	172			538, 605	W704385-S300	20193	603
F6TZ-6730-BA	19279	280	N803362-S	13993	573,	N807620-S100	18461	308	W704740-S300	18816	598
F75Z-6730-BA	18025	279			506, 534, 607, 626	N807673-S	22058	496,	W704881-S300	19237	93,
F75Z-6730-BA	19773	280	N803387-S	15668	434, 477			545, 604		100, 598	
F79Z-1123342-AAA	13030	616	N803387-S300	15668	434, 477	N807706-S	19326	596	W704897-S417	19419	307
F7CZ-17C756-EA	16843	533	N803421-S	14019	529,	N807721-S	17612	426, 478	W704958-S300	19511	501,
		536, 724, 755			535, 609, 628	N807875-S	19524	474, 480			539, 610
F7DZ-5402316-AA	19238	598	N803494-S	14953	567,	N807943-S	19810	455, 481	W705002-S300	19338	433, 480
F7DZ-7421952-AA	19658	588			532, 535, 603	N807951-S	18820	421, 479	W705297-S300	21245	315
F7UZ-1513284-BA	19421	612	N803613-S	16863	434, 477	N807994-S	18816	598	W705376-S900	17420	302
F7UZ-15238A32	19413	412, 603	N803638-S36B	14895	613	N808041-S437	20742	585	W705436-S300	19801	573,
F7UZ-15238A32-AAC	19413	412, 603	N803685-S11	14820	584, 612	N808048-S	16726	510,		500, 607, 626, 539	
F81Z-19D887-AA	20843	249	N803709-S	17103	500,			536, 608	W705532-S300	16726	510,
F81Z-6730-AA	20807	277			536, 573, 607	N808147-S	14991	570,		536, 608	598,
F8DZ-54265A99-AA	20630	614	N803716-S	14018	512			506, 605, 535	W705550-S300	19783	598,
F8VZ-54237A02-AA	18848	455, 479			534, 608	N808182-S309	19436	613		11146	425, 475
FDA13021-A	12228	594	N803734-S	15480	429, 477	N808182-S439	19436	613	W705589-S	11146	425, 475
KA80-51PR6	18882	603, 715	N803739-S	22139	298	N808331-S	18895	506,	W705589-S	15414	425, 477
MB455-56143	17632	508,	N803763-S100	20415	585, 613			538, 605	W705589-S300	11146	425, 475
		537, 605, 688, 722	N803768-S	18155	595	N808332-S	18894	506,	W705589-SS5YZ	11146	425, 475
MG350-68AB1	18824	458,	N803857-S	20311	417, 481			538, 605	W705590-S300	20466	552, 597
		479, 721	N803862-S	13751	298	N808342-S307	20546	612	W705681-S300	20360	427, 482
N605920-S2	12327	122, 127	N803933-S101	17408	302, 305	N808370-S	19127	427, 479	W705711-S417	19414	302
N606676-S100	12160	121, 124	N803934-S	13994	529,	N808594-S100	18396	304	W705745-S300	17632	508,
N606676-S100	15778	121, 124			577, 534, 609	N808679-S	15480	429, 477		537, 605, 688, 722	
N606676-S2	12160	121, 124	N803946-S	14992	500,	N808689-S417	19458	304	W705848-S300	14753	570,
N606676-S36	15778	121, 124			535, 604, 624	N808791	20273	514,		506, 605, 624, 535	
N606677-S36	12335	121, 125	N804189-S	13747	297			540, 606, 625	W705849-S300	20355	602
N606677-S43B	15779	121, 125	N804193-S100	18167	304	N808842-S	19338	433, 480	W705894-S300	20245	595
N606677-S53B	15779	121, 125	N804343-S	13748	297	N808847-S	19244	528,	W705955-S300	20177	423, 481
N606690-S2	15780	122, 127	N804344-S	14967	587,			538, 609	W705956-S300	20233	527,
N606690-S55	15780	122, 127			614, 630, 634	N808908-S	19337	497,		540, 606	
N606692-S2	16931	122, 127	N804349S	15479	431, 477			539, 609	W705957-S300	20518	527,
N610959-S2	13019	93,	N804349-S	15479	431, 477	N811006-S	18936	473, 479		540, 609	
		102, 130, 135	N804376-S	16421	106, 107	N811018-S100	17639	315	W706009-S300	16954	611
N620391-S36	17495	140	N804379-S	15478	430, 477	N811018-S100	19263	315	W706092-S300	21098	510,
N620480	15316	139	N804448	14757	422, 476	N811040-S	20893	417, 483		542, 605, 624	
N620480-S2A	15316	139	N804570-S	14753	570,	N811169-S	19783	598,	W706172-S309	20401	613
N620482	15318	139			506, 605, 624, 535			706, 786	W706182-S300	20516	519,
N621900	15325	139	N804570-S	14993	506,	N811257-S100	20421	613		540, 607	
N621903	15326	139			535, 570	N811257-S309	20421	613	W706350-S300	14992	500,
N621905	15328	139	N804583	15187	297, 309	N811259-S	18812	293		535, 604, 624	
N621905-S2	15328	139	N804583-S	15187	297, 309	N811283-S	20545	510,	W706350-S3000	14992	500,
N621906-S361	16774	139	N804614-S	13994	529,			540, 605		535, 604, 624	
N621906-S437	16774	139			577, 534, 609	N811353-S100	20171	598	W706358-S300	15478	430, 477
N621907	15332	139	N804674-S	15701	528,	N811460-S100	19419	307	W706494-S300	19849	511,
N621940-S424	15335	139			536, 609	N811478-S100	20927	112, 595		539, 606	
N621942-S2	15337	139	N804675-S	17101	298	N811534-S61	19653	92	W706519-S300	20518	527
N621942-S301	15337	139	N804759-S	15491	298			99, 129, 133		540, 609	
N621942-S441	15337	139	N804765-S	19277	596	N811540-S	20360	427, 482	W706575-S300	20393	596
N621945-S2	21001	139	N804837-S	14994	529,	N811772-S	19472	580, 610	W706635-SSW	21241	431, 484
N623330-S2	18337	145, 177			535, 606	N811540-S	20360	427, 482	W706676-S900	17664	425, 478
N623331-S2	18338	145, 177	N804851-S100	19516	315	N905150-S	17466	312	W706713-S300	20367	511,
N623332-S100	11864	145, 178	N804863-S100	13754	297	N905180-S	17466	312		540, 605	
N623332-S2	11864	145, 178	N804992-S58	10654	72	NAO1-56145	16858	522,	W706738-S300	20190	468, 481
N623332-S21	12669	145, 178	N805026S	14995	495			536, 606, 699, 723, 753	W706739-S300	20190	468, 481
N623332-S439	12669	145, 178			535, 569, 604, 623	W520802-S439	11864	145, 178	W706812-S300	19386	466, 480
N623332-S53	12669	145, 178	N805083-C	16832	396	W520821-S426	18338	145, 177	W706815-S300	21257	426, 484
N623333-S100	11629	145, 179	N805155-S	17124	455, 477	W520821-S439	18338	145, 177	W707157-S300	20245	595
N623333-S2	11629	145, 179	N805229-S	14988	493,	W520822-S426	12669	145, 178	W707388-S300	20936	603, 715
N623340-S2	11625	145, 177			535, 604	W520823-S426	11629	145, 179	W707501-S300	12253	141
N623343-S100	11630	145, 179	N805231S	15522	503,	W520823-S439	11629	145, 179	W707593-S300	20190	468, 481
N623343-S2	11630	145, 179			536, 607	W520832-S424	12575	145, 178	W707638-S900C	22067	313
N623344-S2	18339	145, 179	N805231-S	15522	503,	W520832-S426	12575	145, 178	W707889-S300	20192	424, 481
N800312-S2	15776	93,			536, 607	W525170-S417	19414	302	W708035-S300	20531	423, 482
		102, 130, 135	N805231-S	15522	503,	W525172-S	19110	303	W708045-S300	20532	596
N800369	16422	106, 107			536, 607	W525172-S300	19110	303	W708088-S300	18770	416, 478
N800369-S2	16421	106, 107	N805315	17381	433, 478	W525172-S417	19461	303	W708319-S300	21239	596
N800387-S	11842	433, 475	N805315-S	17381	433, 478	W525174-S	19420	304	W708325-S300	14998	524,
N800466	15325	139	N805350-S	20675	587,	W525174-S300	19420	304		535, 570	
N800484-S58	16736	69, 74			614, 630, 634	W525175-S	19456	304	W708384-S309	20401	613
N800503-S	11841	596	N805592-S100	17121							

O.E.M. INTERCHANGE BY MANUFACTURER

OEM No.	Auveco No.	Page No.	OEM No.	Auveco No.	Page No.	OEM No.	Auveco No.	Page No.	OEM No.	Auveco No.	Page No.
W710250-S300	21089	510, 542, 605	XW4Z-54238A70-AA	20363	499, 540, 610	379830-S	9862	595	390964-S	18682	419, 478
W710312-S300	20761	424, 482	XW7Z-6302354-AAB	20625	431, 482	379830-S	14755	595	391304-S100	17606	388
W710459-S300	20466	552, 597	YF4Z-8194-AA	20400	599	379830-S	14756	595, 617	391305-S100	17607	388
W710528-S300	20817	600	YL3Z-1521970-AA	20153	614, 724	379831-S	8814	177	391396-S100	17604	388
W710532-S300	20926	424, 483	YL3Z-1521970-AB	20153	614, 724	380098-S2	10052	177	391397-S100	17605	388
W710752-SSC	14992	500, 535, 604, 624	YL3Z-1521971-AA	20195	614, 724	380033-S	8306	294	3M8Z-1502316-A	20923	532, 541, 604, 722
W710754-S439	21187	583	YL3Z-1521971-AB	20195	614, 724	380111-S	12949	199	3M8Z-16K262-A	21304	597
W710763-S901	22104	92, 98, 129, 133	YL8Z-16K262-HC	20755	515, 541, 723	380334-S	8310	294	3M8Z-17C432-A	21300	597
W710769-S424	20268	583	YR3Z-13466-AD	B3157A	262	380575-S2	8847	88, 90	3U2Z-14S411-AVA	18867	239
W710791-S437	21215	613	YR3Z-13466-AD	B4157	262	380613-S	4439	197, 399	3U2Z-14S411-BFA	17684	247
W710793-S439	21185	594	YS4Z-13N021-AA	18661	260	380615-S	12209	197, 399	3U2Z-14S411-BGA	18215	250
W710923-S300	18680	430, 478	YS4Z-13N021-AA	20601	260	380707-S	11368	112	3U2Z-14S411-BGB	18215	250
W711031-S300	21826	596	YS4Z-16K262-AA	20191	604	380707-S	11370	106, 110	3U2Z-14S411-BHA	11439	256
W711035-S300	17216	576, 522, 608, 627, 537	YS4Z-6730-AA	20347	278	381671-S	10642	91, 94	3U2Z-14S411-BHB	11439	256
W711037-S300	20949	468, 483	YU5Z-13466-AD	16901	258	381801-S2	15774	91, 96	3U2Z-14S411-BHC	11439	256
W711079-S300	21368	595	YU5Z-13466-AD	16901	258	381818-S2	9880	174	3U2Z-14S411-BXA	17684	247
W711139-S300	8892	293	1008068	21853	454, 486, 701, 815	381863-S2	9879	174	3U2Z-14S411-BXB	17684	247
W711390-S900	22232	122, 125	13235-A	8763	255	382163-S	19826	172	3U2Z-14S411-BYA	19126	246
W711513-S300	21189	469, 483	16758	4248	394	382413-S2	17460	92, 97	3U2Z-14S411-CFA	17661	248
W711521-S300	20616	468, 482	16758A	4155	395	382413-S9	17460	92, 97	3U2Z-14S411-CJAA	17110	240
W711687-S300	21199	420, 483	1725489	21988	812	382443-S	4439	197, 399	3U2Z-14S411-CNA	20561	251
W711712-S300	19118	517, 538, 676	17562	4260	394	382929-S	12729	582	3U2Z-14S411-CNB	20561	251
W711858-S300	21334	438, 484	175720B010	14011	504, 534, 571	382931-S	14533	271	3U2Z-14S411-CVA	17623	247
W712160-S300	21165	597	1R3Z-18D434-BA	21445	611	383000	12929	197	3U2Z-14S411-ECAA	21490	240, 245, 254
W712196-S300	20889	576, 523, 608, 541	1U2Z-14S411-AA	17624	246	383001-S	12929	197	3U2Z-14S411-EA	20246	246
W712665-S300	20993	528, 542, 577, 608	1U2Z-14S411-AAB	17624	246	383001-S	12930	197	3U2Z-14S411-EEA	16693	240
W712930-S437	8892	293	1U2Z-14S411-AEA	20843	249	383003-S	12930	197	3U2Z-14S411-EFA	20549	249
W713202-S300	21172	496, 542, 604	1U2Z-14S411-AJA	18671	250	383003-S100	12930	197	3U2Z-14S411-EHA	20851	252
W713297-S300	21169	469, 483	1U2Z-14S411-APA	20246	246	383003-S101	12931	197	3U2Z-14S411-ESA	20549	249
W713331-S300	20989	512, 574, 541, 608	1U2Z-14S411-ARA	20550	246	383003-S101	12916	198	3U2Z-14S411-ESB	20549	249
W713445-S300	21172	496, 542, 604	1U2Z-14S411-BA	20277	249	383016-S	12916	198	3U2Z-14S411-EUA	16174	238, 245, 254, 255
W713579-S300	21794	456, 486	1U2Z-14S411-BAA	17617	249	383031	12927	199	3U2Z-14S411-EUB	16174	238, 245, 254, 255
W713590-S300	21174	601	1U2Z-14S411-BB	20277	249	383033-S100	10780	409	3U2Z-14S411-FFAA	18216	250
W713610-S300	20988	510, 574, 626, 541	1U2Z-14S411-BCA	16175	239, 245, 254, 255	383033-S100	11863	409	3U2Z-14S411-FKAA	22425	46
W713617-S439	22272	612	1U2Z-14S411-BHA	19125	245	383033-S101	10780	409	3U2Z-14S411-FKAB	22425	46
W713819-S900	21884	308	1U2Z-14S411-BPA	20842	250	383033-S101	11863	409	3U2Z-14S411-FKAC	22425	46
W714004-S900	22264	312	1U2Z-14S411-CA	19582	248	383142-S	20310	502	3U2Z-14S411-FKAE	22425	46
W714040-S300	20880	574, 511, 541	1U2Z-14S411-DA	19126	246	383207-S	14217	540, 606	3U2Z-14S411-FVA	19880	251
W714076-SS3JA	22180	424, 488	1U2Z-14S411-EA	16175	239, 245, 254, 255	383229-S	11104	294, 305	3U2Z-14S411-GA	18819	248
W714584-S300	20766	521, 541, 627	1U2Z-14S411-GB	19125	245	383229-S	11105	294, 305	3U2Z-14S411-GEA	18870	239
W714599-S900	17420	302	1U2Z-14S411-JA	14918	238, 245, 255	383229-S	11106	294, 305	3U2Z-14S411-HNA	17623	247
W714975-S300	20992	523, 542, 576	1U2Z-14S411-KA	18216	250	383255-S36	16770	155	3U2Z-14S411-HZA	20848	245
W715030-S437	8892	293	1U2Z-14S411-NA	17620	248	383356-S	14756	595, 617	3U2Z-14S411-IHA	20848	245
W715201-S300	21668	600	1U2Z-14S411-TA	20851	252	383577-S	11419	199	3U2Z-14S411-JKA	20837	245
W715537-S300	20826	575, 514, 541	1U2Z-14S411-YA	21490	240, 245, 254	383581-S	19418	437, 480	3U2Z-14S411-KBA	20846	251
W715544-S300	22304	611	1U5Z-13466-BB	16901	258	384057-S	12949	199	3U2Z-14S411-KGA	19885	251
W715926-S300	21673	422, 485	1W1Z-19E889-HB	17604	388	384111-S	12949	199	3U2Z-14S411-KHA	18916	239
W715951-S300	22053	431, 488	1W6Z-238A90-AA	20363	499, 540, 610	384111-S	12949	199	3U2Z-14S411-KRA	17623	247
W716156-S303	12255	141	1W6Z-238A91-AA	20363	499, 540, 610	384432-S	19459	310	3U2Z-14S411-KRB	17623	247
W716350-S300	20977	602	2C5Z-13N021-AA	BH11	265	384931-S	17035	88, 90	3U2Z-14S411-KTA	17624	246
W716351-S300	20909	600	2F1Z-9A317-AA	20482	611	385189-S100	1620	302	3U2Z-14S411-LNA	19623	248
W716352-S300	22124	600	2F1Z-9A317-BA	20483	610	385189-S100	16837	302	3U2Z-14S411-LVA	17683	250
W716400-S300	21187	583	2L1Z-7852140-AA	15479	431, 477	385323-S100	1621	304	3U2Z-14S411-MFA	20846	251
W716460-S300	22038	600	309414	16835	524, 536, 670, 624	385323-S100	16838	304	3U2Z-14S411-MGA	17598	249
W716497-S300	21669	600	351050-S3	2309	409	385330-S	11136	441, 475	3U2Z-14S411-MNA	17618	249
W716503-S300	22033	601	351450-S3	2309	409	385353-S	12210	197, 399	3U2Z-14S411-MVA	20547	246
W716507-S300	22269	460, 489	352839	4258	395	385400	15345	155	3U2Z-14S411-MYA	20548	246
W716510-S300	21703	508, 544, 605	353123	1256	409	385595-S	19655	434, 480	3U2Z-14S411-NCA	18668	252
W716529-S900	22289	584, 612, 631	353745-S	2598	193, 400	385661-S	11351	429, 475	3U2Z-14S411-NMA	17662	250
W716783-S300	22431	49	354341-S	5196	170	385677-S	19425	437, 480	3U2Z-14S411-NRA	13644	252
W716969-S300	21703	508, 544, 605	354860-S	4248	394	385974-S	19460	312	3U2Z-14S411-NZA	19882	241
W71736-S300	22154	700	355891	2611	169	386299-S	16954	611	3U2Z-14S411-PCA	18463	246
W717870-S300	18030	537, 506, 573, 626, 537	355811	4246	394	386553-S	19655	434, 480	3U2Z-14S411-PJA	18463	246
W717970-S300	22474	49	357811	2272	409, 634	387042-S	12939	199	3U2Z-14S411-SCA	17112	239
W717984-S417	22333	309, 489	358107	2272	409, 634	387065-S	12932	199	3U2Z-14S411-SFA	19882	241
W718033-S300	22179	451, 488	358470	9361	409	387075-S	12933	199	3U2Z-14S411-SLB	20845	251
W718088-S300	22227	511, 545, 608	358560	19626	824	387182-S	11671	456, 475	3U2Z-14S411-SMA	20845	251
W718365-S300	22284	528, 545, 609	358560	19627	824	387258-S	11679	421, 475	3U2Z-14S411-TDA	18214	247
W718369-S300	22475	49	358560-S100	19626	824	387466-S	12209	197, 399	3U2Z-14S411-UEA	17622	250
W719084-S300	22493	49	370247-S2N	5586	174	387477-S	11797	457, 475	3U2Z-14S411-VBA	19157	251
W719367-S300	22349	497, 545, 607	370374-S	4248	394	387496-S	11672	471, 475	3U2Z-14S411-VZA	16694	239
W725172-S300	19110	303	372741-S100	9864	270	387843-S	11705	500, 534, 606	3U2Z-14S411-VZB	16694	239
W790173-S900	21202	600	372820-S36	12654	314	387944-S	11706	514, 534, 606	3U2Z-14S411-XA	19813	251
W790225-S900	22021	558	372820-S40	12654	314	387980-S	12948	534, 606	3U2Z-14S411-XBA	18216	250
XF5Z-14S411-AA	14918	238, 245, 255	373528-S32	5854	169	388034	12919	198	3U2Z-14S411-XLA	20839	247
XL3Z-											

O.E.M. INTERCHANGE BY MANUFACTURER

OEM No.	Auveco No.	Page No.	OEM No.	Auveco No.	Page No.	OEM No.	Auveco No.	Page No.	OEM No.	Auveco No.	Page No.
57030-S2	10823	88, 89	10184895	13751	298	11500401	15335	139	11503812	12064	121, 123
57030-S36	17034	88, 89	10185925	18301	423, 478	11500421	2775	72	11503815	12322	121, 124
57039-S2	9756	88, 90	10186453	18691	580	11500434	15373	92,	11503823	12693	121, 124
5C3Z-12224-A	18527	241	10195515	14995	495,			98, 128, 132	11503825	13618	122, 126
5C3Z-13466-AA	18016	258		535, 569, 604, 623		11500654	18337	145, 177	11503833	15788	121, 124
5C3Z-13466-AA	18465	258	10201332	19514	309	11500655	11625	145, 177	11503834	12065	121, 124
5C3Z-13N021-AA	BH13	265	10204266	18170	315	11500656	18338	145, 177	11503892	15373	92,
5F7Z-13466-B	20285	259	10207146	17226	501,						98, 128, 132
5L8Z-16828-AA	16954	611		537, 573		11500657	11626	145, 178			
5R3Z-54310D12-AAA	21024	507,	10211824	10831	425, 475	11500658	11628	145, 179	11503941	13617	121, 124
		542, 608, 722	10220168	18688	431, 478	11500660	11629	145, 179	11503957	11864	145, 178
5R3Z-54310D12-BAA	21560	422,	10229437	18680	430, 478	11500661	11630	145, 179	11503958	12669	145, 178
		485, 720	10237960	19220	585	11500662	11631	145, 179	11503982	13715	121, 124
5U2Z-14S411-SA	19156	250	10241518	18688	431, 478	11500663	18339	145, 179	11504010	15721	91,
5U2Z-14S411-SB	19156	250	10242285	20521	563	11500754	11935	122, 126			96, 128, 131
5U2Z-14S411-TA	19156	250	10242316	18680	430, 478	1150086	12350	94,	11504035	11627	145, 179
5U2Z-14S411-VA	19582	248	10246149	19788	569,			104, 130, 137	11504047	16842	145, 178
5U2Z-14S411-XA	22425	46		493, 539		11500970	12336	122, 126	11504056	12738	92,
5U2Z-14S411-ZB	20842	250	10249241	19501	431, 480	11500971	12348	122, 127			98, 128, 132
6000121	13173	810, 822	10261327	19410	554	11500994	12057	93,	11504119	16980	141
6C3Z-17A386-AA	3682	112	10262036	18684	415, 478	11500996	12339	94,	11504230	1943	71
6E5Z-13466-AC	B4157K	262	10262143	19247	551	11500997	12354	94,	11504288	12667	145, 179
6E5Z-7850980-AAA	21024	507,	10270517	20464	565			103, 130, 136	11504492	12348	122, 127
		542, 608, 722	10270672	19390	557	11501102	13613	122, 126	11504493	12323	121, 125
6G1Z-5410182-A	20977	602	10274778	19819	404	11501105	11633	122, 126	11504531	9879	174
6G1Z-5410182-C	20979	600	10277480	19676	551	11501152	13613	122, 126	11504536	13002	168
6W1Z-5422008-A	18890	615	10278936	17654	299	11501188	13614	122, 127	11504565	13619	122, 127
7L3Z-9S317-A	21126	611	10280874	18680	430, 478	11501193	11641	122, 127	11504570	12067	121, 124
7L3Z-9S317-B	21127	611	10280874	18688	431, 478	11501194	13620	128	11504614	15327	139
7U2Z-14S411-FA	17621	250	10281487	20395	585	11501794	12739	91,	11504659	2710	69
800843	12935	197	10283414	19368	438, 480			95, 128, 131	11504693	11626	145, 178
801471	12922	198	10285935	19270	457, 479	11501800	15334	139	11504978	12666	145, 178
803716-S	14018	512,	10287379	20261	122, 125	11501814	12254	140	11504981	12068	94,
		534, 608	10287547	20408	558	11501835	12253	141	11504982	103, 130, 136	
91GBA611A08EAW	18387	612	10287926	20232	402, 556	11501836	12255	141	11504984	12667	145, 178
9L3Z-14030A12-A	20836	400	10287971	19275	457, 479	11501849	12260	141	11504985	12068	94,
9N7Z-13N021-A	16897	260	10293193	20893	417, 483	11501850	11645	140	11505005	12596	139
9N7Z-13N021-A	B9005	264	10293674	19149	417, 479	11501883	12059	91,	11505022	12351	93,
			10297368	19381	563			96, 128, 131	11505023	12339	94,
FREIGHTLINER			10297369	20521	563	11501884	12060	97, 128, 132	11505044	18416	122, 126
22-44567-000	19844	639	10297370	20825	563	11501889	11644	140	11505104	13712	91,
			10297371	19379	563	11501896	12061	91,			96, 128, 131
GENERAL MOTORS			10298115	19486	549	11501903	12062	91,	11505182	14053	129, 130
03762180	4265	394	10299660	19449	437, 480	11501932	12253	141	11505209	13618	122, 126
05480853	8889	293	10300287	20353	563	11501937	12119	141	11505326	15790	122, 126
10003294	12919	198	10301966	20365	509,	11502449	15373	92,	11505329	12595	139, 821
10003617	12927	199		540, 574		11502483	12097	98, 128, 132	11505596	16268	139, 821
10004121	12943	199	10305191	20814	458, 482	11502504	12125	141	11506101	11645	140
10005510	14968	582	10308019	20521	563	11502507	15711	141	11506117	15335	139
10008002	8814	177	10319395	20859	259	11502540	12115	141	11506174	12693	121, 124
10008002	10052	177	10323057	20607	561	11502540	12115	141	11507036	11644	140
10009923	12259	141	10341794	20464	565	11502540	12115	141	11507036	16269	140
10013764	11352	583	10350983	21346	456, 484	11502540	12115	141	11508023	12322	121, 124
10014363	12997	167	10351052	21347	551	11502540	12115	141	11508241	12575	145, 178
10017487	12931	197	10352797	20809	560	11502540	12115	141	11508269	13614	122, 127
10017615	14677	278	10352798	20973	560	11502540	12115	141	11508275	15330	139
10018202	12695	156	10352799	20808	560	11502540	12115	141	11508430	12339	94,
10027015	17230	551	10352803	19800	559	11502540	12115	141			103, 130, 136
10031004	18014	258	10352804	20974	560	11502540	12115	141	11508900	12253	141
10032838	12713	552,	10352804	20974	560	11502540	12115	141	11508927	13002	168
		618, 765	10352809	20775	560	11502540	12115	141	11508930	15791	121, 123
10036503	14023	297	10352810	19800	559	11502540	12115	141	11509005	18449	145, 178
10040001	9282	287	10352810	19800	559	11502540	12115	141	11509189	12350	94,
10041588	14527	175	10353835	20811	560	11502540	12115	141			104, 130, 137
10051034	15467	404	10363352	21177	565	11502540	12115	141	11509371	12057	93,
10053182	14997	500,	10363811	20634	456, 482	11502540	12115	141	11509374	12741	91,
		535, 569	10369649	21240	460, 484	11502540	12115	141			97, 128, 132
10053388	15045	536, 578	10382313	21176	527,	11502540	12115	141	11509511	11639	122, 126
			10383817	21157	565	11502540	12115	141	11509535	15711	141
10062	12253	141	10384814	20950	565	11502540	12115	141	11509589	11638	122, 126
10062367	16695	458, 477	10403591	19449	437, 480	11502540	12115	141	11509816	12067	121, 124
10063599	18683	415, 478	10405030	19368	438, 480	11502540	12115	141	11509932	12253	141
10069112	15488	297	10408480	19527	457, 480	11502540	12115	141	11510062	12253	141
10073833	12992	472, 475	10410398	19220	585	11502540	12115	141	11513599	21040	145, 177
10077283	15042	530,	10416890	19757	559	11502540	12115	141	11513798	20600	260
		535, 578	10421018	20338	458, 481	11502540	12115	141	11513801	BH3	265
10078274	18897	417, 479	10423331	19783	706, 786	11502540	12115	141			98, 128, 132
10082288	18390	558		540, 574		11502540	12115	141	11513864	12064	121, 123
10084751	19644	145, 179	10423332	19783	598,	11502540	12115	141	11514282	15711	141
10087223	15462	403	10423332	19783	598,	11502540	12115	141	11514290	10067	174
10089262	14987	493,	10423553	20481	563	11502540	12115	141	11514343	11639	122, 126
		535, 569, 623	10425306	20365	509,	11502540	12115	141	11514518	11644	140
10098645	18682	419, 478		540, 574		11502540	12115	141	11514596	11644	140
10108746	16625	522,	10426555	21400	579,</						

O.E.M. INTERCHANGE BY MANUFACTURER

OEM No.	Auveco No.	Page No.	OEM No.	Auveco No.	Page No.	OEM No.	Auveco No.	Page No.	OEM No.	Auveco No.	Page No.
11516150	12667	145, 179	11562250	21242	562	11610198	20529	553	12052922	16806	218
11516152	18339	145, 179	11562256	20998	457, 483	11610210	21114	306	12065158	18150	214
11516372	20416	145, 178	11562257	20999	457, 483	11610271	3079	71	12066214	14881	218
11516397	20339	145, 177	11562287	20634	456, 482	11610383	21124	313	12066614	20231	220
11516440	3079	71	11562364	21187	583	11610495	21793	562	12076946	17175	237
11516596	13705	122, 127	11562503	21753	584	11610522	21157	565	12083005	16585	238
11516656	20935	563	11562563	21128	561	11610544	22410	47	12083006	16586	238
11516780	15335	139	11562568	22034	469, 488	11610605	21488	450, 485	12083007	17108	236
11516807	20741	311	11562588	21047	278	11610606	21489	453, 485	12083460	18924	236
11516811	13755	297	11569618	20423	586	11610705	20938	551	12083680	17172	238
11516936	18927	310	11569663	18811	293	11610747	21301	428, 484	12083689	17173	238
11516942	13619	122, 127	11569697	21161	565	11610748	21302	580	12084595	15948	215
11517071	11708	139	11569700	22031	468, 488	11611110	21672	511,	12084912	20209	220
11517293	12596	139	11569768	11146	425, 475			544, 574,	12084913	20210	220
11517343	12065	121, 124	11569917	20423	586	11611367	22268	559	12085270	20752	223
11517517	12324	121, 123	11569917	22121	586	11611375	21825	558	12085330	17174	238
11517700	19449	437, 480	11570082	13614	122, 127	11611435	21827	565	12085483	18916	239
11517706	13619	122, 127	11570512	21156	562	11611623	22080	559	12085485	19882	241
11517803	16622	512, 571	11570637	22070	92,	11611626	21739	566	12085490	16968	242
		536, 575			98, 129, 133	11611651	21439	310		250, 254, 255,	256
11517824	19297	502, 539	11570654	22289	584, 612, 631	11611651	21737	307	12085491	16968	242
		552				11611677	22233	433, 489		250, 254, 255,	256
11517873	20452	552	11570830	21674	551	11611822	21488	450, 485	12085495	18868	239
11517992	20615	433, 482	11570846	21370	564	11612035	22100	519,	12085496	17114	239
11517996	11708	139	11570887	22027	563			545, 575	12085497	18524	239
11518017	17216	576,	11571118	21535	457, 485	11612122	22036	562	12085498	16694	239
	522, 608, 627, 537	576,	11571119	21536	457, 485	11612122	22036	562	12085502	16964	241
	20632	576,	11571159	21443	432, 485	1165051	19626	824	12085503	16514	240
		523, 541, 608	11571175	20934	562	117971	19627	824	12085506	18918	242
11518201	20281	429, 481	11571175	21242	562	119005	16897	260	12085507	16965	241
11518357	20377	561	11571175	21374	562, 622	1196781	3682	112	12085525	17109	240
11518531	21027	584	11571175	21536	457, 485	12001470	13549	236	12085526	17109	240
11518684	20415	585, 613	11571175	21242	562	12003757	13546	238	12085527	17109	240
11518908	20395	585	11571175	21374	562, 622	12003758	13545	238	12085528	17109	240
11518937	22117	585	11571175	21374	562, 622	12003759	12600	238, 253	12085533	17199	241
11518988	21036	564	11588308	18461	308	12003878	13544	237	12085538	18917	240
11519030	21189	469, 483	11588308	21327	297	12004005	12536	235	12089040	14150	215
11519031	20616	468, 482	11588415	18337	145, 177	12004009	12540	235	12089188	14151	215
11519032	21189	469, 483	11588441	21351	586	12004010	16359	235	12089189	13659	209
11519408	21047	278	11588650	20883	583	12004010	16359	235	12089189	19258	209
11519444	14010	528, 571, 625	11588782	19732	553	12004188	19199	229	12089190	13669	209
		513,	11588818	19732	553	12004201	8775	216	12089190	19259	209
		540, 575	11588863	21200	564	12004311	12237	236,	12089191	13678	209
11519444	20631	575, 512, 541	11588863	20944	456, 483			244, 253	12089191	19262	209
		574,	11588988	20631	575, 512, 541	12010085	15948	215	12089305	15948	215
11519444	20888	574, 512, 627, 541	11589015	12738	92,	12010182	15937	215	12089306	18325	215
		524,			98, 128, 132	12010293	18326	216	12089307	20747	215
11519807	18896	538, 576	11589111	21439	310	12010300	15955	216	12089340	16806	218
11519818	19783	598, 706, 786	11589176	20972	560	12010717	15953	214	12089649	14883	217
		575,	11589181	21199	420, 483	12010973	15951	214	12092075	16360	235
11519949	19239	575,	11589182	20868	564	12010975	18146	214	12092080	16355	235
	518, 538, 648, 676, 738	586	11589244	20891	566	12010996	15949	214	12092081	16354	235
11519952	20422	586	11589289	19801	573,	12012000	14884	222	12092344	20227	219
11519960	20423	586	11589289	500, 607, 626, 539	510,	12013813	13543	238	12094429	20583	222
1154604	19957	637	11589289	20988	510,	12014012	14462	215	12101820	19891	240
1154605	19958	637	11589290	574, 626, 541	506,	12014254	20751	223	12101855	18870	239
1154606	19944	637	11589290	14007	505,	12014836	14153	216	12101856	18320	239
1154607	19945	637	11589290	534, 571, 625	570,	12014837	14154	216	12101857	18318	239
1154610	19954	637	11589290	14753	570,	12015024	18148	214	12101859	18318	239
1154611	19955	637	11589290	20880	574,	12015193	12546	235	12101869	18151	214
11546343	22451	47	11589290	574, 626, 541	506,	12015193	20618	216	12101879	13559	256
11546588	22240	450, 489	11589290	13996	506,	12015323	20618	216	12101880	18867	239
11546635	22036	562	11589290	534, 574	574, 626, 541	12015631	19795	580, 271	12101895	17109	240
11546805	22071	448, 488	11589290	14007	505,	12015791	15950	214	12101897	16174	238,
11546963	22278	453, 489	11589290	534, 571, 625	570,	12015792	15952	214		245, 254, 255	
11546964	22279	454, 489	11589290	14753	570,	12015793	15954	214	12101898	16175	239,
11547024	22276	559	11589290	534, 571, 625	570,	12015797	18145	214		245, 254, 255	
11547026	22080	559	11589290	506, 605, 624, 535	535,	12015798	18147	214	12101903	17690	242
11547026	22080	559	11589290	20880	574,	12015799	18151	214	12101906	16967	239
11547026	22167	559	11589291	511, 541	511, 541,	12015857	14881	218	12101909	13548	243
11547047	22259	455, 489	11589291	20989	512,	12015858	20216	218	12101909	17691	243
11547210	22029	563	11589291	574, 541, 608	574, 541, 608	12015861	15938	219	12101917	13686	233
11547211	22258	561	11589292	20991	522,	12015862	15948	215	12101927	19554	242
11547339	22228	555	11589292	542, 576	542, 576	12015870	15945	220	12101937	17113	240
11547341	21835	621	11589293	20889	576,	12015878	17002	216	12101939	18871	243
11547446	22277	585	11589293	523, 608, 541	523, 608, 541	12015899	20749	215	12102568	17463	242
11547574	21488	450, 485	11589294	20992	523,	12015917	18324	215	12102620	16693	240
11547581	22492	48	11589294	523, 608, 541	523, 608, 541	12015972	15952	214	12102621	14580	241
11547582	22491	47	11589295	20993	528,	12015983	16941	581, 271	12102664	21490	240,
11547601	22278	453, 489	11589295	542, 577, 608	542, 577, 608	12020116	14880	218		245, 254	
11547602	22279	454, 489	11589296	20994	528,	12020120	15939	219	12102747	17110	240
11561143	12127	141	11589296	542, 577	542, 577	12020320	1948	217	12102748	18527	241
11561329	21200	564	11609292	22035	586	12020321	18650	217	12102757	19555	243
11561334	22266	313	11609292	20422	586	12020347	15935	217	12103360	20230	219
11561349	20766	521,	11609317	12575	145, 178	12020757	14883	217	12103881	15497	217
		524,	11609385	12596	139	12020801	20748	215	12110842	20217	219
11561353	14998	541, 627	11609411	12596	139	12021333	18923	238	12110843	20218	219
		574,	11609417	20826	575,	12022960	17463	242	12110844	20222	219
11561368	20888	535, 570	11609417	20826	575,	12033674	14150	215	12110845	20225	219
		512, 627, 541			514, 541	12033817	15960	217	12110846	20225	219
11561448	18153	584	11609483	21377	580	12034046	15947	218	12110847	20224	219
11561491	20884	564	11609535	20527	553	12034047	15948	218	12112171	13644	252
11561499	21383	456, 484	11609536								

O.E.M. INTERCHANGE BY MANUFACTURER

OEM No.	Auveco No.	Page No.	OEM No.	Auveco No.	Page No.	OEM No.	Auveco No.	Page No.	OEM No.	Auveco No.	Page No.
12126452	15952	214	14007510	13232	88,	15116576	20935	563	15762170	14921	416, 476
12126470	16967	239			89, 167	15127746	20934	562	15763285	14921	416, 476
12126473	18527	241	14007511	14976	88,	15149708	19639	573,	15769308	21290	586
12126487	17112	239			89, 167			505, 626, 539	15772605	16908	258
12129373	20213	217	14007940	12999	167	15153415	19615	576,	15772605	B2057A	262
12129409	20223	219	14008227	12210	197, 399			522, 539	15773445	14753	570,
12129484	20212	217	14011722	11109	88, 90	15175428	12930	197		506, 605, 624,	535
12129493	18658	218	14013246	13960	550	15199562	B4114K	262	15786626	19819	404
12129497	18659	218	14017701	12930	197	15209748	21106	233	15802005	21338	428,
12159662	17172	238	14017705	12923	198	15221959	20865	560			484
12160374	20665	271, 581	14017779	12947	199	152266	8375	176	15822417	21474	233
12160551	20211	220	14017780	12924	198	152267	8372	176	15824471	20945	638
12160857	20514	582	14019205	12567	571,	152273	15677	176	15828918	B3157A	262
12160858	20397	271, 581			505, 625, 534	15227654	20792	397	15862271	20859	259
12167116	18916	239	14019206	14007	505,	15227655	20792	397	15862656	21033	242
12167121	18867	239			534, 571, 625	15236893	20951	564	15862656	21542	242
12176844	19853	582	14019206	14007	505,	15236894	20952	561	15864780	22037	565
12186456	20220	218			534, 571, 625	15266057	20666	571,	15872008	20884	564
12186457	20221	219	14019225	14007	505,			494, 541	15893516	20885	561
12187091	17111	240			534, 571, 625	15281294	20864	549	15931605	21379	469, 484
12191645	16351	235	14019226	14011	504,	15282120	20935	563	15944588	21248	428, 484
12337831	20892	567,			534, 571	15284612	20529	553	15953247	17649	472, 478
		532, 541	14022878	12621	555	15288146	20885	561	15954398	19429	552
12337852	14031	550	14023108	12925	198	15289020	20527	553	15955172	13752	298
12337868	15518	588	14025274	12916	198	15296830	20990	514,	15955232	17654	299
12337873	10054	177	14027471	12759	431, 475			575, 542, 627	15955523	18169	309
12337898	17341	404	14027775	20799	397	15300530	19882	241	15956062	14998	524,
12337900	16953	580	14027776	20800	397	15305932	18524	239			535, 570
12337915	15490	298	14027777	20793	397	15306157	21006	237	15956470		
12337916	15783	88, 90	14027778	20794	397	15306302	17111	240			
12337917	22669	145, 178	14029095	12940	199	15326410	19836	418, 481	15958694	11146	425, 477
12337920	12737	472, 475	14031114	12926	198	15328724	16352	235	15958694	15414	425, 477
12337920	14524	472, 476	14031144	12916	198	15502538	8931	294	15959832	18268	530,
12337966	11630	145, 179	14031145	12932	199	15505451	16251	168			537, 578
12338011	15467	404	14031900	16880	140	15506827	14012	297	15959833	18334	530,
12338015	17437	592	14032200	14008	533,	1550971	18474	259			538, 578
12338025	13009	168			534, 567	15516462	18749	311	15960325	18353	497,
12338034	15453	396	14032291	14009	552	15545178	18926	588			538, 579
12338074	16936	593	14037239	18926	588	15545202	15670	472, 477	15960621	19355	572,
12338089	12594	555	14039420	14001	504,	15562609	16937	593			496, 539
12338096	12824	555			534, 568	15562610	17976	592	15963179	16938	457, 477
12338100	15518	588	14040999	16322	145, 178	15577924	15459	586	15964853	13966	170, 765
12338114	9112	191	14045480	14010	528,	15589071	20797	397	15964971	16936	593
12338123	2775	72			534, 571, 625	1559072	20798	397	15964972	16937	593
12338146	8814	177	14047034	12929	197	15588024	19046	472, 476	15967691	19424	592
12338146	10052	177	14048060	13005	168	15588078	14032	424, 476	15969147	17216	576,
12338153	11621	304	14051674	15518	588	15591860	19424	592			
12353912	15463	403	140663981	13750	298	15592279	14031	550			
12354949	11083	229	14066728	17437	592	15596280	14037	552, 618	15975244	19834	427, 481
12354969	15948	215	14070914	13749	297	15596301	13946	472, 476	15986343	18371	424, 478
12354970	15937	215	14071289	14011	504,	15598757	15792	88, 90	15986673	19356	457, 480
12355104	9481	213			534, 571	15600382	12992	472, 475	15989431	21380	432, 484
12355107	14150	215	14074081	14036	424, 476	15606409	20792	397	15989487	19387	579
12355107	14153	216	14078435	11852	303	15607165	15970	472, 477	15990756	18030	537,
12375975	22453	48	14082956	18817	91,	15612948	15970	472, 477			
1244839	9665	567, 824			97, 128, 132	15614746	21028	297			506, 573, 626, 537
12450053	18001	258	14083173	14820	584, 612	15614774	18244	311	15993201	16622	512,
12450143	8884	263	14090382	19278	92,	15622490	17615	306			536, 575
12450143	8893	263			98, 129, 132	15632790	17508	585	15994165	20542	504,
12450176	20595	260	14090908	16026	275	15638413	16938	457, 477			540, 573
12450313	8921	262	14093088	14020	529,	15641800	11110	88, 90	1600375	10759	547
1247872	15459	586			535, 577, 609	15648833	14988	493,	1605396	11146	425, 475
12506490	20008	637	14093311	10831	425, 475	15650655	9880	535, 604	1605396	15414	425, 477
12519975	18417	556	14093869	14980	141	15653790	19781	591	1606642	11657	547
12530252	17654	299	14100784	17382	585	15659161	17072	436, 477	1610403	12917	198
12531209	19441	602	14101262	15702	529,	15672149	19242	568,	1611249	20364	92, 100
12531210	19441	602			536, 577			492, 538	1614858	12931	197
12533567	17103	500,	14103026	12084	301	15672183	19782	591	1617333	12919	198
		536, 573, 607	14103026	17424	302	15672328	17599	474, 478	1618890	11470	547, 634
12540326	19725	591	14103435	16953	580	15672330	14998	524,	1618890	11657	547
12547778	20089	638	14103438	15042	530,			535, 570	1619321	12137	430, 475
1254815	11838	549			526,	15672713	18167	304	1619321	16263	430, 477
1255823	11865	552, 595	14103461	15043	526,	15678493	17215	434, 477	1621253	12935	197
1257702	14217	582,			535, 577	15678979	18948	417,	1631564	15478	430, 477
		610, 634	14103461	15045	530,			479, 749	1635218	12999	167
1260888	19166	175			536, 578	15679091	14953	567,	1636632	16624	505,
1264963	12713	552,	142451	20292	259			532, 535, 603			536, 573
		618, 765	142451	B68	262	15681408	17103	500,	1638575	19162	175
127934	16910	258	142452	16911	258			536, 573, 607	1640810	15373	92,
127934	B57	262	142452	20705	267	15682898	18262	584			
1304225	4249	395	142453	18015	258	15683327	21387	583			
131282	16914	258	142454	16926	258	15685040	19424	592			
13144822	21541	93,	142456	16923	258	15685099	20415	585, 613	1644290	18948	417,
		101, 130, 135	142456	B1141	262	15686047	15792	88, 90			
13252118	21365	450, 484	145525	14388	270	15686142	18153	584	16500308	14016	490,
13252119	21364	453, 484	1477728	5592	442, 475	15690531	18744	298			534, 572, 625
13265959	21168	638	1480627	8359	176	15691478	17216	576,	16502342	20301	106, 109
13265959	22168	435, 488	1480909	8377	176						

O.E.M. INTERCHANGE BY MANUFACTURER

OEM No.	Auveco No.	Page No.	OEM No.	Auveco No.	Page No.	OEM No.	Auveco No.	Page No.	OEM No.	Auveco No.	Page No.
16632192	16937	593	20298365	11677	472, 475	21039129	17975	434, 478	22704458	20634	456, 482
16632193	16936	593	20319841	12731	429, 475	21039141	17215	434, 477	22713392	20634	456, 482
16633853	17069	587	20325696	12656	306	21042045	17218	455, 477	22717568	20483	610
16640343	19658	588	20328600	15467	404	21042053	17218	455, 477	22718305	15480	429, 477
16643104	17069	587	20338568	13925	554	21042058	17218	455, 477	22718369	21238	571,
16659130	20279	472, 481	20340710	15463	403	21042098	17214	569,			530, 542
16662182	19519	583, 631	20345137	14549	592		493, 623, 537		22722859	20634	456, 482
16674629	20189	427, 481	20346654	14217	582,	21042104	17218	455, 477	22722860	20635	553
16675980	19658	588			610, 634	21042108	20829	454, 482	22884291	22430	48
16715497	17468	298, 308	20348200	12315	593	21047094	16816	497,	23223178	20945	638
16723225	12084	301	20351035	12065	121, 124			536, 572	23262603	21168	638
16723225	17427	302	20363491	13999	490,	21075686	17222	572,	23372321	20158	638
1688094	11425	555			534, 572		500, 607, 537		23372322	20945	638
1689827	12095	91, 96	20374473	12737	472, 475	21077123	19801	573,	23372327	21168	638
1706200	13828	556	20374473	14524	472, 476		500, 607, 626, 539		24100042	21047	278
1729250	11485	412, 554	20376243	4441	395	21077131	17616	531,	2419255	8905	294
1732326	12315	593	20393536	14033	556			537, 578	24205245	20528	416, 482
1746408	18817	91,	20413107	11612	418, 475	21077323	17226	501,	24233099	21093	278
	97, 128, 132		20421672	13752	298			537, 573	24405739	22024	559
176653	16134	141, 823	20421800	12992	472, 475	21077405	17227	490,	24405740	22022	559
17988488	14820	584, 612	20423550	15774	91, 96			537, 570	24449408	21540	143,
17997722	14820	584, 612	20423647	13747	297	21077575	18033	440, 478			178, 770
19115561	11083	229	20426301	14260	498,	21093588	17219	556	24501057	21090	428, 483
19115586	19199	229		535, 568, 722, 801		21094146	16818	423, 477	24571185	16026	275
19115640	21476	233	20429451	13992	472, 476	21094240	18515	121, 123	24574578	14988	493,
19115673	17112	239	20429500	14553	593	21094747	17220	297			535, 604
19116359	21475	233	20430956	13858	582	21095797	18896	524,	2477054	8895	293
19119304	21752	235	20432975	13748	297			538, 576	2495701	8938	294
19130464	10649	273	20433026	13753	298	21097229	19854	572,	25015169	12237	236
19130464	14547	581, 271	20444103	13458	556			490, 539			244, 253
19130464	20471	581, 271	20451119	13457	568,	21098967	19397	403	2501569	12237	236
19149964	20450	140			505, 534	21110145	16816	497,			244, 253
19152583	14524	472, 476	20451401	13461	471,			536, 572	25016383	11612	418, 475
19168446	19258	209			475	21110201	16818	423, 477	25016383	11680	418, 475
19168447	13669	209	20452072	14753	570,	21170767	19397	403	25099299	20163	579,
19168448	19262	209		506, 605, 624, 535		21992748	20482	611			495, 540
19171104	17111	240	20453400	12064	121, 123	2201406	12522	156, 157	25117765	18925	240
19179416	20872	588	20455900	14006	417, 476	2201407	12520	156, 157	25508532	12566	553, 618
19183888	20758	707, 789	20461373	13856	580	2207713	16132	426,	25512081	12729	582
19183917	20757	708, 789	20462090	16865	566, 413			477, 823	25512688	19162	175
19206781	15499	217	20465395	14005	297	22189414	20360	427, 482	25514221	11675	420, 475
19209790	21828	235	20475950	14014	550, 811	22505958	12934	197	25522466	9285	287
19209791	21829	235	20477732	16687	308	22508049	12932	199	25524005	14004	297
19209792	21830	235	20478294	13860	580	22508050	12918	198	25525798	14220	552
19209793	21831	235	20478295	13456	580	22508051	12937	197	25526447	19435	552
19209793	21831	235	20478732	17159	404	22508052	12927	199	25527289	14822	172
19209794	21832	235	20478733	15462	403	22508803	11419	199	25530441	14527	175
19209795	21833	235	20480475	13453	471, 475	22512276	12766	430, 475	25535963	19472	580, 610
19209796	21834	235	2048248	11673	429, 475	22512276	16262	430, 477	25536302	14820	584, 612
19209797	21749	235	20487630	15463	403	22512857	12605	548	25552853	18423	557
19209798	21750	235	20487631	17341	404	22513813	12605	548	25552856	17979	556
19209799	21751	235	20493450	17455	404	22516030	20450	140	25554845	19361	554
19209800	21752	235	20510029	13993	573,	22527147	18748	584	25556911	19166	575
19257054	16898	260		506, 534, 607, 626		22527720	14035	424, 476	25580123	19519	583, 631
19257054	B9006	264	20511451	13454	421, 475	22529733	2293	173	25601491	18174	423, 478
19257055	B9004	264	20514862	15367	420, 477	22531616	11631	145, 179	25603960	18389	416, 478
19257057	20599	260	20538173	18302	416, 478	22535007	15044	530,	25605716	14527	175
19257375	17112	239	20547865	14147	529,			536, 578	25609048	17641	311
19258649	21006	237			535, 577	22536642	18298	417, 478	25612368	22058	496,
19260056	21487	591	20551451	13454	421, 475	22537749	14220	552			545, 604
19260058	21404	590	20570245	13994	529,	22538004	14993	506,	25612415	22459	49
19260060	21403	589			577, 534, 609	22538102	14990	570,	25618730	17121	310
19260061	21406	590	20582532	18392	587			535, 579	25630331	19411	557
19260063	21444	590	20582533	18393	587	22539533	15462	403	25631448	19417	94,
19260086	17172	238	20590899	13996	506,	22542705	15045	530,			104, 130, 137, 579, 629
19260663	21072	589			534, 574			536, 578	25640501	3138	171
19260663	21582	590	20603072	11152	401, 402	22543363	17176	404	25642453	17103	500,
19299324	20485	588	20606417	14946	554	22547243	15543	426, 477			536, 573, 607
19300089	13659	209	20612732	13746	297	22550254	17545	554	25648693	20280	557
19302122	21092	588	20624923	14014	550, 811	22550254	15684	303	25649667	20466	552, 597
193065	18474	259	20626174	19394	404	22566142	17106	495,	25655537	10831	425, 475
19326896	15948	215	20632190	17666	566, 413	22566221		536, 572	25663903	20265	570,
19329253	17112	239	20633148	18392	587						529, 540
19329763	20485	588	20633149	18393	587	22569178	18927	310	25670009	18848	455, 479
19352194	22088	308	20633504	15463	403	22578985	18911	554	25672428	20279	472, 481
19355537	22423	48	20635065	13994	529,	22579423	18927	310	25680782	14991	570,
1999366	16898	260			577, 534, 609	22585836	18912	310			506, 605, 535
1999367	20859	259	20641977	18218	252	22587036	18310	529,	25693852	19822	561
1999482	20620	259	2064891	10621	471, 475			538, 577	25695687	18992	571,
20003056	20427	469, 482	2064891	16260	471, 477	22587341	12081	301			530, 539
20030401	15457	433, 477	20652520	18679	430, 478	22595587	14988	493,	25696301	19758	470, 481
20032850	11679	421, 475	20664091	14753	570,			535, 604	25704141	19758	470, 481
20037597	12314	593			506, 605, 624, 535	22595723	18930	469, 479	25704358	21428	552
20043351	19183	592	20664092	14753	570,	22599312	20263	402, 556	25705182	21517	94,
20043361	19183	592			506, 605, 624, 535	22600612	18930	469, 479			104, 130, 137, 579
20046147	14559	591	20687704	16624	505,	22600614	18930	469, 479	25707329	20244	515,
20058837	18398	566, 413			505,	22600614	18930	469, 479			540, 579
20064875	15456	433, 477	20699808	14921	416, 476	22603384	19820	560	25718851	20326	559
20085729	17073	405	20712172	15463	403	22615352	19732	553	25722671	20318	557
20097200	12569	595, 617	20712176	15463	403	22638717	13750	298	25724529	20774	562
2011554	12084	301	20713843	15684	303	22638717	20740	311	25732397	21081	106, 109
2011554	17427	302	20732399	10831	425, 475	22641917	18912	310	25742293	20976	560
20123070	15467	404	20734005	17092	472, 477	22642756	20262	430, 481	25744385	21503	565
20130258	13002	168	20747508	17341	404	22643056	18889	313	25749564		

O.E.M. INTERCHANGE BY MANUFACTURER

OEM No.	Auveco No.	Page No.	OEM No.	Auveco No.	Page No.	OEM No.	Auveco No.	Page No.	OEM No.	Auveco No.	Page No.
2962448	8777	217	3927320	9481	213	513388	4243	394	88860480	17621	250
2962510	11440	242, 254	3944866	9965	567, 824	516637	8744	156	88860481	17622	250
2962953	17115	221	3944866	12971	567, 824	528846	13004	168	88860482	20389	253
2962984	8775	216	3946988	2710	69	5297428	18952	212	88860484	20610	466, 673
2962987	8776	216	3946988	2710	69	534343	11831	582			
2965142	15957	216	3960314	10362	88, 89	547944	4439	197, 399	88860485	18530	243
2965470	14892	221	3963228	11738	198	5480766	19505	787	88860486	17624	246
2965580	15504	221	3970076	12922	198	5480772	20863	577, 787	88860487	17623	247
2971962	15956	216	3977775	11130	434, 475			525, 541	88860488	17598	249
2973215	18690	218	3982098	8359	176	5480852	20756	562	88860489	17684	247
2973216	18651	218	3984469	10653	72	5480853	8889	293	88860492	18525	242
2973932	9905	236, 253	3985058	11424	550	5482087	21284	582	88860494	18464	246
2974309	8756	237	3986997	11109	88, 90	5482103	20881	450, 483	88860495	18463	246
2977373	11442	243	3997391	14030	550, 811	5485676	17216	576	88860496	20277	249
2977607	11444	242	3998009	15759	588			522, 608, 627, 537	88860497	18819	248
2978302	8755	236	4001934	13467	435, 475	549790	11640	122, 127	88860498	14130	245
2978302X	8755	236	4001934	13467	435, 475	554343	11831	582	88860499	18215	250
30006620	19257	466	400764	4473	396	55568037	21650	279	88860500	18676	247
	479, 711, 798		400765	4474	396	55577568	22360	46	88860501	20841	247
30008324	19243	568	406511	12922	198	596196	11665	547	88860502	18216	250
		501, 538	407217	11110	88, 90	556539	11667	548	88860505	11440	242, 251
30012018	14696	498	4081765	4188	394	556992	12932	199	88860507	19076	251
	535, 678, 694, 752		409988	4417	389	557057	11655	548	88860509	20172	247
30020637	20908	517	411700	11721	417, 475	557057	11871	548	88860510	20547	246
	541, 777, 804		4137121	4242	394	559312	11655	548	88860511	20548	246
3065575	11796	472, 475	413945	8744	156	559312	11871	548	88860512	18673	246
3065575	16261	472, 477	416629	12069	410	560625	12937	197	88860514	20246	246
3078511	11130	434, 475	4234830	15518	588	560692	11419	199	88860515	20550	246
3297373	11442	243	4301446	15759	588	562327	11831	582	88860518	17598	249
332364	10831	425, 475	4417599	8447	825	5655006	9905	236, 253	88860524	19885	251
332364	16259	425, 477	444613	9278	287	568792	19626	824	88860526	19126	246
342271	16253	168	444619	9279	287	568792	19627	824	88860527	19125	245
343541	11243	547	444620	9279	287	574355	19626	824	88860537	20844	247
343543	11246	547	444667	9285	287	574355	19627	824	88860538	19157	251
343555	11243	547	444676	9283	287	575411	12961	824	88860546	19881	247
343555	11245	547	444777	9283	287	575411	12961	824	88860549	11436	243
343555	11246	547	444777	9283	287	588546	15037	91, 95	88860551	19880	251
345510	11154	237	444777	9283	287	5949838	3178	548	88860552	20549	249
347065	16237	168	444782	9284	287	5953005	5788	548	88860558	19890	245
347347	13450	549	444789	9285	287	5963268	11156	237	88860559	19623	248
347893	11292	172	445429	11292	172	5973400	12757	572	88860561	19883	248
3526573	19358	556	4457495	10220	554				88860578	18920	253
3533539	16940	312	4457595	10220	554	5973823	19847	571	88860584	11444	242
3533539	19057	294	4459049	9342	413			528, 534	88860585	11445	252
35366964	21047	278	4490167	9477	566	5973996	12756	572	88860586	13541	253
3536966	18665	275	4492962	10318	556			529, 534	88860589	20849	248
3537056	18685	427, 478	4492962	11288	554	612019	9298	154	88860592	22184	246
3538469	21047	278	4495047	9367	586	6263345	11138	554	88861015	5220	256
3538874	18394	530	4533699	8583	401	6270163	10832	425, 475	88861017	5225	256
		538, 628	4536999	8583	401	6271903	20801	397	88861018	8759	236
3540161	16940	312	454626	16919	258	6271904	20803	397	88861020	8761	244
3540161	19057	294	454645	16925	258	6271905	20802	397	88861022	17690	242
354076	11246	547	454646	18004	258	6271906	20804	397	88861047	5196	170
3540858	18308	514	455136	16920	258	6271989	14559	591	88861050	8764	256
		537, 575	455490	16918	258	6272766	12918	198	88861073	13548	243
354400	12939	199	4563173	4240	396	6276604	3617	413	88861075	20561	251
3548804	18685	427, 478	4564974	4264	395	6280765	3617	413	88861078	20843	249
357020	12918	198	4565415	4240	396	6288704	8777	217	88861084	20845	251
358501	8746	156	458030	12316	593	6292995	12629	227	88861089	20853	247
362069	11638	122, 126	4628769	19626	824	6292995	15372	226	88861091	20851	252
362379	11245	547	4628769	19626	824	6294493	13548	243	88861094	20842	250
363137	15461	471, 477	4637277	20175	824	6294737	15935	217	88861095	20842	250
363137	16017	471, 477	4657731	2628	402	6298886	9883	236, 244	88861096	20852	249
365266	11826	547	4676189	19807	824	6298886	11166	236, 244	88861101	5226	256
365270	11718	547	4689929	2744	824	6298886	13558	236	88862211	16514	240
3655015	4233	395	4689929	2818	824	6298892	9883	236, 244	88862213	18217	248
3664645	4237	394	4689929	2818	824	6298892	13558	236	88862214	14580	241
367291	14976	88	4689929	12962	824	6298935	9883	236, 244	88862215	17112	239
		89, 167	4699315	2619	824	6299087	11157	237, 253	88862216	17109	240
367292	12995	167	470433	20795	397	6466355	12920	198	88862217	16694	239
367292	12996	167	470434	20796	397	7634583	9275	401	88862218	17107	241
3688699	8963	846	4721222	4281	396	7637192	4441	395	88862219	18918	242
3688811	4235	394	4723818	12961	824	7642589	13467	435, 475	88862220	16693	240
3689084	4236	396	4723818	12961	824	7693140	9639	401	88862223	16967	239
3691599	11371	616	472434	11699	571,	7693976	9633	401	88862225	18916	239
3693292	4250	395		506, 624, 534		7724826	4447	395	88862226	17110	240
3711168	4265	394	472450	15453	396	7730788	9749	401	88862227	18917	240
3722635	2619	824	472812	12935	197	7731589	10632	412	88862228	17111	240
3722635	12958	824	472814	12921	198	796255	11349	471, 475	88862229	17114	239
3744999	2752	824	472815	12922	198	821240	18952	212	88862230	17113	240
3744999	12960	824	4730773	20175	824	8717859	10243	401	88862231	16965	241
3745361	4280	394	474821	14976	88,	8731909	3620	442, 475	88862232	16964	241
3762180	4280	394				8731909	11120	416, 475	88862235	17683	250
3783002	5278	106, 107				8733059	10318	556	88862238	18527	241
3783006	5228	112				8733059	11288	554	88862241	13644	252
3783794	5195	169				8734067	10242	401	88862247	17690	242
380370	8418	112	4755299	8435	112	8736585	9749	401	88862255	18674	241
380382	9829	549	4759145	2943	567, 824	8736586	9639	401	88862256	19891	240
3816659	10649	273	4761842	2943	567, 824	8736586	9639	401	88862260	18870	239
3828472	18329	310	4767559	4446	395	8763591	9633	401	88862262	17199	241
383569	8623	87	4778814	2744	824	879350	10617	555	88862264	21490	240, 254
383569	8624	87	4778814	2744	824	88860426	9883	236, 244			
383569	8625	87	4778814	12962	824	88860429	8756	237	88862266	19556	242
3846202	15783	88, 90	4779348	2943	567, 824	88860432	12237	236	88862267	19882	241
3863669	8942	549	4801268	3620	442, 475				88862271	18925	240
3866846	15345	155	480534	19418	437, 480	88860434	9905	236, 253	88862273	19554	242
3876130	16240	168	4853108	8398	825	88860442	14135	244	88862274	19555	243
389089	13757	435, 476	4872948	4446	395	88860444	14130	245	88862276	19813	251

O.E.M. INTERCHANGE BY MANUFACTURER

OEM No.	Auveco No.	Page No.	OEM No.	Auveco No.	Page No.	OEM No.	Auveco No.	Page No.	OEM No.	Auveco No.	Page No.
88909763	12553	235	916581	9884	243	9437643	20402	303	96061699	14367	415,
88909764	12554	235	916581	9885	243	9437846	14486	303		476, 719	
88909765	12555	235	916632	9916	243	9437938	11621	304	96061863	17356	583
88909766	12556	235	916638	9884	243	9437938	16838	304	96064506	19128	516,
88909769	12547	235	916638	9885	243	9438068	18012	258		538, 803	
88909770	15505	235	92095787	B885	263	9438068	B194A	262	9617200	11118	413, 566
88909771	15506	235	92138636	22219	512,	9438150	11246	547	9624520	11066	401
88909772	15507	235			545, 575	9438848	16907	258	9662548	17233	567
88909773	15508	235	92138807	22226	565	9438848	B2057	262	9662950	11067	401
88909774	15509	235	92138808	22225	564	9438850	16908	258	9669486	11855	550, 764
8891030	15673	587, 630	92138811	22220	467, 489	9439559	18749	311	9685057	11678	471, 475
8891031	15673	587, 630	92138865	22222	558	9439719	12657	312	9711304	15759	588
88938226	14921	416, 476	92138942	20515	466, 482	9440178	9879	174	97134978	17355	402, 694
88953358	21033	242	92139070	22224	558	9441592	18167	304	9716926	14549	592
88953358	21542	242	92139147	22041	532,	9441723	B890	263	9721917	14550	592, 615
88961517	12669	145, 178			545, 567	9441724	20598	263	9731301	11152	401, 402
88969790	20576	449,	92139150	22089	307	9441724	B891	263	9786454	9354	87
		482, 795	92231490	18501	297	9441728	B880	263	9786454	9355	87
88970345	20559	459,	93356553	19781	591	9441731	16896	260	9786454	9356	87
		482, 711, 797	94051993	16859	497,	9441732	16897	260	9795883	10068	87
88970493	17481	780			536, 569, 751	9441732	B9005	264	9796223	10714	94, 104
88970494	20577	568,	9411017	9265	284	9441733	16898	260	9808241	10630	402
		515, 541, 712, 803	9411019	9266	284	9441770	8938	294	9815325	14967	587,
88970495	20578	556, 781	9411022	9257	283	9441837	18017	258		614, 630, 634	
88970656	20575	463,	9411031	9260	283	9441837	B24	262	9818648	10621	471, 475
		482, 711, 798	94113207	17271	551	9441838	18000	258	9822198	14548	592
88970747	19729	445,	94145515	17076	427,	9441838	20721	267	9838109	10318	556
		480, 709, 793	9414716	3079	71	9441838	B2357A	262	9838109	11288	554
88970766	21687	715, 807	9414723	1943	71	9441839	16915	258	9854717	10631	402
88970767	20869	507,	9414723	2808	71	9441839	20722	267	9882774	8853	437, 475
		574, 541, 713, 802	9414767	2734	69	9441839	B3057	262	9883583	10621	471, 475
88973654	20578	556, 781	9415465	2366	71	9441840	16916	258	9883583	11774	471, 475
88973676	20577	568,	9416042	2712	69	9441840	B3057A	262	9883583	16260	471, 477
		515, 541, 712, 803	9416444	2709	69	9441854	17998	258	9895598	10701	401
88974848	B194	262	9416927	16909	258	9441866	17999	258			
88980509	20872	588	9416927	20715	267	9441866	20720	267	217-770	15932	233
88980510	20872	588	9417276	B1893	262	9441866	B2357	262	217-771	15933	233
88981030	15674	587, 630	9417561	1937	71	9441923	18018	258	33111-SR3-A01	18661	260
88981031	15673	587, 630	9417863	20285	259	9441923	B24A	262	33111-SR3-A01	20601	260
88986451	18868	239	9417863	16906	258	9441941	2808	258	33115-SB4-A01	B9005	264
88987187	21220	240, 255	9417866	B1895	262	9441956	18005	258	33116-S2A-003	BH1	264
88987962	17109	240	9417866	16904	258	9442003	17996	258	33116-SB4-A11	B9006	264
88988301	18527	241	94178705	B1156	262	9442004	B3156	262	33116-S7-003	BD2S	264
88988447	19582	248		18876	465,	9442081	17997	258	33165-SAA-003	BH11	265
88988609	21212	240	9419740	5655	70	9442361	17641	311	33165-TL0-003	16694	239
8900524	11948	217	94198687	14697	568,	9442486	18001	258	33303-SD4-671	16901	258
8901283	11166	236, 244		496, 535, 678, 722	98, 128, 132	9442486	B3157A	262	34301-692A-0000	14317	665
89023920	21168	638	9420052	12097	92,	9442492	18478	259	34355-SD2-003	15997	659
89024363	20945	638		98, 128, 132	92,	9442877	B881	263	34906-SLO-A01	20296	259
8902487	11446	237	9420850	11923	71	9442878	20596	260	34906-SLO-A01	20730	267
89025539	20485	588	9421330	16902	258	9442879	20683	260	38211-SD2-000	15932	233
89025543	21092	588	9421330	16902	258	9442880	B889	263	38212-SE0-000	15933	233
89025546	21072	589	9421330	B194	262	9442881	20599	260	38529-689A-6300	14323	447,
89026634	21385	433, 484	9421777	16912	258	94467458	17355	402, 694		476, 671	
89026634	21386	433, 484	9421777	B97	262	94515248	22527	47	60658-SB3-000	17289	681
8903020	11154	237	94218027	17195	597,	94515340	16136	139	60658-SD2-000	17289	681
8903020	11475	237		620, 658, 694, 735	520, 658, 694, 735	94530438	21112	569,	66421-634-000	14291	442,
8903020	11476	237	9422339	14727	567,			499, 542		476, 668	
8903283	11446	237	9422339	532, 535, 694, 755	18469	94530565	21070	460,	66435-648-000	14291	442,
8903488	12629	227	9422552	11292	172		483, 687, 698	460,	66435-648-0000	14291	442,
8903488	15372	226	94226492	14269	464,	94530623	17267	521,		476, 668	
8903489	12628	227		476, 694, 721, 799	106, 108			537, 649	71144-SR3-A00	18415	668
8904437	11156	237	9423101	19777	106, 108	94530624	18119	537, 629	71591-S5A-000	21636	661
89057707	18218	252	9424837	9880	174	94530742	21316	579	71592-S5D-000	20603	658
89057711	17620	248	9425491	9881	174	94748652	22161	558	71598-S30-013	20677	658
89057714	13548	243	9425542	16921	258	94841130	14277	786	72311-S10-003	19673	417,
89057717	20838	252	9425542	20706	267	94841226	14750	143,		480, 673	
89057718	19887	248	9425542	B168	262			725, 807	72311-S5S-003	21704	440,
89057721	11440	242, 254	9426331	12547	235	94841764	13932	736, 785		486, 645, 674	
89057722	11442	243	9426334	12545	235	94842543	17224	785	72431-S2X-003	21639	642, 660
8905794	20471	581, 271	9427587	18013	258	94842841	18297	443,	73154-TA0-A01	22273	664
8909518	11156	237	9427761	10666	172			478, 708, 791	73156-TA0-A03	22165	665
8909908	11446	237	9427882	9282	287	94847334	17383	492,	73862-672-003	14299	436,
8911472	14546	581, 271	9427909	8925	294		537, 570, 777, 800	492,	73862-672-0030	14299	436,
8911473	14544	581, 271	9427943	20289	259	94848189	18330	441, 478		476, 673	
8911497	14545	581, 271	9428481	3796	172	94848192	18330	441, 478	74806-SB6-003	16825	665
8912698	11157	237, 253	9428902	16899	258	94848834	15695	558, 779	74842-659-003	16779	448,
8912750	13540	236	9428902	B1157	262	94849113	18297	443,		477, 671, 793	
8913369	14885	222	9428904	16901	258			478, 708, 791	74842-659-0030	16779	448,
8914822	11154	237	9428904	B1157A	262	94852368	19140	568,		477, 671, 793	
8914822	11475	237	9431530	9880	174		522, 624, 538, 649, 739, 804	568,	75305-S0A-003	20783	660
8914823	11476	237	9431532	10067	174	94853733	18939	512,	75305-SH2-003	20784	660
8915135	12629	227	9431647	2293	173			538, 712	75305-SH4-003	20785	660
8915136	12628	227	9431808	16913	258	94854203	19194	551, 788	75305-SHJ-003	21186	659
8917283	17002	216	9431809	18011	258	94858299	18876	465,	75305-SM4-A01	21556	660
8917320	14547	581, 271	9432137	16687	308			479, 798	75306-SDA-A01	20782	662
8917444	11083	229	9432552	16686	307	94858338	19312	419,	75306-SV1-A01	20602	660
8918527	9883	236, 244	9432645	11246	547			480, 790	75306-SZA-A01	21470	659
8918527	11166	236, 244	9433040	18010	258	94858343	19726	568,	75307-SN7-000	20570	140,
8919916	13543	238	9433043	11628	145, 179			496, 539		681, 734	
8933059	10318	556	9433143	20286	259	94858509	19729	445,	75315-S9A-004	22136	671
8933059	11288	554	9433156	20582	174		480, 709, 793	445,	75315-TP6-A01	22465	671
90230846	22527	47	9433184	18016	258	94858560	18873	513,	75316-S9A-004	21557	642, 659
90321122	21088	452, 483	9433185	18811	293			538, 803	75316-TP6-A01	22464	51
90560163	22336	458, 489	9433186	18168	312	94858864	19645	568,	75329		

O.E.M. INTERCHANGE BY MANUFACTURER

OEM No.	Auveco No.	Page No.	OEM No.	Auveco No.	Page No.	OEM No.	Auveco No.	Page No.	OEM No.	Auveco No.	Page No.
90107-S0X-A01	21521	644, 668	90667-SA7-0030	16775	426, 670, 749	91502-S84-A11	19683	441, 480, 674	91530-SP1-003	18877	440, 479, 645, 674
90107-S10-003	19533	668	90667-SA7-003ZB	16775	426, 670, 749	91502-S9A-003	21216	661, 524, 536, 679	91530-SS0-003	18864	663
90107-SX0-003	19734	644, 668	90667-TC0-U01-ZA	22415	52	91502-SM4-400	17143	524, 536, 679	91530-ST5-003	19116	440, 479, 674
90108-S00-003	20331	658	90668-SB0-003	14698	508, 535, 678	91502-SM4-000	19407	524, 539, 679	91531-ST0-003	19359	662
90108-SW3-003	19470	422, 480, 669	90669-671-000	14284	272, 680, 806	91502-SP0-003	18119	523, 537, 679	91533-SG0-000	19186	492, 538, 647, 675
90109-SW3-003	19470	422, 480, 669	90669-671-0000	14284	272, 680, 806	91503-S3Y-003	21419	661, 518, 542, 676	91534-SE0-000	17443	659
90114-SE0-000	20259	93, 100, 129, 134	90669-671-003	14284	272, 680, 806	91503-S7A-003	21297	518, 542, 676	91534-SE0-003	17443	659
90114-SZ3-000	20259	93, 100, 129, 134	90669-SB0-003	19487	735	91503-SHJ-A01	21454	520, 543, 677	91545-SE0-003	16782	520, 536, 677, 753
90116-S82-A01	19439	658	90669-SP0-003ZA	19744	422, 481, 670	91503-SWA-A01	22466	51	91545-SE0-003-W1	16782	520, 536, 677, 753
90212-SA5-003	16470	140, 681	90669-SP0-003ZB	19744	422, 481, 670	91503-SZ3-003	19233	519, 538, 648, 676	91547-SE0-003	14688	680
90301-ST0-003	12118	141	90670-692-003	16781	444, 477, 669, 792	91503-SZ5-003	20564	522, 540, 649, 677	91547-SE0-0030	14688	680
90418-SW3-003	19470	422, 480, 669	90670-SG0-003	19741	667	91503-T1W-003	22446	52	91550-S50-000ZK	21477	503, 543, 677
90471-PX4-000	16955	275	90670-SOD-003ZK	21303	419, 484, 669	91503-T2A-A01	21796	661	91550-S50-000ZL	21190	503, 542, 677
90501-SDR-003	22419	53	90671-SDA-A01	20740	311	91504-S2A-003	22518	51	91550-SH3-003	19142	499, 538, 678
90505-SM4-003	17057	512, 536, 678	90672-671-003	18157	444, 478, 668	91504-SM4-000	17144	523, 536, 679	91550-SH3-003ZR	19142	499, 538, 678
90505-SX0-003	19453	510, 539, 676	90672-671-8110M1	14268	667, 787	91504-SP1-003	21558	642, 661	91558-SE3-003	21388	649, 680
90601-SH3-014	17442	661	90672-SA0-003	14298	272, 680, 725	91504-SR3-003	20432	679	91560-S04-003	22243	450, 489, 671
90601-SMG-003	22242	659	90672-SA0-0030	14298	272, 680, 725	91504-TBA-A01	22263	445, 489, 669	91560-S0X-A01	21638	460, 485, 672
90602-S2A-003	21696	449, 486, 671	90672-SA6-003	14700	664	91505-S9A-003	20986	519	91560-S6A-003	21206	463, 483, 673
90602-S5A-003	21059	467, 483, 647, 673	90672-SA6-0030	14700	664	91505-SG0-003	17280	643, 664	91560-S7A-003	21554	461, 485, 672
90602-S7S-003	20611	449, 482, 671	90672-SC6-003	14700	664	91505-S77-003ZA	20910	504, 541, 677	91560-S84-A01	21149	459, 483, 672
90602-SAA-003	21087	465, 483, 673	90673-SC6-003	14703	664	91505-TM8-003	21706	486, 520, 648, 676	91560-S84-A11	20411	461, 482, 647, 672
90602-SX0-003	21107	451, 483, 646, 671	90673-SC6-0030	14703	664	91506-S9A-003	21173	521, 542, 648, 676	91560-S9A-A01	20959	462, 483, 647, 672
90602-TA0-003	21417	646, 671	90674-SB0-000	14268	667, 787	91507-SH3-003	17632	508, 537, 605, 688, 722	91560-SL4-003	20610	466, 482, 673
90603-S7S-003	20612	666	90675-692-003	14306	659	91508-S50-003	19547	504, 539, 675	91560-SLJ-J01	21208	461, 483, 647, 672
90612-SF1-003	17320	662	90675-692-0031	14306	659	91508-SM4-003	17192	509, 537, 675	91560-SM4-003	20610	466, 482, 673
90617-TBA-A01	22262	659	90675-SA5-003	22105	145, 178, 681	91508-SR3-000	18165	504, 537, 675	91560-SP0-003	19145	461, 479, 647, 671
90650-S5A-003	22365	51	90675-SA6-003	14294	665	91510-SR3-003	17981	661	91560-SZW-003	21675	460, 485, 672
90651-SL9-013	19454	668	90675-SA6-0030	14294	665	91512-S50-003	21555	642, 660	91560-SZW-J01	21676	462, 485, 672
90651-SL9-0130	19454	668	90675-SB0-003	16000	516, 536, 679, 723, 753	91512-SE0-003	18512	679	91560-TX4-A01	22499	52
90651-T3L-003	22469	52	90675-SB3-003	16000	516, 536, 679, 723, 753	91512-SF1-003	22514	52	91561-S84-A00-M1	20352	504, 540, 678
90651-TP8-003	21705	440, 486, 645, 674	90676-SA7-003	17058	665	91512-SJ6-J01	21559	642, 659	91561-S84-A01	19415	662
90652-SB2-023	16949	680	90676-SR4-003	18115	668	91512-SJK-003	22069	519, 545, 648, 677	91561-S84-A21ZB	20352	504, 540, 678
90653-HC4-900	17222	572, 500, 607, 537	90677-671-003	14687	680	91512-SM4-003	17379	516, 537, 679	91561-SJD-003	21141	509, 542, 673
90654-SA4-003	19730	680	90677-693-003	14687	680	91512-SR3-004	20472	141, 645, 668	91561-TA0-A11	22394	53
90655-SA0-003	14288	665	90677-SE0-003	16950	680	91512-STK-A01	22112	519, 544, 648, 677	91562-S84-A01	20737	661
90655-SA0-0030	14288	665	90679-692-003	14308	659	91512-SX0-003	19239	575, 518, 538, 648, 676, 738	91562-SV4-003	18405	662
90656-671-6310M1	14287	665	90682-SB0-003	17058	665	91513-SE0-003	18818	441, 479, 674	91562-SV4-003	21707	440, 486, 645, 674, 794
90657-SA5-003	22199	498, 545, 647, 675	90682-SDA-A01	21205	667	91513-SJK-003	22068	331	91566-SP0-003	18294	467, 478, 673
90657-SA6-003	14697	568, 496, 535, 678, 722	90682-SEA-003	20954	644, 667	91513-SM4-000	17096	662	91567-S3M-000	21458	415, 485, 673
90657-SA6-0030	14697	568, 496, 535, 678, 722	90683-693-000	14690	666, 745	91513-SMG-E01	22241	659	91567-SR2-013	21548	415, 485, 709, 794
90657-SB0-003	19186	492, 538, 647, 675	90683-693-0000	14690	666, 745	91513-SMG-E11	21207	659	91568-SR2-003	19171	439, 479, 674
90658-SB0-003	14701	663	90683-SA5-003	14696	498, 476, 748	91513-TOA-A01	22463	51	91568-TR0-003	21705	440, 486, 645, 674
90658-SB0-0030	14701	663	90684-SA5-003	14696	498, 476, 748	91514-SAA-003	22283	661	91570-SDA-A01	21095	663
90661-SC7-003	14695	667, 717, 736, 743, 787	90685-SA5-003	14356	448, 476, 748	91514-SLN-A01	22434	52	91570-SK7-003ZF	19546	505, 539, 678
90661-SC7-0030	14695	667, 717, 736, 743, 787	90687-671-003	14319	448, 476, 671	91514-SMG-E01	22433	51	91570-SZA-305	21543	644, 663
90662-671-003	14313	666, 717, 742	90687-671-0030	14319	448, 476, 671	91514-SYP-003	22468	52	91571-SDA-A01	21096	663
90662-671-0030	14313	666, 717, 742	90687-SA5-003	14282	443, 476, 668	91514-TF0-003	22482	52	91572-SDA-A01	21094	664
90662-693-003	14281	667, 787	90687-SB0-003	17287	495, 537, 678	91514-TR3-A01	22367	52	91572-SV4-003	18404	664
90662-693-0031	14281	667, 787	90687-SB0-013	17287	495, 537, 678	91515-SR4-003	19737	661	91576-SV4-003	19477	643, 662
90662-SB2-003	14313	666, 717, 742	90687-SB2-901ZF	17287	495, 537, 678	91516-SK7-013	17350	520, 537, 679, 754	91577-SV4-003	19476	643, 662
90664-671-003	14328	436, 476, 673	90688-SB0-003	14968	582	91516-SM4-013	19116	440, 479, 674	91578-SV4-003	18457	658
90664-SB0-004	15472	664	90688-SB0-013	14968	582	91517-SE0-003	19247	551	91578-TOA-003	21836	658
90664-SB3-003	20303	667	90694-SB0-003	17281	664	91518-S10-003	19682	446, 480, 670	91589-SV4-003	20272	661
90665-SA0-9700	12576	658	90694-SB0-0030	17281	664	91518-SM4-003	19114	446, 479, 646, 670	91591-SJ6-013	21170	649, 680
90665-SM4-000	19646	667	90700-SB2-003	15998	432, 477, 670	91519-S5A-003	20387	663	91603-SL0-000	21635	666
90666-SA0-003	14289	418, 476, 669	90713-SB0-003	14705	664	91519-SCV-A01	21597	662	91604-SD2-013	18454	680
90666-SA0-0030	14289	418, 476, 669	90866-SA0-000	20350	665	91520-S5A-003	20386	663	91619-SA5-000	14274	666, 717, 742, 785
90666-SA0-003A3	14289	418, 476, 669	91213-SZA-A01	22467	51	91520-SM4-000	21295	442, 484, 747	91619-SM4-003	19117	666
90666-SA0-003A9	14289	418, 476, 669	91500-SM4-999AH	16960	106, 109	91520-SM4-C01	18114	446, 478, 645, 670	91620-SR2-003	19307	666
90666-SA0-003ZD	14289	418, 476, 669	91501-S04-003	19118	517, 538, 676	91520-SM4-003	19114	446, 478, 645, 670	91623-SM2-003	19143	667
90666-SD9-000	20351	665	91501-S1K-003	20609	435, 482, 646, 670	91524-SE0-003	17081	508, 536, 678	91623-SM2-0030	19143	667
90667-671-013ZA	20381	444, 482, 669, 737, 748	91501-SEA-003	20882	445, 483, 669	91527-SM4-003	19415	662	91626-SH3-003	19741	667
90667-SOD-003ZC	20334	422, 481, 669	91501-SM4-003	17205	447, 477, 671	91527-SZ3-003	19415	662	91626-SP0-003	21700	645, 668
90667-SA0-003	16776	422, 477, 670, 749	91501-SM5-A00	19680	662	91528-S01-A01	19115	664	91635-SM4-003	17609	666
90667-SA0-0030	16776	422, 477, 670, 749	91501-SNA-003	22054	445, 488, 669	91528-SR4-003	19115	664	94109-14000	16956	275
90667-SA7-003	16775										

O.E.M. INTERCHANGE BY MANUFACTURER

OEM No.	Auveco No.	Page No.	OEM No.	Auveco No.	Page No.	OEM No.	Auveco No.	Page No.	OEM No.	Auveco No.	Page No.
90269-04050	20628	306	AB8-6A	19058	294	G030-68-885-B-38	14709	420,	8133-50-022	14380	448,
90269-04051	20788	305	ABL4-2A	8922	294			476, 720			476, 720
90269-04053	20627	306	ABL4-4A	8931	294	G031-58-762	18692	439,	9924-90-512B	14367	415,
90269-04060	21714	307	ABL4-8A	20474	294			478, 720, 794			476, 719
90269-05034	21713	311	ABL6-10A	19057	294	G032-68-865A-00	21560	422,	9926-40-531B	18271	444,
90269-05056	21713	311	ABL6-4A	19055	294			485, 720			478, 719
90269-05065	21046	311	ABL6-6A	8313	294	G14S-50-EA1	21769	495,	9926-40-543	14349	442,
90269-A0006	20788	305	ABL6-8	19051	294			544, 721			476, 719, 747
90341-10006	19318	277	ABL6-8A	19056	294	G18K-51-SJ3	20932	452,	9926-50-625	14260	498,
90341-10011	19318	277	AC4-2	8908	294			483, 720			476, 719, 747
90341-10012	19318	277	AC4-2A	8299	294	G350-68-AB1	18824	458,	9926-50-635	14369	515,
90341-12012	21293	277	AC4-4	8914	294			479, 721			535, 568, 722, 801
90467-05020	19506	420,	AC4-4A	8928	294	G46L-50-EB1	22517	55			535, 723
	480, 646, 669		HP-2	7915	295	G6JA-50-Z5	20957	716	9927-40-821	14363	470,
90467-05114	20956	143,	HP-30B	7983	295	GA2A-56-399A	19753	718			476, 721
	175, 715, 807		HP-30C	7984	295	GA2A-56-694	14709	420,	9927-40-822	16778	470,
90467-05125	21693	419,	HP-30D	7985	295			476, 720			477, 721, 795
	486, 708		HP-30N	7981	295, 305	GA2A-58-762	19481	480, 721	9927-40-825	14269	464,
90467-05136	21849	496,	SB3-4	19045	293			480, 721			476, 694, 721, 799
	544, 712, 801		SB4-1	19046	293	GA5R-56-392	19306	502,	9927-70-901	14378	724
90467-05138	21687	715, 807	SB4-2	5749	293			539, 722	9927-80-404	14365	724
90467-05170	22125	491,	SB4-3	8874	293	GD7A-50-EA1	20755	515,	9927-80-405	14359	724
	545, 712, 800		SB4-4	5753	293			541, 723	9928-90-753	14376	272, 725
90467-06005	22472	60	SB4-6	8880	293	GHP9-50-355	22448	46	9928-91-053	14298	272,
90467-06015-C0	22214	443,	SB4-8	8882	293	GJ21-50-034	17060	603, 724			680, 725
	489, 791		SB5-2	8883	293	GJ21-50-049	17003	612, 725	9956-41-400	19621	275
90467-06092	17991	441,	SB5-4	8886	293	GJ21-50-H81	17551	598, 718	9991-00-402	14366	717, 743
	478, 710		SB6-10	8902	293	GJ21-50-H82	17552	598, 718	9991-00-403	14364	717
90647-06192	22487	60	SB6-2	8889	293	GJ21-58-502A	19743	718	9991-00-412	13930	717, 742
90467-06205-C0	22495	60	SB6-4	8892	293	GJ21-58885-A69	18206	508,	9991-00-501	14357	717
90467-07049-C0	20874	431,	SB6-6	8895	293			537, 608, 723	9991-00-503	14313	666,
	483, 708		SB6-8	8899	293	GJ21-68-885B-02	21024	507,			717, 742, 785
90467-07066-14	17383	492,	SBL4-2	8291	293			542, 608, 722	9CF600516B	22294	93,
	537, 570, 777, 800		SBL4-12	18814	293	GJ21-68-885-B02	18206	508,			101, 129, 134
90467-07066-22	17383	492,	SBL6-4	8293	293	GJ21-68885-B69	18206	508,	9GG600616T	22293	121, 123
	537, 570, 777, 800		SBL6-6	18811	293			537, 608, 723	9XG0-73-88X0	20936	603, 715
90467-07117	18270	504,	SBL6-8	18812	293	GJ21-68-885-B69	18206	508,	9XG0-75-93X0	20190	468, 481
	18270		SC4-2	5751	293			537, 608, 723	9XG1-10-37X	20190	468, 481
90467-07121-C0	19908	515,	SC4-4	8303	293	GJ6A-50-025	20957	716			
	540, 803		SSB4-4S	19060	294	GJ6A-50-ES1	21304	597	MERCEDES BENZ		
90467-07137	21692	443,	SSB6-8S	19061	294	GJ6A-58-975	21743	718	A901-988-00-25	21843	728, 813
	486, 709		SSBN4-3	11104	294, 305	GJ6A-68-162	20958	716	000-987-10-81	13157	728
90467-07138	17992	518,	53130	12657	312	GJ6A-68-AB1	18824	458,	000-988-15-81	13141	727
	537, 712		53181	12654	314			479, 721	000-988-16-25	20647	728
90467-07138-C0	17992	518,				GJ6A-68-AB1	20983	460,	000-988-55-81	13144	728
	537, 712							483, 720	000-988-76-81	13141	727
90467-07201	20955	713, 804				GJ6E-50-715-A	20923	532,	000-988-86-25	20404	728
90467-07211	21201	513,						541, 604, 722	000-990-03-92	13230	490,
	542, 713					GJ6E-50-715-B	20923	532,			534, 730, 823
90467-07217	22400	62,						541, 604, 722	000-990-22-92	13230	490,
90467-08180	20910	504,				GJ6R-68-ABX	20983	460,			534, 730, 823
	541, 677							483, 720	000-990-29-92	19195	502,
90467-08224	22396	69				GK2A-50-798	21300	597	000-990-29-92	19195	502,
90467-09101	18939	512,				GM9E-63-938A	20960	716	000-990-34-92	20187	538, 818
	538, 712					GS3L-68-615	21413	717	000-990-34-92	20187	491,
90467-09138	17990	444,				H001-50-609	14719	716	000-990-37-92	20314	540, 730, 817
	478, 709					H001-50-841	14695	667,	000-990-37-92	20314	496,
90467-09169-C0	22395	60				B092-50-715	17195	597,	000-990-40-92	20640	540, 730
90467-09237	22353	708				B092-51-833	620, 658, 694, 735	717, 736, 743, 787	000-990-40-92	20640	494,
90467-10152	19534	707, 789				B100-68-8550	21110	509,	000-990-44-92	20639	541, 730
90467-10170-C0	21702	509,				B101-68-252-00	17478	497,	000-990-44-92	20639	494,
	544, 713, 802					B27K-51-PS7	22049	511,	000-990-46-92	20641	731
90467-10181	22351	703, 779				B455-56-135	21862	725	000-990-54-92	20234	500,
90467-10183	20869	507,				B455-56-741	18458	446,	000-990-54-92	20234	540, 654, 730
	574, 541, 713, 802							478, 719	000-990-57-92	20642	449,
90467-10190	21537	704				B45A-56-146A	22424	56, 62	000-990-60-92	21859	502,
90467-11117	22051	707, 785				B467-68-AC3-02	21858	543,	000-990-60-92	21859	544, 730, 757, 823
90467-12071	21698	705				BM450355	20971	308	000-990-84-92	21037	491,
90467-12072	21848	704				BM450355	20971	308	000-990-84-92	21037	542, 730
90467-12074	21697	704				BC1D-56-145	19315	516,	000-990-90-51	20234	500,
90467-A0002-C0	22473	61						539, 723	000-991-01-98	22309	461,
90467-A0004	22350	705, 781				BC1M-50-0Z5	20984	716	000-991-01-98	22309	489, 729
90467-A0005	21102	463,				BF67-50-033	15366	603, 724	000-991-49-40	22306	517,
	483, 711, 798					BF67-50-235	17450	603, 724	000-991-49-40	22306	545, 731
90467-A0007	22471	61				BF82-50-233	16843	533,	000-991-59-32	22265	314
90467-A0008	20878	426,						536, 724, 755	000-991-59-40	21711	493,
	483, 708, 790					BG74-56-145	22515	56	000-991-63-98	22252	544, 730
90467-A0009	18297	443,				BN8F-50-355	22501	46	000-991-63-98-64	22252	489, 729
	478, 708, 791					BP4K-58-762	21307	446,	000-991-63-98-M22	22252	451,
90467-A0016-C0	17162	499,						484, 719	000-991-73-98	22307	727
	536, 571, 801					BP4L-51-SJ3	21171	716	000-991-74-98	22254	448,
90541-09124	22490	59				BW0A-50-792	19138	598, 718	000-994-04-45	13224	142, 732
90901-89004	20660	707				BW0B-69-240	19393	404	000-994-06-45	13218	142,
90950-01620	22097	714, 806				C274-50-133	22519	55	000-994-06-45	13218	656, 733
						D001-56-731	22516	55	000-994-09-45	13220	144,
						D10E-51-SJ3	22511	56	000-994-14-45	13215	733, 757, 823
						E11451W24	21561	715	000-994-14-45	13215	656, 733
						E120-68-AB1	22484	49	000-994-14-45	13215	142,
								56, 57	000-994-14-45	13216	142,
						EA01-50-037	21663	491	000-994-25-45	13223	770, 820
								544, 721	001-988-03-25	21105	

O.E.M. INTERCHANGE BY MANUFACTURER

OEM No.	Auveco No.	Page No.	OEM No.	Auveco No.	Page No.	OEM No.	Auveco No.	Page No.	OEM No.	Auveco No.	Page No.
001-988-60-81	21468	726	51-71-1-496-621	21143	437,	MU840016	15927	233	01553-05131	21637	693, 756
001-988-63-81	21469	726			483, 734	MU840021	15931	233	01553-05233	22301	689, 740
001-988-76-81	20205	727	51-71-7-127-742	21716	733	106212	14335	736, 743	01553-05323	21192	518,
001-988-80-81	21465	727	51-77-7-171-002	21787	454,	58974-0008	17195	597,		542, 693, 723, 754	
001-988-97-81	22310	437,			486, 653, 734		620, 658, 694, 735		01553-05751	22000	739
		489, 728							01553-05751	16860	739
001-990-00-91	20651	142, 733							01553-05933	21192	518,
001-990-01-92	22339	531,	MITSUBISHI			MOTORCRAFT				542, 693, 723, 754	
		545, 731	AB009006	16898	260	WPT-118	20851	252	01553-06071	21620	499,
001-990-169-2	21859	502,	HB121467	14720	448,	WPT-159	20842	250			543, 752
	544, 730, 757, 823				476, 737	WPT-169	20843	249	01553-06451	22075	422,
001-990-16-92	19195	502,	MB020923	19385	445,	WPT-173	18671	250		488, 691, 749	
		538, 818			480, 737	WPT-335	20848	245	01553-06721	17347	518,
001-991-26-98	22305	460,	MB023930	14366	717, 743	WPT-793	22425	46			537, 754
		489, 729	MB029111	14277	786				01553-07111	20669	465,
001-994-98-45	21823	732	MB098145	14275	736,	NISSAN				482, 692, 750	
001-997-42-90	20654	272, 732			744, 787	01241-00551	17193	143, 756	01553-08101	21998	461,
002-988-51-81	20897	726	MB106212	14335	736, 743	01241-00881	21459	144,			488, 750
002-997-33-86	18302	416, 478	MB132008	14335	736, 743			693, 757	01553-08231	21545	520,
002-997-33-86-67	18302	416, 478	MB153825	17195	597,	01281-00023	14275	736,		543, 693, 753	
003-988-41-78	20188	470,			620, 658, 694, 735			744, 787	01553-08911	21618	740
		481, 729	MB253964	17351	504,	01281-0003U	19293	744	01553-08961	21295	442,
003-990-02-51	21431	656, 732			537, 738	01281-0005U	21318	746	01553-09241	19246	510,
003-990-24-97	21184	310	MB271999	20565	736	01281-00072	14256	785	01553-09311	19684	539, 752
003-990-35-97	22122	313	MB325299	16671	806	01281-00111	22416	57			440,
003-990-94-97	20971	308	MB358818	15926	233	01281-00111	22416	57	01553-09321	19274	480, 751
003-994-30-45	13218	142,	MB358819	15927	233	01281-00111	14335	736, 743			516,
		656, 733	MB419858	19487	735	01281-00231	14275	736,	01553-09431	21134	539, 754
004-988-76-78	20657	726	MB475404	17162	499,			744, 787			520,
004-988-77-78	20657	726			536, 571, 801	01281-00331	21111	690, 744	01553-09611	20349	508,
004-990-16-97	21286	314	MB547806	17472	522,	01281-00431	22176	745		540, 713, 752, 802	
006-988-30-78	20201	726			537, 739, 754	01281-00441	17342	743	01553-09791	20668	463,
006-988-35-78	20199	727	MB566720	19334	453,	01281-00501	21367	743			482, 692, 750
006-988-43-78	22236	451,			480, 737	01281-00601	19293	744	01553-10051	19905	515,
		489, 729	MB608104	19129	468,	01281-00691	21324	690, 743			540, 753
006-988-89-78	21434	726			479, 800	01281-00711	20604	690, 744	01553-10501	20349	508,
007-603-014-104	19621	275	MB608137	19343	735	01281-00711	20604	690, 744		540, 713, 752, 802	
007-603-014-106	20454	275	MB608140	19330	735	01281-00801	17342	743	01553-10501	20349	508,
007-603-016-105	14871	146	MB619582	21140	498,	01281-00831	20764	690, 742		540, 713, 752, 802	
007-988-34-78	20879	463,			542, 738	01281-00QAF	21930	742, 764	01553-10641	22288	467,
		483, 729	MB645307	21025	619, 737	01281-01081	20736	691, 745			489, 692
007-988-71-78	21467	727	MB655630	22082	445,	01281-01121	22274	690, 743	01553-10721	21192	518,
007-988-99-78	20879	463,			488, 737	01281-01321	21425	690		542, 693, 723, 754	
		483, 729	MB696120	19320	449,	01281-01431	22494	57	01553-1JA0A	21229	439,
008-988-09-78	22498	56			480, 737	01451-00841	18340	92,			484, 691, 747
009-988-03-78	22504	56	MB814419	19314	735			99, 129, 130	01553-2DR9A	22039	518,
011-988-76-78	22309	461,	MB817060	20573	736	01454-N5061	22292	93,			545, 693, 752
		489, 729	MB846992	20572	735			101, 130, 135	01553-2U001	21824	690, 744
114-990-01-92	21859	502,	MB869072	19331	444,	01454-N5061	22292	93,	01553-30001	22237	463,
	544, 730, 757, 823				480, 737			101, 130, 135			489, 750
114-997-02-90	20655	273, 732	MB879499	22077	507,	01515-0009U	21113	308	01553-S3500	13945	471,
123-990-00-92	20636	493,			545, 738	01515-00Q0C	21876	511,			476, 751
		541, 731	MB880455	19745	735			544, 752, 769	01553-S3500A	13945	476, 751
123-990-02-92	20637	516,	MB887567	17351	504,	01552-00661	21999	755	01651-00481	14695	667,
123-990-05-92	21044	502,			537, 738	01553-00051	14356	448,		717, 736, 743, 787	
		542, 730	MB888561	19324	736			476, 748	08540-61608	19170	93,
123-994-08-45	20650	727	MC440901	20381	444,	01553-00172	14737	443,			102, 130, 135
124-988-90-78	22115	732			482, 669, 737, 748			476, 748, 791	08540-61608	19170	93,
124-988-90-78-M89	22115	732	MD050317	19007	276	01553-00202	14347	447,			102, 130, 135
124-988-94-78	21759	727	MF453091	21746	93,			476, 748, 792	10998-30880	14696	498,
124-990-04-92	20909	503,			101, 129, 134	01553-00291	14355	442,		535, 678, 694, 752	
		541, 731	MQ907568	22483	55, 56			476, 747	11026-01M02	21258	276
124-990-05-92-9051	20640	494,	MR138807	18951	523,	01553-0034U	17350	520,	11026-JA00A	21258	276
		541, 730			538, 739			537, 679, 754	11128-01MOB	21293	277
124-990-07-92	20203	532,	MR200300	20247	509,	01553-0038U	21311	508,	11296-3TA0A	22198	756
		540, 731			540, 675, 738			542, 752	11296-AG000	20953	519,
124-990-07-92-9C75	20203	532,	MR201466	19328	739	01553-00401	14355	442,			541, 693, 754
		540, 731	MR221507	21623	735, 778			476, 747	24220-89986	14345	755
126-990-03-92	21044	502,	MR288150	21658	498,	01553-0052U	20671	445,	24225-89960	21259	273, 756
		542, 730			544, 738, 774			482, 748	255Y3616-10	12585	741
140-698-00-82	20656	727	MR322000	21690	453,	01553-00545	17452	443,	26023-H1000	13931	742
201-988-04-78	20202	726			486, 737			478, 747	26261-89969	B7443A	262
201-990-00-50	20645	732	MR328954	19274	516,	01553-00575	16784	508,	26272-8991A	B7440A	262
201-990-02-92	20638	520,			539, 754			26296-9B90A	BH13	265	
		541, 654, 731	MR435918	20571	449,	01553-0075U	18948	417,	26296-9B91D	BH9	265
201-990-05-36	21774	93,			482, 738			536, 752, 802	26296-9B92B	BH11	265
		100, 129, 134	MR478262	20580	499,	01553-01121	17452	478, 747	26297-9B91A	BD2S	264
201-997-22-81	20659	727			541, 626, 738			479, 749	26398-ED000	21850	689, 746
211-988-00-81	20773	727	MR478263	20580	499,	01553-01182	20256	419,	26557-2U000	22440	57
230-990-00-92-9C75	20638	520,	MR489986	22361	57			478, 747	26557-2U000	22440	57
		541, 654, 731	MR975267	22484	49,	01553-01393	16843	533,	26557-2U001	21824	690, 744
230-990-01-92	21086	517,			56, 57			481, 749	26717-89950	B1156A	262
		542, 627, 731	MS452348	21744	93,	01553-0170U	22503	58	26717-9B90E	B3057	262
463-988-02-78	20735	470,			102, 130, 135	01553-01733	20196	496,	27158-Q0100	17634	417,
		482, 729	MS480001	14255	665,			536, 724, 755			478, 747
6399980185	20647	728			717, 735	01553-01781	17634	417,	27948-M7002	14348	444,
673-988-00-25	20315	728	MS480002	13932	73						

O.E.M. INTERCHANGE BY MANUFACTURER

OEM No.	Auveco No.	Page No.	OEM No.	Auveco No.	Page No.	OEM No.	Auveco No.	Page No.	OEM No.	Auveco No.	Page No.
77-03-077-117	21869	65	909130096	22343	459, 773	51454-48010	21856	518, 804	67771-12080	20575	463, 798
77-03-077-153	21912	420, 487, 766	909130105	22206	489, 773, 467, 773	52115-0C090	21221	783	67771-14040	15707	465, 799
77-03-077-174	21868	427, 487, 760, 766	909130109	21591	488, 773, 451, 773	52115-48040	21132	783	67771-16080	19108	466, 799
77-03-077-225	21806	429, 486, 767	909130118	22290	485, 773, 773	52161-02020	18873	513, 803	67771-16120	18874	466, 799
77-03-077-231	21802	418, 486, 766	909130146	20558	459, 482, 711, 797	52161-16010	18873	513, 803	67771-16160	18874	466, 799
77-03-077-420	21897	765	909130213	21502	465, 485, 773	52161-20010	20931	513, 803	67771-16170	18875	452, 796
77-03-077-421	21866	65	909140002	21576	527, 543, 776	52188-06030	22197	789	67771-22010	14270	465, 799
77-03-077-422	21867	65	909140007	21420	524, 543, 776	52197-22020	22096	707, 789	67771-22020	14728	464, 797
77-03-077-435	21805	429, 486, 767	909140012	21570	501, 543, 774	52197-52010	21133	782	67771-26240	22486	61
77-03-077-444	21899	65	909140051	21422	516, 543, 775	52535-0E010	21015	707, 786	67771-30070	19109	460, 797
77-03-077-449	21908	447, 487, 765	909140052	21592	518, 543, 775	52535-0E030	21712	705, 782	67771-30090	19129	479, 797
77-03-077-453	21900	427, 487, 767	909140054	19233	519, 538, 648, 676	52535-30150	21583	707, 786	67771-32090	18844	463, 797
77-03-077-457	21870	447, 487, 765	909140055	21501	527, 543, 776	52535-50060	21015	707, 786	67771-32120	21686	459, 796
77-03-077-464	21911	420, 487, 766	909140059	22230	490, 545, 774	52599-48020	22335	710	67771-58010	21369	778
77-03-077-468	21814	461, 486, 761, 768	909140062	22160	498, 545, 774	53145-12010	22163	779	67771-89104	19203	461, 797
77-03-077-468	21814	461, 486, 761, 768	909140063	21500	518, 543, 775	53145-16020	22132	454, 489, 709, 791	67773-0E020	21795	454, 796
77-03-077-487	21910	419, 487, 766	909140065	22181	507, 545, 775	53145-60030	22212	444, 489, 709, 791	67867-0C010	20443	439, 795
77-03-081-056	21915	765	909140068	22270	517, 545, 775	53384-0R010	22126	514, 545, 803	67867-0D060	21707	440, 794
77-03-081-134	21959	758, 764	909207031	22211	432, 489, 772	53384-68010	22126	514, 545, 803	67867-12150	19749	439, 794
77-03-081-160	21930	742, 764	909300007	22044	771	53452-90351	17611	805	67867-28030	18692	439, 794
77-03-081-163	21931	758, 764	909300015	21569	771	53455-14020	14732	805	67867-52010	21707	440, 794
77-03-081-184	21874	758, 764	910107FA080	21562	771	53455-33010	19529	805	67867-89103	18692	439, 794
77-03-081-185	21960	758, 764	910109FC010	21564	770	53455-33011	19529	805	67868-02020	19749	439, 794
77-03-081-225	21932	764	910109FC030	21581	770	53813-48011	22132	454, 488, 711, 796	67868-30030	21627	415, 794
77-03-081-232	21961	759, 764	910109FC041	22050	771	53857-0E010	22334	710	67868-89101	18692	439, 794
77-03-081-233	21958	758, 764	910109FC090	21572	771	53857-12010	22346	703, 779	67869-12050	21551	449, 794
77-03-088-105	22002	65	910109FC110	21564	770	53857-47011	22103	435, 488, 710, 793	67869-20030	21548	415, 794
80-00-609-205	21904	65	91084AA010	22043	772	53867-47020	21237	789	67869-22030	21548	415, 794
82-00-110-307	21909	447, 487, 765	91085TA030	21566	502, 543, 775	53879-06100	21797	708, 789	67921-32010	19719	450, 796
82-00-151-367	21902	66	91085TA030	21566	502, 543, 775	53879-0R010	22412	60	68211-07010	19380	781
82-00-321-368	21907	429, 487, 767	91085TA030	21566	502, 543, 775	53879-14010	14750	143, 725, 807	68211-95D00	19722	783
82-00-700-969	21916	462, 487, 761, 768	91086AA000	22175	776	53879-14010A	14750	143, 725, 807	69293-12030	20469	714, 805
82-00-721-200	21905	427, 487, 766	91167AA000	21579	771	53879-14020	14750	143, 725, 807	69293-12040	20470	714, 805
82-00-909-084	21895	462, 487, 761, 768	91167FA010	22046	447, 488, 772	53879-14020	14750	143, 725, 807	69293-12050	20534	714, 806
82-00-939-873	21903	65	91486KJ000	21590	772	53879-20020	21613	143, 807	69293-12060	20535	714, 806
			91486KJ010	21531	772	53879-20010	14276	144, 808	69293-30030	21336	714, 805
			94044TA040	22364	58	53879-22010	14750	143, 725, 807	69293-33010	20469	714, 805
			94078FA080	22048	459, 488, 774	53879-22030	14750	143, 725, 807	69951-12180	18113	404, 742
			94081FA010	21575	771	53879-28010	22412	60	75392-04010	21016	782
			94415FA000NE	22047	527, 545, 776	53879-30040	21797	708, 789	75392-0R010	21016	782
			95022AC040ML	21630	422, 485, 772	53879-30050	22489	60	75392-35200	21016	782
			99045AE03AMA	21589	419, 485, 772	53879-58010	20758	707, 789	75392-35220	21857	705, 782
			99045SG000	22429	58	53879-60010	20335	507, 540, 802	75392-42030	21841	93, 134
						53888-48010	21225	509, 542, 803	75395-0T010	21453	779
						53935-35020	21162	783	75395-14020	14264	781
						61118-35010	21194	779	75395-14020A	14264	781
						61991-35010	21234	782	75395-35070	20688	780
						61992-35010	21235	782	75395-42020	22525	59
						62217-13010	20558	459, 482, 711, 797	75396-30020	20687	780
						62217-33031	22158	782	75397-35010	20688	780
						62489-0E010	22460	61	75397-42010	22215	781
						62581-14020	16778	470, 477, 721, 795	75494-20010	22525	59
						62955-12010	15695	558, 779	75495-35010	20687	780
						62955-20020	15695	558, 779	75498-20010	19843	781
						62955-50010	22456	59	75545-16020	14751	784
						65487-60010	22497	60	75545-28010	14749	784
						65613-07010	21337	807	75545-32020	16833	783
						67771-01010	14144	465, 476, 799	75545-88080	14749	784
						67771-02030	15709	464, 477, 799	75545-880B0	14749	784
						67771-02030	15709	464, 477, 799	75545-89101	16942	784
						67771-02030	19898	465, 481, 799	75546-12030	16821	784
						67771-03030	15707	465, 477, 799	75546-12050	14746	784
						67771-04040	19210	467, 479, 800	75546-12060	19204	783
						67771-06010	18844	463, 479, 797	75546-14080	16821	784
						67771-06030	19109	460, 479, 797	75546-20050	14745	784
						67771-12010	14269	464, 476, 694, 721, 799	75546-22060	17334	783
						67771-12010F	476, 694, 721, 799	14269	75547-22010	17298	784
						67771-12030	15709	464, 476, 694, 721, 799	75547-51021	21082	307
						67771-12040	19016	477, 799	75548-22150	19484	784
						67771-12050	18898	176	75548-60021	22427	59
						67771-12050	19257	466, 479, 711, 798	75791-0W010	15707	465, 799
						67771-12070	20473	452, 482, 710, 796	75819-33010	21748	704, 779
									75867-02010	21226	452, 795
									75867-06030	21596	521, 795

SUBARU

SUZUKI

TOYOTA

O.E.M. INTERCHANGE BY MANUFACTURER

OEM No.	Auveco No.	Page No.	OEM No.	Auveco No.	Page No.	OEM No.	Auveco No.	Page No.	OEM No.	Auveco No.	Page No.
75867-21010	20576	449, 482, 795	90189-06018	14258	785	90467-07043-11	16784	508, 536, 752, 802	90467-08196	21846	704, 781
75867-30110	19842	423, 481, 793	90189-06020	16825	665	90467-07043-C0	16784	508, 536, 752, 802	90467-08224	22396	59
75867-30120	21123	511, 542, 802	90189-06028	19194	551, 788	90467-07044	19128	516, 538, 803	90467-08225	22217	780
75867-30130	22056	452, 488, 710, 795	90189-06029	19505	787	90467-07059-22	19013	498, 538, 801	90467-09004	19112	446, 479, 793
75867-33030	21538	452, 485, 796	90189-06042	14695	667, 717, 736, 743, 787	90467-07050	14737	443, 476, 748, 791	90467-09004-01	19112	446, 479, 793
75867-52020	22478	61	90189-06065	20440	788	90467-07059-22	19013	498, 538, 801	90467-09006	18842	446, 479, 793
75867-AA010	21012	452, 483, 710, 796	90189-06076	22213	788	90467-07066	17383	492, 537, 570, 777, 800	90467-09008	14738	446, 476, 794
75867-AA010	21538	485, 796	90189-06114	20412	788	90467-07066-14	17383	492, 537, 570, 777, 800	90467-09008-01	14738	446, 476, 794
75867-AC020	21653	780	90189-06116	19505	787	90467-07066-J0	17383	492, 537, 570, 777, 800	90467-09050	19729	445, 480, 709, 793
76647-42010	21616	143, 807	90189-06145	21625	706, 787	90467-07071-22	21249	492, 542, 800	90467-09065-B1	16781	444, 477, 669, 792
76817-12060	21612	781	90189-06157	19721	788	90467-07072	14697	568, 588, 678, 722	90467-09093	17439	501, 537, 712
76817-68010	22454	60	90189-06162	18747	778	90467-07072-22	14697	568, 496, 535, 678, 722	90467-09096	19219	501, 538, 712, 805
76853-10010	21586	782	90189-06177	21411	788	90467-07076	17162	499, 536, 571, 801	90467-09127	19739	523, 539, 804
76879-44010	21611	806	90189-06193	20895	785	90467-07076-C0	17162	499, 536, 571, 801	90467-09139	19416	510, 539, 677, 723, 802
76879-48010	22332	307	90189-06211	21331	787	90467-07096	19124	447, 479, 792	90467-09143	17988	514, 537, 712
76923-47010	22072	531, 545, 714, 805	90189-06214	19756	788	90467-07121	19908	515, 540, 803	90467-09145	17206	499, 537, 801
76923-52021	22502	62	90189-06236	21792	788	90467-07121-B2	19907	515, 540, 803	90467-09166	21010	516, 542, 804
76924-02010	20578	556, 781	90189-A0002	20440	788	90467-07121-C0	19908	515, 540, 803	90467-09169-C0	22395	60
76924-12030	22166	445, 790	90189-A0008	21625	706, 787	90467-07126	19535	707, 789	90467-09185	21547	508, 543, 713, 802
76924-13020	22457	61	90189-A0011	19742	706, 787	90467-07138-C0	17992	518, 537, 712	90467-09204	21546	703, 778
76924-47010	21217	783	90269-03041	8905	294	90467-07146	19552	501, 539, 801	90467-09206	20437	463, 482, 798
76924-47020	22073	448, 488, 708, 790	90269-04047	21715	309	90467-07164	20908	517, 541, 777, 804	90467-09227	21366	525, 543, 804
76924-52021	20578	556, 781	90269-04053	20627	306	90467-07166	18888	515, 538, 803	90467-09237	22353	708
81124-89101	16951	778	90269-05034	21713	311	90467-07168	20577	568, 515, 541, 712, 803	90467-10018	14347	447, 476, 748, 792
81137-22530	21628	785	90269-05035	20626	311	90467-07168-C1	20577	568, 515, 541, 712, 803	90467-10077	19797	780
81150-1A750	21628	785	90269-05054	20626	311	90467-07188	21011	500, 542, 801	90467-10096	19534	707, 789
81496-0E020	22488	59	90269-05056	21713	311	90467-07192	21120	499, 542, 801	90467-10107	19123	444, 479, 794
81496-21010	21684	779	90269-06013	20834	311	90467-07199	21120	499, 542, 801	90467-10123	19014	442, 479, 790
81496-52020	22488	59	90269-06017	21315	313	90467-07210	20955	713, 804	90467-10146	19728	441, 480, 795
81496-60010	22398	59	90269-A0005	21315	313	90467-07211	21201	513, 542, 713	90467-10161	18876	465, 479, 798
82711-12200	21553	273, 806	90269-A0006	20788	305	90467-07214	21294	516, 542, 803	90467-10162	18861	450, 479, 795
89785-08020	21101	639	90341-12012	21293	277	90467-07215	22439	62	90467-10167	20559	479, 795
89785-60160	21101	639	90430-12018	22134	275	90467-07217	22400	62	90467-10168	18950	463, 482, 711, 797
90075-10004	21628	785	90430-12027	22134	275	90467-08004	18297	443, 478, 708, 791	90467-10183	20869	507, 574, 541, 713, 802
90075-10801	19783	598, 706, 786	90430-12031	22134	275	90467-08008	14737	443, 476, 748, 791	90467-10186	21634	445, 485, 709, 792
90080-46010	21296	443, 484, 791	90463-10337	14284	272, 680, 806	90467-08011	18297	443, 478, 708, 791	90467-10188	20633	464, 482, 798
90080-46269	19797	780	90467 10168	18950	463, 479, 797	90467-08014	19121	426, 478, 708, 791	90467-10192	20558	459, 482, 711, 797
90080-46294	21325	503, 542, 802	90467-04034	21552	438, 485, 710, 794	90467-08014-01	19121	426, 479, 791	90467-10206	21624	501, 544, 712, 801
90080-46327	22221	445, 489, 792	90467-05020	19506	420, 480, 646, 669	90467-08030	22001	444, 488, 792	90467-11005	14353	447, 476, 748
90080-81041	16897	260	90467-05020-01	19506	420, 480, 646, 669	90467-08045	21695	443, 486, 791	90467-11063	17481	780
90080-82014	12540	235	90467-05045-22	19686	415, 480, 790	90467-08063	21695	443, 486, 791	90467-11099	21550	780
90080-82014	21603	235	90467-05063-C0	21218	492, 542, 800	90467-08081	18878	446, 479, 793	90467-11100	20429	780
90080-82051	21436	235	90467-05081	21615	144, 714, 807	90467-08101	21643	444, 485, 709, 791	90467-11111	19647	780
90080-82052	21437	235	90467-05090-B1	21103	491, 542, 800	90467-08124	19113	445, 479, 709, 793	90467-11117	22051	707, 785
90080-82053	21166	235	90467-05096-22	19312	419, 480, 790	90467-08136	21254	448, 484, 793	90467-12073	21641	781
90080-82055	21438	235	90467-05114	20956	143, 175, 715, 807	90467-08145	16000	516, 536, 679, 723, 753	90467-12075	21642	782
90084-26001	17420	302	90467-05128	21614	144, 807	90467-08155	19140	568, 522, 624, 538, 649, 739, 804	90467-12078	16779	448, 477, 671, 793
90084-26002	20383	308	90467-05136	21849	496, 544, 712, 801	90467-08179	19910	465, 481, 798	90467-13005	17194	778
90084-26008	17411	302	90467-05138	21687	715, 807	90467-08180	20910	504, 541, 677	90467-13008	17194	778
90084-46020	21071	781	90467-05164	21332	422, 484, 791	90467-08185	20349	508, 540, 713, 752, 802	90467-13011	17195	597, 620, 658, 694, 735
90084-98033	18661	260	90467-05164-B6	21253	422, 484, 790	90467-08186	20184	421, 481, 790	90467-13075	21623	735, 778
90084-98033	20601	260	90467-05170	22125	491, 545, 712, 800	90467-08186-C0	20184	421, 481, 790	90467-17004	17438	779
90099-14044	18136	388	90467-06005	22472	60	90467-08188	22369	61	90467-A0002-C0	22473	61
90099-14045	18143	388	90467-06017	14260	498	90467-08195	21847	704, 781	90467-A0003	19113	445, 479, 709, 793
90105-06037	21840	121, 123	90467-06017-41	14260	498				90467-A0003	19113	445, 479, 709, 793
90118-WB048	22424	56, 62	90467-06017-C0	14260	498				90467-A0003	19113	445, 479, 709, 793
90159-50316	21839	93, 101, 129, 134	90467-06017-C0	14260	498				90467-A0003	19113	445, 479, 709, 793
90159-60303	22106	93, 102, 130, 136	90467-06017-C0	14260	498				90467-A0003	19113	445, 479, 709, 793
90159-60488	21838	94, 103, 130, 136	90467-06017-C0	14260	498				90467-A0003	19113	445, 479, 709, 793
90159-60525	21837	94, 104, 130, 136	90467-06017-C0	14260	498				90467-A0003	19113	445, 479, 709, 793
90159-A0001	21839	93, 101, 129, 134	90467-06017-C0	14260	498				90467-A0003	19113	445, 479, 709, 793
90159-A0030	21838	94, 103, 130, 136	90467-06017-C0	14260	498				90467-A0003	19113	445, 479, 709, 793
90183-03001	16306	806	90467-06017-C0	14260	498				90467-A0003	19113	445, 479, 709, 793
90189-04008	14277	786	90467-06017-C0	14260	498				90467-A0003	19113	445, 479, 709, 793
90189-04011	14271	785	90467-06017-C0	14260	498				90467-A0003	19113	445, 479, 709, 793
90189-04013	14268	667, 787	90467-06017-C0	14260	498				90467-A0003	19113	445, 479, 709, 793
90189-04014	14256	785	90467-06017-C0	14260	498				90467-A0003	19113	445, 479, 709, 793
90189-04019	14263	786	90467-06017-C0	14260	498				90467-A0003	19113	445, 479, 709, 793
90189-04022	17224	785	90467-06017-C0	14260	498						

O.E.M. INTERCHANGE BY MANUFACTURER

OEM No.	Auveco No.	Page No.	OEM No.	Auveco No.	Page No.	OEM No.	Auveco No.	Page No.	OEM No.	Auveco No.	Page No.
90467-A0004	22350	705, 781	N-904-374-01	20830	309	175-867-949	8418	112	7M3867299	21853	454, 815
90467-A0005	20437	463, 482, 798	N905-333-01	21891	434, 487, 817	176-941-117A	15666	634, 808	701-867-299	21479	513, 543, 818
90467-A0005	21102	463, 483, 711, 798	N905-353-01	21985	811	179-813-881	14030	550, 811	703-867-299	21450	451, 485, 815
90467-A0006	18876	465, 479, 798	N905-369-01	22238	491, 545, 818	179-813-883	12735	550, 616, 811	8D0-805-121	21889	819
90467-A0007	22471	61	N90561601	18661	260	191-853-577	21508	809	8D0-805-121B	21888	819
90467-A0008	20878	426, 483, 708, 790	N90561601	20601	260	191-853-577-A	21390	809	8D0-807-192--	21933	63, 65
90467-A0009	18297	443, 478, 708, 791	N90565301	21842	814	191-853-733-A	21416	808	8E0-805-121A	21886	819
90467-A0016-C0	17162	499, 536, 571, 801	N90634901	17006	309	191-867-775A	21989	492, 545, 818	8E0-864-229-9B9	22444	64
90467-A0018	21615	144, 714, 807	N906-420-01	21842	814	191-941-142	21498	811	8E0-868-243	21144	473, 483, 816
90467-A0032	22455	61	N90-757-901	22418	63	2D1867741	21843	728, 813	8K0-805-121	21887	819
90468-04030	16671	806	N90775001	22111	93, 101, 129, 134	251-823-717	21982	436, 488, 813	8K0-805-922A	22260	820
90468-04038	16306	806	N90775801	22110	92, 133, 100, 129	3A0-853-575	21478	810	8K0-821-213A	22308	813
90520-01002	2288	400	N90-796-501	21485	820	3A0-853-575-A	21448	809	8K0-868-307	22420	64
90520-01274	2288	400	N90-796-502	21485	820	3A0-853-575-A	21448	809	8P0-868-243	21996	454, 488, 816
90541-09069	22413	59	N908-131-01	21817	821	3A0-867-301-01C	21994	810	8R0-853-909	22414	63
90541-09124	22490	59	N-908132-01	20746	280	3B0-853-575	21449	809	8T0-853-909-A	22426	63
90904-67021	19430	779	N90813202	20746	280	3B0-853-576	21447	810	8U0-853-909	22417	64
90904-67036	20390	780	N908214-01	20925	811	3B0-868-243	20341	473, 481, 816	8V0-868-243	22442	63
90904-67037	20391	780	N908-214-01	20925	811	3C0-853-585	21761	812	8Z0-867-646	21995	454, 488, 816
90950-01248	16777	447, 477, 720, 792	N90833801	21816	812	3C0-853-586	22445	63	801-853-577	12635	808
90950-01620	22097	714, 806	N90833801	20924	811	3C0-853-934	22280	498, 545, 818	801-867-299-01C	21758	447, 486, 814
90950-08004	22159	782	N90833801	20924	811	3C0-863-559	22338	431, 489, 814	803-853-139A	13189	808
90959-01136	17631	805	N90892001	22111	93, 101, 129, 134	3D0-864-812-A-B41	22441	63	803-853-139C	13174	808
90981-13018	20600	260	N90-911-301	22449	64	3D0-864-851-B41	22411	63	811-807-557-C	21510	811
90981-13046	B9005	264	N-910-189-01	22291	820	321-837-581-01C	14194	821	811-807-577C	21510	811
90981-13046	16897	260	N91167901	21798	279	321-867-299B	21993	810	811-807-577C	21510	811
90981-13047	B9006	264	N989021	11612	418, 475	333-867-633-4FB	21451	496, 543, 818	823-867-299	20252	470, 481, 816
90981-13055	18661	260	N989022	11351	429, 475	357-827-998	20933	812	867-809-966	21510	811
90981-13055	20601	260	N989-051-01	11678	471, 475	357-853-575	21509	449, 485, 814	867-863-849-A01C	21892	817
90981-13075	BH11	265	028-103-059-A	21041	281	357-853-586-D	20250	812	1246926	14212	822
90982-08188	15926	233	06L-103-801	22143	277	357-868-143	21890	812	1-246-926	14212	822
90982-08189	15927	233	1H0-819-055-B01C	21392	426, 484, 814	4A0-805-121-A	21515	814	1-246-993	14209	822
90982-08202	15930	233	1H0-819-055-C01C	21452	526, 543, 819	4A0-805-121-C	21885	814	1-255-551	14211	822
90982-08203	15931	233	1H0-823-397	21483	819	4A0-805-121C	22208	814	1-255-553	14210	822
90982-08223	15929	233	1H0-823-717	21981	436, 487, 813	4A0-805-163	21815	812	1268176	19248	503, 539, 823
90982-09019	21602	235	1H0-837-719	21497	447, 485, 813	4A0-853-825	21492	810	1268176-3	19248	503, 539, 823
90982-09025	21604	235	1H0-853-585	21394	810	4A0-853-825-A	21493	809	1268642	21859	502, 544, 730, 757, 823
93904-46320	16960	106, 109	1H0-853-585-A	21396	810	4A0-853-825-C	21481	809	30624192	21785	458, 486, 823
95900-04036	17224	785	1H0-853-585-B	21395	810	4A0-857-610	21986	811	30653441	21786	458, 543, 823
SU003-02194	21326	281	1H0-853-586	21397	813	4A0-867-276	21818	820	30753487	22138	822
			1H0-867-199-01C	21789	430, 486, 814	4D0-807-300	22101	525, 545, 818	30753556	22137	822
			1H0-867-199-A	21482	526, 543, 819	4F0-805-163	22098	820	30784514	21784	822
			1H0-867-199-A	21482	526, 543, 819	4F0-825-429A	22235	813	30808521	22340	822
			1H0-868-243	21393	473, 484, 817	4L0-886-373	22094	812	3104-426	13173	810, 822
			1H0-868-243-B	21415	473, 484, 817	441863987B	21485	820	591-740	12637	822
			1H5-863-849-A01C	21145	817	443-853-909-A	21491	809	680-097	13191	822
			1H5-863-849-A01C	21145	817	5J0-867-276	21893	454, 487, 815	9133073	20407	532, 540, 823
			1J6-867-276	22116	820	5X0-867-299	21894	473, 487, 817	9133073-8	20407	532, 540, 823
			1K0-837-199B	22397	64	6E0-837-732	21992	816	9133417	21859	502, 544, 730, 757, 823
			1K6-837-200B	22231	458, 489, 816	6K0-868-243-C	21398	473, 484, 816	9133417-7	19904	503, 539, 823
			1Z0-837-732A	21980	439, 487, 813	6L0-121-136A	21990	497, 545, 818	9151649	20405	822
			111-837-5811	13031	821	6L6-853-575A	21991	449, 488, 815	9151649-2	20405	822
			111-837-5815	13031	821	6N0-809-966A	21816	812	946-418	13220	144, 733, 757, 823
			111-837-581J	13031	821	6N0-823-397-AC	21514	819	947-098	13230	490, 534, 730, 823
			113-853-615A	13227	141, 812	6N0-867-276	22216	813	95290	13173	810, 822
			113-857-219A	13206	812	6N0-868-243A	21997	473, 488, 817	979878	19376	309
			131-853-585C	10322	808	6Q0-807-643	22399	64	979878-6	19376	309
			155-809-966	12735	550, 616, 811	6Q0-853-147	22447	63	980557	B3357	262
			161-867-299-01C	19195	502, 538, 818	6Q0-868-243	21251	526, 542, 819			
			165-827-592	21480	811	6Q0-868-246-A	21760	809			
			171-201-969	21456	821	6Q0-868-297	21783	450, 486, 815			
			171-807-249-A	21494	470, 485, 816	6Y0-823-717	21984	415, 488, 814			
			175-820-435	16252	168	7L0-839-069	21512	809			
			175-853-577	13748	297	7L5-853-994	21495	451, 485, 767, 815			
			175-853-577-01C	13748	297	7L6-868-243	21708	473, 486, 817			
			175-853-577A	13753	298	7M0-867-299-K	21853	454, 486, 701, 815			
			175-853-674	14014	550, 811						
			175-867-299	13475	471, 476, 768, 815						

O.E.M. INTERCHANGE BY NUMERICAL ORDER

OEM No.	Auveco No.	Page No.	OEM No.	Auveco No.	Page No.	OEM No.	Auveco No.	Page No.	OEM No.	Auveco No.	Page No.
E9TZ-13032B	16399	594	G030-68-885-B-38	14709	420,	KA01-50-H16	17553	598, 719	MB374270	21118	465,
E9TZ-13032-B	16399	594			476, 720	KA80-51PR6	18882	603, 715			483, 738
E9TZ-6730-B	19365	282	G031-58-762	18692	439,	KD51-51-W24	22510	55	MB374271	21118	465,
EA01-50-037	21663	491,			478, 720, 794	KD53-51-SJ3A	22520	55			483, 738
		544, 721	G032-68-865A-00	21560	422,	KD53-51-W24	22512	55	MB419858	19487	735
EA01-50-048	18882	603, 715			485, 720	L000000880	B880	263	MB455-56143	17632	508,
EC01-68-AB1	20190	468, 481	G14S-50-EA1	21769	495,	L00000067	B67	262		537, 605, 688,	722
EF95510X4	BH13	265			544, 721	L00000089	B89	262	MB475404	17162	499,
EOSZ-13466-A	20291	259	G18K-51-SJ3	20932	452,	L0000168	20706	267			536, 571, 801
EOVY-13A506-A	17164	610			483, 720	L0000168	B168	262	MB475404	17162	499,
F0TZ-14489-J	19004	251	G350-68-AB1	18824	458,	L0000194	B194	262			536, 571, 801
F1CZ-13466-C	20595	260			479, 721	L00002057A	B2057A	262	MB547806	17472	522,
F1CZ-13A147A	18899	594	G46L-50-EB1	22517	55	L0000880	B880	263			537, 739, 754
F1CZ-13A147-A	18899	594	G6JA-50-0Z5	20957	716	L0000886	B886	263	MB547806	17472	522,
F1CZ-16674-A	18458	446,	GA2A-56-399A	19753	718	L0000891	B891	263			537, 739, 754
		478, 719	GA2A-56-694	14709	420,	L0000894	B894	263	MB566719	19802	455, 481
F1CZ-16774-A	18458	446,			476, 720	L0000896	B896	263	MB566720	19334	453,
		478, 719	GA2A-58-762	19481	438,	L0000899	B899	263			480, 737
F1CZ-5802316-A	19138	598, 718			480, 721	L0000906	B906	262	MB566720	19334	453,
F1CZ-61101B04-A	17602	602	GA5R-56-392	19306	502,	L0000912	B912	262			480, 737
F1CZ-8A188-A	17317	597			539, 722	L0000H11	BH11	265	MB608104	19129	468,
F1TZ-13411-A	22184	246	GD7A-50-EA1	20755	515,	L0000H13	BH13	265			479, 800
F1TZ-17698-A	19393	404			541, 723	L0001156	B1156	262	MB608104	19129	468,
F1TZ-7810182-A	19441	602	GHP9-50-355	22448	46	L0001157	B1157	262			479, 800
F1ZZ-13466-A	20286	259	GJ21-50-034	17060	603, 724	L0001893	B1893	262	MB608137	19343	735
F2ZZ-16774-A	14709	420,	GJ21-50-049	17003	612, 725	L0001895	B1895	262	MB608140	19330	735
		476, 720	GJ21-50-H81	17551	598, 718	L0002057	B2057	262	MB619582	21140	498,
F2DZ-13466-C	20599	260	GJ21-50-H82	17552	598, 718	L0003057	20722	267			542, 738
F2PZ-14A464-C	19004	251	GJ21-58-502A	19743	718	L0003057	B3057	262	MB645307	21025	619, 737
F2UZ-1602354-AAA	19846	432, 481	GJ21-58885-A69	18206	508,	L0003156	B3156	262	MB655630	22082	445,
F3Z2-17C756-S	17003	612, 725			537, 608, 723	L0003157	B3157	262			488, 737
F3Z7-13N129-A	18263	594	GJ21-68-885B-02	21024	507,	L0003157AK	B3157A	262	MB696120	19320	449,
F3DZ-6730-A	18025	279			542, 608, 722	L0003457	B3457	262			480, 737
F3DZ-6734-A	18299	275	GJ21-68-885-B02	18206	508,	L0007440	B7440	262	MB696120	19320	449,
F3LB-14K056-AA	17222	572,			537, 608, 723	L0007440NA	B7440A	262			480, 737
		500, 607, 537	GJ21-68885-B69	18206	508,	L0007443	B7443	262	MB814419	19314	735
F3LY-14570-B	17222	572,			537, 608, 723	L0009004LL	B9004	264	MB817060	20573	736
		500, 607, 537	GJ21-68-885-B69	18206	508,	L0009005	B9005	264	MB846992	20572	735
F3LY-6321970-A	17119	614			537, 608, 723	L0009006	B9006	264	MB869072	19331	444,
F3LY-6321971-A	17118	614	GJ6A-50-0Z5	20957	716	L0009006XS	B9006	264			480, 737
F3PZ-14A464-D	19126	246	GJ6A-50-ES1	21304	597	L0009007QL	B9007	264	MB879499	22077	507,
F3PZ-14A464-E	19125	245	GJ6A-58-975	21743	718	L0009145	BH10	265			545, 738
F4CZ-13466-A	16917	258	GJ6A-68-162	20958	716	L000921E	B921	265	MB880455	19745	735
F4CZ-13466-A	B3157	262	GJ6A-68-AB1	18824	458,	L00194NA	B194A	262	MB887567	17351	504,
					479, 721	L002057A	B2057A	262			537, 738
F4PZ-14A411-C	19885	251	GJ6A-68-AB1	20983	460,	L004157NAK	B4157K	262	MB888561	19324	736
F4TZ-13N021-B	18662	260			483, 720	L00H355V	20600	260	MB888869	19140	568,
F4TZ-13N021-B	B9007	264	GJ6E-50-715-A	20923	532,	L01255H3	20600	260			522, 624, 538, 649, 739, 804
F4UB-14A464-A	19004	251			541, 604, 722	L33X13209	21192	518,	MBF67-50-033	15366	603, 724
F4UZ-13B765-A	12237	236,	GJ6E-50-715-B	20923	532,		2192	518,	MBF82-50-233	16843	533,
		244, 253			541, 604, 722		542, 693, 723, 754			536, 724, 755	
F4VY-14A411-A	20846	251	GJ6R-68-ABX	20983	460,		2192	518,	MC440901	20381	474,
F4VY-14A411-S	20846	251			483, 720		2192	518,		482, 669, 737, 748	
F4XY-1200586-A	17339	440, 478	GK2A-50-798	21300	597	L562	20402	303	MD050317	19007	276
F4XY-6734-A	21258	276	GM9E-63-938A	20960	716	L891	20598	260	MF453091	21746	93,
F4ZZ-6310182-A	20965	602	GS3L-68-615	21413	717	LA01-50-6A8A	19831	717			101, 129, 134
F50Y-14603-A	21224	597	H001-50-609	14719	716	LA01-56-135	14750	143,	MG350-68AB1	18824	458,
F54Y-13466-A	19209	260	H001-50-841	14695	667,		14750	143,			479, 721
F54Y-13466-A	20717	267			717, 736, 743, 787			725, 807	MG350-68AB1	18824	458,
F57B-16241-AA	21000	601	H001-68-719B	17451	599, 718	LR000080	22148	701			479, 721
F57E-9C631-AA	15044	530,	H001-68-719C	17451	599, 718	LR002229	22150	701			536, 606, 699, 723, 753
		536, 578				LR012844	22245	474,	MNA01-56145	16858	522,
F57Z-16241-AB	20663	602	H1	BH1	264			489, 701			721
F57Z-7810182-AA	19441	602	H10	BH10	265	LR013135	22251	453,	MQ907568	22483	55, 56
F58Z-16237A02-A	18848	455, 479	H11	BH11	265			489, 702	MR138807	18951	523,
F5DZ-13466-B	17996	258	H115-67-099	15926	233	LR027255	22149	468,			538, 739
F5DZ-13466-B	B3156	262	H116-67-099	15927	233			488, 702	MR200300	20247	509,
F5OY-14603-A	21224	597	H117-67-099	15931	233	LR028939	22152	459,			540, 675, 738
F5RZ-17698-A	19393	404	H13	BH13	265			488, 702	MR200300	20247	509,
F5RZ-17K657-A	20425	596	H260-50-6K8	22064	718	LR032984	22153	449,			540, 675, 738
F5RZ-6730-B	18374	278	H3	BH3	265			488, 702	MR201466	19328	739
F5TZ-6734-BA	20453	275	H4	BH4	260	LR033144	22155	495,	MR221507	21623	735, 778
F65Z-15020C34-AA	19536	611	H452EK1	17080	531,			488, 701	MR288150	21658	498,
F65Z-1521952-AA	19658	588			536, 625			702, 545			544, 738, 774
F67Z-7822008-AA	18890	615	H7	BH7	265	LR034389	22244	454,	MR322000	21690	453,
F6AZ-14A411-AA	18218	252	H9	BH9	265			489, 701			486, 737
F6DZ-16758-AD	16850	396	HB1	B9004	264	LR053837	22244	454,	MR328954	19274	516,
F6DZ-5402316-AA	19238	598	HB1	16896	260			489, 701			539, 754
F6DZ-5403296-A	20942	400	HB121467	14720	448,	LS101	9883	236, 244	MR328954	19274	516,
F6DZ-5410182-AA	20358	601			476, 737	MB020923	19385	445,			539, 754
F6TZ-6730-BA	19279	280	HB2	18661	260			480, 737	MR435918	20571	449,
F75Z-6730-BA	18025	279	HB3	B9005	264	MB020923	19385	445,			482, 738
F75Z-6730-BA	19773	280	HB3	16897	260			480, 737	MR478262	20580	499,
F79Z-1123342-AAA	13030	616	HB4	B9006	264	MB023930	14366	717, 743			541, 626, 738
F7CZ-17C756-EA	16843	533,	HB4	16898	260	MB029111	14277	786	MR478263	20581	619, 736
		536, 724, 755	HB5	B9007	264	MB098145	14275	736,	MR489986	22361	57
F7DZ-5402316-AA	19238	598	HB5	18662	260			744, 787	MR975267	22484	49,
F7DZ-7421952-AA	19658	588	HG30-50-6B9A	19648	716	MB106212	14335	736, 743			56, 57
F7UZ-1513284-BA	19421	612	HP-2	7915	295	MB132008	14335	736, 743	MS452348	21744	93,
F7UZ-15238A32	19413	412, 603	HP-3								

O.E.M. INTERCHANGE BY NUMERICAL ORDER

OEM No.	Auveco No.	Page No.	OEM No.	Auveco No.	Page No.	OEM No.	Auveco No.	Page No.	OEM No.	Auveco No.	Page No.
MU480034	19322	736	N801169-S900	22104	92	N805592-S100	17121	310	N905150-S	17466	312
MU481027	19325	438,		98, 129, 133		N805612-S	17102	455, 477	N905180-S	17466	312
		480, 738	N801554	15040	423, 476	N805612-S100	17102	455, 477	N905-333-01	21891	434,
MU481187	19323	445,	N801603-S2	20271	92,	N805660-S	15672	505,			487, 817
		480, 737		98, 129, 132				536, 624	N905-353-01	21985	811
MU840004	15931	233	N801706-S	12569	595, 617	N805759-S100	16834	307	N-905-369-01	22238	491,
MU840015	15926	233	N801851-S45	14947	121,	N805889-S100	19480	145, 179			545, 818
MU840016	15927	233			125, 167	N805995-S100	18331	315	N90561601	18661	260
MU840021	15931	233	N801925	12565	455, 475	N806113-S	20189	427, 481	N90561601	20601	260
MWC3136	22085	700	N801925-S	12565	455, 475	N806126-S100	17408	302, 305	N90565301	21842	814
MWC9134	21770	417,	N801994	19667	421, 480	N806191-S1901	17643	611	N-906-349-01	17006	309
		486, 701	N801994 DUP	19667	421, 480	N806289-S	17339	440, 478	N906-420-01	21842	814
		417,	N801994-S100	19667	421, 480	N806322-S	18893	505,	N90-757-901	22418	63
MXC1800	21855	486, 701	N802224-S	20316	430, 481			538, 604	N90775001	22111	93,
		146	N802239-S	17643	611	N806334-S	20245	595			101, 129, 134
N013844-2	14871	275	N802241-S	17642	611	N806340-S	19850	438, 481	N90775801	22110	92,
N013849-2	20454	275	N802331-S53	16842	145, 178	N806344-S	18277	432, 478			133, 100, 129
N013849-3	19621	275	N802376-S	14754	595	N806363-S	20264	597	N90-796-501	21485	820
N-014-389-3	13173	810, 822	N802538	14526	175	N806511-32	19823	612	N90-796-502	21485	820
N0385491	19195	502,	N802538-S100	14526	175	N806511-S32	19823	612	N908-131-01	21817	821
		538, 818	N802734-S	15480	429, 477	N806511-S441	19823	612	N-908132-01	20746	280
N038550-1	21391	493,	N802734-S	19197	429, 479	N806624-S191	18102	612, 631	N90813202	20746	280
		543, 818	N802737-S	13469	513,	N806830-S100	17639	315	N908-214-01	20925	811
N038-550-1	21391	493,		534, 606		N806830-S100	19263	315	N90833801	21816	812
		543, 818	N802775-S36	16883	139	N806959-S	19235	388	N908338-01	20924	811
N102593-01	20187	491,	N802781-S	14020	529,	N807154-S	19371	426, 480	N908-338-01	20924	811
		540, 730, 817			535, 577, 609	N807154-S	19373	426, 480	N90892001	22111	93,
N-102-593-01	20187	491,	N802865-S100	18153	584	N807154-SZUD4	19373	426, 480			101, 129, 134
		540, 730, 817	N802900-S	12565	455, 475	N807155-S	19352	425, 480	N90-911-301	22449	64
N-103-201-01	16897	260	N802900-S	13470	455, 476	N807155-S	19354	425, 480	N-910-189-01	22291	820
N10475903	B3357A	262	N803043-S	13750	298	N807168-S	19111	312	N91167901	21798	279
N105-168-01	21987	812	N803170-S	14021	416, 476	N807189-S100	20171	598	N989021	11612	418, 475
N106-213-01	21988	812	N803183-S32	14814	172	N807247-S	19526	598	N989022	11351	429, 475
N-106-213-01	21988	812	N803362-S	13993	573,	N807389-S	17216	576,	N989-051-01	11678	471, 475
N10-700-901	22421	64		506, 534, 607, 626			522, 608, 627, 537		NA01-50-101A	19228	715
N10721801	BD2C	264	N803387-S	15668	434, 477	N807535-S	19760	428, 481	NA01-56-145	16858	522,
N10724401	B7440A	262	N803387-S300	15668	434, 477	N807535-SSZ	19760	428, 481		536, 606, 699, 723, 753	
N10724402	B7440	262	N803421-S	14019	529,	N807577-S	18895	506,	NE51-51-SJ3A	21678	452,
N14-4003	11404	115,		535, 609, 628				538, 605			485, 720
		137, 821	N803494-S	14953	567,	N807578-S	18894	506,	OH452KD5	17080	531,
N185101	11101	148, 285		532, 535, 603				538, 605			536, 625
N185112	11099	148, 285	N803613-S	16863	434, 477	N807620-S100	18461	308	OWX68BD1-AA	20948	525,
N185151	11097	148, 285	N803638-S36B	14895	613	N807673-S	22058	496,			541, 625
N185161	11098	148, 285	N803685-S11	14820	584, 612			545, 604	OWX68BD5-AA	21021	524,
N185301	11100	148, 285	N803709-S	17103	500,						542, 625
N304-13-356A	14697	568,		536, 573, 607		N807706-S	19326	596			542, 625
		496, 535, 678, 722	N803716-S	14018	512,	N807721-S	17612	426, 478	PR2	16927	258
N304-13-356B	14697	568,		534, 608		N807875-S	19524	474, 480	PT516	13547	243
		496, 535, 678, 722	N803734-S	15480	429, 477	N807943-S	19810	455, 481	PT549	11440	242, 254
N605920-S2	12327	122, 127	N803739-S	22139	298	N807951-S	18820	421, 479	R4357	11104	294, 305
N606676-S100	12160	121, 124	N803763-S100	20415	585, 613	N807994-S	18816	598	RYQ500170	22248	513,
N606676-S2	12160	121, 124	N803768-S	18155	595	N808041-S437	20742	585			545, 702
N606676-S36	15778	121, 124	N803857-S	20311	417, 481	N808048-S	16726	510,	S47P-64-345	22483	55, 56
N606677-S36	12335	121, 125	N803862-S	13751	298			536, 608	S51S-51-833	21662	492,
N606677-S43B	15779	121, 125	N803933-S101	17408	302, 305	N808147-S	14991	570,			544, 721
N606677-S53B	15779	121, 125	N803934-S	13994	529,			506, 605, 535	SB3-4	19045	293
N606690-S2	15780	122, 127		577, 534, 609		N808182-S309	19436	613	SB4-1	19046	293
N606690-S55	15780	122, 127	N803946-S	14992	500,	N808182-S439	19436	613	SB4-2	5749	293
N606692-S2	16931	122, 127		535, 604, 624		N808331-S	18895	506,	SB4-3	8874	293
N610959-S2	13019	93,	N804189-S	13747	297			538, 605	SB4-4	5753	293
		102, 130, 135	N804193-S100	18167	304	N808332-S	18894	506,	SB4-6	8880	293
N620391-S36	17495	140	N804343-S	13748	297			538, 605	SB4-8	19047	293
N620480	15316	139	N804344-S	14967	587,	N808342-S307	20546	612	SB5-2	8883	293
N620480-S2A	15316	139		614, 630, 634		N808370-S	19127	427, 479	SB5-4	8886	293
N620482	15318	139	N804349S	15479	431, 477	N808594-S100	18396	304	SB6-10	8902	293
N621900	15325	139	N804349-S	15479	431, 477	N808679-S	15480	429, 477	SB6-2	8889	293
N621903	15326	139	N804376-S	16421	106, 107	N808689-S417	19458	304	SB6-4	8892	293
N621905	15328	139	N804379-S	15478	430, 477	N808791	20273	514,	SB6-6	8895	293
N621905-S2	15328	139	N804448	14757	422, 476			540, 606, 625	SB6-8	8899	293
N621906-S361	16774	139	N804570-S	14753	570,	N808842-S	19338	433, 480	SBL4-2	8291	293
N621906-S437	16774	139		506, 605, 624, 535		N808847-S	19244	528,	SBL4-4	8293	293
N621907	15332	139	N804570-S	14993	506,			538, 609	SBL6-12	18814	293
N621940-S424	15335	139		535, 570		N808908-S	19337	497,	SBL6-4	18811	293
N621942-S2	15337	139	N804583	15187	297, 309			539, 609	SBL6-6	8305	293
N621942-S301	15337	139	N804583-S	15187	297, 309	N811006-S	18936	473, 479	SBL6-8	18812	293
N621942-S441	15337	139	N804614-S	13994	529,	N811018-S100	17639	315	SC4-2	5751	293
N621945-S2	21001	139		577, 534, 609		N811018-S100	19263	315	SC4-4	8303	293
N623330-S2	18337	145, 177	N804674-S	15701	528,	N811040-S	20893	417, 483	SD34BS	19045	293
N623331-S2	18338	145, 177		536, 609		N811169-S	19783	598,	SD41BS	19046	293
N623332-S100	11864	145, 178	N804675-S	17101	298			706, 786	SD42BS	5749	293
N623332-S2	11864	145, 178	N804759-S	15491	298	N811257-S100	20421	613	SD42BSLF	8291	293
N623332-S21	12669	145, 178	N804765-S	19277	596	N811257-S309	20421	613	SD43BS	8874	293
N623332-S439	12669	145, 178	N804837-S	14994	529,	N811259-S	18812	293	SD44BS	5753	293
N623332-S53	12669	145, 178		535, 606		N811283-S	20545	510,	SD44BSLF	8293	293
N623333-S100	11629	145, 179	N804851-S100	19516	315			540, 605	SD46BS	8880	293
N623333-S2	11629	145, 179	N804863-S100	13754	297	N811353-S100	20171	598	SD48BS	19047	293
N623340-S2	11625	145, 177	N804992-S58	10654	72						

O.E.M. INTERCHANGE BY NUMERICAL ORDER

OEM No.	Auveco No.	Page No.	OEM No.	Auveco No.	Page No.	OEM No.	Auveco No.	Page No.	OEM No.	Auveco No.	Page No.
SSBN4-3	11104	294, 305	W705955-S300	20177	423, 481	W712665-S300	20993	528,	YS4Z-13N021-AA	20601	260
SSC42	5750	293	W705956-S300	20233	527,		542, 577,	608	YS4Z-16K262-AA	20191	604
SSD44SSBS	19060	294			540, 606	W712930-S437	8892	293	YS4Z-6730-AA	20347	278
SSD627OUG	17429	302	W705957-S300	20518	527,	W713202-S300	21172	496,	YS4Z-6734-AA	21180	275
SSD68SSBS	19061	294			540, 609		542, 604	611	YU5Z-13466-AD	16901	258
SSP42	5748	293	W706009-S300	16954	609	W713297-S300	21169	469, 483	YU5Z-13466-AD	B3457A	262
SU003-02194	21326	281	W706092-S300	21098	510,	W713331-S300	20989	512,	000-987-10-81	13157	728
T001-50-M48B	19450	715			542, 605, 624		574, 541,	608	000-988-15-81	13141	727
TD11-56-694	21661	421	W706172-S309	20401	613	W713445-S300	21172	496,	000-988-16-25	20647	728
		485, 720	W706182-S300	20516	519,		542, 604	496,	000-988-55-81	13144	728
TD12-51-SJ3A	21412	454,			540, 607	W713579-S300	21794	456, 486	000-988-76-81	13141	727
		484, 721	W706350-S300	14992	500,	W713590-S300	21174	601	000-988-86-25	20404	728
TY98TL2-AA	20541	433, 482			535, 604, 624	W713610-S300	20988	510,	000-990-03-92	13230	490,
UB39-45-919	20465	507,	W706350-S3000	14992	600,		574, 626, 541	612		534, 730, 823	
		540, 722	W706358-S300	15478	430, 477	W713617-S439	22272	612	000-990-22-92	13230	490,
UB39-50-795	19747	507,	W706494-S300	19849	511,	W713819-S900	21864	308		534, 730, 823	
		539, 722	W706519-S300	20518	527,	W714004-S900	22264	312	000-990-299-2	21859	502,
W-159	15004	157			539, 606	W714040-S300	20880	574,		544, 730, 757, 823	
W-246	15018	158	W706575-S300	20393	596		511, 541	541	000-990-29-92	19195	502,
W-486	15009	157	W706635-SSW	21241	431, 484	W714076-SS3JA	22180	424, 488		538, 818	
W-487	15010	157	W706676-S300	17664	425, 478	W714584-S300	20766	521,	000-990-34-92	20187	491,
W520802-S439	11864	145, 178	W706713-S300	20367	511,		541, 627	302		540, 730, 817	
W520802-S439	11864	145, 178	W706738-S300	20190	468, 481	W714599-S900	17420	302	000-990-37-92	20314	496,
W520821-S426	18338	145, 177	W706739-S300	20190	468, 481	W714975-S300	20992	523,		540, 730	
W520821-S439	18338	145, 177	W706812-S300	19386	466, 480		542, 576,	293	000-990-40-92	20640	494,
W520822-S426	12669	145, 178	W706815-S300	21257	426, 484	W715030-S437	8892	293		541, 730	
W520823-S426	11629	145, 179	W707157-S300	20245	595	W715201-S300	21668	600	000-990-44-92	20639	494,
W520823-S439	11629	145, 179	W707388-S300	20936	603, 715	W715537-S300	20826	575,		541, 730	
W520832-S424	12575	145, 178	W707501-S300	12253	141		514, 541	611	000-990-46-92	20641	731
W520832-S426	12575	145, 178	W707593-S300	20190	468, 481	W715544-S300	22304	611	000-990-54-92	20234	500,
W525170-S417	19414	302	W707593-S300	20190	468, 481	W715926-S300	21673	422, 485		540, 654, 730	
W525172-S	19110	303	W707638-S900C	22067	313	W715951-S300	22053	431, 488	000-990-57-92	20642	449,
W525172-S300	19110	303	W707889-S300	20192	424, 481	W716156-S303	12255	141		482, 729	
W525172-S417	19461	303	W708035-S300	20531	423, 482	W716350-S300	20977	602	000-990-609-2	21859	502,
W525174-S	19420	304	W708045-S300	20532	596	W716351-S300	22099	600		544, 730, 757, 823	
W525174-S300	19420	304	W708088-S300	21770	416, 478	W716352-S300	22124	600	000-990-84-92	21037	491,
W525175-S	19456	304	W708325-S300	21239	596	W716460-S300	21187	583		542, 730	
W525175-S300	19456	304			524,	W716460-S300	22038	600	000-990-90-51	20234	500,
W-6	15017	158	W708384-S309	20401	613	W716497-S300	21669	600		540, 654, 730	
W623463-S54	8868	154	W708456-S309	16883	139	W716503-S300	22033	601	000-991-01-98	22309	461,
W700566-S300	18383	595	W708464-S450B	22428	44	W716507-S300	22269	460, 489		489, 729	
W700614-S300	18498	602	W708513-S309	20776	614	W716510-S300	21703	508,	000-991-49-40	22306	517,
W700671-S300	20319	427, 481	W708530-S300	20632	576,		544, 605	605		545, 731	
W701054-S300	18503	529,			523, 608, 541	W716529-S900	22289	584,	000-991-59-32	22265	314
		538, 609	W708580-S300	21362	596		612, 631	49	000-991-59-40	21711	493,
W701133-S300	18386	610	W708621-S300	20190	468, 481	W716783-S300	22431	49		544, 730	
W701221-S300	20193	603	W708633-S300	21313	433, 484	W716969-S300	21703	508,	000-991-63-98	22252	451,
W701223-S300	20194	603	W708761-SSB	18275	432, 478		544, 605	700		489, 729	
W701259-S300	10831	425, 475	W708761-SSE	19760	428, 481	W717736-S300	22154	700	000-991-63-98-64	22252	451,
W701374-S	20399	421, 482	W708761-SSZUD4	19760	428, 481	W717870-S300	18030	537,		489, 729	
W701374-S300	20399	421, 482	W708771-S300	20530	597	W717970-S300	22474	49	000-991-63-98-M22	22252	451,
W701380-SSW	18379	423, 478	W708777-S437	22023	314	W717984-S417	22333	489, 309		489, 729	
W701430-S300	18377	599	W708777-S900C	21286	314	W718033-S300	22179	451, 488	000-991-73-98	22307	727
W701566-S417	18331	315	W708888-SAB	17664	425, 478	W718088-S300	22227	511,	000-991-74-98	22254	448,
W701649-S	19237	93,	W708888-SD	17664	425, 478		545, 608	608		489, 728	
		100, 598	W709002-S	20624	423, 482	W718365-S300	22284	528,	000-994-04-45	13224	142, 732
W701650-S	19238	598	W709002-SAA	20624	423, 482		545, 609	609	000-994-06-45	13218	142,
W701855-S300	20366	424, 482	W709176-S300	19639	573,	W718369-S300	22475	49		13220	144,
W701971	20169	540, 609			505, 626, 539	W719084-S300	22493	49	000-994-09-45	13220	144,
		540, 609	W709346-S300	17664	425, 478	W719367-S300	22349	497,		733, 757, 823	
W701993-S	17604	388	W709629-S300	20532	596		545, 607	607	000-994-14-45	13215	142,
W702380-S300	18504	611	W709688-S300	21790	599	W725172-S300	19110	303		13216	142,
W702412-S300	19345	603	W709767-S300	20663	602	W790173-S900	21202	600		656, 733, 757, 770, 820	
W702413-S450B	22348	44	W709883-S300	13467	435, 475	W790225-S900	22021	558	000-994-25-45	13223	142,
W702438-S300	22359	599	W709984-S300	20631	575,		15015	157		656, 732	
W702512-S900C	22023	314			512, 541	WPT-118	20851	252	001-988-03-25	21105	448,
W702554-S900	22066	314	W709995-S300	21247	466, 484	WPT-159	20842	250		483, 729	
W702554-S900C	22066	314	W710250-S300	21089	510,	WPT-169	20843	249	001-988-20-81	16124	141, 728
W702926-S	18744	298			542, 605	WPT-173	18671	250	001-988-20-81	20205	727
W703842-S300	20193	603	W710312-S300	20761	424, 482	WPT-335	20848	245	001-988-40-81	21464	726
W703919-S300	20193	603	W710332-S300	20926	424, 483	WPT-793	22425	46	001-988-46-81	21466	726
W704021-S100	20268	583	W710752-SSC	14992	500,	WX68BD1-AA	20948	525,	001-988-49-81	21433	726
W704021-S424	20268	583			535, 604, 624		541, 625	625	001-988-50-81	21441	726
W704340-S300	14020	529,	W710754-S439	21187	583	WX68DX9-AA	20739	524,	001-988-60-81	21468	726
		535, 577,	W710763-S901	22104	92,		541, 625	625	001-988-63-81	21469	726
W704342-S300	13751	298			98, 129, 133	XF5Z-14S411-AA	14918	238,	001-988-76-81	20205	727
W704385-S300	20193	603	W710769-S424	20268	583		245, 255	265	001-988-80-81	21465	727
W704740-S300	18816	598	W710791-S437	21215	613	XL3Z-13466-AA	BH10	265	001-988-97-81	22310	437,
W704881-S300	19237	93,	W710793-S439	21185	594	XL3Z-17E971-AA	19607	502,		489, 728	
		100, 598	W710923-S300	18680	430, 478		539, 607	607	001-990-00-91	20651	142, 733
W704897-S417	19419	307	W711031-S300	21826	596	XR819630	20363	499,	001-990-01-92	22339	531,
W704958-S300	19511	501,	W711035-S300	17216	576,		540, 610	610		545, 731	

O.E.M. INTERCHANGE BY NUMERICAL ORDER

OEM No.	Auveco No.	Page No.	OEM No.	Auveco No.	Page No.	OEM No.	Auveco No.	Page No.	OEM No.	Auveco No.	Page No.
003-994-30-45	13218	142, 656, 733	01553-03101	17378	525, 537, 754	07-13-1-480-419	21709	733	10121502	17664	425, 478
004-988-76-78	20657	726	01553-03201	20753	526, 541, 754	07-13-2-757-821	21659	733	10125439	16864	309
004-988-77-78	20657	726	01553-03269	15481	428, 477	07-13-7-073-915	21527	733	10126901	15669	471, 477
004-990-16-97	21286	314	01553-03803	19416	510, 539, 677, 723, 802	07-14-3-448-498	18156	106, 107	10131511	18461	308
006-988-30-78	20201	726	01553-03831	21121	739	07-14-6-962-771	22285	462, 489, 734	10134407	18030	537, 537
006-988-35-78	20199	727	01553-05131	21637	693, 756	07-14-6-963-883	22110	92, 133, 100, 129	10135796	18118	555
006-988-43-78	22236	451, 489, 729	01553-05233	22301	689, 740	07-14-6-976-114	22298	652	10139822	14991	570, 570
006-988-89-78	21434	726	01553-05323	21192	518, 542, 693, 723, 754	07-14-7-122-912	22086	474, 488, 653	10140480	16835	524, 524
007-603-014-104	19621	275	01553-05751	16860	739	07-14-7-122-913	21854	474, 486, 652	10143422	17102	455, 477
007-603-014-106	20454	275	01553-05751	22000	739	07-14-7-129-160	22030	92, 133, 100, 129	10146315	20177	423, 481
007-603-016-105	14871	146	01553-05933	21192	518, 542, 693, 723, 754	07-14-7-129-161	22030	92, 133, 100, 129	10153057	16695	458, 477
007-988-34-78	20879	463, 483, 729	01553-06071	21620	499, 543, 752	07-14-7-145-753	21139	460, 483, 734	10157547	16939	314
007-988-71-78	21467	727	01553-06451	22075	422, 488, 691, 749	07-14-7-201-307	22084	651	10158124	18175	536, 575
007-988-99-78	20879	463, 483, 729	01553-06721	17347	518, 537, 754	07-14-7-293-278	22146	657	10160960	18935	312
008-988-09-78	22498	56	01553-07111	20669	465, 482, 692, 750	07-14-7-296-886	22509	50	10167445	19357	557
009-988-03-78	22504	56	01553-07111	20669	465, 482, 692, 750	07-14-7-391-323	22144	657	10167448	18428	557
011-988-76-78	22309	461, 489, 729	01553-08101	21998	461, 488, 750	07-14-7-391-324	22131	657	10169377	12669	145, 178
01241-00551	17193	143, 756	01553-08231	21545	520, 543, 693, 753	07-14-7-391-324	22131	657	10169777	20344	416, 482
01241-00881	21459	144, 693, 757	01553-08911	21618	740	07-14-9-158-194	21762	651	10184895	13751	298
01281-00023	14275	736, 744, 787	01553-08961	21295	442, 484, 747	08540-61608	19170	93, 102, 130, 135	10185925	18301	423, 478
01281-0003U	19293	744	01553-09241	19246	510, 539, 752	08540-61608	19170	93, 102, 130, 135	10186453	18691	580
01281-0005U	21318	746	01553-09311	19684	440, 480, 751	09409-06309-5ES	21691	428, 486, 777	10195515	14995	495, 535, 569, 604, 623
01281-00072	14256	785	01553-09321	19274	516, 539, 754	09409-07303-5ES	19128	516, 538, 803	10201332	19514	309
01281-00111	22416	57	01553-09431	21134	520, 542, 753	09409-07308	17162	499, 536, 571, 801	10204266	18170	305
01281-00111	22416	57	01553-09611	20349	508, 540, 713, 752, 802	09409-07313	17383	492, 537, 570, 777, 800	10207146	17226	511, 537, 573
01281-00151	14335	736, 743	01553-09791	20668	463, 482, 692, 750	09409-07325	19243	568, 501, 538	10211824	10831	425, 475
01281-00231	14275	736, 744, 787	01553-10051	19905	515, 540, 753	09409-07332	20908	517, 541, 777, 804	10220168	18688	431, 478
01281-00331	21111	690, 744	01553-10501	20349	508, 540, 713, 752, 802	09409-08320	19257	466, 479, 711, 798	102229437	18680	430, 478
01281-00431	22176	745	01553-10501	20349	508, 540, 713, 752, 802	09409-08327	22083	501, 545, 777	10237960	19220	585
01281-00441	17342	743	01553-10641	22288	467, 489, 692	09409-08327	22083	501, 545, 777	10241518	18688	431, 478
01281-00501	21367	743	01553-10721	21192	518, 542, 693, 723, 754	OG032-50037-A	21146	508, 542, 699	10242285	20521	563
01281-00601	19293	744	01553-1JA0A	21229	439, 484, 691, 747	OK95-A-68401	22312	460, 489, 698	10242316	18680	430, 478
01281-00691	21324	690, 743	01553-2DR9A	22039	518, 545, 693, 752	OK95A-68615	21372	699	10246149	19788	569, 599, 539
01281-00711	20604	690, 744	01553-2U001	21824	690, 744	OWX68XDB-AA	21427	524, 543, 625	10249241	19501	431, 480
01281-00711	20604	690, 744	01553-30001	22237	463, 489, 750	10003294	12919	198	10261327	19410	554
01281-00801	17342	743	01553-S3500	13945	471, 476, 751	10003617	12927	199	10262036	18684	415, 478
01281-00831	20764	690, 742	01553-S3500A	13945	471, 476, 751	10004121	12943	199	10262143	19247	551
01281-00QAF	21930	742, 764	01651-00481	14695	667, 717, 736, 743, 787	10005510	14968	582	10270517	20464	565
01281-01081	20736	691, 745	028-103-059-A	21041	281	10008002	8814	177	10270672	19390	557
01281-01121	19741	667	03-446-243	12642	757	10008002	10052	177	10274778	19819	404
01281-01121	22274	690, 743	03762180	4265	394	10009923	12259	141	10277480	19676	551
01281-01321	21425	690	05-40-000-1R	21876	511, 544, 752, 769	10013764	11352	583	10278936	17654	299
01281-01431	22494	57	05480853	8889	293	10014363	12997	167	10280874	18680	430, 478
01451-00841	18340	92, 99, 129, 130	06504995AA	12993	418, 475, 766	10014675	12931	197	10280874	18688	431, 478
01454-N5061	22292	93, 101, 130, 135	06509673AA	21601	503, 543, 628	10017615	14677	278	10281487	20395	585
01454-N5061	22292	93, 101, 130, 135	06L-103-801	22143	277	10018202	12695	156	10283414	19368	438, 480
01515-0009U	21113	308	07-11-9-901-294	13215	142, 656, 733	10018202	12695	156	10285935	19270	457, 479
01515-00QOC	21876	511, 544, 752, 769	07-11-9-901-299	13215	142, 656, 733	10018202	12695	156	10287379	20261	122, 125
01552-00661	21999	755	07-11-9-916-945	13215	142, 656, 733	10027015	17230	551	10287547	20408	558
01553-00051	14356	448, 476, 748	07-11-9-963-253	14871	146	10031004	18014	258	10287926	20232	402, 556
01553-00172	14737	443, 476, 748, 791	07-12-9-901-645	13223	142, 656, 732	10032838	12713	552, 618, 765	10287971	19275	457, 479
01553-00202	14347	447, 476, 748, 792	07-12-9-901-651	13218	142, 656, 733	10036503	14023	297	10293193	20893	417, 483
01553-00291	14355	442, 476, 747	07-12-9-904-150	22114	142, 656	10040001	16920	258	10293674	19149	417, 479
01553-0034U	17350	520, 537, 679, 754	07-12-9-904-224	13218	142, 656, 733	10041588	14527	175	10297368	19381	563
01553-0038U	21311	508, 542, 752	07-12-9-904-224	13218	142, 656, 733	100451034	15467	404	10297369	20521	563
01553-00401	14355	442, 476, 747	07-12-9-925-708	13223	142, 656, 732	10053182	14997	500, 535, 569	10297370	20825	563
01553-0052U	20671	445, 482, 748	07-12-9-925-720	13162	143, 657	10053388	15045	530, 536, 578	10297371	19379	563
01553-00545	17452	443, 478, 747	07-12-9-925-737	13218	142, 656, 733	10062	12253	141	10297480	19676	551
01553-00755	16784	508, 536, 752, 802	07-13-0-702-516	21137	458, 483, 734	10062367	16695	458, 477	10278936	17654	299
01553-0075U	18948	417, 479, 749	07-13-0-702-715	20570	140, 681, 734	10063599	18683	415, 478	10280874	18680	430, 478
01553-01121	17452	443, 478, 747	07-13-0-702-966	17267	521, 537, 649	10069112	15488	297	10280874	18688	431, 478
01553-01182	20256	419, 481, 749	07-13-0-702-966	17267	521, 537, 649	10073833	12992	472, 475	10281487	20395	585
01553-01393	16843	533, 536, 724, 755	07-13-0-702-966	17267	521, 537, 649	10077283	15042	530, 535, 578	10283414	19368	438, 480
01553-01733	20196	496, 540, 800	07-13-0-702-966	17267	521, 537, 649	10078274	18897	417, 479	10285935	19270	457, 479
01553-0170U	22503	58	07-13-0-702-966	17267	521, 537, 649	1008068	21853	454, 486, 701, 815	10287379	20261	122, 125
01553-01781	17634	417, 478, 747	07-13-0-702-966	17267	521, 537, 649	10082288	18390	558	10287547	20408	558
01553-01A50	21519	417, 485, 691, 749	07-13-0-702-966	17267	521, 537, 649	10084751	19644	145, 179	10287926	20232	402, 556
01553-02741	17378	525, 537, 754	07-13-0-702-966	17267	521, 537, 649	10087223	15462	403	10287971	19275	457, 479
01553-02821	20670	459, 482, 751	07-13-0-702-966	17267	521, 537, 649	10089262	14987	493, 535, 569, 623			

O.E.M. INTERCHANGE BY NUMERICAL ORDER

OEM No.	Auveco No.	Page No.	OEM No.	Auveco No.	Page No.	OEM No.	Auveco No.	Page No.	OEM No.	Auveco No.	Page No.
10423553	20481	563	11501932	12253	141	11505044	18416	122, 126	11519444	20631	575,
10425306	20365	509,	11501937	12119	141	11505104	13712	91,			512, 541
		540, 574	11502449	15373	92,			96, 128, 131	11519444	20888	574,
10426555	21400	579,			98, 128, 132	11505182	14053	70,			512, 627, 541
		527, 543	11502483	12097	92,			129, 130	11519807	18896	524,
10426887	20775	560			98, 128, 132	11505209	13618	122, 126			538, 576
10431503	20775	560	11502504	12125	141	11505326	15790	122, 126	11519818	19783	598,
10431523	20810	559	11502507	15711	141	11505329	12595	139, 821			706, 786
10431524	19757	559	11502540	12115	141	11505329	16268	139, 821	11519949	19239	575,
10431526	20811	560	11502605	11639	122, 126	11505596	18338	145, 177		518, 538, 648, 676, 738	
10431761	19821	565	11502609	11644	140	11506101	11645	140	11519952	20422	586
10437563	19800	559	11502617	11629	145, 179	11506117	15335	139	11519960	20423	586
10437565	19800	559	11502618	22164	121, 123	11506174	12693	121, 124	11519960	19957	637
10442914	20353	563	11502618	22164	121, 123	11507036	11644	140	11519960	19958	637
10443956	20328	561	11502624	11639	122, 126	11507036	16269	140	11519960	19944	637
10444839	21228	432, 484	11502722	19309	140	11508023	12322	121, 124	11519960	19945	637
10445899	21504	563	11502737	12127	141	11508241	12575	145, 178	11519960	19954	637
10476561	9282	287	11502759	12126	141	11508269	13614	122, 127	11519960	19955	637
106212	14335	736, 743	11502770	10171	69	11508275	15330	139	11519960	22451	47
106653	12543	235	11502785	11627	145, 179	11508430	12339	94,	11519960	22240	450, 489
10708	12522	156, 157	11502790	11935	122, 126			103, 130, 136	11519960	22036	562
10709	12520	156, 157	11502794	12118	141	11508900	12253	141	11519960	22071	448, 488
1073	18004	258	11502811	11709	139	11508927	13002	168	11519960	22267	465, 489
1076	18469	258	11502812	11708	139	11508930	15791	121, 123	11519960	22278	453, 489
10998-30880	14696	498,	11502941	12693	121, 124	11509005	18449	145, 178	11519960	22279	454, 489
		535, 678, 694, 752	11503317	11630	145, 179	11509189	12350	94,	11519960	22276	559
11005	20299	259	11503394	12740	91,			104, 130, 137	11519960	22080	559
11006	20300	259			96, 128, 131	11509371	12057	93,	11519960	22080	559
11026-01M02	21258	276	11503395	12741	91,			102, 130, 135	11519960	22167	559
11026-JA00A	21258	276			97, 128, 132	11509374	12741	91,	11519960	22259	455, 489
1104882	21859	502,	11503396	12742	92,			97, 128, 132	11519960	22029	563
		544, 730, 757, 823			98, 128, 132	11509511	11639	122, 126	11519960	22258	561
11126AA000	19139	276	11503421	12213	72,	11509535	15711	141	11519960	22228	555
11128-01M0B	21293	277			91, 95	11509589	11638	122, 126	11519960	21835	621
11-13-7-605-018	22344	281	11503432	12117	141	11509816	12067	121, 124	11519960	22277	585
111-837-5811	13031	821	11503455	12667	145, 179	11509932	12253	141	11519960	21488	450, 485
111-837-5815	13031	821	11503483	12742	92,	11510062	12253	141	11519960	22492	48
111-837-581J	13031	821			98, 128, 132	11513599	21040	145, 177	11519960	22491	47
11254-06203	22296	94,	11503503	12097	92,	11513798	20600	260	11519960	22278	453, 489
		103, 130, 136			98, 128, 132	11513798	BH3	265	11519960	22279	454, 489
11254-06206	22296	94,	11503578	18261	28,	11513801	12738	92,	11519960	18470	258
		103, 130, 136			91, 97, 132			98, 128, 132	11519960	B1156	262
11296-3TA0A	22198	756	11503619	13613	122, 126	11513864	12064	121, 123	11519960	16904	258
11296-AG000	20953	519,	11503632	12336	122, 126	11514282	15711	141	11519960	12127	141
		541, 693, 754	11503636	12213	72,	11514290	10067	174	11519960	21200	564
113-853-615A	13227	141, 812			91, 95	11514343	11639	122, 126	11519960	22266	313
113-857-219A	13206	812	11503668	13705	122, 127	11514518	11644	140	11519960	20766	521,
1141	B1141	262	11503685	11627	145, 179	11514596	11644	140	11519960		541, 627
1141	16923	258	11503695	15335	139	11514623	12067	121, 124	11519960	14998	524,
1142	20681	259	11503698	12124	141	11515478	12575	145, 178	11519960		535, 570
1149900192	21859	502,	11503714	11864	145, 178	11515566	18781	91,	11519960	20888	574,
		544, 730, 757, 823	11503715	12575	145, 178			96, 128, 131	11519960	512, 627, 541	
114-990-01-92	21859	502,	11503716	11864	145, 178	11515638	22074	145, 177	11519960	18153	584
		544, 730, 757, 823	11503719	18449	145, 178	11515756	11639	122, 126	11519960	20884	564
114-997-Q2-90	20655	273, 732	11503736	14980	141	11515757	13614	122, 127	11519960	21383	456, 484
11500086	12350	94,	11503745	19205	140	11516077	11708	139	11519960	21384	553
		104, 130, 137	11503752	12595	139, 821	11516148	18477	259	11519960	20261	122, 125
11500401	15335	139	11503754	12596	139	11516149	12667	145, 179	11519960	21333	467, 484
11500421	2775	72	11503756	12596	139	11516150	11630	145, 179	11519960	20938	551
11500434	15373	92,	11503785	18261	28,	11516152	12667	145, 179	11519960	19644	145, 179
		98, 128, 132			91, 97, 132	11516152	18339	145, 179	11519960	12253	141
11500654	18337	145, 177	11503791	13715	121, 124	11516372	20416	145, 178	11519960	21361	578,
11500655	11625	145, 177	11503800	12324	121, 123	11516397	20339	145, 177	11519960		528, 543, 754
11500656	18338	145, 177	11503812	12064	121, 123	11516440	3079	71	11519960	22347	500,
11500657	11626	145, 178	11503815	12322	121, 124	11516596	13705	122, 127	11519960		545, 573
11500658	11628	145, 179	11503823	12693	121, 124	11516656	20935	563	11519960	21518	553
11500660	11629	145, 179	11503825	13618	122, 126	11516780	15335	139	11519960	20995	456, 483
11500661	11630	145, 179	11503833	15788	121, 124	11516807	20741	311	11519960	20996	456, 483
11500662	11631	145, 179	11503834	12065	121, 124	11516811	13755	297	11519960	20868	564
11500663	18339	145, 179	11503892	15373	92,	11516936	18927	310	11519960	21242	562
11500754	11935	122, 126			98, 128, 132	11516942	13619	122, 127	11519960	20998	457, 483
1150086	12350	94,	11503941	13617	121, 124	11517071	11708	139	11519960	20999	457, 483
		104, 130, 137	11503957	11864	145, 178	11517293	12596	139	11519960	20634	456, 482
11500970	12336	122, 126	11503957	12669	145, 178	11517343	12065	121, 124	11519960	21187	583
11500971	12348	122, 127	11503958	13715	121, 124	11517517	12324	121, 123	11519960	21753	584
11500994	12057	93,	11504010	15721	91,	11517700	19449	437, 480	11519960	21128	561
		102, 130, 135			96, 128, 131	11517706	13619	122, 127	11519960	11562568	22034
11500996	12339	94,	11504035	11627	145, 179	11517803	16622	512,	11519960	21047	278
		103, 130, 136	11504047	16842	145, 178			536, 575	11519960	20423	586
11500997	12354	94,	11504056	12738	92,	11517824	19297	571,	11519960	18811	293
		103, 130, 136			98, 128, 132			502, 539	11519960	21161	565
11501102	13613	122, 126	11504119	16980	141	11517873	20452	552	11519960	21617	585
11501105	11633	122, 126	11504230	1943	71	11517992	20615	433, 482	11519960	11146	425, 475
11501152	13613	122, 126									

O.E.M. INTERCHANGE BY NUMERICAL ORDER

OEM No.	Auveco No.	Page No.	OEM No.	Auveco No.	Page No.	OEM No.	Auveco No.	Page No.	OEM No.	Auveco No.	Page No.
11571159	21443	432, 485	12001470	13549	236	12085497	18524	239	12167116	18916	239
11571175	20934	562	12003757	13546	238	12085498	16694	239	12167121	18867	239
11571175	21242	562	12003758	13545	238	12085502	16964	241	12176844	19853	582
11571175	21374	562, 622	12003759	12600	238, 253	12085503	16514	240	12186456	20220	218
1157A	B1157A	262	12003878	13544	237	12085506	18918	242	12186457	20221	219
1157NA	16901	258	12004005	12536	235	12085507	16965	241	12187091	17111	240
11588308	18461	308	12004009	12540	235	12085525	17109	240	12191645	16351	235
11588308	21327	297	12004010	16359	235	12085526	17109	240	12337831	20892	567, 532, 541
11588415	18337	145, 177	12004188	19199	229	12085527	17109	240			
11588441	21351	586	12004201	8775	216	12085528	17109	240	12337852	14031	550
11588650	20883	583	12004311	12237	236,	12085533	17199	241	12337868	15518	588
11588782	19732	553			244, 253	12085538	18917	240	12337873	10054	177
11588782	19732	553	12010085	15948	215	12089040	14150	215	12337898	17341	404
11588818	21200	564	12010182	15937	215	12089188	14151	215	12337900	16953	580
11588863	20944	456, 483	12010293	18326	216	12089189	13659	209	12337915	15490	298
11588988	20631	575,	12010300	15955	216	12089189	19258	209	12337916	15783	88, 90
		512, 541	12010717	15953	214	12089190	13669	209	12337917	12669	145, 178
11589015	12738	92,	12010973	15951	214	12089190	19259	209	12337920	12737	472, 475
		98, 128, 132	12010974	18146	214	12089191	13678	209	12337920	14524	472, 476
11589111	21439	310	12010975	18152	215	12089191	19262	209	12337966	11630	145, 179
11589176	20972	560	12010996	15949	214	12089305	15948	215	12338011	15467	404
11589181	21199	420, 483	12012000	14884	222	12089306	18325	215	12338015	17437	592
11589182	20868	564	12013813	13543	238	12089307	20747	215	12338025	13009	168
11589244	20891	566	12014012	14462	215	12089340	16806	218	12338034	15453	396
11589289	19801	573,	12014254	20751	223	12089649	14883	217	12338074	16936	593
	500, 607, 626, 539		12014836	14153	216	12092075	16360	235	12338089	12594	555
11589289	20988	510,	12014837	14154	216	12092080	16355	235	12338096	12824	555
		574, 626, 541	12015024	18148	214	12092081	16354	235	12338100	15518	588
11589290	13996	506,	120151	12546	235	12092344	20226	218	12338114	9112	191
		534, 574	12015193	20618	216	12092345	20227	219	12338123	2775	72
11589290	14007	505,	12015323	14152	215	12094429	20583	222	12338146	8814	177
		534, 571, 625	12015631	19795	580, 271	12100	17995	258	12338146	10052	177
11589290	14753	570,	12015791	15950	214	12101820	19891	240	12338153	11621	304
	506, 605, 624, 535		12015792	15952	214	12101855	18870	239	12353912	15463	403
11589290	20880	574,	12015793	15954	214	12101856	18320	239	12354949	11083	229
		511, 541	12015797	18145	214	12101857	18318	239	12354969	15948	215
11589291	20989	512,	12015798	18147	214	12101859	18318	239	12354970	15937	215
		574, 541, 608	12015799	18151	214	12101869	18151	214	12355104	9481	213
11589292	20991	522,	12015857	14881	218	12101879	13559	256	12355107	14150	215
		542, 576,	12015858	20216	218	12101880	18867	239	12355107	14153	216
11589293	20889	576,	12015861	15938	219	12101895	17109	240	12375975	22453	48
		523, 608, 541	12015862	15948	215	12101897	16174	238,	123-990-00-92	20636	493,
11589294	20992	523,	12015870	15945	220			245, 254, 255			541, 731
		542, 576,	12015878	17002	216	12101898	16175	239,			516,
11589295	20993	528,	12015899	20749	215			245, 254, 255	123-990-02-92	20637	541, 731
		542, 577, 608	12015917	18324	215	12101903	17690	242			502,
11589296	20994	528,	12015972	15952	214	12101906	16967	239	123-990-05-92	21044	542, 730
		542, 577	12015983	16941	581, 271	12101909	13548	243			142, 733
11609292	22035	586	12020116	14880	218	12101909	17691	243	123-994-08-45	20650	142, 733
11609317	20422	586	12020120	15939	219	12101917	13686	233	1243-50-609	12591	716
11609385	12575	145, 178	12020126	15944	219	12101927	19554	242	1244839	9965	567, 824
11609411	12596	139	12020320	11948	217	12101937	17113	240	12450053	18001	258
11609417	20826	575,	12020321	18650	217	12101939	18871	243	12450143	B884	263
		514, 541	12020347	15935	217	12102568	17463	242	12450143	B893	263
11609483	21377	580	12020757	14883	217	12102620	16693	240	12450176	20595	260
11609535	20527	553	12020801	20748	215	12102621	14580	241	12450313	B921	262
11609536	20529	553	12027133	18923	238	12102664	21490	240,	1246926	14212	822
11609624	19220	585	12029960	17463	242			245, 254	1-246-926	14212	822
11609651	21745	583,	12033674	14150	215	12102747	17110	240	1-246-993	14209	822
		613, 631, 700, 777	12033817	15960	217	12102748	18527	241	1247872	15459	586
11609738	14980	141	12034046	15947	218	12102757	19555	243	12493-05167B	18340	92,
11609740	21667	564	12034047	15946	218	12103360	20230	219			99, 129, 130
11609762	22081	92,	12034051	14151	215	12103881	15497	217	12493-05167B	18340	92,
		99, 129, 133	12034342	18149	214	12110842	20217	219			99, 129, 130
11609836	22121	586	12040902	15924	217	12110843	20219	219	12493-06207-B	22295	94,
11609862	20938	551	12040983	19851	581, 271	12110844	20218	219			103, 130, 136
11609923	21667	564	12040984	19440	580, 271	12110845	20222	219	12493-06207-B	22295	94,
11609952	21027	584	12041351	20618	216	12110846	20225	219			103, 130, 136
11609952	21754	584	12043215	16694	239	12110847	20224	219	124-988-90-78	22115	732
11610049	21164	580	12045234	15927	233	12112171	13644	252	124-988-90-78-M89	22115	732
11610086	15543	426, 477	12045236	15926	233	12116958	17111	240	124-988-94-78	21759	727
11610157	21524	584	12045773	18653	217	12117260	14918	238,	124-990-04-92	20909	503,
11610198	20529	553	12046624	16693	240			245, 255			541, 731
11610210	21114	306	12047581	15498	217	12117354	19556	242	124-990-05-92-9051	20640	494,
11610271	3079	71	12047680	15497	217	12117361	17109	240			541, 730
11610383	21124	313	12047767	15499	217	12117367	11439	256	124-990-07-92	20203	532,
11610495	21793	562	12048074	18654	217	12117384	13547	243			540, 731
11610522	21157	565	12048369	14918	238,	12117385	17107	241	12499007929C75	20203	532,
11610544	22410	47			245, 255	12117387	18145	214			540, 731
11610605	21488	450, 485	12051234	14580	241	12124075	20214	218	124-990-07-92-9C75	20203	532,
11610606	21489	453, 485	12052922	16806	218	12124076	20215	218			540, 731
11610705	20938	551	12065158	18150	214	12124304	15938	219	12506490	20008	637
11610747	21301	428, 484	12066214	14881	218	12124515	8774	216	12519975	18417	556
11610748	21302	580	12066614	20231	220	12124580	15937	215	12530252	17654	299
11611110	21672	511,	12076946	17175	237	12124581	18324	215	12531209	19441	602
		544, 574,	12083005	16585	238	12124582	15948	215	12531210	19441	602
11611367	22268	559	12083006	16586	238	12124587	18325	215	12533567	17103	500,
11611375	21825	558	12083007	17108	236	12125637	11440	242, 254			536, 573, 607
11611435	21827	565	12083460	18924	236	12126451	18674	241	12540326	19725	591
11611623	22080	559	12083680	17172	238	12126452	15952	214	12547778	20089	638
11611626	21739	566	12083689	17173	238	12126470	16967	239	1254815	11838	549
11611651	21439	310	12084595	15948	215	12126473	18527	241	1255	BH3	265
11611651	22173	307	12084912	20209	220	12126487	17112	239	1255/H3	20600	260
11611677	22233	433, 489	12084913	20210	220	12129373	20213	217	1-255-551	14211	822
11611822	21488	450, 485	12085270	20752	223	12129409	20223	219	1-255-553	14210	822
11612035	22100	519,	12085330	1							

O.E.M. INTERCHANGE BY NUMERICAL ORDER

OEM No.	Auveco No.	Page No.	OEM No.	Auveco No.	Page No.	OEM No.	Auveco No.	Page No.	OEM No.	Auveco No.	Page No.
1268176-3	19248	503, 823	14078435	11852	303	15326410	19836	418, 481	15862656	21033	242
		539, 823	14082956	18817	91,	15328724	16352	235	15862656	21542	242
1268642	21859	502,		97, 128, 132		153297	16478	91, 96	15864780	22037	565
	544, 730, 757, 823		14083173	14820	584, 612	1539.16	21973	517,	15872008	20884	564
126-990-03-92	21044	502,	14090382	19278	92,			544, 763	15893516	20885	561
		542, 730		98, 129, 132		154534	16534	92, 97	15931605	21379	469, 484
127934	16910	258	14090908	16026	275	15502538	8931	294	15944588	21248	428, 484
127934	B57	262	14093088	14020	529,	15505451	16251	168	15953247	17649	472, 478
1295NA	19208	259		535, 577, 609		15506827	14012	297	15954398	19429	552
1304225	4249	395	14093311	10831	425, 475	1550971	18474	259	15955172	13752	298
13050	17994	258	14093869	14980	141	15516462	18749	311	15955523	17654	299
131282	16914	258	14100784	17382	585	15545178	18926	588	15956062	18169	309
13144822	21541	93,	14101262	15702	529,	15545202	15670	472, 477	15956470	14998	524,
	101, 130, 135			536, 577		15562609	16937	593		535, 570	
131-853-585C	10322	808	14103026	12084	301	15562610	17976	592	15958694	11146	425, 475
13235-A	8763	255	14103026	17424	302	15567924	15459	586	15958694	15414	425, 477
13252118	21365	450, 484	14103435	16953	580	15569071	20797	397	15959832	18268	530,
13252119	21364	453, 484	14103438	15042	530,	15569072	20798	397		537, 578	
13265959	21168	638		535, 578		155-809-966	12735	550,	15959833	18334	530,
13265959	22168	435, 488	14103461	15043	526,			616, 811		538, 578	
13-3008-L	15004	157		535, 577		15588024	13946	472, 476	15960325	18353	497,
13-3026-L	15010	157	14103461	15045	530,	15588078	14032	424, 476		538, 579	
13365058	22025	583		536, 578		15591860	19424	592	15960621	19355	572,
13503401	16902	258	14160-03103	22437	46	15596279	14031	550		496, 539	
13503417	B885	263	14160-05130	22436	47	15596280	14037	552, 618	15963179	16938	457, 477
13503418	BH13	265	14160-03133	22481	46	15596301	13946	472, 476	15964853	13966	170, 765
1351769	9112	191	14206-08250-B	22253	509,	15598757	15792	88, 90	15964971	16936	593
1355003	9069	550		545, 688, 699		15600382	12992	472, 475	15964972	16937	593
13584255	21220	240, 255	142451	20292	259	1560058	19626	824	15967691	19424	592
13584433	17112	239	142451	B68	262	1560058	19627	824	15969147	17216	576,
13585316	18868	239	142452	16911	258	15606344	20792	397		522, 608, 627, 537	
13586114	17110	240	142452	20705	267	15606409	20792	397	15975244	19834	427, 481
13-6003	15017	158	142453	18015	258	15607165	15970	472, 477	15986343	18371	424, 478
13-6005	15018	158	142454	16926	258	15612948	15970	472, 477	15986673	19356	457, 480
1370853	12735	550,	142456	16923	258	15614746	21028	297	15989431	21380	432, 484
		616, 811	142456	B1141	262	15614774	18244	311	15989487	19387	579
1377030	10365	552	1445	18472	259	15622490	17615	306	15990756	18030	537,
13-8004	15015	157	1449	18473	259	15632790	17508	585		506, 573, 626, 537	
1395-68-676	14369	515,	145525	14388	270	15638413	16938	457, 477	15993201	16622	512,
		535, 723	14591787	21802	418,	15641800	11110	88, 90		536, 575	
14002811	13002	168		486, 766		15648833	14988	493,	15994165	20542	504,
14003784	16986	87, 137	14592086	21804	418,			535, 604		540, 573	
14004876	12931	197		486, 766		15650655	9880	174	1600375	10759	547
14005089	11854	570,	14592087	21803	418,	15653790	19781	591	1605396	11146	425, 475
		492, 534		486, 766		15659161	17072	436, 477	1605396	15414	425, 477
14005097	16248	168	1477728	5592	176	15672149	19242	568,	1606642	11657	547
14005953	14977	88,	1480627	8359	176			492, 538	16-092-672-80	21812	519,
		89, 167	1480909	8377	176	15672183	19782	591		544, 763, 769	
14007510	13231	88,	14910-05000	22300	684	15672328	17599	474, 478	161	20285	259
		89, 167	14913-05010	21150	684	15672330	14998	524,	1610403	12917	198
14007510	13232	88,	14913-05010	21150	684			535, 570	1611249	20364	92, 100
		89, 167	1494251	15677	176	15672713	18167	304	16-13-1-176-747	21431	656, 732
14007511	14976	88,	1494252	8359	176	15678493	17215	434, 477	1614858	12931	197
		89, 167	1494253	10830	176	15678979	18948	417,	1617333	12919	198
14007940	12999	167	1494254	10054	177			479, 749	161-867-299-01C	19195	502,
14008227	12210	197, 399	1494257	10051	176	15679091	14953	567,		538, 818	
14011722	11109	88, 90	1494258	8814	177			532, 535, 603	1618890	11470	547, 634
14013246	13960	550	1494258	10052	177	15681408	17103	500,	1618890	11657	547
14017701	12930	197	15002520	18262	584			536, 573, 607	1619321	12137	430, 475
14017705	12923	198	15014352	20943	569,	15682898	18262	584	1619321	16263	430, 477
14017779	12947	199		497, 541		15683327	21387	583	1621253	12935	197
14017780	12924	198	15015804	18889	313	15685040	19424	592	1624705	2744	824
14019205	12567	571,	15026222	20158	638	15685099	20415	585, 613	1624705	12959	824
		505, 625, 534	15026223	20157	638	15686047	15792	88, 90	1631564	15478	430, 477
14019205	14007	505,	15029828	4369	395	15686142	18153	584	1635218	12999	167
		534, 571, 625	15031239	17654	299	15690531	18744	298	1636632	16624	505,
14019206	14007	505,	15033681	20860	583	15691478	17216	576,		536, 573	
		534, 571, 625	15037290	10080	631			522, 608, 627, 537	1638	20295	259
14019225	14007	505,	15040331	21290	586	15691493	16936	593	1638575	19162	175
		534, 571, 625	15045388	21195	400	15691494	16937	593	1640810	15373	92,
14019226	14011	504,	15056810	20362	430, 482	15691595	19424	592		98, 128, 132	
		534, 571	15061964	21195	400	15694099	18391	456, 478	1641-B	9257	283
14022878	12621	555	15076791	20444	468, 482	15694193	16936	593	1644290	18948	417,
14023108	12925	198	15078238	20860	583	15704030	19515	310		479, 749	
14025274	12916	198	15116576	20935	563	15705372	11246	547	16500308	14016	490,
14027471	12759	431, 475	15127746	20934	562	15707256	19317	585, 113		534, 572, 625	
14027775	20799	397	15149708	19639	573,	15709521	18262	584	16502342	20301	106, 109
14027776	20800	397		505, 626, 539		15714775	11655	548	16503329	14002	549
14027777	20793	397	15153415	19615	576,	15714775	11871	548	16503548	14145	550
14027778	20794	397		522, 539		15715058	17654	299	16506582	17000	547
14029095	12940	199	15175428	12930	197	15718794	13755	297	16510893	15676	549
14031114	12926	198	15199562	B4114K	262	15732202	18028	297	16517439	14021	416, 476
14031144	12916	198	15209748	21106	233	15733970	19614	553	16524326	20601	260
14031145	12932	199	15221959	20865	560	15733971	19613	553	16524431	18662	260
14031900	16880	140	152266	8375	176	15737532	12520	156, 157	1654047	11345	402
14032200	14008	533,	152267	8372	176	15737533	12522	156, 157	165-827-592	21480	811
		534, 567	152273	15677	176	15745990	20527	553	1660123	11717	55

O.E.M. INTERCHANGE BY NUMERICAL ORDER

OEM No.	Auveco No.	Page No.	OEM No.	Auveco No.	Page No.	OEM No.	Auveco No.	Page No.	OEM No.	Auveco No.	Page No.
16662182	19519	583, 631	19257055	B9004	264	1W6Z-238A91-AA	20363	499, 610	20570245	13994	529, 609
16674629	20189	427, 481	19257057	20599	260			540, 439		577, 534,	262
16675980	19658	588	19257375	17112	239	1Z0-837-732A	21980	439,	2057A	B2057A	258
16715497	17468	298, 308	19258649	21006	237			487, 813	2057NA	16908	587
16723225	12084	301	19260056	21487	591	20003056	20427	469, 482	20582532	18392	587
16-7552	17427	302	19260058	21404	590	20030401	15457	433, 477	20582533	18393	587
16758	9481	213	19260060	21403	589	20032850	11679	421, 475	20590899	13996	506,
16758A	4248	394	19260061	21406	590	20037597	12314	593			534, 574
168	4155	395	19260063	21444	590	20043351	19183	592	20603072	11152	401, 402
168	B168	262	19260066	17172	238	20043361	19183	592	20606417	14946	554
1688094	16921	258	19260663	21072	589	20046147	14559	591	20612732	13746	297
1689827	11425	555	19260663	21582	590	20058837	18398	566, 413	20624923	14014	550, 811
1706200	12095	91, 96	19299324	20485	588	20064875	15456	433, 477	20626174	19394	404
171-201-969	13828	556	193	18013	258	20085729	17073	405	20632190	17666	566, 413
17131	21456	821	19300089	13659	209	20097200	12569	595, 617	20633148	18392	587
17171	20589	259	19302122	21092	588	2011554	12084	301	20633149	18393	587
17177	20590	259	193065	18474	259	2011554	17427	302	20633504	15463	403
171-807-249-A	20591	259	19326896	15948	215	20123070	15467	404	20635065	13994	529,
	21494	470,	19329253	17112	239	20130258	13002	168		577, 534,	609
		485, 816	19329763	20485	588	20130258	13003	168	20641977	18218	252
1719245	21859	502,	19352194	22088	308	20158344	20675	587,	2064891	10621	471, 475
	544, 730,	757, 823	19355537	22423	48		614, 630,	634	2064891	16260	471, 477
1725489	21988	812	194	B194	262	20160591	15466	403	20652520	18679	430, 478
1725489	21988	812	194	16902	258	20162174	17176	404	20664091	14753	570,
1729250	11485	412, 554	194A	B194A	262	20169887	12135	402		506, 605,	624, 535
1732326	12315	593	194NA	18012	258	20171942	12594	555	20664092	14753	570,
1746408	18817	91,	198	16924	258	20173225	19817	400		506, 605,	624, 535
		97, 128, 132	199	18466	258	20175051	12563	555	20687704	16624	505,
1-74-713	12642	757	1999366	16898	260	20184399	11621	304			536, 573
1-74-820	19153	757	1999367	20859	259	201-988-04-78	20202	726	20699808	14921	416, 476
17562	4260	394	1999482	20620	259	201-990-00-50	20645	732	20712172	15463	403
175720B010	14011	504,	1BA41AX1-AA	20763	621	201-990-02-92	20638	520,	20712176	15463	403
		534, 571	1BA41XWG-AA	21175	621		541, 654,	731	20713843	15684	303
1758099	2752	824	1F1Z-14A411-CA	20561	251	201-990-05-36	21774	93,	20-72-175	13220	144,
1758099	12960	824	1F1Z-19E889-AA	19235	388		100, 129,	134		733, 757,	823
175-820-435	16252	168	1HO-819-055-B01C	21392	426,	20199675	14642	555	2072728	8746	156
175-853-577	13748	297		484, 814	526,	201-997-22-81	20659	727	20732399	10831	425, 475
175-853-577-01C	13748	297	1HO-819-055-C01C	21452	526,	20200750	18510	436, 478	20734005	17092	472, 477
175-853-577A	13753	298		543, 819	819	20237057	12602	555	2074089	8971	846
175-853-674	14014	550, 811	1HO-823-397	21483	819	2024778	18938	313	20747508	17341	404
175-867-299	13475	471,	1HO-823-717	21981	436,	2024781	8300	294	20747509	17159	404
		476, 768, 815		487, 813	447,	20274997	12824	555	2075380	19055	294
175-867-949	8418	112	1HO-837-719	21497	447,	20298365	11677	472, 475	2084421	8774	216
176653	16134	141, 823		485, 813	810	20319841	12731	429, 475	2085119	16940	312
176-941-117A	15666	634, 808	1HO-853-585	21394	810	20325696	12656	306	2085119	19057	294
17916	20593	259	1HO-853-585-A	21396	810	20328600	15467	404	2085823	19060	294
179-813-881	14030	550, 811	1HO-853-585-B	21395	810	20338568	13925	554	2096454	17115	221
179-813-883	12735	550,	1HO-853-586	21397	813	20340710	15463	403	2096466	14892	221
		616, 811	1HO-853-733B	19136	808	20345137	14549	592	2096467	15504	221
17988488	14820	584, 612	1HO-867-199-01C	21789	430,	20346654	14217	582,	21006725	18023	277
17997722	14820	584, 612		486, 814	526,		610, 634	593	21011332	12254	140
1815	18474	259	1HO-867-199A	21482	526,	20348200	12315	593	21021319	18749	311
1816	16919	258		543, 819	526,	20351035	12065	121, 124	21030249	17216	576,
18647-55009-E	BH9	265	1HO-867-199-A	21482	526,	20363491	13999	490,		522, 608,	627, 537
18649-55009-H	BH11	265		543, 819	473,		534, 572	490,	21030249	17216	576,
18649-60556	18661	260	1HO-868-243	21393	473,	20374473	12737	472, 475		522, 608,	627, 537
18649-60556-L	18661	260		484, 817	472, 476	20374473	14524	472, 476	21035018	14031	550
1889	18003	258	1HO-868-243-B	21415	473,	20376243	4441	395	21035345	19297	571,
1891	18002	258		484, 817	817	20393536	14033	556			502, 539
1893	B1893	262	1H5-863-849-A01C	21145	817	2040	19209	260	21039129	17975	434, 478
1893	16909	258	1H5-863-849-A01C	21145	817	20413107	11612	418, 475	21039141	17215	434, 477
1895	B1895	262	1H5-863-849-A-01C	21145	817	20421672	13752	298	21042045	17218	455, 477
1895	16906	258	1J6-867-276	22116	820	20421800	12992	472, 475	21042053	17218	455, 477
1900654	9361	409	1K0-837-199B	22397	64	20423550	15774	91, 96	21042058	17218	455, 477
19115561	11083	229	1K6-837-200B	22231	458,	20423647	13747	297	21042098	17214	569,
19115586	19199	229		489, 816	106, 107	20426301	14260	498,		493, 623,	537
19115640	21476	233	1L24-17A386-AA	16421	531		535, 568,	722, 801	21042104	17218	455, 477
19115673	17112	239	1L5Z-17K826-AA	19638	531,	20429451	13992	472, 476	21042108	20829	454, 482
19116359	21475	233		539, 607,	629	20429500	14553	593	21047094	16816	497,
19119304	21752	235	1R3Z-18D434-BA	21445	611	20430956	13858	582			536, 572
19130464	10649	273	1U2Z-14S411-AAA	17624	246	20432975	13748	297	21075686	17222	572,
19130464	14547	581, 271	1U2Z-14S411-AAB	17624	246	20433026	13753	298		500, 607,	537
19130464	20471	581, 271	1U2Z-14S411-AEA	20843	249	20444103	13458	556	21077123	19801	573,
19149964	20450	140	1U2Z-14S411-AJA	18671	250	20451119	13457	568,		500, 607,	626, 539
19152583	14524	472, 476	1U2Z-14S411-APA	20246	246		505, 534		21077131	17616	531,
19168446	19258	209	1U2Z-14S411-ARA	20550	246	20451401	13461	471, 475			537, 578
19168447	13669	209	1U2Z-14S411-BA	20277	249	20452072	14753	570,	21077323	17226	501,
19168448	19262	209	1U2Z-14S411-BAA	17617	249		506, 605,	624, 535			537, 573
19177104	17111	240	1U2Z-14S411-BB	20277	249	20453400	12064	121, 123	21077405	17227	490,
19179416	20872	588	1U2Z-14S411-BCA	16175	239,	20455900	14006	417, 476			537, 570
19183888	20758	789		245, 254,	255	20461373	13856	580	21077575	18033	440, 478
19183917	20757	708, 789	1U2Z-14S411-BHA	22185	249	20462090	16865	566, 413	21093588	17219	556
191-853-577	21508	809	1U2Z-14S411-BPA	20842	250	20465395	14005	297	21094146	16818	423, 477
191-853-577-A	21390	809	1U2Z-14S411-CA	19582	248	20475950	14014	550, 811	21094240	18515	121, 123
191-853-733-A	21416	808	1U2Z-14S411-DA	19126							

O.E.M. INTERCHANGE BY NUMERICAL ORDER

OEM No.	Auveco No.	Page No.	OEM No.	Auveco No.	Page No.	OEM No.	Auveco No.	Page No.	OEM No.	Auveco No.	Page No.
21992748	20482	611	24	18017	258	26053314	20149	637	3157SA	18479	259
2201406	12522	156, 157	2409826	8742	156	26261-89969	B7443A	262	3201767	13966	170, 765
2201407	12520	156, 157	24100042	21047	278	26272-8991A	B7440A	262	321-837-581-01C	14194	821
2207713	16132	426, 477, 823	2419255	8905	294	26296-9B904	BH13	265	321-867-299B	21993	810
22189414	20360	427, 482	24205245	20528	416, 482	26296-9B91D	BH9	265	3236813	12927	199
222	20287	259	24220-89986	14345	755	26296-9B92B	BH11	265	3237451	12949	199
22-44567-000	19844	639	24225-89960	21259	273, 756	26297-9B91A	BD2S	264	3239826	12935	197
22505958	12934	197	24233099	21093	278	26398-ED000	21850	689, 746	3297373	11442	243
22508049	12932	199	24405739	22024	559	26557-2U004	22440	57	33111-SR3-A01	18661	260
22508050	12918	198	24405740	22022	559	26557-2U001	21824	690, 744	33111-SR3-A01	20601	260
22508051	12937	197	24449408	21540	143, 178, 770	2664040	14985	436, 476, 629	33115-S84-A01	16897	260
22508052	12927	199	2448770	16873	833	26717-89950	B1156A	262	33115-S84-A03	BH1	264
22508803	11419	199	24501057	21090	428, 483	26717-9B90E	B3057	262	33116-S84-A11	B9006	264
22512276	12766	430, 475	24571185	16026	275	271022	10773	154	33116-SLO-003	BD2C	264
22512276	16262	430, 477	24574578	14988	493, 535, 604	2711-0613	17429	302	33116-SLO-003	BD2S	264
22512857	12605	548	2477054	8895	293	27158-Q0100	17634	417, 478, 747	33116-SLO-003	BD2S	264
22513813	12605	548	2486468	17434	632	274004	18472	259	33165-SAA-003	BH11	265
22516030	20450	140	2495701	8938	294	274007	18473	259	33165-TL0-003	16694	239
22527147	18748	584	2496279	9905	236, 253	2745108	20675	587, 614, 630, 634	332364	10831	425, 475
22527720	14035	424, 476	24A	262	262	2771-0613	17425	302	332364	16259	425, 477
22529733	2293	173	24NA	18018	258	2771-0817	17427	302	33303-S30-003	19206	259
22531616	11631	145, 179	25015169	12237	244, 253	2771-0824	17428	302	33303-SD4-671	16901	258
22535007	15044	530, 536, 578	2501569	12237	244, 253	2774-0613	17421	302	33303-SL4-003	19206	259
22536642	18298	417, 478	25016383	11612	418, 475	2774-0617	17423	302	333-867-633-4FB	21451	496, 543, 818
22537749	14220	552	25016383	11680	418, 475	2774-0817	17423	302	3357	B3357	262
22538004	14993	506, 535, 570	25099299	20163	579, 495, 540	2774-0824	17424	302	3357A	B3357A	262
22538102	14990	569, 492, 535	25117765	18925	240	27948-M7002	14348	444, 476, 748	3357NA	18478	259
22539533	15462	403	251-823-717	21982	436, 488, 813	279670	12523	156, 157	34201287	16826	105, 108, 121, 124
22542705	15045	530, 536, 578	2524525	8419	616	279670L	12521	156, 157	34201358	15331	139
22543363	17176	404	2534814	14461	846	279670R	12523	156, 157	34201545	12993	418, 475, 766
22547243	15543	426, 477	25508532	12566	553, 618	279671	12521	156, 157	34201621	12567	571, 505, 625, 534
22550254	17545	554	25512081	12729	582	28945-CA000	22275	755	34201631	18108	297
22566142	15684	303	25512688	19162	175	293	18467	258	34202159	17495	140
22566221	17106	495, 536, 572	25514221	11675	420, 475	2945108R	20675	587, 614, 630, 634	34202672	13993	573, 506, 534, 607, 626
22569178	18927	310	25522466	9285	287	2945109L	14967	587, 614, 630, 634	34202787	15478	430, 477
22578985	18911	554	25524005	14004	297	2962447	8774	216	342271	16253	168
22579423	18927	310	25525798	14220	552	2962448	8777	217	3426388	2272	409, 634
22585836	18912	310	25526447	19435	552	2962510	11440	242, 254	34301-692A-0000	14317	665
22587036	18310	529, 538, 577	25527289	14822	172	2962593	17115	221	343541	11243	547
22587341	12081	301	25530441	14527	175	2962984	8775	216	343543	11246	547
22595587	14988	493, 535, 604	25536302	14820	584, 610	2962987	8776	216	343555	11243	547
22595723	18930	469, 479	25552853	18423	557	2964547	11129	416, 475	343555	11245	547
22599312	20263	402, 556	25552856	17979	556	2965142	15957	216	343555-SD2-003	15997	659
22600612	18930	469, 479	25554845	19361	554	2965470	14892	221	3441734	12930	197
22600614	18930	469, 479	25556911	19166	175	2965580	15504	221	3441743	12930	197
22600616	18930	469, 479	25580123	19519	583, 631	2965716	15956	216	3454220	15673	587, 630
22603384	19820	560	25591491	12585	741	2971962	18690	218	3454221	15674	587, 630
22615352	19732	553	25601491	18174	423, 478	2973215	18651	218	345510	11154	237
22638717	13750	298	25603960	18389	416, 478	2973932	9905	236, 253	3457	B3457	262
22638717	20740	311	25605716	14527	175	2974309	8756	237	3457	20587	259
22641917	18912	310	25609048	17641	311	2977373	11442	243	3457A	B3457A	262
22642756	20262	430, 481	25612368	22058	496, 545, 604	2977607	11444	242	3457NA	20588	259
22643056	18889	313	25612415	22459	49	2978302	8755	236	3467-531	19153	757
22644361	19522	572, 494, 539	25618730	17121	310	2978302X	8755	236	347065	16237	168
22646099	19428	469, 480	25630331	19411	557	2998430	10332	428, 475	347347	13450	549
22649878	11691	550	25631448	19417	94, 104, 130, 137, 579, 629	2C5Z-13N021-AA	BH11	265	347893	11292	172
22649879	11691	550	25640501	3138	171	2D1867741	21843	728, 813	34906-S30-003	19207	259
22651066	18930	469, 479	25642453	17103	500, 536, 573, 607	2F1Z-9A317-AA	20482	611	34906-SLO-A01	20296	259
22657634	19787	569, 494, 539	25648693	20280	557	2F1Z-9A317-BA	20483	610	34906-SLO-A01	20730	267
22657634	19788	569, 493, 539	25649667	20466	552, 597	2L1Z-7852140-AA	15479	431, 477	34906-ST5-003	19207	259
22659122	19335	567	25655537	10831	425, 475	30006620	19257	466, 479, 711, 798	3496	20296	259
22677979	20666	571, 494, 541	25663903	20265	570, 529, 540	30008324	19243	568, 501, 538	3500378J02	BH13	265
22677980	20666	571, 494, 541	25670009	18848	455, 479	30012018	14696	498, 535, 678, 694, 752	3509575	9905	236, 253
22690838	21246	570, 494, 542	25672428	20279	472, 481	30020637	20908	517, 541, 777, 804	351050-S3	2309	409
22691056	21091	455, 483	25680782	14991	570, 506, 605, 535	3057	B3057	262	3513686	13542	253
22699649	20634	456, 482	25693852	19822	561	3057	16915	258	351450-S3	2309	409
22704458	20634	456, 482	25695687	19892	571, 530, 539	3057A	B3057A	262	3526573	19358	556
22713392	20634	456, 482	25696301	19758	470, 481	3057NA	16916	258	352839	4258	395
22717568	20483	610	25704141	19758	470, 481	30624192	21785	458, 486, 823	353123	1256	409
22718305	15480	429, 477	25704358	21428	552	30653441	21786	458, 543, 823	3533539	16940	312
22718369	21238	571, 530, 542	25705182	21517	94, 104, 130, 137, 579	3065575	11796	472, 475	3533539	19057	294
22722859	20634	456, 482	25707329	20244	515, 540, 579	3065575	16261	472, 477	353745-S	2598	193, 400
22722860	20635	553	25718851	20326	559	30753487	22138	822	3537056	18685	427, 478
22884291	22430	48	25722671	20318	557	30753556	22137	822	353745-S	2598	193, 400
230-990-00-92-9C75	20638	520, 541, 654, 731	25724529	20774	562	30784514	21784	822	3538469	21047	278
230-990-01-92	21086	517, 542, 627, 731	25732397	21081	106, 109	3078511	11130	434, 475	3538874	18394	530, 538, 628
23223178	20945	638	25742293	20976	560	30808521	22340	822	3540161	16940	312
23262603	21168	638	25744385	21503	565	309414	16835	524, 536, 570, 624	3540161	19057	294
23372321	20158	638	25749564	21227	434, 484	3104-426	13173	810, 822	354076	11246	547
23372322	20945	638	25762391	19758	470, 481	3155	17997	258	3540858	18308	514, 537, 575
23372327	20945	638	25774893	21375	566	3156	B3156	262	354341-S	5196	170
2357	B2357	262	25775903	21335	566	3156	17996	258	354400	12939	199
2357	B2357	262	25796285	21681	564	3156A	B3156A	262	354860-S	4248	394
2357	B2357	262	25803643	22026	551	3156NA	18475	259	3548804	18685	427, 478
2357	B2357	262	25822063	21287	432, 484	3157	18475	259	355891	2611	169
2357A	B2357A	262	25822063	21287	432, 484	3157	B3157	262	357020	12918	198
2357NA	18000	258	25832258	22372	47	3157	16917	258	3574085	11653	616
2396	17998	258	25922739	21370	564	3157A	B3157A	262	357811	4246	

O.E.M. INTERCHANGE BY NUMERICAL ORDER

OEM No.	Auveco No.	Page No.	OEM No.	Auveco No.	Page No.	OEM No.	Auveco No.	Page No.	OEM No.	Auveco No.	Page No.
357-853-585-A	21496	450, 815	380111-S	12949	199	388047-S100	11852	303	3U2Z-14S411-CNB	20561	251
			380334-S	8310	294	388047-S102	12653	303	3U2Z-14S411-CVAA	17623	247
357-853-586-D	20250	812	380370	8418	112	388047-S1021	11852	303	3U2Z-14S411-ECAA	21490	240,
357-868-143	21890	812	380382	9829	549	388047-S1021	12653	303		245, 254	254
358107	2272	409, 634	380575-S2	8847	88, 90	388131-S	12925	198	3U2Z-14S411-EDAA	20246	246
358470	9361	409	380613-S	4439	197, 399	388246-S	11612	418, 475	3U2Z-14S411-EEAA	16693	240
358501	8746	156	380614-S	4440	197, 399	388248-S-36B	11768	172	3U2Z-14S411-ESAA	20549	249
358560	19626	824	380615-S	12209	197, 399	388442-S100	12652	315	3U2Z-14S411-ESAA	20851	252
358560	19627	824	380707-S	11368	112	388442-S309	12652	315	3U2Z-14S411-ESB	20549	249
358560-S100	19626	824	380707-S	11370	106, 110	388577-S	11146	425, 475	3U2Z-14S411-EUA	16174	238,
3588314	13541	253	3816659	10649	273	388577-S	15414	425, 477		245, 254, 255	255
36000148	15666	634, 808	381671-S	10642	91, 94	388664-S100	14127	311	3U2Z-14S411-EUB	16174	238,
36001966	15666	634, 808	381801-S2	15774	91, 96	388904-S	20316	430, 481		245, 254, 255	255
36003452	13454	421, 475	381818-S2	9880	174	388908-S	14163	434, 476	3U2Z-14S411-FFAA	18216	250
362069	11638	122, 126	381863-S2	9879	174	388908-S	19655	434, 480	3U2Z-14S411-FKAA	22425	46
362379	11245	547	38211-SD2-000	15932	233	388916-S	12908	197, 399	3U2Z-14S411-FKAB	22425	46
363137	15461	471, 477	38212-SE0-000	15933	233	388930-S	12909	431, 475	3U2Z-14S411-FKAE	22425	46
363137	16017	471, 477	382163-S	19826	172	389089	13757	435, 476	3U2Z-14S411-FVA	19880	251
3652	20298	259	382413-S2	17460	92, 97	389129-S	12907	197, 399	3U2Z-14S411-GA	18819	248
365266	11826	547	382413-S9	17460	92, 97	389138	12937	197	3U2Z-14S411-GEA	18870	239
365270	11718	547	382443-S	4439	197, 399	389144-S	17075	457, 477	3U2Z-14S411-HNA	17623	247
3655015	4233	395	3828472	18329	310	389258	10831	425, 475	3U2Z-14S411-HZA	20848	245
3664645	4237	394	382929-S	12729	582	389268-S100	11621	304	3U2Z-14S411-HZB	20848	245
36711410	12918	198	382930-S	14531	271	389358-S	10831	425, 475	3U2Z-14S411-HKA	20837	245
367291	14976	88,	382931-S	14533	271	389358-S	16259	425, 477	3U2Z-14S411-KBA	20846	251
		89, 167	383000-S	12929	197	389360-S	11865	552, 595	3U2Z-14S411-KGA	19885	251
367292	12995	167	383000-S	12929	197	3893980	10330	549	3U2Z-14S411-KHA	18916	239
367292	12996	167	383001-S	12930	197	389443-S	12571	429, 475	3U2Z-14S411-KRA	17623	247
3673945	12918	198	383001-S	12930	197	3895904	12923	198	3U2Z-14S411-KRB	17623	247
3674096	18395	582, 409	383003-S	12937	197	389809	13757	435, 476	3U2Z-14S411-KTA	17624	246
3688699	8963	846	383004-S	12935	197	3899596	14030	550, 811	3U2Z-14S411-LNA	19623	248
3688811	4235	394	383005-S	12931	197	390018-S	17664	425, 478	3U2Z-14S411-LVA	17683	250
3689084	4236	396	383016	12916	198	3900684	4369	395	3U2Z-14S411-MFA	20846	251
3691590	10831	425, 475	383031	12927	199	3901067	19932	640	3U2Z-14S411-MGA	17598	249
3691590	16259	425, 477	383033-S100	10780	409	390126-S	14017	418, 476	3U2Z-14S411-MNA	17618	249
3691599	11371	616	383033-S100	11863	409	390126-S	14857	418, 476	3U2Z-14S411-MVA	20547	246
3693099	14217	582,	383033-S101	10780	409	390428-S100	17410	302, 310	3U2Z-14S411-MYA	20548	246
		610, 634	383033-S101	11863	409	390523-S	15675	614	3U2Z-14S411-NCA	18668	252
3693292	4250	395	383142-S	20310	502,	3907444	11719	112	3U2Z-14S411-NMA	17662	250
3696693	10843	400			540, 606	390964-S	18682	419, 478	3U2Z-14S411-NRA	13644	252
37	18465	258	383207-S	14217	582,	391304-S100	17606	388	3U2Z-14S411-NZA	19882	241
370247-S2N	5586	174,			610, 634	391305-S100	17607	388	3U2Z-14S411-PCA	18463	246
370374-S	4248	394	383229-S	11104	294, 305	391396-S100	17604	388	3U2Z-14S411-PJA	18463	246
3711168	4265	394	383229-S	11105	294, 305	391397-S100	17605	388	3U2Z-14S411-SCA	17112	239
3722635	2619	824	383229-S	11106	294, 305	3919773	11691	550	3U2Z-14S411-SFA	19882	241
3722635	12958	824	383255-S36	16770	155	3920179	11352	583	3U2Z-14S411-SLB	20845	251
372741-S100	9864	270	383356-S	14756	595, 617	3921446	9851	548	3U2Z-14S411-SMA	20845	251
372820-S36	12654	314	383569	8623	87	3921988	19130	276	3U2Z-14S411-TDA	18214	247
372820-S40	12654	314	383569	8624	87	3923948	10090	549	3U2Z-14S411-UEA	17622	250
373528-S32	5854	169	383569	8625	87	3927320	9481	213	3U2Z-14S411-VBA	19157	251
373846-S	12918	198	383847-S	11419	199	3944866	9965	567, 824	3U2Z-14S411-VZA	16694	239
3744734	10843	400	384051-S	19418	437, 480	3944866	12971	567, 824	3U2Z-14S411-VZB	16694	239
3744750	12237	236,	384111S	12949	199	3946988	2710	69	3U2Z-14S411-XA	19813	251
		244, 253	384111-S	12949	199	3960314	10362	88, 89	3U2Z-14S411-XBA	18216	250
3744999	2752	824	3843245	12598	253	3963228	11738	198	3U2Z-14S411-XLA	20839	248
3744999	12960	824	3843345	12628	227	3970076	12922	198	3U2Z-14S411-XXA	20841	247
3745361	4280	394	3843386	16349	221	3977775	11130	434, 475	3U2Z-14S411-YHA	18673	246
374985C1	9905	236, 253	3843392	12627	227	3982098	8359	176	3U2Z-14S411-YNA	18673	246
3751212	12923	198	3843432	13233	253	3984469	10653	72	3U2Z-14S411-ZA	19887	248
3752023	17467	305	384432-S	19459	310	3985058	11424	550	3U2Z-14S4AA-SLA	20845	251
375372-S	5592	442, 475	3846202	15783	88, 90	3986997	11109	88, 90	3W7Z-5422008-AA	18890	615
375480-S100	5195	169	384931-S36	17035	88, 90	3997391	14030	550, 811	4000141	11697	634
375480-S102	5195	169	385189-S100	11620	302	3998009	15759	588	400141	9829	549
3757NALL	20859	259	385189-S100	16837	302	3A0-853-575	21478	810	4001916	18508	441, 478
375890-S100	2595	169	38529-689A-6300	14323	447,	3A0-853-575-A	21448	809	4001934	13467	435, 475
375890-S102	11293	169			476, 671	3A0-867-301-01C	21994	810	4003120	13004	168
375936-S	17469	305	385323-S100	11621	304	3B0-853-575	21449	809	4003672R	20675	587,
3759944	18770	416, 478	385323-S100	16838	304	3B0-853-576	21447	810		614, 630, 634	634
3762180	4280	394	385330-S	11136	441, 475	3B0-868-243	20341	473,	4003673L	14967	587,
376337-S100	9853	86	385353-S	12210	197, 399			481, 816		614, 630, 634	634
376337-S100	9854	86	385400	15345	155	3C0-853-585	21761	809	4004569	10831	425, 475
376337-S100	9855	86	385595-S	19655	434, 480	3C0-853-586	22445	63	4004569	16259	425, 477
3764863	12599	253	385661-S	11351	429, 475	3C0-853-934	22280	498,	4004689	10330	549
3764865	12598	253	385677	19425	437, 480			545, 818	4005091	18296	92, 98
3767196	18979	400	385974-S	19460	312	3C0-863-559	22338	431,	4005099	11349	471, 475
376785-S2	15351	155	3861577	11347	421, 475			489, 814	4005250	11350	433, 475
376988-S2	10654	72	3861577	11679	421, 475	3D0-864-812-A-B41	22441	63	4005470	11678	471, 475
377537-S	16039	74	386299-S	16954	611	3D0-864-851-B41	22411	63	4005540	11152	401, 402
3775994	18770	416, 478	3863669	8942	549	3M8Z-1502316-A	20923	532,	4005714	15813	401, 634
3783002	5278	106, 107	386553-S	19655	434, 480			541, 604, 722	4006204	11470	547, 634
3783006	5228	112	3866846	15345	155	3M8Z-16K262-A	21304	597	4006316	13965	169
3783794	5195	169	387042-S	12939	199	3M8Z-17C432-A	21300	597	4006516	11612	418, 475
378527-S1											

O.E.M. INTERCHANGE BY NUMERICAL ORDER

OEM No.	Auveco No.	Page No.	OEM No.	Auveco No.	Page No.	OEM No.	Auveco No.	Page No.	OEM No.	Auveco No.	Page No.
4095145	12929	197	4580779	14011	504,	4857753-AA	20359	513,	51-21-8-205-295	20388	521,
409988	4417	389			534, 571			540, 575			540, 655
4100727	12932	199	45998051	12119	141	4860198	10330	549	51-32-1-938-884	21423	400, 650
4104998	12937	197	46064AE000	21593	497,	4860375-AB	20667	618	513388		4243, 394
4114785	12134	410			543, 774	4860379-AA	21026	426, 483	51-41-015-44-20		21764, 651
4114K	B4114K	262	4628769	19626	824	4872948	4446	395	51-41-0-407-983	22229	466,
411700	11721	417, 475	4630088	18031	297	4876498	10744	437, 475			489, 654
4124081	20389	253	4630088	18028	297	4877000	8385	825	51-41-0-407-984	21788	466,
4124721	12598	253	4630253	18029	533,	4877001	8386	825			486, 653, 734
4-131-508-M	13230	490,			537, 623	4878883-AA	20164	434, 481	51-41-1-802-258	13170	651
		534, 730, 823	4630660	18031	297	4879431	9229	91, 95	51-41-1-973-500	20253	471,
4137121	4242	394	4636360	18921	253	4879481	8448	825			481, 653
413945	8744	156	4636361	18920	253	4882723	11120	416, 475	51-41-700-16-29	21764	651
4157	B4157	262	4636362	18920	253	4883164	8399	825	51-41-7-001-629	21764	651
4157K	B4157K	262	4637277	20175	824	4886720	8447	825	51-41-8-172-050	13179	470,
4157LL	20620	259	4638136	14753	570,	4887980	18395	582, 409			475, 653, 816
4157NALL	20621	259			506, 605, 624, 535	490067	11770	87	51-41-821-58-06		21762, 651
416629	12069	410	4638136	14993	506,	490067	11771	87	51-41-8-224-768	21788	466,
4167810	12920	198			535, 570	4956-A	15017	158			486, 653, 734
4179981	12946	197	463-988-02-78	20735	470,	4963	15015	157	51-41-8-224-781	22229	466,
4179982	12944	199			482, 729	4A0-805-121-A	21515	814			489, 654
4200408	15326	139	4657731	2628	402	4A0-805-121C	22208	814	51-43-0-141-025	22229	466,
4201198	12934	197	4658444	19191	631	4A0-805-121C	21885	814			489, 654
4234830	15518	588	4658673	19149	417, 479	4A0-805-163	21815	812	51-43-7-001-491	21138	464,
4241054	12939	199	4658676	20675	587,	4A0-853-825	21492	810			483, 734
4241296	12930	197			614, 630, 634	4A0-853-825-A	21493	809	51-43-7-194-187	22109	656
4241362	12916	198	4658677	14967	587,	4A0-853-825C	21481	809	51-44-7-780-135	21499	652, 728
4270974	11369	106, 109			614, 630, 634	4A0-853-825-C	21481	809	51-45-030-47-03	21764	651
4-29-29-06	13198	421,	4658887	20165	416, 481	4A0-857-610	21986	811	51-45-0-396-330	21763	651
		475, 657	4676189	19807	824	4A0-867-276	21818	820	51453-0E010	21860	525,
4301446	15759	588	4676356	19339	631	4A0-867-276A	22108	810			544, 713, 804
4304729	16804	221	4689929	2744	824	4D0-807-300	22101	525,	51453-0E010	21860	525,
4307218	12943	199	4689929	2818	824			545, 818			544, 713, 804
4336115	17167	632	4689929	12962	824	4D0-867-299D	22204	817	51453-48010	21860	525,
4339372	21022	403	4696129	18033	440, 478	4F0-805-163	22098	820			544, 713, 804
4341060	17004	435, 477	4696488	14995	495,	4F0-825-429A	22235	813	51453-48010	21860	525,
4368618	15499	217			535, 569, 604, 623	4F1Z-9A317-AA	21214	611			544, 713, 804
4370138	17101	298	4699315	2619	824	4L0-886-373	22094	812	51454-0E010	21856	518,
4378751	20030	635	470433	20795	397	4L3Z-1503296-AB	20836	400			544, 713, 804
4378794	19933	640	470434	20796	397	4L3Z-1510182-AA	20862	599	51454-0E010	21856	518,
4381395	20316	430, 481	4717224	19855	425, 481	4U2Z-14S411-DA	20852	249			544, 713, 804
4389940-AB	21670	621	4721222	4281	396	4U2Z-14S411-FA	19890	245	51454-48010	21856	518,
4389947-AA	21376	527,	4723818	2789	824	5008055-AA	20309	405			544, 713, 804
		543, 628	4723818	12961	824	5012874-AA	19628	467, 480	51-45-8-161-557	21763	651
4399576	20389	253	472434	11699	571,	5017410-AA	14021	416, 476	51-45-816-52-60	21764	651
4400588	13542	253			506, 624, 534	5023111-AA	19804	470, 481	51-45-8-266-814	21775	652
4417599	8447	825	472450	15453	396	5023173-AA	20563	469, 482	51-46-7-002-606	21779	491,
441863987B	21485	820	472812	12935	197	5023351-AA	19804	470, 481			544, 654
4428987	19155	435, 479	472814	12921	198	5028438-AA	20428	468, 482	51-47-0-146-782	20638	520,
4437565	12237	236,	472815	12922	198	5073327-AA	20187	491,			541, 654, 731
		244, 253	4730773	20175	824			540, 730, 817	51-47-0-390-017	20638	520,
443-853-909-A	21491	809	474821	14976	88,	5103921-AA	20637	516,			541, 654, 731
444613	9278	287			89, 167			541, 731	51-47-1-881-521	21851	474,
444619	9279	287	4755299	8435	112	51-11-1-908-077	20234	500,			486, 652
444620	9279	287	4759145	2943	567, 824			540, 654, 730	51-47-1-911-992	20638	520,
444667	9285	287	4759514-AA	20356	619	51-11-1-942-789	21861	657			541, 654, 731
444776	9283	287	4759514-AB	20356	619	51-11-1-944-537	20734	520,	51-47-1-919-209	22052	521,
444777	9283	287	4761842	2943	567, 824			541, 655			545, 655
444782	9284	287	4767559	4446	395	51-11-1-964-186	22401	50	51-47-1-945-266	21777	455,
444789	9285	287	47749-06010	21357	708	51-11-7-160-451	21782	651			486, 653
4453429	12569	595, 617	47749-06010	21357	708	51-11-8-174-185	20248	521,	51-47-2-499-935	21851	474,
445429	11292	172	47749-08010	20757	708, 789			540, 655			486, 652
4457495	10220	554	47749-50090	21357	708	51-11-8-400-709	21844	657	51-47-7-117-532	22090	469,
4457595	10220	554	47749-58010	20757	708, 789	51-12-7-004-445	21777	455,			488, 654
4459049	9342	413	4778115	20139	635			486, 653	51-47-8-116-564	21851	474,
4486948	11157	237, 253	4778814	2744	824	51-12-7-020-321	21987	812			486, 652
4490167	9477	566	4778814	2818	824	51-12-7-070-202	22113	145,	51-47-8-166-992	21780	490,
4492962	10318	556	4778814	12962	824			177, 657, 820			544, 654
4492962	11288	554	4779348	2943	567, 824	5113015-AA	18032	493,	51-47-8-183-031	21851	474,
4495047	9367	586	4784018-AA	21231	619			537, 623			486, 652
4498100	14552	632	4801268	3620	442, 475	51-13-1-804-205	13158	650	51-48-1-884-779	22052	521,
45262	10048	176	480534	19418	437, 480	51-13-1-829-904	21767	650			545, 655
45262	18998	176	4805405-AA	19638	531,	51-13-1-885-399	16115	532,	51-48-1-915-964	20270	516,
45262-S2	10048	176			539, 607, 629			536, 655			540, 655
45263-S101	10050	176	4805405-AB	19638	531,	51-13-1-934-160	22202	651	51-48-1-938-725	20270	516,
45263-S2	10050	176			539, 607, 629	51-13-1-960-054	21429	650			540, 655
45264	10053	176	4805570-AA	20526	631	51-13-2-251-394	21430	650	51-48-8-126-849	22524	50
45264-S2	12265	176	4806110-AA	20767	526,	5113360-AA	20529	553	51-48-8-181-420	21757	445,
45265-S2	10054	177			541, 628	51-13-6-440-146	21767	650			486, 652
45267	10051	176	4806226-AA	21187	583	51-13-8-124-389	20254	652	51-49-0-151-605	22057	450,
45268-S2	8814	177	4806240-AA	20768	513,	51-13-8-166-675	21432	650			488, 653
45268-S2	10052	177			541, 627	51-13-8-231-130	21766	650	51-49-8-105-79	22057	450,
45269	10055	177	4806240-AB	20768	513,	51-14-1-807-495	20186	651			488, 653
45269-S	10055	177			541, 627	51-14-1-902-279	20186	651	51-49-8-105-790	22057	450,
45332	15347	155	4806271-AA	22028	619	51-16-1-881-149	20187	491,			488, 653
45334	15345	155									

O.E.M. INTERCHANGE BY NUMERICAL ORDER

OEM No.	Auveco No.	Page No.	OEM No.	Auveco No.	Page No.	OEM No.	Auveco No.	Page No.	OEM No.	Auveco No.	Page No.
51-71-1-958-025	22087	656	53879-17020	21359	143, 715, 807	57172C91	11156	237	6003752	20276	402
51-71-7-002-953	20754	297				5735-L	15004	157	6003774	13927	620
51-71-7-006-757	22140	650	53879-20020	21613	143, 807	57371GA070	22210	776	6003858	13847	620
51-71-7-066-220	22141	650	53879-22010	14276	144, 808	574355	19626	824	6003861	13843	620
51-71-7-066-223	22142	651	53879-22030	14750	143, 725, 807	574355	19627	824	6003878	20276	402
51-71-7-066-226	22092	474, 488, 653				575411	2789	824	6003916	20276	402
			53879-28010	22412	60	575411	12961	824	6003965	13927	620
51-71-7-066-299	22091	473, 488, 652	53879-30040	21797	708, 789	57728AC090	19246	510, 539, 752	6004036	17151	402, 620
			53879-30050	22489	60				6004162	17064	620
51-71-7-127-742	21716	733	53879-50020	21358	708	57750AA090	21578	526, 543, 776	6004212	14005	297
51-71-8-184-574	21765	650	53879-58010	20758	707, 789				6006264	3404	155
51-71-8-259-788	21781	521, 544, 655	53879-60010	20335	507, 540, 802	57750FC010	21577	771	6010029	19626	824
						588546	15037	91, 95	6010029	19627	824
51-75-7-271-848	22084	651	53888-48010	21225	509, 542, 803	58974-0008	17195	597, 620, 658, 694, 735	6010046	2752	824
51-77-7-171-002	21787	454, 486, 653, 734							6010046	12960	824
			53935-35020	21162	783	59114AG000	21192	518, 542, 693, 723, 754	6010093	2744	824
51-77-7-171-003	21776	435, 486, 652	54229-0201P	16340	401, 756				6010093	12959	824
			547944	4439	197, 399	59122AC030	21580	518, 543, 775	6013029	2619	824
51-77-7-171-004	22147	657	5480766	19505	787				6013029	12958	824
51787-60070	22479	61	5480772	20863	577, 525, 541	59122FA010	21571	517, 543, 775	6013122	11677	472, 475
5183468-AA	19472	580, 610							6023171	10053	176
5189180-AA	21154	621	5480852	20756	562	59130AA000	14697	568, 496, 535, 678, 722	6023204	15345	155
5189181-AA	21155	623	5480853	8889	293				6023718	18811	293
5208743	15040	423, 476	5482087	21284	582	591-740	12637	822	6023925	8242	112
52115-0C090	21221	783	5482103	20881	450, 483	5949838	3178	548	6025004	15345	155
52115-48040	21132	783	5485676	17216	576, 522, 608, 627, 537	5953005	5788	548	6025005	15347	155
52161-02020	18873	513, 538, 803				5963268	11156	237	6025007	15350	155
			549790	11640	122, 127, 55	5973400	12757	572, 528, 534	6025329	9480	88, 89
52161-16010	18873	513, 538, 803	55022134	15042	530, 535, 578				6026166	16237	168
						5973823	19847	571, 525, 539	6026430	9299	154
52161-20010	20931	513, 541, 803	55054844	15666	634, 808				6026723	10655	87
			55055098	18248	442, 478	5973996	12756	572, 529, 534	6026723	10656	87
52188-06030	22197	789	55074801	14010	528, 534, 571, 625				6026958	10086	154
52197-22020	22096	707, 789				5988-L	15010	157	6027924	10080	631
52197-30040	21682	706	55075139	17214	569, 493, 623, 537	5988-R	15009	157	6027958	19485	112, 617, 736
52197-52010	21133	782				5BB14LX9	19245	514, 538, 627			
52-20-1-964-201	22521	50	55075487	20110	635				6029348	16852	154
52-20-8-238-999	13167	652	55075488	20090	635	5C3Z-12224-A	18527	241	6029501	12735	550, 616, 811
52535-0E010	21015	707, 786	55116997-AA	22461	49	5C3Z-13466-AA	18016	258			
52535-0E030	21712	705, 782	55116997-AB	22461	49	5C3Z-13466-AA	18465	258	6030441	11146	425, 475
52535-30150	21583	707, 786	55156429-AA	20523	621	5C3Z-13N021-AA	BH13	265	6030441	15414	425, 477
52535-50060	21015	707, 786	55156447-AB	20700	622	5F7Z-13466-B	20285	259	6030441	18815	419, 479
5255110	18979	400	55156655-AA	21738	623	5FR56DX9	19894	621	6030538	10832	425, 475
52599-0E010	21084	707	55156879-AB	20962	619	5FR56XXX-AB	19894	621	6031091	11621	304
52599-48020	22335	710	55157055-AA	20700	622	5GCG71RC3-AA	20273	514, 540, 606, 625	6031091	16838	304
528846	13004	168	55157065-AA	20887	623				6031115	11620	302
5288722AA	18263	594	55157069-AB	20827	622	5GC71RK5-AA	20273	514, 540, 606, 625	6031115	16837	302
5297428	18952	212	55157070-AC	20828	621				6031138	14218	618
53	B53	262	55157112-AA	20890	533, 541, 629	5GF92RC3-AA	20273	514, 540, 606, 625	6031147	8865	154
53	16914	258							6031183	14218	618
53041045	16873	833	55157112-AB	20890	533, 541, 629	5GF92RK5-AA	20273	514, 540, 606, 625	6031234	13647	617
53130	12657	312							6031321	10831	425, 475
53130	12657	312	55176248	14020	529, 535, 577, 609	5GUU9K111BA	20993	528, 542, 577, 608	6031383	11704	505, 534, 624
53145-12010	22163	779									
53145-16020	18846	786	55256967-AC	19816	400	5J0-867-276	21893	454, 487, 815	6031390	11699	571, 506, 624, 534
53145-60030	22212	444, 489, 709, 791	55350747-AB	19775	469, 481						
			554343	11831	582	5L8Z-16828-AA	16954	611	6031438	12995	167
53181	12654	314	55568037	21650	279	5R3Z-54310D12-AAA	21024	507, 542, 608, 722	6031438	12996	167
53181	12654	314	55577568	22360	46				6031869	12713	552, 618, 765
53259-0E010	21525	513, 543, 713	556196	11665	547	5R3Z-54310D12-BAA	21560	422, 485, 720			
			556539	11667	548				6031875	19152	631
53271-0B010	22102	707, 778	556992	12932	199	5U2Z-14S411-SA	19156	250	6032061	12566	553, 618
53271-12040	22102	707, 778	557057	11655	548	5U2Z-14S411-SB	19156	250	6032083	16851	154
53271-12060	22102	707, 778	557057	11871	548	5U2Z-14S411-TA	19156	250	6032138	16687	308
53271-44010	20738	705, 778	557057	12605	548	5U2Z-14S411-VA	19582	248	6032363	11351	429, 475
53326-08010	21211	434, 484, 793	55914-S2	13021	93, 102	5U2Z-14S411-XA	22425	46	6032516	13466	112, 616
			559312	11655	548	5U2Z-14S411-ZB	20842	250	6032856	17615	306
53384-0R010	22126	514, 545, 803	56001419	11871	548	5X0-867-299	21894	473, 487, 817	6032881	12652	315
			560625	12937	197				6032926	12655	303
53384-68010	22126	514, 545, 803	560692	11419	199	6000020	2611	169	6032926	14486	303
			561	18010	258	6000121	13173	810, 822	6033082	17664	425, 478
534343	11831	582	562	20289	259	6000258	19537	170	6033184	2625	111
53452-90351	17611	805	562327	11831	582	6000558	10073	169	6033560	15345	155
53455-14020	14732	805	5655006	9905	236, 253	6000605	5854	169	6033677	14756	595, 617
53455-33010	19529	805	568792	19626	824	6000705	2619	824	6033688	18810	314
53455-33011	19529	805	568792	19627	824	6000705	12958	824	6033840	17664	425, 478
53813-48011	22132	454, 488, 711, 796	56910-S2	13025	91, 95	6000709	2744	824	6033862	11349	471, 475
			56910-S424	13025	91, 95	6000720	2752	824	6034212	18461	308
53857-0E010	22334	710	56911-S2	13711	91, 97	6000720	12960	824	6034213	10375	154
53857-12010	22346	703, 779	56911-S2	13711	91, 97	6000943	8419	616	6034336	19310	631
53857-47011	22103	435, 488, 710, 793	56911-S36	13711	91, 97	6000943	9377	616, 764	6034376	18373	276
			56911-S61	13711	91, 97	6001419	5592	442, 475	6034703	18934	94, 103
53867-47020	21237	789	56912-S	13026	92, 97	6002893	10622	402	6034812	19310	631
53879-06100	21797	708, 789	56929-S2	13711	91, 97	6003147	11354	620	6034848	19657	306
53879-0R010	22412	60	57	B57	262	6003219	13616	620	6034944	16988	299
53879-14010	14750										

O.E.M. INTERCHANGE BY NUMERICAL ORDER

OEM No.	Auveco No.	Page No.	OEM No.	Auveco No.	Page No.	OEM No.	Auveco No.	Page No.	OEM No.	Auveco No.	Page No.
6035821	20524	618	63-21-7-190-591	BH13	265	6502689	18501	297	6507741-AA	21354	278
6036148-AA	20629	308	63-21-7-217-509	BD1S	264	6502738	17353	156	6508072-AA	21236	617
6036155-AA	11146	425, 475	63844-01A00	16858	522,	6502745	16868	833	6508197-AA	21098	510,
6036310-AA	18163	156		536, 606, 699, 723, 753		6502776	18102	612, 631		542, 605, 624	
6036679-AA	22371	47	63844-01A99	14726	505,	6502790	14753	570,	6508365-AA	20623	630
6036747-AA	18163	156			535, 752		506, 605, 624, 535		6508444-AA	21446	297
60658-SB3-000	17289	681	63844-D0100	14727	567,	6502842	17975	434, 478	6508540-AA	21418	305
60658-SD2-000	17289	681			532, 535, 694, 755	6502871	14992	500,	6508643-AA	21348	531,
6100042	11629	145, 179	63846-5V000	21768	690, 744		535, 604, 624		6508712-AA	20888	543, 629
6100047	19216	139	63846-9E000	20813	746	6502907	17669	467, 478		512, 627, 541	
6100048	15329	139	63848-01G00	16782	520,	6502988	19519	583, 631	6508727-AA	21257	426, 484
6100049	15331	139			536, 677, 753	6502991	17685	469, 478	6508746-AA	14010	528,
6100050	15333	139	63848-35F00	19735	143, 757	6503106	18269	526,		534, 571, 625	
6100053	15337	139	63848-40Y00	20613	511,			537, 628	6508863-AA	20988	510,
6100539	12232	121, 123			541, 753	6503108	18034	617		574, 626, 541	
6100566	12160	121, 124	63848-9E001	20327	512,	6503163	14997	500,	6508947-AA	21153	622
6100567	19455	125			540, 753			535, 569	6509049-AA	20880	574,
6100568	15818	122, 125	63848-9Y000	21664	693, 756	6503204	18862	468, 479	6509103-AA	19801	573,
6100775	12254	140	63848-D0100	17193	143, 756	6503221	12766	430, 475		500, 607, 626, 539	
6100810	12115	141	63848-D4000	17385	143, 757	6503336	21023	474, 483	6509106-AA	21019	632
6100811	12253	141	63848-D4001	17385	143, 757	6503339	21023	474, 483	6509288-AA	21223	622
6100814	19548	141	63854-01A00	17472	522,	6503373	18249	680	6509432-AA	22289	584,
6100815	16829	141			537, 739, 754	6503374	18825	618		612, 631	
6100839	12122	141	63876-95596	16000	516,	6503401	19417	94,	6509539-AA	21865	93,
6100840	12123	141			536, 679, 723, 753		104, 130, 137, 579, 629			100, 129, 134	
6101283	11629	145, 179	63878-01E10	20348	523,	6503433	18375	280	6509590-AA	21679	423, 486
6101308	18449	145, 178			540, 753	6503453	18394	530,	6509673AA	21601	503,
6101718	19455	125	6399980185	20647	728			538, 628		543, 628	
6102396-AA	19455	125	645350	1256	409	6503454	18327	198	6509761-AA	22459	49
6104900-AA	21086	517,	6466355	12920	198			538, 625	6509884-AA	20989	512,
		542, 627, 731	6500092	12617	156	6503573	15861	834	6509960-AA	21680	507,
6104908-AA	18302	416, 478	6500284	15329	139	6503598	17216	576,		544, 541, 608	
61118-35010	21194	779	6500361	14561	633		522, 608, 627, 537		6510139-AA	22354	510,
612019	9298	154	6500526	12715	156	6503709	19213	455, 479		545, 626	
614	12629	227	6500650	15860	834	6503741	11691	550	6510734-AA	22363	50
616	12628	227	6500651	15861	834	6503768	18301	423, 478	6510766-AA	22177	502,
61991-35010	21234	782	6500653	15861	834	6503800	13748	297		545, 628	
61992-35010	21235	782	6500722	15862	834	6503812	19779	632	65487-60010	22497	60
62217-13010	20558	459,	6500724	12569	595, 617	6503819	19417	94,	6555.LE	21875	494,
		482, 711, 797	6500787	14016	490,		104, 130, 137, 579, 629			544, 762, 769	
62217-33031	22158	782			534, 572, 625	6503837	18531	140, 153	65613-07010	21337	807
62228-51S00	19147	756	6500859	13754	297	6503860	17101	298	65624-V0100	14337	755
622A2-9E000	21361	578,	6500898	13755	297	6503892	18827	434, 479	65722-01E00	22358	693, 756
		528, 543, 754	6500899	13748	297	6503896	17669	467, 478	65722-01E00	22358	693, 756
622A2-9E000A	21361	578,	6500911	13750	298	6503938	18913	297	65722-50A00	22362	755
		528, 543, 754	6501025	12125	141	6503943	20189	427, 481	65722-EA000	21309	755
62318-01W00	16860	739	6501067	15481	428, 477	6504014	18915	467, 479	65810-K2000	21229	439,
62318-H8500	21121	739	6501086	20316	430, 481	6504018	19141	280		484, 691, 747	
62319-0W000	20266	743	6501178	14980	141	6504043	17612	426, 478	65810-K2002	22060	439,
62319-AU000	22287	691, 746	65011868	13747	297	6504072	19793	618		488, 691, 747	
62380-U7400	17196	745	6501227	12993	418,	6504090	12567	571,	65832-F5000	17237	435,
62489-0E010	22460	61			475, 766		505, 625, 534			477, 749	
62489-0E010	22460	61	6501301	16818	423, 477	6504098	19338	433, 480	65846-30F00	17237	435,
62581-14020	16778	470,	6501415	16980	141	6504135	19541	428, 480	65846-40F00	19468	432,
		477, 721, 795	6501509	18242	297	6504424	18375	280		480, 691	
6263345	11138	554	6501544	14021	416, 476	6504452	17669	467, 478	65846-4Z000	17237	435,
62660-48600-1	20381	444,	6501544	17106	495,	6504521	19422	513,		477, 749	
		482, 669, 737, 748	6501559	13751	298			539, 627	65846-4Z000	19468	432,
62698-V7000	14313	666,	6501577	17106	495,	6504555	17222	572,		477, 749	
		717, 742			536, 572		500, 607, 537		65846-4Z000	21288	432,
6270163	10832	425, 475	6501590	14019	529,	6504601	19779	632	661179000	22044	771
6271903	20801	397			535, 609, 628	6504700	13750	298	66421-634-000	14291	442,
6271904	20803	397	6501630	17104	533,	6505149-AA	18531	140, 153	66435-648-000	14291	442,
6271905	20802	397			536, 624	6505161-AA	19640	617		476, 668	
6271906	20804	397	6501699	17354	618	6505292-AA	19386	466, 480	66814-01G00	16725	532,
6271989	14559	591	6501772	17104	533,	6505411-AA	10831	425, 475		536, 755	
6272766	12918	198			536, 624	6505417-AA	19836	418, 481	66820-3S500	20672	452,
62731FA000	21629	771	6501773	12569	595, 617	6505425	10831	425, 475		482, 749	
62731FA010	21587	771	6501825	12259	141	6505534-AA	20829	454, 482	66820-3S500-C1	20672	452,
6276604	3617	413	6501878	17104	533,	6505539-AA	19628	467, 480		482, 749	
6280765	3617	413			536, 624	6505667-AA	20360	427, 482	66820-3S510	20614	741
62869-N4700	14723	447,	6501916	15543	426, 477	6505686-AA	20362	430, 482	66820-4BA5A	22476	58
		476, 748	6501925	18030	537,	6505703-AA	20267	617	66820-61U00	21689	691, 747
6288704	8777	217			506, 573, 626, 537	6505759-AA	20427	469, 482	66820-88E00	17633	746
6292995	12629	227	6501948	19893	422, 481	6505813-AA	18934	94, 103	66820-9N00A	22128	746
6292995	15372	226	6502078	11146	425, 475	6505878-AA	17124	455, 477	66820-AX020	21159	751
6294493	13548	243	6502081	16871	833	6505918-AA	20515	466, 482	66824-01G00	16783	493,
6294737	15935	217	6502083	16872	833	6506007-AA	13751	298		536, 755	
62955-12010	15695	558, 779	6502085	16873	833	6506008-AA	19639	573,	66860-01W01	16859	497,
62955-20020	15695	558, 779	6502087	16874	833		505, 626, 539			536, 569, 751	
62955-50010	22456	59	6502089	16875	833	6506104-AA	20173	632		B67	262
6298886	9883	236, 244	6502089	16876	833	6506132-AA	20458	521,	67	16905	258
6298886	11166	236, 244	6502090	16877	833			540, 627	673-988-00-25	20315	728
6298886	13558	236	6502091	16878	833	6506161-AA	19278	92,			
6298892	9883	236, 244	6502104	18771	430, 479			98, 129, 132			
6298892	13558	236	6502152	16846	145, 178	6506214-AA	19141	280			
6298935	9883	236, 244	6502328	14921	416, 476	6506306-AA	20623	630			
6299087	11157	237, 253	6502381	18815	419, 479	6506654-AA	20274	455, 481			
63	20283	259	6502407	16826	105,	6506655-AA	20275	618			
631	18468	258			108, 121, 124	6506852-AA	20468	618			
63-17-1-637-868	20647	728	6502450	16876	833	6506852-AB	20468	618			
63-21-7-160-777	BH1	264	6502491	16870	833	6507055-AA	20765	468, 482			
63-21-7-160-779	BH3	265	6502545	18237	629	6507669-AA	20766	521,			
63-21-7-160-780	BH7	265	6502573	18032	493,			541, 627			
63-21-7-160-806	BD2S	264			537, 623	6507670-AA	19111	312			
			6502625	16835	524,	6507686-AA	20765	468, 482			
					536, 570, 624						

O.E.M. INTERCHANGE BY NUMERICAL ORDER

OEM No.	Auveco No.	Page No.	OEM No.	Auveco No.	Page No.	OEM No.	Auveco No.	Page No.	OEM No.	Auveco No.	Page No.
67771-01010	14144	465, 476, 799	68028049-AA	20377	561	6C3Z-17A386-AA	3682	112	75316-S9A-004	21557	642, 659
		464, 477, 799	68033045-AA	22209	448, 489	6E0-837-732	21992	816	75316-TP6-A01	22464	51
67771-02030	15709	464, 477, 799	68033794AA	21442	629	6E5Z-13466-AC	B4157K	262	75329-SH4-013	21109	660
		464, 477, 799	68033794-AA	21442	629	6E5Z-7850980-AAA	21024	507, 542, 608, 722	75392-04010	21016	782
67771-02030	15709	464, 477, 799	68034329-AA	21442	629	6G1Z-5410182-A	20977	602	75392-0R010	21016	782
		465, 481, 799	68039280-AA	21528	622	6G1Z-5410182-C	20979	600	75392-35200	21016	782
67771-02030	19898	465, 481, 799	68061648-AA	21329	464, 484	6K0-868-243-C	21398	473, 484, 816	75392-35220	21857	705, 782
		465, 477, 799	68084593-AA	21213	619				75392-42030	21841	93, 101, 129, 134
67771-03030	15707	465, 477, 799	68092697-AA	20870	622	6L0-121-136A	21990	497, 545, 818	75392-60030	20877	704
		467, 479, 800	68093998-AA	22432	49, 50, 67	6L6-853-575A	21991	449, 488, 815	75392-60031	20877	704
67771-04040	19210	467, 479, 800	68172491-AA	21374	562, 622	6N0-809-966A	21816	812	75393-60030	21314	704
		463, 479, 797	68211-07010	19380	781	6N0-823-397-AC	21514	819	75394-60060	20875	704
67771-06010	18844	463, 479, 797	68211-95D00	19722	783	6N0-867-276	22216	813	75395-0T010	21453	779
		460, 479, 797	68213168-AA	21791	621	6N0-868-243A	21997	473, 488, 817	75395-14020	14264	781
67771-06030	19109	460, 479, 797	6822.LL	21822	464, 486, 762, 798	6Q0-807-643	22399	64	75395-14020A	14264	781
		464, 479, 799	68225214-AA	21835	621	6Q0-853-147	22447	63	75395-33030	19900	704
67771-12010	14269	464, 476, 694, 721, 799	68257098-AA	21374	562, 622	6Q0-868-243	21251	526, 542, 819	75395-35070	20688	780
		464, 476, 694, 721, 799	68365015-AA	17222	572, 500, 607, 537	6Q0-868-246-A	21760	809	75395-42020	22525	59
67771-12010F	14269	464, 476, 694, 721, 799	68425-H5000	14313	666, 717, 742	6Q0-868-297	21783	450, 486, 815	75396-30260	21699	703
		464, 477, 799	6902.07	21967	490, 544, 762	6W1Z-5422008-A	18890	615	75396-35020	20687	780
67771-12040	19016	466, 479, 800	69293-12030	20469	714, 805	6Y0-823-717	21984	415, 488, 814	75397-33010	20661	703
		466, 479, 799	69293-12040	20470	714, 805	701-867-299	21479	513, 543, 818	75397-35010	20688	780
67771-12050	18898	176, 19257, 466, 479, 711, 798	69293-12050	20534	714, 806	703-867-299	21450	451, 485, 815	75397-42010	22215	781
		466, 479, 799	69293-12060	20535	714, 806	71144-SR3-A00	18415	668	75397-48010	19899	703
67771-12070	20473	452, 482, 710, 796	69293-30030	21336	714, 805	7136.A5	21962	758	75397-48030	20605	703
		463, 482, 711, 798	69293-33010	20469	714, 805	7136.J7	21931	758, 764	75492-60030	20876	704
67771-12080	20575	463, 482, 711, 798	69293-33020	20470	714, 805	71591-S5A-000	21636	661	75494-42010	22525	59
		465, 477, 799	693005370	21584	458, 485, 774	71592-S5D-000	20603	658	75495-35010	20687	780
67771-14040	15707	465, 477, 799	6966.39	21976	331	71598-S30-013	20677	658	75498-42010	19843	781
		466, 479, 799	6972.11	21881	491, 544, 762	71728806	22432	49, 50, 67	75521-611-000	14274	666, 717, 742, 785
67771-16080	19108	466, 479, 799	6972.24	21968	490, 544, 762, 768	72115-60A00	17356	583	75522-611-000	14255	665, 717, 735
		466, 479, 799	6973.A9	21813	763	72311-S10-003	19673	417, 480, 673	75545-14081	14747	784
67771-16120	18874	466, 479, 799	6973.34	21971	503, 544, 763	72311-S5S-003	21704	440, 486, 645, 674	75545-16020	14751	784
		466, 479, 799	6983.17	21809	428, 486, 760	72431-S2X-003	21639	642, 660	75545-24030	19776	705
67771-16160	18874	466, 479, 799	6983.24	21942	442, 487, 759	72727-W1000	15470	742	75545-28010	14749	784
		466, 479, 799	6984.03	21948	66	72826-01P00	15468	741	75545-32020	16833	783
67771-16170	18875	452, 479, 796	6987.A1	21929	758, 764	73	20284	259	75545-33011	21255	705
		465, 476, 799	6990.C4	21970	495, 544, 762	73154-TA0-A01	22273	664	75545-53011	21255	705
67771-22010	14270	465, 476, 799	6990.5	21884	467, 487, 762	73156-TOA-003	22165	665	75545-53011	21505	705
		466, 479, 797	6990.62	21959	758, 764	7368261	16801	221	75545-88080	14749	784
67771-22020	14728	464, 476, 797	6990.F0	21882	494, 544, 762, 769	73856-51E00	17348	741	75545-880B0	14749	784
		461, 479, 797	6991.G1	21957	66	73858-8J000	20873	740	75545-89101	16942	784
67771-26240	22486	61, 460, 479, 797	6991.S6	21814	461, 486, 761, 768	73858-ZB00A	20873	740	75546-12030	16821	784
		460, 479, 797	6991.X7	21883	520, 544, 763	73862-672-003	14299	436, 476, 673	75546-12060	19204	783
67771-30070	19109	460, 479, 797	6991.Z1	21895	462, 487, 761, 768	73862-672-0030	14299	436, 476, 673	75546-14080	16821	784
		460, 479, 797	6991.39	21965	758	74	18016	258	75546-22050	14745	784
67771-30090	19129	468, 479, 800	6991.43	21975	449, 487, 761, 768	7410.E2	21964	758	75546-22060	17334	783
		463, 479, 800	6992.07	21936	416, 487, 760	7427.46	21874	758, 764	75547-22010	17298	784
67771-32090	18844	463, 479, 797	6992.18	21972	492, 544, 762	7437.1	21947	422, 487, 760	75547-51021	21082	307
		463, 479, 797	6992.31	21808	416, 486, 759	7440	B7440	262	75548-22150	19484	784
67771-32120	21686	459, 486, 711, 796	6992.C6	21877	419, 487, 760	7440	19206	259	75548-60021	22427	59
		465, 479, 797	6992.G2	21955	66	7440A	B7440A	262	75791-0W010	15707	465, 477, 799
67771-58010	21369	778, 461, 479, 797	6992.J4	21978	462, 487, 761	7443	B7443	262	75819-33010	21748	704, 779
		461, 479, 797	6992.S2	21979	759	7443	19207	259	75867-02010	21226	452, 484, 795
67771-89104	19203	461, 479, 797	6992.W9	21937	421, 487, 760	7443A	B7443A	262	75867-06030	21596	521, 543, 713, 804
		461, 479, 797	6992.82	21974	462, 487, 761	74798-S9000	14695	667, 717, 736, 743, 787	75867-21010	20576	449, 482, 795
67773-0E020	21795	454, 486, 711, 796	6992.95	21940	420, 487, 760	74806-SB6-003	16825	665	75867-30110	19842	423, 481, 793
		439, 482, 795	6995.A3	21871	449, 487, 761, 767	74842-659-003	16779	448, 477, 671, 793	75867-30120	21123	511, 542, 802
67867-0C010	20443	439, 482, 795	6995.V6	21879	446, 487, 759	75039-33010	19482	705	75867-30130	22056	452, 488, 710, 795
		440, 486, 645, 674, 794	6995-12180	18113	404, 742	75039-33040	19492	703	75867-33030	21538	452, 485, 796
67867-0D060	21707	440, 486, 645, 674, 794	6997.T2	21960	544, 763	75039-33060	19120	705	75867-33050	21596	521, 543, 713, 804
		439, 481, 794	6997.T6	21960	758, 764	75049-33010	17989	703	75867-AA010	21012	452, 483, 710, 796
67867-12150	19749	439, 481, 794	6997.R1	21868	427, 487, 760, 766	75049-33020	17989	703	75867-AA010	21538	452, 485, 796
		439, 481, 794	6999.T4	21880	446, 487, 759	75-22-709	20454	275	75867-AC020	21653	780
67867-28030	18692	439, 478, 720, 794				75305-S0A-003	20783	660	7588.VX	21938	420, 487, 760
		438, 486, 709				75305-SH2-003	20784	660	7589.V4	21939	421, 487, 760
67867-50020	21694	438, 486, 709				75305-SH4-003	20785	660	76222-SP1-003	21772	642, 660
		440, 486, 645, 674, 794				75305-SHJ-003	21186	659	7634583	9275	401
67867-52010	21707	440, 486, 645, 674, 794				75305-SM4-A01	21556	660	7637192	4441	395
		439, 481, 794				75306-SDA-A01	20782	662	7642589	13467	435, 475
67867-89103	18692	439, 478, 720, 794				75306-SV1-A01	20602	660	76647-42010	21616	143, 807
		439, 481, 794				75306-SZA-A01	21470	659	76817-12060	21612	781
67868-02020	19749	439, 481, 794				75307-SN7-000	20570	140, 681, 734	76817-68010	22454	60
		439, 481, 794							76847-1JB0A	22055	740
67868-30030	21627	415, 485, 709, 794							76847-JG00A	22281	741
		439, 481, 794							76848-35		

O.E.M. INTERCHANGE BY NUMERICAL ORDER

OEM No.	Auveco No.	Page No.	OEM No.	Auveco No.	Page No.	OEM No.	Auveco No.	Page No.	OEM No.	Auveco No.	Page No.
76848-54C00	22059	745	77-03-077-420	21897	765	811-807-577-C	21399	811	86155-2H100	21328	498
76848-71S00	21622	745	77-03-077-435	21805	429, 486, 767	812893	12600	238, 253		543, 688	
76848-8J010	20786	745				8133-50-022	14380	448, 476, 720	86157-37000	21233	491, 542, 688
76848-ED000	22255	691, 746	77-03-077-444	21899	65	81496-0E020	22488	59	86179-2V000	22318	686
76848-JG00A	22257	745	77-03-077-449	21908	447, 487, 765	81496-21010	21684	779	86179-2V020	22319	686, 698
76853-10010	21586	782				81496-50010	22127	703	86359-33500	21457	696
76876-W5000	14352	443, 476, 747	77-03-077-453	21900	427, 487, 767	81496-52020	22488	59	86360-3L000	22010	682
						81496-60010	22398	59	86434-4A000	21382	436, 484, 685, 697
76879-44010	21611	806	77-03-077-464	21911	420, 487, 766	82-00-110-307	21909	447, 487, 765	86438-1R000	22320	436, 489, 686
76879-48010	22332	307				82-00-151-367	21902	66			
76881-JG00A	22239	744	77-03-077-468	21814	461, 486, 761, 768	82-00-321-368	21907	429, 487, 767	86438-2B000	18692	439, 478, 720, 794
76882-0E700	21617	741				82-00-700-969	21916	462, 487, 761, 768	86438-2T000	22321	436, 489, 685, 697
76882-0M000	21017	142, 693, 756	77-03-077-487	21910	419, 487, 766	82-00-721-200	21905	427, 487, 766	86438-4A100	21381	437, 484, 685, 697
76882-0M060	21619	739	77-03-081-056	21915	765	82-00-909-084	21895	462, 487, 761, 768	86518-3M000	22322	684, 696
76882-57A00	18265	503, 537, 752	77-03-081-134	21959	758, 764	82-00-939-873	21903	65	86590-28000	17632	508, 537, 605, 688, 722
			77-03-081-160	21930	742, 764	8211.VV	21811	517, 544, 763	86590-28000-HZ	17632	508, 537, 605, 688, 722
76882-6P000	20886	689	77-03-081-163	21931	758, 764				86590-35000	22299	523, 545, 699
76882-6P010	22076	689, 740	77-03-081-184	21874	758, 764	821240	18952	212			
76882-EG01A	21285	740	77-03-081-185	21960	758, 764	82132-27100	22337	446, 489, 686	86591-25000	21363	696
76882-EW00B	21683	740	77-03-081-225	21932	764	82315-22000	22004	464, 488, 687	86593-24000	21067	688
76882-JG10A	22061	689, 740	77-03-081-232	21961	759, 764	82315-27000	21188	459, 483, 687, 698	86595-21500	22253	509, 545, 688, 699
76882-1KA1A	22523	58	77-03-081-233	21958	758, 764				86625-1M000	22323	684, 696
76884-90100	12583	741	77-03-088-105	22002	65	82315-2P000	21070	460, 483, 687, 698	86625-3S000	22011	685
76906-T3000	14353	447, 476, 748	7724826	20744	777	82315-2P000	22003	462, 488, 686, 698	86699-2D000	21371	697
			7730788	9749	401	82315-2P000	22003	462, 488, 686, 698	86699-2M000	21371	697
76923-47010	22072	531, 545, 714, 805	7731589	9850	412, 555	82315-2W000	22313	459, 489, 687, 699	867-809-966	21510	811
			7731589	10632	412	82315-3020	22005	462, 488, 687, 699	867-863-849-A01C	21892	817
76923-52021	22502	62	77553-65D00	20743	777	82315-36000	22006	467, 488, 686	86825-26000	22505	53
76924-02010	20578	556, 781	77553-65D10	22079	777	82315-38000	21070	460, 483, 687, 698	86825-28000	21378	144, 688, 700
76924-12030	22166	445, 790	78856-R4301	14690	666, 745				86848-22000	21068	684
76924-13020	22457	61	796255	11349	471, 475	823-867-299	20252	470, 481, 816	86848-25000	21068	684
76924-47010	21217	783	79796-71E00	17349	741	82711-12200	21553	273, 806	86910-21010	21232	685
76924-47020	22073	448, 488, 708, 790	7L0-839-069	21512	809	83219-22000	22135	684	86910-22000	19505	787
			7L3Z-9S317-A	21126	611	8335.TE	21916	462, 487, 761, 768	8717859	10243	401
76924-52021	20578	556, 781	7L3Z-9S317-B	21127	611	83501000	12599	253	8731909	3620	442, 475
7693140	9639	401	7L5-853-994	21495	451, 485, 767, 815	83504041	19318	277	8733059	11120	416, 475
76988-3DN0A	22032	741	7L6-868-243	21708	473, 486, 817	83542-65D00	22078	777	8734067	10242	401
76988-3J000	19736	746	7M0-867-299-K	21853	454, 486, 701, 815	8411	15018	158	8736585	9749	401
76988-4N000	21291	740	7M3867299	21853	454, 486, 701, 815	84145-26000	22352	688	8736586	9639	401
7698976	9633	401				84219-3L000	22435	53	87378-3N000	22012	469, 488, 688
76996-01P02	16776	422, 477, 670, 749	80-00-609-205	21904	65	84653-N7400	14337	755			
			800843	12935	197	84747-2L000	22007	331	8749.Q5	21943	442, 487, 759
76997-P7100	14723	447, 476, 748	801471	12922	198	84915-0W000	19731	461, 480, 750	8749.ZA	21961	759, 764
			801-853-577	12635	808				8763591	9633	401
77 03 077 111	21871	449, 487, 761, 767	801-867-299-01C	21758	447, 486, 814	84937-6P000	22368	58	87701-3B000	22324	684
			80287-37F00	22286	445, 489, 691, 748	84937-6P100	22368	58	87702-H1000	21244	683
77 03 077 117	21869	65	8-03536-966-0	18665	275	84953-AP100	21640	465, 485, 692	87703-H1000	22013	683
77 03 077 174	21868	427, 487, 760, 766	803716-S	14018	512, 534, 608	84953-JA00A	21289	464, 484, 750	87714-FD200	21356	684
						84995-3J101	21631	515, 544, 753	87715-3K000	22438	53
77 03 077 421	21866	65	803-853-139A	13189	808				87716-2W000	22470	54
77 03 077 422	21867	65	803-853-139C	13174	808	85099-0B720	19293	744	87719-02500	22014	696
77 03 077 457	21870	447, 487, 765	803916010	21326	281	85099-1MA0A	22522	57	87719-3D000	21038	682
			807016160	21326	281	85099-1VA0A	22123	744	87756-1C000	21356	684
77-01-030-058	21923	769	80850-89900	21633	441, 485, 692, 751	85222-0M000	20790	746	87756-1F000	22015	683, 696
77-01-030-059	21921	769	80850-CA003	21588	446, 485, 747	85222-0M00A	20790	746	87756-26900	22016	685
77-01-030-059	21922	769	80850-JM01A	22107	436, 488, 751	85284-4J500	21701	459, 486, 692, 750	87756-2E000	21136	683
77-01-030-060	21926	770	80871-SN7-003	18141	388	85284-7S610	21160	689	87756-2G000	21312	682
77-01-030-060	21927	770	80871-ST7-000	18141	388	85284-AD000	21147	689	87756-2J000	22508	54
77-01-049-008	21977	450, 487, 761, 767	80872-ST7-000	18140	388	85284-AL510	22452	58	87756-2W000	22325	439, 489, 686, 697
			80873-ST7-000	18137	388	85284-EG000	22218	746	87756-3N100	22500	54
77-01-397-183	21928	65, 66	80874-AX000	21646	693, 756	85495-2E050	22008	458, 488, 687, 698	87756-34520	22017	685, 697
77-03-072-224	21968	490, 544, 762, 768	80875-85E00	18166	441, 478, 751	85506-4A000	22009	464, 488, 686, 698	87756-37000	22018	683
			80915-29A66	14369	515, 535, 723	856543	22432	49, 50, 67	87756-38000	20567	682, 697
77-03-072-236	21875	494, 544, 762, 769	80999-05N07	16784	508, 536, 752, 802				87756-3D000	20566	684
			80999-VE000	20668	463, 482, 692, 750	85746-06000LX	21349	420, 484, 697	87756-3E500	21484	696
77-03-072-261	21882	494, 544, 762, 769	80999-VE000	21414	463, 484, 692, 750	85746-06000RU	21350	420, 484, 697	87756-C5000	22326	696
			81124-89101	16951	778				87756-D3000	22327	53
77-03-072-352	21898	505, 544, 769	81126-37010	20543	448, 482, 686, 698				87758-2S000	22328	53
			81137-22530	21628	785	85815-24100	22314	683	87758-35000	21064	682
77-03-072-360	21807	509, 544, 769	8-11519-408-0	21047	278	85849-3B000	21360	463, 484, 687	87758-35010	21863	682, 695, 735
			8-11562-588-0	21047	278				87758-37000	21066	685, 697
77-03-072-361	21935	493, 487, 769	81174-11011	22507	54	85849-3L000	22315	466, 489, 687, 699	87758-38000	22329	682, 696
			81174-21000	22507	54				87758-39000	22019	683
77-03-072-416	21812	519, 544, 763, 769	81174-21010	22507	54	85858-3S000	22316	682, 695	87758-3D000	20568	683
			81174-2L000	22506	54	85859-3S100	22317	682, 695	87758-3E000	22014	696
77-03-074-315	21914	429, 487, 767	811-807-557-C	21510	811	86155-22000	17162	499, 536, 571, 801	87758-3L000		

O.E.M. INTERCHANGE BY NUMERICAL ORDER

OEM No.	Auveco No.	Page No.	OEM No.	Auveco No.	Page No.	OEM No.	Auveco No.	Page No.	OEM No.	Auveco No.	Page No.
87759-3E000	22014	696	88861073	13548	243	88981030	15674	587, 630	894-298-119-0	14696	498,
87759-3S000	22297	685	88861075	20561	251	88981031	15673	587, 630	535, 678, 694, 752		
87759-3V000	22331	54	88861078	20843	249	88986451	18868	239	8-94298-119-0	14696	498,
87770-27000	22020	683	88861084	20845	251	88987187	21220	240, 255	535, 678, 694, 752		
8799350	10617	555	88861089	20853	247	88987962	17109	240	8-94328-493-2	14727	567,
880	B880	263	88861091	20851	252	88988301	18527	241	532, 535, 694, 755		
881	B881	263	88861094	20842	250	88988447	19582	248	8-94467-458-4	17355	402, 694
881	20595	260	88861095	20848	245	88988609	21212	240	8955-022-134	15042	530,
88-10-0-141-180	B53	262	88861096	20852	249	89	B89	262			
88199-1HA0A	14289	418,	88861101	5226	256	89	16911	258	8956001	15666	634, 808
		476, 669	88862211	16514	240	890	B890	263	896	B896	263
884	B884	263	88862213	18217	248	8900524	11948	217	8964.57	21878	419,
885	B885	263	88862214	14580	241	8901283	11166	236, 244			487, 760
885	20596	260	88862215	17112	239	89023920	21168	638	8-97134-978-0	17355	402, 694
886	B886	263	88862216	17109	240	89024363	20945	638	8-97214-872-0	18661	260
886	20683	260	88862217	16694	239	8902487	11446	237	8-97286-997-0	16897	260
88796-6P000	22311	744	88862218	17107	241	89025539	20485	588	89785-08020	21101	639
8880417	15672	505,	88862219	18918	242	89025543	21092	588	89785-60160	21101	639
		536, 624	88862220	16693	240	89025546	21072	589	899	B899	263
8880476	15672	505,	88862223	16967	239	89026634	21385	433, 484	8D0-805-121	21889	819
		536, 624	88862225	18916	239	89026635	21386	433, 484	8D0-805-121B	21888	819
88860426	9883	236, 244	88862226	17110	240	8903202	11154	237	8D0-807-192	21933	63, 65
88860429	8756	237	88862227	18917	240	8903202	11475	237	8E0-805-121A	21886	819
88860432	12237	236,	88862228	17111	240	8903203	11476	237	8E0-864-229-9B9	22444	64
		244, 253	88862229	17114	239	8903283	11446	237	8E0-868-243	21144	473,
88860434	9905	236, 253	88862230	17113	240	8903488	12629	227			483, 816
88860442	14135	244	88862231	16965	241	8903488	15372	226	8K0-805-121	21887	819
88860444	14130	245	88862232	16964	241	8903489	12628	227	8K0-805-922A	22260	820
88860447	13559	256	88862235	17683	250	8904437	11156	237	8K0-821-213A	22308	813
88860452	18671	250	88862238	18527	241	89057707	18218	252	8K0-868-307	22420	64
88860453	17661	248	88862241	13644	252	89057711	17620	248	8L3837199B	22397	64
88860457	18214	247	88862247	17690	242	89057714	13548	243	8P0-868-243	21996	454,
88860458	20837	245	88862255	18674	241	89057717	20838	252			488, 816
88860459	17619	249	88862256	19891	240	89057718	19887	248	8R0-853-909	22414	63
88860462	17617	249	88862260	18870	239	89057721	11440	242, 254	8T0-853-909-A	22426	63
88860463	18668	252	88862262	17199	241	89057722	11442	243	8U0-853-909	22417	64
88860465	17662	250	88862264	21490	240,	89057722	11442	243	8V0-868-243	22442	63
88860466	17618	249			245, 254	8905794	20471	581, 271	8Z0-867-646	21995	454,
88860474	19582	248	88862266	19556	242	8909518	11156	237			488, 816
88860476	20839	248	88862267	19882	241	8909908	11446	237	90	18015	258
88860480	17621	250	88862271	18925	240	891	B891	263	90001-SG0-003	14291	442,
88860481	17622	250	88862273	19554	242	891	20598	260			476, 668
88860482	20389	253	88862274	19555	243	8911472	14546	581, 271	90009-PH1-000	21353	278
88860484	20610	466,	88862296	19813	251	8911473	14544	581, 271	90009-PY3-000	20426	279
		482, 673	88862301	20846	251	8911497	14545	581, 271	90009-R70-A00	22205	280
88860485	18530	243	88862302	17463	242	8912698	11157	237, 253	9003	18661	260
88860486	17624	246	88862303	16968	242,	8912750	13540	236	9004	B9004	264
88860487	17623	247			250, 254, 255, 256	8913369	14885	222	9004	16896	260
88860488	17598	249	88863493	21033	242	8914822	11154	237	9005	B9005	264
88860489	17684	247	88891731	19424	592	8914822	11475	237	9005	B9005	264
88860492	18525	242	88891787	21047	278	8914823	11476	237	9006	16897	260
88860494	18464	246	88891791	18889	313	8915135	12629	227	9006	B9006	264
88860495	18463	246	889	B889	263	8915136	12628	227	9006	16898	260
88860496	20277	249	88909758	12548	235	8917283	17002	216	9007	B9007	264
88860497	18819	248	88909760	12536	235	8917320	14547	581, 271	9007	18662	260
88860498	14130	245	88909760	12550	235	8917444	11083	229	90075-10004	21628	785
88860499	18215	250	88909761	12551	235	8918527	9883	236, 244	90075-10801	19783	598,
88860500	18676	247	88909762	12552	235	8918527	11166	236, 244			706, 786
88860501	20841	247	88909763	12553	235	8919916	13543	238	90075-10805	19783	598,
88860502	18216	250	88909764	12554	235	893	B893	263			706, 786
88860505	11440	242, 254	88909765	12555	235	893	20599	260	9008	BH13	265
88860507	19076	251	88909766	12556	235	8933059	10318	556	90080-46010	21296	443,
88860509	20172	247	88909769	12547	235	8933059	11288	554			484, 791
88860510	20547	246	88909770	15505	235	8934-201-235	13464	765	90080-46269	19797	780
88860511	20548	246	88909771	15506	235	8934-201-262	11855	550, 764	90080-46294	21325	503,
88860512	18673	246	88909772	15507	235	8934-201-263	9377	616, 764			542, 802
88860514	20246	246	88909773	15508	235	8934201287	16826	105,	90080-46327	22221	445,
88860515	20550	246	88909774	15509	235			108, 121, 124			489, 792
88860518	17598	249	88909774	15509	235	8934-201-493	16256	168	90080-81041	16897	260
88860522	19889	250	8891030	15673	587, 630	8934-201-602	12713	552,	90080-82014	12540	235
88860524	19885	251	8891031	15673	587, 630			618, 765	90080-82050	21603	235
88860526	19126	246	88938226	14921	416, 476	8934-201-621	14007	505,	90080-82051	21436	235
88860527	19125	245	88953358	21033	242			534, 571, 625	90080-82052	21437	235
88860537	20844	247	88953358	21542	242	8934-201-631	13750	298	90080-82053	21166	235
88860538	19157	251	88961517	12669	145, 178	8934-201-681	13475	471,	90080-82055	21438	235
88860546	19881	247	88969790	20576	449,			476, 768, 815	90084-26001	17420	302
88860549	11436	243			482, 795	8934-201-767	13966	170, 765	90084-26002	20383	308
88860551	19880	251	88970345	20559	459,	8934-201-835	17496	297	90084-26008	17411	302
88860552	20549	249			482, 711, 797	8934-202-293	16251	168	90084-46020	21071	781
88860558	19890	245	88970493	17481	780	8934-202-599	17102	455, 477	90084-98033	20601	260
88860559	19623	248	88970494	20577	568,	8936000-148	15666	634, 808	90099-14044	18136	388
88860561	19883	248			515, 541, 712, 803	8936001	15666	634, 808	90099-14045	18143	388
88860578	18920	253	88970495	20578	556, 781	894	B894	263	90103-SDA-A00	22203	93,
88860584	11444	242	88970656	20575	463,	8-94134-027-0	14739	694, 785			101, 129, 134
88860585	11445	252			482, 711, 798	8-94145-515-0	17076	427,	90105-06037	21840	121, 123
88860586	13541	253	88970747								

O.E.M. INTERCHANGE BY NUMERICAL ORDER

OEM No.	Auveco No.	Page No.	OEM No.	Auveco No.	Page No.	OEM No.	Auveco No.	Page No.	OEM No.	Auveco No.	Page No.
90467-11111	19647	780	90653-HC4-900	17222	572,	90671-SDA-A01	20740	311	909130007	21567	451,
90467-11117	22051	707, 785		500, 607, 537		90672-671-003	18157	444,		485, 773	
90467-12071	21698	705	90654-SA4-003	19730	680			478, 668	909130008	21771	770
90467-12072	21848	704	90655-SA0-003	14288	665	90672-671-8110M1	14268	667, 787	909130013	21658	498,
90467-12073	21641	781	90655-SA0-0030	14288	665	90672-SA0-003	14298	272,		544, 738, 774	
90467-12074	21697	704	90656-671-6310M1	14287	665			680, 725	909130034	21574	460,
90467-12075	21642	782	90657-SA5-003	22199	498,	90672-SA0-0030	14298	272,		485, 773	
90467-12078	16779	448,		545, 647, 675				680, 725	909130051	21594	517,
		477, 671, 793	90657-SA6-003	14697	568,	90672-SA6-003	14700	664		21563	543, 775
90467-12078-01	16779	448,		496, 535, 678, 722		90672-SA6-0030	14700	664	909130059	21563	521,
		477, 671, 793	90657-SA6-0030	14697	568,	90672-SC6-003	14700	664			543, 776
90467-12080	21549	703, 778		496, 535, 678, 722		90673-SC6-003	14703	664	909130067	21530	507,
90467-12096	14277	786	90657-SB0-003	19186	492,	90673-SC6-0030	14703	664		543, 688, 699, 775	
90467-13005	17194	778		538, 647, 675		90674-SB0-000	14268	667, 787	909130074	21421	432,
90467-13008	17194	778	90658-SB0-003	14701	663	90675-692-003	14306	659			484, 772
90467-13011	17195	597,	90658-SB0-0030	14701	663	90675-692-0031	14306	659	909130088	22207	451,
		620, 658, 694, 735	90661-SC7-003	14695	667,	90675-SA5-003	22105	145,			488, 773
90467-13075	21623	735, 778		717, 736, 743, 787				178, 681	909130096	22343	459,
90467-17004	17438	779	90661-SC7-0030	14695	667,	90675-SA6-003	14294	665			489, 773
90467-A0002-C0	22473	61		717, 736, 743, 787		90675-SA6-0030	14294	665	909130105	22206	467,
90467-A0003	19729	445,	90661-ST7-003	18456	644	90675-SB0-003	16000	516,			488, 773
		480, 709, 793	90662-671-003	14313	666,			536, 679, 723, 753	909130109	21591	451,
90467-A0004	22350	705, 781		717, 742		90675-SB3-003	16000	516,			485, 773
90467-A0005	21102	463,	90662-671-0030	14313	666,			536, 679, 723, 753	909130118	22290	773
		483, 711, 798		717, 742		90676-SA7-003	17058	665	909130146	20558	459,
90467-A0006	18876	465,	90662-693-003	14281	667, 787	90676-SR4-003	18115	668			482, 711, 797
		479, 798	90662-693-0031	14281	667, 787	90677-671-003	14687	680	909130213	21502	465,
90467-A0007	22471	61	90662-SB2-003	14313	666,	90677-693-003	14687	680			485, 773
90467-A0008	20878	426,		717, 742		90677-SE0-003	16950	680	90913-0213	21502	465,
		483, 708, 790	90664-671-003	14328	436,	90679-692-003	14308	659			485, 773
90467-A0009	18297	443,		476, 673		90679-692-0030	14308	659	909140002	21576	527,
		478, 708, 791	90664-SB0-004	15472	664	90682-SB0-003	17058	665			543, 776
90467-A0016-C0	17162	499,	90664-SB3-003	20303	667	90682-SDA-A01	21205	667	909140007	21420	524,
		536, 571, 801	90665-SA0-9700	12576	658	90682-SEA-003	20954	644, 667			543, 776
90467-A0018	21615	144,	90665-SM4-000	19646	667	90682-SEA-003	20954	644, 667	909140012	21570	501,
		714, 807	90666-SA0-003	14289	418,	90683-693-000	14690	666, 745			543, 774
90467-A0032	22455	61		476, 669		90683-693-0000	14690	666, 745	909140051	21422	516,
90468-04030	16671	806	90666-SA0-0030	14289	418,	90683-SA5-003	19311	499,			543, 775
90468-04038	16306	806		476, 669				539, 678	909140052	21592	518,
90471-PX4-000	16955	275	90666-SA0-003A3	14289	418,	90683-SA6-003	14685	663			543, 775
90501-SDR-003	22419	53		476, 669		90683-SA6-0030	14685	663	909140054	19233	519,
90505-SL0-003	19140	568,	90666-SA0-003A9	14289	418,	90683-SC6-003	14685	663			538, 648, 676
		522, 624, 538, 649, 739, 804		476, 669		90683-SC6-0030	14685	663	909140055	21501	527,
90505-SM4-003	17057	512,	90666-SA0-003ZD	14289	418,	90684-SA5-003	14696	498,			543, 776
		536, 678		476, 669				535, 678, 694, 752	90914-0055	21501	527,
90505-SX0-003	19453	510,	90666-SA7-003ZW	19506	420,	90685-SA5-003	14356	448,			543, 776
		539, 676		480, 646, 669				476, 748	909140059	22230	490,
90520-01002	2288	400	90666-SD9-000	20351	665	90687-671-003	14319	448,			545, 774
90520-01274	2288	400	90666-SS0-003	19740	643, 662			476, 671	909140062	22160	498,
90541-09069	22413	59	90667-671-013ZA	20381	444,	90687-671-0030	14319	448,			545, 774
90541-09124	22490	59		482, 669, 737, 748				476, 671	909140063	21500	518,
90560163	22336	458, 489	90667-S0D-003ZC	20334	422,	90687-SA5-003	14282	443,			543, 775
905920039	22332	307		481, 669				476, 668	909140065	22181	507,
906	B906	262	90667-SA0-003	16776	422,	90687-SA5-0030	14282	443,			545, 775
906	16922	258		477, 670, 749				476, 668	909140068	22270	517,
90601-SH3-014	17442	661	90667-SA0-0030	16776	422,	90687-SB0-003	17287	495,			545, 775
90601-SMG-003	22242	659		477, 670, 749				537, 678	909207031	22211	432,
90602-S2A-003	21696	449,	90667-SA7-003	16775	426,	90687-SB0-013	17287	495,			489, 772
		486, 671		477, 670, 749				537, 678	909300007	22044	771
90602-S5A-003	21059	467,	90667-SA7-0030	16775	426,	90687-SB2-901ZF	17287	495,			21569
		483, 647, 673		477, 670, 749				537, 678	90950-01248	16777	447,
90602-S7S-003	20611	449,	90667-SA7-003ZB	16775	426,	90688-SB0-003	14968	582			477, 720, 792
		482, 671		477, 670, 749		90688-SB0-013	14698	508,	90950-01620	22097	714, 806
90602-SAA-003	21087	465,	90667-SD4-003	19464	452,			535, 678	90950-08004	22159	782
		483, 673		480, 646		90694-SB0-003	17281	664	90959-01136	17631	805
90602-SEP-A00	21131	468,	90667-TC0-U01-ZA	22415	52	90694-SB0-0030	17281	664	90981-13018	20600	260
		483, 647	90668-SB0-003	14698	508,	906A	B906A	262	9098113046	B9005	264
90602-SFA-004	21308	642, 660		535, 678		90700-SB2-003	15998	432,	90981-13046	16897	260
90602-SX0-003	21107	451,	90669-671-000	14284	272,			477, 670	9098113047	B9006	264
		483, 646, 671		680, 806		90700-SJ4-000	18746	435,	90981-13055	18661	260
90602-TA0-003	21417	646, 671	90669-671-0000	14284	272,			478, 646, 670	90981-13055	20601	260
90603-S7S-003	20612	666		680, 806		90713-SB0-003	14705	664	9098113075	BH11	265
90612-SF1-003	17320	662	90669-671-003	14284	272,	90814FC001	21322	772	90982-08188	15926	233
90617-TBA-A01	22262	659		680, 806		90826FA000	21295	442,	90982-08189	15927	233
90621-SK7-003	18756	643	90669-SB0-003	19487	735			484, 747	90982-08202	15930	233
90650-S5A-003	22365	51	90669-SP0-003ZA	19744	422,	90866-SA0-000	20350	665	90982-08203	15931	233
90650-S5A-003	22365	51		481, 670		90901-89004	20660	707	90982-08223	15929	233
90651-SL9-013	19454	668	90669-SP0-003ZB	19744	422,	90904-67021	19430	779	90982-09019	21602	235
90651-SL9-0130	19454	668		481, 670		90904-67036	20390	780	90982-09025	21604	235
90651-T3L-003	22469	52	90670-692-003	16781	444,	90904-67037	20391	780	91017FA080	21562	771
90651-TP8-003	21705	440,		477, 669, 792		909120024	21548	415,	91059FC010	21564	770
		486, 645, 674	90670-SG0-003	19741	667			485, 709, 794	91059FC030	21581	770
90652-SB2-023	16949	680	90671-S0D-003ZK	21303	419,	909130003	21585	490,	91059FC041	22050	771
				484, 669				543, 774	91059FC090	21572	771

O.E.M. INTERCHANGE BY NUMERICAL ORDER

OEM No.	Auveco No.	Page No.	OEM No.	Auveco No.	Page No.	OEM No.	Auveco No.	Page No.	OEM No.	Auveco No.	Page No.
91059FC110	21564	770	91503-T1W-003	22446	52	91520-SM4-C01	18114	446,	91562-S84-A01	20737	661
91084AA010	22043	772	91503-T2A-A01	21796	661		478, 645, 670		91562-SV4-003	18405	662
91085TA030	21566	502, 543, 775	91504-SDA-003	22518	51	91524-SE0-003	17081	508, 536, 678	91563-SCV-003	21707	440, 486, 645, 674, 794
91086AA000	22175	776	91504-SM4-000	17144	523, 536, 679	91526-SP1-003	18767	644	91566-SP0-003	18294	467, 478, 673
91167AA000	21579	771	91504-SP1-003	19408	523, 539, 679	91527-SM4-003	19415	662	91567-S3M-000	21458	415, 485, 673
91167FA010	22046	447, 488, 772	91504-SP1-003	21558	642, 661	91527-SZ3-003	19415	662	91567-SR2-013	21548	415, 485, 709, 794
911711148	18661	260	91504-SP1-003	21558	642, 661	91528-S01-A01	19115	664	91568-SL4-003	17608	644
911711148	20601	260	91504-SR3-003	20432	679	91528-SR4-003	19115	664	91568-SR2-003	19171	439, 479, 674
91173701	15926	233	91504-TBA-A01	22263	445, 489, 669	91528-SS0-003	18866	663	91568-SR2-003	19171	439, 479, 674
91176726	20417	561	91505-S9A-003	20986	519, 541, 676	91529-SS0-003	18865	662	91568-TR0-003	21705	440, 486, 645, 674
912	B912	262	91505-SG0-003	17280	643, 664	91530-S0A-003	21773	440, 486, 645, 674	91570-SDA-A01	21095	663
912	18008	258	91505-SL0-003	19231	510, 538, 648	91530-SE0-003	14328	436, 476, 673	91570-SK7-003ZF	19546	505, 539, 678
91213-SZA-A01	22467	51	91505-S77-003ZA	20910	504, 541, 677	91530-SH4-003	14328	436, 476, 673	91570-SZA-305	21543	644, 663
9128.S1	21941	421, 487, 761	91505-TM8-003	21706	486, 520, 648, 676	91530-SP1-003	18877	440, 479, 645, 674	91571-SDA-A01	21096	663
9132667	22088	308	91506-S9A-003	21173	521, 542, 648, 676	91530-SS0-003	18864	663	91571-SDA-A01	21094	664
9133073	20407	532, 540, 823	91507-SH3-003	17632	508, 537, 605, 688, 722	91530-ST5-003	19116	440, 479, 674	91572-SV4-003	18404	664
9133073-8	20407	532, 540, 823	91508-S50-003	19547	504, 539, 675	91531-ST0-003	19359	662	91576-SV4-003	19477	643, 662
9133417	21859	502, 544, 730, 757, 823	91508-SM4-003	17192	509, 537, 675	91533-SG0-000	19186	492, 538, 647, 675	91577-SV4-003	19476	643, 662
9133417-7	19904	503, 539, 823	91508-SR3-000	18165	504, 537, 675	91533-ST0-003	19668	643	91578-SV4-003	18457	658
9145	BH10	265	91510-SR3-003	17981	661	91534-SE0-000	17443	659	91578-T0A-003	21836	658
9147.14	21951	67	91512-S50-003	21555	642, 660	91534-SE0-003	17443	659	91589-SV4-003	20272	661
9147.15	21953	67	91512-SED-003	22514	52	91535-SP0-003	18754	643	91591-SJ6-013	21170	649, 680
9147.21	21954	67	91512-SE0-003	18512	679	91537-SPO-013	18236	644	916	B916	262
91486KJ000	21590	772	91512-SJ6-J01	21559	642, 659	91545-SE0-003	16782	520, 536, 677, 753	916	18006	258
91486KJ010	21531	772	91512-SJK-003	22069	519, 545, 648, 677	91545-SE0-003-W1	16782	520, 536, 677, 753	91601-STX-A00	21209	645
91500-SM4-999AH	16960	106, 109	91512-SM4-003	17379	516, 537, 679	91547-SE0-003	14688	680	91603-SL0-000	21635	666
91501-S04-003	19118	517, 538, 676	91512-SR3-004	20472	141, 645, 668	91547-SE0-0030	14688	680	91604-SD2-013	18454	680
91501-S1K-003	20609	435, 482, 646, 670	91512-STK-A01	22112	519, 544, 648, 677	91550-S50-000ZK	21477	503, 543, 677	91619-SM4-003	19117	666
91501-SEA-003	20882	445, 483, 669	91512-SX0-003	19239	575, 518, 538, 648, 676, 738	91550-S50-000ZL	21190	503, 542, 677	91619-SM4-0030	19117	666
91501-SG0-003	17440	642	91513-SE0-003	18818	441, 479, 674	91550-SH3-003	19142	499, 538, 678	91620-SR2-003	19307	666
91501-SL4-003	19467	443, 480, 646	91513-SJK-003	22068	331	91550-SH3-003ZR	19142	499, 538, 678	91623-SM2-003	19143	667
91501-SM4-003	17205	447, 477, 671	91513-SM4-000	17096	662	91558-SE3-003	21388	649, 680	91623-SM2-0030	19143	667
91501-SM5-A00	19680	662	91513-SMG-E01	22241	659	91558-SE3-003	21388	649, 680	91626-SH3-003	19741	667
91501-SNA-003	22054	445, 488, 669	91513-SMG-E11	21207	659	91560-S04-003	22243	450, 489, 671	91626-SP0-003	21700	645, 668
91501-SP1-003	19225	642	91513-SPO-003	17323	643	91560-S0X-A01	21638	460, 485, 672	91635-SM4-003	17609	666
91501-STK-003	20609	435, 482, 646, 670	91513-TOA-A01	22463	51	91560-S6A-003	21206	463, 483, 673	91652-SP0-003	19465	644
91501-SWA-003	21652	435, 485, 670	91513-TK8-A01	22443	51	91560-S7A-003	21554	461, 485, 672	91652-SZ3-003	19746	415, 481, 646
91501-TR0-003	21651	517, 544, 676	91514-SAA-003	22283	661	91560-S84-A01	21149	459, 483, 672	916581	9884	243
91502-S84-A01	19683	441, 480, 674	91514-SLN-A01	22434	52	91560-S84-A11	20411	461, 482, 647, 672	916581	9885	243
91502-S84-A11	19683	441, 480, 674	91514-SMG-E01	22433	51	91560-S9A-A01	20959	462, 483, 647, 672	916632	9916	243
91502-S9A-003	21216	661	91514-SMG-E01	22433	51	91560-SL4-003	20610	466, 482, 673	916638	9884	243
91502-SM4-000	17143	524, 536, 679	91514-SP0-003	18764	643	91560-S7A-003	21554	461, 485, 672	916638	9885	243
91502-SM4-000	19407	524, 539, 679	91514-SP1-003	18760	643	91560-S84-A01	21149	459, 483, 672	916A	B916A	262
91502-SP0-003	18119	523, 537, 679	91514-SYP-003	22468	52	91560-S84-A11	20411	461, 482, 647, 672	916NA	B916NA	258
91502-SZ5-003	19232	504, 538, 648	91514-TF0-003	22482	52	91560-S9A-A01	20959	462, 483, 647, 672	916NA	18007	258
91503-S0K-A01	20608	520, 541, 676	91514-TR3-A01	22367	52	91560-SL4-003	20610	466, 482, 673	91GBA611A08EAW	18387	612
91503-S3Y-003	21419	661	91515-SR3-000	19483	441, 480, 646, 675	91560-SLJ-J01	21208	461, 483, 647, 672	92095787	B885	263
91503-S7A-003	21297	518, 542, 676	91515-SR4-003	19737	661	91560-SM4-003	20610	466, 482, 673	921	B921	262
91503-SHJ-A01	21454	520, 543, 677	91516-SK7-013	17350	520, 537, 679, 754	91560-SPO-003	19145	461, 479, 647, 671	921	18005	258
91503-SK7-013	19723	644	91516-SM4-013	19116	440, 479, 674	91560-SZ3-003	19466	460, 480, 647	92138636	22219	512, 545, 575
91503-SP0-003	17267	521, 537, 649	91517-SE0-003	19247	551	91560-SZ3-003	19466	460, 480, 647	92138807	22226	565
91503-SWA-A01	22466	51	91518-S10-003	19682	446, 480, 670	91560-SZ3-003	19466	460, 480, 647	92138808	22225	564
91503-SZ3-003	19233	519, 538, 648, 676	91518-SM4-003	19114	446, 479, 646, 670	91560-SZ3-003	19466	460, 480, 647	92138811	22220	467, 489
91503-SZ3-003	19233	519, 538, 648, 676	91519-S5A-003	20387	663	91560-SZ3-003	19466	460, 480, 647	92138865	22222	558
91503-SZ5-003	20564	522, 540, 649, 677	91519-SCV-A01	21597	662	91560-SZ3-003	19466	460, 480, 647	92138942	20515	466, 482
			91520-S5A-003	20386	663	91560-SZ3-003	19466	460, 480, 647	92139070	22224	558
			91520-SCC-003	21295	442, 484, 747	91560-SZ3-003	19466	460, 480, 647	92139147	22041	532, 545, 567,
						91560-SZ3-003	19466	460, 480, 647	92139150	22089	307
						91561-S84-A01	19415	662	92155-22000	22296	94, 103, 130, 136
						91561-S84-A21ZB	20352	504, 540, 678	921A	B921A	262
						91561-SJD-003	21141	509, 542, 673	922	20294	259
						91561-SW5-003	19479	644	92231490	18501	297
						91561-TA0-A11	22394	53	9227.35	21956	66
									92351-37000	21069	106, 684, 696
									92470-N8200	18135	388
									92470-N8210	18135	388
									92471-N8200	18139	388
									92472-N8200	18134	388
									92473-N8200	18142	388
									92474-N8200	18138	388
									92475-W1000	18140	388
									92475-W2100	18144	388

O.E.M. INTERCHANGE BY NUMERICAL ORDER

OEM No.	Auveco No.	Page No.	OEM No.	Auveco No.	Page No.	OEM No.	Auveco No.	Page No.	OEM No.	Auveco No.	Page No.
92485-2H000	22370	54	9431809	18011	258	94515340	16136	139	97	16912	258
92552-36000	22006	467, 488, 686	9432137	16687	308	94530438	21112	569, 499, 542	9711304	15759	588
93	16926	258	9432552	16686	307	94530565	21070	460, 483, 687, 698	97134978	17355	402, 694
93356553	19781	591	9432645	11246	547	94530623	17267	521, 537, 649	9716926	14549	592
93904-46320	16960	106, 109	9433040	18010	258	94530624	18119	523, 537, 679	9721917	14550	592, 615
94044TA040	22364	58	9433043	11628	145, 179	946-418	13220	144, 733, 757, 823	972724	4244	395
94051993	16859	497, 536, 569, 751	9433143	20286	259	947-098	13230	490, 534, 730, 823	9731301	11152	401, 402
94078FA080	22048	459, 488, 774	94331546	20582	174	94748652	22161	558	97606-B0700	13930	717, 742
94081FA010	21575	771	9433155	9879	174	94841130	14277	786	9786454	9354	87
94109-14000	16956	275	9433156	20582	174	94841226	14750	143, 725, 807	9786454	9355	87
9411017	9265	284	9433184	18016	258	94841764	13932	736, 785	9786454	9356	87
9411019	9266	284	9433185	18811	293	94842543	17224	785	9795883	10068	87
9411022	9257	283	9433186	18168	312	94842841	18297	443, 478, 708, 791	9796223	10714	94, 104
9411031	9260	283	9433373	10171	69	94847334	17383	492, 537, 570, 777, 800	979878	19376	309
94113207	17271	551	9433489	11614	86	94848189	18330	441, 478	979878-6	19376	309
9411943	3401	155	9433489	11615	86	94848192	18330	441, 478	980557	B3357	262
94145515	17076	427, 477, 694	9434229	18732	294	94848834	15695	558, 779	9808241	10630	402
9414716	3079	71	9436175	11620	302	94849113	18297	443, 478, 708, 791	9815325	14967	587, 614, 630, 634
9414722	1943	71	9436175	16837	302	94852368	19140	568, 522, 624, 538, 649, 739, 804	9818648	10621	471, 475
9414723	2808	71	9436750	16922	258	94853733	18939	512, 538, 712	9822198	14548	592
9414767	2734	69	9436789	18465	258	94854203	19194	551, 788	9838109	10318	556
9415465	2366	71	9436790	20284	259	94858299	18876	465, 479, 798	9838109	11288	554
9416042	2712	69	9437173	B912	262	94858338	19312	419, 480, 790	9854717	10631	402
9416444	2709	69	9437486	12655	303	94858343	19726	568, 496, 539	9882774	8853	437, 475
9416927	16909	258	9437643	20402	303	94858509	19729	445, 480, 709, 793	9883583	10621	471, 475
9416927	20715	267	9437846	14486	303	94858560	18873	513, 538, 803	9883583	11774	471, 475
9416927	B1893	262	9437938	11621	304	94858864	19645	568, 496, 539	9885583	16260	471, 477
9417276	1937	71	9437938	16838	304	95005064	14144	465, 476, 799	9895598	10701	401
9417561	20285	259	9438068	18012	258	95022AC040ML	21630	422, 485, 772	99045AE03AMA	21589	419, 485, 772
9417863	16906	258	9438068	B194A	262	95188	15011	157	99045SG000	22429	58
9417863	B1895	262	9438150	11246	547	95230842	21529	512, 543, 574	9924-90-512B	14367	415, 476, 719
9417866	16904	258	9438848	16907	258	95290	13173	810, 822	9926-40-531B	18271	444, 478, 719
9417866	B1156	262	9438848	B2057	262	95900-04036	17224	785	9926-40-543	14349	442, 476, 719, 747
94178705	18876	465, 479, 798	9438850	16908	258	9590477	12675	156	9926-50-625	14260	498, 535, 568, 722, 801
9419740	5655	70	9439559	18749	311	9601750	20562	587	9926-50-635	14369	515, 535, 723
94198687	14697	568, 496, 535, 678, 722	9439719	12657	312	96057846	17162	499, 536, 571, 801	9927-40-821	14363	470, 476, 721
9420052	12097	92, 98, 128, 132	9440178	9879	174	96061699	14367	415, 476, 719	9927-40-822	16778	470, 476, 721
9420850	11923	71	9441592	18167	304	96061863	17356	583	9927-40-825	14269	464, 477, 721, 795
9421330	16902	258	94415FA000NE	22047	527, 545, 776	96064506	19128	516, 538, 803	9927-70-901	14378	724
9421330	B194	262	9441723	B890	263	9617200	11118	566, 413	9927-80-404	14365	724
9421777	16912	258	9441724	20598	260	9624520	11066	401	9927-80-405	14359	724
9421777	B97	262	9441724	B891	263	9662548	17233	567	9928-90-753	14376	272, 725
94218027	17195	597, 620, 658, 694, 735	9441728	B880	263	9662950	11067	401	9928-91-053	14298	272, 680, 725
94221150	14727	567, 532, 535, 694, 755	9441731	16896	260	9669486	11855	550, 764	9956-41-400	19621	275
9422202	13708	91, 95	9441732	16897	260	96706-89901	14366	717, 743	99604-H1400	16780	755, 805
9422246	13707	91, 94	9441732	B9005	264	96706-B0700	13930	717, 742	9991-00-402	14366	717, 743
9422339	18469	258	9441733	16898	260	96706-B6700	13930	717, 742	9991-00-403	14364	717
9422552	11292	172	9441770	8938	294	96706-H2500	14724	743	9991-00-412	13930	717, 742
94226492	14269	464, 476, 694, 721, 799	9441837	18017	258	96706-H9400	14335	736, 743	9991-00-501	14357	717
9423101	19777	106, 108	9441837	B24	262	96706-K1300	14335	736, 743	9991-00-503	14313	666, 717, 742
9423950	15827	92, 99	9441838	18000	258	96706-K1351	14335	736, 743	9991-00-601	14274	666, 717, 742, 785
9424837	9880	174	9441838	20721	267	96706-N8000	14334	742	9CF600516B	22294	93, 101, 129, 134
9425491	9881	174	9441839	16915	258	96706-P0105	14274	666, 717, 742, 785	9GG600616T	22293	121, 123
9425542	16921	258	9441839	20722	267	96706-W1000	14267	706, 789	9L3Z-14030A12-A	20836	400
9425542	20706	267	9441839	B3057	262	96706-W1099	14267	706, 789	9N7Z-13N021-A	16897	260
9425542	B168	262	9441840	16916	258	9685057	11678	471, 475	9N7Z-13N021-A	B9005	264
9426331	12547	235	9441840	B3057A	262	97	B97	262	9XG0-73-88X0	20936	603, 715
9426334	12545	235	9441854	17998	258				9XG0-75-93X0	20190	468, 481
9427587	18013	258	9441866	17999	258				9XG1-10-37X	20190	468, 481
9427761	10666	172	9441866	20720	267						
9427882	9282	287	9441866	B2357	262						
9427909	8925	294	9441923	18018	258						
9427943	20289	259	9441923	20702	267						
9427977	13709	93, 100	9441923	B24A	262						
9428273	13027	92, 99	9441941	2808	71						
9428481	3796	172	9441956	18005	258						
9428902	16899	258	9442003	17996	258						
9428902	B1157	262	9442004	B3156	262						
9428904	16901	258	9442081	17997	258						
9428904	B1157A	262	9442361	17641	311						
9431530	9880	174	9442486	18001	258						
9431532	10067	174	9442486	B3157A	262						
9431647	2293	173	9442492	18478	259						
9431808	16913	258	9442877	B881	263						
			9442878	20596	260						
			9442879	20683	260						
			9442880	B889	263						
			9442881	20599	260						
			94467458	17355	402, 694						
			94515248	22527	47						

Your Body Hardware and Specialty Fastener Solutions

Packaging



Small Unit Quantities



Large Bulk Quantities



AuvecoPak
One-price package retail program

Kits and Storage



Quik-Select Kits



Body Hardware Master
Kits and Storage Cabinet



Fix-Kits

Check out the Green Section 15 for our full line of Body Hardware Master Kits, Quik-Select kits, Fix-Kits and other assortments. You'll also find our full AuvecoPak line and merchandiser. We also have several bins, cabinets and other accessories to organize all your kits and fasteners.

FasTrack: Body cost recovery system

An easy-to-use, web based system designed to assist body shops and dealerships in recovering the cost of body repair clips and fasteners used in daily collision repairs.

FasTrack is the ONLY supplemental invoicing system on the market using the OEM pricing structure that is widely accepted and requested by insurance companies across the country.

With a newly designed web site for easier use. And our recent integration with CCC® Estimating. CCC ONE is the largest supplier of a body shop estimating system in the US.

For questions or to learn more about FasTrack please call 1-800-354-9816 or email fastrack.support@auveco.com

Delivering the World's Largest Selection of Automotive Body Hardware and Specialty Fasteners



Auto-Vehicle Parts LLC
Cold Spring, KY 41076
(Metropolitan Cincinnati)

Sold through authorized distributors